

**THE NOVEL "CONTROLLED INTERMEDIATE NUCLEAR FUSION"  
AND ITS POSSIBLE INDUSTRIAL REALIZATION AS PREDICTED BY  
HADRONIC MECHANICS AND CHEMISTRY**

**Ruggero Maria Santilli**

Institute for Basic Research

P. O. Box 1577, Palm Harbor, FL 34682, U.S.A.

ibr@ibr.net, <http://www.i-b-r.org>

**Abstract**

In this note, we propose, apparently for the first time, a new type of controlled nuclear fusion called "intermediate" because occurring at energies intermediate between those of the "cold" and "hot" fusions, and propose a specific industrial realization. For this purpose: 1) We show that known limitations of quantum mechanics, quantum chemistry and special relativity cause excessive departures from the conditions occurring for all controlled fusions; 2) We outline the covering hadronic mechanics, hadronic chemistry and isorelativity specifically conceived, constructed and verified during the past two decades for new cleans energies and fuels; 3) We identify seven physical laws predicted by the latter disciplines that have to be verified by all controlled nuclear fusions to occur; 4) We review the industrial research conducted to date in the selection of the most promising engineering realization as well as optimization of said seven laws; and 5) We propose with construction details a specific *hadronic reactor* (patented and international patents pending), consisting of actual equipment specifically intended for the possible industrial production of the clean energy released by representative cases of controlled intermediate fusions for independent scrutiny by interested colleagues.

**1. Limitations of Quantum Mechanics, Quantum Chemistry and Special Relativity.** Following the pioneering research by Fleishmann, Pons and Hawkins [1a] of 1989 vast research [1b,1c,1d] has confirmed the existence of Low Energy Controlled Nuclear Fusions (LECNF) popularly called "Cold Fusion" (CF). Nevertheless, the achievement of an industrially relevant energy output has remained evasive, and none is in sight at the moment on strict scientific grounds.

Similarly, additional research supported by a collective international investment of about one billion dollars has shown that the High Energy Controlled Nuclear Fusion (HECNF), popularly called "Hot Fusion" (HF), can indeed be attained in laboratory, although this research too has not achieved results of industrial significance, and none is in sight at the moment, due to uncontrollable instabilities at the initiation of the fusions and other reasons.

In view of the above protracted insufficiencies at high and low energies, in this paper we propose, apparently for the first time, a new type of nuclear synthesis under the name of Intermediate Energy Controlled Nuclear Fusions (IECNF), or "Intermediate Fusion" (IF) for short.

A main argument is that, for the case of the "cold fusion", the available energy is insufficient for a systematic exposure of nuclei via the control of electron clouds, in which case no fusion is evidently possible. For the case of the "hot fusion" we have the opposite occurrence in which the available energy is simple excessive, thus preventing the possibility of a real control. The name "intermediate" is here proposed to denote that the available energy is indeed intermediate between those of the "cold" and "hot" fusions.

More particularly, the available energy for the proposed intermediate fusion is set to a value sufficient for the ionization of atoms in order to expose nuclei in preparation for their controlled synthesis, as it is the case for a plasma created by an electric arc. Such a plasma is typically at about  $10,000^{\circ}F$ , thus having an energy that cannot be credibly qualified as belonging to either the "cold or the "hot" fusion.

It should be indicated that numerous plasmas have been used in the "cold fusion" research [1b,1c,1d]. Nevertheless, dramatic differences will soon emerge between the "intermediate fusion" proposed in this paper and existing plasma fusion research due to irreconcilable differences in the assumed basic disciplines.

Another objective of this paper is to propose specific reactors, called for technical reasons explained below *hadronic reactors* (patented and international patents pending) for the possible industrial utilization of the clean energy expected from "intermediate fusions." To achieve this task we shall: 1) Identify the basic disciplines that are applicable to all controlled fusions, whether "cold," "intermediate" or "hot"; 2) Identify the basic laws that have to be verified for any controlled fusion to occur; and 3) Propose with all necessary construction details a specific hadronic reactor based on the realization and optimization of said physical laws.

To begin, let us recall that the original discovery of the cold fusion [1a] created considerable controversies fueled by authoritative voices stating that *cold fusions are not predicted by quantum mechanics*. Subsequently, the existence of CF was experimentally established. Yet, with the passing of time, said authoritative doubts have been ignored and the CF has been essentially studied to this day via the use of quantum mechanics.

Another objective of this paper is to resume the authoritative doubts on the incompatibility between CF and established disciplines because the inability to achieve industrially valid results for both the "cold" and "hot" fusions may well be due to insufficiencies of the basic disciplines.

To begin our analysis, recall that limitations on the universal validity of quantum mechanics, quantum, chemistry and special relativity were fully known by the middle of the past century. As an example, this author became a theoretical physicist because of the doubts in the "completion" of quantum mechanics expressed by Einstein, Podolsky and Rosen [2a], or the doubts expressed by Fermi (Ref. [2b], p. 111 when treating the structure of nuclei) "as to whether the usual concepts of geometry hold for such small region of space" and other authoritative doubts.

With the passing of the decades, debates on these authoritative doubts were suppressed in most technical journals. However, increasingly cataclysmic events caused by our alarming environmental problems have rendered mandatory the search for new clean energies and fuels. In turn, said need forced the conduction in the last part of the 20-th century of

systematic studies [3] on the *limitations* of quantum mechanics, quantum chemistry and special relativity, that is, the identification of the conditions under which said disciplines can be safely assumed as being exactly valid, and the different conditions under which said disciplines are only approximately valid.

The latter studies [3] (see also independent monographs [4] and comprehensive literature covering two decades of research in Ref. [3i]), have confirmed that quantum mechanics, quantum chemistry and special relativity can indeed be assumed to be *exactly valid* under the conditions of their original conception, construction and verification, namely, *for systems of point-like particles and electromagnetic waves propagating in vacuum (empty space)*.

Typical examples of exact validity of quantum mechanics and special relativity are the structure of the hydrogen atom, particles moving in high energy accelerators, the structure of crystals and various other structures for which the indicated conditions of applicability are met.

However, studies [3,4] have identified precise conditions under which quantum mechanics and special relativity remain evidently applicable, but are only *approximately valid*, among which we note:

1) In **particle physics**, there exist various cases in which the fit of experimental data requires the introduction of arbitrary parameters, as it is the case for the Bose-Einstein correlation that requires *four* arbitrary parameters. In reality, these parameters constitute a direct measure of the *deviations* of the Bose-Einstein correlation from the unadulterated axioms of quantum mechanics and special relativity. As an example, the two point correlation function of the Bose-Einstein correlation requires off-diagonal terms that are incompatible with the quantum axiom of expectation values of operators that, to be observables, must be Hermitean, thus diagonal (see monographs [3i,3k] for details).

2) In **atomic physics**, quantum mechanics and special relativity have not permitted an exact representation of all spectral data of the helium, with embarrassing deviations from the experimental data of heavy atoms such as the zirconium, let alone the historical inability in about one century to understand the spectral emission of the Sun (see, again, refs. [3i,3k] for details).

3) In **nuclear physics**, quantum mechanics and special relativity have been unable to represent the experimental data of the simplest possible nucleus, the deuteron, because of the inability to explain the spin 1 of its ground state (since quantum axioms require that the ground state of two particles with spin 1/2 should be 0, while the ground state of the deuteron has spin 1), the lack of an exact representation of the deuteron magnetic moment despite all possible relativistic corrections, the historical inability to understand the stability of the neutron in the deuteron, and other basic insufficiencies, with truly embarrassing deviations from experimental data of heavy nuclei [3i,3k].

4) In **superconductivity**, quantum mechanics, quantum chemistry and special relativity have created a condition similar to that of atomic physics prior to the representation of the structure of atoms, since said disciplines cannot explain the bond of the two identical electrons in the Cooper pair (evidently because electrons repel each other according to quantum mechanics), thus resulting in a description of an *ensemble* of Cooper pairs without a true description of their structure [3l].

5) In **chemistry**, quantum mechanics, quantum chemistry and special relativity have been unable to provide an exact representation of the binding energy of the simplest molecule, the hydrogen molecule (due to the historical 2% missing when using unadulterated quantum axioms), with larger deviations when passing to more complex molecules such as water (for which, e.g., electric and magnetic moments are predicted with the wrong sign, let alone large numerical deviations), not to forget the embarrassing prediction by quantum chemistry that all molecules are ferromagnetic (a direct consequence of the independence of the electrons in valence bonds, thus permitting the polarization of their orbits under an external magnetic field). At the same time, adulterations of quantum axioms now vastly used to improve the approximation, such as the so-called "screenings of the Coulomb law," imply the abandonment of the very quantum of energy (because no longer admitted for potentials of the type  $\frac{q_1 q_2}{r} e^{f(r)}$ ), while the same screenings imply structural departures from quantum axioms (because the transition from the Coulomb to screened potentials requires *nonunitary* transforms, thus exiting from the classes of equivalent of quantum mechanics) (see [3l] for details).

6) In **biology**, any claims of exact validity of quantum mechanics, quantum chemistry and special relativity constitute scientific deceptions because, as experts are expected to know to qualify as such, quantum treatments imply that biological structures are perfectly rigid, perfectly reversible in time and perfectly eternal, as it is typically the case for crystals (see monograph [3j] for details).

7) In **engineering**, various equipment show sizable deviations from quantum mechanics, quantum chemistry and special relativity. An illustration important for the reactors to be proposed in this note, the use of Maxwell's equations and quantum chemistry for underwater electric arcs between graphite electrodes is afflicted by a *ten fold error in excess* in the prediction of the produced carbon monoxide, a *ten-fold error in defect* in the production of carbon dioxide in the combustion exhaust, a *fourteen-fold error in defect* in the amount of oxygen present in the combustion exhaust, and other deviations simply too big to be accountable via the usual *ad hoc* parameters or other manipulations to adapt reality to preferred theories.

All the above limitations exist for *matter*. Additional large insufficiencies exist for *anti-matter* as presented in details in monograph [3n], such as the inability by Einsteinian theories to provide a consistent *classical* treatment of antiparticles because, after quantization, one obtains a "particle," rather than a charge conjugated "antiparticle" with the wrong sign of the charge, the impossibility for Einsteinian theories to provide a distinction between classical neutral bodies made up of matter and antimatter, and other serious insufficiencies. These insufficiencies are ignored hereon because we shall evidently deal with nuclei made up of *matter*. Nevertheless, the insufficiencies for antimatter are sufficient, alone, to establish the nonscientific nature of any claim of terminal character of quantum mechanics, quantum chemistry and special relativity.

Independently from these studies, a mere confrontation of reality with the basic axioms of quantum mechanics, quantum chemistry and special relativity is sufficient to establish their limits of exact applicability.

As an example, a confrontation of the pillar of special relativity, the Poincaré symmetry,

and the structure of hadrons, nuclei, molecules and stars is sufficient to see the *impossibility* for special relativity to be exactly valid for the structures considered.

In fact, a necessary condition for the validity of the Poincaré symmetry, well known to experts to qualify as such, is to have a *Keplerian structure* as occurring in the atomic and planetary structures, while *hadrons, nuclei, molecules, stars and other systems do not have a Keplerian structure because, e.g., nuclei do not have nuclei*. The modification of the Poincaré symmetry to account for the absence of Keplerian nuclei, no matter how small, causes its evident breaking, with consequential *impossibility* beyond scientific doubt for special relativity to be exactly valid for the structures considered (collectively called *interior dynamical systems*, while atomic and planetary systems are examples of *exterior dynamical systems* [3a,3b]).

Similarly, an inspection of the basic dynamical equations of quantum mechanics and quantum chemistry is sufficient to see the *impossibility* for the theories to be exactly valid in interior dynamical systems. In fact, said disciplines are based on the familiar Schrödinger equation

$$i \times \frac{\partial}{\partial t} |\psi \rangle = H(t, r, p) \times |\psi \rangle, \quad (1.1a)$$

$$p_k \times |\psi \rangle = -i \times \partial_k |\psi \rangle, \quad H = \frac{p^2}{2 \times m} + V(r), \quad (1.1b)$$

and the equivalent Heisenberg equations for a (Hermitian) observable A, expressible in their finite and infinitesimal forms

$$U \times U^\dagger = U^\dagger \times U = I \quad (1.2a)$$

$$A(t) = U(t) \times A(0) \times U^\dagger(t) = e^{H \times t \times i} \times A(0) \times e^{-i \times t \times H}, \quad (1.2b)$$

$$i \times \frac{dA}{dt} = [A, H] = A \times H - H \times A, \quad (1.2c)$$

with related canonical commutation rules

$$[r^i, p_j] = i \hat{\times} \delta_j^i, \quad [r^i, r^j] = [p_i, p_j] = 0. \quad (1.3)$$

where  $\hbar = 1$  and we have used the symbol  $\times$  to denote the conventional associative product of quantum mechanics in order to distinguish it from other products needed for this paper.

Inspection of the above equations confirms their exact validity for systems of point-like particles moving in vacuum, but also identifies the impossibility to represent, e.g., the hyperdense fireball of the Bose-Einstein correlation, or the deep overlapping of electrons in valence bonds and their breaking in chemical reactions due to the strictly linear, local, potential and reversible character of the equations, while said fireball or chemical reactions are expected to be dominated by nonlinear, nonlocal, nonpotential and irreversible effects.

Alternatively and equivalently, the impossibility for the above equations to be exactly valid for conditions 1)-7) above can be derived from their basic Euclidean topology, since the latter solely admit the treatment of a finite set of isolated points.

Consequently, any claim of exact validity of Eqs. (1.1)-(1.3) for the Bose-Einstein correlation, chemical reactions and other processes is nonscientific, since the only scientifically

debatable issue is the identification of the applicable *generalization* of quantum mechanics and special relativity.

When passing to the study of controlled nuclear fusions, the *impossibility* of quantum mechanics, quantum chemistry and special relativity to be exactly valid for becomes dramatic (see [3k] for details). Besides limitations 1)-7), we here restrict ourself to the indication that *quantum mechanics, quantum chemistry and special relativity are strictly invariant under time reversal, trivially, because all known potentials are reversible in time. Consequently, said disciplines can only predict the synthesis of nuclei in a form that is time reversal invariant, that is, by equally admitting as causal their disintegration. This feature alone, let alone numerous other technical inconsistencies [3i,3k], is sufficient to establish that quantum mechanics, quantum chemistry and special relativity are not suited for quantitative treatment of any controlled nuclear fusion, whether cold, intermediate or hot.*

In closing this section it should be indicated that the use of the word "violation" of quantum mechanics, quantum chemistry and special relativity would not be scientifically appropriate because said disciplines were not conceived and constructed for the conditions considered (e.g., antimatter had yet to be discovered when Einstein formulated the special and general relativities). This illustrates the reason for the use of the word "inapplicable."

It should be finally indicated that, contrary to quasi-religious beliefs during the second half of the 20-th century, the insufficiencies of quantum mechanics, quantum chemistry and special relativity are *multiplied*, rather than resolved or even decreased, under the assumption that the hypothetical quarks are physical constituents of hadrons existing in our spacetime.

As an illustration, the reduction of the deuteron to quarks *increases* the difficulties in representing the magnetic moment, trivially, because the hypothetical orbits of the hypothetical quarks are too small to yield polarizations sufficient to fit experimental data, while the problem of the spin of the deuteron is equally multiplied, trivially, because of difficulties for quark conjectures to represent the spin of individual protons and neutrons, let alone their bond, not to mention lack of achievement of a true confinement that bypasses the prediction from Heisenberg's uncertainty principle of a finite probability that quarks are free in dramatic disagreement with available experimental evidence.

Any study of controlled nuclear fusions via quark conjecture is dismissed in this paper also because *quarks cannot experience gravity*, since gravity can only be defined in our spacetime, while quarks are purely mathematical representations of a purely mathematical internal unitary symmetry defined on a purely mathematical complex-valued unitary space without any credible definition in our spacetime (that is prohibited by O'rafeartaigh's theorem).

Stated in plain language, no serious studies of controlled nuclear fusions can be credibly voiced under the assumption that the nuclei to be fused can freely float in space due to their reduction to hypothetical quarks without any provable gravity.

In this note, we shall assume that the SU(3)-color, Mendeleev-type classification of hadrons into families is of final character, and we shall assume quarks what they are technically, purely mathematical objects useful for said classification, while we shall assume that the physical constituents of hadrons are basically unknown at this writing.

By recalling that the historical contributions to civilization produced by molecules, atoms and nuclei were based on the capability *to extract the constituents free*, the assumption of

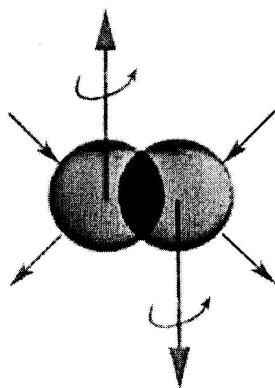

Figure 1: A schematic view of the interactions at the foundation of hadronic mechanics and isorelativity, those caused by deep wave-overlappings of the charge distribution as well as of the wavepackets of particles. A main purpose of this paper is to show that these interactions are crucial for industrial realizations of LENS.

the hypothetical quark as physical particles permanently bound inside hadrons is considered nowadays one of the biggest obstructions against new clean energies so much needed by mankind [3k,3m].

## 2. The Covering Hadronic Mechanics, Hadronic Chemistry and Isorelativity.

Studies [3,4] have established that the basic insufficiency responsible for *all* limitations 1)-7) of the preceding section is the impossibility to represent interactions due to deep mutual penetration and overlapping of the wavepackets and/or charge distributions of particles as illustrated in Figure 1. We are here referring to *interactions of contact (thus zero-range) type, nonlinear (in the wavefunctions), nonlocal-integral (because occurring in a finite volume), and nonpotential, thus not representable with a Hamiltonian.*

This limitation is evidently due to the fact that quantum mechanics, quantum chemistry and special relativity are strictly linear, local-differential and potential theories. Consequently, the interactions depicted in Figure 1 are beyond any hope of representation.

A typical illustration is that of valence bonds that are abstracted by quantum chemistry into two point-particles interacting at a distance. It is, of course, true that electrons have a *point-like charge*. However, the idea that electrons have a "point-like wavepacket" is outside the boundary of serious science. When this physical reality is admitted, valence bonds result to be due not only to electromagnetic interactions but also to contact nonlocal-integral and nonpotential interactions due to the mutual penetration of the wavepackets as depicted in Figure 1.

The lack of representation of deep wave-overlappings has been proved to be responsible for the lack of 2% of experimental data in molecular binding energies [3l,9a,9b], the departures from spectral data in the helium (where, contrary to popular belief, the two electrons are

partially in conditions of mutual overlap as in Figure 1) [3k], and other insufficiencies.

When at the Department of Mathematics of Harvard University in the late 1970s, R. M. Santilli initiated comprehensive research toward a solution of the insufficiencies of conventional doctrines outlined in Section 1.

The central problem was *to identify a broadening-generalization of quantum mechanics, quantum chemistry and special relativity in such a way to represent linear, local and potential interactions, as well as additional, contact, nonlinear, nonlocal-integral and nonpotential interactions.*

Since the Hamiltonian can only represent conventional interactions, the above condition requested the identification of a *new quantity* capable of representing interactions that, by conception, are outside the capability of a Hamiltonian. Another necessary condition was the exiting from the class of equivalence of quantum mechanics, as a consequence of which the broader theory had to be *nonunitary*, namely, its time evolution has to violate the unitarity condition (1.2a). The third and most insidious condition was the *invariance*, namely, the broader theories had to represent the new nonpotential interactions in a way as invariant as that of conventional interactions, so as to predict the same numerical values under the same conditions at different times. We assume that experts are aware of the *theorems of catastrophic inconsistencies of noncanonical and nonunitary theories* [5j], which theorems mandate the achievement of invariance for any theory to have physical value.

It was evident that a solution verifying the above conditions required *new mathematics, e.g. new numbers, new spaces, new geometries, new symmetries, etc.* A detailed search in advanced mathematics libraries of the cantabridgean area revealed that the need new mathematics simply did not exist.

Following additional (unpublished) trials and errors, Santilli [5a,5b] proposed in 1978 the solution consisting in the representation of said contact, nonlinear, nonlocal and nonpotential interactions via a *generalization (called lifting) of the basic unit +1* of conventional theories into a function, a matrix or an operator  $\hat{I}$  that is positive-definite like +1, but otherwise has an arbitrary functional dependence on all needed quantities, such as time  $t$ , coordinates  $r$ , momenta  $p$ , density  $\mu$ , frequency  $\omega$ , wavefunctions  $\psi$ , their derivatives  $\partial\psi$ , etc.

$$+1 \rightarrow \hat{I}(t, r, p, \mu, \omega, \psi, \partial\psi, \dots) = 1/\hat{T} > 0, \quad (2.1)$$

while jointly lifting the conventional associative product  $\times$  between two generic quantities  $A, B$  (numbers, vector fields, matrices, operators, etc.) into the form admitting  $\hat{I}$ , and *no longer +1*, as the correct left and right unit

$$A \times B \rightarrow A \hat{\times} B = A \times \hat{T} \times B, \quad (2.2a)$$

$$1 \times A = A \times 1 = A \rightarrow \hat{I} \hat{\times} A = A \hat{\times} \hat{I} = A, \quad (2.2b)$$

for all elements  $A, B$  of the set considered.

The selection of the basic unit resulted to be unique for the verification of the above three conditions. As an illustration, whether generalized or not, the unit is the basic invariant of any theory. The representation of non-Hamiltonian interactions with the basic unit permitted



the crucial by-passing of the theorems of catastrophic inconsistencies of nonunitary theories [5j] (skeptic readers are encouraged to try alternative solutions).

Since the unit is the ultimate pillar of all mathematical, physical and chemical formulations, liftings (2.1) and (2.2) requested a corresponding, compatible lifting of the *totality* of the mathematical, physical and chemical formulations used by conventional theories, resulting indeed into new numbers, new fields, new spaces, new algebras, new geometries, new symmetries, etc, [3,4]. This explains the dimension and time requested by the research. Following the original proposal of 1978 to build hadronic mechanics [5a,5b], mathematical maturity in the formulation of the new numbers was reached in memoir [5c] of 1993 and general mathematical maturity was reached in memoir [5d] of 1996. Physical maturity was then quickly achieved in papers [5e,5f,5g].

In honor of Einstein's vision on the lack of completion of quantum mechanics, Santilli submitted in the original proposal [5a,5b] the name of *isotopies* for the above liftings, a word used in the Greek meaning of "preserving the original axioms." In fact,  $\hat{I}$  preserves all topological properties of +1,  $A \hat{\times} B$  is as associative as the conventional product  $A \times B$  and the preservation of the original axioms holds at all subsequent levels to such an extent that, in the event any original axiom is not preserved under isotopies, the lifting is incorrect. Nowadays, the resulting new mathematics is known as *Santilli isomathematics* [4],  $\hat{I}$  is called *Santilli's isounit*,  $A \hat{\times} B$  is called the *isoproduct*, etc.

The fundamental dynamical equations of hadronic Mechanics were submitted by Santilli in the original proposal [5a], are today called *Heisenberg-Santilli isoequations*, and can be written in the finite form

$$\hat{U} \hat{\times} \hat{U}^\dagger = \hat{U} \hat{\times} \hat{U} = \hat{I} \neq 1, \quad (2.3a)$$

$$\begin{aligned} \hat{A}(\hat{t}) &= \hat{U}(\hat{t}) \hat{\times} \hat{A}(\hat{0}) \hat{\times} \hat{U}^\dagger(\hat{t}) = (\hat{e}^{\hat{H} \hat{\times} \hat{t} \hat{\times} \hat{i}}) \hat{\times} \hat{A}(\hat{0}) \hat{\times} (\hat{e}^{-\hat{i} \hat{\times} \hat{t} \hat{\times} \hat{H}}) = \\ &= [(e^{H \times \hat{T} \times t \times i}) \times \hat{I}] \times \hat{T} \times A(0) \times \hat{T} \times [\hat{I} \times (e^{-i \times t \times \hat{T} \times H})] = \\ &= (e^{H \times \hat{T} \times t \times i}) \times \hat{A}(\hat{0}) \times (e^{-i \times t \times \hat{T} \times H}), \end{aligned} \quad (2.3b)$$

and infinitesimal form [5a,5g]

$$\begin{aligned} \hat{i} \hat{\times} \frac{\hat{d}\hat{A}}{\hat{d}\hat{t}} &= i \times \hat{I}_t \times \frac{d\hat{A}}{d\hat{t}} = [\hat{A}, \hat{H}] = \hat{A} \hat{\times} \hat{H} - \hat{H} \hat{\times} \hat{A} = \\ &= \hat{A} \times \hat{T}(\hat{t}, \hat{r}, \hat{p}, \hat{\psi}, \hat{\partial}\hat{\psi}, \dots) \times \hat{H} - \hat{H} \times \hat{T}(\hat{t}, \hat{r}, \hat{p}, \hat{\psi}, \hat{\partial}\hat{\psi}, \dots) \times \hat{A}, \end{aligned} \quad (2.4)$$

where: Eq. (2.3a) represent the crucial *isounitary property*, namely, the reconstruction of unitarity on *iso-Hilbert spaces* over isofields with inner product  $\langle \hat{\psi} | \hat{\times} | \hat{\psi} \rangle$ ; all quantities have a "hat" to denote their formulation on isospaces over isofields with isocomplex numbers  $\hat{c} = c \times \hat{I}$ ,  $c \in C$ ; and one should note the *isodifferential calculus* with expressions of the type  $\hat{d}/\hat{d}\hat{t} = \hat{I}_t \times d/d\hat{t}$  first achieved in memoir [5d] (see below).

The equivalent lifting of Schrödinger's equation was suggested by Santilli [5a,6a], Myung and Santilli [6b] and by Mignani [6c], all original proposals being formulated on conventional spaces over conventional fields. The isoequation was reformulated via the isodifferential

calculus by Santilli [5d], it is today called the *Schrödinger-Santilli isoequation*, and can be written

$$\begin{aligned} \hat{i} \hat{\times} \frac{\hat{\partial}}{\hat{\partial} \hat{t}} |\hat{\psi} \rangle &= i \times \hat{I}_t \times \frac{\partial}{\partial t} |\hat{\psi} \rangle = \hat{H} \hat{\times} |\hat{\psi} \rangle = \\ &= \hat{H}(\hat{t}, \hat{r}, \hat{p}) \times \hat{T}(\hat{r}, \hat{p}, \hat{\psi}, \hat{\partial} \hat{\psi}, \dots) \times |\hat{\psi} \rangle = \hat{E} \hat{\times} |\hat{\psi} \rangle = E \times |\hat{\psi} \rangle, \end{aligned} \quad (2.5)$$

with *isoepectation values*

$$\langle \hat{A} \rangle = \frac{\langle \hat{\psi} | \hat{\times} \hat{A} \hat{\times} | \hat{\psi} \rangle}{\langle \hat{\psi} | \hat{\times} | \hat{\psi} \rangle} \quad (2.6)$$

and basic properties

$$\frac{\langle \hat{\psi} | \hat{\times} \hat{I} \hat{\times} | \hat{\psi} \rangle}{\langle \hat{\psi} | \hat{\times} | \hat{\psi} \rangle} = \hat{I}, \quad \hat{I} \hat{\times} |\hat{\psi} \rangle = |\hat{\psi} \rangle, \quad (2.7a)$$

$$\hat{I}^n = \hat{I} \hat{\times} \hat{I} \hat{\times} \dots \hat{I} \equiv \hat{I}, \quad \hat{I}^{1/2} = \hat{I}, \quad (2.7b)$$

confirming that  $\hat{I}$  is indeed the isounit of hadronic mechanics (where the isoquotient  $\hat{\int} = / \times \hat{I}$  has been tacitly used [5d]).

By the mid 1990's, despite the isotopic lifting of all possible quantities and operations, hadronic mechanics had not yet reached an invariant formulation. In particular, hadronic mechanics still missed a consistent representation of the isotopic momentum, thus preventing systematic verifications and applications.

After extensive additional studies, the problem resulted to rest where nobody would expect it, in the ordinary differential calculus. It was popularly believed for centuries in mathematics that the differential calculus is independent from the unit of the underlying field. Such a belief is, of course, correct, for *constant units*. However, isomathematics uses isounits with an arbitrary functional dependence that does require the lifting into the *isodifferential calculus*, that permitted the first invariant formulation of the *isomomentum* [4d]

$$\hat{p}_k \hat{\times} |\hat{\psi} \rangle = -\hat{i} \hat{\times} \hat{\partial}_k |\hat{\psi} \rangle = -i \times \hat{I}_k^i \times \partial_i |\hat{\psi} \rangle, \quad (2.8)$$

with *isocanonical commutation rules*

$$[\hat{r}^i, \hat{p}_j] = \hat{i} \hat{\times} \hat{\delta}_j^i = i \times \delta_j^i \times \hat{I}, \quad [\hat{r}^i, \hat{r}^j] = [\hat{p}_i, \hat{p}_j] = 0. \quad (2.9)$$

A few comments are now in order. Note the identity of Hermiticity and its isotopic image,  $(\langle \hat{\psi} | \hat{\times} \hat{H}^\dagger) \hat{\times} |\hat{\psi} \rangle \equiv \langle \hat{\psi} | \hat{\times} (\hat{H} \hat{\times} |\hat{\psi} \rangle)$ ,  $\hat{H}^\dagger \equiv \hat{H}^\dagger$ , thus implying that all quantities that are observable for quantum mechanics remain observable for hadronic mechanics; the new mechanics is indeed isounitary, thus avoiding the theorems of catastrophic inconsistencies of nonunitary theories; hadronic mechanics preserves all conventional quantum laws, such as Heisenberg's uncertainty principle, Pauli's exclusion principle, etc.; hadronic mechanics has been proved to be "directly universal" for all possible theories with conserved energy, that is, capable of representing all infinitely possible systems of the class admitted (universality) directly in the frame of the observer without transformations (direct universality); and numerous other features one can study in Refs. [3i,3k,3l].

Note the crucial *representation of irreversibility under the conservation of the total energy*, as necessary for isolated irreversible processes such as controlled nuclear fusions,

$$\hat{T}(t, \dots) = \hat{T}^\dagger(t, \dots) \neq T(-t, \dots), \quad i \times d\hat{H}/dt = [\hat{H}, \hat{H}] \equiv 0. \quad (2.10)$$

Also, one should note that *hadronic mechanics verifies the abstract axioms of quantum mechanics to such an extent that the two mechanics coincide at the abstract, realization-free level*. In reality, hadronic mechanics provides an explicit and concrete realization of the theory of "hidden variables"  $\lambda$  [2c], as one can see from the abstract identity of the isoeigenvalue equation  $H \hat{\times} |\hat{\psi}\rangle = \hat{E} \hat{\times} |\hat{\psi}\rangle$  and the conventional equation  $H \times |\psi\rangle = E \times |\psi\rangle$ , by providing in this way an *operator* realization of hidden variables  $\lambda = \hat{T}$  (for detailed studies on these aspects, including the *inapplicability* of Bell's inequality [2d] for hadronic mechanics due to its nonunitary structure, we refer the reader to memoir [7h]).

We should also indicate that the birth of hadronic mechanics can be seen in the following *new isosymmetry*, here expressed for a constant  $K$  for simplicity,

$$\langle \psi | \times | \psi \rangle \times 1 \equiv \langle \psi | \times K^{-1} \times | \psi \rangle \times (K \times 1) = \langle \psi | \hat{\times} | \psi \rangle \times \hat{I}. \quad (2.11)$$

The reader should not be surprised that the above isosymmetry remained unknown throughout the 20-th century, because its identification required the prior discovery of *new numbers*, Santilli's isonumbers with arbitrary units [5c].

Compatibility between hadronic and quantum mechanics is reached via the condition

$$\text{Lim}_{r \gg 10^{-13} \text{cm}} \hat{I} \equiv I, \quad (2.12)$$

under which hadronic mechanics recovers quantum mechanics uniquely and identically at all levels.

The name of "hadronic mechanics" was suggested by Santilli [5a] to represent strong interactions as well as all possible short range interactions. The new mechanics was then constructed in such a way to coincide everywhere with quantum mechanics except inside the so-called *hadronic horizon*, namely, a sphere of radius  $1F = 10^{-13} \text{cm}$ .

A simple method has been identified in Refs. [5f,5g] for the construction of hadronic mechanics and all its underlying new mathematics. This method is important for controlled nuclear fusions because it permit the implementation of existing conventional models into covering isomodels, thus permitting the addition of contact nonpotential interactions that will soon acquire a crucial role for controlled nuclear fusions. The method consists in:

(i) Representing all conventional interactions with a Hamiltonian  $H$  and all non-Hamiltonian interactions and effects with the isounit  $\hat{I}$ ;

(ii) Identifying the latter interactions with a nonunitary transform

$$U \times U^\dagger = \hat{I} \neq I \quad (2.13)$$

and

(iii) Subjecting the *totality* of conventional mathematical, physical and chemical quantities and all their operations to the above nonunitary transform, resulting in expressions of the type

$$I \rightarrow \hat{I} = U \times I \times U^\dagger = 1/\hat{T}, \quad (2.14a)$$

$$a \rightarrow \hat{a} = U \times a \times U^\dagger = a \times \hat{I}, \quad (2.14b)$$

$$\begin{aligned} a \times b &\rightarrow U \times (a \times b) \times U^\dagger = \\ &= (U \times a \times U^\dagger) \times (U \times U^\dagger)^{-1} \times (U \times b \times U^\dagger) = \hat{a} \hat{\times} \hat{b}, \end{aligned} \quad (2.14c)$$

$$e^A \rightarrow U \times e^A \times U^\dagger = \hat{I} \times e^{\hat{T} \times \hat{A}} = (e^{\hat{A} \times \hat{T}}) \times \hat{I}, \quad (2.14d)$$

$$\begin{aligned} [X_i, X_j] &\rightarrow U \times [X_i X_j] \times U^\dagger = \\ &= [\hat{X}_i, \hat{X}_j] = U \times (C_{oj}^k \times X_k) \times U^\dagger = \hat{C}_{ij}^k \hat{\times} \hat{X}_k = \\ &= C_{ij}^k \times \hat{X}_k, \end{aligned} \quad (2.14e)$$

$$\begin{aligned} \langle \psi | \times | \psi \rangle &\rightarrow U \times \langle \psi | \times | \psi \rangle \times U^\dagger = \\ &= \langle \psi | \times U^\dagger \times (U \times U^\dagger)^{-1} \times U \times | \psi \rangle \times (U \times U^\dagger) = \\ &= \langle \hat{\psi} | \hat{\times} | \hat{\psi} \rangle \times \hat{I}, \end{aligned} \quad (2.14f)$$

$$\begin{aligned} H \times | \psi \rangle &\rightarrow U \times (H \times | \psi \rangle) = (U \times H \times U^\dagger) \times (U \times U^\dagger)^{-1} \times (U \times | \psi \rangle) = \\ &= \hat{H} \hat{\times} | \hat{\psi} \rangle, \text{ etc.} \end{aligned} \quad (2.14g)$$

Note that the above simple rules permit the explicit construction of the new isoeigenvalues equations and related iso-Hilbert space over isonumbers, as well as of all needed aspects, including isoalgebras, isosymmetries and their isorepresentations [3].

Note also that *catastrophic inconsistencies emerge in the event even one single quantity or operation is not subjected to isotopies*. In the absence of comprehensive liftings, we would have a situation equivalent to the elaboration of quantum spectral data of the hydrogen atom with isomathematics, resulting of dramatic deviations from reality.

It is easy to see that the application of an additional nonunitary transform  $W \times W^\dagger \neq I$  to expressions (2.14) causes the *lack of invariance*, with consequential activation of the catastrophic inconsistencies of theorems [5j]. However, any given nonunitary transform can be identically rewritten in the isounitary form,

$$W \times W^\dagger = \hat{I}, \quad W = \hat{W} \times \hat{T}^{1/2}, \quad (2.15a)$$

$$W \times W^\dagger = \hat{W} \hat{\times} \hat{W}^\dagger = \hat{W}^\dagger \hat{\times} \hat{W} = \hat{I}, \quad (2.15b)$$

under which hadronic mechanics is indeed isoinvariant

$$\hat{I} \rightarrow \hat{I}' = \hat{W} \hat{\times} \hat{I} \hat{\times} \hat{W}^\dagger = \hat{I}, \quad (2.16a)$$

$$\begin{aligned} \hat{A} \hat{\times} \hat{B} &\rightarrow \hat{W} \hat{\times} (\hat{A} \hat{\times} \hat{B}) \hat{\times} \hat{W}^\dagger = \\ &= (\hat{W} \times \hat{T} \times A \times \hat{T} \times \hat{W}^\dagger) \times (\hat{T} \times \hat{W}^\dagger)^{-1} \times \hat{T} \times (\hat{W} \times \\ &\quad \times \hat{T})^{-1} \times (\hat{W} \times \hat{T} \times B \times \hat{T} \times \hat{W}^\dagger) = \\ &= \hat{A}' \times (\hat{W}^\dagger \times \hat{T} \times \hat{W})^{-1} \times \hat{B}' = \hat{A}' \times \hat{T} \times \hat{B}' = \hat{A}' \hat{\times} \hat{B}', \text{ etc.} \end{aligned} \quad (2.16b)$$

Note that the invariance is ensured by the *numerically invariant values of the isounit and of the isotopic element under nonunitary-isounitary transforms*,

$$\hat{I} \rightarrow \hat{I}' \equiv \hat{I}, \quad A \hat{\times} B \rightarrow A' \hat{\times}' b' \equiv A' \hat{\times} B', \quad (2.17)$$

in a way fully equivalent to the invariance of quantum mechanics, as expected to be necessarily the case due to the preservation of the abstract axioms under isotopies. The resolution of the catastrophic inconsistencies for noninvariant theories is then consequential.

Hadronic mechanics has nowadays clear experimental verifications in particle physics, nuclear physics, superconductivity, chemistry, astrophysics, cosmology and biology (see monographs [3j,3k,3l] for details), which verifications cannot possibly be reviewed here. We merely mention for subsequent need for controlled nuclear fusions the reformulation of valence bonds via hadronic chemistry characterized by the isounit [9a,9b]

$$\begin{aligned} \hat{I} = & \text{Diag.}(n_{11}^2, n_{12}^2, n_{13}^2, n_{14}^2) \times \text{Diag.}9n_{21}^2, n_{22}^2, n_{23}^2, n_{24}^2) \times \\ & \times e^{N \times (\hat{\psi}/\psi) \times \int d^3r \times \psi_{\downarrow}^{\dagger}(r) \times \psi_{\uparrow}(r)} \end{aligned} \quad (2.18)$$

where  $n_{ak}^2$ ,  $a = 1, 2, k = 1, 2, 3$  are the semiaxes of the ellipsoids characterizing the two particles,  $n_{a4}$ ,  $a = 1, 2$  represents their density,  $\hat{\psi}$  represents the isowavefunctions,  $\psi$  represents the conventional function, and  $N$  is a positive constant.

The use of the above isounit permitted R. M. Santilli and D. Shillady [9a,9b] to reach the first exact and invariant representation on scientific records of all characteristics of the hydrogen, water and other molecules, said representation being achieved directly from first axiomatic principles without any *ad hoc* parameters, or screening adulterations of the Coulomb law. In reality, due to its nonunitary structure, hadronic chemistry contains as a particular cases all infinitely possible screenings of the Coulomb laws (see [3l] for details).

Note the admission of quantum chemistry for the atomic structure in molecular bonds and the use of a covering chemistry only in the short range valence interactions, namely, inside the "hadronic horizon." In fact, at distances sufficiently greater than  $1F$ , the volume integral in the exponent of Eq. (2.18) is identically null, the actual dimensions and density of the particles are ignorable, and Santilli's isounit (2.18) verifies the crucial condition (2.12).

We should also mention that, when the Schrödinger-Santilli isoequation is worked out in detail under isounit (2.18), there is the emergence of a strongly attractive Hulthen potential that, as well known, behaves at short distances like the Coulomb potential, thus absorbing the repulsive Coulomb force between the valence electrons [9a,9b].

$$\begin{aligned} U \times \left[ \left( \frac{1}{2\mu_1} p_1 \times p_1 + \frac{1}{2\mu_2} p_2 \times p_2 + \frac{e^2}{r_{12}} - \frac{e^2}{r_{1a}} - \frac{e^2}{r_{2a}} - \frac{e^2}{r_{1b}} - \frac{e^2}{r_{2b}} + \frac{e^2}{R} \right) \times |\psi\rangle \right] \approx \\ \approx \left( -\frac{\hbar^2}{2 \times \mu_1} \times \nabla_1^2 - \frac{\hbar^2}{2 \times \mu_2} \times \nabla_2^2 - V \times \frac{e^{-r_{12} \times b}}{1 - e^{-r_{12} \times b}} - \right. \\ \left. - \frac{e^2}{r_{1a}} - \frac{e^2}{r_{2a}} - \frac{e^2}{r_{1b}} - \frac{e^2}{r_{2b}} + \frac{e^2}{R} \right) \times |\hat{\psi}\rangle, \end{aligned} \quad (2.19)$$

(see monograph [3], chapters 4 and 5 for details). The insufficiency of quantum chemistry is now transparent because, without the hadronic lifting, the total electromagnetic force between the two hydrogen atoms is identically null.

Refs. [9a,9b] achieved in this way the first model of valence bonds in scientific records with an *explicitly computed and strongly attractive force between the electrons of a valence bond*, for which reason the model is today often referred to as the *Santilli-Shillady strong valence bond*, where the word "strong" evidently refers to the strength of the valence force.

Superficial inspections of hadronic mechanics and chemistry may tend to dismiss the relevance of the strong valence bond for controlled nuclear fusions. Recall that the conventional quantum view on valence are basically insufficient to explain how two electrons can bond to each other to form the molecular structures of our everyday life, while having identical charges that cause extreme repulsions at the distances of valence bonds. For this reason, the various valence models of quantum chemistry are mere nomenclatures, because none of them identifies the *attractive* character of the valence force in an *explicit* form, let alone with an *numerical value* sufficient to represent reality.

A crucial feature established by hadronic chemistry is that *the new contact, nonlinear, nonlocal and nonpotential interactions due to wave-overlapping are strongly repulsive at short distance for triplet couplings (parallel spins) and strongly attractive in singlet coupling (antiparallel spins)*.

After (and only after) the above scientific journey, the importance of hadronic mechanics and chemistry begins to emerge for the objective that motivated their construction, the prediction and quantitative treatment of basically *new* clean energies and fuels, that is, energies and fuels NOT predicted by quantum mechanics and chemistry.

The *isotopic (axiom-preserving) lifting of special relativity* required a parallel extensive research that cannot possibly be reviewed here. We merely mention that this lifting, today known as *isorelativity*, was first reached by Santilli as follows: the first isotopies of the Minkowski space were presented in Ref. [7a,7b]; the first isotopies of the rotational symmetry were reached in Ref. [7c]; the first isotopies of the SU(2)-spin symmetry were formulated in Ref. [7d]; the first isotopies of the Poincaré symmetry and special relativity were submitted in Refs. [7e]; the first isotopies of the spinorial covering of the Poincaré symmetry were reached in Refs. [7f,7g]; the first implications for local realism were reached in Ref. [7h]; and the first comprehensive studies on the iso-Minkowskian geometry were presented in Ref. [7i] (for numerous related works, see monographs [3]).

Note that, due to the positive-definiteness of the isounit and rule (2.14c), all isosymmetries are locally isomorphic to the original symmetries, as necessary under isotopies, yet they provide the most general known nonlinear, nonlocal and non-Hamiltonian realizations of known spacetime and internal symmetries. Intriguingly, these isosymmetries generally reconstruct as exact on isospaces over isofields all symmetries believed to be broken [3h,3i].

The reader should know that isorelativity is based on a *geometric unification of the Minkowskian and Riemannian geometries* [7i], with *consequential unification of special and general relativities* that are now differentiated by the selected realization of Santilli's isounit. These unifications permitted a novel formulation of gravity that is invariant under the Poincaré-Santilli isosymmetry. These advances have permitted the first and perhaps only

known axiomatically consistent grand unification of electroweak and gravitational interactions [8], where the axiomatic consistency is achieved thanks to the reformulation of gravity via the axioms of electroweak interactions.

The reader should also be aware that *isorelativity provides the ultimate formulation of the possible industrial realization of controlled nuclear fusions proposed in this paper*. As an illustration, certain key features of controlled nuclear fusions predicted by isorelativity are dependent on the abandonment of the philosophical abstraction of the "universal constancy of the speed of light" and the assumption instead that light is a local variable  $C = c/n(t, r, p, \mu, \omega, \dots)$  depending on the characteristics of the medium in which it propagates, assuming that light can propagate at all in a given medium.

Another belief that has to be abandoned for the formulation of "new" energies is that the speed of light is the maximal causal speed, and the replacement with a new *maximal causal speed characterized by the geometry of the medium*, that happens to be  $c$  in vacuum. An illustration is given electrons propagating in water at a speed 1/3-rd greater than the local speed of light (Cerenkov effect), with consequential catastrophic inconsistencies in case special relativity is assumed to be valid within physical media.

If the speed of light *in vacuum* is assumed as the maximal causal speed *in water*, we have the violation of the principle of causality, while if we assume the speed of light *in water* to be the maximal causal speed *in water*, we have the violation of the relativistic addition of speeds. The statement that special relativity is recovered by reducing light to photons scattering among atoms has been proved to be nonscientific because: 1) The reduction to photons of electromagnetic waves with one meter wavelengths traveling in water with speed  $\frac{2}{3}c$  has no credibility; 2) The reduction to photons for light traveling faster than that in vacuum according to vast experimental evidence now available is nonscientific; and 3) The nonscientific character of the reduction is established by the fact that the reduction of light to photons, even when applicable, is afflicted by an error in defect of about 30%, namely, it can only represent a few percentage of the reduction of the speed of light, and not its 33% reduction (due to the very low cross section of Compton scattering as serious scientist are expected to know).

In reality, there is no need for calculations, but only to observe and admit evidence visible to our naked eye. A source of light submerged within pure water shows no dispersion. This implies that photons have to scatter along a straight line to represent the lack of dispersion, a first impossibility, while on the other side, the speed of light is decreased of about 33% compared to the speed in vacuum. The impossibility of a credible manipulation in an attempt to salvage special relativity under these conditions is beyond credible doubt.

In conclusion, as clearly stated by Albert Einstein in his limpid writing, and as reviewed in Section 1, special relativity was conceived, constructed and verified *in vacuum*. The validity of special relativity for all conditions existing in the universe has been proffered by Einstein's followers. Evidence beyond any possible doubt establish that special relativity is inapplicable for interior dynamical problems, including dynamics within physical media, systems without a Keplerian nucleus (as it is the case for nuclear fusions) and others.

Rather than being topics of esoterica academic interest, the above issues have direct societal implications for the much needed new clean energies and fuels. In fact, *nuclei*

*constitute some of the densest media measured by mankind until now.* It then follows that *nuclear fusions cannot be reduced to events in vacuum.* Consequently, any insistence without clear evidence on the exact validity of special relativity for nuclear fusions was tolerated in the past as an act of scientific fervor, but nowadays the potential severe injury to society forces the denunciation of such a fervor particularly when proffered by experts.

**3. Physical Laws of Cold, Intermediate and Hot Fusions as Predicted by Hadronic Mechanics, Hadronic Chemistry and Isorelativity.** One of the first contributions of hadronic mechanics, hadronic chemistry and isorelativity to controlled fusions is the identification of seven different physical laws that have to be obeyed by all Controlled Nuclear Fusions (CNF) to occur, and have to be optimized in engineering realizations for CNF to acquire industrial relevance. These laws were first derived in ref. [3k], they apply for cold, intermediate and hot fusions, and are referred to in the literature as *Santilli's laws for Controlled Nuclear Fusions*. We are not in a position to review here their derivation to avoid a prohibitive length. Nevertheless, for completeness of this presentation we provide below their outline with a few comments.

**LAW I: CNF must verify the conservation of the energy.** This is the trivial law that needs no comment.

**LAW II: The most probable CNF are those occurring under the conservation of the angular momentum.** The differences between quantum and hadronic mechanics begin to emerge. Conservation laws of linear momentum and angular momentum are necessary for Keplerian structures, such as planetary or atomic systems, in which no collision among the constituents is admitted and the constituents are assumed to be point-like. The same laws are not necessarily verified for the broader interior systems that include collisions of extended constituents. To do serious science we must admit that *during actual collisions of extended particles (such as billiard balls), linear momentum can be transformed into angular momentum, and vice versa.* The same feature must be kept under quantization to avoid evident inconsistencies. Needless to say, whenever linear momentum and angular momentum transforms into each others, the sum of their energies is conserved. Stated differently, the only conservation laws out of ten characterized the Poincaré symmetry that are necessarily verified in the physical reality are the conservation of the energy and the uniform motion of the center of mass for isolated systems. It is at this point where isorelativity becomes mandatory to conduct serious scientific studies of CNF. In fact, the Poincaré-Santilli isosymmetry does indeed permit the exchange of linear momentum into angular momentum and vice-versa (under the conservation of the total energy) because occurring under the lifting of the conventional symmetry firstly, to represent extended particles and, secondly, to represent "contact" interactions as in Eq. (2.12). Exchanges of linear and angular momenta under collisions are then consequential. Note that "cold fusions" may not admit energies sufficient for the transformation of linear into angular momentum. However, these energies are definitely available for the "hot fusions," while the case of "intermediate fusions" requires specific studies.



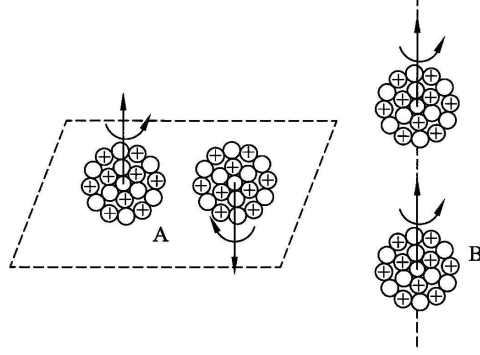

Figure 2: A schematic view of only two stable couplings permitted by hadronic mechanics, the "planar singlet coupling" of the l.h.s. and the "axial triplet coupling" of the r.h.s. All other spin configurations have been proved to produce strongly "repulsive" forces under which no CNF is credibly possible. The configuration preferred in this paper is the axial one for reasons of bigger efficiency in the energy output.

**LAW III: CNF only occur for nuclei with compatible spins given by the "planar singlet coupling" or the "axial triplet coupling" of Figure 3.** This is another law with profound engineering implications indicated in Section 5. This law also illustrates the structural differences between quantum and hadronic mechanics, as well as the necessity of the latter for CNF. The constituents of a bound state of two quantum particles must necessarily be point-like to avoid structural inconsistencies beginning with the local-differential topology. Consequently, singlet and triplet couplings are equally possible for quantum mechanics. When the actual extended character of the constituents is taken into account, it is easy to see that *planar triplet couplings of extended particles at short distances are strongly repulsive, while planar singlet couplings are strongly attractive*, where the word "planar" is intended to indicate that the two nuclei have a common median plane (Figure 2). This law was introduced by Santilli in the original proposal [5a] to build hadronic mechanics via the so-called *gear model*. In fact, the coupling of gears in triplet (parallel spins) causes extreme repulsion to the point of breaking the gear teeth, while the only possible coupling of gears is in singlet (antiparallel spins). As we shall see, the first reason why "cold" and "hot" fusions have not achieved industrial relevance until now is the general lack of controlled implementation of this basic law.

**LAW IV: The most probable CNF are those occurring at threshold energies (namely, at the minimum value of the energies of the constituents needed to verify Law 1).** A main reason of this law is that *all energies above the indicated threshold value cause instability that reduce the rate of synthesis*. As we shall see, the lack of engineering implementation of this law constitutes another reason why "cold" and "hot" fusions have not achieved industrial relevance until now. Note that this law favors the "cold" over the "hot" fusion. In fact, the lack of achievement of industrial significance by the "hot fusion" until

now is particularly due to instabilities caused by the available energies that are excessively bigger than the indicated threshold value.

**LAW V: The most probable CNF are those without the release of massive particles (such as protons, neutrons and electrons).** This law was not expected by the author. Yet, contrary to popular beliefs, explicit calculations based on hadronic (and certainly not quantum) mechanics indicated that the probability of a nuclear synthesis with the release of neutrons is much *smaller* than that of another synthesis with the emission of massive particles. As we shall see, this fourth law appears to be verified by nuclear syntheses spontaneously occurring in nature.

**LAW VI: A necessary condition for CNF to occur is to control the peripheral atomic electrons in such a way to allow nuclei to be exposed.** Nature has set matter in such a way that nuclei are strongly shielded by their atomic clouds. It is evident that a "nuclear" synthesis between two conventional "atoms" is impossible at low energies because the electron clouds will never allow nuclei to approach each other, let alone to synthesize a new nucleus. This law explains the difficulties for "cold fusions" to achieve industrial significance in energy output because, by definition, "cold fusions" do not have the energy necessary for the ionization of atoms. This law also illustrates the need for the proposed "intermediate fusions."

**LAW VII: CNF cannot occur without a trigger (that is, an external mechanism forcing exposed nuclei through the hadronic horizon).** All nuclei are positively charged, thus repelling each other. Without a mechanism that overcomes the Coulomb repulsion and brings nuclei inside the hadronic horizon of  $1F = 10^{-13}cm$ , no nuclear synthesis is evidently possible. However, when inside the hadronic horizon and the preceding laws are verified, the synthesis is inevitable, as we shall see, due to the strongly attractive hadronic forces as for model (2.19).

Evidently, the achievement of industrially relevant energy outputs by CNF requires the engineering optimization of all preceding laws. This is less obvious of what may appear in first inspection because each law can be realized in a number of different engineering versions. However, this does not mean that all realizations have equal efficiency. Maximization of the energy output is realized only when said engineering realizations "optimize" the laws.

It is instructive to examine a representative case of "cold fusion" under the above physical laws. Consider the *Fleishmann-Pons electrolytic cell* [1a]. It is easy to see that this cell does indeed verify Law I (conservation of the energy), Law II (conservation of the angular momentum), Law IV (absence of excessive energy over threshold), Law V (absence of secondary radiation) and law VII (the trigger being characterized in this case by the electrostatic pressure compressing deuteron atoms inside the palladium).

However, Fleishmann-Pons electrolytic cell [1a] does not verify Law III (control of the singlet couplings) as well as Laws VI (control of atomic clouds to expose nuclei). In fact, nuclear spin couplings occur at random, there is no clearly identified mechanism to expose nuclei, and there is an equally clear lack of optimization of the verified laws. Consequently,

nuclear syntheses occur at random, thus preventing industrial values of the energy outputs.

It is an instructive exercise for researchers serious in real advances in new clean energies to inspect other realizations of "cold fusions" among the large variety existing in the literature [1b-1c]. One can see in this way that, to our best knowledge at this time, *none of available "cold fusions" realizes "all" seven basic laws* (the indication of the contrary would be appreciated).

In conclusion, Santilli's Laws on Controlled Nuclear Fusions practically rule out the possible achievement of industrially meaningful "hot fusions," by confirming in this way a rather widespread consensus in the scientific community. The same laws offer serious possibilities for "cold fusions" to achieve industrial relevance under a number of revisions of their engineering realizations, by therefore confirming another widespread consensus. However, the same laws identify quite clearly the need for the proposed "intermediate fusions" in order to optimize their engineering realizations.

**4. The New Chemical Species of Santilli's Magnecules.** Inspection of Laws I-VII for Controlled Nuclear Fusions (CNF) reveals that the most difficult engineering realization is that of Law VI on the control of electron clouds so as to expose nuclei as a pre-requisite for their fusion. The author has worked for years to achieve an industrially relevant solution of this problem (thanks to large private investments). This section is devoted to a brief outline of the proposed solution because truly basic for the concrete industrial realization proposed in the next section.

The current environmental problems are not caused by fossil fuels per se, but rather by the strength of their valence bonds that has prevented the achievement of a full combustion for over one century. In fact, hydrocarbons and other pollutants in the exhaust literally are chunks of uncombusted molecules (for which very reason these pollutants are carcinogenic).

A solution was proposed in Ref. [9c] of 1998 consisting of a new chemical species, today known as *Santilli magnecules* (in order to distinguish them from the conventional molecules) whose bond is stable, but sufficiently weaker than the conventional valence bond to permit full combustion (see website [9d] and monograph [31] for comprehensive studies).

The new species required the identification of a *new attractive force among atomic constituents that is not of valence type as a central condition, thus occurring among atoms irrespective of whether valence electrons are available or not.*

The solution proposed in Ref. [9c] was the use of an external magnetic field sufficient to create the polarization of atomic orbitals into toroids, as a result of which the orbiting electrons create a magnetic moment along the symmetry axis of the toroid that is non-existing in the conventional spherical distribution of the same orbitals.

Evidently, individual toroidal polarizations are, individually, extremely unstable because the spherical distribution is recovered in nanoseconds following the removal of the external magnetic field due to temperature related effects. Nevertheless, when two toroidal polarizations are bonded together by opposing magnetic polarities North-South-North-South- etc. as in Figure 3, spherical distributions are again recovered in nanoseconds following the removal of the external magnetic field, but this time such distribution occurs for the bounded pair as a whole.

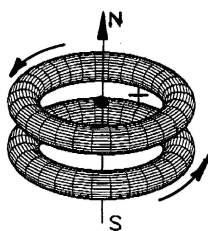

Figure 3: A schematic view of a "diatomic Santilli magnecule" consisting of the bonding of two atoms caused by the attractive force between opposing polarities North-South-North-South- etc. of toroidal polarizations of at least some peripheral atomic electrons [9c,9d]. Note that, in reality, the "magnecular bond" is rather complex since it is characterized by the attraction among "three" magnetic moments (those of the toroids, plus the intrinsic magnetic moments of the electrons and of the nuclei), as well as the repulsive force among equal nuclear and electron charges. Consequently, the figure depicts a condition of equilibrium between these opposing forces. Note also the absence in magnecular bonds of considerations pertaining to the nature of the atoms and the possible availability of valence electrons. Note finally the lack of limits in the number of constituents in magnecules except limits set by instabilities due to collisions. Note that Santilli's magnecules naturally realize the "axial" (but not the "planar") compatible spin coupling of Figure 2 (see monograph [31] for comprehensive studies).

The experimental detection of magnecules is rather difficult since it requires analytic instruments and methods different than those currently used to detect molecules. Vice versa, analytic methods so effective to detect molecules generally reveals no magnecules, and this explains their lack of detection since the discovery of molecules in the mid of the 19-th century.

An analytic equipment developed for molecules that is also effective for the detection of gaseous (liquid) magnecules is given by a Gas (Liquid) Chromatographer Mass Spectrometer necessarily equipped with InfraRed Detector for gases (GC-MS/IRD) or with UltraViolet Detector for liquids (LC-MS/UVD).

Let us recall that large clusters (of the order of hundreds of amu or more) cannot be constituted by molecules when without an IR signature for gases or a UV signature for liquids, because that would require perfect sphericity that is prohibited by nature for a large number of constituents.

The detection of a magnecule requires its identification, firstly, with a peak in the MS that must result to be unknown following the computer search among all known molecules and, secondly, that peak must show no IR or UV signature at its amu value. The latter condition explains the need for a GC-MS (or LC-MS) necessarily equipped with IRD (UVD). In fact, if the same species is tested with an IRD (or UVD) disjoint from the MS, the IRD (UVD) is not generally focused on the selected MS peak at its amu value, resulting in the detection of

a variety of signatures of conventional molecular species that, in reality, are the *constituents* of the considered magneucle. Note that the lack of IR or UV signature also confirms the achievement of the desired *bond weaker than the valence*, as needed to achievement full combustion (see, for details, website [9c]).

As indicated in Section 2, the word "valence" is essentially a nomenclature due to the lack of explicit and concrete identification of the "attractive" force necessary to produce a valance bond (for Santilli-Shillady strong valence force as in Eq. (2.19), see Refs. [9a,9b,3l]). By comparison, Santilli identified in the original proposal [9c] the *attractive character* of the magneuclear forces as well as its *numerical value*, that was confirmed by Kucherenko and Aringazin [9e] as well as by others [3l].

The importance of the new species of magnecules for controlled nuclear fusions is established by an inspection of Figure 3, where one can see that the toroidal polarizations of the peripheral orbitals does indeed expose nuclei, as desired. The configuration clearly result to be preparatory for the subsequent nuclear synthesis. Finally, the absence of IR signatures for gases or UV signatures for liquids confirms that the bond occurs at low energy, as necessary for controlled nuclear fusions. We therefore have the following:

*DEFINITION [9c,3k,3l]: Santilli's magnecules are stable clusters consisting of individual atoms (H, C, O, etc.), dimers (OH, CH, etc.) and ordinary molecules (CO, H<sub>2</sub>O, etc.) bonded together by opposing magnetic polarities originating from toroidal polarizations of the orbitals of atomic electrons.*

Numerous new substances with magneuclear structures have been identified experimentally to date, among which we indicate MagneGas<sup>TM</sup> [9d], MagneHydrogen<sup>TM</sup> [9h], *HHO*<sup>TM</sup> [9i], and others under industrial development. Their primary features (for which large industrial investments have been made) is the complete combustion without contaminant in the exhaust and cost competitiveness over fossil fuels.

It is now customary in the field to denote a molecular bond with the symbol "–" and a magneuclear bond with the symbol "×." Consequently, the hydrogen molecule is represented with  $H_2 = H - H$ , while hydrogen magnecules are represented with the symbol  $MH = H \times H \times \dots$ . A main difference is that the only possible valence bond is  $H_2$  (trivially, because the hydrogen atom has only *one* electron), while there is no theoretical limit for the number of constituents under magneuclear bond except those set by collisions. In fact, a species of MagneHydrogen  $H_{14}$  having *seven* times the amu of  $H_2$  has been detected in independent laboratories [9h]. The latter measurements provide final confirmation on the existence of magnecules due to the evident impossibility of any credible interpretation via valence.

**5. Proposed Industrial Realization of Controlled Intermediate Fusions via Hadronic Reactors.** Without any claim of completeness or uniqueness, in this section we propose in the necessary construction details a concrete *hadronic reactor* (patented and international patents pending), that is, an equipment for the possible industrial utilization of new clean energies produced by Intermediate Energy Controlled Nuclear Fusions (IECNF), or "intermediate fusions" (IF) for short, via the engineering implementation and optimization of all seven Santilli's Laws on Controlled Nuclear Fusions of Section 3. The application of the re-

sults to Low Energy Controlled Nuclear Fusions (LECNF), or "cold fusions" (CF) for short, will be left to interested readers. High Energy Controlled Nuclear Fusions (HECNF), or "hot fusions" (HF) for short, shall be ignored because outside realistic feasibility based on current scientific knowledge and technological capabilities.

To begin, we use nature, rather than pre-existing research [1], for guiding lines. As established by chemical analyses of air bubbles in amber, about one hundred millions years ago Earth's atmosphere had about 40% of nitrogen, while its current percentage is about double that value. Other chemical analyses show that the increase of nitrogen in our atmosphere has been gradual. These data establish *the existence in our atmosphere of a process for the natural synthesis of nitrogen from lighter elements*.

Among all possible origins of such a synthesis, the most probable is given by *lighting*, because a serious scientific (that is, quantitative) explanation of *thunder* requires nuclear syntheses. In fact, a numerical explanation of one thunder requires energy equivalent to hundreds of tons of explosives that simply cannot be explained via conventional processes due to the very small cylindrical volume of air affected by lightning combined with its extremely short duration of the order of nanoseconds (serious scholars are suggested to do these calculations to prevent venturing nonscientific opinions).

By comparison, a relatively low rate of nitrogen syntheses provides indeed a numerical explanation of thunder as well as its slow rate of increase in our atmosphere. Among all possible syntheses, the most probable results to be the *synthesis of nitrogen from carbon and deuteron*. Needless to say, numerous alternative fusions are also possible and some of them will be indicated below.

Consequently, by following nature, in this section we propose a specific and concrete industrial realization of hadronic reactors that, by central conception, is based on processes associated to lighting and thunder. Therefore, we have the following optimization of Laws I-VII for the specific objective at hand:

**Optimization of Law I:** For the preferred embodiment identified below, the implementation and optimization of energy conservation can be achieved by controlling the temperature of the chemical species selected for IECNF.

**Optimization of Law II:** For simplicity, as well as in order to operate at the *lowest* possible energies, in this section we shall select engineering realizations and optimization applicable under the conservation of the angular momentum, with the understanding that the restriction is not scientifically necessary for the conditions at hand in which the Poincaré symmetry and special relativity are inapplicable, thus permitting a variety of additional hadronic reactors (that would be suppressed by a nonscientific imposition of special relativity for conditions it was not built for with evident damage to society) we plan to address in a subsequent paper.

**Optimization of Law III:** With reference to Figure 2, there are two types of engineering implementation and optimization of the condition to have compatible spins, called in the literature of hadronic mechanics [3i,3k] *planar and axial compatible couplings*. The engineering "implementation" of the planar coupling can indeed be achieved (see the various

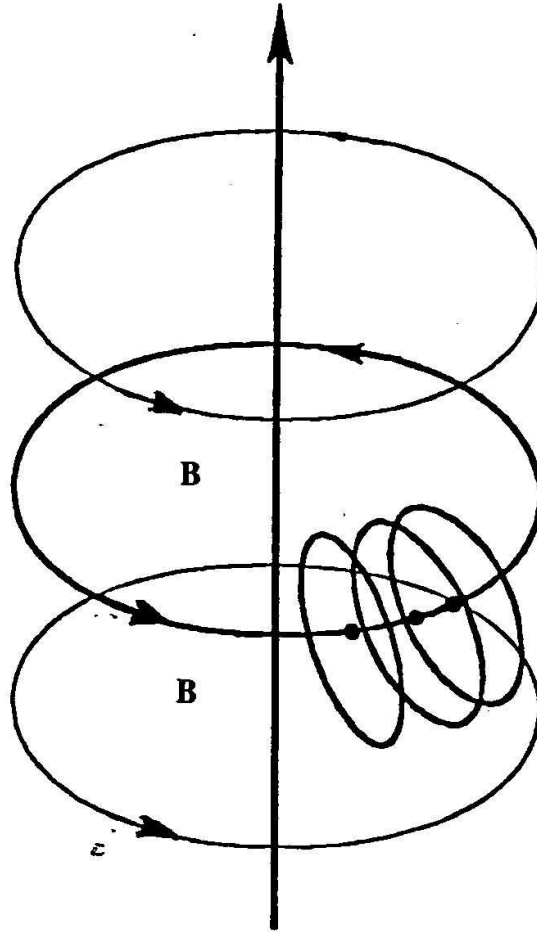

Figure 4: A schematic view of the geometry of a DC electric arc represented by the vertical line, with the associated magnetic field represented by horizontal circles, and the created magnecules represented by circles perpendicular to the latter. This geometry has the following primary implications: 1) Since the magnetic field  $M$  is proportional to  $I/r$ , one can see that at atomic distances  $r = 10^{-8}\text{cm}$  from electric arcs with  $I = 10^3\text{A}$  the magnetic field is of the order of  $10^{11}\text{G}$ , thus being amply sufficient to polarize atomic orbitals [3l,9f,9g]; 2) Following said polarization, the geometry of electric arcs is such to align automatically polarized atoms with opposing polarities North-South-North-South-..., thus creating magnecular bonds automatically possessing the axial spin couplings of Figure 2; and 3) For reasons not entirely understood [9c], electric arcs compress magnecules toward their axis at the time of their initiation or shut off, thus assisting in the realization of the trigger necessary for nuclear fusions.

proposals of Refs. [3i,3k,3l]), e.g., by subjecting to opposing polarizations two nuclear beams. However, the "optimization" of Law III definitely suggests the adoption of the compatible axial coupling over the planar one for various reasons, such as the fact that, for the case of planar coupling, the control of the polarization is lost at the initiation of the fusion, with evident dispersal and loss of efficiency, while the axial coupling can be controlled all the way to the completion of the fusion, with evidently higher efficiency. Therefore, the preferred embodiment depicted below is based on the engineering implementation and optimization of Law III via compatible axial couplings.

**Optimization of Law IV:** For the preferred embodiment of this section, the engineering implementation and optimization of the minimal possible threshold energy is also achievable via the control of the temperature and other features discussed below.

**Optimization of Law V:** The implementation of this law is achieved by selecting nuclei in such a way that *the original as well as final nuclei are natural and stable isotope*. The "optimization" of this law definitely favors *light, natural and stable nuclei* over heavier ones for various reasons, e.g., the fact that the heavier the nuclei, the bigger the possibilities for secondary radiations.

**Optimization of Law VI:** As indicated in the preceding section, the hadronic reactors proposed in this paper are based on the creation of a magnecular bond prior to the nuclear fusion because this new bond automatically verifies Laws I, II, III, IV, V and VI. However, the creation of the new species of magnecular is not elementary because as studied by Aringazin [9f], the polarization of electron orbitals to create magnecular bonds requires magnetic fields so intense (of the order of  $10^{10}G$  or more) that cannot be provided by the most powerful laboratory magnets. The solution adopted by Santilli [9d] in the original proposal of the new chemical species of magnecules is the use of *flowing a selected fluid through a submerged electric arc so as to continuously remove magnecules from the arc soon after their formation* (this is the so-called "PlasmaArcFlow<sup>TM</sup> Process [9d] - US Patented and international patents pending). In fact, the magnetic field surrounding electric arcs has indeed the intensity necessary for the toroidal polarization of the orbitals. The continuous removal of the magnecules from the arc is then necessary for control of the process.

**Optimization of Law VII:** As it is well known in the new field of clean burning fuels, magnecular bonds such as that of Figure 4 *cannot* yield nuclear fusions, trivially, because the two nuclei have the same charge, thus experiencing an intense Coulomb repulsion. Magnecular structures such as that of Figure 3 essentially consist of a new statistical equilibrium among a variety of electromagnetic forces. In order to convert a magnecular bond as that of Figure 3 into a nuclear fusion, there is the need of an external mechanism (the "trigger") that forces the two nuclei at mutual distances of the order of  $10^{-13}cm$  (the "hadronic horizon"), at which point the new strongly attractive forces identified by hadronic mechanics and chemistry take effect and, under the verification of all preceding laws, the fusion is inevitable. The "trigger" adopted in this proposal is given by a combination of *pressures* as well as *pulse DC arcs*.



The achievement of "intermediate fusions" of industrial value requires the systematic production of energy in a reliable and repetitive way without excessive service interruptions. The "implementation" of this requirement eliminates liquids as feedstocks of hadronic reactors because of the short life of the electrodes needed for the creation of magnecular bonds and other reasons. In fact, arcs within liquids can only occur at very short distances proportional to the arc power, thus exposing the electrodes to the large energy of the fusion, with their consequential rapid disintegration and lack of industrial maturity. More generally, the "optimization" of the requirement here considered requires the abandonment of a rather general tendency in the field [1], that of materializing nuclear fusions inside the electrodes themselves. In fact, this approach prevents any possible industrially viable engineering because of the extremely short life of the electrodes, let alone their cost. To avoid these problem, the "optimization" here selected is that *"intermediate fusions" are created by the arc itself and not by the electrodes.*

By using the above optimization, a preferred embodiment of the hadronic reactors herein proposed consists of a metal vessel capable of withstanding steady pressures up to 10,000psi (666bars) as well as impulse pressures up to 100,000psi (6666bars) in which a 50 Kw DC electric arc of steady and impulse nature is initiated, maintained and optimized via the automatic controls of the Magnegas Technology [9d]. The vessel is filled up with a *gaseous* (rather than liquid) feedstock as selected below and continuously recirculated through said arc. The control of the energy output is done by controlling: 1) the value and frequency of the impulse pressure; 2) the power and the frequency of the pulse DC arc; and 3) the flow of the fluid through the arc.

With respect to Figure 5, the proposed hadronic reactor (patented and international patents pending) comprises: a metal vessel 232 with hemispherical heads 233 and fasteners 252 and bases 234 capable of withstanding a steady pressure of at least 10,000 psi (666 bars) and an impulse pressure of at least 100,000 psi (6666 bars); a stationary, negatively charged, tungsten anode 235 that protrudes outside the hemispherical head 233 for connection via cable 299 to the negative polarity of a steady or pulsing AC-DC converter with at least 50 Kw power (not shown in the figure), said protrusion occurring through insulating pressure resistant bushing 236 in phenolic G10 or equivalent; an internally movable, positively charged tungsten cathode 237 connected via cable 300 and insulating bushing 301 to the positive polarity of said outside power source; said cathode 237 being connected via insulating phenolic G10 block 238 to a metal rod equipped with rake 239 that is internally fastened to vessel 232 via brackets 240; said rake 239 being operated by a pignon 240 that is controlled by an outside servomotor 242 through insulating pressure resistant bushing 302; vessel 232 being filled up with a gaseous feedstock 251 that is recirculated through the electric arc 250 via blower 252 through pipe 253; the gaseous feedstock is then sucked by pipe 244 for passage through heat exchanger 245 for continuous recirculation through the arc 250 via blower 252 and pipe 253; the heat acquired by heat exchanger 245 being utilizes via an external fluid via inlet 246 and outlet 247; the proposed hadronic recycler being completed by pipe 248 for burst of pressure of the gaseous feedstock inside vessel 232 to realize the hadronic trigger, said burst of pressure being realized by outlet 260 and impact blower 261, the two check

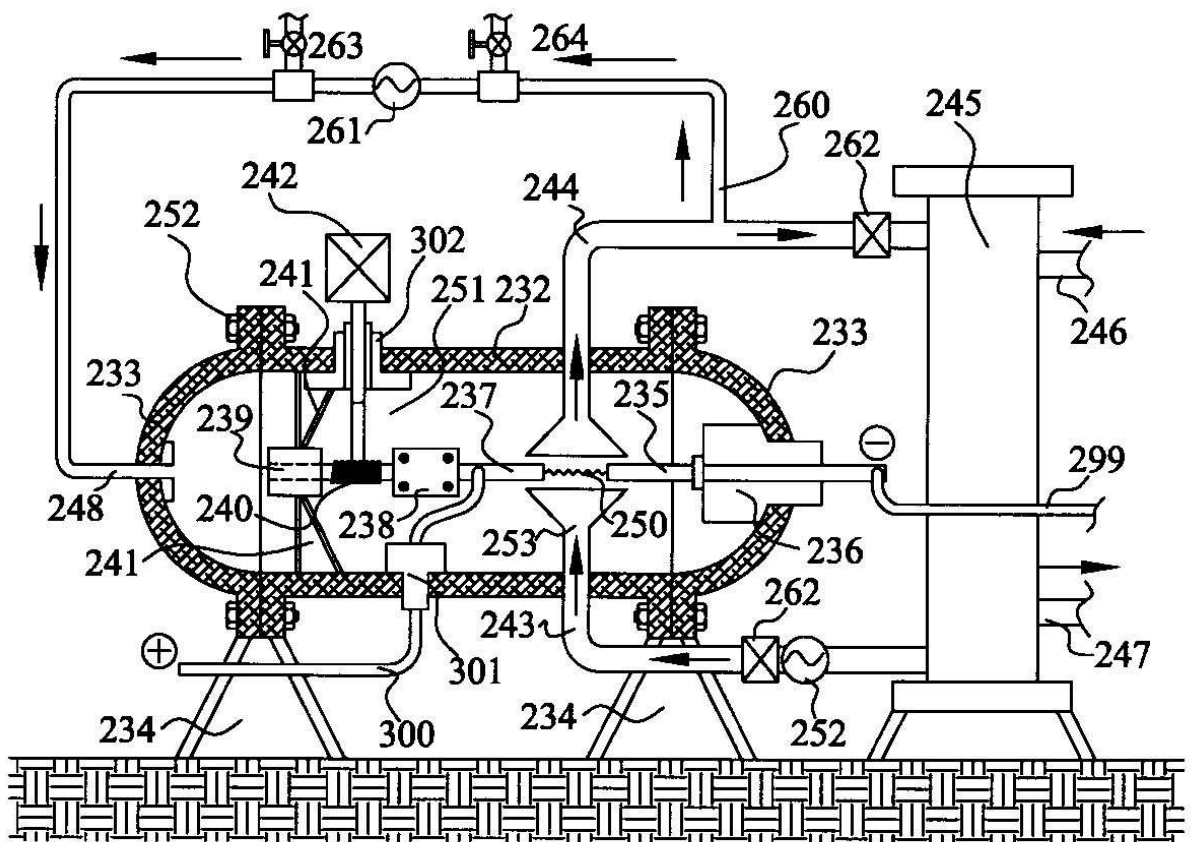

Figure 5: A schematic view of the preferred embodiment for the industrial realization of the proposed controlled intermediate fusion.

valves 262 protecting the primary blower 252 and the heat exchanger 245.

The operation of the proposed hadronic reactor is the following. Firstly, a high vacuum inside vessel 232 is secured via valve 263. Subsequently, valve 263 is closed and the vessel is filled up with the gaseous feedstock 251 via valve 264 up to the preset pressure of at least 10,000 psi (666 bars). At the achievement of the preset pressure, the automatic controls activate the primary blower 252 and the continuous recirculation of the gaseous feedstock through the arc is established. DC power is then automatically released to the anode-cathode pair when the electrodes are at such a distance not to allow an arc for the pre-selected gaseous feedstock and for the pre-selected pressure (open arc). Via the use of servomotor 242 acting on pignon 240 that, in turn activates rake 239 solidly connected to cathode 237 via insulating bushing 238, the automatic control move said cathode 237 toward the stationary anode 235 until such a distance at which an electric arc of high current (e.g., 1,000 A) within said gaseous feedstock is activated. This first phase serves to create magnecules. The automatic controls then increase the gap between the electrodes to such a value for which the variation of the voltage is within preset values (one of the twenty adjustable parameters of the automatic controls of the Magnegas Technology [9d]), so as to maximize the travel of the arc within the gaseous feedstock for an electric arc with present stability. Following a preset duration of such high current arc, the automatic control active the high voltage impulse current as a partial realization of the trigger. According to a pre-set frequency, the automatic control also activate the impulse blower 261 to create burst of very high pressure inside vessel 232.a the trigger via a combination of the following three means: 1) Impulse high voltage arcs; 2) Impulse high pressures; and 3) the enhancement of both preceding contributions by the arc geometry (Figure 4). It would be naive to assume that the above description is exhaustive, since numerous other features are needed to render the above hadronic reactor industrially viable, but they are omitted here for security reasons.

The desired Intermediate Energy Controlled Nuclear Fusions are of the generic type

$$TR + N_1(A_1, Z_1, J_1^{p_1}) + N_2(A_2, Z_2, J_2^{p_2}) \rightarrow N_3(A_3, Z_3, J_3^{p_3}) + Heat, \quad (5.1)$$

where: TR is the trigger;  $A$  is the number of nucleons;  $Z$  is the number of protons;  $J$  is the angular momentum;  $p$  is the parity;  $A_1 + A_2 = A_3$ ,  $Z_1 + Z_2 = Z_3$ ,  $J_1 + J_2 = J_3$ ,  $p_1 = p_2 = p_3$ ; and, by central assumption, *the original and final nuclei are light, natural, and stable isotope.*

To illustrate how restrictive Laws I-VII are, it is important to show that *the use of the deuteron gas for the synthesis of the helium is not recommendable for the proposed hadronic reactor.* In fact, Eq. (5.1) becomes in this case

$$TR + H(2, 1, 1^+) + H(2, 1, 1^+) \not\rightarrow He(4, 2, 0^+) + heat, \quad (5.2)$$

that violates Law III on compatible spin coupling, as well as Law II on angular momentum conservation.

A possible hadronic reactor for the synthesis of the helium verifying Laws II and III according to the synthesis

$$TR + H(2, 1, 1^+) + H(2, 1, -1^+) \rightarrow He(4, 2, 0^+) + heat, \quad (5.3)$$

would be dramatically different than that herein considered, and has been suggested elsewhere [3k,3l]. Therefore, the synthesis of the helium is ignored hereon.

A more promising "intermediate fusion" is that of synthesizing a stable isotope of the Lithium from a 50-50 mixture of deuteron and helium according to the following realization of Eq. (5.1)

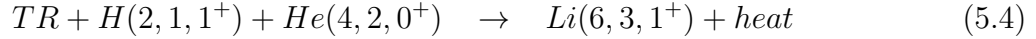

that verifies all seven laws of CNF.

A preferred use of the proposed hadronic reactor is that for the synthesis of nitrogen from carbon and deuteron indicated earlier according to the fusion process

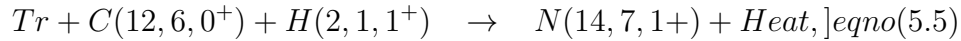

that verifies all seven laws of controlled nuclear fusions. The above fusion can be tested by using tungsten electrodes and filling up the hadronic reactor with a 50-50 mixture of carbon dioxide and deuteron gas. In this case, the electric arc decomposes  $CO_2$  into carbon and oxygen, thus rendering the carbon available for fusion (5.5). The resulting oxygen is also expected to have "intermediate fusions" via the reaction

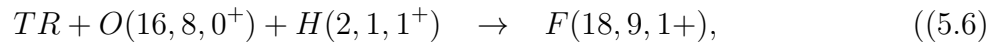

that also verifies all CNF laws, with the exception that  $F(18, 9, 1+)$  is not a stable isotope. Nevertheless, it decays in about 109 minutes into the oxygen via an electron capture or a beta plus decay, thus being acceptable on environmental grounds (since the beta are easily trapped by the heavy steel of the reactor vessel). Another alternative is the use of carbon electrodes and then filling up the hadronic reactor with only deuteron gas. In this case the electrodes will consume since they provide the carbon needed for synthesis (5.5), although their cost is minimal and fast means of their replacement are possible for minimal service [9d], to as to maintain industrial maturity.

Numerous other gaseous feedstock are possible for the proposed hadronic reactor. Their systematic study is left to interested readers for brevity.

The expected energy output of the nitrogen synthesis is significant. In fact, we have the energy release per synthesis

$$\Delta E = [C(12, 6, 0^+) + H(2, 1, 1^+)] - N(14, 7, 1+) = 14.850MeV/c^2. \quad (5.7)$$

By remember that  $1MeV = 1.6021 \times 10^{-13}$  joule and that in one mole we have  $6.022 \times 10^{23}$  atoms (Avogadro number), the extremely low efficiency of one over  $10^7$  atoms per mole per minute of said 50-50 mixture of carbon dioxide and deuteron gas, would yield the energy release

$$(14.8 \times 10^6 \times 1.6 \times 10^{-19} \text{ Joule}) \times (6 \times 10^{23}) \times (10^{-7} \text{ reaction/min per mole}) = 1.4 \times 10^6 \text{ joule/min}, \quad (5.8)$$

namely, an energy outputm if confirmed, would have full industrial significance since the energy input ( $50Kw$ ) is essentially ignorable with respect to the above energy output on a per minute basis.

To understand the engineering optimization of the proposed hadronic reactor it is important to indicate other possibilities verifying all seven CNF laws, but they are not recommended because of industrial insufficiencies. Suppose that the reactor is filled up with hydrogen, and that the electrodes are made up of Palladium 106 or 108. In this case we expect the following fusions *at the palladium cathode*

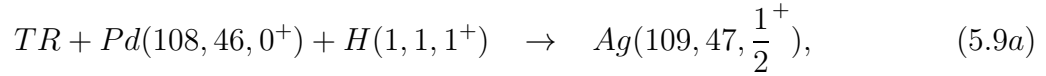
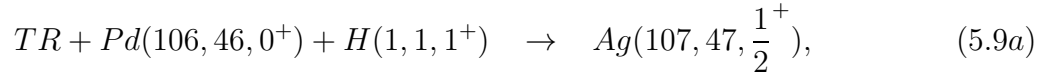

which fusions do verify all CNF laws. Nevertheless, the preceding fusions would imply the rapid disintegration of the electrodes, with consequential lack of industrial relevance. This illustrates the need for an embodiment to have a sufficiently long life prior to service as a necessary condition for industrial maturity.

A few comments are now in order. Firstly, *we stress the impossibility for the proposed hadronic reactor to produce energy of explosive character*, because synthesis (5.5) occur along the arc, thus displacing the gaseous feedstock away from the arc at their occurrence, with consequential halting of all effects. This is the very reason why the patented PlasmaArcFlow Technology is mandatory to reach industrially meaningful results.

Secondly, note the *the impossibility for fusion (5.5) to produce any harmful radiation*, evidently because either the nitrogen is synthesized or not, while the emission of neutrons is impossible because the available energies are dramatically insufficient for the fission of any available nucleus, while possible proton and electron radiations are easily trapped by the heavy metal vessel due to their charges.

Thirdly, one should note that the energy output is easily controllable in the proposed hadronic reactor in a variety of way, including the control via the values and impulse frequency of pressure and DC power as well as the control of the PlasmaArcFlow.

Despite these intrinsic safety features, all energy productions imply risks, and this is the case also for the proposed hadronic reactor. In fact, the latter can only operate at high pressures, thus requiring safety precautions for any operation, essentially given by operation under ground with heavy steel reinforced cement protections due to known risks connected to high pressure, and the sole possible operation via completely automatic remote controls. This illustrates the need of the proposal to use the already developed automatic and remote controls of the Magnegas Technology.

We should also indicated that the proposed hadronic reactor is based on preliminary experimental evidence of the MagneGas Reactors of Ref. [9d] in regard to the production of anomalous heat (that is, heat that cannot be entirely accounted with conventional thermochemical reactions), as well as anomalous content of nitrogen in Magnegas. Nevertheless, these indications should be taken with care due to the need of systematic measurements for their independent verification not conducted until now.

We would like also to confirm that hadronic mechanics, hadronic chemistry and isorelativity do indeed predict that, under the above realization and optimization of all seven CNF laws via the proposed hadronic reactor, the synthesis of the nitrogen from carbon and

deuteron is inevitable following the triggering through the hadronic horizon. However, we should also indicate that the excessive number of unknowns due to the novelty of the research prohibit the prediction of specific numerical values. Their numerical values of pressures, DC power and PlasmaArcFlow have been suggested above on semi-empirical grounds based on their maximal possible engineering realization. Therefore, no claim of actual existence of the proposed "intermediate fusion" of nitrogen from carbon and deuteron can be voiced prior to the actual construction and successful test of the proposed hadronic reactor.

In closing, it is appropriate to recall that both the "cold" and the "hot" fusions have produced no industrially value result to date following large investments over a protracted period of time. While research along these lines should evidently continue, pressing societal needs caused by ever increasing cataclysmic climactic events requires serious research and investments on *new* alternative, of which the "intermediate fusion" proposed in this paper is merely one among other possibilities. In the final analysis, readers should remember that the well being of their children is at stake.

### Legal Note.

The hadronic reactor proposed in this paper is protected by U.S. Patent numbers 6,926,872; 6,673,322; 6,663,752; 6,540,966; and 6,183,604; issued to R. M. Santilli and assigned to private corporations plus a number of additional international patents are pending. This is to acknowledge that, according to international patent laws, any researcher is completely free to conduct any and all desired *research* on the proposed hadronic reactor without any need for prior authorization from the patent holder, under the condition that this paper and the quoted patents are listed in any possible publication. Prior authorization by the owners of the intellectual rights is requested by law only in the event of sales or other uses of the patented technology implying an *income*.

## References

- [1] M. Fleishmann, S. Pons and M. Hawkins, *Electroanalytic chem.* **261**, 301 (1989)[1a]. 1. <http://www.picosearch.com/cgi-bin/ts0.pl?index=102342> [1b]. <http://prola.aps.org/search> [1c]. <http://www.infinite-energy.com/resources/techrefa-g.html#top> [1d].
- [2] A. Einstein, B. Podolsky, and N. Rosen, *Phys. Rev.* **47**, 777 (1935) [2a]. E. Fermi, *Nuclear Physics*, University of Chicago Press (1948) [2b]. D.Bohm, *Quantum Theory* (Dover Publications, New York, 1979) [2c]. J. S. Bell, *Physica* **1**, 195 (1965) [11d].
- [3] R. M. Santilli, *Foundations of Theoretical Mechanics*, Vol. I (1978) [3a] and Vol. II (1982) [3b] Springer-Verlag, Heidelberg-New York; *Lie-admissible Approach to the Hadronic Structure*, Vol.I (1978) [3c] and Vol. II (1981) [3d], Hadronic Press, Palm Harbor, Florida; *Isotopic Generalizations of Galilei and Einstein Relativities*, Vol. I (1991) [3e] and Vol. II (1991) [3f], Hadronic Press, Palm Harbor, Florida; *Elements of Hadronic Mechanics*, Vol. (1995) [3g], Vol. II (1995) [3h and Vol. III

- (in press) [3i], Ukrainian Academy of Sciences, Kiev; *Isotopic, Genotopic and Hyperstructural Methods in Theoretical Biology*, Ukrainian Academy of Sciences, Kiev (1996) [3j]; *The Physics of New Clean Energies and Fuels According to Hadronic Mechanics*, Special issue of the Journal of New Energy, 318 pages (1998) [3k]; *Foundations of Hadronic Chemistry with Applications to New Clean Energies and Fuels*, Kluwer Academic Publishers, Boston-Dordrecht-London (2001) [3l]; *The Structure of the Neutron as Predicted by Hadronic Mechanics and the Possible Utilization of its Energy via its Stimulated Decay*, <http://www.neutronstructure.org> (1995) [3m]; *Isodual Theory of Antimatter with Applications to Antigravity, Grand Unifications and Cosmology*, Springer (in press) [3n].
- [4] H. C. Myung, *Lie Algebras and Flexible Lie-Admissible Algebras*, Hadronic Press (1982) [4a]. A.K. Aringazin, A.Jannussis, D.F.Lopez, M.Nishioka and B.Veljanosky, *Santilli's Lie-Isotopic Generalization of Galilei's Relativities*, Kostarakis Publisher, Athens, Greece (1980) [4b]. J. V. Kadeisvili, *Santilli's Isotopies of Contemporary Algebras, Geometries and Relativities*, Second Edition, Ukraine Academy of Sciences, Kiev (1997) [4c]. D. S. Sourlas and G. T. Tsagas, *Mathematical Foundations of the Lie-Santilli Theory*, Ukraine Academy of Sciences, Kiev (1993) [4d]. J. Lohmus, E. Paal and L. Sorgsepp, *Nonassociative Algebras in Physics*, Hadronic Press, Palm Harbor, FL, (1994) [4e]. R. M. Falcon Ganforina and J. Nunez Valdes, *Fondamentos de la Isoteoria de Lie-Santilli*, (in Spanish) International Academic Press, America-Europe-Asia, (2001), also available in the pdf file <http://www.i-b-r.org/docs/spanish.pdf> [4f]. Chun-Xuan Jiang, *Foundations of Santilli's Isonumber Theory*, International Academic Press, America-Europe-Asia (2002), also available in the pdf file <http://www.i-b-r.org/docs/jiang.pdf> [4g].
- [5] R. M. Santilli, Hadronic J. **1**, 224, 574, and 1267 (1978) [5a]; Phys. Rev. D **20**, 555 (1979) [5b]; Algebras, Groups and Geometries **10**, 273 (1993) [5c]; Rendiconti Circolo Matematico di Palermo, Supplemento **42**, 7 (1996) [5d]; Intern. J. Modern Phys. D **7**, 351 (1998) [5e]; Found. Phys. **27**, 625 (1997) [5f]; Found. Phys. **27**, 1159 (1997) [5g]; Advances in Algebras, **21**, 121 (2003) [5h]; Journal of Dynamical Systems and Geometric Theories, **1**, 121 (2003) [5i]. Intern. J. Modern Phys. A **14**, 3157 (1999) [5j].
- [6] R. M. Santilli, Hadronic Journal **3**, 440 (1979) [6a]. R. M. Santilli and H. C. Myung, Hadronic Journal **5**, 1367-1404 (1982) [6b]. R. Mignani, Hadronic Journal **5**, 1120 (1982) [6c].
- [7] R.M.Santilli, Nuovo Cimento Lett. **37**, 545 (1983) [7a]; Lett. Nuovo Cimento **38**, 509, (1983) [7b]; Hadronic J. **8**, 25 and 36 (1985) [7c]; JINR Rapid Comm. **6**, 24 (1993) [7d]; J. Moscow Phys. Soc. **3**, 255 (1993) [7e]; JINR Comm. No. E4-93-352 (1993) [7f]; Chinese J. Syst. Eng. and Electr. & Electr. **6**, 177 (1996) [7g]; Acta Applicandae Math. **50**, 177 (1998) [7h]. Intern. J. Modern Phys. A **14**, 2205 (1999) [7i].

- [8] R. M. Santilli, *Found. Phys. Letters* **10**, 305 (1997) [8a]; contributed paper in the *Proceedings of the Eight Marcel Grossmann Meeting in Gravitation*, T. Piran, and R. Ruffini, Editors, World Scientific, pages 473-475 (1999) [8b]; *Annales Fondation L. de Broglie*, **29**, 953 (2004) [8c].
- [9] R. M. Santilli, and D. D. Shillady, *Intern. J. Hydrogen Energy* **24**, 943 (1999) [9a]. R. M. Santilli and D. D. Shillady, *Intern. J. Hydrogen Energy* **25**, 173 (2000) [9b]. R. M. Santilli, *Hadronic J.* **21**, 789 (1998) [9c]. R. M. Santilli, <http://www.magnegas.com> [9d]. M. G. Kucherenko and A. K. Aringazin, *Hadronic J.* **21**, 895 (1998) [9e]. A. K. Aringazin, *Hadronic J.* **24**, 395 (2001) [9f]. H. Ruder, G. Wunner, H. Herold, F. Geyer, *Atoms in Strong Magnetic Fields*, Springer, Berlin-Heidelberg-New York, (1994) [9g]. R. M. Santilli, *Intern. J. Hydrogen Energy* **28**, 177 (2003) [9h]. R. M. Santilli, "A new gaseous and combustible form of water," *Intern. J. Hydrogen Energy*, in press (2005) [9i].