

EXPERIMENTAL STUDY OF THE LASER DIODE PUMPED RUBIDIUM MASER *

Alain Michaud, Pierre Tremblay
and Michel Têtu

*Centre d'optique, photonique et laser (COPL),
Dép. de génie électrique, Université Laval,
Québec (Québec) G1K 7P4, Canada*

Abstract

We report the operation of a ^{87}Rb maser in the self-oscillating mode, using a laser diode as the optical pumping source. The maser uses a TE_{021} cavity surrounding a cell containing the atoms and 11 Torr of N_2 as the buffer gas. The optical pumping is accomplished by using a commercial laser diode frequency-locked on the linear absorption line of an external rubidium cell. The maser output power

**IEEE Trans. Instrum. Meas.*, vol. 40, no 2, pp. 170-3, April 1991.

This work has been presented at the CPEM'90, Ottawa, Canada, June 1990,
DOI:10.1109/CPEM.1990.109969, .

is maximized when the laser spectrum is spread by modulating its frequency through the variation of its injection current. The maser output power is also presented for various modulation waveforms and frequencies. We find that the spurious sidebands induced by the modulation can be minimized. Finally, the linear dependence between the laser and maser frequencies is shown. We find that the relative maser frequency pulling from the laser is about 4.6×10^{-3} .

I. Introduction

The availability of high quality, low cost laser diodes, brings many opportunities in metrology. This is especially true in optical pumping experiments where their tunability permits the replacement of the traditional spectral lamp or the cumbersome dye laser. Recently, many papers reported their use for the optical pumping of various alkalis such as cesium [1], [2]. We used a similar technique to optically pump a rubidium maser, replacing the usual lamp-isotopic filter configuration by a laser diode. Two reasons motivate this study. The conventional active frequency standard showed a frequency stability of about 5×10^{-14} for averaging times of the order of 100 s, but starts to deteriorate for longer times [3]. The light fluctuations were supposed to be a major cause for the long-term instabilities. Optical pumping from the laser brings the possibility of a better control of these fluctuations. Also proper operation of the maser involves three temperatures for the cavity, the filter and the lamp. The gradients of temperature present, and the volume of the elements complicate the design of a compact, temperature stabilized optical pumping module.

II. Description

The maser (Fig. 1), uses a cylindrical TE₀₂₁ mode microwave cavity containing a quartz bulb in which a ⁸⁷Rb vapor is present with about 11 Torr of N₂ used as a buffer gas. The cavity is made of a quartz cylinder coated with silver and its resonance frequency is tuned to 6.83468 GHz corresponding to the transition frequency between the two $m_F = 0$ ground state hyperfine levels of the atoms. One end of the cavity is equipped with a coupling loop to bring the maser signal to the receiver, and with a piston for its fine frequency tuning. The other end has a screen made of a silver coated corrugated ribbon so the pumping light can enter into the cavity. The loaded quality factor of the cavity is around 27000.

The pumping light is derived from a commercial laser-diode selected for use at 780.027 nm, corresponding to the $5^2S_{1/2}, F=1 \longleftrightarrow 5^2P_{3/2}, F = 0, 1, 2$ transitions, the Doppler width of each transition overlapping. At this wavelength, the optical power delivered by the laser is around 18 mW.

Coarse adjustment of the wavelength is achieved by setting the case temperature of the laser with the use of a thermoelectric cooler, while fine tuning is achieved with the change of the injection current. The light is first collimated and injected into the maser cavity. The collimated beam waist dimensions are about 3×9 mm. The light enters the cavity near the side wall and then shines in all directions and polarizations. It was not possible with this setup to evaluate the light intensity distribution, but this arrangement produced the best output power. Also, no optical isolator was needed in order to avoid feedback light which could result in laser mode hoppings.

A portion of the laser beam is sent through an external cell containing also

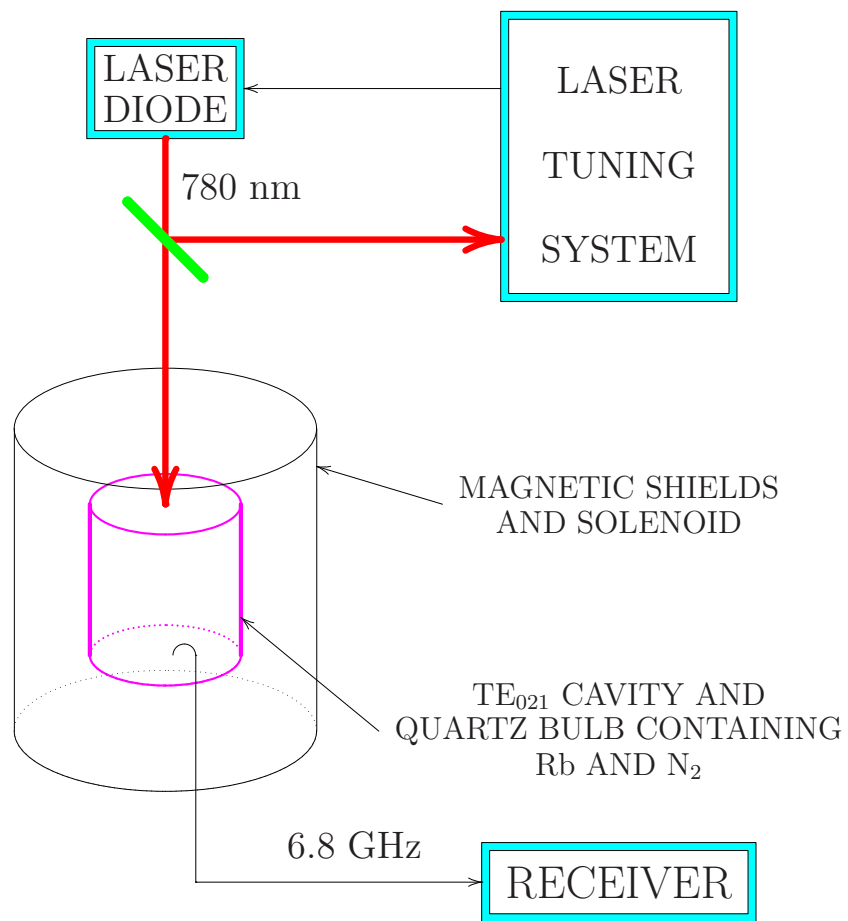

Figure 1: Schematic of the laser diode pumped Rb maser.

a Rb vapor in order to lock the nominal laser frequency on the absorption resonance. Fig. 2 shows the arrangement for the laser frequency-locking system. An additional photodetector and an analog voltage divider were used to compensate for the change in the output power of the laser when the injection current is varied. The signal from the divider is then phase compared with the modulation signal. The resulting error signal is then proportional to the frequency difference between the laser and the absorption resonance.

Three deterministic types of modulation signal were used: sine, triangle and square waves. Fig. 3 shows the error signal observed when the laser is scanned across the resonance line, for typical operating conditions and for the different modulation waveforms. The scale reference for the frequency axis is determined by measuring the injection current required to reach the center of each of the two absorption lines of the external cell which corresponds to a 6.521 GHz frequency offset [4]. All the curves are adjusted for the coincidence of the zero of the error signal. The same setting, frequency scale and operating conditions are used in Figs. 3, 4, 5 and 9.

The discriminator gain and the locking range are about the same for both sine and triangle wave modulation. They are somewhat restrained for square wave, due to the large modulation excursion. This should be taken into account if this type of modulation is to be used.

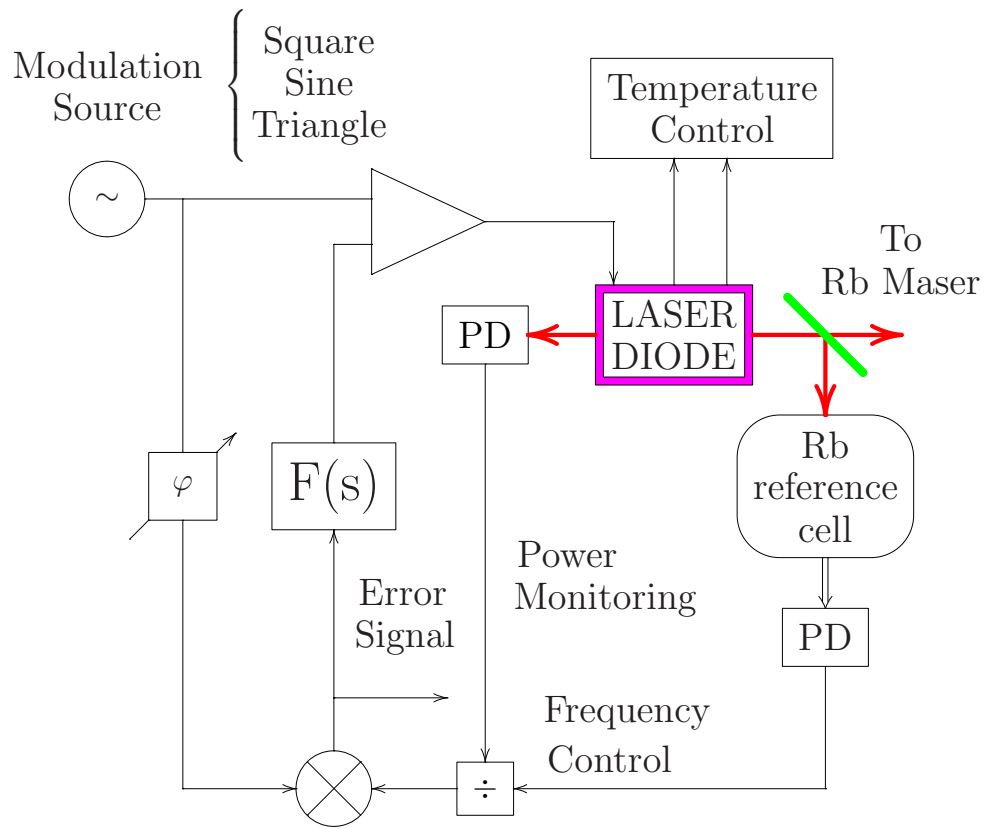

Figure 2: Schematic of the laser locking system.

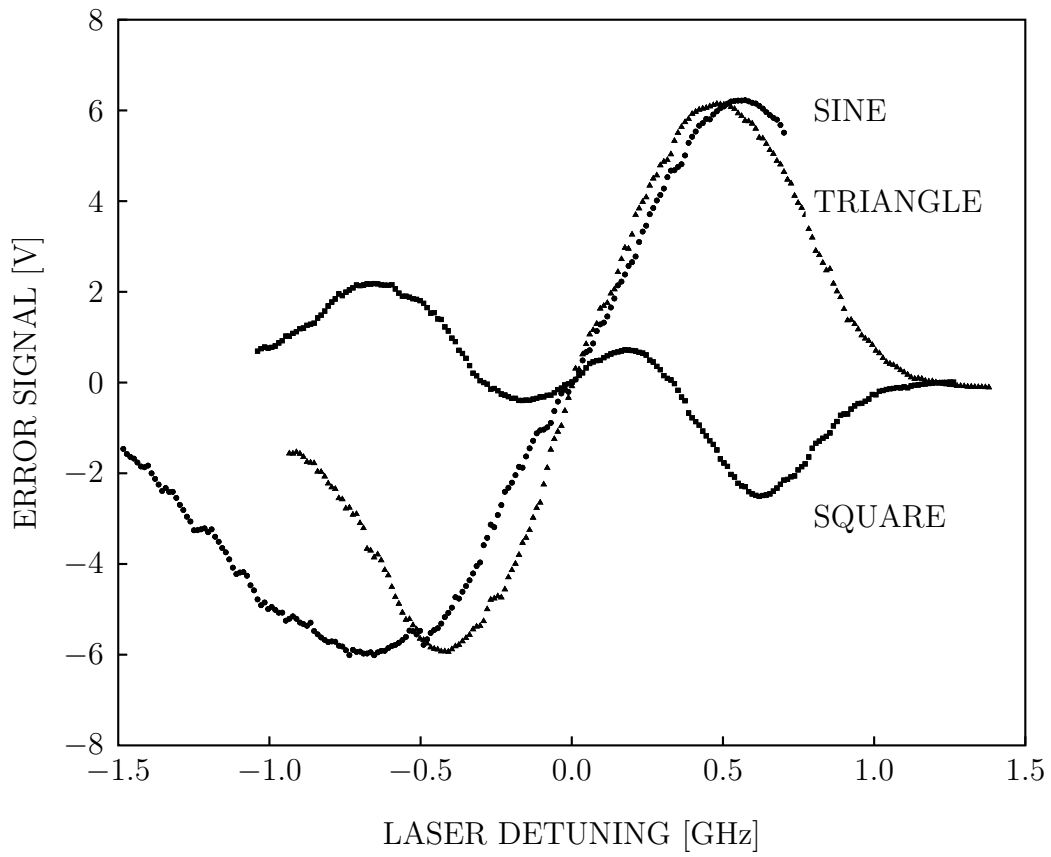

Figure 3: Error signal as a function of the average laser detuning for different modulation waveforms.

III. Output Power

When the laser is unmodulated, its linewidth of about 25 MHz is too narrow to pump a sufficiently large number of atoms and to maintain the maser oscillation. Therefore it is necessary to modulate the laser frequency. This modulation results in a broadening of the laser spectrum, thus allowing optical pumping of all classes of atomic velocities. The benefits of this broadening are limited by available laser power and undesired pumping from the $5S_{1/2}$, $F=2$ level, thus resulting in a decrease in the maser power.

Fig. 4 shows the output power of the maser as a function of the average laser frequency detuning for the various modulation waveforms. The amplitude of the modulation was adjusted for the maximum maser power for each modulation waveform. We also used a 50 kHz bandwidth, Gaussian filtered white noise as a modulation source. The zero of the horizontal axis is arbitrary for this type of modulation since the locking system is useless in the absence of a periodic waveform. All the curves are shown for the same optical power (18 mW) and modulation frequency (5 kHz). We observe that the power is maximum when the modulating waveform is square. On the opposite, the Gaussian noise is the less efficient source of modulation. We also note an asymmetry of the curves. This is due to the presence of the neighboring $5S_{1/2}$, $F=2 \iff 5P_{3/2}$, $F=1,2,3$ transitions.

The laser spectrum for low modulation frequency can be expressed as the convolution of the unmodulated laser spectrum itself and the probability density function of the modulating signal. For example, since a randomly starting triangle wave has a uniform probability density function, the central part of the modulated laser spectrum will also be uniform. Fig. 5 shows the

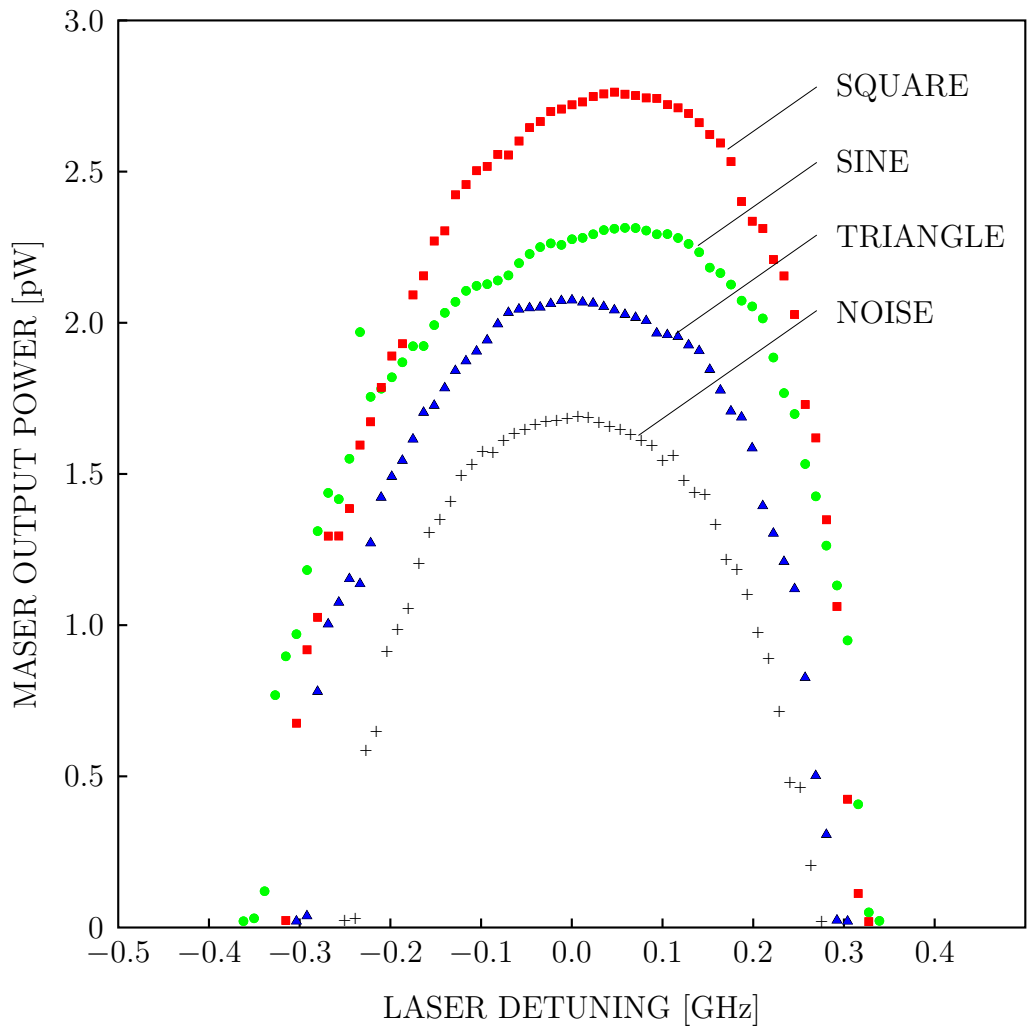

Figure 4: Output power of the maser as a function of the average laser detuning for different modulation waveforms.

estimated spectrum of the laser for the four modulation waveforms used in the experiments. The modulation amplitudes are respectively 1.08, 1.40, 1.75 GHz peak for square, sine and triangle and 1.3 GHz RMS for the gaussian noise. It also shows the unmodulated laser spectrum and absorption curve of the vapor, which is a Voigt profile.

This figure, along with Fig. 4 shows that the best maser output power is obtained by an optimum distribution of the light intensity over the absorption profile of the atomic vapour. Hence a narrow linewidth laser would cause excessive relaxation for the microwave coherence, thus killing the maser action.

The maser output power also varies drastically with the modulation frequency. Fig. 6 shows the output power as a function of the modulation frequency. We see that the power suddenly drops when the frequency is below a certain threshold. In fact, when the modulation period comes close to the relaxation times, the changes in laser frequency are not fast enough to pump all class of atoms simultaneously and the gain drops. This means that the pumping of the atoms is not only due to the power spectrum of the pumping light, but also to the speed of its variation.

Fig. 7 shows the power of the maser when its temperature and the light intensity are changed for square wave modulation. We observe the same type of dependence as the conventional maser. These curves show a maximum output power for a certain light intensity. This maximum increases as the number of atoms increases. Although this phenomenon will eventually be limited by relaxation of the atoms, the behavior of the curves shows us that the output power of the maser is actually limited by the available laser power.

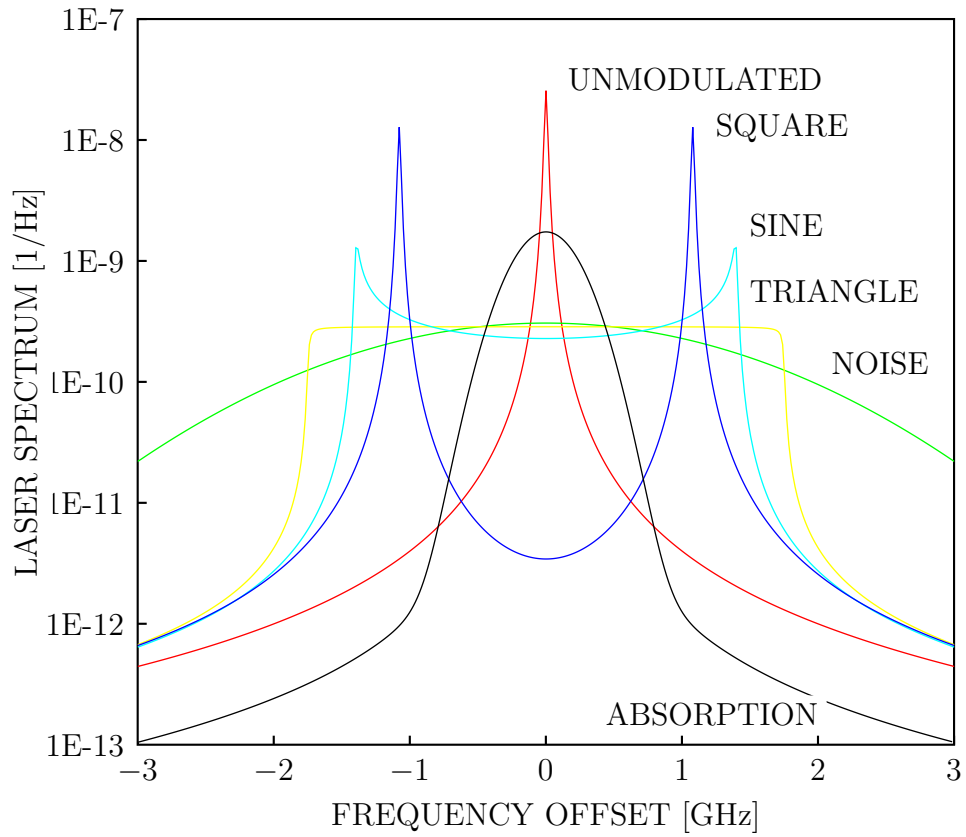

Figure 5: Estimated light spectrum of the modulated laser for three deterministic modulation waveform, random noise modulation and the absorption spectrum of the atoms (black line).

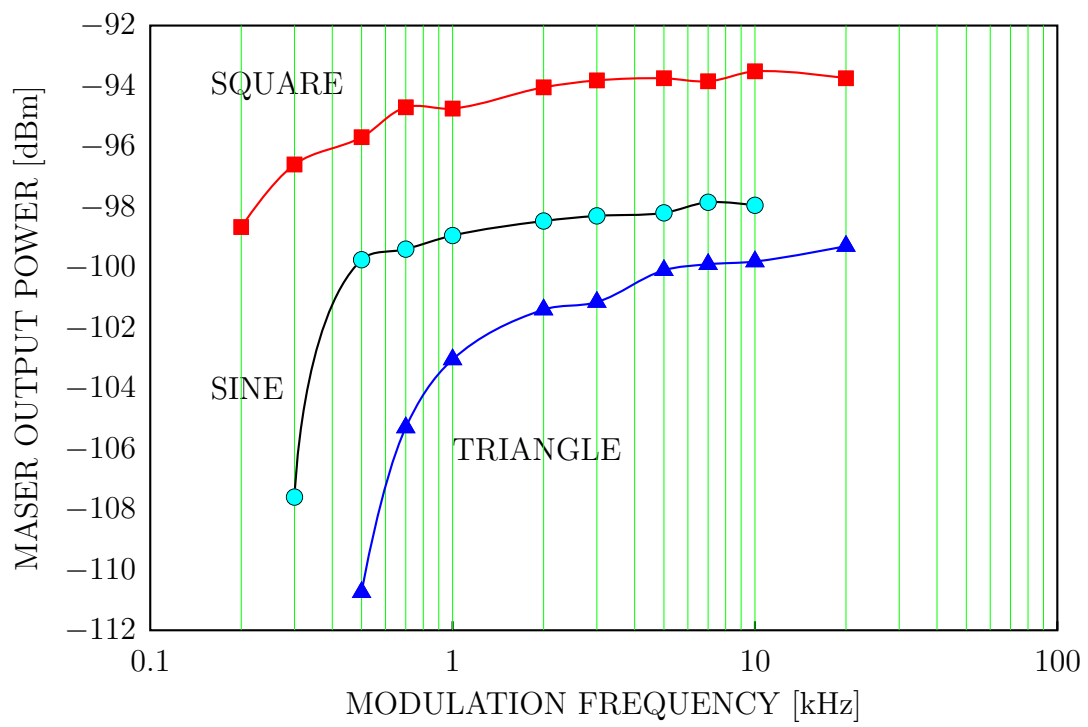

Figure 6: Maser output power as a function of the laser modulation frequency.

Other waveforms showed a similar behavior although the maser was less powerful.

IV. Maser Frequency

Modulating the laser frequency also results in a frequency modulation of the maser signal. Fig. 8 gives the relative level of the modulation sidebands when the modulation frequency is changed. We see that they decrease as the frequency modulation is increased at a rate of about 20 dB per decade. Their effect can be minimized by a proper choice of the modulation frequency. As an example for a modulation frequency of 20 kHz the curve shows sidebands levels of about -50 dBc. This level could deteriorate the short term stability to a level of about $3 \times 10^{-13} \tau^{-1}$ [5], which is the same as the stability of the maser itself. Moreover, the maser signal is used to phase-lock a quartz oscillator through a coherent receiver. It has been shown that the optimum bandwidth of the phase-locked loop is around 1 kHz [6], so the remaining spurious sidebands will be filtered out [7].

Fig. 9 shows the maser frequency when the laser is detuned. Again the zero offset for the noise modulation is arbitrary. We observe that the frequency dependence of the curve is about the same for all types of modulation. The measured pulling coefficient y_m/y_l is about 4.6×10^{-3} . The frequency stability of the maser has been measured with the laser unlocked, and showed a flicker floor level of about 1×10^{-11} , leading to a laser stability of 5×10^{-9} , which is typical for the setup we used [4].

This stresses out the importance of the laser frequency stabilization in

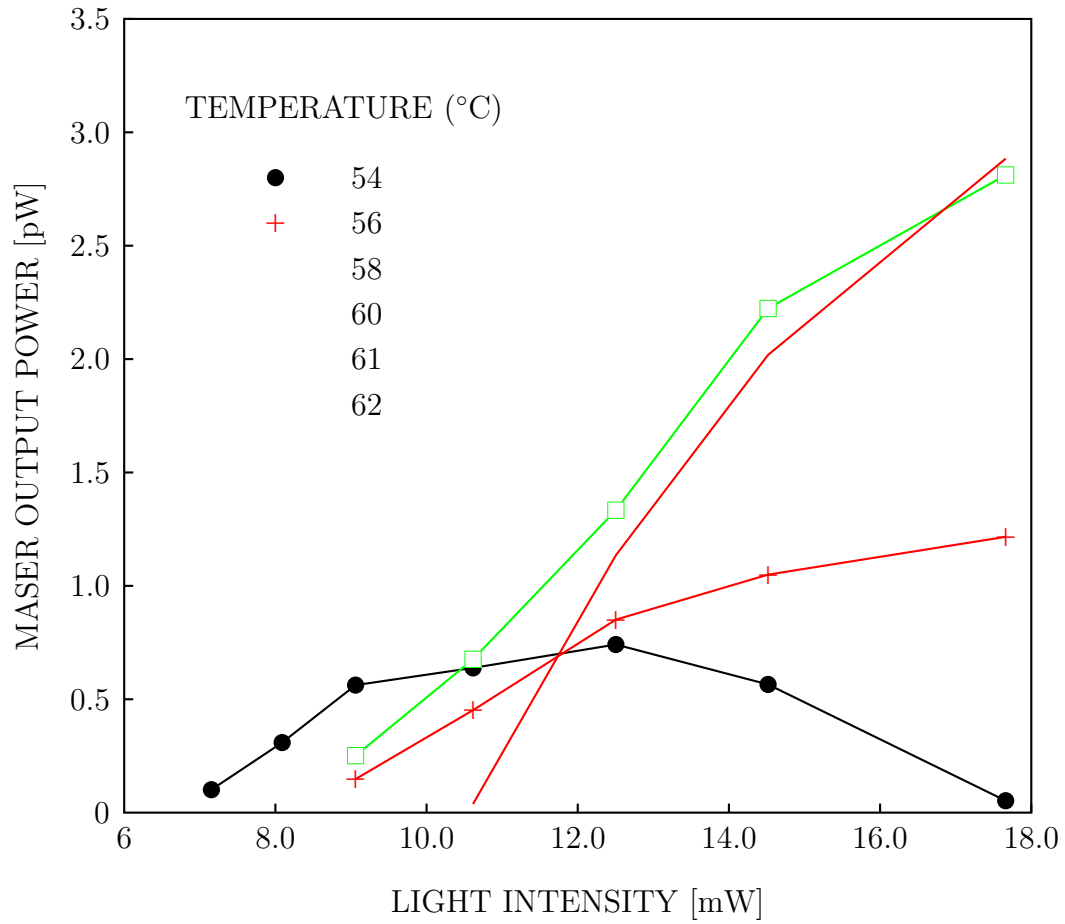

Figure 7: Maser power as a function of the light intensity for different temperatures and a square wave modulation of the laser.

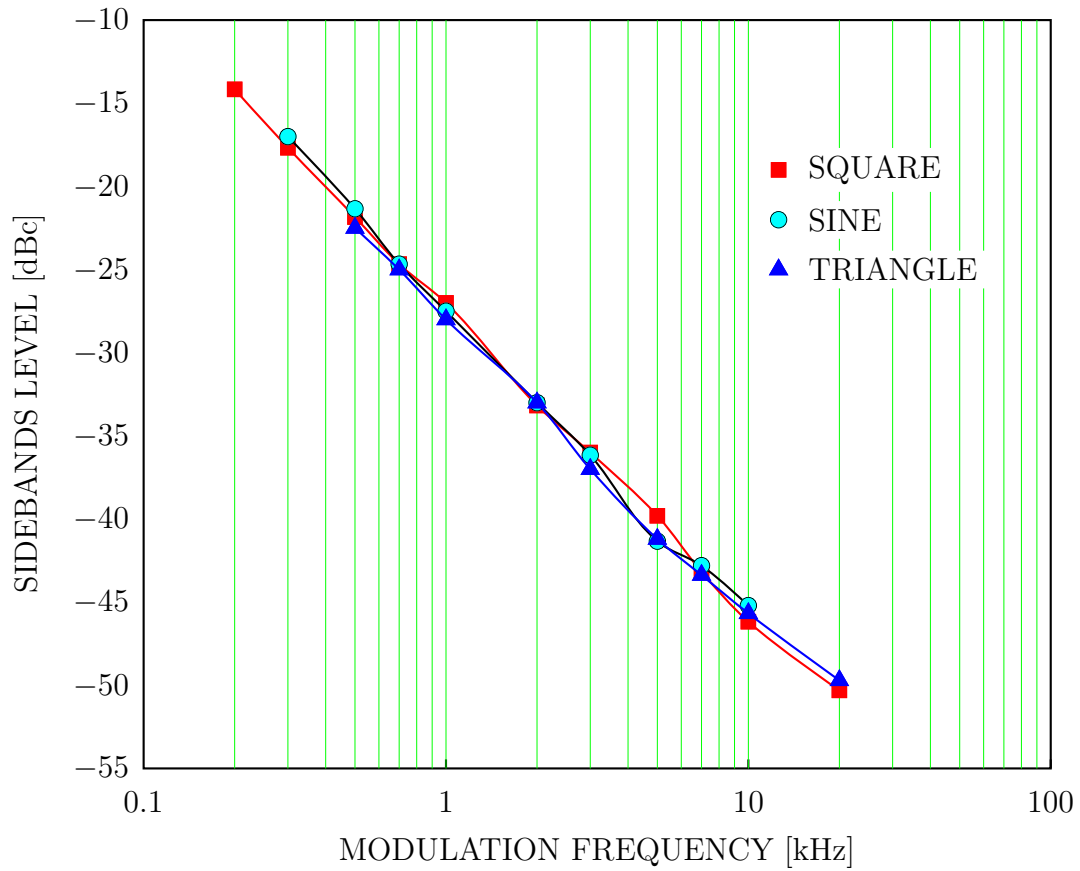

Figure 8: Sidebands level as a function of the modulation frequency for different modulation waveform.

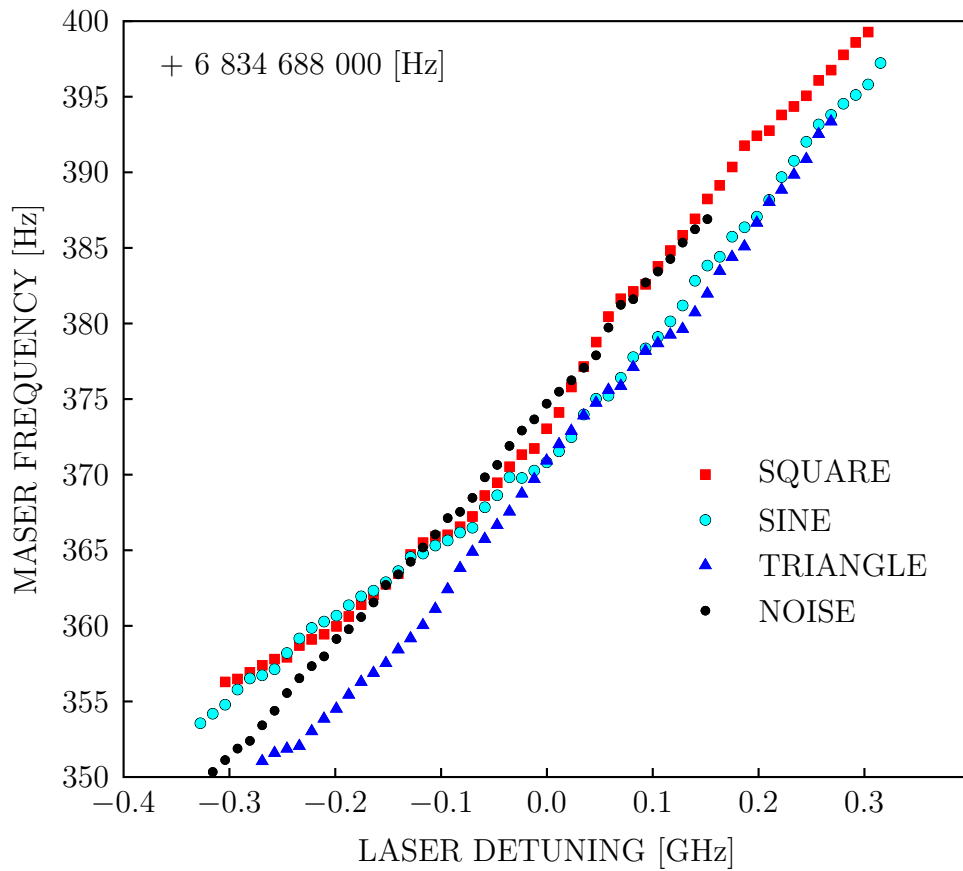

Figure 9: Maser frequency as a function of the average laser detuning.

order to achieve good performances. The frequency locking of the laser improves its stability by two orders of magnitude [4], which would bring the maser stability to about 5×10^{-13} . Recently, techniques have been reported to further increase the stability of the laser [8]. These techniques along with a cavity tuning system based on light intensity modulation could result in presently unachievable performance.

V. Conclusion

Laser diode used as a pumping source on the rubidium maser will permit the construction of a more compact frequency standard. The design of the maser involves the broadening of the laser spectrum in order to maximize the maser power. Periodic deterministic modulations are preferable to random modulations, since they produce higher maser power and permit the frequency locking technique on an external absorption cell. It has been shown that the modulation frequency has to be high enough in order to ensure high maser power and low frequency modulation spurious. Measurements have shown a relative laser frequency pulling over the relative maser frequency of about 4.6×10^{-3} .

Acknowledgements

The authors wish to thank Prof. Yang Shi-Qi on leave from South China Normal University, and S. Thériault, M. Chamberland and M. Levesque from Laval University, for their help and discussions. This research was supported

by Natural Sciences and Engineering Research Council, Canada, and Fonds F.C.A.R., Québec.

References

- [1] É. de Clerq *et al.*, “Laser diode optically pumped caesium beam,” *Journal de physique*, Vol. 45, pp. 239–247, Feb. 1984.
- [2] S.I. Ohshima *et al.* “Development of an Optically Pumped Cs Frequency Standard at the NRLM,” *IEEE Trans. on Instrumentation and Measurement*, Vol. 37, pp. 409–13, Sept. 1988.
- [3] M. Têtu *et al.*, “Experimental Results On a Frequency Standard Based on a Rubidium 87 Maser,” *Proc. 36th Annual Symposium on Frequency Control*, Philadelphia, U.S.A., pp. 64–71, May 1985.
- [4] M. Têtu *et al.*, “Multiwavelength Sources Using Laser Diodes Frequency-Locked to Atomic Resonances” *Journal of Lightwave Technology*, Vol. 7, pp. 1540-8, Oct. 1989, DOI:10.1109/50.39095. Available: .
- [5] J. Rutman, “Characterization of Phase and Frequency Instabilities in Precision Frequency Sources: Fifteen Years of Progress” *Proceedings of IEEE*, Vol. 66, pp. 1048-75, Sept. 1978, Available: .
- [6] A. Michaud, “Etude de la stabilité de la fréquence d’un étalon de fréquence basé sur un maser à rubidium 87: Influence du récepteur cohérent.”, M. Sc. Thesis, Université Laval, Québec, Canada, May 1986, Available: .

- [7] J. Vanier and M. Têtu “Phase-Locked Loops Used with Masers: Atomic Frequency Standards,” *IEEE Trans. on Communications*, Vol. 30, pp. 2355–2361, Oct. 1982, Available: .

- [8] M. de Labachellerie and P. Cerez, ‘Frequency locking of a 850 nm external-cavity semiconductor laser on a Doppler-free Cs-D2 line’, Proc. SPIE, vol. 701, ECOOSA’86, Florence 1986.