

Contributions to the theory of a two-scale homogeneous dynamo experiment

Karl-Heinz Rädler

Astrophysical Institute of Potsdam, An der Sternwarte 16, D-14482 Potsdam, Germany

Axel Brandenburg

NORDITA, Blegdamsvej 17, DK-2100 Copenhagen Ø, Denmark

(Dated: February 9, 2020, Revision: 1.34)

The principle of the Karlsruhe dynamo experiment is closely related to that of the Roberts dynamo working with a simple fluid flow which is, with respect to proper Cartesian co-ordinates x , y and z , periodic in x and y and independent of z . A modified Roberts dynamo problem is considered with a flow more similar to that in the experimental device. Solutions are calculated numerically, and on this basis an estimate of the excitation condition of the experimental dynamo is given. The modified Roberts dynamo problem is also considered in the framework of the mean-field dynamo theory, in which the crucial induction effect of the fluid motion is an anisotropic α -effect. Numerical results are given for the dependence of the mean-field coefficients on the fluid flow rates. The excitation condition of the dynamo is also discussed within this framework. The behavior of the dynamo in the nonlinear regime, i.e. with backreaction of the magnetic field on the fluid flow, depends on the effect of the Lorentz force on the flow rates. The quantities determining this effect are calculated numerically. The results for the mean-field coefficients and the quantities describing the backreaction provide corrections to earlier results, which were obtained under simplifying assumptions.

Key words: dynamo, dynamo experiment, mean-field dynamo theory, α -effect, Lorentz force

PACS numbers: 52.65.Kj, 52.75.Fk, 47.65.+a

I. INTRODUCTION

In the Forschungszentrum Karlsruhe U. Müller and R. Stieglitz have set up an experimental device for the demonstration and investigation of a homogeneous dynamo as it is expected in the Earth's interior or in cosmic bodies [1]. The experiment ran first time successfully in December 1999, and since then several series of measurements have been carried out [2, 3, 4, 5]. It is the second realization of a homogeneous dynamo in the laboratory. Its first run followed only a few weeks after that of the Riga dynamo experiment, working with a somewhat different principle, which was pushed forward by A. Gailitis, O. Lielausis and co-workers [6, 7].

The basic idea of the Karlsruhe experiment was proposed in 1975 by F. H. Busse [8, 9]. It is very similar to an idea discussed already in 1967 by A. Gailitis [10]. The essential piece of the experimental device, the dynamo module, is a cylindrical container as shown in Fig. 1, with both radius and height somewhat less than 1m, through which liquid sodium is driven by external pumps. By means of a system of channels with conducting walls, constituting 52 “spin generators”, helical motions are organized. The flow pattern resembles one of those considered in the theoretical work of G. O. Roberts in 1972 [11]. This kind of Roberts flow, which proved to be capable of dynamo action, is sketched in Fig. 2. In a proper Cartesian co-ordinate system (x, y, z) it is periodic in x and y with the same period length, which we call here $2a$, but independent of z . The x and y -components of the velocity can be described by a stream function proportional to $\sin(\pi x/a) \sin(\pi y/a)$, and the z -component is simply proportional to $\sin(\pi x/a) \sin(\pi y/a)$.

When speaking of a “cell” of the flow we mean a unit like that given by $0 \leq x, y \leq a$. Clearly the velocity is continuous everywhere, and at least the x and y -components do not vanish at the margins of the cells. The real flow in the spin generators deviates from the Roberts flow in the way indicated in Fig. 3. In each cell there are a central channel and a helical channel around it. In the simplest approximation the fluid moves rigidly in each of these channels, and it is at rest outside the channels. We relate the word “spin generator flow” in the following to this simple flow. In contrast to the Roberts flow the spin generator flow shows discontinuities and vanishes at the margins of the cells.

The theory of the dynamo effect in the Karlsruhe device has been widely elaborated. Both direct numerical solutions of the induction equation for the magnetic field [12, 13, 14, 15, 16, 17, 18] as well as mean-field theory and solutions of the corresponding equations [19, 20, 21, 22, 23, 24] have been employed. We focus our attention here on this mean-field approach. In this context mean fields are understood as averages over areas in planes perpendicular to the axis of the dynamo module covering the cross-sections of several cells. The crucial induction effect of the fluid motion is then, with respect to the mean magnetic field, described as an anisotropic α -effect. The α -coefficient and related quantities have first been calculated for the Roberts flow [19, 20, 22, 23, 25]. In the calculations with the spin generator flow carried out so far, apart from the case of small flow rates, a simplifying but not strictly justified assumption was used. The contribution of a given spin generator to the α -effect was considered independent of the neighboring spin generators and in that sense deter-

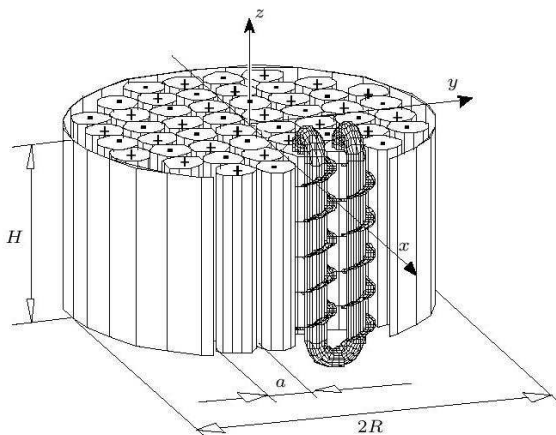

FIG. 1: The dynamo module (after [1]). The signs + and - indicate that the fluid moves in the positive or negative z -direction, respectively, in a given spin generator. $R = 0.85$ m, $H = 0.71$ m, $a = 0.21$ m.

mined under the condition that all its surroundings are conducting fluid at rest [20, 22, 23, 25]. An analogous assumption was used in calculations of the effect of the Lorentz force on the fluid flow rates in the channels of the spin generators [22, 24]. It remained to be clarified which errors result from these assumptions.

The main purpose of this paper is therefore the calculation of the α -coefficient and a related coefficient as well as the quantities determining the effect of the Lorentz force on the fluid flow rates for an array of spin generators, taking into account the so far ignored mutual influences of the spin generators. In Section II the modified Roberts dynamo problem with the spin generator flow is formulated. In Section III the numerical method used for solving this problem and the related problems occurring in the following sections are discussed. Section IV presents in particular results concerning the excitation condition for the dynamo with spin generator flow. In Section V various aspects of a mean-field theory of the dynamo experiment are explained and results for the mean electromotive force due to the spin generator flow are given. Section VI deals with the effect of the Lorentz force on the flow rates in the channels of the spin generators. Finally in Section VII some consequences of our findings for the understanding of the experimental results are summarized.

Independent of the recent comprehensive accounts of the mean-field approach to the Karlsruhe dynamo experiment [22, 23, 24], this paper may serve as an introduction to the basic idea of the experiment. However, we do not strive to repeat all important issues discussed in those papers, but we mainly want to deliver the two supplements mentioned above.

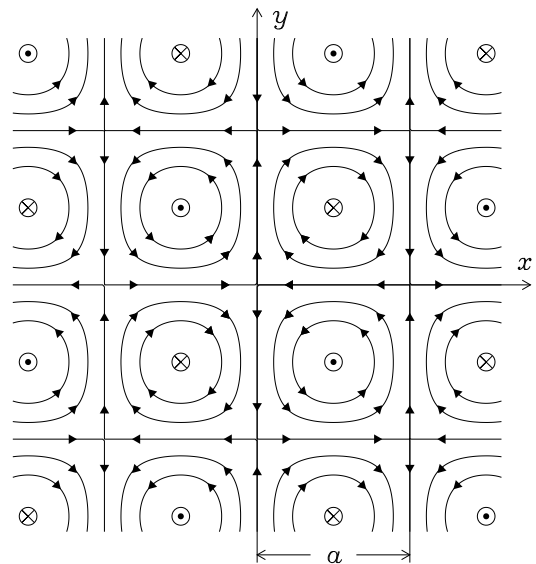

FIG. 2: The Roberts flow pattern. The flow directions correspond to the situation in the dynamo module if the coordinate system coincides with that in Fig. 1.

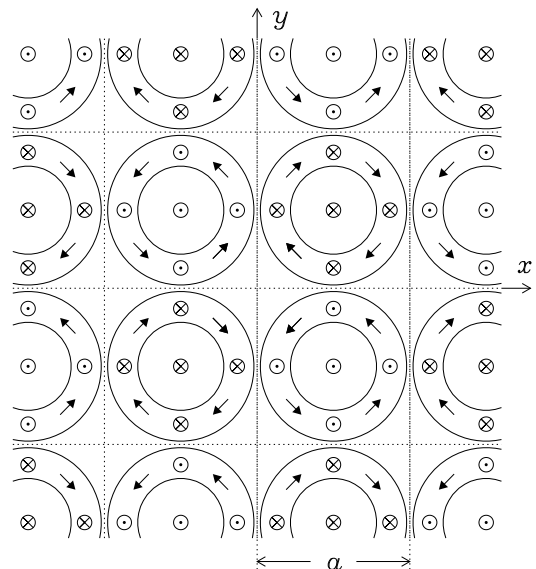

FIG. 3: The spin generator flow pattern. As for the flow directions the remark given with Fig. 2 applies. The fluid outside the cylindrical regions where flow directions are indicated is at rest. There are no walls between the cells.

II. FORMULATION OF THE DYNAMO PROBLEM

Let us first formulate the analogue of the Roberts dynamo problem for the spin generator flow. We consider a magnetic field \mathbf{B} in an infinitely extended homogeneous electrically conducting fluid, which is governed by the

induction equation,

$$\eta \nabla^2 \mathbf{B} + \nabla \times (\mathbf{u} \times \mathbf{B}) - \partial_t \mathbf{B} = \mathbf{0}, \quad \nabla \cdot \mathbf{B} = 0, \quad (1)$$

where η is the magnetic diffusivity of the fluid and \mathbf{u} its velocity. The fluid is considered incompressible, so $\nabla \cdot \mathbf{u} = 0$. Referring to the Cartesian co-ordinate system (x, y, z) mentioned above we focus our attention on the cell $0 \leq x, y \leq a$ and introduce there cylindrical co-ordinates (r, φ, z) such that the axis $r = 0$ coincides with $x = y = a/2$. We define then the fluid velocity \mathbf{u} in this cell by

$$\begin{aligned} u_r &= 0 && \text{everywhere} \\ u_\varphi &= 0, \quad u_z = -u && \text{for } 0 < r \leq r_1 \\ u_\varphi &= -\omega r, \quad u_z = -(h/2\pi)\omega && \text{for } r_1 < r \leq r_2 \\ u_\varphi &= 0, \quad u_z = 0 && \text{for } r > r_2, \end{aligned} \quad (2)$$

where u and ω are constants, r_1 and r_2 are the radius of the central channel and the outer radius of the helical channel, respectively, and h is the pitch of the helical channel. The coupling between u_φ and u_z in $r_1 < r \leq r_2$ considers the constraint on the flow resulting from the helicoidal walls of the helical channel. The velocity \mathbf{u} in all space follows from the continuation of velocity in the considered cell in the way indicated in Fig. 3, i.e. with changes of the flow directions from each cell to the adjacent ones so that the total pattern is again periodic in x and y with the period length $2a$ and independent of z .

We characterize the magnitudes of the fluid flow through the central and helical channels of a spin generator by the volumetric flow rates V_C and V_H given by

$$V_C = \pi r_1^2 u, \quad V_H = \frac{1}{2}(r_2^2 - r_1^2)h\omega. \quad (3)$$

We may measure them in units of $a\eta$, so we introduce the dimensionless flow rates \tilde{V}_C and \tilde{V}_H ,

$$\tilde{V}_C = V_C/a\eta, \quad \tilde{V}_H = V_H/a\eta. \quad (4)$$

We further define magnetic Reynolds numbers R_{mC} and R_{mH} for the two channels by $R_{mC} = ur_1/\eta$ and $R_{mH} = \omega r_2(r_2 - r_1)/\eta$. Thus we have $\tilde{V}_C = (\pi r_1/a)R_{mC}$ and $\tilde{V}_H = [(r_1 + r_2)h/2ar_2]R_{mH}$.

In view of the application of the results for the considered dynamo problem to the experimental device we mention here the numerical values for the radius R and the height H of the dynamo module, the lengths a , h , r_1 and r_2 characterizing a spin generator and the magnetic diffusivity η of the fluid: $R = 0.85$ m, $H = 0.71$ m, $a = 0.21$ m, $h = 0.19$ m, $r_1/a = 0.25$, $r_2/a = 0.5$, $\eta = 0.1$ m²/s. (More precisely, the values of R and H apply to the ‘‘homogeneous part’’ of the dynamo module, i.e. the part without connections between different spin generators. The value of η is slightly higher than that for sodium at 120°C, considering the effective reduction of the magnetic diffusivity by the steel walls of the channels.) The given data imply $a\eta = 75.6$ m³/s. Furthermore we have

$\tilde{V}_C = 0.785R_{mC}$ and $\tilde{V}_H = 1.357R_{mH}$, so \tilde{V}_C and \tilde{V}_H are in fact magnetic Reynolds numbers. Concerning deviations from the rigid-body motion of the fluid assumed here and the role of turbulence we refer to the more comprehensive representations [22, 23].

We are interested in dynamo action of the fluid motion, so we are interested in growing solutions \mathbf{B} of (1) with the velocity \mathbf{u} defined by (2) and the explanations given with them. According to some modification of Cowling’s anti-dynamo theorem growing solutions \mathbf{B} independent of z are impossible; cf. [26]. We restrict our attention to solutions of the form

$$\mathbf{B} = \text{Re}[\hat{\mathbf{B}}(x, y, t) \exp(ikz)], \quad (5)$$

where $\hat{\mathbf{B}}$ is a complex periodic vector field which has again a period length $2a$ in x and y , and k a non-vanishing real constant. In this case we may consider equations (1) in the period interval $-a \leq x, y \leq a$ only and adopt periodic boundary conditions. (Solutions \mathbf{B} with larger period lengths, as were investigated for the Roberts flow [27, 28, 29], seem to be well possible but are not considered here.)

If we put $\hat{\mathbf{B}}(x, y, t) = \hat{\mathbf{B}}(x, y) \exp(pt)$ with a parameter p , for which we have to admit complex values, equation (1) together with the boundary conditions pose an eigenvalue problem with p being the eigenvalue parameter. Clearly p depends on V_C , V_H and k . The condition $\text{Re}(p) = 0$ defines for each given k a neutral line, i.e. a line of marginal stability, in the $V_C V_H$ -diagram, which separates the region of V_C and V_H in which growing \mathbf{B} are impossible from that where they are possible.

III. THE NUMERICAL METHOD

In view of the numerical solution of the induction equation (1) we express \mathbf{B} by a vector potential \mathbf{A} ,

$$\mathbf{B} = \nabla \times \mathbf{A}. \quad (6)$$

Inserting this in (1) and choosing $\nabla \cdot \mathbf{A}$ properly we may conclude that

$$\eta \nabla^2 \mathbf{A} + \mathbf{u} \times \mathbf{B} - \partial_t \mathbf{A} = \mathbf{0}. \quad (7)$$

Analogous to (5) we put

$$\mathbf{A}(x, y, z, t) = \text{Re}[\hat{\mathbf{A}}(x, y, t) \exp(ikz)]. \quad (8)$$

Then we have

$$\hat{\mathbf{B}} = \nabla \times \hat{\mathbf{A}} + i\mathbf{k} \times \hat{\mathbf{A}}, \quad (9)$$

where $\mathbf{k} = ke$ with e being the unit vector in z -direction, and

$$\eta(\nabla^2 - k^2)\hat{\mathbf{A}} + \mathbf{u} \times \hat{\mathbf{B}} - \partial_t \hat{\mathbf{A}} = \mathbf{0}. \quad (10)$$

With a solution $\hat{\mathbf{A}}$ we can calculate $\hat{\mathbf{B}}$ according to (9) and finally \mathbf{B} according to (6).

In the sense explained above we consider (10) only in the period unit $-a \leq x, y \leq a$ and adopt periodic boundary conditions. When replacing $\hat{\mathbf{A}}(x, y, t)$ by $\hat{\mathbf{A}}(x, y) \exp(pt)$ we arrive again at an eigenvalue problem with p as eigenvalue parameter.

Let us, for example, assume that p is real and consider the steady case, $p = 0$. We may then consider, e.g., V_C as eigenvalue parameter while V_H and k are given. Modifying the equation resulting from (8) by an artificial quenching of V_C and following up the evolution of $\hat{\mathbf{A}}$, the wanted steady solutions of the original equation (10) and thus the relations between V_C and V_H for given k and $p = 0$ can be found.

For the numerical computations a grid-point scheme was used. They were carried out on a two-dimensional mesh typically with 60×60 or 120×120 points, and some of the results were checked with 240×240 points. The x and y -derivatives were calculated using sixth order explicitly finite differences, and the equations were stepped forward in time using a third order Runge-Kutta scheme.

IV. THE EXCITATION CONDITION OF THE DYNAMO

Using the described numerical method solutions \mathbf{B} of the dynamo problem posed by (1), (2) and (5) have been determined. As in the case of the Roberts flow [28, 29] the most easily excitable solutions are non-oscillatory, which corresponds to real p , and possess a contribution independent of x and y .

Fig. 4 shows the neutral lines in the $V_C V_H$ -diagram for several values of the dimensionless quantity κ defined by $\kappa = ak$. In view of the Karlsruhe experiment the case deserves special interest in which a ‘‘half wave’’ of \mathbf{B} fits just to the height H of the dynamo module, so $\kappa = \pi a/H = 0.929$. The neutral line for this case can provide us a very rough estimate of the excitation condition of the Karlsruhe dynamo. However, this estimate neither takes into account the finite radial extend of the dynamo module nor realistic conditions at its plane boundaries. Let us consider, e.g., the values of V_H necessary for self-excitation in the experimental device for given V_C . The values of V_H obtained in the experiment as well as those found by direct numerical simulations are by a factor of about 2 higher than the values concluded from the neutral curve for $\kappa = 0.9$; see e.g. Fig. 4 in Refs. [4] and [5], Fig. 2 in Ref. [17] or Fig. 3 in Ref. [18]. The tendency of the variation of V_H with V_C is however well predicted. (The influence of the finite radial extend of the dynamo module on the excitation condition will be discussed in Section V D. It makes the mentioned factor of about 2 plausible.)

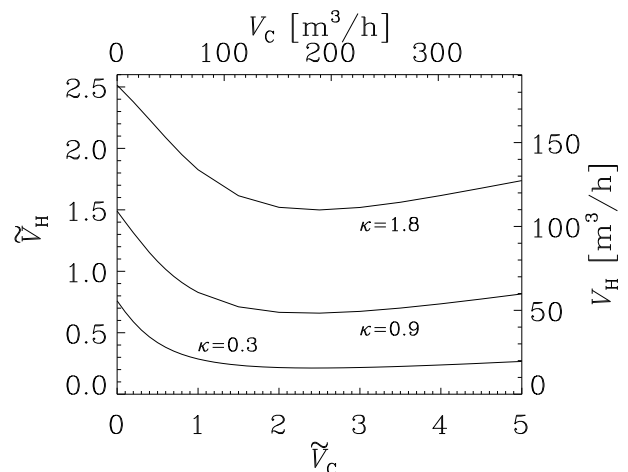

FIG. 4: Neutral lines describing steady dynamo states in the $V_C V_H$ -plane for various values of κ .

V. THE MEAN-FIELD APPROACH

The Karlsruhe dynamo experiment has been widely discussed in the framework of the mean-field dynamo theory; see e.g. [30]. Let us first discuss a few aspects of the traditional mean-field approach applied to spatially periodic flows and then a slight modification of this approach, which possesses in one respect a higher degree of generality. We always assume that the magnetic flux density \mathbf{B} is governed by the induction equation (1) and the fluid velocity \mathbf{u} is specified to be either a Roberts flow or the spin generator flow as defined above.

A. The traditional approach

For each given field F we define a mean field \overline{F} by taking an average over an area corresponding to the cross-section of four cells in the xy -plane,

$$\overline{F}(x, y, z) = \frac{1}{4a^2} \int_{-a}^a \int_{-a}^a F(x + \xi, y + \eta, z) d\xi d\eta. \quad (11)$$

We note that the applicability of the Reynolds averaging rules, which we use in the following, requires that \overline{F} varies only weakly over distances a in x or y -direction. (The following applies also with a definition of \overline{F} using averages over an area corresponding to two cells only [28], but we do not want to consider this possibility here.)

We split the magnetic flux density \mathbf{B} and the fluid velocity \mathbf{u} into mean fields $\overline{\mathbf{B}}$ and $\overline{\mathbf{u}}$ and remaining fields \mathbf{B}' and \mathbf{u}' ,

$$\mathbf{B} = \overline{\mathbf{B}} + \mathbf{B}', \quad \mathbf{u} = \overline{\mathbf{u}} + \mathbf{u}'. \quad (12)$$

Clearly we have $\overline{\mathbf{u}} = \mathbf{0}$, and therefore $\mathbf{u} = \mathbf{u}'$.

Taking the average of equations (1) we see that $\overline{\mathbf{B}}$ has to obey

$$\eta \nabla^2 \overline{\mathbf{B}} + \nabla \times \mathcal{E} - \partial_t \overline{\mathbf{B}} = \mathbf{0}, \quad \nabla \cdot \overline{\mathbf{B}} = 0, \quad (13)$$

where \mathcal{E} , defined by

$$\mathcal{E} = \overline{\mathbf{u} \times \mathbf{B}'}, \quad (14)$$

is a mean electromotive force due to the fluid motion.

The determination of \mathcal{E} for a given \mathbf{u} requires the knowledge of \mathbf{B}' . Combining equations (1) and (13) we easily arrive at

$$\begin{aligned} \eta \nabla^2 \mathbf{B}' + \nabla \times (\mathbf{u} \times \mathbf{B}')' - \partial_t \mathbf{B}' &= -\nabla \times (\mathbf{u} \times \overline{\mathbf{B}}), \\ \nabla \cdot \mathbf{B}' &= 0, \end{aligned} \quad (15)$$

where $(\mathbf{u} \times \mathbf{B}')' = \mathbf{u} \times \mathbf{B}' - \overline{\mathbf{u} \times \mathbf{B}'}$. We conclude from this that \mathbf{B}' is, apart from initial and boundary conditions, determined by \mathbf{u} and $\overline{\mathbf{B}}$ and is linear in $\overline{\mathbf{B}}$. We assume here that \mathbf{B}' vanishes if $\overline{\mathbf{B}}$ does so (and will comment on this below). Thus \mathcal{E} too can be understood as a quantity determined by \mathbf{u} and $\overline{\mathbf{B}}$ only and being linear and homogeneous in $\overline{\mathbf{B}}$. Of course, \mathcal{E} at a given point in space and time depends not simply on \mathbf{u} and $\overline{\mathbf{B}}$ in this point but also on their behavior in some neighborhood of this point.

We adopt the assumption often used in mean-field dynamo theory that $\overline{\mathbf{B}}$ varies only weakly in space and time so that $\overline{\mathbf{B}}$ and its first spatial derivatives in this point are sufficient to define the behavior of $\overline{\mathbf{B}}$ in the relevant neighborhood. Then \mathcal{E} can be represented in the form

$$\mathcal{E}_i = a_{ij} \overline{B}_j + b_{ijk} \partial \overline{B}_j / \partial x_k, \quad (16)$$

where the tensors a_{ij} and b_{ijk} are averaged quantities determined by \mathbf{u} . We use here and in the following the notation $x_1 = x$, $x_2 = y$, $x_3 = z$ and adopt the summation convention. Of course, the neglect of contributions to \mathcal{E} with higher order spatial derivatives or with time derivatives of $\overline{\mathbf{B}}$ (which is in one respect relaxed in Section VB) remains to be checked in all applications.

The specific properties of the considered flow patterns allow us to reduce the form of \mathcal{E} given by (16) to a more specific one. Due to our definition of averages and the periodicity of the flow patterns in x and y , and its independence of z , the tensors a_{ij} and b_{ijk} are independent of x , y and z . Clearly a 90° rotation of the flow pattern about the z -axis as well as a shift by a length a along the x or y -axes change only the sign of \mathbf{u} so that simultaneous rotation and shift leave \mathbf{u} unchanged. This is sufficient to conclude that a_{ij} and b_{ijk} are axisymmetric tensors with respect to the z -axis. So a_{ij} and b_{ijk} contain no other tensorial construction elements than the Kronecker tensor δ_{lm} , the Levi-Civita tensor ϵ_{lmn} and the unit vector \mathbf{e} in z -direction. The independence of the flow pattern of z requires that a_{ij} and b_{ijk} are invariant under the change of the sign of \mathbf{e} . Finally it can be concluded on the basis of (15) that \mathcal{E} has to vanish if

$\overline{\mathbf{B}}$ is a homogeneous field in z -direction, which leads to $a_{33} = 0$. With the specification of a_{ij} and b_{ijk} according to these requirements relation (16) turns into

$$\begin{aligned} \mathcal{E} &= -\alpha_{\perp} (\overline{\mathbf{B}} - (\mathbf{e} \cdot \overline{\mathbf{B}}) \mathbf{e}) \\ &\quad -\beta_{\perp} \nabla \times \overline{\mathbf{B}} - (\beta_{\parallel} - \beta_{\perp}) (\mathbf{e} \cdot (\nabla \times \overline{\mathbf{B}})) \mathbf{e} \\ &\quad -\beta_3 \mathbf{e} \times (\nabla (\mathbf{e} \cdot \overline{\mathbf{B}}) + (\mathbf{e} \cdot \nabla) \overline{\mathbf{B}}), \end{aligned} \quad (17)$$

where the coefficients α_{\perp} , β_{\perp} , β_{\parallel} and β_3 are averaged quantities determined by \mathbf{u} and independent of x , y and z . The term with α_{\perp} describes an α -effect, which is extremely anisotropic. It is able to drive electric currents in the x and y -directions, but not in the z -direction. The terms with β_{\perp} and β_{\parallel} give rise to the introduction of a mean-field diffusivity different from the original magnetic diffusivity of the fluid and again anisotropic. In contrast to them the remaining term with β_3 is not connected with $\nabla \times \overline{\mathbf{B}}$ but with the symmetric part of the gradient tensor of $\overline{\mathbf{B}}$ and can therefore not be interpreted in the sense of a mean-field diffusivity.

In the case of the Roberts flow the coefficient α_{\perp} has been determined for arbitrary flow rates, and coefficients like β_{\perp} , β_{\parallel} and β_3 for small flow rates [19, 20, 22, 23, 25]. As for the spin generator flow only results for α_{\perp} have been given so far [19, 20, 22, 23, 25].

For the determination of α_{\perp} it is sufficient to consider equation (15) for \mathbf{B}' with $\overline{\mathbf{B}}$ specified to be homogeneous field. In this case, which implies $\nabla \times (\mathbf{u} \times \overline{\mathbf{B}}) = \mathbf{0}$, this equation turns into

$$\begin{aligned} \eta \nabla^2 \mathbf{B}' + (\mathbf{B}' \cdot \nabla) \mathbf{u} - (\mathbf{u} \cdot \nabla) \mathbf{B}' - \partial_t \mathbf{B}' &= -(\overline{\mathbf{B}} \cdot \nabla) \mathbf{u}, \\ \nabla \cdot \mathbf{B}' &= 0. \end{aligned} \quad (18)$$

We may again consider \mathbf{B}' like $\overline{\mathbf{B}}$ as independent of z . Let us put $\mathbf{B}' = \mathbf{B}'_{\perp} + \mathbf{B}'_{\parallel}$ and $\mathbf{u} = \mathbf{u}_{\perp} + \mathbf{u}_{\parallel}$ with $\mathbf{B}'_{\perp} = \mathbf{B}' - (\mathbf{e} \cdot \mathbf{B}') \mathbf{e}$ and $\mathbf{B}'_{\parallel} = (\mathbf{e} \cdot \mathbf{B}') \mathbf{e}$, and \mathbf{u}_{\perp} and \mathbf{u}_{\parallel} defined analogously. Then we find

$$\begin{aligned} \eta \nabla^2 \mathbf{B}'_{\perp} + (\mathbf{B}'_{\perp} \cdot \nabla) \mathbf{u}_{\perp} - (\mathbf{u}_{\perp} \cdot \nabla) \mathbf{B}'_{\perp} - \partial_t \mathbf{B}'_{\perp} &= -(\overline{\mathbf{B}} \cdot \nabla) \mathbf{u}_{\perp}, \\ \eta \nabla^2 \mathbf{B}'_{\parallel} - (\mathbf{u}_{\perp} \cdot \nabla) \mathbf{B}'_{\parallel} - \partial_t \mathbf{B}'_{\parallel} &= -((\overline{\mathbf{B}} + \mathbf{B}'_{\perp}) \cdot \nabla) \mathbf{u}_{\parallel}. \end{aligned} \quad (19)$$

We further put $\mathbf{u}_{\perp} = u_{\perp} \tilde{\mathbf{u}}_{\perp}$ and $\mathbf{u}_{\parallel} = u_{\parallel} \tilde{\mathbf{u}}_{\parallel}$, where u_{\perp} and u_{\parallel} are factors independent of x and y characterizing the magnitudes of \mathbf{u}_{\perp} and \mathbf{u}_{\parallel} , and $\tilde{\mathbf{u}}_{\perp}$ and $\tilde{\mathbf{u}}_{\parallel}$ fields which are normalized in some way. Clearly \mathbf{B}'_{\perp} is independent of u_{\parallel} , and \mathbf{B}'_{\parallel} linear in u_{\parallel} . The x and y -components of $\mathbf{u} \times \overline{\mathbf{B}}$, from which α_{\perp} can be concluded, are sums of products of components of \mathbf{u}_{\parallel} and \mathbf{B}'_{\perp} and of \mathbf{u}_{\perp} and \mathbf{B}'_{\parallel} . Thus α_{\perp} must depend in a homogeneous and linear way on u_{\parallel} whereas the dependence on u_{\perp} is in general more complex. This can be observed from the results for the Roberts flow. In view of the spin generator flow we split \mathbf{u}_{\parallel} into two parts, $\mathbf{u}_{\parallel 1}$ and $\mathbf{u}_{\parallel 2}$, of which the first one is non-zero in the central channel and the second one in the helical channel only. We further introduce

the corresponding quantities $u_{\parallel 1}$ and $u_{\parallel 2}$. We may then conclude that α_{\perp} is linear but no longer homogeneous in $u_{\parallel 1}$. Since $u_{\parallel 1}$ is proportional to V_C we find that α_{\perp} is linear but not homogeneous in V_C whereas it shows a more complex dependence on V_H .

For small flow rates we may neglect the terms with \mathbf{u} on the left-hand side of equation (18). This corresponds to the second-order correlation approximation often used in mean-field dynamo theory. Then the solutions \mathbf{B}' and further α_{\perp} can be calculated analytically. Starting from the result found in this way for the spin generator flow [19, 20, 25] and using the above findings we conclude that the general form of α_{\perp} reads

$$\alpha_{\perp} = \frac{V_H}{a^2 h \eta} [V_C \phi_C(V_H/h\eta) + \frac{1}{2} V_H \phi_H(V_H/h\eta)] \quad (20)$$

with two functions ϕ_C and ϕ_H satisfying $\phi_C(0) = \phi_H(0) = 1$. Note that the argument $V_H/h\eta$ is equal to $(a/h)\tilde{V}_H$, which is in turn equal to $\omega(r_2+r_1)(r_2-r_1)/2\eta$. Consequently it is just some kind of magnetic Reynolds number for the rotational motion of the fluid in a helical channel. The functions ϕ_C and ϕ_H have been calculated analytically under a simplifying assumption [20, 25], which, however, proved not to be strictly correct. We will give rigorous results for α_{\perp} and for ϕ_C and ϕ_H in a more general context below in Section V C.

As announced we make now a comment on the assumption that \mathbf{B}' vanishes if $\overline{\mathbf{B}}$ does so. Investigations with the Roberts dynamo problem have revealed that non-decaying solutions \mathbf{B} of the induction equation (1) whose average over a cell vanishes are well possible [28]. They coincide with non-decaying solutions \mathbf{B}' of the equation (15) in the case $\overline{\mathbf{B}} = \mathbf{0}$. These solutions are, however, always less easily excitable than solutions with non-vanishing averages over a cell. They are therefore without interest in the discussion of the excitation condition for mean magnetic fields $\overline{\mathbf{B}}$. In that sense the above assumption is, although not generally true, at least in the case of the Roberts flow acceptable for our purposes. Presumably this applies also for the spin generator flow.

In view of the next Section we assume for a moment that $\overline{\mathbf{B}}$ does not depend on x and y but only on z . In that case we have $\nabla \times \overline{\mathbf{B}} = \mathbf{e} \times [\nabla(\mathbf{e} \cdot \overline{\mathbf{B}}) + (\mathbf{e} \cdot \nabla)\overline{\mathbf{B}}] = \mathbf{e} \times d\overline{\mathbf{B}}/dz$ and therefore (17) turns into

$$\begin{aligned} \mathcal{E} &= -\alpha_{\perp} (\overline{\mathbf{B}} - (\mathbf{e} \cdot \overline{\mathbf{B}}) \mathbf{e}) - \beta \mathbf{e} \times d\overline{\mathbf{B}}/dz, \\ \beta &= \beta_{\perp} + \beta_3. \end{aligned} \quad (21)$$

Interestingly enough, here the difference in the characters of the β_{\perp} and β_3 -terms in (17) is no longer visible. While there are reasons to assume that the coefficients β_{\perp} and β_{\parallel} , which can be interpreted in the sense of a mean-field diffusivity, are never negative, this is no longer true for β_3 and therefore also not for β . The results for the Roberts flow show indeed explicitly that β can take also negative values [19, 22, 23].

B. A modified approach

We now modify the mean-field approach discussed so far in view of the case in which $\overline{\mathbf{B}}$ does not depend on x and y but may have an arbitrary dependence on z . All quantities like \mathbf{B} , $\overline{\mathbf{B}}$, \mathbf{B}' or \mathcal{E} , which depend on z , are represented as Fourier integrals according to

$$F(x, y, z, t) = \int \hat{F}(x, y, k, t) \exp(ikz) dk. \quad (22)$$

The corresponding representation of \mathbf{B} clearly includes the ansatz (5). $\hat{\mathbf{B}}$ depends on x , y , k and t , but $\overline{\hat{\mathbf{B}}}$ and $\hat{\mathcal{E}}$ depend only on k and t . The requirement that $F(x, y, z, t)$ is real leads to $F^*(x, y, k, t) = F(x, y, -k, t)$. Relations of this kind apply to \mathbf{B} , $\overline{\mathbf{B}}$, \mathbf{B}' and \mathcal{E} .

Equations (11) to (15) remain valid whereas (16), (17) and (21) have to be modified. Clearly (13) and (14) are equivalent to

$$\eta k^2 \hat{\overline{\mathbf{B}}} - \mathbf{i} \mathbf{k} \times \hat{\mathcal{E}} + \partial_t \hat{\overline{\mathbf{B}}} = \mathbf{0}, \quad \mathbf{e} \cdot \hat{\overline{\mathbf{B}}} = 0, \quad (23)$$

and

$$\hat{\mathcal{E}} = \overline{\mathbf{u} \times \hat{\mathbf{B}}'}. \quad (24)$$

Instead of (15) we have

$$\begin{aligned} \eta(\nabla^2 - k^2) \hat{\mathbf{B}}' + (\nabla + \mathbf{i} \mathbf{k}) \times (\mathbf{u} \times \hat{\mathbf{B}}') - \partial_t \hat{\mathbf{B}}' \\ = -(\nabla + \mathbf{i} \mathbf{k}) \times (\mathbf{u} \times \hat{\overline{\mathbf{B}}}), \quad (\nabla + \mathbf{i} \mathbf{k}) \cdot \hat{\mathbf{B}}' = 0, \end{aligned} \quad (25)$$

where $(\mathbf{u} \times \hat{\mathbf{B}}')' = \mathbf{u} \times \hat{\mathbf{B}}' - \overline{\mathbf{u} \times \hat{\mathbf{B}}'}$.

Assuming again that \mathcal{E} is linear and homogeneous in $\overline{\mathbf{B}}$ we conclude that the same applies to $\hat{\mathcal{E}}$ and $\hat{\overline{\mathbf{B}}}$, too. Therefore we now have

$$\hat{\mathcal{E}}_i(k, t) = \hat{\alpha}_{ij}(k) \hat{\overline{\mathbf{B}}}_j(k, t), \quad (26)$$

where $\hat{\alpha}_{ij}$ is a complex tensor determined by the fluid flow. Analogous to $\hat{\mathcal{E}}$ and $\hat{\overline{\mathbf{B}}}$ it has to satisfy $\hat{\alpha}_{ij}^*(k) = \hat{\alpha}_{ij}(-k)$. From the symmetry properties of the \mathbf{u} -field we conclude again that the connection between \mathcal{E} and $\overline{\mathbf{B}}$ remains its form if both are simultaneously subject to a 90° rotation about the z -axis, i.e. relation (26) remains unchanged under such a rotation of $\hat{\mathcal{E}}$ and $\hat{\overline{\mathbf{B}}}$. This means that the tensor $\hat{\alpha}_{ij}$ is axisymmetric with respect to the axis defined by \mathbf{k} . The general form of $\hat{\alpha}_{ij}$ that is compatible with $\hat{\alpha}_{ij}^*(k) = \hat{\alpha}_{ij}(-k)$ is given by

$$\hat{\alpha}_{ij}(k) = a_1(|k|)\delta_{ij} + a_2(|k|)k_i k_j + ia_3(|k|)\epsilon_{ijl} k_l \quad (27)$$

with real a_1 , a_2 and a_3 . Together with (26) this leads to $\hat{\mathcal{E}}_z = (a_1 + a_2 k^2) \hat{\overline{\mathbf{B}}}_z$. On the other hand $\hat{\mathcal{E}}_z$ is equal to the average of $u_x \hat{B}'_y - u_y \hat{B}'_x$, and we may conclude from (25) that \hat{B}'_x and \hat{B}'_y are independent of $\hat{\overline{\mathbf{B}}}_z$. This in turn implies $a_1 + a_2 k^2 = 0$. We note the final result for $\hat{\alpha}_{ij}(k)$ in the form

$$\hat{\alpha}_{ij}(k) = -\hat{\alpha}_{\perp}(k)(\delta_{ij} - e_i e_j) + i\hat{\beta}(k)\epsilon_{ijl} k_l \quad (28)$$

with two real quantities $\hat{\alpha}_\perp$ and $\hat{\beta}$, which are even functions of k .

From (26) and (28) we obtain

$$\hat{\mathcal{E}}(k) = -\hat{\alpha}_\perp(k)(\hat{\mathbf{B}} - (\mathbf{e} \cdot \hat{\mathbf{B}})\mathbf{e}) - i\hat{\beta}(k)\mathbf{k} \times \hat{\mathbf{B}}. \quad (29)$$

Together with (22) this leads to

$$\begin{aligned} \mathcal{E}(z, t) = & \\ & - \int \hat{\alpha}_\perp(k) [\hat{\mathbf{B}}(k, t) - (\mathbf{e} \cdot \hat{\mathbf{B}}(k, t))\mathbf{e}] \exp(ikz) dk \\ & - \mathbf{e} \times \frac{\partial}{\partial z} \int \hat{\beta}(k) \hat{\mathbf{B}}(k, t) \exp(ikz) dk. \end{aligned} \quad (30)$$

This in turn is equivalent to

$$\begin{aligned} \mathcal{E}(z, t) = & \\ & - \frac{1}{2\pi} \int \alpha_\perp(\zeta) [\hat{\mathbf{B}}(z + \zeta, t) - (\mathbf{e} \cdot \hat{\mathbf{B}}(z + \zeta, t))\mathbf{e}] d\zeta \\ & - \frac{1}{2\pi} \mathbf{e} \times \frac{\partial}{\partial z} \int \beta(\zeta) \hat{\mathbf{B}}(z + \zeta, t) d\zeta \end{aligned} \quad (31)$$

with

$$\begin{aligned} \alpha_\perp(\zeta) &= \int \hat{\alpha}_\perp(k) \exp(ik\zeta) dk, \\ \beta(\zeta) &= \int \hat{\beta}(k) \exp(ik\zeta) dk. \end{aligned} \quad (32)$$

Note that both α_\perp and β are even in ζ .

Let us now expand $\hat{\alpha}_{ij}(k)$ as given by (28) in a Taylor series and truncate it after the second term,

$$\hat{\alpha}_{ij}(k) = -\hat{\alpha}_\perp(0)(\delta_{ij} - e_i e_j) + ik\hat{\beta}(0)\epsilon_{ijl}e_l. \quad (33)$$

The corresponding expansion of \mathcal{E} as given by (30) reads

$$\mathcal{E} = -\hat{\alpha}_\perp(0)(\mathbf{B} - (\mathbf{e} \cdot \mathbf{B})\mathbf{e}) - \hat{\beta}(0)\mathbf{e} \times d\mathbf{B}/dz. \quad (34)$$

Comparing this with relation (21) of the preceding section we find

$$\alpha_\perp = \hat{\alpha}_\perp(0), \quad \beta = \hat{\beta}(0). \quad (35)$$

Returning again to arbitrary k we define for later purposes a function $\hat{\alpha}(k)$ by

$$\hat{\alpha}(k) = \hat{\alpha}_\perp(k) + k\hat{\beta}(k). \quad (36)$$

If $\hat{\alpha}(k)$ is given, we may determine $\hat{\alpha}_\perp(k)$ and $\hat{\beta}(k)$ according to

$$\begin{aligned} \hat{\alpha}_\perp(k) &= \frac{1}{2} [\hat{\alpha}(k) + \hat{\alpha}(-k)], \\ \beta(k) &= \frac{1}{2k} [\hat{\alpha}(k) - \hat{\alpha}(-k)]. \end{aligned} \quad (37)$$

Moreover, we have

$$\alpha_\perp = \hat{\alpha}(0), \quad \beta = \frac{d\hat{\alpha}(k)}{dk}(0). \quad (38)$$

C. The parameters defining α -effect etc.

In view of the determination of the quantities $\hat{\alpha}_\perp(k)$ and $\hat{\beta}(k)$, which includes that of α_\perp and β , we note that relations like (21) or (29) connecting \mathcal{E} with \mathbf{B} or $\hat{\mathcal{E}}$ with $\hat{\mathbf{B}}$ apply, apart from the explicitly mentioned restrictions, for arbitrary \mathbf{B} . Thus we may take these quantities from calculations carried out for specific \mathbf{B} .

Using the method described in Section III we have numerically determined steady solutions of equation (15) for $\hat{\mathbf{B}}'$ with given V_C , V_H , k and a specific $\hat{\mathbf{B}}$ of Beltrami type satisfying $\mathbf{e} \times d\hat{\mathbf{B}}/dz = k\hat{\mathbf{B}}$. With these solutions we have then calculated the quantity $\hat{\mathcal{E}} \cdot \hat{\mathbf{B}}^*$, which, according to (29), has to satisfy

$$\hat{\mathcal{E}} \cdot \hat{\mathbf{B}}^* = -\hat{\alpha}|\hat{\mathbf{B}}|^2 \quad (39)$$

with $\hat{\alpha}$ defined by (36). From the values of $\hat{\alpha}$ and their dependence on k obtained in this way $\hat{\alpha}_\perp(k)$, $\hat{\beta}(k)$, α_\perp and β have been determined.

In mean-field models of the Karlsruhe device in the sense of the traditional approach explained in Section V A the coefficient α_\perp occurs in the dimensionless combination $C = \alpha_\perp R/\eta$, with R being the radius of the dynamo module, and the influence of β can be discussed in terms of $\tilde{\beta} = \beta/\eta$. We generalize the definitions of C and $\tilde{\beta}$ by putting

$$C = \hat{\alpha}_\perp R/\eta, \quad \tilde{\beta} = \hat{\beta}/\eta. \quad (40)$$

Now C and $\tilde{\beta}$ show a dependence on k , which we express by one on $\kappa = ak$.

Thinking first of the traditional approach we consider C with $\kappa = 0$. Figure 5 shows contours of C in the $V_C V_H$ -diagram, Fig. 6 the functions ϕ_C and ϕ_H , from which α_\perp and thus C can be calculated. These results deviate for large V_H significantly from those determined with the simplifying assumption mentioned above, according to which the mutual influence of the spin generators was ignored [20, 25]. In the region of V_C and V_H which is of interest for the experiment, say $0 < \tilde{V}_C, \tilde{V}_H < 2$, the values of C , ϕ_C and ϕ_H for given V_C and V_H are somewhat larger than those obtained with that assumption. One reason for that might be that in the case of an array of spin generators, compared to a single one in a fluid at rest, the rotational motion in a helical channel expels less magnetic flux into regions without fluid motion, where it can not contribute to the α -effect. Remarkably, in the region $0 < \tilde{V}_C, \tilde{V}_H < 2$ our result for C agrees very well with one derived under the assumption of a Roberts flow [22, 23].

Figure 7 exhibits contours of $\tilde{\beta}$ for $\kappa = 0$ in the $V_C V_H$ -diagram. We already pointed out that $\tilde{\beta}$ can take negative values. Here we see that $\tilde{\beta}$ becomes negative for sufficiently large values of V_C and V_H . Although this happens somewhat beyond the region of interest for the

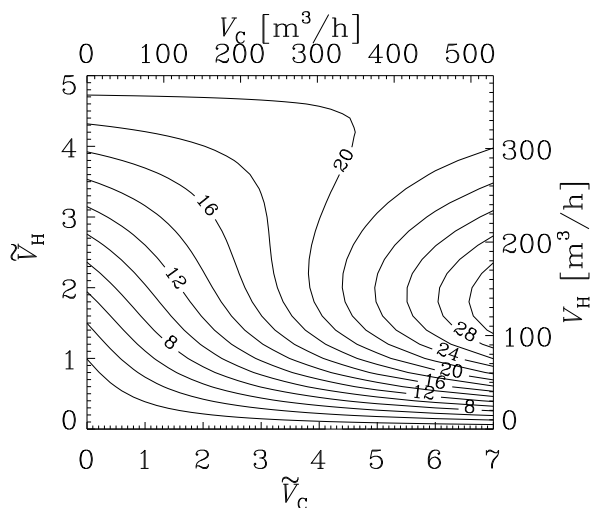
FIG. 5: Contours of C for $\kappa = 0$.

experiment it suggests that inside this region the positive values of $\tilde{\beta}$ may be small. The diffusion term in the mean-field induction equation is proportional to $\eta(1+\tilde{\beta})$. In the investigated region of V_C and V_H this quantity proved always to be positive.

Let us now proceed to C and $\tilde{\beta}$ for $\kappa \neq 0$. As already mentioned, in view of the experimental device it seems reasonable to put $\kappa = \pi a/H = 0.929$. Analogous to Fig. 5, which applies to $\kappa = 0$, Fig. 8 shows contours of C for $\kappa = 0.9$. We see that C for given V_C and V_H is slightly higher in the latter case. The results for $\tilde{\beta}$ are virtually indistinguishable for both cases.

D. The excitation condition in mean-field models

We consider first again the traditional approach to mean-field theory explained in Section V A. Equation (13) for $\overline{\mathbf{B}}$ together with relation (17) for \mathcal{E} allows the solutions

$$\begin{aligned} \overline{\mathbf{B}} &= B_0(\cos(kz), \mp \sin(kz), 0) \exp(pt), \\ p &= -(\eta + \beta)k^2 \pm \alpha_{\perp}k, \end{aligned} \quad (41)$$

where B_0 is an arbitrary constant. We refer here again to Cartesian co-ordinates and consider k as a positive parameter. For these solutions we have $\nabla \times \overline{\mathbf{B}} = \pm k\overline{\mathbf{B}}$, i.e. they are of Beltrami type. This implies that there are no mean electric currents in the z -direction. The solution that corresponds to the upper signs can grow if α_{\perp} is sufficiently large. The condition of marginal stability reads $\alpha_{\perp} = (\eta + \beta)k$ or, what is the same,

$$C = (1 + \tilde{\beta})kR, \quad (42)$$

where C and $\tilde{\beta}$ have to be interpreted as the values for $\kappa = 0$. If we relate this to the dynamo module and put $k = \pi/H$ we have

$$C = (1 + \tilde{\beta})\pi R/H. \quad (43)$$

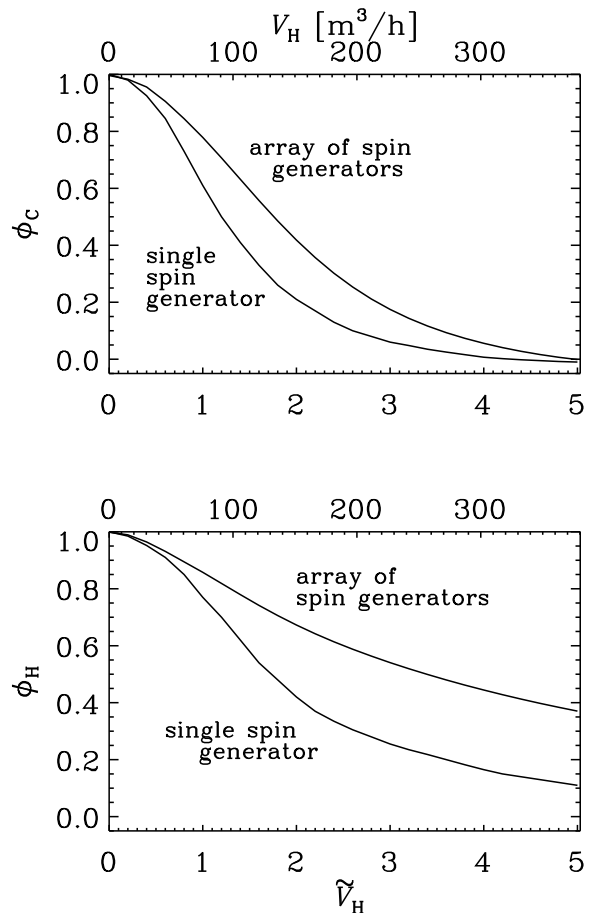
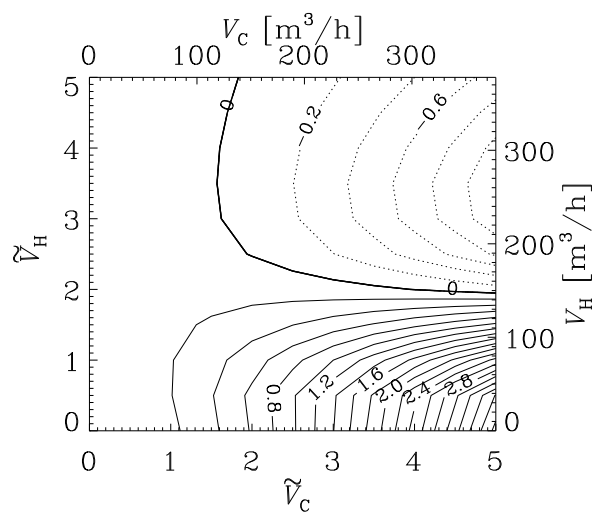
FIG. 6: The functions ϕ_C and ϕ_H calculated for an array of spin generators. For comparison the results of the approximation considering single spin generators (i.e. ignoring their mutual influences) are also given.FIG. 7: Contours of $\tilde{\beta}$ for $\kappa = 0$ (calculated as the limit $\kappa \rightarrow 0$).

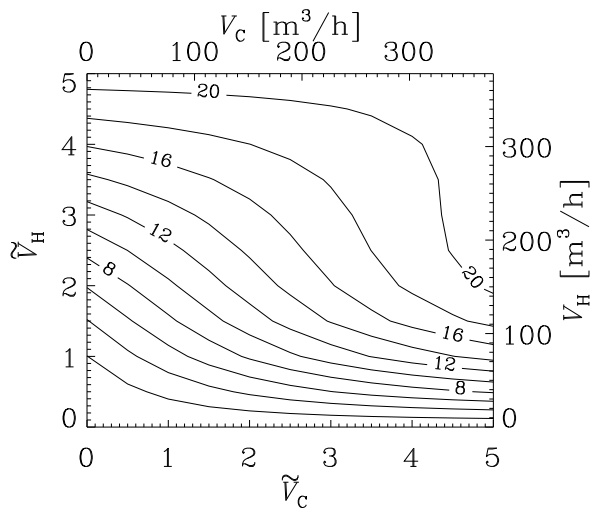

FIG. 8: Contours of C for $\kappa = 0.9$.

Note that the factor R in the conditions (42) and (43) results from the definition of C only. In fact they are independent of R .

Proceeding to the modified approach to the mean-field theory and replacing relation (17) for \mathcal{E} by (30) we find formally the same result. However, α_{\perp} and β have to be replaced by $\hat{\alpha}_{\perp}$ and $\hat{\beta}$, and C and $\tilde{\beta}$ in (42) and (43) have to be taken for $\kappa = ak$. The condition (42) interpreted in this sense defines neutral lines in the $V_C V_H$ -diagram which have to agree exactly with those shown in Fig. 4. Likewise, the condition (43) defines the special neutral line with $\kappa = \pi a/H$.

One of the shortcomings of estimates of the self-excitation condition of the experimental device based on the solutions of the induction equation used in Section IV or, equivalently, on a relation like (43), consists in ignoring the finite radial extent of the dynamo module. We point out another solution of equation (13) for $\overline{\mathbf{B}}$, which has been used for an estimate of the self-excitation condition of the experimental device considering its finite radial extent [20, 23, 31]. For the sake of simplicity we assume that \mathcal{E} is given by equation (17) with $\beta_{\perp} = \beta_{\parallel} = \beta_3 = 0$. We refer to a new cylindrical coordinate system (r, φ, z) adjusted to the dynamo module so that $r = 0$ coincides with its axis and $z = 0$ with its midplane. The solution we have in mind reads

$$\begin{aligned} \overline{\mathbf{B}} &= B_0 \left(\frac{\partial \Psi}{\partial z}, \frac{\eta(q^2 + k^2) + p}{\alpha_{\perp}} \Psi, -\frac{1}{r} \frac{\partial}{\partial r} (r \Psi) \right) \exp(pt), \\ \Psi &= J_0(qr) \cos(kz), \\ p &= -\eta(q^2 + k^2) \pm \alpha_{\perp} k, \end{aligned} \quad (44)$$

where q and k are constants and J_0 is the zero-order Bessel function of the first kind. This solution is axisymmetric with respect to the z -axis. It has further the property that the normal components of $\nabla \times \overline{\mathbf{B}}$ vanish both on the cylindrical surfaces $qr = z_{\nu}$, where z_{ν} denotes the zeros of J_0 , and on the planes $kz = (l + 1/2)\pi$ with

integer l . We identify the region inside the smallest of these cylindrical surfaces between two neighboring planes of that kind with the dynamo module, so we put $q = z_1/R$, where z_1 is the smallest positive zero of J_0 , and $k = \pi/H$. Then there are no electric currents penetrating the surface of the dynamo module. The condition of marginal stability for the so specified solution reads

$$C = \pi(R/H)[1 + (z_1 H/\pi R)^2]. \quad (45)$$

In the limit $H/R \rightarrow 0$ this agrees with (43) if we put $\tilde{\beta} = 0$. For finite H/R , however, C is now always larger than the value given by (43) with $\tilde{\beta} = 0$. This can easily be understood considering that there is now an additional dissipation of the magnetic field due to its radial gradient. C as function of H/R has a minimum at $H/R = \pi/z_1$. The dynamo module was designed so that H/R has just this value. In this case we have

$$C = 2\pi R/H. \quad (46)$$

In other words, the real radial extent of the dynamo module enlarges the requirements for C , compared to the case of infinite extent, by a factor 2. As can be seen from Fig. 5, in the region of V_C and V_H in which experimental investigations have been carried out, say $1.3 < \tilde{V}_C, \tilde{V}_H < 1.6$, this enlargement of C means that if, e.g., V_C is given, V_H grows by a factor between 2.5 and 3.5. We recall here the deviation of the experimental results from the estimate of the self-excitation condition given in Section IV on the basis of Fig. 4, which just corresponds to (43). In the light of these explanations concerning the influence of the radial extent of the dynamo module this deviation is quite plausible. It is actually rather small, which indicates that our reasoning despite a number of neglected effects does not underestimate the requirements for self-excitation.

We note that also the result (46) is not a completely satisfying estimate of the self-excitation condition of the experimental device. Apart from the fact that it does not consider realistic boundary conditions for the dynamo module it is based on an axisymmetric solution of the equation for $\overline{\mathbf{B}}$. Several investigations have however revealed that a non-axisymmetric solution is slightly easier to excite than axisymmetric ones [19, 21, 22, 23]. The influence of the β_{\perp} and β_3 -terms of \mathcal{E} can no longer be expressed by $\tilde{\beta}$, and there is also an influence of the β_{\parallel} -term. All these influences increase the marginal values of C [19].

VI. THE EFFECT OF THE LORENTZ FORCE ON THE FLOW RATES

In the theory of the experiment, equations determining the fluid flow rates in the loops containing the central channels and in those containing helical channels have been derived from the balance of the kinetic energy in these loops. The rate of change of the kinetic energy in

a loop is given by the work done by the pumps against the hydraulic resistance and the Lorentz force. For the work done by the Lorentz force averaged over a central or a helical channel we write $\langle \mathbf{u} \cdot \mathbf{f} \rangle \mathcal{V}$, where $\langle \dots \rangle$ means the average over this channel, \mathcal{V} its volume and \mathbf{f} the Lorentz force per unit volume,

$$\mathbf{f} = \mu^{-1}(\nabla \times \mathbf{B}) \times \mathbf{B}, \quad (47)$$

with μ being the magnetic permeability of free space.

We use again $\mathbf{B} = \overline{\mathbf{B}} + \mathbf{B}'$. For all results reported here we have assumed that $\overline{\mathbf{B}}$ is a homogeneous field and, correspondingly, \mathbf{B}' is also independent of z so that equations (18) apply. Then also \mathbf{f} is independent of z and $\langle \dots \rangle$ may simply be interpreted as an average over the section of the channel with the xy -plane.

We have calculated the quantities $\langle \mathbf{u} \cdot \mathbf{f} \rangle_C$ and $\langle \mathbf{u} \cdot \mathbf{f} \rangle_H$ for a central and a helical channel analytically in two different approximations [22, 24]. In approximation (i) all contributions to \mathbf{f} of higher than first order in V_C or V_H were neglected so that it applies to small V_C and V_H only. In approximation (ii) arbitrary V_C and V_H were admitted, but as in an earlier calculation of the α -effect only a single spin generator surrounded by conducting medium at rest was considered, i.e. any influence of the neighboring spin generators was ignored. We represent the results of both approximations in the form

$$\begin{aligned} \langle \mathbf{u} \cdot \mathbf{f} \rangle_C &= -\frac{\sigma}{2\gamma_C} \left(\frac{V_C}{s_C} \right)^2 B_{\perp}^2 \psi_C(V_C, V_H), \\ \langle \mathbf{u} \cdot \mathbf{f} \rangle_H &= -\frac{\sigma}{2\gamma_H} \left(\frac{V_H}{s_H} \right)^2 B_{\perp}^2 \psi_H(V_C, V_H). \end{aligned} \quad (48)$$

Here σ is the electric conductivity of the fluid, γ_C and γ_H are given by

$$\gamma_C = 1, \quad \gamma_H = \frac{(r_1 + r_2)^2 + (h/\pi)^2}{2(r_1^2 + r_2^2) + (h/\pi)^2}, \quad (49)$$

s_C and s_H are the cross-sections of the central and helical channels, and B_{\perp} is the magnetic flux density perpendicular to the axis of the spin generator, i.e. to the z -axis. In approximation (i) we have $\psi_C = \psi_H = 1$. In approximation (ii) ψ_C and ψ_H are functions of V_C and V_H satisfying $\psi_C(V_C, 0) = 1$ for $V_C \neq 0$ and $\psi_H(V_C, 0) = 1$ for all V_C , varying only slightly with V_C and decaying with growing V_H ; see also Fig. 9. The factors ψ_C and ψ_H in the relations (48) for $\langle \mathbf{u} \cdot \mathbf{f} \rangle_C$ and $\langle \mathbf{u} \cdot \mathbf{f} \rangle_H$ describe the reduction of the Lorentz force by the magnetic flux expulsion out of the moving fluid by its azimuthal motion.

We may conclude from the relevant equations that $\langle \mathbf{u} \cdot \mathbf{f} \rangle_C$ and $\langle \mathbf{u} \cdot \mathbf{f} \rangle_H$ can again be represented in the form (48) if the complete array of spin generators and arbitrary V_C and V_H are taken into account. Only the dependences of ψ_C and ψ_H on V_C and V_H changes.

Before giving detailed results we make a general statement on these dependences. As in the considerations in the paragraph containing (18) we may again introduce the quantities \mathbf{B}'_{\perp} , \mathbf{B}'_{\parallel} , \mathbf{u}_{\perp} , \mathbf{u}_{\parallel} and use (19). With the

same reasoning as applied there we find that for the spin generator flow \mathbf{B}'_{\perp} is independent of V_C and \mathbf{B}'_{\parallel} linear in V_C . We further express \mathbf{f}_{\perp} and \mathbf{f}_{\parallel} , defined analogous to \mathbf{B}'_{\perp} and \mathbf{B}'_{\parallel} , according to (47) by the components of \mathbf{B}'_{\perp} and \mathbf{B}'_{\parallel} , their derivatives and the components of $\overline{\mathbf{B}}$. In this way we find that $\langle \mathbf{u} \cdot \mathbf{f} \rangle_C$ is a sum of two terms, one proportional to V_C and the other proportional to V_C^2 . Consequently, ψ_C has the form $\psi_C^{(0)}(V_H) + \psi_C^{(-1)}(V_H)V_C^{-1}$ with $\psi_C^{(0)}(0) = 1$. We further find that $\langle \mathbf{u} \cdot \mathbf{f} \rangle_H$ is a sum of three terms, one independent of V_C and the others proportional to V_C and V_C^2 , and ψ_H has the form $\psi_H^{(0)}(V_H) + \psi_H^{(1)}(V_H)V_C + \psi_H^{(2)}(V_H)V_C^2$ with $\psi_H^{(0)}(0) = 1$. This can be seen explicitly from the calculations in the approximation (ii) mentioned above, in which, by the way, $\psi_H^{(2)} = 0$.

We have calculated ψ_C and ψ_H numerically on the basis of equations (15) using the method described in Section III. The result is shown in Fig. 9. Instead of the complete array of spin generators we have also considered an array in which fluid motion occurs only in one out of 4×4 spin generators. The numerical result obtained for this case agrees very well with the analytical result of approximation (ii) shown in Fig. 9.

For a complete array of spin generators the factors ψ_C and ψ_H in the relations (48) are generally larger compared to approximation (ii). In other words, the Lorentz force is less strongly reduced by the azimuthal motion of the fluid. This can be understood by considering that less magnetic flux can be pushed into regions without fluid motion.

VII. CONCLUSIONS

We have first dealt with a modified Roberts dynamo problem with a flow pattern resembling that in the Karlsruhe dynamo module. Based on numerical solutions of this problem a self-excitation condition was found. Since in these calculations neither the finite radial extent of the dynamo module nor realistic boundary conditions at its plane boundaries were taken into account this self-excitation condition deviates markedly from that for the experimental device.

A mean-field approach to the modified Roberts dynamo problem is presented. Two slightly different treatments are considered, assuming as usual only weak variations of the mean magnetic field in space, or admitting arbitrary variations in the z -direction. The coefficient α_{\perp} describing the α -effect and a coefficient β connected with derivatives of the mean magnetic field are calculated for arbitrary fluid flow rates. The result for α_{\perp} corrects earlier results obtained in an approximation that ignores the mutual influences of the spin generators [25]. It leads to a much better agreement of the calculated self-excitation condition with the experimental results [22, 23]. We note in passing that in the case of small flow rates our result, although calculated for rigid-body

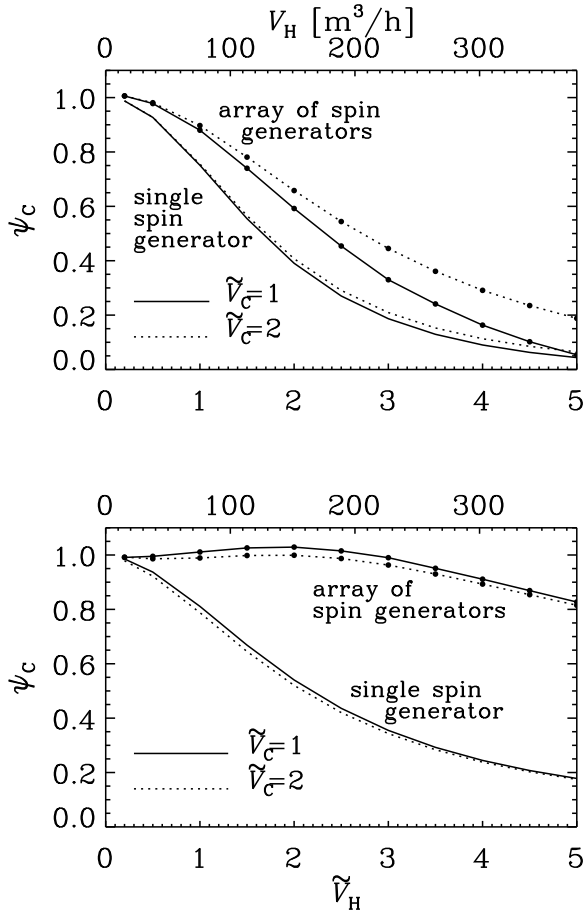

FIG. 9: The dependence of ψ_H and ψ_C on \tilde{V}_H for $\tilde{V}_C = 1$ and $\tilde{V}_C = 2$ for an array of spin generators. For comparison the results of approximation (ii), which considers a single spin generator only, are also given.

motions only, applies also for more general flow profiles

[22, 23]. The result for β suggests that the enlargement of the effective magnetic diffusivity by the fluid motion can be partially compensated by another effect of this motion. The same has been observed in investigations with the Roberts flow [29]. This could be one of the reasons why the results calculated under idealizing assumptions, in particular ignoring the effect of the mean-field diffusivity, deviate only little from the experimental results [23].

In the framework of the mean-field approach we have also given an estimate of the excitation condition which considers the finite radial extent of the dynamo module. It shows that the real extent enhances the critical value of C , which is a dimensionless measure of α_\perp , by a factor 2. In other words, if in the region of V_C and V_H , in which experimental investigations have been carried out, V_C is fixed, V_H has to be larger by a factor between 2.5 and 3.5. If the excitation condition is corrected in this way it does not underestimate the requirements for self-excitation.

We have also calculated the effect of the Lorentz force on the fluid flow rates in the channels of a spin generator. Again our result corrects a former one obtained in the approximation already mentioned which ignores the mutual influences of the spin generators [22, 23]. The braking effect of the Lorentz force proves to be stronger than predicted by the former calculations. This means in particular that estimates of the saturation field strengths given so far [22, 24] have to be corrected by factors between 0.8 and 0.9; for more details see Note added in proof in [24].

Acknowledgement The results reported in this paper have been obtained during stays of K.-H.R. at NORDITA. He is grateful for its hospitality. An anonymous referee is acknowledged for making useful suggestions.

-
- [1] R. Stieglitz and U. Müller, Geodynamo - Eine Versuchsanlage zum Nachweis des homogenen Dynamoeffektes. *Wissenschaftliche Berichte Forschungszentrum Karlsruhe FZKA 5716* (1996).
- [2] U. Müller and R. Stieglitz, *Naturwissenschaften* **87**, 381 (2000).
- [3] R. Stieglitz and U. Müller, *Phys. Fluids* **13**, 561 (2001).
- [4] U. Müller and R. Stieglitz, *Nonlinear Processes in Geophysics* **9**, 165 (2002).
- [5] R. Stieglitz and U. Müller, *Magnetohydrodynamics* **38**, 27 (2002).
- [6] A. Gailitis, O. Lielausis, S. Dementév, E. Platācis, A. Cifersons, G. Gerbeth, T. Gundrum, F. Stefani, M. Christen, H. Hänel, and G. Will, *Phys. Rev. Lett.* **84**, 4365 (2000).
- [7] A. Gailitis, O. Lielausis, E. Platācis, S. Dementév, A. Cifersons, G. Gerbeth, T. Gundrum, F. Stefani, M. Christen, and G. Will, *Phys. Rev. Lett.* **86**, 3024 (2001).
- [8] F. H. Busse, *Geophys. J. R. Astr. Soc.* **42**, 437 (1975).
- [9] F. H. Busse, in *Evolution of Dynamical Structures in Complex Systems*, edited by R. Friedrich and A. Wunderlin (Springer-Progress in Physics, Vol. **69**, 1992) pp.197-207.
- [10] A. Gailitis, *Magnetohydrodynamics* **3**, 23 (1967).
- [11] G. O. Roberts, *Phil. Trans. Roy. Soc. London, A* **271**, 411 (1972).
- [12] A. Tilgner, *Phys. Lett. A* **226**, 75 (1997).
- [13] A. Tilgner, *Acta Astron. et Geophys. Univ. Comenianae* **19**, 51 (1997).
- [14] A. Tilgner, *Phys. Earth Planet. Int.* **117**, 171 (2000).
- [15] A. Tilgner and F. H. Busse, in *Dynamo and Dynamics, a Mathematical Challenge*, edited by P. Chossat et al. (Kluwer Academic Publishers 2001, pp. 109-116).
- [16] A. Tilgner and F. H. Busse, *Magnetohydrodynamics* **38**, 35 (2002).
- [17] A. Tilgner, *Astron. Nachr.* **323**, 407 (2002).

- [18] A. Tilgner, *Phys. Fluids* **14**, 4092 (2002).
- [19] K.-H. Rädler, A. Apel, E. Apstein, and M. Rheinhardt, Contributions to the theory of the planned Karlsruhe dynamo experiment. *AIP Report* (1996).
- [20] K.-H. Rädler, E. Apstein, M. Rheinhardt, and M. Schüler, Contributions to the theory of the planned Karlsruhe dynamo experiment - Supplements and Corrigenda. *AIP Report* (1997).
- [21] K.-H. Rädler, E. Apstein, M. Rheinhardt, and M. Schüler, *Studia geoph. et geod.* **42**, 224 (1998).
- [22] K.-H. Rädler, M. Rheinhardt, E. Apstein, and H. Fuchs, *Nonlinear Processes in Geophysics* **9**, 171 (2002).
- [23] K.-H. Rädler, M. Rheinhardt, E. Apstein, and H. Fuchs, *Magnetohydrodynamics* **38**, 41 (2002).
- [24] K.-H. Rädler, M. Rheinhardt, E. Apstein, and H. Fuchs, *Magnetohydrodynamics* **38**, 73 (2002).
- [25] K.-H. Rädler, E. Apstein, and M. Schüler, in *Proceedings of the 3rd International PAMIR Conference 'Transfer Phenomena in Magnetohydrodynamic and Electroconducting Flows'*, Aussios, France, September 1997, Vol. 1, pp. 9-14.
- [26] D. Lortz, *Phys. Fluid* **11**, 913 (1968).
- [27] A. Tilgner and F. H. Busse, *Proc. Roy. Soc. A* **448**, 237 (1995).
- [28] F. Plunian and K.-H. Rädler, *Geophys. Astrophys Fluid Dyn.* **96**, 115 (2002).
- [29] F. Plunian and K.-H. Rädler, *Magnetohydrodynamics* **38**, 95 (2002).
- [30] F. Krause and K.-H. Rädler, *Mean-Field Magnetohydrodynamics and Dynamo Theory*. (Pergamon Press, Oxford 1980).
- [31] F. H. Busse, U. Müller, R. Stieglitz, and A. Tilgner, in *Evolution of Spontaneous Structure in Dissipative Continuous Systems*, edited by F. H. Busse and S. C. Müller (Springer, Berlin 1998), pp.546-558.