

FOLDED SOLITARY WAVES AND FOLDONS IN 2+1 DIMENSIONS

XIAO-YAN TANG¹ AND SEN-YUE LOU^{1,2,3}

¹*Department of Physics, Shanghai Jiao Tong University, Shanghai, 200030, P.R.China*

²*School of Mathematics, The University of New South Wales, Sydney, NSW 2052, Australia*

³*Department of Physics, Ningbo University, Ningbo 315211, P. R. China*

ABSTRACT. A general type of localized excitations, folded solitary waves and foldons, are defined and studied both analytically and graphically. The folded solitary waves and foldons may be “folded” in quite complicated ways and possess quite rich structures and abundant interaction properties. The folded phenomenon is quite universal in the real natural world. The folded solitary waves and foldons are obtained from a quite universal formula and the universal formula is valid for some quite universal (2+1)-dimensional physical models. The “universal” formula is also extended to a more general form with many more independent arbitrary functions.

PACS.05.45.Yv, 02.30.Jr, 02.30.Ik.

In the study of nonlinear science, soliton theory plays a very important role and has been applied in almost all the natural sciences especially in all the physical branches such as the fluid physics, condense matter physics, biophysics, plasma physics, nonlinear optics, quantum field theory and particle physics etc.. Almost all the previous studies of soliton theory especially in high dimensions are restricted in single valued situations. However, the real natural phenomena are very complicated. In various cases, it is even impossible to describe the natural phenomena by single valued functions. For instance, in the real natural world, there exist very complicated folded phenomena such as the folded protein [1], folded brain and skin surfaces and many many other kinds of folded biologic systems[2]. The simplest multi-valued (folded) waves may be the bubbles on (or under) a fluid surface. Various kinds of ocean waves are really folded waves also.

To study the complicated folded natural phenomena is very difficult. Similar to the single valued cases, the first important question we should ask is: Are there any stable multi-valued (folded) localized excitations? For convenience later, we define the multi-valued localized excitations folded solitary waves. Furthermore, if the interactions among the folded solitary waves are completely elastic, we call them foldons. In (1+1)-dimensional case, the simplest foldons are so-called loop solitons[3] which can be found in many (1+1)-dimensional integrable systems[3] and have been applied in some possible physical fields like the string

interaction with external field[4], quantum field theory[5] and particle physics[6]. However, in our knowledge, there is no study at all for the possible higher dimensional foldons. That is the main topic of this letter.

In (1+1)-dimensions, it has been proven that when a physical model can be expressed by a partial differential equation (PDE), then under some suitable approximations, one can always find nonlinear Schrödinger type equations[7] that is why the (1+1)-dimensional soliton theory can be successively applied in almost all the physical branches. Similarly, if (2+1)-dimensional physical model can be expressed by a PDE, then under some suitable approximations, one can find the Davey-Stewartson (DS) type equations[8].

Recently, it is found that a quite “universal” formula [9]

$$U \equiv \frac{-2\Delta q_y p_x}{(a_0 + a_1 p + a_2 q + a_3 p q)^2}, \quad \Delta \equiv a_0 a_3 - a_1 a_2, \quad (1)$$

is valid for suitable fields or potentials of various (2+1)-dimensional physically interesting integrable models including the DS equation, the dispersive long wave equation (DLWE)[10], the Broer-Kaup-Kupershmidt (BKK), and so on. In Eq. (1), $p \equiv p(x, t)$ is an arbitrary function of $\{x, t\}$, $q \equiv q(y, t)$ may be either an arbitrary function for some kinds of models such as the DS system or an arbitrary solution of a Riccati equation for some others, say, the DLWE while a_0, a_1, a_2 and a_3 are taken as constants. One of the most important results obtained from (1) is that for all the models mentioned above there are quite rich localized excitations such as the solitons, dromions, lumps, breathers, instantons, ring solitons, peakons, compactons, localized chaotic and fractal patterns and so on[9].

Now the natural and important question is: Can we find some types of (2+1)-dimensional foldons from the “universal” formula? Fortunately, the answer is obviously positive because of the arbitrariness of the functions p and q included in the universal formula. To find more general types of foldons, we extend the universal formula to a more general form for the DLWE before to give out concrete foldons. For the (2+1)-dimensional DLWE

$$u_{yt} + \eta_{xx} + u_x u_y + u u_{xy} = 0, \quad \eta_t + u_x + \eta u_x + u \eta_x + u_{xxy} = 0, \quad (2)$$

(1) is valid for the field $v \equiv -\eta - 1$ and the related exact solution reads

$$v \equiv -\eta - 1 = U, \quad u = \pm \frac{2p_x(a_1 + a_3 q)}{a_0 + a_1 p + a_2 q + a_3 p q} + u_0, \quad (3)$$

with p being an arbitrary functions of $\{x, t\}$, $q = q(y, t)$ being an arbitrary solution of the Riccati equation, $q_t - a_0 c_0 - (a_1 c_1 + a_2 c_0 - a_0 c_2)q - (a_3 c_1 - a_2 c_2)q^2 = 0$, and $u_0 =$

$-p_x^{-1}[p_t \pm p_{xx} - a_0 c_1 - (a_1 c_1 + a_2 c_0 + a_0 c_2)p - (a_1 c_2 + a_3 c_0)p^2]$. The (1+1)-dimensional DLWE ($y = x$ of (2)) is also called the classical Boussinesq equation. There exist a large number of papers to discuss the possible applications and exact solutions of the (1+1)-dimensional DLWE[11]. Various interesting properties of the (2+1)-dimensional DLWE have been studied by many authors[12]–[16].

To extend the universal formula to a more general form, we use the multi-linear variable separation approach again. For the DLWE (2), the transformation $\{u = u_0 \pm 2\frac{f_x}{f}, \eta = 2\frac{f_{xy}}{f} - 2\frac{f_x f_y}{f^2} - 1\}$ with $u_0 \equiv u_0(x, t)$ degenerates two equations of (2) to a trilinear form

$$\begin{aligned} & [f_{xxxy} \pm (f_{xyt} + u_{0x} f_{xy} + u_0 f_{xxy})]f^2 - [(f_{xxx} \pm u_0 f_{xx} \pm f_{xt})f_y \pm f_x f_y u_{0x} \\ & + (f_{xxy} \pm 2u_0 f_{xy} \pm f_{yt})f_x + f_{xy} f_{xx} \pm f_t f_{xy}]f + 2f_x f_y (f_{xx} \pm u_0 f_x \pm f_t) = 0. \end{aligned} \quad (4)$$

To solve the trilinear equation (4), one has to use some prior ansatz. The variable separation solution (3) is resulted from the ansatz $f = a_0 + a_1 p + a_2 q + a_3 pq$.

For the DLWE (2), there are two sets of infinitely many symmetries and every symmetry possesses an arbitrary function of t or y [14]. That means infinitely many arbitrary functions of y and t can be entered into the solutions of (2). So it is possible to extend the solution (3) to a more general one with more arbitrary functions. After finishing the detailed calculations, we find that the following variable separation ansatz,

$$f = q_0 + \sum_{i=1}^N p_i q_i, \quad (5)$$

where $\{q_i, i = 0, 1, 2, \dots, N\}$, and $\{p_i, i = 1, 2, \dots, N\}$ are functions of $\{y, t\}$ and $\{x, t\}$ respectively, solves the trilinear equation (4) under the conditions

$$q_{it} = \sum_{j=0}^N (c_{i,j} + q_i C_j) q_j, \quad p_{it} = (c_{00} - u_0 \partial_x - \partial_x^2) p_i - c_{0i} + \sum_{j=1}^N (c_{j0} p_i - c_{ji}) p_j, \quad (6)$$

for all $i = 0, 1, 2, \dots, N$ and $\{c_{ij}, i, j = 0, 1, 2, \dots, N, C_j, j = 1, 2, \dots, N\}$ being arbitrary functions of t . Obviously, the general ansatz (5) will return back to the known one for $N = 2$, $q_0 = a_0$, $q_1 = a_1$, $q_2 = a_2 q$, $q_3 = a_3 q$, $p_1 = p_3 = p$, $p_2 = 1$.

The corresponding solution for the field $v = -\eta - 1$ now reads

$$v = \frac{-2 \sum_{i=1}^N p_{ix} q_{iy}}{q_0 + \sum_{i=1}^N p_i q_i} + \frac{2 \sum_{i=1}^N p_{ix} q_i \left(q_{0y} + \sum_{j=1}^N p_j q_{jy} \right)}{(q_0 + \sum_{i=1}^N p_i q_i)^2} \equiv U_E \quad (7)$$

while the quantity u is given by $u = \pm(2 \sum_{i=1}^N p_{ix} q_i)/(q_0 + \sum_{i=1}^N p_i q_i) + u_0$. It is clear that in addition to a (1+1)-dimensional arbitrary function of $\{x, t\}$ (one of u_0 and p_i), ($N +$

1)($N + 2$) - 1 arbitrary functions of t , c_{ij} , C_j have been included in the general solution. Furthermore, various arbitrary functions of y and $\{x, t\}$ will also be included in (7) after the coupled systems of (6) being solved. Because of the complexity, we have to leave these problems for our future studies. Here we just write down the simplest nontrivial case for the later uses. It is quite trivial that, when we fix $N = 1$, $c_{ij} = C_i = 0$, $p_1 = p$ and $q_0 \rightarrow a_0 + q_0$, the formula (7) is simplified to

$$v = \frac{2p_x(q_1q_{0y} - (a_0 + q_0)q_{1y})}{(a_0 + q_0 + pq_1)^2} \quad (8)$$

with q_0 and q_1 being arbitrary functions of y and p being an arbitrary function of $\{x, t\}$. We can prove that the simplified quantity expressed by the right hand side of (8) does work for all the known models that allow the universal formula (1). It is interesting also that though we have not yet proven the validity of (7) for all the models mentioned in [9], we do have proven that the extended form (7) is really valid at least for some of them such as the BKK system, the (2+1)-dimensional Burgers system and the (1+1)-component AKNS system. For instance, the quantities $g \equiv -2G = U_E$ and $H = (\ln f)_x + u_0/2$ with the same f , p_i and q_i determined by (5) and (6) solve the BKK system $\{H_{ty} - H_{xxy} + 2(HH_x)_y + 2G_{xx} = 0, G_t + G_{xx} + 2(HG)_x = 0\}$.

As pointed out in [9], because of the arbitrariness of the functions appeared in the universal formula and its extended forms, various class of localized excitations can be constructed. Now we concentrate on how to find some types of folded solitary waves and foldons from the universal formula and its extended forms. First of all, we write a localized function, px , in the form

$$px \equiv \sum_{j=1}^M f_j(\xi + v_j t), \quad x = \xi + \sum_{i=1}^M g_i(\xi + v_i t), \quad (9)$$

where $v_1 < v_2 < \dots < v_M$ are all arbitrary constants and $\{f_j, g_j\}$, $\forall j$ are all localized functions with the properties $f_j(\pm\infty) = 0$, $g_i(\pm\infty) = G_i^\pm = \text{consts}$. From the second equation of (9), we know that ξ may be a multi-valued function in some possible regions of x by selecting the functions g_j suitably. So the function px may be a multi-valued function of x in these regions though it is a single valued function of ξ . It is also clear that px is an interaction solution of M localized excitations because of the property $\xi|_{x \rightarrow \infty} \rightarrow \infty$. Actually, most of the known multi-loop solutions are the special cases of (9). Now if we take all the arbitrary functions appeared in the universal formula (1) and/or its slightly general one (8) (and/or

even its more general extended one (7)) possess the forms similar to (9), then we can get various types of folded solitary waves and/or foldons.

In Fig. 1, four typical special folded solitary waves are plotted for the quantity v shown by (8) with $p_x = px$, $p = \int^\xi p_x x_\xi d\xi$ and the functions q_0 and q_1 being given in a similar way

$$q_{\delta y} = \sum_{j=1}^{M_\delta} Q_{\delta j}(\theta), \quad y = \theta + R(\theta), \quad q_\delta = \int^\theta q_{\delta y} y_\theta d\theta, \quad (\delta = 0, 1). \quad (10)$$

In (10), $Q_{\delta j}(\theta)$, $\forall j$ and $R(\theta)$ are localized functions of θ . The more detailed function selections of the figures are directly given in the figure caption.

To construct the possible localized excitations with completely elastic interaction behaviors, especially, foldons, we should discuss the asymptotic behaviors of (8) and (9) when $t \rightarrow \pm\infty$. Assuming further that $F_j(\omega_j) \equiv F_j(\xi + v_j t) \equiv \int f_j dx|_{\omega_j \rightarrow \pm\infty} \rightarrow F_j^\pm$, we can gaze at the j th excitation to see the interaction properties among the localized excitations expressed by (8) with (9) and (10). In other words, we can take ω_j invariant and then take $t \rightarrow \infty$ because q_0 and q_1 have been fixed as t -independent. The results read

$$v|_{t \rightarrow \mp\infty} \rightarrow \frac{2f_j(\omega_j)[q_1 q_{0y} - (a_0 + q_0)q_y]}{[a_0 + q_0 + q_1(F_j(\omega_j) + \Omega_j^\mp)]^2}, \quad x|_{t \rightarrow \mp\infty} \rightarrow \xi + \Gamma_j^\mp + g_j(\xi + v_j t), \quad (11)$$

where $\Omega_j^\mp = \sum_{i>j} F_i^\mp + \sum_{i<j} F_i^\pm$ and $\Gamma_j^\mp = \sum_{i>j} G_i^\mp + \sum_{i<j} G_i^\pm$. From the asymptotic results (11), we know that, (i) the j th localized excitation given by (8) with (9) and (10) is a travelling wave moving in the velocity v_j along the negative ($v_j > 0$) or positive ($v_j < 0$) x -direction; (ii) the multi-valued properties (i.e., the structures) of the j th localized excitation is only determined by g_j of (9); (iii) the shape of the j th excitation will be changed if $\Omega_j^+ \neq \Omega_j^-$, however, it will preserve its shape if $\Omega_j^+ = \Omega_j^-$; (iv) the total phase shift for the j th excitation is $\Gamma_j^+ - \Gamma_j^-$.

From the above discussions, it is seen that to construct some (2+1)-dimensional localized soliton type excitations with completely elastic interaction behaviors becomes an easy task. The only thing one has to do is to select suitable localized functions F_j (and then f_j) with $\Omega_j^+ = \Omega_j^-$ in (9)! The localized soliton like solutions can still possess quite rich structures. Especially, various types of known single-valued localized excitations are also in the catalog due to the arbitrariness of the functions included in (9) and (10). For instance, if we select f_i and Q_i of (9) and (10) possesses the peakon shape solutions[9, 17] and/or the compacton shape solutions[18] with the property $\Omega_i^+ = \Omega_i^-$, then we can find some (2+1)-dimensional peakon type and/or compacton type solutions with completely elastic interaction properties.

Fig. 1a

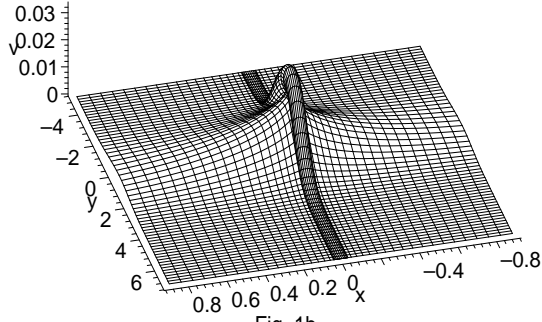

Fig. 1b

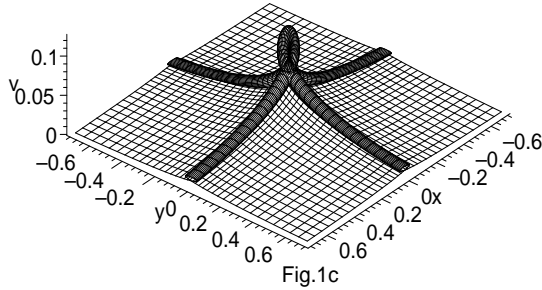

Fig.1c

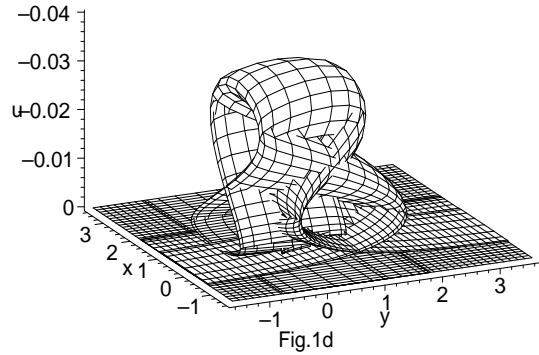

Fig.1d

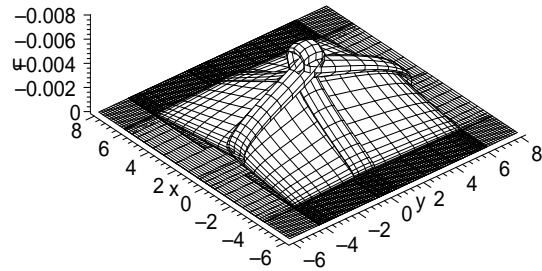

FIGURE 1. Four typical folded solitary wave solutions for the field v expressed by (8) at $t = 0$ with (9), (10) and the related concrete selections are: (a) $p_x = \text{sech}^2(\xi - v_1 t)$, $q_{0y} = \text{sech}^2 \eta$, $q_1 = 1$, $x = \xi - 1.15 \tanh(\xi - v_1 t)$, $y = \eta + l_0 \tanh \eta$, $l_0 = 1$ and $a_0 = 8$; (b) same as (a) but with $l_0 = -1.15$ and $a_0 = 4$; (c) p_x and q_{0y} are same as (a), however, $q_{1y} = \text{sech}^6 \eta$, $x = \xi + 2 \tanh(\xi - v_1 t) + \tanh^2(\xi - v_1 t) - k_0 \tanh^3(\xi - v_1 t)$, $y = \eta + 2 \tanh \eta + \tanh^2 \eta - k_0 \tanh^3 \eta$, $k_0 = -5.4$ and $a_0 = 50$; (d) same as (c) but with $k_0 = 10$ and $a_0 = 250$.

Figs. 2a–2c are plotted to show the possible existence of foldons which are given by (8) with $q_1 = 1$, (9) and (10) for $\delta = 0$ and the concrete function selections are also given in the figure caption. From Figs. 2a and 2c, we can see that the interaction of two foldons is completely elastic. Because one of the velocities of foldons has been selected as zero, it can also be seen that there are phase shifts for two foldons. Especially, before the interaction, the static foldon (the large one) is located at $x = -1.5$ and after the interaction, the large foldon is shifted to $x = 1.5$.

In summary, starting from the “universal” formula and/or its extended form, various kinds of localized excitations with and without completely elastic interaction behaviors can be constructed easily by selecting the arbitrary functions suitably according to the asymptotic results (11). Especially, a new kinds of localized excitations, folded solitary waves and foldons, are investigated both analytically and graphically. The foldons may be folded quite freely and complicatedly and then possess quite rich structures and interaction behaviors. The explicit phase shifts for all the localized excitations given by (8) with (9) and (10) have been given.

On the one hand, there are a large number of complicated “folded” and/or the multi-valued phenomena in the real natural world. On the other hand, there is no good analytical way to treat these kinds of complicated phenomena. This letter is only a beginning attempt, to find some types of possible stable multi-valued localized excitations, folded solitary waves and foldons, for some real physical models including some quite “universal” systems such as the well known DS equation and the DLWE.

Because the formula (8) is valid for various (2+1)-dimensional interesting models, which are divergently applied in many physical fields, we believe that the foldons may be useful in the future studies on the complicated “folded” natural world. The more about both the (extended) “universal” formula and the general (or special) foldons especially its real possible applications should be studied further.

The authors are in debt to thank the helpful discussions with Prof. C. Rogers, Dr. W. Schief, Prof. C-z Qu and Dr. H-c Hu. The work was supported by the National Outstanding Youth Foundation of China (No. 19925522), the National Natural Science Foundation of China (No. 90203001) and the Research Fund for the Doctoral Program of Higher Education of China (Grant. No. 2000024832) and ARC Large Grant A00103139 of the University of New South Wales University, Australia.

Fig.2a

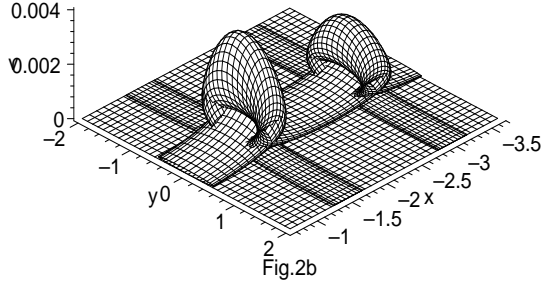

Fig.2b

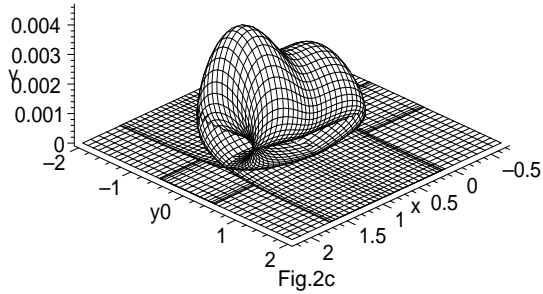

Fig.2c

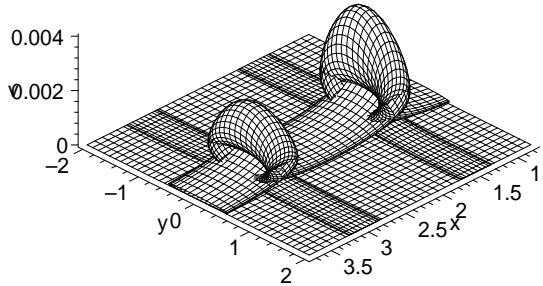

FIGURE 2. Evolution plots of two foldons for the field v expressed by (8) with $p_x = 0.8\text{sech}^2\xi + 0.5\text{sech}^2(\xi - 0.25t)$, $x = \xi - 1.5 \tanh \xi - 1.5 \tanh(\xi - 0.25t)$, $q_1 = 1$, $q_0 = \text{sech}^2\theta$, $y = \theta - 2 \tanh \theta$ and $a_0 = 20$ at times, (a) $t = -18$, (b) $t = 7.2$ and (c) $t = 18$ respectively.

REFERENCES

- [1] S. C. Trewick, T. F. Henshaw, R. P. Hausinger, T. Lindahl, B. Sedgwick, Nature **419** 174 (6903); S. W. Lockless, R. Ranganathan, Science **286** 295 (1999); P. A. Lindgard and H. Bohr, Phys. Rev. Lett., **77** 779 (1996).
- [2] M. B. Goodman, G. G. Ernstrom, D. S. Chelur, R. O'Hagan, C. A. Yao and M. Chalfie, Nature **415** 1039 (2002); B. L. MacInnis, R. B. Campenot, Science **295** 1536 (2002).
- [3] V. O. Vakhnenko, J. Phys. A: Math. Gen. **25** 4181 (1992); V. O. Vakhnenko and E. J. Parkes, Non-linearity **11** 1457 (1998); A. J. Morrison, E. J. Parkes and V. O. Vakhnenko, *ibid.*, **12** 1427 (1999).
- [4] H. Kakuhashi and K. Konno, J. Phys. Soc. Jpn. **68** 757 (1999).

- [5] S. Matsutani, Mod. Phys. Lett. A, **10** 717 (1995); J. Geom. Phys. **43** 146 (2002).
- [6] M. Schleif and R. Wunsch, Eur. J. Phys. A **1** 171 (1998); M. Schleif, R. Wunsch and T. Meissner, Int. J. Mod. Phys. E, **7** 121 (1998).
- [7] F. Calogero, A. Degasperis and X. D. Ji, J. Math. Phys. **41**, 6399 (2000); **42**, 2635 (2001).
- [8] A. Maccari, J. Math. Phys., **37**, 6207 (1996); **38**, 4151 (1997); **40**, 3971 (1999); **42**, 2689 (2001); G. X. Huang, V. V. Konotop, H. W. Tam and B. B. Hu, Phys. Rev. E **64** 056619 (2001).
- [9] X. Y. Tang, S. Y. Lou and Y. Zhang, Phys. Rev. E. **66**, 046601 (2002); S. Y. Lou, C. L. Chen and X. Y. Tang, J. Math. Phys. **43**, 4078 (2002).
- [10] X. Y. Tang, C. L. Chen and S. Y. Lou, J. Phys. A: Math. Gen. 35 (2002) L293.
- [11] M. Musette and R. Conte, J. Phys. A: Math. Gen. **27**, 3895 (1994); M. Musette, R. Conte and A. Pickering, *ibid*, **179**(1995); C. L. Chen and S. Y. Lou, Chaos, Solitons and Fractals, (2003) in press.
- [12] M. Boiti, J. J. P. Leon and F. Pempinelli, Inverse Problem, **3**, 371 (1987).
- [13] G. Paquin and P. Winternitz, Physica D **46**, 122 (1990).
- [14] S. Y. Lou, J. Phys. A: Math. Gen. **27**, 3235 (1994); Phys. Rev. Lett. **71** 4099 (1993).
- [15] S. Y. Lou, Math. Meth. Appl. Sci. **18**, 789 (1995).
- [16] S. Y. Lou, Phys. Lett. **A176** , 96 (1993).
- [17] R. Camassa and D. D. Holm, Phys. Rev. Lett. **71** 1661 (1993).
- [18] P. Rosenau and J. M. Hyman, Phys. Rev. Lett. **70** 564 (1993).