

HOPF PLUMBING, ARBORESCENT SEIFERT SURFACES, BASKETS, ESPALIERS, AND HOMOGENEOUS BRAIDS

LEE RUDOLPH

ABSTRACT. Four constructions of Seifert surfaces—Hopf and arborescent plumbing, basketry, and \mathcal{T} -bandword handle decomposition—are described, and some interrelationships expounded, e.g.: arborescent Seifert surfaces are baskets; Hopf-plumbed baskets are precisely homogeneous \mathcal{T} -bandword surfaces.

1. INTRODUCTION; STATEMENT OF RESULTS

Let $A(O, n) \subset S^3$ denote an n -twisted unknotted annulus. A Seifert surface S is *Hopf-plumbed* (see §3) if $S = D^2$ or if $S = S_0 *_\alpha A(O, \mp 1)$ can be constructed by plumbing a positive or negative Hopf annulus $A(O, \mp 1)$ to a Hopf-plumbed surface S_0 along a proper arc $\alpha \subset S_0$; a Hopf-plumbed surface is a fiber surface, [22, 11, 12]. A Seifert surface S is a *basket* (see §4.1) if $S = D^2$ or if $S = S_0 *_\alpha A(O, n)$ can be constructed by plumbing $A(O, n)$ to a basket S_0 along a proper arc $\alpha \subset D^2 \subset S_0$, [18, 3]; a fundamental theorem of Gabai [7, 8] implies that a basket is a fiber surface iff it is Hopf-plumbed. A Seifert surface S is *arborescent* (see §4.2) if $S = D^2$, or if $S = A(O, n)$, or if $S = S_0 *_\alpha A(O, n)$ can be constructed by plumbing $A(O, n)$ to an arborescent Seifert surface S_0 along a transverse arc α of an annulus plumband of S_0 , [4, 21, 9]; an arborescent Seifert surface is a basket (Proposition 4.2.1).

In §5.1, I define the \mathcal{T} -generators of a braid group corresponding to a tree $\mathcal{T} \subset \mathbb{C}$. Call \mathcal{T} an *espalier* if each edge \mathbf{e} of \mathcal{T} is properly embedded in $\mathbb{C}_- := \{z \in \mathbb{C} : \text{Im } z \leq 0\}$ and $\text{Re} | \mathbf{e} : \mathbf{e} \rightarrow \mathbb{R}$ is injective. For an espalier \mathcal{T} , words \vec{b} in the \mathcal{T} -generators correspond nicely to \mathcal{T} -bandword surfaces $S(\vec{b}) \subset \mathbb{R}^3 \subset S^3$. (If \mathcal{J}_n is an espalier with an edge from p to $p+1$, $1 \leq p < n$, then the \mathcal{J}_n -generators of B_n are the standard generators $\sigma_1, \dots, \sigma_{n-1}$, and $S(\vec{b})$ is the output of Seifert's algorithm [20] applied to the closed braid diagram of \vec{b} .) If \vec{b} is *homogeneous*, then $S(\vec{b})$ is a fiber surface, [22, 15, 16]; in particular $S(\vec{b})$ is incompressible and connected. In §6, I generalize (and make more precise) the fact that a homogeneous \mathcal{J}_n -bandword surface is Hopf-plumbed, and prove a converse.

1991 *Mathematics Subject Classification*. Primary 57M25; Secondary 32S55, 14H99.

Key words and phrases. Arborescent surface, fiber surface, homogeneous braid, Hopf-plumbed surface, plumbing.

Partially supported by UNAM, CAICYT, NSF (DMS-8801915, DMS-9504832), and CNRS.

Main Theorem. (1) If S is any Hopf-plumbed basket (for instance, an arborescent fiber surface), then there is an espalier \mathcal{T} and a homogeneous \mathcal{T} -bandword \vec{b} such that S is isotopic to $S(\vec{b})$. (2) If \mathcal{T} is any espalier, and \vec{b} is a \mathcal{T} -bandword, then the following are equivalent: (A) \vec{b} is homogeneous; (B) $S(\vec{b})$ is a Hopf-plumbed basket; (C) $S(\vec{b})$ is a fiber surface; (D) $S(\vec{b})$ is incompressible and connected.

General notations, definitions, and conventions are established in §2. A number of more or less well-known results about plumbing are collected in §3; the exposition and notation there are adapted to the requirements of §§4-6.

2. PRELIMINARIES

2.1. Miscellany. Both $A := B$ and $B =: A$ define A as meaning B . The symbol \square signals either the end or the omission of a proof. Projection on the i th factor of a cartesian product is denoted by pr_i . For $n \in \mathbb{N} := \{0, 1, 2, \dots\}$, $\mathbf{n} := \{1, \dots, n\}$. Let $s, t, s', t' \in \mathbb{R}$, $s \neq t$, $s' \neq t'$. Say $\{s, t\}$ and $\{s', t'\}$ *touch* if $\text{card}(\{s, t\} \cap \{s', t'\}) = 1$, and *link* (resp., *unlink*) iff they do not touch and the cross-ratio $((s - s')(t - t')) / ((s - t')(s' - t))$ is positive (resp., negative).

2.2. Spaces. Spaces, maps, etc., are piecewise smooth. Isotopies are ambient unless otherwise noted. That X is isotopic to Y is denoted $X \cong Y$, or by $X \cong_Z Y$ if there is such an isotopy fixing Z pointwise. Manifolds may have boundary and are oriented unless otherwise noted; in particular, \mathbb{R} , \mathbb{C}^n , and $S^{2n-1} \subset \mathbb{C}^n$ have standard orientations, as does \mathbb{R}^3 which is identified with the complement of a point $\infty \in S^3$. Identify $\mathbb{C} = \mathbb{R} + \sqrt{-1}\mathbb{R} \supset \mathbb{R}$ with \mathbb{R}^2 and write Re (resp., Im) for pr_1 (resp., pr_2). Then also $\mathbb{C} \times \mathbb{R}$ is identified with \mathbb{R}^3 . Write $\mathbb{C}_- := \{w \in \mathbb{C} : \text{Im } w \leq 0\}$ (resp., $\mathbb{C}_+ := \{w \in \mathbb{C} : \text{Im } w \geq 0\}$) for the closed lower (resp., upper) half-plane.

If M is a manifold, then $-M$ denotes M with its orientation reversed (and, where notation requires it, $+M$ denotes M). For a suitable subset $Q \subset M$, $N_M(Q)$ denotes a closed regular neighborhood of Q in $(M, \partial M)$. For a suitable codimension-1 submanifold $Q \subset M$ (resp., submanifold pair $(Q, \partial Q) \subset (M, \partial M)$), a *collaring* is an orientation-preserving embedding $Q \times [0, 1] \rightarrow M$ (resp., $(Q, \partial Q) \times [0, 1] \rightarrow (M, \partial M)$) extending $1_Q = 1_{Q \times \{0\}}$; a *collar* of Q in M (resp., of $(Q, \partial Q)$ in $(M, \partial M)$) is the image $\text{col}_M(Q)$ (resp., $\text{col}_{(M, \partial M)}(Q, \partial Q)$) of a collaring. The *push-off* of Q determined by a collaring of Q or $(Q, \partial Q)$, denoted by Q^+ , is the image by the collaring of $Q \times \{1\}$ with the orientation of Q ; let $Q^- := -Q^+$ (so that Q and Q^- are oriented submanifolds of the boundary of $\text{col}_M(Q)$).

An *arc* is a manifold diffeomorphic to $[0, 1]$. An *edge* is an unoriented arc. A *surface* is a compact 2-manifold no component of which has empty boundary. An arc or edge α in a 2-manifold S is *proper* (resp., *boundary*) if $\partial\alpha = \alpha \cap \partial S$ (resp., $\alpha \subset \partial S$). Given ordered index sets X, U , and an

ordered handle decomposition

$$(2.2.1) \quad S = \bigcup_{x \in X} h_x^{(0)} \cup \bigcup_{u \in U} h_u^{(1)}$$

of a surface S , write $S^{(0)} := \bigcup_{x \in X} h_x^{(0)}$, $S^{(1)} := \bigcup_{u \in U} h_u^{(1)}$; it is understood that if $u < v$ then the attaching region $h_u^{(1)} \cap \partial S^{(0)}$ is disjoint from $h_v^{(1)} \cap \partial S^{(0)}$. A *core* (resp., *transverse*) arc of a 1-handle $h^{(1)}$ is any proper arc $\kappa(h^{(1)})$ (resp., $\tau(h^{(1)})$) which joins interior points of the two components of the attaching region of $h^{(1)}$ (resp., the complement in $\partial h^{(1)}$ of the attaching region of $h^{(1)}$).

2.3. Seifert surfaces. A *Seifert surface* is a surface $S \subset S^3$. Let $\text{top}(S) := \text{col}_{S^3}(S)$, $\text{bot}(S) := \text{top}(-S)$. A *link* L is the boundary of a Seifert surface. A *knot* is a connected link; a knot O which is the boundary of a disk $D^2 \subset S^3$ is an *unknot*. If K is a knot, then $A(K, n)$ denotes any Seifert surface A (necessarily an annulus) such that $K \subset \partial A$, A is a collar of K in A , and the linking number in S^3 of K and K^+ is n . Since clearly $K^- \cong -K$, so also $A(K, n) \cong A(-K, n)$; further, $-A(K, n) \cong A(K, n)$. A *transverse arc* of $A(K, n)$ is any proper arc $\tau(A(K, n)) \subset A(K, n)$ from K to K^- ; $\tau(A(K, n))$ is unique up to isotopy on $A(K, n)$.

2.4. Incompressible surfaces; fiber surfaces. Let S be a Seifert surface. Say that $D^2 \subset S^3$ is a *top-compression disk* for S , and call S *top-compressible*, if $\partial D^2 = D^2 \cap S$, ∂D^2 bounds no disk on S , and $D^2 \cap \text{top}(S) = \text{col}_{D^2}(\partial D^2)$; a top-compression disk for S can always be taken to be disjoint from $\text{Int bot}(S)$. It is a well known consequence of the Loop Theorem that S is top-compressible iff $\pi_1(S_0) \rightarrow \pi_1(S^3 \setminus S)$ (induced by the inclusion $S^+ \hookrightarrow S^3 \setminus S$ of a push-off) is not injective for some component S_0 of S . Call S *compressible* if either S or $-S$ is top-compressible, and *incompressible* otherwise. (It can happen that exactly one of S , $-S$ is top-compressible, cf. [9].) Call S a *fiber surface* (and ∂S a *fibered link*) if there is a fibration $\varphi : S^3 \setminus \partial S \rightarrow S^1$ such that $\text{Int } S = \varphi^{-1}(1)$ and for all $\zeta \in S^1$, the closure of $\varphi^{-1}(\zeta)$ is a surface with boundary ∂S . By [22] and [6], S is a fiber surface iff S is connected and $\pi_1(S) \rightarrow \pi_1(S^3 \setminus S)$ is bijective. Consequently, a fiber surface is incompressible, and $A(K, n)$ is a fiber surface iff $K = O$, $n = \mp 1$.

2.5. Trees. A *tree* is a finite, connected, acyclic 1-complex \mathcal{T} . Let $\mathbf{V}(\mathcal{T})$ (resp., $\mathbf{V}_{\text{end}}(\mathcal{T})$; $\mathbf{E}(\mathcal{T})$) denote the set of 0-cells (resp., endpoints; 1-cells) of \mathcal{T} .

3. PLUMBING

This section is a systematic exposition of results about those Seifert surfaces that can be constructed from some base Seifert surface (not necessarily a disk) by iterated plumbing of annuli. Although most (if not all) of the results are more or less well-known, there are a few I have not been able to find in the literature.

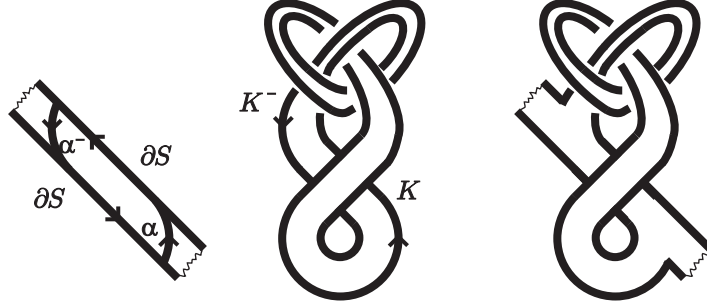

FIGURE 1. A neighborhood of C_α on S ; an annulus $A(K, n)$; the top-plumbed Seifert surface $S \bar{*}_\alpha A(K, n)$.

3.1. Top- and bottom-plumbing. Let $\alpha \subset S$ be a proper arc on a Seifert surface. Let $C_\alpha := \text{col}_{(S, \partial S)}(\alpha, \partial\alpha)$. Then C_α is a 2-patch in the sense of [18], that is, a 2-cell naturally endowed with the structure of a 4-gon such that ∂C_α is the union of two proper arcs in S (namely, α and α^-) and two boundary arcs in S , say γ_α and γ_{α^-} , in the cyclic order $\alpha, \gamma_\alpha, \alpha^-, \gamma_{\alpha^-}$. Let $D_\alpha := \text{col}_{\text{top}(S)}(C_\alpha)$ (so D_α is a 3-cell “on top” of S , that is, the positive normal to S along $C_\alpha = S \cap D_\alpha \subset \partial D_\alpha$ points into D_α). Let $A(K, n) \subset D_\alpha$ be an annulus such that $A(K, n) \cap \partial D_\alpha = C_\alpha$, $\alpha \subset K$, $\alpha^- \subset K^-$. Then $\gamma_\alpha \subset A(K, n)$ is a proper arc, $C_\alpha = \text{col}_{(A(K, n), \partial A(K, n))}(\gamma_\alpha, \partial\gamma_\alpha)$ is a 2-patch on $A(K, n)$, and the union $S \cup A(K, n) =: S \bar{*}_\alpha A(K, n)$ is a Seifert surface. Say $S \bar{*}_\alpha A(K, n)$ is constructed by *top-plumbing* $A(K, n)$ to S along α . Figure 1 illustrates this construction; Figure 2 illustrates *bottom-plumbing* $A(K, n)$ to S along α , that is, the construction of $S \underline{*}_\alpha A(K, n) := -(S \bar{*}_{-\alpha} A(-K, n))$ from $\alpha \subset S$ and $A(K, n)$. In any case where the distinction between $S \bar{*}_\alpha A(K, n)$ and $S \underline{*}_\alpha A(K, n)$ can safely be suppressed (e.g., if they are isotopic; see 3.2–3.3), each may be denoted by $S *_\alpha A(K, n)$ and said simply to have been constructed by *plumbing* $A(K, n)$ to S along α . Given $S' := S *_\alpha A(K, n)$, call any transverse arc of $A(K, n)$ which is disjoint from S a *transverse arc of $A(K, n)$ in S'* , and denote it by $\tau(A(K, n) \subset S')$.

It is useful to have some notations for iterated plumbing. Given proper arcs $\alpha_1 \subset S_0$, $\alpha_2 \subset S_1 := S_0 *_{\alpha_1} A(K_1, n_1)$, \dots , $\alpha_\mu \subset S_{\mu-1}$, call

$$(3.1.1) \quad S_\mu = (\dots (S_0 *_{\alpha_1} A(K_1, n_1) *_{\alpha_2} A(K_2, n_2) \dots) *_{\alpha_\mu} A(K_\mu, n_\mu)) \\ =: S_0 *_{(\alpha_1, \dots, \alpha_\mu)} (A(K_1, n_1), \dots, A(K_\mu, n_\mu))$$

an *annulus S_0 -presentation of S_μ* with *plumbands* $A(K_s, n_s)$ and *plumbing arcs* α_s ; further abbreviate the righthand side of (3.1.1) by $S_0 *_{\vec{\alpha}} A(\vec{K}, \vec{n})$ (where $\vec{\alpha} := (\alpha_1, \dots, \alpha_\mu)$, etc.). Call S *annulus S_0 -plumbed* if it has an annulus S_0 -presentation.

Remark 3.1.1. The notation (3.1.1) does not indicate the type (top or bottom) of each plumbing. In cases where all plumbings are of one type, more

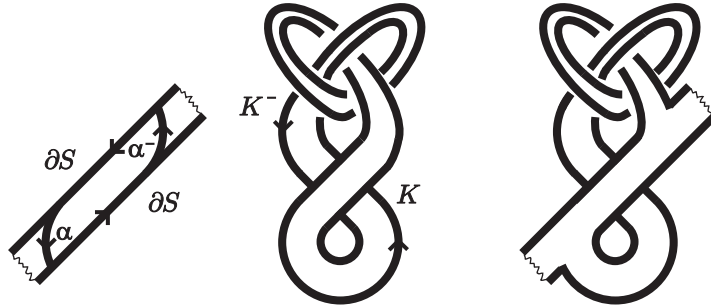
 FIGURE 2. Bottom-plumbing $A(K, n)$ to S along α .

specific notations $S_0 \overline{\ast}_{(\alpha_1, \dots, \alpha_\mu)}(A(K_1, n_1), \dots, A(K_\mu, n_\mu))$ (or $S_0 \overline{\ast}_{\vec{\alpha}} A(\vec{K}, \vec{n})$) and $S_0 \underline{\ast}_{(\alpha_1, \dots, \alpha_\mu)}(A(K_1, n_1), \dots, A(K_\mu, n_\mu))$ (or $S_0 \underline{\ast}_{\vec{\alpha}} A(\vec{K}, \vec{n})$) may be used.

Historical note 3.1.2. Top-plumbing is a special case of *Stallings plumbing* [22] (equivalently, *Murasugi sum* [7]), in the general case of which Seifert surfaces S_1, S_2 (possibly neither an annulus) are attached along a k_1 -patch and a k_2 -patch (possibly with $k_i > 2$). The special case of annulus D^2 -plumbing in which all plumbands are unknotted is also a special case of *arborescent plumbing* [4, 21, 9] (see §4.2), which in general also admits unknotted Möbius bands as plumbands (of course “top” has no global meaning where unoriented, possibly nonorientable, surfaces are involved).

3.2. Coincidences among isotopy classes of plumbed surfaces. Up to isotopy in S^3 , $S \overline{\ast}_{\alpha} A(K, n)$ depends only on S, α (up to isotopy on S), K, n , and the orientations of S, α , and K . In all cases $S \overline{\ast}_{\alpha} A(K, n) = S \overline{\ast}_{-\alpha} A(-K, n)$. In many cases, no two of the Seifert surfaces $S \overline{\ast}_{\alpha} A(K, n), S \underline{\ast}_{\alpha} A(K, n), S \overline{\ast}_{-\alpha} A(K, n)$, and $S \underline{\ast}_{-\alpha} A(K, n)$ are isotopic, though each is the union of oriented submanifolds S and $A(K, n)$ intersecting in C_{α} : if the knot K is not reversible (i.e., $K \not\cong -K$), then $S \overline{\ast}_{\alpha} A(K, n)$ and $S \overline{\ast}_{\alpha} A(-K, n)$ may not be isotopic; and if neither S nor $A(K, n) \neq A(O, \mp 1)$ is a fiber surface, then $S \overline{\ast}_{\alpha} A(K, n)$ and $S \underline{\ast}_{\alpha} A(K, n)$ may not be isotopic. However, various systematic coincidences are worth noting. Let S be a Seifert surface, $\alpha \subset S$ a proper arc.

Lemma 3.2.1. $S \overline{\ast}_{\alpha} A(O, \mp 1) \cong S \underline{\ast}_{\alpha} A(O, \mp 1)$.

Proof. This is a well-known consequence of general facts about geometric monodromies of fibered links (see, e.g., [12]). It is also easily seen directly (Figure 3). \square

Scholium 3.2.2. If S is a fiber surface, then $S \overline{\ast}_{\alpha} A(K, n) \cong S \underline{\ast}_{\alpha} A(K, n)$.

Proof. This follows from the same generalities as 3.2.1. \square

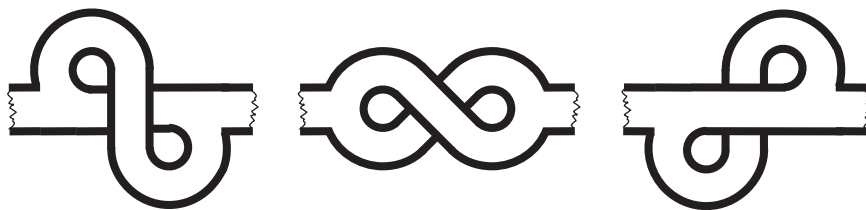

FIGURE 3. Indifference of Hopf annuli to “top” and “bottom”: an isotopy from $S^{\overline{*}}_{\alpha} A(O, -1)$ to $S^{\underline{*}}_{\alpha} A(O, -1)$.



FIGURE 4. $S^{\natural}A(K, n) = S^*_{\alpha} A(K, n)$.

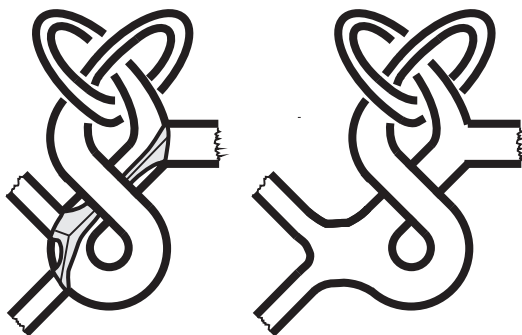

FIGURE 5. A Murasugi sum $S^*A(K, n)$ along a 3-patch, and an isotopic top-plumbing $S^{\overline{*}}_{\alpha} A(K, n)$.

Lemma 3.2.3. *If α is boundary-compressible (i.e., there is 2-disk $D \subset S$ with $\alpha \subset \partial D$, $\partial D \setminus \text{Int } \alpha \subset \partial S$), then for any $A(K, n)$, $S^{\overline{*}}_{\alpha} A(K, n) \cong S^{\underline{*}}_{\alpha} A(K, n)$.*

Proof. Each is a boundary-connected sum $S^{\natural}A(K, n)$ along $\partial D \setminus \text{Int } \alpha$ and an arc of $K \subset \partial A(K, n)$ (Figure 4). \square

Lemma 3.2.4. *Any Murasugi sum of S with an annulus $A(K, n)$ (not necessarily along 2-patches) is isotopic to $S^*_{\alpha} A(K, n)$ for an appropriate α . \square*

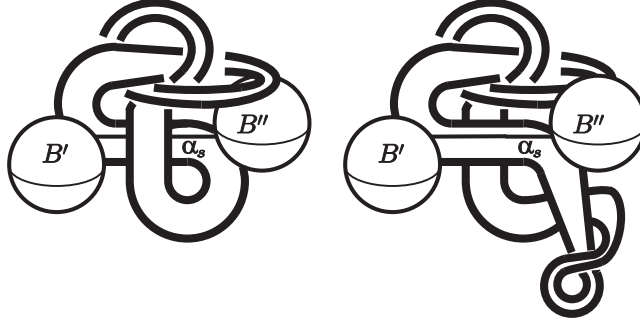

FIGURE 6. Disjoint 3-balls B' and B'' enclose S' and S'' ; there is no obstruction to pulling $A(K_0, n_0)$ around from front to back.

Proof. This is a consequence of the paucity of distinct isotopy classes of k -patches on an annulus. The example in Figure 5 adequately suggests the general proof. \square

Lemma 3.2.5. *Let $\gamma \subset S$ be a proper arc such that $S = S' \natural_{\gamma} S''$. If $\overline{S}_0 := S \overline{*}_{\gamma} A(K_0, n_0)$, $\underline{S}_0 := S \underline{*}_{\gamma} A(K_0, n_0)$, $S_{\mu} := S *_{\vec{\alpha}} A(\vec{K}, \vec{n})$, then $\overline{S}_0 *_{\vec{\alpha}} A(\vec{K}, \vec{n})$ and $\underline{S}_0 *_{\vec{\alpha}} A(\vec{K}, \vec{n})$ are well-defined, and $\overline{S}_0 *_{\vec{\alpha}} A(\vec{K}, \vec{n}) \cong_{S_{\mu}} \underline{S}_0 *_{\vec{\alpha}} A(\vec{K}, \vec{n})$.*

Proof. All the plumbing arcs α_s miss $A(K_0, n_0) \setminus S$, so $\overline{S}_0 *_{\vec{\alpha}} A(\vec{K}, \vec{n})$ and $\underline{S}_0 *_{\vec{\alpha}} A(\vec{K}, \vec{n})$ are well-defined. Figure 6 illustrates the required isotopy. \square

Corollary 3.2.6. *For any γ , $\vec{\alpha}$, $A(K_0, n_0)$, and $A(\vec{\alpha}, \vec{n})$,*

$$(D^2 \overline{*}_{\gamma} A(K_{\gamma}, n_{\gamma})) *_{\vec{\alpha}} A(\vec{K}, \vec{n}) \cong_{D^2} (D^2 \underline{*}_{\gamma} A(K, n)) *_{\vec{\alpha}} A(\vec{K}, \vec{n}). \quad \square$$

Scholium 3.2.7. *There exists a non-ambient isotopy in (D^4, S^3) of the pairs $(S \overline{*}_{\alpha} A(K, n), \partial(S \overline{*}_{\alpha} A(K, n)))$ and $(S \underline{*}_{\alpha} A(K, n), \partial(S \underline{*}_{\alpha} A(K, n)))$; in particular, $\partial(S \overline{*}_{\alpha} A(K, n)) \cong \partial(S \underline{*}_{\alpha} A(K, n))$.*

Proof. Figure 7. \square

3.3. Commuting plumbings. Let S be a Seifert surface, $\alpha_1, \alpha_2 \subset S$ proper arcs.

Lemma 3.3.1. *For all K_1, K_2, n_1 , and n_2 ,*

$$(S \overline{*}_{\alpha_1} A(K_1, n_1)) \underline{*}_{\alpha_2} A(K_2, n_2) = (S \underline{*}_{\alpha_2} A(K_2, n_2)) \overline{*}_{\alpha_1} A(K_1, n_1).$$

Proof. Clear, since (if minimal care is taken) $\text{Int top}(S) \cap \text{Int bot}(S) = \emptyset$. \square

Lemma 3.3.2. *If $|n_1| = 1 = |n_2|$, then*

$$S *_{(\alpha_1, \alpha_2)} (A(O, n_1), A(O, n_2)) \cong S *_{(\alpha_2, \alpha_1)} (A(O, n_2), A(O, n_1)).$$



FIGURE 7. An isotopy from $\partial(S\overline{*}_\alpha A(K, n))$ to $\partial(S\underline{*}_\alpha A(K, n))$, pushing $\partial(A(K, n)\setminus S)$ through $A(K, n)\cap S$.

Proof. Immediate from 3.2.1 and 3.3.1. \square

Lemma 3.3.3. *If $\alpha_1 \cap \alpha_2 = \emptyset$, then for all K_1, K_2, n_1 , and n_2 ,*

$$S_{*(\alpha_1, \alpha_2)}(A(K_1, n_1), A(K_2, n_2)) \cong S_{*(\alpha_2, \alpha_1)}(A(K_2, n_2), A(K_1, n_1)).$$

Proof. If (without loss of generality) C_{α_1} and C_{α_2} are taken to be disjoint, then in fact the two surfaces can be taken to be identical. \square

Scholium 3.3.4. *If $\alpha_1, \alpha_2 \subset S$ intersect transversely in a single point P , and $D \subset S$ is a 3-gon such that $\partial D \cap \partial S$ is an arc and $\partial D \cap \alpha_s$ is an arc with endpoint P , then there is a proper arc $\alpha_3 \subset S$ intersecting each of α_1, α_2 transversely in the single point P , such that, for any $A(K, n)$,*

$$S_{*(\alpha_1, \alpha_2)}(A(K, n), A(O, 1)) = S_{*(\alpha_2, \alpha_3)}(A(O, 1), A(K, n)),$$

$$S_{*(\alpha_2, \alpha_1)}(A(O, -1), A(K, n)) = S_{*(\alpha_3, \alpha_2)}(A(K, n), A(O, -1)).$$

Proof. The first case is illustrated in Figure 8; the second case is similar. \square

3.4. Annulus-plumbed and Hopf-plumbed Seifert surfaces. An annulus D^2 -plumbed Seifert surface will be called simply *annulus-plumbed*. By 3.2.4, any Seifert surface which can be constructed from D^2 by iterated Murasugi sums with annuli is in fact annulus-plumbed. A *Hopf S_0 -presentation* is an annulus S_0 -presentation (3.1.1) such that each plumband is a Hopf annulus $A(O, \mp 1)$. A Hopf D^2 -plumbed Seifert surface is called simply *Hopf-plumbed*.

Proposition 3.4.1. *If S has an annulus S_0 -presentation (3.1.1), then S is a fiber surface iff S_0 is a fiber surface and (3.1.1) is a Hopf S_0 -presentation. In particular, an annulus-plumbed surface is a fiber surface iff it is Hopf-plumbed.*

Proof. Given that an annulus is a fiber surface iff it is a Hopf annulus (2.4), the proposition follows immediately from Gabai's theorem [8] that a Murasugi sum of two Seifert surfaces is a fiber surface iff both summands are fiber surfaces. \square

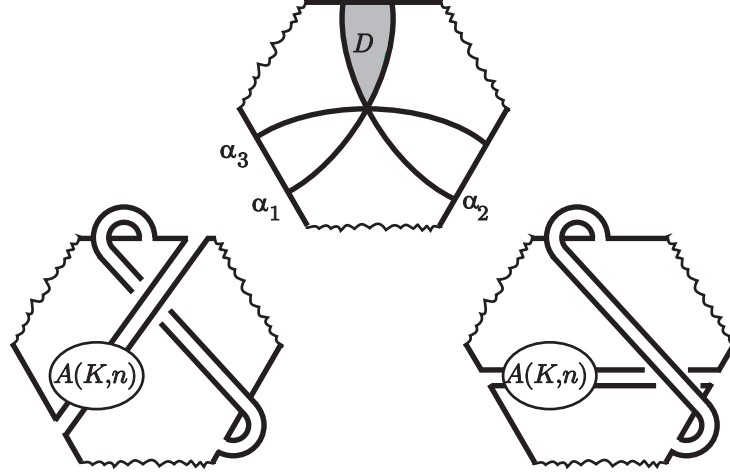

FIGURE 8. One attaching region of the 1-handle $A(K, n) \setminus \text{Int } S$ slides off ∂S , over the 1-handle $A(O, 1) \setminus \text{Int } S$, and back to ∂S .

4. BASKETRY AND ARBORESCENCE

4.1. Baskets. A basket S_0 -presentation is an annulus S_0 -presentation (3.1.1) such that each $K_s = O_s$ is an unknot and each plumbing arc α_s is contained in S_0 . A Seifert surface with a basket D^2 -presentation is a *basket*.

Proposition 4.1.1. *A basket is a fiber surface iff it is Hopf-plumbed.*

Proof. Immediate from 3.4. □

The failure of (3.1.1) to distinguish top from bottom is, in the case of baskets, alleviated by the following result.

Proposition 4.1.2. *Any basket is isotopic, by an isotopy fixing D^2 , to a basket with the same plumbing arcs and plumbands, in which each plumbing is a top-plumbing.*

Proof. For any S_0 , if S has a basket S_0 -presentation with k bottom-plumbed plumbands and ℓ top-plumbed plumbands, then (by 3.3.1) S has a basket S_0 -presentation in which all bottom-plumbed plumbands precede all top-plumbed plumbands, i.e., $S = (S_0 \underset{\vec{\alpha}'}{\ast} A(\vec{O}', \vec{n}')) \underset{\vec{\alpha}''}{\ast} A(\vec{O}'', \vec{n}'')$, where $\vec{\alpha}' = (\alpha'_1, \dots, \alpha'_k)$, $\vec{\alpha}'' = (\alpha''_1, \dots, \alpha''_\ell)$, and so on.

If now $S_0 = D^2$ (the basket case), then induction on k (using 3.2.6 and 3.3.1) completes the proof, and in fact establishes that $S \cong_{D^2} D^2 \underset{\vec{\alpha}}{\ast} A(\vec{O}, \vec{n})$, where $\vec{\alpha} = (\alpha'_k, \alpha'_{k-1}, \dots, \alpha'_1, \alpha''_1, \dots, \alpha''_\ell)$, $\vec{n} = (n'_k, n'_{k-1}, \dots, n'_1, n''_1, \dots, n''_\ell)$. □

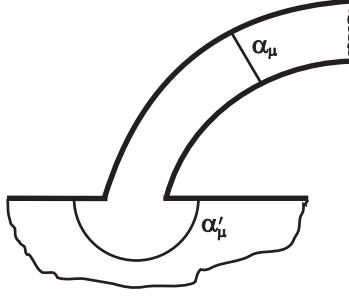

FIGURE 9. Pushing $\tau(A(O_t, n_t) \subset S'_t)$ off $A(O_t, n_t)$.

4.2. Arborescent Seifert surfaces. An *arborescent S_0 -presentation* is an annulus S_0 -presentation (3.1.1) such that each $K_s = O_s$ is an unknot and each plumbing arc α_s with $s > 1$ is a transverse arc $\tau(A(O_t, n_t) \subset S_t)$ for some $t < s$. A Seifert surface with an arborescent D^2 -presentation is simply called *arborescent*.

Proposition 4.2.1. *An arborescent Seifert surface is a basket.*

Proof. More generally and precisely, if $S = S_0 *_{\vec{\alpha}} A(\vec{O}, \vec{n})$ is an arborescent S_0 -presentation with μ plumbands, then there are proper arcs $\alpha'_1 = \alpha_1, \alpha'_2, \dots, \alpha'_\mu \subset S_0$ such that $S' := S_0 *_{\vec{\alpha}'} A(\vec{O}, \vec{n}) \cong_{M_\mu} S$, where (for suitable transverse arcs and regular neighborhoods) $M_k := (S_0 \setminus N_{S_0}(\partial\alpha_1)) \cup \bigcup_{s=2}^k N_{A(O_s, n_s)}(\tau(A(O_s, n_s) \subset S))$.

The proof is by induction on μ . For $\mu \leq 1$, the assertion is trivial. Let $S = (S_0 *_{\vec{\alpha}} A(\vec{O}, \vec{n})) *_{\alpha_\mu} A(O_\mu, n_\mu)$ be an arborescent S_0 -presentation such that $S_{\mu-1} := S_0 *_{\vec{\alpha}} A(\vec{O}, \vec{n}) \cong_{M_{\mu-1}} S'_{\mu-1} := S_0 *_{\vec{\alpha}'} A(\vec{O}, \vec{n})$ for appropriate proper arcs $\alpha'_s \subset S_0$. By assumption, $\alpha_\mu \subset S_{\mu-1}$ is a transverse arc $\tau(A(O_t, n_t) \subset S_t)$ for some $t < s$, so also without loss of generality $\alpha_\mu = \tau(A(O_t, n_t) \subset S'_t)$. Figure 9 illustrates one of the two possible choices (up to isotopy on S_0) of $\alpha'_\mu \subset S_0 \subset S'_t \subset S'_{\mu-1}$. \square

Remarks 4.2.2. (1) Given $S = D^2 *_{\vec{\alpha}} A(\vec{O}, \vec{n})$, an arborescent D^2 -presentation of an arborescent Seifert surface S , it is easy to choose $\vec{\alpha}'$ in 4.2.1 so that $\mathcal{A}' := \bigcup \alpha'_s \subset D^2$ is a tree such that, if $v \in \mathcal{V}(\mathcal{A}')$, then $\text{card}\{\mathbf{e} \in \mathcal{E}(\mathcal{A}') : v \in \partial\mathbf{e}\} \in \{1, 4\}$ (for instance, if $\text{Int } D^2$ is identified with the real hyperbolic plane, then each α_s can be taken to be a hyperbolic line together with its ideal endpoints on ∂D^2). There is a partial converse: if $S = D^2 *_{\vec{\alpha}} A(\vec{O}, \vec{n})$ is a basket presentation such that $\mathcal{A} := \bigcup \alpha_s \subset D^2$ is a tree and each intrinsic vertex of \mathcal{A}' has valence exactly 4, then there is an arborescent surface \tilde{S} , having an arborescent presentation with the same plumbands as S , such that $\partial\tilde{S} = \partial S$ (use 3.2.6 repeatedly). The situation is not merely reminiscent of, but actually strictly analogous to, the duality between “resolution

trees” and “plumbing diagrams” in the theory of graph manifolds and resolution of surface singularities (cf. [5], particularly the figures on p. 146). (2) Arborescent Seifert surfaces and their boundaries (there called *special arborescent links*) have also been studied, from a rather different point of view, in [19].

5. ESPALIERS, BRAIDS, AND \mathcal{T} -BANDWORD SURFACES

5.1. **Espaliers.** A tree embedded in \mathbb{C} (as a stratified space, i.e., with all vertices—not just intrinsic vertices—distinguished) is *planar*. A planar tree \mathcal{T} is an *espalier* if each $\mathbf{e} \in E(\mathcal{T})$ is a proper edge in \mathbb{C}_- and $\text{Re}|e : \mathbf{e} \rightarrow \mathbb{R}$ is injective.

Lemma 5.1.1. *Every planar tree is isotopic to an espalier.*

Given espaliers \mathcal{T} and \mathcal{T}' , it is useful, though abusive, to write $\mathcal{T} = \mathcal{T}'$ when merely $V(\mathcal{T}) = V(\mathcal{T}')$ and \mathcal{T} is isotopic to \mathcal{T}' in \mathbb{C}_- . The embedding of an espalier in \mathbb{C}_- is determined (up to isotopy in \mathbb{C}_-) by the combinatorial structure of \mathcal{T} (i.e., the underlying abstract simplicial 1-complex) together with the order induced on $V(\mathcal{T})$ by its embedding in \mathbb{R} . In particular, given n real numbers $x_1 < \dots < x_n$ and $n - 1$ pairs $\{x_{i(p)}, x_{j(p)}\}$ with $1 \leq i(p) < j(p) \leq n$ for $1 \leq p \leq n - 1$, the following are equivalent: (a) there is an espalier \mathcal{T} with $V(\mathcal{T}) = \{x_1, \dots, x_n\}$, $E(\mathcal{T}) = \{\mathbf{e}_1, \dots, \mathbf{e}_{n-1}\}$, and $\partial\mathbf{e}_p = \{x_{i(p)}, x_{j(p)}\}$; (b) for $1 \leq p < q \leq n - 1$ the pairs $(x_{i(p)}, x_{j(p)})$ and $(x_{i(q)}, x_{j(q)})$ do not link (i.e., they either touch or unlink). For $X = \{x_1, \dots, x_n\} \subset \mathbb{R}$, $x_1 < \dots < x_n$, let \mathcal{J}_X (resp., \mathcal{Y}_X) denote any espalier \mathcal{T} with $V(\mathcal{T}) = X$ and $\{\partial\mathbf{e} : \mathbf{e} \in E(\mathcal{T})\} = \{\{x_p, x_{p+1}\} : 1 \leq p < n\}$ (resp., $\{\{x_1, x_p\} : 1 < p \leq n\}$). Among the combinatorial types of trees with X as the set of 0-cells, \mathcal{J}_X and \mathcal{Y}_X represent two extreme types, viz., *linear* (minimal number of endpoints) and *star-like* (maximal number of endpoints), respectively; further, among the linear (resp., star-like) espaliers, \mathcal{J}_X (resp., \mathcal{Y}_X) is again extreme, in a sense the reader may formalize (for \mathcal{Y}_X , see 6.1.1).

5.2. **Braid groups; bands.** For $n \in \mathbb{N}$, let E_n denote the *configuration space*

$$\{\{w_1, \dots, w_n\} \subset \mathbb{C} : 0 \neq \prod_{i \neq j} w_i - w_j\}$$

of unordered n -tuples of distinct complex numbers. The quotient map of the natural action of $\mathcal{S}_n := \text{Aut}(\mathbf{n})$ on

$$\{(w_1, \dots, w_n) \in \mathbb{C}^n : 0 \neq \prod_{i \neq j} w_i - w_j\} \subset \mathbb{C}^n = \mathbb{C}^{\mathbf{n}}$$

induces a topology, smooth structure, and orientation on E_n , cf. [13]. For any basepoint $X \in E_n$, the fundamental group $B_X := \pi_1(E_n; X)$ is an *n -string braid group*. Of course, an n -string braid group is isomorphic to the *standard n -string braid group* $B_n := B_{\mathbf{n}}$, but it is very convenient to allow more general basepoints. Denote by o_X the identity of B_X .

The map $\{w_1, w_2\} \mapsto (w_1 + w_2, (w_1 - w_2)^2)$ is an orientation-preserving diffeomorphism $E_2 \rightarrow \mathbb{C} \times (\mathbb{C} \setminus \{0\})$; it follows that, for any edge $\mathbf{e} \subset \mathbb{C}$, the 2-string braid group $B_{\partial\mathbf{e}}$ is infinite cyclic with a preferred generator, say $\sigma_{\mathbf{e}}$, which of course depends only on $\partial\mathbf{e}$. For $n \geq 2$, if $X \in E_n$ and $X \cap \mathbf{e} = \partial\mathbf{e}$, then there is a natural injection $\iota_{\mathbf{e};X} : B_{\partial\mathbf{e}} \rightarrow B_X$, which depends only on the isotopy class of \mathbf{e} (rel. $\partial\mathbf{e}$) in $\mathbb{C} \setminus (X \setminus \mathbf{e})$. A *positive* X -band is any element $\sigma_{\mathbf{e};X} := \iota_{\mathbf{e};X}(\sigma_{\mathbf{e}}) \in B_X$. (When X is understood, or irrelevant, $\sigma_{\mathbf{e};X}$ may be abusively abbreviated to $\sigma_{\mathbf{e}}$.) Any two positive X -bands are conjugate in B_X . The inverse of a positive X -band is a *negative* X -band. Write $|\sigma_{\mathbf{e};X}^{\pm 1}| := \sigma_{\mathbf{e};X}$.

In any group G , let $[g, h] := ghg^{-1}h^{-1}$ (resp., $\lll g, h \rrr := ghgh^{-1}g^{-1}h^{-1}$) denote the *commutator* (resp., the *yangbaxter*) of $g, h \in G$.

Lemma 5.2.1. *Let $X \in E_n$. Let $\mathbf{e}, \mathbf{f} \subset \mathbb{C}$ be two edges with $X \cap \mathbf{e} = \partial\mathbf{e}$, $X \cap \mathbf{f} = \partial\mathbf{f}$. If $\mathbf{e} \cap \mathbf{f} = \emptyset$ (resp., $\mathbf{e} \cap \mathbf{f} = \{x\} \subset \partial\mathbf{e} \cap \partial\mathbf{f}$), then $[\sigma_{\mathbf{e};X}, \sigma_{\mathbf{f};X}] = o_X$ (resp., $\lll \sigma_{\mathbf{e};X}, \sigma_{\mathbf{f};X} \rrr = o_X$).*

Proof. Geometrically obvious (trivially so for the commutator, slightly less trivially for the yangbaxter). \square

Corollary 5.2.2. *Let $\mathcal{T} \subset \mathbb{C}$ be a planar tree. The positive $V(\mathcal{T})$ -bands $\sigma_{\mathbf{e};V(\mathcal{T})}$, $\mathbf{e} \in E(\mathcal{T})$, generate $B_{V(\mathcal{T})}$. If $\mathbf{e} \cap \mathbf{f} = \emptyset$ (resp., $\mathbf{e} \cap \mathbf{f} = \{z\}$, $z \in V(\mathcal{T})$), then $[\sigma_{\mathbf{e};V(\mathcal{T})}, \sigma_{\mathbf{f};V(\mathcal{T})}] = o_{V(\mathcal{T})}$ (resp., $\lll \sigma_{\mathbf{e};V(\mathcal{T})}, \sigma_{\mathbf{f};V(\mathcal{T})} \rrr = o_{V(\mathcal{T})}$).* \square

Call the $V(\mathcal{T})$ -bands $\sigma_{\mathbf{e};V(\mathcal{T})}$, $\mathbf{e} \in E(\mathcal{T})$, the \mathcal{T} -generators of $B_{V(\mathcal{T})}$.

Remark 5.2.3. Corollary 5.2.2 asserts that the braid group $B_{V(\mathcal{T})}$ is a quotient of

$$\text{gp} \left(\sigma_{\mathbf{e}}, \mathbf{e} \in E(\mathcal{T}) \mid \begin{array}{ll} [\sigma_{\mathbf{e}}, \sigma_{\mathbf{f}}] & \text{if } \mathbf{e} \cap \mathbf{f} = \emptyset, \\ \lll \sigma_{\mathbf{e}}, \sigma_{\mathbf{f}} \rrr & \text{if } \mathbf{e} \cap \mathbf{f} = \{z\} \end{array} \right);$$

it does not assert that these groups are identical, and in fact they are easily seen to be so iff \mathcal{T} is linear.

5.3. Embedded band representations and \mathcal{T} -bandwords. Let $X \subset \mathbb{R}$ be finite. If $\mathbf{e} \subset \mathbb{C}_-$ is a proper edge with $\partial\mathbf{e} = \{p, q\} \subset X$, then $\sigma_{\mathbf{e};X} \in B_X$ depends only on $\{p, q\}$; write $\sigma_{p,q;X} := \sigma_{\mathbf{e};X}$ and call $\sigma_{p,q;X}^{\pm 1}$ an *embedded* X -band. If $X' \subset X$, then there is a well-defined injective homomorphism $\iota_{X';X} : B_{X'} \rightarrow B_X$ such that $\iota_{X';X}(\sigma_{p,q;X'}) = \sigma_{p,q;X}$ for all $p, q \in X'$ with $p \neq q$; this justifies the notation $\sigma_{p,q} := \sigma_{p,q;X}$.

Proposition 5.3.1. (1) *If $\{p, q\}$ and $\{r, s\}$ unlink then $\sigma_{p,q}\sigma_{r,s} = \sigma_{r,s}\sigma_{p,q}$.*
(2) *If $p < q < r$ then $\sigma_{p,q}\sigma_{q,r}^{\pm 1} = \sigma_{p,r}^{\pm 1}\sigma_{p,q}$.*

Proof. Immediate from 5.2.1. \square

An *embedded X -band representation* is a word $\vec{b} =: (b(1), \dots, b(k))$ such that each $b(s)$ is an embedded X -band; for $k = 1$ write $\vec{b} = b(1)$ instead of $\vec{b} = (b(1))$. The *concatenation* of \vec{b} with $\vec{b}' =: (b'(1), \dots, b'(\ell))$ is $\vec{b} \frown$

$\vec{b}' := (b(1), \dots, b(k), b'(1), \dots, b'(\ell))$. The *braid of \vec{b}* is $\beta(\vec{b}) := b(1) \cdots b(k) \in B_X$. An embedded X -band representation of length k determines (and is determined by) a map $(i_{\vec{b}}, j_{\vec{b}}, \varepsilon_{\vec{b}}) : \mathbf{k} \rightarrow X \times X \times \{+, -\}$ with $i_{\vec{b}} < j_{\vec{b}}$, such that $b(s) = \sigma_{i_{\vec{b}}(s), j_{\vec{b}}(s); X}^{\varepsilon_{\vec{b}}(s)1}$. Extend $\iota_{X'; X}$ to embedded band representations termwise.

Let \mathcal{T} be an espalier with $V(\mathcal{T}) = X$, so the \mathcal{T} -generators of B_X are embedded X -bands. A \mathcal{T} -*bandword* is an embedded X -band representation \vec{b} such that each $|b(s)|$ is a \mathcal{T} -generator. Let \vec{b} be a \mathcal{T} -bandword. Say \vec{b} is **e-strict** if $\{s : |b(s)| = \sigma_{\mathbf{e}; X}\} \neq \emptyset$, and *strict* if it is **e-strict** for every $\mathbf{e} \in E(\mathcal{T})$. Say \vec{b} is **e-positive** (resp., **e-negative**) if \vec{b} is **e-strict** and $\varepsilon_{\vec{b}}|_{\{s : |b(s)| = \sigma_{\mathbf{e}; X}\}}$ is the constant $+$ (resp., the constant $-$); say \vec{b} is *positive* (resp., *homogeneous*) if, for every $\mathbf{e} \in E(\mathcal{T})$, \vec{b} is **e-positive** (resp., either **e-positive** or **e-negative**).

Remarks 5.3.2. (1) Embedded $\mathcal{J}_{\mathbf{n}}$ -band representations are “embedded band representations in $B_{\mathbf{n}}$ ” as defined in [13]. The $\mathcal{J}_{\mathbf{n}}$ -generator $\sigma_{i, i+1; \mathbf{n}}$ is the standard generator σ_i of $B_{\mathbf{n}} = B_n$, and an $\mathcal{J}_{\mathbf{n}}$ -bandword is essentially a *braid word* in B_n in the usual sense, [2, p. 70 ff.], [14]. The definitions of positive and homogeneous \mathcal{T} -bandwords extend to an arbitrary espalier \mathcal{T} what is in effect the established usage for $\mathcal{T} = \mathcal{J}_{\mathbf{n}}$, cf. [2, 22, 15, 16]. (2) Of course the set of all $\binom{n}{2}$ positive embedded $\mathcal{J}_{\mathbf{n}}$ -bands generates B_n . In [1], Birman, Ko, and Lee show that the group with these generators, and the relations given in 5.3.1, is in fact B_n (rather than being strictly larger, cf. 5.2.3); they give interesting applications to algorithms for the word and conjugacy problems.

5.4. Braided Seifert surfaces and \mathcal{T} -bandword surfaces. A Seifert surface $S \subset \mathbb{C} \times \mathbb{R}$ is *braided* (resp., a *\mathcal{T} -bandword surface*) if S has a handle decomposition (2.2.1) with $X, U \subset \mathbb{R}$, satisfying 5.4.1–5.4.4 (resp., 5.4.1–5.4.5).

5.4.1. $S \cap \mathbb{C}_+ \times \mathbb{R} = S^{(0)}$ and $S \cap \mathbb{C}_- \times \mathbb{R} = S^{(1)}$.

5.4.2. $\text{Re}(h_x^{(0)}) = \{x\}$, and $\partial h_x^{(0)} \cap \{x\} \times \mathbb{R}$ is a single boundary arc of $\partial h_x^{(0)}$ on which $\partial h_x^{(0)}$ induces the same orientation as that induced from the orientation of $\{x\} \times \mathbb{R} \subset \mathbb{C} \times \mathbb{R}$.

5.4.3. $u \in \text{Int}(\text{pr}_2(h_u^{(1)})) \subset \mathbb{R}$, and the closed intervals $\text{pr}_2(h_u^{(1)})$, $u \in U$, are pairwise disjoint.

5.4.4. $\text{pr}_2|_{h_u^{(1)}} : h_u^{(1)} \rightarrow \mathbb{R}$ is Morse with exactly one (interior) critical point, of index 1 and critical value u , whence $h_u^{(1)} \cap \mathbb{C}_- \times \{u\}$ is the union of a transverse arc $\tau(h_u^{(1)})$ and a core arc $\kappa(h_u^{(1)})$ intersecting transversely at one point (the critical point).

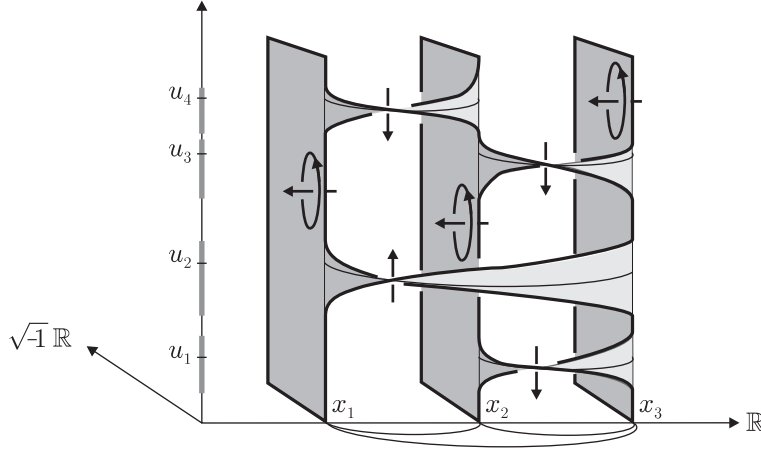

FIGURE 10. A braided surface in $\mathbb{C} \times \mathbb{R}$, embellished with normal vectors, core arcs, projections of the core arcs into $\mathbb{C}_- \times \{0\}$, and projections of the 1-handles into $\{0\} \times \mathbb{R}$.

5.4.5. There is an espalier \mathcal{T} with $V(\mathcal{T}) = X$ and $\text{pr}_1(\kappa(h_u^{(1)})) \in E(\mathcal{T})$ for $u \in U$.

Given 5.4.1–5.4.4 (resp., 5.4.1–5.4.5), it is easy to extract an embedded X -band representation (resp., a \mathcal{T} -bandword) \vec{b}_S : if $U =: \{u_1, \dots, u_k\}$, $u_1 < \dots < u_k$, then set $\{i_{\vec{b}_S}(s), j_{\vec{b}_S}(s)\} := \partial \text{pr}_1(\kappa(h_{u_s}^{(1)}))$ and $\varepsilon_{\vec{b}_S}(s) := \pm$ if the positive normal vector to S at the critical point of $\text{pr}_2|_{h_{u_s}^{(1)}}$ is a positive multiple of $\pm D \text{pr}_2$. Clearly, $\vec{b}_S = \vec{b}_{S'}$ iff S and S' are isotopic through braided Seifert surfaces (resp., \mathcal{T} -bandword surfaces), and every band representation (resp., \mathcal{T} -bandword) is \vec{b}_S for some braided Seifert surface (resp., \mathcal{T} -bandword surface) S . Write $S = S(\vec{b})$ when $\vec{b} = \vec{b}_S$. Note that a \mathcal{T} -bandword surface $S = S(\vec{b})$ determines \mathcal{T} iff S is connected iff \vec{b} is strict.

Figure 10 illustrates a braided surface $S(\vec{b})$ with three 0-handles and four 1-handles, which evidently fails to satisfy 5.4.5. Deletion of the first and third, or the second, or the fourth 1-handle from $S(\vec{b})$, produces a \mathcal{T} -bandword surface (for various espaliers \mathcal{T} with $V(\mathcal{T}) = \{x_1, x_2, x_3\}$).

For any braided Seifert surface $S(\vec{b})$, the projection $(\text{Re}, \text{pr}_2)(S(\vec{b})) \cap \mathbb{C}_- \times \mathbb{R} \subset \mathbb{R} \times \mathbb{R}$ becomes a *braid diagram* for $\beta(\vec{b})$ once it is embellished in the usual way with the correct crossings at its k doublepoints. It is only slightly abusive to conflate $\partial S(\vec{b})$ with the *closed braid* $\widehat{\beta}(\vec{b})$. (In fact, $\partial S(\vec{b})$ and $\widehat{\beta}(\vec{b})$ have the same link type, and it is easy to choose a braid axis $A \subset \text{Int}(\mathbb{C}_+) \times \mathbb{R}$ and well-positioned 0-handles $h_u^{(0)} \subset S(\vec{b})$ so that $\partial S(\vec{b})$ actually is a closed braid.)

Call a braided Seifert surface S *standardized* if $X = \mathbf{n}$, $U = \mathbf{k}$. Every isotopy class of braided Seifert surfaces has a standardized representative.

It is, however, convenient not to be limited to standardized braided Seifert surfaces.

Remark 5.4.6. Every Seifert surface is isotopic to a braided Seifert surface [13]. Not every Seifert surface is isotopic to a \mathcal{T} -bandword surface: e.g., it is easy to see that if \vec{b} is a strict \mathcal{T} -bandword then $\pi_1(S^3 \setminus S(\vec{b}); *)$ is free.

5.5. Elementary moves of braided and \mathcal{T} -bandword surfaces. Given $S = S(\vec{b})$ satisfying 5.4.1–5.4.4, if $\Phi_{\vec{b}} := (\text{Re}, \text{pr}_2)(G_{\vec{b}}) \subset \mathbb{R} \times \mathbb{R}$ is the projection of $G_{\vec{b}} := \bigcup_{x \in X} (h_x^{(0)} \cap \mathbb{R} \times \mathbb{R}) \cup \bigcup_{u \in U} \kappa(h_u^{(1)}) \subset S(\vec{b}) \cap (X \times \mathbb{R} \cup U \times \mathbb{C}_-)$, then $(\Phi_{\vec{b}}, \varepsilon_{\vec{b}})$ is a *charged fence diagram* (with *graph* $G_{\vec{b}}$), as described in [17] and [18] (where $S(\vec{b})$ was denoted by $S[i, j, \varepsilon]$, with $i = i_{\vec{b}}$ and so on). Figure 11 (adapted from [18], Figures 2 and 3) uses fence diagrams (with the charge on a wire indicated, where necessary, by a crook at its right end) to illustrate several elementary moves, each of which replaces a braided Seifert surface $S(\vec{b})$ by an isotopic braided Seifert surface $S(\vec{b}')$ having a different standardization. These moves can also be described in the language and notation of embedded X -band representations, as follows.

5.5.1. Let $p \in X$, $q \in X' := X \setminus \{p\}$. Let \vec{b}'_0, \vec{b}'_1 be embedded X' -band representations, $\vec{b}' := \vec{b}'_0 \frown \vec{b}'_1$. Say $\vec{b} := \iota_{X'; X}(\vec{b}'_0) \frown \sigma_{p,q; X}^{\pm 1} \frown \iota_{X'; X}(\vec{b}'_1)$ is obtained from \vec{b}' by an *inflation* of sign \pm , and that \vec{b}' is obtained from \vec{b} by a *deflation*. Algebraically, $\beta(\vec{b})$ is obtained from $\beta(\vec{b}')$ by an insignificant generalization of that “Markov move” [2] which increases braid index by 1.

5.5.2. Let $p, q, r, s \in X =: X'$ be such that $\{p, q\}$ and $\{r, s\}$ unlink. Let \vec{b}_0, \vec{b}_1 be embedded X -band representations. Say $\vec{b}' := \vec{b}_0 \frown (\sigma_{p,q}^{\pm 01}, \sigma_{r,s}^{\pm 11}) \frown \vec{b}_1$ is obtained from $\vec{b} := \vec{b}_0 \frown (\sigma_{r,s}^{\pm 11}, \sigma_{p,q}^{\pm 01}) \frown \vec{b}_1$ by a *slip*. Algebraically, $\beta(\vec{b})$ is obtained from $\beta(\vec{b}')$ by an application of 5.2.1(1).

5.5.3. Let $p, q, r \in X =: X'$ be such that $p < q < r$. Let \vec{b}_0, \vec{b}_1 be embedded X -band representations. (A) Say that $\vec{b}' := \vec{b}_0 \frown (\sigma_{q,r}, \sigma_{p,r}^{\pm 1}) \frown \vec{b}_1$ (resp., $\vec{b}' := \vec{b}_0 \frown (\sigma_{p,q}^{-1}, \sigma_{p,r}^{\pm 1}) \frown \vec{b}_1$) is obtained from $\vec{b} := \vec{b}_0 \frown (\sigma_{p,q}^{\pm 1}, \sigma_{q,r}) \frown \vec{b}_1$ (resp., $\vec{b} := \vec{b}_0 \frown (\sigma_{q,r}^{\pm 1}, \sigma_{p,r}^{-1}) \frown \vec{b}_1$) by a *straight slide up*. Call the inverse to a straight slide up a *bent slide down*. (B) Say $\vec{b}' := \vec{b}_0 \frown (\sigma_{p,r}^{\pm 1}, \sigma_{p,q}) \frown \vec{b}_1$ (resp., $\vec{b}' := \vec{b}_0 \frown (\sigma_{p,r}^{\pm 1}, \sigma_{q,r}^{-1}) \frown \vec{b}_1$) is obtained from $\vec{b} := \vec{b}_0 \frown (\sigma_{p,q}, \sigma_{q,r}^{\pm 1}) \frown \vec{b}_1$ (resp., $\vec{b} := \vec{b}_0 \frown (\sigma_{q,r}^{-1}, \sigma_{p,q}^{\pm 1}) \frown \vec{b}_1$) by a *straight slide down*. Call the inverse to a straight slide down a *bent slide up*. (C) Say $\vec{b}' := \vec{b}_0 \frown (\sigma_{p,r}, \sigma_{p,q}^{\pm 1}) \frown \vec{b}_1$ (resp., $\vec{b}' := \vec{b}_0 \frown (\sigma_{p,r}^{-1}, \sigma_{q,r}^{\pm 1}) \frown \vec{b}_1$) is obtained from $\vec{b}_0 \frown (\sigma_{q,r}^{\pm 1}, \sigma_{p,r}) \frown \vec{b}_1$ (resp., $\vec{b}_0 \frown (\sigma_{p,q}^{\pm 1}, \sigma_{p,r}^{-1}) \frown \vec{b}_1$) by a *doubly-bent slide up*. Call the inverse to a doubly-bent slide up a *doubly-bent slide down*. Algebraically, in all these cases, $\beta(\vec{b})$ is obtained from $\beta(\vec{b}')$ by an application of 5.2.1(2).

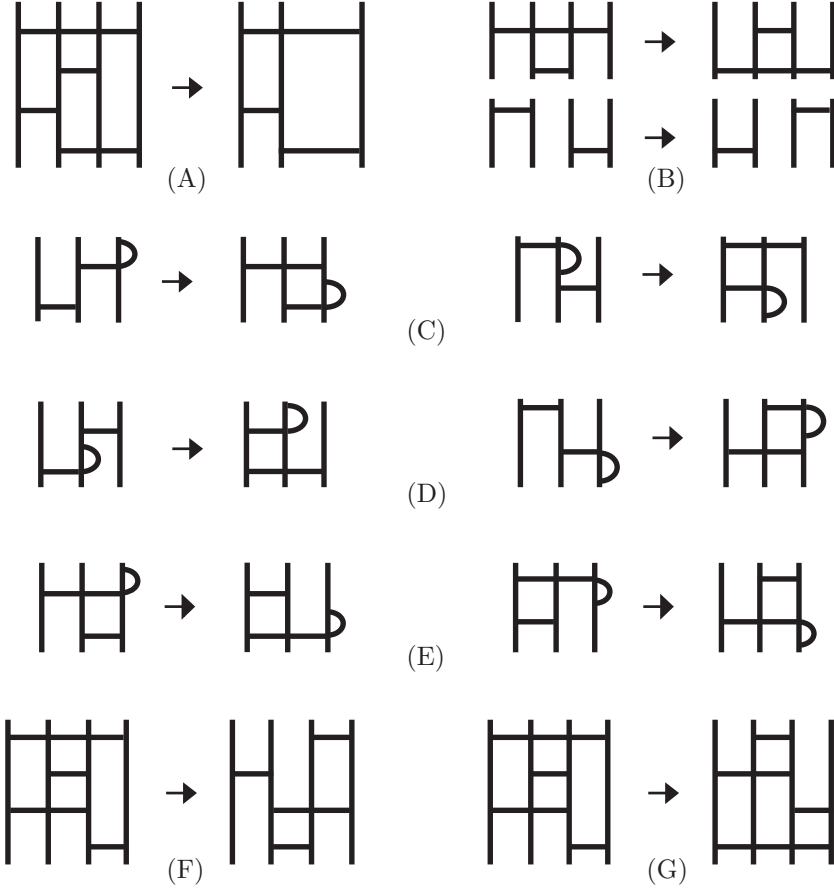

FIGURE 11. (A) A deflation. (B) Two slips. (C) Two straight slides up. (D) Two straight slides down. (E) Two doubly-bent slides up. (F) A twirl. (G) A turn.

5.5.4. Let $x' > \max X$, $X' := X \setminus \{\min X\} \cup \{x'\}$. Define $f : X \rightarrow X'$ by $f(x) = x$ for $x \in X \cap X'$, $f(\min X) = x'$. Let \vec{b} be an embedded X -band representation. Define \vec{b}' by setting $\vec{b}'(s) = \sigma_{f(p),f(q);X'}^{\pm 1}$ when $\vec{b}(s) = \sigma_{p,q;X}^{\pm 1}$. Say \vec{b}' is obtained from \vec{b} by a *twirl*. Algebraically, the standardization of $\beta(\vec{b}')$ (in $B_{\text{card}(X)}$) is obtained from the standardization of $\beta(\vec{b})$ by conjugation with $\sigma_{n-1}\sigma_{n-2}\cdots\sigma_1$.

5.5.5. Let \vec{b} be an embedded X -band representation, $X' = X$. Say $\vec{b}' := (b(k), b(1), \dots, b(k-1))$ is obtained from \vec{b} by a *turn*. Algebraically, $\beta(\vec{b}')$ is obtained from $\beta(\vec{b})$ by conjugation with the embedded band $b(k)$.

Proposition 5.5.6. *If \vec{b}' is obtained from an embedded X -band representation \vec{b} by an inflation, a deflation, slip, slide (straight, bent, or doubly-bent;*

up or down), twirl, or turn, then \vec{b}' is an embedded X' -representation, the closed braid $\widehat{\beta}(\vec{b}')$ is isotopic to $\widehat{\beta}(\vec{b})$, and in fact the braided Seifert surface $S(\vec{b}')$ is isotopic to $S(\vec{b})$.

Proof. Certainly \vec{b}' is an embedded X' -band representation. That $\widehat{\beta}(\vec{b}')$ is isotopic to $\widehat{\beta}(\vec{b})$ follows, in light of the algebraic interpretations of 5.5.1–5.5.5, from (the easy direction of) Markov’s Theorem [2]; of course it also follows from the final claim, about braided Seifert surfaces, which is established by observing that in each case the elementary move from \vec{b}' to \vec{b} corresponds to an elementary move, preserving 5.4.1–5.4.4, on the ordered handle decomposition (2.2.1) of $S(\vec{b})$. Specifically: an inflation (resp., a deflation) corresponds to adjoining (resp., removing) a new 0-handle and a new 1-handle which attaches it to the rest of the surface; a slip corresponds to transposing the order in which two adjacent 1-handles are attached to four suitably placed 0-handles; the various slides are, precisely, handle slides of one 1-handle over another suitably placed 1-handle; and a twirl (resp., a turn) consists essentially of a cyclic reordering of the index sets of the 0-handles (resp., the 1-handles) of (2.2.1). In turn, each of these moves on (2.2.1) corresponds, in a standard way, to an isotopy from $S(\vec{b})$ to $S(\vec{b}')$. \square

Remark 5.5.7. A more general notion of slide was introduced in [13], in the context of Seifert ribbons and their corresponding (not necessarily embedded) band representations. The straight, bent, and doubly-bent slides defined above are those which preserve embeddedness and so are suitable in the present context of Seifert surfaces.

Historical note 5.5.8. It should have been mentioned in [17] or [18] that the first published appearance of fences (and certainly the first time I saw them) may well have been c. 1959, in one of Martin Gardner’s “Mathematical Games” columns in *Scientific American*, reprinted as Chapter 2, “Group Theory and Braids”, of [10]. Gardner refers to them there as “vertical lines and shuttles”, and includes, as an application, a drinking game for computer programmers.

5.6. Moves of espaliers; more isotopies of \mathcal{T} -bandword surfaces.

Let \mathcal{T} be an espalier. Several elementary moves, with obvious similarities to the identically named moves on braided Seifert surfaces (or bandwords) described in 5.5, may be applied to \mathcal{T} to produce another espalier \mathcal{T}' .

5.6.1. Let $\mathbf{e} \in E(\mathcal{T})$ be such that $q \in \partial\mathbf{e} \cap V_{\text{end}}(\mathcal{T})$. Let $V(\mathcal{T}') := V(\mathcal{T}) \setminus \{q\}$, $E(\mathcal{T}') := E(\mathcal{T}) \setminus \{\mathbf{e}\}$. Say \mathcal{T}' is obtained from \mathcal{T} by a *deflation* and that \mathcal{T} is obtained from \mathcal{T}' by an *inflation*.

5.6.2. Let $\mathbf{e}_0 \in E(\mathcal{T})$, $\partial\mathbf{e}_0 =: \{p, q\}$, $\{\mathbf{e}_0, \mathbf{e}_1, \dots, \mathbf{e}_r\} := \{\mathbf{e} \in E(\mathcal{T}) : q \in \partial\mathbf{e}\}$. There exist proper edges $\mathbf{e}'_1, \dots, \mathbf{e}'_r \subset C_-$ with $\partial\mathbf{e}'_s = \partial\mathbf{e}_s \setminus \{q\} \cup \{p\}$, $s = 1, \dots, r$, such that, if $V(\mathcal{T}') := V(\mathcal{T})$, $E(\mathcal{T}') := E(\mathcal{T}) \setminus \{\mathbf{e}_1, \dots, \mathbf{e}_r\} \cup$

$\{\mathbf{e}'_1, \dots, \mathbf{e}'_r\}$, then \mathcal{T}' is an espalier. If $p < q$ (resp., $q < p$), then say \mathcal{T}' is obtained from \mathcal{T} by a *slide left* (resp., a *slide right*) *along* \mathbf{e}_0 , and—of course—that \mathcal{T} is obtained from \mathcal{T}' by a slide right (resp., a slide left) along \mathbf{e}_0 .

5.6.3. Let $q > \max V(\mathcal{T})$. Let $\{\mathbf{e}_1, \dots, \mathbf{e}_r\} := \{\mathbf{e} \in E(\mathcal{T}) : \min V(\mathcal{T}) \in \partial \mathbf{e}\}$. There exist proper edges $\mathbf{e}'_1, \dots, \mathbf{e}'_r \subset \mathbb{C}_-$ with $\partial \mathbf{e}'_s = \partial \mathbf{e}_s \setminus \{\min V(\mathcal{T})\} \cup \{q\}$, $s = 1, \dots, r$, such that, if $V(\mathcal{T}') := V(\mathcal{T})$, $E(\mathcal{T}') := E(\mathcal{T}) \setminus \{\mathbf{e}_1, \dots, \mathbf{e}_r\} \cup \{\mathbf{e}'_1, \dots, \mathbf{e}'_r\}$, then \mathcal{T}' is an espalier. Say \mathcal{T}' is obtained from \mathcal{T} by a *twirl*.

Lemma 5.6.4. *If \vec{b}' is obtained from a \mathcal{T} -bandword \vec{b} by an inflation (resp., a deflation; a slip; a twirl; a turn), then \vec{b}' is a \mathcal{T}' -bandword, where \mathcal{T}' is obtained from \mathcal{T} by an inflation (resp., a deflation; doing nothing; a twirl; doing nothing). \square*

In contradistinction to 5.6.4, if \vec{b}' is obtained from \vec{b} by applying a slide (straight, bent, or doubly-bent; up or down), then (with trivial exceptions) the embedded $V(\mathcal{T})$ -band representation \vec{b}' is not a \mathcal{T}' -bandword for any espalier \mathcal{T}' , in particular not for any \mathcal{T}' produced from \mathcal{T} by a slide. It is nevertheless the case that for certain \mathcal{T} -bandwords \vec{b} , if an appropriate sequence of two or more slides, with slips interspersed as necessary, is applied to \vec{b} , then the result is a \mathcal{T}' -bandword \vec{b}' , where \mathcal{T}' is produced from \mathcal{T} by a slide. Figure 12 illustrates such a multiple slip-slide of bandword surfaces covering a slide of espaliers; on each side of the figure, the upper part is a fence diagram $(\text{Re}, \text{pr}_2)(G)$ (with slight distortions, as in Figure 11, to indicate charges) derived from the graph G on the bandword surface, while the lower part is the espalier $\text{pr}_1(G)$.

6. PROOF OF THE MAIN THEOREM

6.1. Characterization of Hopf-plumbed baskets. Write $\mathcal{T} \prec \mathcal{T}'$ in case \mathcal{T} and \mathcal{T}' are espaliers with $V(\mathcal{T}) = V(\mathcal{T}')$ and either

$$\text{card}(V_{\text{end}}(\mathcal{T})) < \text{card}(V_{\text{end}}(\mathcal{T}'))$$

or

$$\text{card}(V_{\text{end}}(\mathcal{T})) = \text{card}(V_{\text{end}}(\mathcal{T}')) \text{ and } \sum_{v \in V_{\text{end}}(\mathcal{T})} v < \sum_{v \in V_{\text{end}}(\mathcal{T}')} v.$$

Let \mathcal{T} be an espalier, \vec{b} a \mathcal{T} -bandword. Let \mathcal{T} be an espalier, \vec{b} a \mathcal{T} -bandword. Recall the definition of \mathcal{Y}_X from 5.1. The following lemma formalizes the assertion there that \mathcal{Y}_X is the most extreme star-like espalier with X as the set of 0-cells.

Lemma 6.1.1. $\mathcal{T} \prec \mathcal{Y}_{V(\mathcal{T})}$ iff $\mathcal{T} \neq \mathcal{Y}_{V(\mathcal{T})}$ iff $\max \partial \mathbf{e} \notin V_{\text{end}}(\mathcal{T})$ for some $\mathbf{e} \in E(\mathcal{T})$. \square

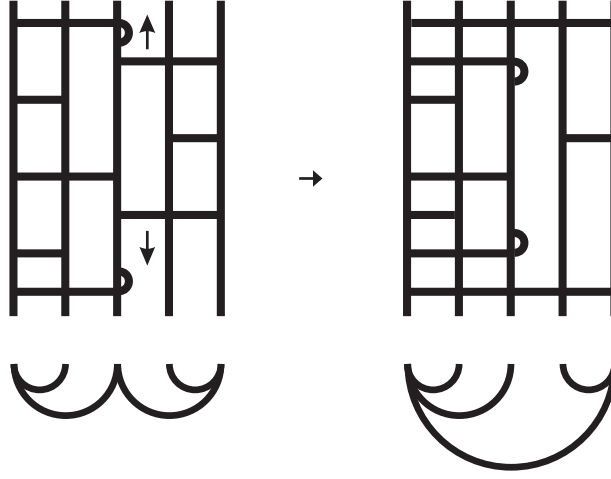

FIGURE 12. Above, partially charged fence diagrams for a \mathcal{T} -bandword surface $S(\vec{b})$ and a \mathcal{T}' -bandword surface $S(\vec{b}')$ isotopic to $S(\vec{b})$ by a slide up, a slip, and a slide down; below, \mathcal{T} and \mathcal{T}' .

Lemma 6.1.2. *If $\mathcal{T} \neq \mathcal{Y}_{\mathcal{V}(\mathcal{T})}$ and \vec{b} is homogeneous, then there exists \mathcal{T}' with $\mathcal{T} \prec \mathcal{T}'$ and a homogeneous \mathcal{T}' -bandword \vec{b}' with $S(\vec{b}') \cong S(\vec{b})$.*

Proof. By 6.1.1, there exists $\mathbf{e}_0 \in \mathbf{E}(\mathcal{T})$ such that $v := \max \partial \mathbf{e}_0 \notin \mathbf{V}_{\text{end}}(\mathcal{T})$ and for all $\mathbf{e} \in \mathbf{E}(\mathcal{T}) \setminus \{\mathbf{e}_0\}$, if $\max \partial \mathbf{e} = v$, then $\min \partial \mathbf{e} < \min \partial \mathbf{e}_0 =: u$. For $x \in \{u, v\}$, let $(\mathcal{T} - \mathbf{e}_0)_x$ denote the component of $\mathcal{T} \setminus \text{Int } \mathbf{e}_0$ which contains x . Clearly $(\mathcal{T} - \mathbf{e}_0)_u$ and $(\mathcal{T} - \mathbf{e}_0)_v$ are disjoint espaliers with $\mathbf{E}((\mathcal{T} - \mathbf{e}_0)_u) \cup \mathbf{E}((\mathcal{T} - \mathbf{e}_0)_v) = \mathbf{E}(\mathcal{T}) \setminus \{\mathbf{e}_0\}$, and $[\sigma_{\mathbf{f}}, \sigma_{\mathbf{g}}] = \sigma_{\mathcal{V}(\mathcal{T})}$ for all $\mathbf{f} \in \mathbf{E}((\mathcal{T} - \mathbf{e}_0)_u)$ and $\mathbf{g} \in \mathbf{E}((\mathcal{T} - \mathbf{e}_0)_v)$.

In case \vec{b} is $\sigma_{\mathbf{e}_0}$ -positive, an appropriate sequence of turns (5.5.5) and slips (5.5.2) converts \vec{b} to a homogeneous \mathcal{T} -bandword $\vec{b}'' = \vec{d}_1 \frown \vec{d}_2 \frown \cdots \frown \vec{d}_\ell$, where $\ell \geq 1$ and for $1 \leq s \leq \ell$, $\vec{d}_s = \sigma_{\mathbf{e}_0} \frown \vec{a}_s \frown \vec{c}_s$ with \vec{a}_s a $(\mathcal{T} - \mathbf{e}_0)_v$ -bandword and \vec{c}_s a $(\mathcal{T} - \mathbf{e}_0)_u$ -bandword; by 5.5.6, $S(\vec{b}'') \cong S(\vec{b})$. By the choice of \mathbf{e}_0 , if $\mathbf{f} \in \mathbf{E}((\mathcal{T} - \mathbf{e}_0)_v)$ and $v \in \partial \mathbf{f}$ then either $\min \partial \mathbf{f} = v$ or $\min \partial \mathbf{f} < u$, so a further sequence of slips and (straight and bent) slides down (5.5.3) converts \vec{b}'' to a homogeneous \mathcal{T}' -bandword \vec{b}' , with $S(\vec{b}') \cong S(\vec{b})$ (again by 5.5.6), where \mathcal{T}' is produced from \mathcal{T} by a slide right along \mathbf{e}_0 . (Figure 13 illustrates such a move from \vec{b} to \vec{b}' , in the style of Figure 12.) Now, if $u \in \mathbf{V}_{\text{end}}(\mathcal{T})$ (i.e., if $(\mathcal{T} - \mathbf{e}_0)_u = \{u\}$), then $\mathbf{V}_{\text{end}}(\mathcal{T}') = \mathbf{V}_{\text{end}}(\mathcal{T}) \setminus \{u\} \cup \{v\}$, whereas if $u \notin \mathbf{V}_{\text{end}}(\mathcal{T})$ then $\mathbf{V}_{\text{end}}(\mathcal{T}') = \mathbf{V}_{\text{end}}(\mathcal{T}) \cup \{v\}$; so in any case $\mathcal{T} \prec \mathcal{T}'$.

In case \vec{b} is $\sigma_{\mathbf{e}_0}$ -negative, the procedure is entirely similar, with $\vec{d}_s = \vec{a}_s \frown \vec{c}_s \frown \sigma_{\mathbf{e}_0}^{-1}$, and \vec{a}_s, \vec{c}_s as before; slides up take the place of slides down. The final products \vec{b}' and \mathcal{T}' are as in the first case; again $S(\vec{b}') \cong S(\vec{b})$ and $\mathcal{T} \prec \mathcal{T}'$. \square

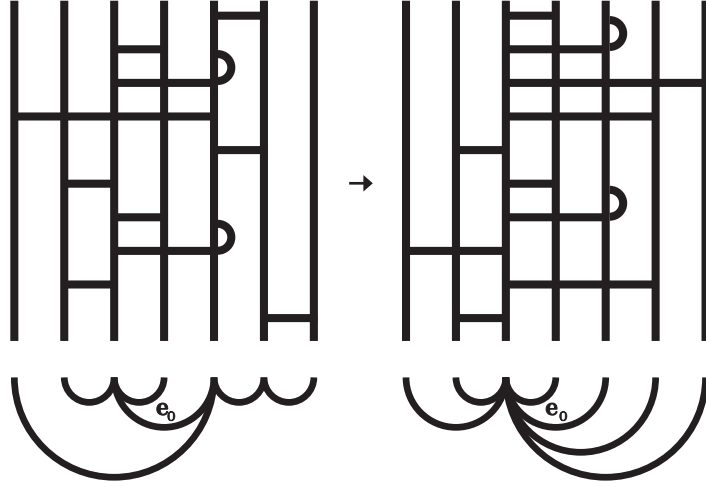

FIGURE 13. Above, partially charged fence diagrams for an \mathbf{e}_0 -positive \mathcal{T} -bandword surface $S(\vec{b})$ and an \mathbf{e}_0 -positive \mathcal{T}' -bandword surface $S(\vec{b}')$ isotopic to $S(\vec{b})$ by an inverse turn, six slips, and four slides down; below, \mathcal{T} and \mathcal{T}' .

Corollary 6.1.3. *If \vec{b} is homogeneous, then there is a homogeneous $\mathcal{Y}_{\mathbf{V}(\mathcal{T})}$ -bandword \vec{b}' with $S(\vec{b}') \cong S(\vec{b})$. \square*

For any \mathcal{T} -bandword \vec{a} , let $c(\vec{a}) := \sum_{\mathbf{e} \in \mathbf{E}(\mathcal{T})} |\text{card}(\{s : |a(s)| = \sigma_{\mathbf{e}}\}) - 2|$.

Lemma 6.1.4. *If $\mathcal{T} = \mathcal{Y}_X$ and \vec{b} is homogeneous, then for some X^* there is a homogeneous \mathcal{Y}_{X^*} -bandword \vec{b}^* such that $S(\vec{b}^*) \cong S(\vec{b})$ and $c(\vec{b}^*) = 0$.*

Proof. Since \vec{b} is strict, if $c(\vec{b}) > 0$ then either $\text{card}(\{s : |b(s)| = \sigma_{\mathbf{e}_0}\}) = 1$ for some $\mathbf{e}_0 \in \mathbf{E}(\mathcal{Y}_X)$, or $\text{card}(\{s : |b(s)| = \sigma_{\mathbf{e}_0}\}) \geq 3$ for some $\mathbf{e}_0 \in \mathbf{E}(\mathcal{Y}_X)$. In either case, let $v := \max \partial \mathbf{e}_0$, $u := \min \partial \mathbf{e}_0 = \min X$.

In the first case, there is a deflation (5.5.1) of \vec{b} to a homogeneous $\mathcal{Y}_{X'}$ -bandword \vec{b}' with $c(\vec{b}') = c(\vec{b}) - 1$, where $X' := X \setminus \{v\}$; by 5.5.6, $S(\vec{b}') \cong S(\vec{b})$. In the second case, choose $w \in]v, \min(X \cap]v, \infty[)$ and set $X' := X \cup \{w\}$. If \vec{b} is \mathbf{e}_0 -positive, then $\vec{b} = \vec{b}_0 \frown \sigma_{\mathbf{e}_0} \frown \vec{b}_1 \frown \sigma_{\mathbf{e}_0} \frown \vec{b}_2 \frown \sigma_{\mathbf{e}_0} \frown \vec{b}_3$ where $\sigma_{\mathbf{e}_0} = \sigma_{u,v}$ does not appear in \vec{b}_1 or \vec{b}_2 , and the sequence of moves

$$\begin{aligned}
\vec{b} &\rightarrow \vec{b}_0 \frown \sigma_{u,v} \frown \vec{b}_1 \frown \sigma_{u,v} \frown \sigma_{v,w} \frown \vec{b}_2 \frown \sigma_{u,v} \frown \vec{b}_3 && \text{by (5.5.1)} \\
&\rightarrow \vec{b}_0 \frown \sigma_{u,v} \frown \vec{b}_1 \frown \sigma_{v,w} \frown \sigma_{u,w} \frown \vec{b}_2 \frown \sigma_{u,v} \frown \vec{b}_3 && \text{by (5.5.3)} \\
&\rightarrow \vec{b}_0 \frown \sigma_{u,v} \frown \sigma_{v,w} \frown \vec{b}_1 \frown \sigma_{u,w} \frown \vec{b}_2 \frown \sigma_{u,v} \frown \vec{b}_3 && \text{by (5.5.2)} \\
&\rightarrow \vec{b}_0 \frown \sigma_{u,w} \frown \sigma_{u,v} \frown \vec{b}_1 \frown \sigma_{u,w} \frown \vec{b}_2 \frown \sigma_{u,v} \frown \vec{b}_3 := \vec{b}' && \text{by (5.5.3)}
\end{aligned}$$

converts \vec{b} to a homogeneous $\mathcal{Y}_{X'}$ -bandword \vec{b}' with $c(\vec{b}') = c(\vec{b}) - 1$, and $S(\vec{b}') \cong S(\vec{b})$ by 5.5.6; if \vec{b} is \mathbf{e}_0 -negative, a similar sequence of moves (an

inflation of sign $-$, a straight slide down, slips, and a straight slide up) has the same effect. Induction on $c(\vec{b})$ completes the proof. \square

Lemma 6.1.5. *If $\mathcal{T} = \mathcal{Y}_X$, \vec{b} is homogeneous, and $c(\vec{b}) = 0$, then $S(\vec{b})$ is a Hopf-plumbed basket with $\text{card}(X) - 1$ plumbands.*

Proof. Without loss of generality, take $S(\vec{b})$ to be standardized, so that $X = \mathbf{n}$ and $U = \mathbf{k}$. For $t = 2, \dots, n$, write $u(t) := \min j_{\vec{b}}^{-1}(t)$, $v(t) := \max j_{\vec{b}}^{-1}(t)$, and let α_t be a proper arc in $h_1^{(0)}$ joining $\kappa(h_{u(t)}^{(1)}) \cap \partial h_1^{(0)}$ to $\kappa(h_{v(t)}^{(1)}) \cap \partial h_1^{(0)}$. Evidently $h_{u(t)}^{(1)} \cup h_t^{(0)} \cup h_{v(t)}^{(1)} \cup N_{h_1^{(0)}}(\alpha_t)$ is a Hopf annulus $A(O_t, \varphi(t))$, where $\varphi(t) = -1$ (resp., 1) if \vec{b} is $\sigma_{1,t}$ -positive (resp., $\sigma_{1,t}$ -negative), and $S(\vec{b})$ is a Hopf-plumbed $h_1^{(0)}$ -basket with plumbing arcs α_t and plumbands $A(O_t, \varphi(t))$. \square

Theorem 6.1.6. (A) *If \mathcal{T} is an espalier and \vec{b} is a homogeneous \mathcal{T} -bandword, then $S(\vec{b})$ is a Hopf-plumbed basket.* (B) *If S is a Hopf-plumbed basket, then S is isotopic to $S(\vec{b})$ for some espalier \mathcal{T} and homogeneous \mathcal{T} -bandword \vec{b} .*

Proof. (A) follows directly from 6.1.2-6.1.5. The construction in the proof of 6.1.5, run in reverse, proves a more precise formulation of (B): if S is a Hopf-plumbed basket with $n - 1$ plumbands, then S is isotopic to $S(\vec{b})$, where \vec{b} is a homogeneous $\mathcal{Y}_{\mathbf{n}}$ -bandword with $c(\vec{b}) = 0$. \square

6.2. The rest of the Main Theorem. Again let \mathcal{T} be an espalier, \vec{b} a \mathcal{T} -bandword, and consider the handle decomposition (2.2.1) of $S(\vec{b})$, satisfying 5.4.1–5.4.5, with $X = \mathbf{V}(\mathcal{T})$.

Lemma 6.2.1. *If \vec{b} is not strict, then $S(\vec{b})$ is not connected.*

Proof. If $\mathbf{e} \in \mathbf{E}(\mathcal{T})$ and \vec{b} is not \mathbf{e} -strict, then the 0-handles $h_{\min \partial \mathbf{e}}^{(0)}$ and $h_{\max \partial \mathbf{e}}^{(0)}$ must lie in different components of $S(\vec{b})$. \square

Lemma 6.2.2. *If $X = \mathbf{2}$, so $\mathcal{T} = \mathcal{Y}_{\mathbf{2}}$, and \vec{b} is strict but not homogeneous, then both $S(\vec{b})$ and $-S(\vec{b})$ are top-compressible.*

Proof. Let $\vec{b} = (\sigma_1^{\varepsilon(1)1}, \dots, \sigma_1^{\varepsilon(k)1})$, $\varepsilon(s) \in \{+, -\}$, be strict but not homogeneous, so that $k \geq 2$ and there exists s with $\varepsilon(s) = -\varepsilon(s+1)$. If $\varepsilon(s) = +$ and $\varepsilon(s+1) = -$ (resp., $\varepsilon(s) = -$ and $\varepsilon(s+1) = +$), then the union of $\kappa(h_s^{(1)})$, $-\kappa(h_{s+1}^{(1)})$, and suitable proper arcs on $h_1^{(0)}$ and $h_2^{(0)}$ is the boundary of a top-compression disk for $S(\vec{b})$ (resp., $-S(\vec{b})$); Figure 14 illustrates these two cases. Up to turns (5.5.5) (which do not change the isotopy type of $S(\vec{b})$, 5.5.6), both cases occur, and so both $S(\vec{b})$ and $-S(\vec{b})$ are top-compressible. \square

Let $X_{\text{end}} := \mathbf{V}_{\text{end}}(\mathcal{T})$. Call $\mathbf{e} \in \mathbf{E}(\mathcal{T})$ a *terminal edge* of \mathcal{T} if $\partial \mathbf{e} \cap X_{\text{end}} \neq \emptyset$.



FIGURE 14. The boundaries of top-compression disks for $S(\dots, \sigma_1, \sigma_1^{-1}, \dots)$ and for $-S(\dots, \sigma_1^{-1}, \sigma_1, \dots)$.

Lemma 6.2.3. *If \mathcal{T} is arbitrary, and \vec{b} is strict but not homogeneous, then $S(\vec{b})$ is compressible.*

Proof. Let $n = \text{card}(X)$. The case $n = 1$ is vacuous. The case $n = 2$ follows from 6.2.2. Suppose $n > 2$. There exists a terminal edge \mathbf{e} of \mathcal{T} with $] \min \partial \mathbf{e}, \max \partial \mathbf{e}[\cap X = \emptyset$. Let $X' := \partial \mathbf{e}$, $X'' := X \setminus (X' \setminus X_{\text{end}}(\mathcal{T}))$, $U' := \{u \in U : \text{pr}_1(\kappa(h_u^{(1)})) = \mathbf{e}\}$, $U'' := U \setminus U'$, $S' = \bigcup_{x \in X'} h_x^{(0)} \cup \bigcup_{u \in U'} h_u^{(1)}$, $S'' = \bigcup_{x \in X''} h_x^{(0)} \cup \bigcup_{u \in U''} h_u^{(1)}$. Clearly $S' \cup S'' = S(\vec{b})$ and $S' \cap S'' = h_q^{(0)}$, where $\partial \mathbf{e} = \{p, q\}$, $p \in X_{\text{end}}(\mathcal{T})$, $q \notin X_{\text{end}}(\mathcal{T})$; further, if $q = \max \partial \mathbf{e}$ (resp., $q = \min \partial \mathbf{e}$), then (for appropriate choices of collars) $S' \setminus h_q^{(0)} \subset \text{Int top}(S'')$ and $S'' \setminus h_q^{(0)} \subset \text{Int bot}(S')$ (resp., $S' \setminus h_q^{(0)} \subset \text{Int bot}(S'')$ and $S'' \setminus h_q^{(0)} \subset \text{Int top}(S')$). Each of S' , S'' is evidently a braided Seifert surface in its own right: more precisely, $S' := S(\iota_{X', X}(\vec{c}))$ and $S'' := S(\iota_{X'', X}(\vec{d}))$, where \vec{c} is an \mathbf{e} -bandword and \vec{d} is a $(\mathcal{T} - \mathbf{e})_q$ -bandword. If \vec{b} is strict but not homogeneous, then both \vec{c} and \vec{d} are strict, and at least one of \vec{c} and \vec{d} is not homogeneous.

If \vec{c} is not homogeneous, and $q = \max \partial \mathbf{e}$ (resp., $q = \min \partial \mathbf{e}$), then (by 6.2.1) there exists a top-compression disk for S' (resp., $-S'$), which can be taken to be disjoint from S'' , and therefore to be a top-compression disk for $S(\vec{b})$ (resp., $-S(\vec{b})$).

If \vec{c} is homogeneous and \vec{d} is inhomogeneous, then S' is a Hopf-plumbed basket (by 6.1.5) and S'' is compressible (by induction on n). In fact, the proof of 6.1.4 is easily adapted to show that $S(\vec{b})$ has a Hopf basket S'' -presentation. By 3.2.1, if there exists a top-compression disk for S'' (resp., $-S''$), then there exists such a disk which is disjoint from $S' \setminus S''$, and is therefore also a top-compression disk for $S(\vec{b})$ (resp., $-S(\vec{b})$).

In any case, if \vec{b} is strict but not homogeneous then $S(\vec{b})$ is compressible. \square

Theorem 6.2.4. *The following are equivalent: (A) \vec{b} is homogeneous; (B) $S(\vec{b})$ is a Hopf-plumbed basket; (C) $S(\vec{b})$ is a fiber surface; (D) $S(\vec{b})$ is incompressible and connected.*

Proof. That (A) implies (B) is contained in Theorem 6. It is a standard fact ([22, 11, 12, 6]; 3.4) that any Hopf-plumbed surface is a fiber surface, so in particular (B) implies (C). It is likewise standard ([22, 7]; 2.4) that any fiber surface is incompressible and connected, so in particular (C) implies (D). Finally, by 6.2.1 and 6.2.3, not-(A) implies not-(D). \square

REFERENCES

- [1] Joan Birman, Ki Hyoungh Ko, and Sang Jin Lee, *A new approach to the word and conjugacy problems in the braid groups*, Adv. Math. **139** (1998), no. 2, 322–353.
- [2] Joan S. Birman, *Braids, links, and mapping class groups*, Princeton University Press, Princeton, N.J., 1974, Annals of Mathematics Studies, No. 82.
- [3] Michel Boileau and Lee Rudolph, *Stein fillings via branched covers and plumbing*, in preparation.
- [4] J. H. Conway, *An enumeration of knots and links, and some of their algebraic properties*, Computational Problems in Abstract Algebra (Proc. Conf., Oxford, 1967), Pergamon, Oxford, 1970, pp. 329–358.
- [5] David Eisenbud and Walter Neumann, *Three-dimensional link theory and invariants of plane curve singularities*, Princeton University Press, Princeton, N.J., 1985.
- [6] David Gabai, *Foliations and the topology of 3-manifolds*, J. Differential Geom. **18** (1983), no. 3, 445–503.
- [7] ———, *The Murasugi sum is a natural geometric operation*, Low-dimensional topology (San Francisco, Calif., 1981), Amer. Math. Soc., Providence, R.I., 1983, pp. 131–143.
- [8] ———, *The Murasugi sum is a natural geometric operation. II*, Combinatorial methods in topology and algebraic geometry (Rochester, N.Y., 1982), Amer. Math. Soc., Providence, R.I., 1985, pp. 93–100.
- [9] ———, *Genera of the arborescent links*, Mem. Amer. Math. Soc. **59** (1986), no. 339, i–viii and 1–98.
- [10] Martin Gardner, *Martin Gardner’s New Mathematical Diversions from Scientific American*, Simon and Schuster, New York, 1966.
- [11] John Harer, *How to construct all fibered knots and links*, Topology **21** (1982), no. 3, 263–280.
- [12] H. R. Morton, *Fibered knots with a given Alexander polynomial*, Knots, braids and singularities (Plans-sur-Bex, 1982), Enseignement Math., Geneva, 1983, pp. 205–222.
- [13] Lee Rudolph, *Braided surfaces and Seifert ribbons for closed braids*, Comment. Math. Helv. **58** (1983), no. 1, 1–37.
- [14] ———, *Constructions of quasipositive knots and links. I*, Knots, braids and singularities (Plans-sur-Bex, 1982), Univ. Genève, Geneva, 1983, pp. 233–245.
- [15] ———, *Some knot theory of complex plane curves*, Enseign. Math. (2) **29** (1983), no. 3-4, 185–208.
- [16] ———, *Mutually braided open books and new invariants of fibered links*, Braids (Santa Cruz, CA, 1986), Amer. Math. Soc., Providence, RI, 1988, pp. 657–673.
- [17] ———, *Quasipositive annuli. (Constructions of quasipositive knots and links. IV)*, J. Knot Theory Ramifications **1** (1992), no. 4, 451–466.
- [18] ———, *Quasipositive plumbing (Constructions of quasipositive knots and links. V)*, Proc. Amer. Math. Soc. **126** (1998), no. 1, 257–267.
- [19] Makoto Sakuma, *Minimal genus Seifert surfaces for special arborescent links*, Osaka J. Math. **31** (1994), no. 4, 861–905.
- [20] Herbert Seifert, *Über das Geschlecht von Knoten*, Math. Annalen **110** (1934), 571–592.
- [21] Laurent Siebenmann, *Exercices sur les nœuds rationnels*, mimeographed notes, Orsay, 1975.

- [22] John R. Stallings, *Constructions of fibred knots and links*, Algebraic and geometric topology (Proc. Sympos. Pure Math., Stanford Univ., Stanford, Calif., 1976), Part 2, Amer. Math. Soc., Providence, R.I., 1978, pp. 55–60.

DEPARTMENT OF MATHEMATICS, CLARK UNIVERSITY, WORCESTER MA 01610 USA
E-mail address: `lrudolph@black.clarku.edu`