

Alcove walks, Hecke algebras, spherical functions, crystals and column strict tableaux

Arun Ram
Department of Mathematics
University of Wisconsin
Madison, WI 53706
ram@math.wisc.edu

Dedicated to R. MacPherson on the occasion of his 60th birthday

1 Introduction

Together, Sections 2 and 5 of this paper form a self contained treatment of the theory of crystals and the path model. It is my hope that this will be useful to the many people who, over the years, have told me that they wished they understood crystals but have found the existing literature too daunting. One goal of the presentation here is to clarify the relationship between the general path model and the crystal operators of Lascoux and Schützenberger used in the type A case [LS]. More specifically, Section 2 is a basic pictorial exposition of Weyl groups and affine Weyl groups and Section 5 is an exposition of the theory of (a) symmetric functions, (b) crystals and (c) the path model which is designed for readers whose only background is the material in Section 2. These two sections can be read independently of Sections 3 and 4.

Sections 3 and 4 give an exposition of the affine Hecke algebra and recent results regarding the combinatorics of spherical functions on p-adic groups (Hall-Littlewood polynomials) using only the material in Section 2 as background. The q -analogue of the theory of crystals developed in Section 4 specializes to the path model version [Li1-3] of the “classical” crystal theory at $q^{-1} = 0$. This specialization property is “to be expected” since Macdonald’s formula for the spherical function specializes to the Weyl character formula at $q^{-1} = 0$. It is my hope that the presentation of the results will illustrate the close connection between the affine Hecke algebra, the path model, and the theory of crystals.

The motivation for this paper is the following. The classical path model is a combinatorial tool for working with crystal bases of integrable representations of symmetrizable Kac-Moody algebras, a generalization of column strict Young tableaux. The same combinatorics can be used to study the equivariant K-theory of the flag variety [PR] and this point provides a translation between the path model and the structure of the nil-affine Hecke algebra. Thus, conceptually,

$$\begin{aligned} \text{crystal bases} &= \text{the path model} \\ &= \text{the nil affine Hecke algebra} \\ &= \text{the } T\text{-equivariant } K\text{-theory of } G/B. \end{aligned}$$

The paper of Gaussent-Littelmann [GL] (see also the work of Kapovich-Millson in [KM]) indicated that there is a refined model which removes the ‘nil’ in this chain of equalities and models

the geometry of Kac-Moody groups over a local field. The result is the conceptual chain of equalities

$$\begin{aligned} \text{positively folded alcove walks} &= \text{geodesics in the affine building} \\ &= \text{the affine Hecke algebra} \\ &= \text{MV cycles in the loop Grassmanian.} \end{aligned}$$

The connection to the affine Hecke algebra and the approach to spherical functions for a p -adic group in [NR] was made concrete by C. Schwer [Sc] who told me that “the periodic Hecke module encodes the positively folded galleries”.

The main results of this paper are obtained by viewing the affine Hecke algebra in terms of a new construct, the alcove walk algebra. This combinatorics provides

- (a) a change of basis formula in the affine Hecke algebra which is an analogue of the change of basis formula for the nil affine Hecke algebra given in [GR],
- (b) a derivation of the combinatorial formula for the Hall-Littlewood polynomials in terms of monomials given by Schwer [Sc],
- (c) a derivation of the product formula for Hall-Littlewood polynomials given by Kapovich-Millson [KM] and Schwer [Sc],
- (d) a description of the restriction rule for Hall-Littlewood polynomials

in the same way that the theory of crystal bases gives expansions for Weyl characters (Schur functions) in terms of monomials and produces general “Littlewood-Richardson rules” for Weyl characters. The result in (a) is a generalization of a result given in Schwer in the same spirit as the $q^{-1} = 0$ result given in the paper of Lenart-Postnikov [LP]. Thus (a) generalizes both the result in [Sc] and the result in [LP]. Results (b) and (c) are all either explicit or implicit in [GL], [KM] and [Sc]. The result in (d) has not appeared in the literature before but it is an easy consequence of the combination of the techniques of [Sc] and the “crystal structure” on positively folded galleries implicit in [GL]. The q -crystal structure gives easy proofs of the results in (c) and (d).

Unfortunately, the limitations of time and space have not allowed me to provide an exposition of the connection between the alcove walk combinatorics and the geometry of the loop group (which is implicit in the affine Hecke algebra and explicit in [Mac], [BD], [GL], [KM] and [Sc]). Hopefully this will be done soon in a future paper.

Acknowledgments. I thank P. Littelmann for useful conversations and C. Schwer for teaching me the right way to think about positively folded galleries. I thank the National Science Foundation (grants DMS-0353038 and DMS-0097977), the Vilas Foundation and the Max-Planck-Institut für Mathematik for support of this work. I thank my hosts in Rome, C. DeConcini, C. Procesi and E. Strickland, for their hospitality during a sabbatical when the writing of this paper was completed. It is a pleasure to dedicate this paper to R. MacPherson. He is an inspiration and a role model.

2 The affine Weyl group

This section is a summary of the main facts and notations that are needed for working with the affine Weyl group \tilde{W} . The main point is that the elements of the affine Weyl group can be identified with alcoves via the bijection in (2.11).

Let $\mathfrak{h}_{\mathbb{R}}^*$ be a finite dimensional vector space over \mathbb{R} . A *reflection* is a diagonalizable element of $GL(\mathfrak{h}_{\mathbb{R}}^*)$ which has exactly one eigenvalue not equal to 1. A *lattice* is a free \mathbb{Z} -module. A *Weyl group* is a finite subgroup W of $GL(\mathfrak{h}_{\mathbb{R}}^*)$ which is

generated by reflections and acts on a lattice L in $\mathfrak{h}_{\mathbb{R}}^*$

such that $\mathfrak{h}_{\mathbb{R}}^* = L \otimes_{\mathbb{Z}} \mathbb{R}$. Let R^+ be an index set for the reflections in W so that, for $\alpha \in R^+$,

$$s_{\alpha} \text{ is the reflection in the hyperplane } H_{\alpha} = (\mathfrak{h}_{\mathbb{R}}^*)^{s_{\alpha}},$$

the fixed point space of the transformation s_{α} . The *chambers* are the connected components of the complement

$$\mathfrak{h}_{\mathbb{R}}^* \setminus \left(\bigcup_{\alpha \in R^+} H_{\alpha} \right)$$

of these hyperplanes in $\mathfrak{h}_{\mathbb{R}}^*$. These are fundamental regions for the action of W .

Let $\langle \cdot, \cdot \rangle$ be a nondegenerate W -invariant bilinear form on $\mathfrak{h}_{\mathbb{R}}^*$. Fix a chamber C and choose vectors $\alpha^{\vee} \in \mathfrak{h}_{\mathbb{R}}^*$ such that

$$C = \{x \in \mathfrak{h}_{\mathbb{R}}^* \mid \langle x, \alpha^{\vee} \rangle > 0\} \quad \text{and} \quad P \supseteq L \supseteq Q, \quad (2.1)$$

where

$$P = \{\lambda \in \mathfrak{h}_{\mathbb{R}}^* \mid \langle \lambda, \alpha^{\vee} \rangle \in \mathbb{Z}\} \quad \text{and} \quad Q = \sum_{\alpha \in R^+} \mathbb{Z}\alpha, \quad \text{where } \alpha = \frac{2\alpha^{\vee}}{\langle \alpha^{\vee}, \alpha^{\vee} \rangle}. \quad (2.2)$$

Pictorially,

$$\langle \lambda, \alpha^{\vee} \rangle \text{ is the distance from } \lambda \text{ to the hyperplane } H_{\alpha}.$$

The *alcoves* are the connected components of the complement

$$\mathfrak{h}_{\mathbb{R}}^* \setminus \left(\bigcup_{\substack{\alpha \in R^+ \\ j \in \mathbb{Z}}} H_{\alpha, j} \right) \quad \text{of the (affine) hyperplanes } H_{\alpha, j} = \{x \in \mathfrak{h}_{\mathbb{R}}^* \mid \langle x, \alpha^{\vee} \rangle = j\}$$

in $\mathfrak{h}_{\mathbb{R}}^*$. The *fundamental alcove* is the alcove

$$A \subseteq C \quad \text{such that} \quad 0 \in \overline{A}, \quad (2.3)$$

where \overline{A} is the closure of A . An example is the case of type C_2 , where the picture is

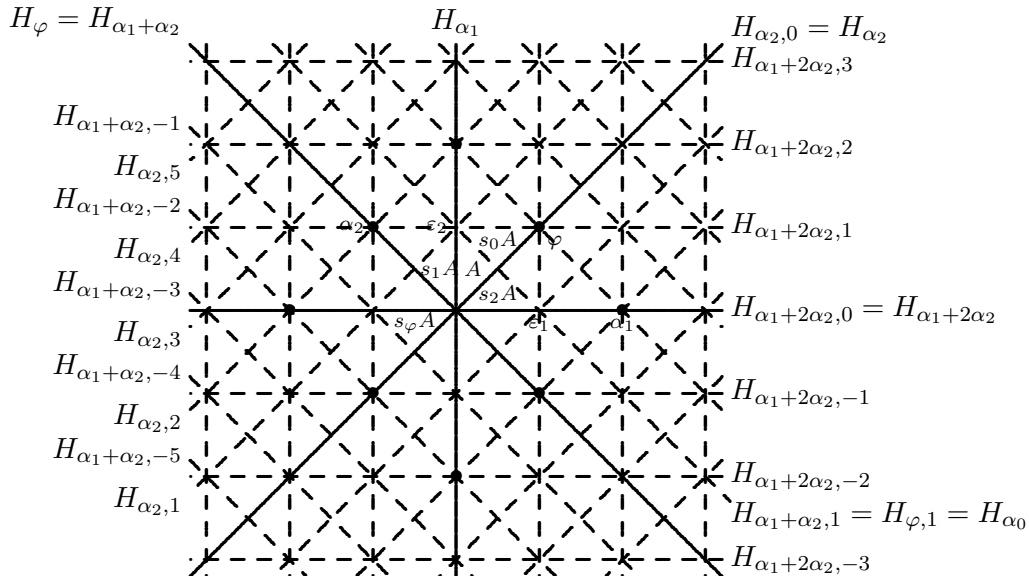

The *translation* in λ is the operator $t_\lambda: \mathfrak{h}_{\mathbb{R}}^* \rightarrow \mathfrak{h}_{\mathbb{R}}^*$ given by

$$t_\lambda(x) = \lambda + x, \quad \text{for } \lambda \in P, x \in \mathfrak{h}_{\mathbb{R}}^*. \quad (2.4)$$

The reflection $s_{\alpha,k}$ in the hyperplane $H_{\alpha,k}$ is given by

$$s_{\alpha,k} = t_{k\alpha}s_\alpha = s_\alpha t_{-k\alpha}. \quad (2.5)$$

The *extended affine Weyl group* is

$$\widetilde{W} = P \rtimes W = \{t_\lambda w \mid \lambda \in P, w \in W\} \quad \text{with} \quad wt_\lambda = t_{w\lambda}w. \quad (2.6)$$

Denote the walls of C by $H_{\alpha_1}, \dots, H_{\alpha_n}$ and extend this indexing so that

$$H_{\alpha_0}, \dots, H_{\alpha_n} \quad \text{are the walls of} \quad A,$$

the fundamental alcove. Then the *affine Weyl group*,

$$W_{\text{aff}} = Q \rtimes W \quad \text{is generated by } s_0, \dots, s_n, \quad (2.7)$$

the reflections in the hyperplanes $H_{\alpha_0}, \dots, H_{\alpha_n}$. Furthermore, A is a fundamental region for the action of W_{aff} on $\mathfrak{h}_{\mathbb{R}}^*$ and so there is a bijection

$$\begin{aligned} W_{\text{aff}} &\longrightarrow \{\text{alcoves in } \mathfrak{h}_{\mathbb{R}}^*\} \\ w &\longmapsto w^{-1}A. \end{aligned}$$

The *length* of $w \in \widetilde{W}$ is

$$\ell(w) = \text{number of hyperplanes between } A \text{ and } wA. \quad (2.8)$$

The difference between W_{aff} and \widetilde{W} is the group

$$\Omega = \widetilde{W}/W_{\text{aff}} \cong P/Q. \quad (2.9)$$

The group Ω is the set of elements of \widetilde{W} of length 0. An element of Ω acts on the fundamental alcove A by an automorphism. Its action on A induces a permutation of the walls of A , and hence a permutation of $0, 1, \dots, n$. If $g \in \Omega$ and $g \neq 1$ let ω_i be the image of the origin under the action of g on A . If s_j denotes the reflection in the j th wall of A and w_i denotes the longest element of the stabilizer W_{ω_i} of ω_i in W , then

$$gs_i g^{-1} = s_{g(i)} \quad \text{and} \quad gw_0 w_i = t_{\omega_i}. \quad (2.10)$$

The group \widetilde{W} acts freely on $\Omega \times \mathfrak{h}_{\mathbb{R}}^*$ ($|\Omega|$ copies of \mathbb{R}^n tiled by alcoves) so that $g^{-1}A$ is in the same spot as A except on the g th “sheet” of $\Omega \times \mathfrak{h}_{\mathbb{R}}^*$. It is helpful to think of the elements of Ω as the *deck transformations* which transfer between the sheets in $\Omega \times \mathfrak{h}_{\mathbb{R}}^*$. Then

$$\begin{aligned} \widetilde{W} &\longrightarrow \{\text{alcoves in } \Omega \times \mathfrak{h}_{\mathbb{R}}^*\} \\ w &\longmapsto w^{-1}A \end{aligned} \quad (2.11)$$

is a bijection. In type C_2 , the two sheets in $\Omega \times \mathfrak{h}_{\mathbb{R}}^*$ look like

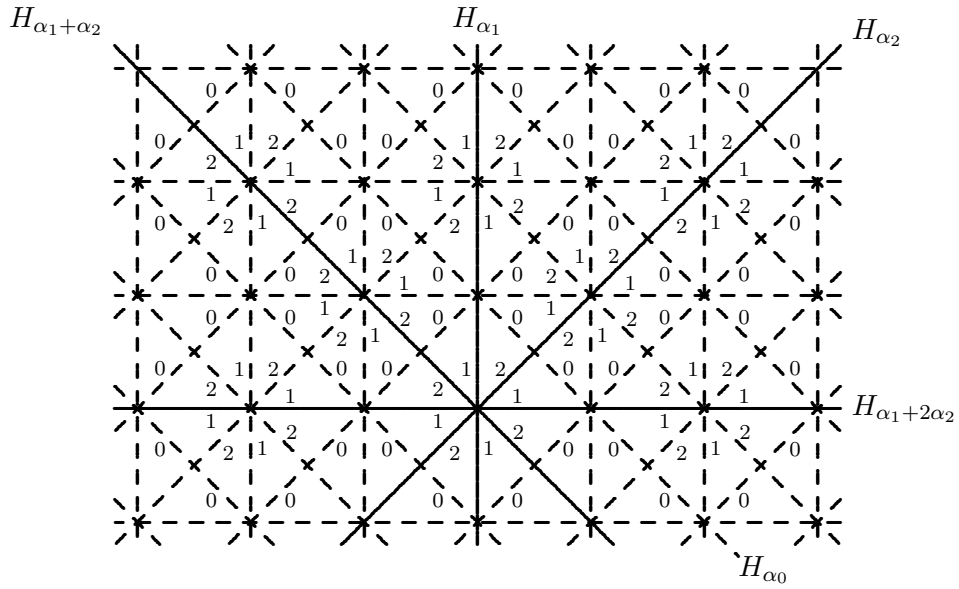

and

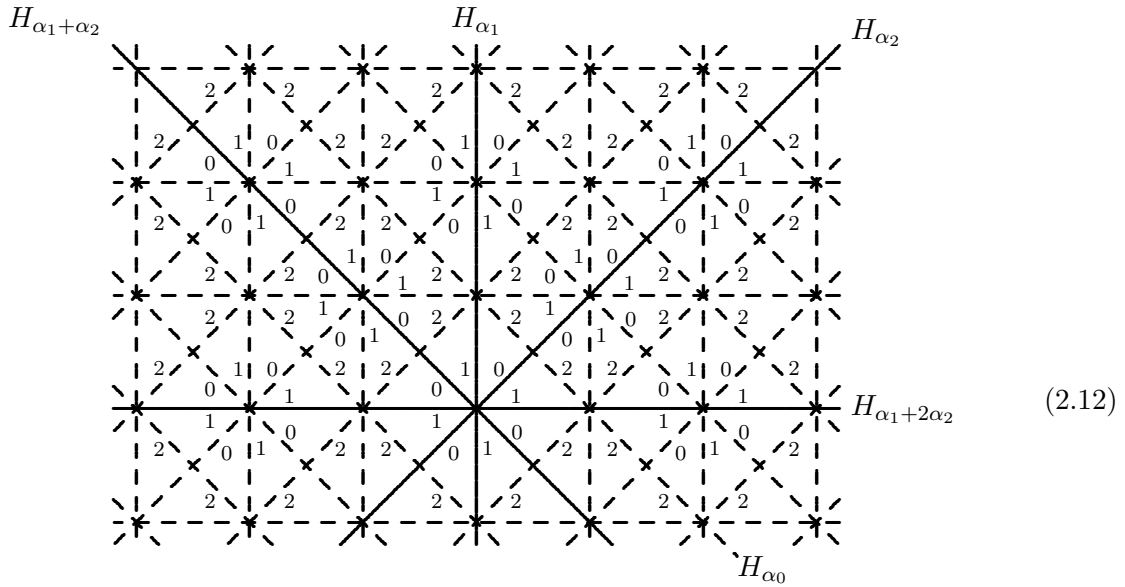

where the numbering on the walls of the alcoves is \widetilde{W} equivariant so that, for $w \in \widetilde{W}$, the numbering on the walls of wA is the w image of the numbering on the walls of A .

The 0 -polygon is the W -orbit of A in $\Omega \times \mathfrak{h}_{\mathbb{R}}^*$ and for $\lambda \in P$, the

the λ -polygon is $\lambda + WA$,

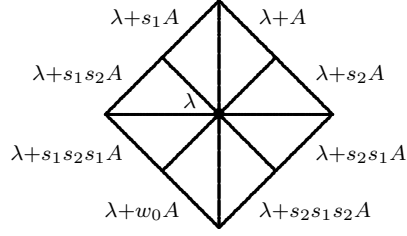

the translate of the W orbit of A by λ . The space $\Omega \times \mathfrak{h}_{\mathbb{R}}^*$ is tiled by the polygons and, via (2.11), we make identifications between W , \widetilde{W} , P and their geometric counterparts in $\Omega \times \mathfrak{h}_{\mathbb{R}}^*$:

$$\widetilde{W} = \{\text{alcoves}\}, \quad W = \{\text{alcoves in the } 0\text{-polygon}\}, \quad P = \{\text{centers of polygons}\}. \quad (2.13)$$

Define

$$P^+ = P \cap \overline{C} \quad \text{and} \quad P^{++} = P \cap C \quad (2.14)$$

so that P^+ is a set of representatives of the orbits of the action of W on P . The *fundamental weights* are the generators $\omega_1, \dots, \omega_n$ of the $\mathbb{Z}_{\geq 0}$ -module P^+ so that

$$C = \sum_{i=1}^n \mathbb{R}_{\geq 0} \omega_i, \quad P^+ = \sum_{i=1}^n \mathbb{Z}_{\geq 0} \omega_i, \quad \text{and} \quad P^{++} = \sum_{i=1}^n \mathbb{Z}_{> 0} \omega_i. \quad (2.15)$$

The lattice P has \mathbb{Z} -basis $\omega_1, \dots, \omega_n$ and the map

$$\begin{array}{ccc} P^+ & \longrightarrow & P^{++} \\ \lambda & \longmapsto & \rho + \lambda, \end{array} \quad \text{where } \rho = \omega_1 + \dots + \omega_n, \quad (2.16)$$

is a bijection. The *simple coroots* are $\alpha_1^\vee, \dots, \alpha_n^\vee$ the dual basis to the fundamental weights,

$$\langle \omega_i, \alpha_j^\vee \rangle = \delta_{ij}. \quad (2.17)$$

Define

$$\overline{C}^\vee = \sum_{i=1}^n \mathbb{R}_{\leq 0} \alpha_i^\vee \quad \text{and} \quad C^\vee = \sum_{i=1}^n \mathbb{R}_{< 0} \alpha_i^\vee. \quad (2.18)$$

The *dominance order* is the partial order on $\mathfrak{h}_{\mathbb{R}}^*$ given by

$$\mu \leq \lambda \quad \text{if} \quad \mu \in \lambda + \overline{C}^\vee. \quad (2.19)$$

In type C_2 the lattice $P = \mathbb{Z}\varepsilon_1 + \mathbb{Z}\varepsilon_2$ with $\{\varepsilon_1, \varepsilon_2\}$ an orthonormal basis of $\mathfrak{h}_{\mathbb{R}}^* \cong \mathbb{R}^2$ and $W = \{1, s_1, s_2, s_1s_2, s_2s_1, s_1s_2s_1, s_2s_1s_2, s_1s_2s_1s_2\}$ is the dihedral group of order 8 generated by the reflections s_1 and s_2 in the hyperplanes H_{α_1} and H_{α_2} , respectively, where

$$H_{\alpha_1} = \{x \in \mathfrak{h}_{\mathbb{R}}^* \mid \langle x, \varepsilon_1 \rangle = 0\} \quad \text{and} \quad H_{\alpha_2} = \{x \in \mathfrak{h}_{\mathbb{R}}^* \mid \langle x, \varepsilon_2 - \varepsilon_1 \rangle = 0\}.$$

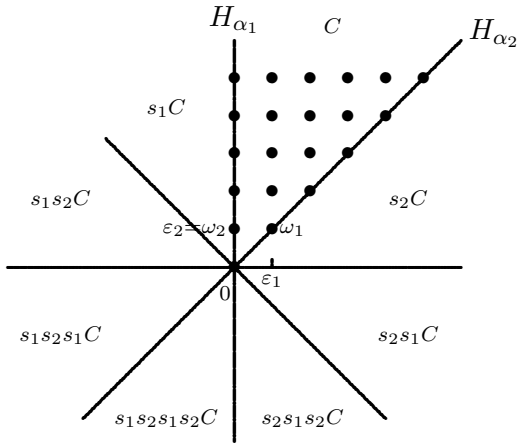
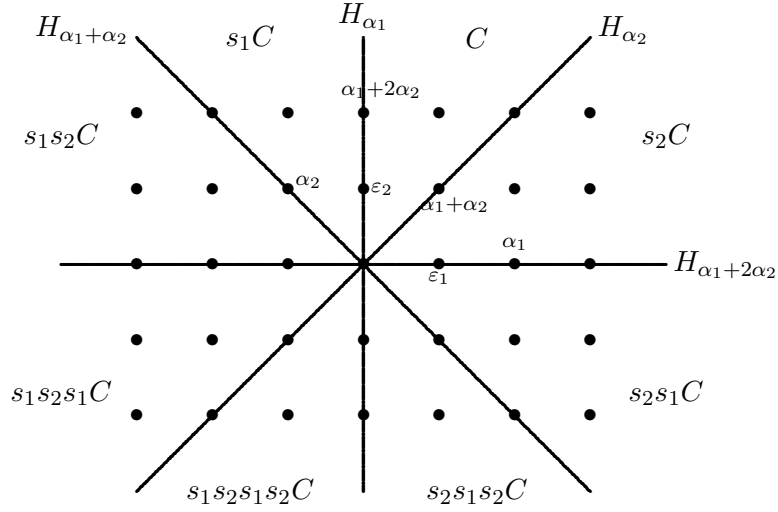

The set P^+

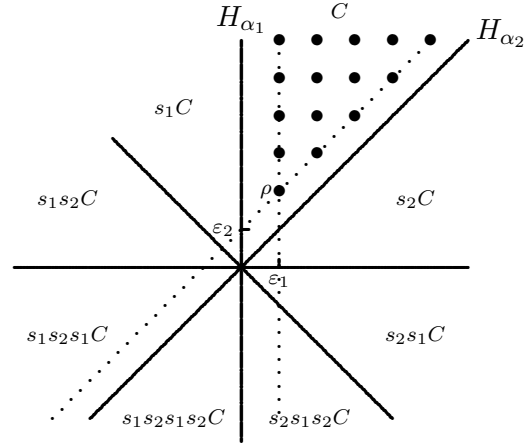

The set P^{++}

In this case

$$\begin{aligned} \omega_1 &= \varepsilon_1 + \varepsilon_2, & \alpha_1 &= 2\varepsilon_1, & \alpha_1^\vee &= \varepsilon_1, \\ \omega_2 &= \varepsilon_2, & \alpha_2 &= \varepsilon_2 - \varepsilon_1, & \alpha_2^\vee &= \alpha_2, \end{aligned}$$

and

$$R = \{\pm\alpha_1, \pm\alpha_2, \pm(\alpha_1 + \alpha_2), \pm(\alpha_1 + 2\alpha_2)\}.$$

3 The affine Hecke algebra

3.1 The alcove walk algebra

Fix notations for the Weyl group W , the extended affine Weyl group \widetilde{W} , and their action on $\Omega \times \mathfrak{h}_{\mathbb{R}}^*$ as in Section 2. Label the walls of the alcoves so that the fundamental alcove has walls labeled $0, 1, \dots, n$ and the labeling is \widetilde{W} -equivariant (see the picture in (2.12)).

The *periodic orientation* is the orientation of the walls of the alcoves given by

$$\text{setting the positive side of } H_{\alpha_j} \quad \text{to be} \quad \{x \in \mathfrak{h}_{\mathbb{R}}^* \mid \langle x, \alpha_j^\vee \rangle > j\}. \quad (3.1)$$

This is an orientation of the walls of the alcoves such that if Δ is an alcove and $\lambda \in P$ then

the walls of $\lambda + \Delta$ have the same orientation as the walls of Δ .

Let \mathbb{K} be a field. Use the notations for elements of Ω as in (2.10). The *alcove walk algebra* is the algebra over \mathbb{K} given by generators $g \in \Omega$ and

$$\begin{array}{cccc}
 \begin{array}{c} i \\ - | + \\ \hline \rightarrow \end{array} & \begin{array}{c} i \\ - | + \\ \hline \leftarrow \end{array} & \begin{array}{c} i \\ - | + \\ \hline \Rightarrow \end{array} & \begin{array}{c} i \\ - | + \\ \hline \Leftarrow \end{array} & (1 \leq i \leq n) \\
 \text{positive } i\text{-crossing} & \text{negative } i\text{-crossing} & \text{positive } i\text{-fold} & \text{negative } i\text{-fold} &
 \end{array}$$

with relations (straightening laws)

$$\begin{array}{c} i \\ - | + \\ \hline \rightarrow \end{array} = \begin{array}{c} i \\ - | + \\ \hline \leftarrow \end{array} + \begin{array}{c} i \\ - | + \\ \hline \Rightarrow \end{array} \quad \text{and} \quad \begin{array}{c} i \\ - | + \\ \hline \leftarrow \end{array} = \begin{array}{c} i \\ - | + \\ \hline \rightarrow \end{array} + \begin{array}{c} i \\ - | + \\ \hline \Leftarrow \end{array} \quad (3.2)$$

and

$$\begin{array}{cc}
 g \left(\begin{array}{c} i \\ - | + \\ \hline \rightarrow \end{array} \right) = \left(\begin{array}{c} g(i) \\ - | + \\ \hline \rightarrow \end{array} \right) g, & g \left(\begin{array}{c} i \\ - | + \\ \hline \leftarrow \end{array} \right) = \left(\begin{array}{c} g(i) \\ - | + \\ \hline \leftarrow \end{array} \right) g, \\
 g \left(\begin{array}{c} i \\ - | + \\ \hline \Leftarrow \end{array} \right) = \left(\begin{array}{c} g(i) \\ - | + \\ \hline \Leftarrow \end{array} \right) g, & g \left(\begin{array}{c} i \\ - | + \\ \hline \Rightarrow \end{array} \right) = \left(\begin{array}{c} g(i) \\ - | + \\ \hline \Rightarrow \end{array} \right) g.
 \end{array}$$

Viewing the product as concatenation each word in the generators can be represented as a sequence of arrows, with the first arrow having its head or its tail in the fundamental alcove. An *alcove walk* is a word in the generators such that,

- (a) the tail of the first step is in the fundamental alcove A ,
- (b) at every step, the head of each arrow is in the same alcove as the tail of the next arrow.

The *type* of a walk p is the sequence of labels on the arrows. Note that, if $w \in \widetilde{W}$ then

$$\ell(w) = \text{length of a minimal length walk from } A \text{ to } wA. \quad (3.3)$$

For example, in type C_2 ,

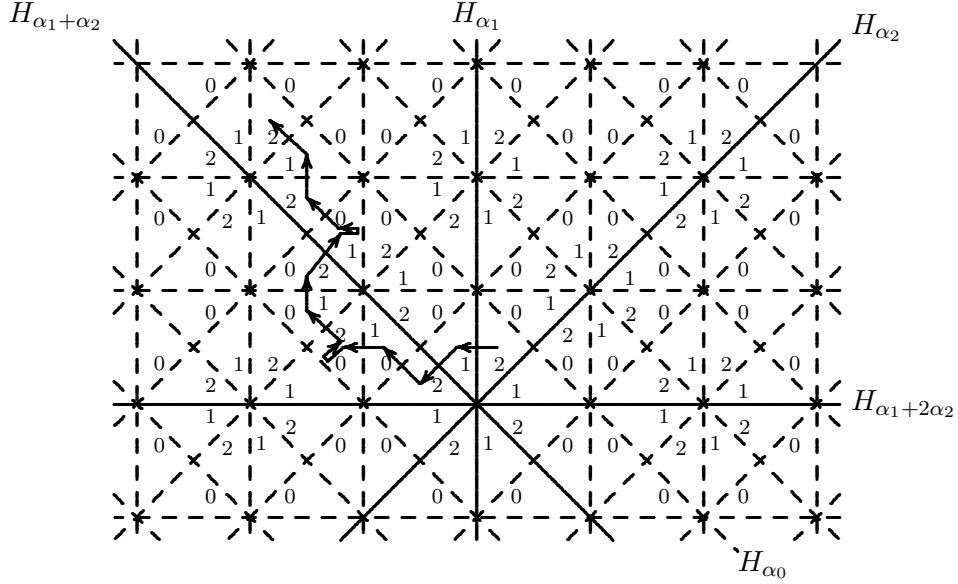

is an alcove walk p of type $(1, 2, 0, 1, 0, 2, 1, 2, 1, 0, 1, 2)$ with two folds. Using the notation

$$\begin{aligned} c_i^+ & \text{ for a positive } i\text{-crossing,} & f_i^+ & \text{ for a positive } i\text{-fold,} \\ c_i^- & \text{ for a negative } i\text{-crossing,} & f_i^- & \text{ for a negative } i\text{-fold,} \end{aligned} \quad (3.4)$$

the walk in the picture is $c_1^- c_2^- c_0^+ c_1^- f_0^+ c_2^+ c_1^+ c_2^+ f_1^- c_0^+ c_1^+ c_2^+$.

The proof of the following lemma is straightforward following the scheme indicated by the example which follows.

Lemma 3.1. *The set of alcove walks is a basis of the alcove walk algebra.*

For example, in type C_2 , a product of the generators which is not a walk is

$$c_1^- c_2^+ c_0^+ c_1^- f_0^- c_2^+ c_1^- c_2^+ f_1^- c_0^+ c_1^+ c_2^-,$$

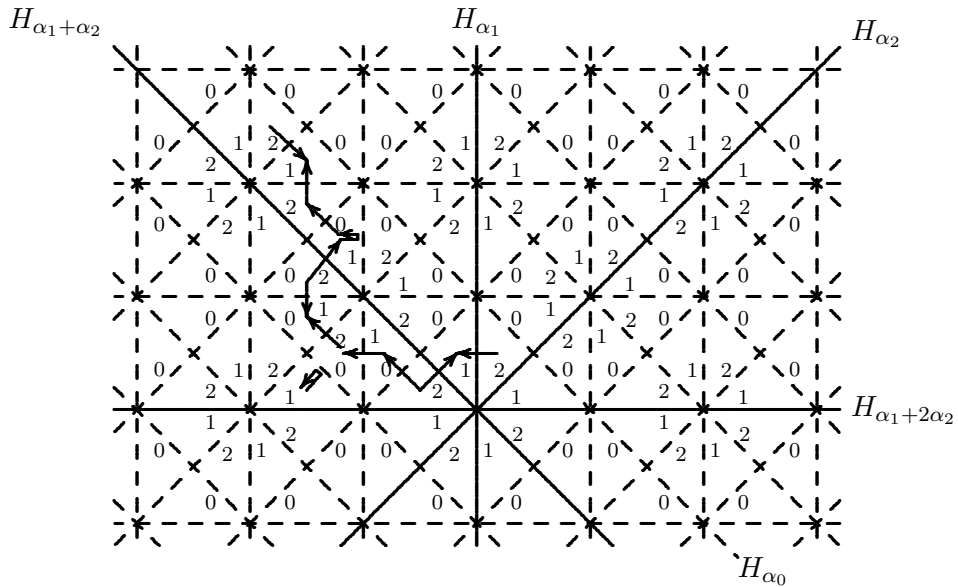

but, by first applying relations $f_i^\mp = -f_i^\pm$ and then working left to right applying the relations $c_i^\pm = c_i^\mp + f_i^\pm$, gives

$$\begin{aligned}
c_1^- c_2^+ c_0^+ c_1^- f_0^- c_2^+ c_1^- c_2^+ f_1^- c_0^+ c_1^+ c_2^- &= -(c_1^- c_2^+ c_0^+ c_1^- f_0^+ c_2^+ c_1^- c_2^+ f_1^- c_0^+ c_1^+ c_2^-) \\
&= -(c_1^- (c_2^- + f_2^+) c_0^+ c_1^- f_0^+ c_2^+ c_1^- c_2^+ f_1^- c_0^+ c_1^+ c_2^-) \\
&= -(c_1^- (c_2^- + f_2^+) c_0^+ c_1^- f_0^+ c_2^+ (c_1^+ + f_1^-) c_2^+ f_1^- c_0^+ c_1^+ c_2^-) \\
&= -(c_1^- (c_2^- + f_2^+) c_0^+ c_1^- f_0^+ c_2^+ (c_1^+ + f_1^-) c_2^+ f_1^- c_0^+ c_1^+ (c_2^+ + f_2^-))
\end{aligned}$$

and every term in the expansion of this expression is an alcove walk.

3.2 The affine Hecke algebra

Fix an invertible element $q \in \mathbb{K}$. The *affine Hecke algebra* \tilde{H} is the quotient of the alcove walk algebra by the relations

$$\begin{array}{c} \begin{array}{|c|} \hline - \\ \hline \end{array} \begin{array}{|c|} \hline i \\ \hline \end{array} \begin{array}{|c|} \hline + \\ \hline \end{array} \rightarrow = \left(\begin{array}{|c|} \hline - \\ \hline \end{array} \begin{array}{|c|} \hline i \\ \hline \end{array} \begin{array}{|c|} \hline + \\ \hline \end{array} \leftarrow \right)^{-1}, \quad \begin{array}{|c|} \hline - \\ \hline \end{array} \begin{array}{|c|} \hline i \\ \hline \end{array} \begin{array}{|c|} \hline + \\ \hline \end{array} \leftarrow = -(q - q^{-1}), \quad \begin{array}{|c|} \hline - \\ \hline \end{array} \begin{array}{|c|} \hline i \\ \hline \end{array} \begin{array}{|c|} \hline + \\ \hline \end{array} \rightarrow = (q - q^{-1}),
\end{array}$$

and

$$p = p' \quad \text{if } p \text{ and } p' \text{ are nonfolded walks with } \text{end}(p) = \text{end}(p'), \quad (3.5)$$

where $\text{end}(p)$ is the final alcove of p . Conceptually, the affine Hecke algebra only remembers the ending alcove of a walk (and some information about the folds) and forgets how it got to its destination.

For $w \in W$ and $\lambda \in P$ define elements

$$\begin{aligned}
T_{w^{-1}}^{-1} &= (\text{image in } \tilde{H} \text{ of a minimal length alcove walk from } A \text{ to } wA), \\
X^\lambda &= (\text{image in } \tilde{H} \text{ of a minimal length alcove walk from } A \text{ to } t_\lambda A).
\end{aligned}$$

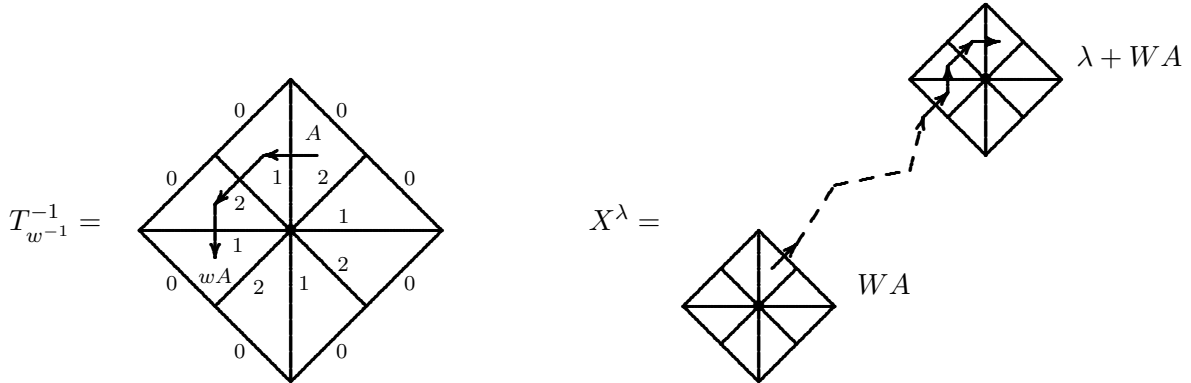

The following proposition shows that the alcove walk definition of the affine Hecke algebra coincides with the standard definition by generators and relations (see [IM] and [Lu]). A consequence of the proposition is that

$$\begin{aligned}
&\text{the finite Hecke algebra,} & H &= \text{span}\{T_{w^{-1}}^{-1} \mid w \in W\}, \quad \text{and} \\
&\text{the Laurent polynomial ring,} & \mathbb{K}[P] &= \text{span}\{X^\lambda \mid \lambda \in P\},
\end{aligned} \quad (3.6)$$

are subalgebras of \tilde{H} .

Proposition 3.2. *Let $g \in \Omega$, $\lambda, \mu \in P$, $w \in W$ and $1 \leq i \leq n$. Let φ be the element of R^+ such that $H_{\alpha_0} = H_{\varphi,1}$ is the wall of A which is not a wall of C and let s_φ be the reflection in H_φ . Let w_0 be the longest element of W . The following identities hold in \tilde{H} .*

(a) $X^\lambda X^\mu = X^{\lambda+\mu} = X^\mu X^\lambda$.

(b) $T_{s_i} T_w = \begin{cases} T_{s_i w}, & \text{if } \ell(s_i w) > \ell(w), \\ T_{s_i w} + (q - q^{-1})T_w, & \text{if } \ell(s_i w) < \ell(w). \end{cases}$

(c) If $\langle \lambda, \alpha_i^\vee \rangle = 0$ then $T_{s_i} X^\lambda = X^\lambda T_{s_i}$.

(d) If $\langle \lambda, \alpha_i^\vee \rangle = 1$ then $T_{s_i} X^{s_i \lambda} T_{s_i} = X^\lambda$.

(e) $T_{s_i} X^\lambda = X^{s_i \lambda} T_{s_i} + (q - q^{-1}) \frac{X^\lambda - X^{s_i \lambda}}{1 - X^{-\alpha_i}}$.

(f) $T_{s_0} T_{s_\varphi} = X^\varphi$.

(g) $X^{w_i} = g T_{w_0 w_i}$, where the action of g on A sends the origin to ω_i and w_i is the longest element of the stabilizer W_{ω_i} of ω_i in W .

Proof. Use notations for alcove walks as in (3.4).

(a) If p_λ is a minimal length walk from A to $t_\lambda A$ and p_μ is a minimal length walk from A to $t_\mu A$ then

$$p_\lambda p_\mu \text{ and } p_\mu p_\lambda \text{ are both nonfolded walks from } A \text{ to } t_{\lambda+\mu} A.$$

Thus the images of $p_\lambda p_\mu$ and $p_\mu p_\lambda$ are equal in \tilde{H} .

(b) If $\ell(ws_i) > \ell(w)$ and p_w is a minimal length walk from A to wA then

$$p_{ws_i} = p_w c_i^- \text{ is a minimal length walk from } A \text{ to } ws_i A.$$

and so $T_{s_i w^{-1}}^{-1} = T_{ws_i^{-1}}^{-1} = T_{w^{-1}}^{-1} T_{s_i}^{-1} = (T_{s_i} T_{w^{-1}})^{-1}$ in \tilde{H} . Taking inverses gives the first result, and the second follows by switching w and ws_i and using the relation $T_{s_i}^{-1} = T_{s_i} - (q - q^{-1})$ which follows from (3.2) and (3.5).

(c) Let p_λ be a minimal length alcove walk from A to $t_\lambda A$. If $\langle \lambda, \alpha_i^\vee \rangle = 0$ then H_{α_i} is a wall of $t_\lambda A$ and $s_i \lambda = \lambda$ and

$$c_i^- p_\lambda c_i^+ \text{ is a nonfolded walk from } A \text{ to } t_\lambda A.$$

Thus $T_{s_i}^{-1}X^\lambda T_{s_i} = X^\lambda = X^{s_i\lambda}$ in \tilde{H} .

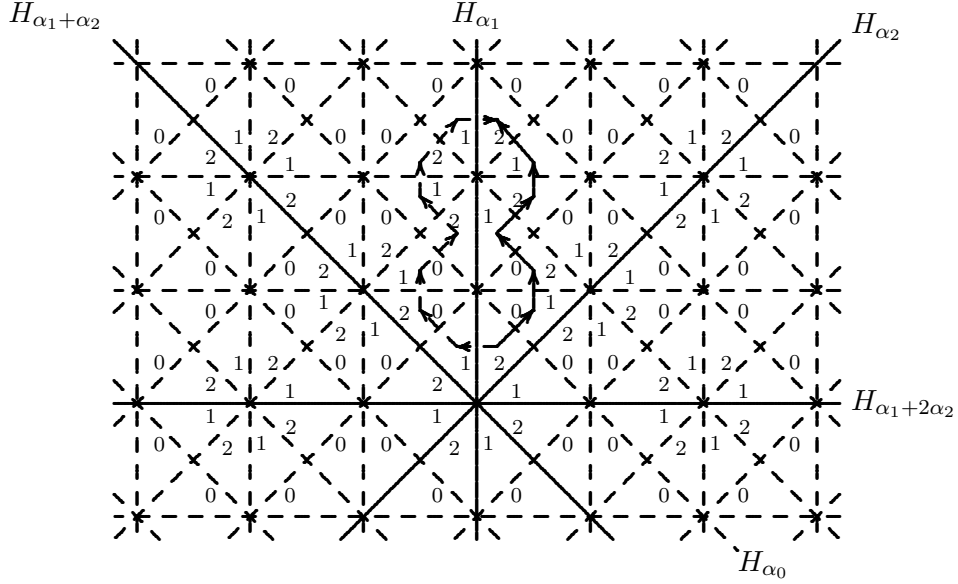

(d) Let p_λ be a minimal length walk from A to $t_\lambda A$. If $\langle \lambda, \alpha_i^\vee \rangle = 1$ then there is a minimal length walk from A to $t_\lambda A$ of the form $p_\lambda = p_{t_\lambda s_i} c_i^+$ where $p_{t_\lambda s_i}$ is minimal length walk from A to $t_\lambda s_i A$. Then

$$c_i^- p_{t_\lambda s_i} \text{ is a minimal length walk from } A \text{ to } t_{s_i\lambda} A.$$

Thus $T_{s_i}^{-1}(X^\lambda T_{s_i^{-1}}) = X^{s_i\lambda}$ in \tilde{H} .

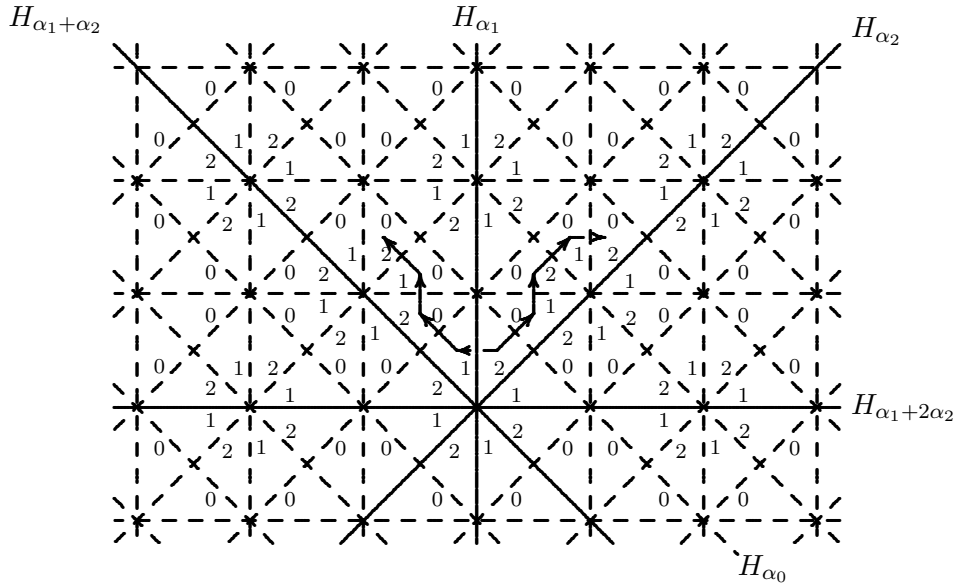

(e) Note that (c) and (d) are special cases of (e). If the statement of (e) holds for λ then, by multiplying on the left by $X^{-s_i\lambda}$ and on the right by $X^{-\lambda}$, it holds for $-\lambda$. If the statement (e)

holds for λ and μ then it holds for $\lambda + \mu$ since

$$\begin{aligned} T_{s_i} X^\lambda X^\mu &= \left(X^{s_i \lambda} T_{s_i} + (q - q^{-1}) \frac{X^\lambda - X^{s_i \lambda}}{1 - X^{-\alpha_i}} \right) X^\mu \\ &= X^{s_i \lambda} \left(X^{s_i \mu} T_{s_i} + (q - q^{-1}) \frac{X^\mu - X^{s_i \mu}}{1 - X^{-\alpha_i}} \right) + (q - q^{-1}) \left(\frac{X^\lambda - X^{s_i \lambda}}{1 - X^{-\alpha_i}} \right) X^\mu \\ &= X^{s_i(\lambda + \mu)} T_{s_i} + (q - q^{-1}) \frac{X^{\lambda + \mu} - X^{s_i(\lambda + \mu)}}{1 - X^{-\alpha_i}}. \end{aligned}$$

Thus, to prove (e) it is sufficient to verify (c) and (d), which has already been done.

(f) Let p_{s_φ} be a minimal length walk from $s_\varphi A$ to A , then

$$p_\varphi = c_0^+ p_{s_\varphi} \text{ is a minimal length walk from } A \text{ to } t_\varphi A.$$

Thus $T_0 T_{s_\varphi} = X^\varphi$ in \tilde{H} .

(g) If $p_{w_0 w_i}$ is a minimal length walk from $w_i w_0 A$ to A then

$$p_{\omega_i} = g p_{w_0 w_i} \text{ is a minimal length walk from } A \text{ to } t_{\omega_i} A.$$

Thus $X^{\omega_i} = g T_{w_0 w_i}$ in \tilde{H} . For example, in type C_2 , $w_0 = s_2 s_1 s_2 s_1$ and there is one element g in Ω such that $g \neq 1$ for which $g \omega_2 = 0$ and $w_2 = s_1$ so that $w_0 w_2 = s_2 s_1 s_2$. \square

The sets

$$\{T_{w^{-1}}^{-1} X^\lambda \mid w \in W, \lambda \in P\} \quad \text{and} \quad \{X^\mu T_v^{-1} \mid \mu \in P, v \in W\} \quad (3.7)$$

are bases of \tilde{H} . If p is an alcove walk then the *weight* of p and the *final direction* of p are

$$\text{wt}(p) \in P \text{ and } \varphi(p) \in W \quad \text{such that} \quad p \text{ ends in the alcove } \text{wt}(p) + \varphi(p)A. \quad (3.8)$$

Let

$$\begin{aligned} f^-(p) &= (\text{number of negative folds of } p), \\ f^+(p) &= (\text{number of positive folds of } p), \quad \text{and} \\ f(p) &= (\text{total number of folds of } p). \end{aligned} \quad (3.9)$$

The following theorem provides a combinatorial formulation of the transition matrix between the bases in (3.7). It is a q -version of the main result of [LP] and an extension of Corollary 6.1 of [Sc].

Theorem 3.3. *Use notations as in (3.4). Let $\lambda \in P$ and $w \in W$. Fix a minimal length walk $p_w = c_{i_1}^- c_{i_2}^- \cdots c_{i_r}^-$ from A to wA and a minimal length walk $p_\lambda = c_{j_1}^{\epsilon_1} \cdots c_{j_s}^{\epsilon_s}$ from A to $t_\lambda A$. Then, with notations as in (3.8) and (3.9),*

$$T_{w^{-1}}^{-1} X^\lambda = \sum_p (-1)^{f^-(p)} (q - q^{-1})^{f(p)} X^{\text{wt}(p)} T_{\varphi(p)^{-1}}^{-1},$$

where the sum is over all alcove walks $p = c_{i_1}^- \cdots c_{i_r}^- p_{j_1} \cdots p_{j_s}$ such that p_{j_k} is either $c_{j_k}^{\epsilon_k}$, $c_{j_k}^{-\epsilon_k}$ or $f_{j_k}^{\epsilon_k}$.

Proof. The product $p_w p_\lambda = c_{i_1}^- c_{i_2}^- \cdots c_{i_r}^- c_{j_1}^{\epsilon_1} \cdots c_{j_s}^{\epsilon_s}$ may not necessarily be walk, but its straightening produces a sum of walks, and this decomposition gives the formula in the statement. \square

Remark 3.4. The *initial direction* $\iota(p)$ and the *final direction* $\varphi(p)$ of an alcove walk p appear naturally in Theorem 3.3. These statistics also appear in the Pieri-Chevalley formula in the K -theory of the flag variety (see [PR], [GR], [Br] and [LP]).

Remark 3.5. In Theorem 3.3, for certain λ the walk p_λ may be chosen so that all the terms in the expansion of $T_{w^{-1}}^{-1}X^\lambda$ have the same sign. For example, if λ is dominant, then p_λ can be taken with all $\epsilon_k = +$, in which case all folds which appear in the straightening of $p_w p_\lambda$ will be positive folds and so all terms in the expansion will be positive. If λ is antidominant then p_λ can be taken with all $\epsilon_k = -$ and all terms in the expansion will be negative. This fact gives positivity results for products in the cohomology and the K -theory of the flag variety (see [PR], [Br]).

Remark 3.6. The affine Hecke algebra \tilde{H} has basis $\{X^\lambda T_{w^{-1}}^{-1} \mid \lambda \in P, w \in W\}$ in bijection with the alcoves in $\Omega \times \mathfrak{h}_{\mathbb{R}}^*$, where $X^\lambda T_{w^{-1}}^{-1}$ is the image in \tilde{H} of a minimal length alcove walk from A to the alcove $\lambda + wA$. Changing the orientation of the walls of the alcoves changes the resulting basis in the affine Hecke algebra \tilde{H} . The orientation in (3.1) is the one such that

$$\text{the most negative point is } -\infty\rho, \text{ deep in the chamber } w_0C. \quad (3.10)$$

Another standard orientation is where

$$\text{the most negative point is the center of the fundamental alcove } A. \quad (3.11)$$

Using the orientation of the walls given by (3.11) produces the basis commonly denoted $\{T_w \mid w \in \widetilde{W}\}$ by taking T_w to be the image in \tilde{H} of a minimal length alcove walk from A to $w^{-1}A$. Since $T_i^{-1} = T_i - (q - q^{-1})$ the transition matrix between the basis $\{X^\lambda T_{w^{-1}}^{-1} \mid \lambda \in P, w \in W\}$ and the basis $\{T_w \mid w \in \widetilde{W}\}$ is triangular.

4 Polynomials and symmetric functions

Recall, from (3.6), that the *finite Hecke algebra* is the subalgebra of the affine Hecke algebra \tilde{H} given by

$$H = \text{span}\{T_{w^{-1}}^{-1} \mid w \in W\}.$$

Let $\mathbf{1}_0$ be the element of H given by

$$\mathbf{1}_0^2 = \mathbf{1}_0 \quad \text{and} \quad T_{w^{-1}}^{-1}\mathbf{1}_0 = q^{-\ell(w)}\mathbf{1}_0, \quad (4.1)$$

for $w \in W$. Two explicit formulas for $\mathbf{1}_0$ are

$$\mathbf{1}_0 = \frac{1}{W_0(q^{-2})} \sum_{w \in W} q^{-\ell(w)} T_{w^{-1}}^{-1} = \frac{1}{W_0(q^2)} \sum_{w \in W} q^{\ell(w)} T_w, \quad \text{where} \quad W_0(t) = \sum_{w \in W} t^{\ell(w)}$$

is the *Poincaré polynomial* of W .

As observed in (3.6), $\mathbb{K}[P] = \text{span}\{X^\lambda \mid \lambda \in P\}$ is a subalgebra of \tilde{H} . The vector space $\mathbb{K}[P]$ also sits inside \tilde{H} in a *different* way. Since $\{X^\lambda \mathbf{1}_0 \mid \lambda \in P\}$ is a basis of $\tilde{H}\mathbf{1}_0$ there is

$$\begin{array}{ccc} \text{a vector space isomorphism} & \mathbb{K}[P] & \longrightarrow & \tilde{H}\mathbf{1}_0 \\ & f & \longmapsto & f\mathbf{1}_0. \end{array} \quad (4.2)$$

The ring of *symmetric functions* is

$$\mathbb{K}[P]^W = \{f \in \mathbb{K}[P] \mid wf = f \text{ for all } w \in W\}. \quad (4.3)$$

By a theorem of Bernstein (see [NR, Theorem 1.4]) this subalgebra of \tilde{H} is the center of \tilde{H} ,

$$\mathbb{K}[P]^W = Z(\tilde{H}). \quad (4.4)$$

The *spherical Hecke algebra* is the ring $\mathbf{1}_0 X^\lambda \mathbf{1}_0$ and the restriction of the map (4.2) to $Z(\tilde{H})$ is the *Satake isomorphism* of the following theorem.

Theorem 4.1. *Let $\mathbf{1}_0$ and $\mathbb{K}[P]^W$ be as in (4.1) and (4.3), respectively. Then*

$$\begin{array}{ccc} \mathbb{K}[P]^W = Z(\tilde{H}) & \longrightarrow & \mathbf{1}_0 \tilde{H} \mathbf{1}_0 \\ f & \longmapsto & f \mathbf{1}_0 \end{array} \quad \text{is a } \mathbb{K}\text{-algebra isomorphism.}$$

Proof. The map is a well defined homomorphism since, if $f, f_1, f_2 \in Z(\tilde{H})$, then $f \mathbf{1}_0 = f \mathbf{1}_0^2 = \mathbf{1}_0 f \mathbf{1}_0$ and $f_1 f_2 \mathbf{1}_0 = f_1 f_2 \mathbf{1}_0^2 = f_1 \mathbf{1}_0 f_2 \mathbf{1}_0$.

Suppose that $\langle \lambda, \alpha_i^\vee \rangle > 0$ so that λ is on the positive side of H_{α_i} . Then, by Proposition 3.2e,

$$\begin{aligned} \mathbf{1}_0 X^{s_i \lambda} \mathbf{1}_0 &= q^{-1} \mathbf{1}_0 T_{s_i} X^\lambda \mathbf{1}_0 \\ &= q^{-1} \mathbf{1}_0 X^\lambda T_{s_i} \mathbf{1}_0 - q^{-1} (q - q^{-1}) \mathbf{1}_0 (X^{s_i \lambda + \alpha_i} + \dots + X^{\lambda - \alpha_i} + X^\lambda) \mathbf{1}_0 \\ &= \mathbf{1}_0 X^\lambda \mathbf{1}_0 - (1 - q^{-2}) \mathbf{1}_0 (X^{s_i \lambda + \alpha_i} + \dots + X^{\lambda - \alpha_i} + X^\lambda) \mathbf{1}_0. \end{aligned}$$

so that

$$\mathbf{1}_0 X^{s_i \lambda} \mathbf{1}_0 = q^{-2} \mathbf{1}_0 X^\lambda \mathbf{1}_0 - (1 - q^{-2}) \mathbf{1}_0 (X^{s_i \lambda + \alpha_i} + \dots + X^{\lambda - \alpha_i}) \mathbf{1}_0 \quad (4.5)$$

or, equivalently,

$$\mathbf{1}_0 (X^{s_i \lambda} + \dots + X^{\lambda - \alpha_i}) \mathbf{1}_0 = q^{-2} \mathbf{1}_0 (X^{s_i \lambda + \alpha_i} + \dots + X^\lambda) \mathbf{1}_0. \quad (4.6)$$

From the relation in (4.5),

$$\begin{aligned} \mathbf{1}_0 X^{s_i \lambda} \mathbf{1}_0 - \mathbf{1}_0 X^{s_i \lambda + \alpha_i} \mathbf{1}_0 &= q^{-2} \mathbf{1}_0 X^\lambda \mathbf{1}_0 - (1 - q^{-2}) \mathbf{1}_0 (X^{s_i \lambda + \alpha_i} + \dots + X^{\lambda - \alpha_i}) \mathbf{1}_0 \\ &\quad - q^{-2} \mathbf{1}_0 X^{\lambda - \alpha_i} \mathbf{1}_0 + (1 - q^{-2}) \mathbf{1}_0 (X^{s_i \lambda + 2\alpha_i} + \dots + X^{\lambda - 2\alpha_i}) \mathbf{1}_0, \end{aligned}$$

so that

$$\mathbf{1}_0 X^{s_i \lambda} \mathbf{1}_0 = q^{-2} \mathbf{1}_0 X^\lambda \mathbf{1}_0 + q^{-2} \mathbf{1}_0 X^{s_i \lambda + \alpha_i} \mathbf{1}_0 - \mathbf{1}_0 X^{\lambda - \alpha_i} \mathbf{1}_0. \quad (4.7)$$

It follows from these relations that any element of $\mathbf{1}_0 \tilde{H} \mathbf{1}_0$ can, inductively, be written as a linear combination of the elements $\mathbf{1}_0 X^\lambda \mathbf{1}_0$, $\lambda \in P^+$. Using Theorem 3.3 to expand $\mathbf{1}_0 X^\lambda$ in terms of the basis $\{X^\mu T_{v^{-1}}^{-1} \mid \mu \in P, v \in W\}$ produces

$$\mathbf{1}_0 X^\lambda = X^{w_0 \lambda} T_{w_0}^{-1} + \sum_{\mu > w_0 \lambda} d_{\mu, v} X^\mu T_{v^{-1}}^{-1},$$

and, since these leading terms are all different (as λ runs over P^+), it follows that

$$\mathbf{1}_0 \tilde{H} \mathbf{1}_0 \quad \text{has basis} \quad \{\mathbf{1}_0 X^\lambda \mathbf{1}_0 \mid \lambda \in P^+\}. \quad (4.8)$$

The *orbit sums*

$$m_\lambda = \sum_{\gamma \in W\lambda} X^\gamma, \quad \lambda \in P^+, \quad (4.9)$$

form a basis of $\mathbb{K}[P]^W$. The relation in Proposition 3.2e implies that, if $f \in \mathbb{K}[P]^W$ then $T_w f = f T_w$ for all $w \in W$, and so the $m_\lambda \mathbf{1}_0 = \mathbf{1}_0 m_\lambda \mathbf{1}_0$ are in $\mathbf{1}_0 \tilde{H} \mathbf{1}_0$. Viewing these in terms of the basis $\{X^\mu T_{v^{-1}}^{-1} \mid \mu \in P, v \in W\}$ of \tilde{H} one sees that the $m_\lambda \mathbf{1}_0$, $\lambda \in P^+$, are linearly independent and so

$$\mathbf{1}_0 \tilde{H} \mathbf{1}_0 \quad \text{has basis} \quad \{m_\lambda \mathbf{1}_0 \mid \lambda \in P^+\}. \quad (4.10)$$

The point is that the transition matrix between the basis in (4.8) and the basis in (4.10) is triangular. \square

4.1 Hall-Littlewood polynomials

For $\mu \in P$ let $W_\mu = \text{Stab}(\mu)$ be the stabilizer of μ . The *Poincaré polynomial* of W_μ is

$$W_\mu(t) = \sum_{w \in W_\mu} t^{\ell(w)}. \quad (4.11)$$

For $\mu \in P$, the *Hall-Littlewood polynomial* or *Macdonald spherical function* $P_\mu(X; t)$ is the element of $\mathbb{K}[P]^W$ defined by

$$P_\mu(X; q^{-2})\mathbf{1}_0 = \left(\sum_{w \in W^\mu} q^{-\ell(w)} T_{w^{-1}}^{-1} \right) X^\mu \mathbf{1}_0, \quad (4.12)$$

where W^μ is a set of minimal length coset representatives for the cosets in W/W_μ . Since every element $w \in W$ has a unique expression $w = uv$ with $u \in W^\mu$ and $v \in W_\mu$,

$$\begin{aligned} \sum_{w \in W^\mu} q^{-\ell(w)} T_{w^{-1}}^{-1} X^\mu \mathbf{1}_0 &= \frac{1}{W_\mu(q^{-2})} \left(\sum_{u \in W^\mu} q^{-\ell(u)} T_{u^{-1}}^{-1} \right) X^\mu \left(\sum_{v \in W_\mu} q^{-\ell(v)} T_{v^{-1}}^{-1} \right) \mathbf{1}_0 \\ &= \frac{1}{W_\mu(q^{-2})} \left(\sum_{u \in W^\mu} q^{-\ell(u)} T_{u^{-1}}^{-1} \right) \left(\sum_{v \in W_\mu} q^{-\ell(v)} T_{v^{-1}}^{-1} \right) X^\mu \mathbf{1}_0 = \frac{W_0(q^{-2})}{W_\mu(q^{-2})} \mathbf{1}_0 X^\mu \mathbf{1}_0, \end{aligned}$$

and hence

$$P_\mu(X, q^{-2})\mathbf{1}_0 \text{ is exactly } \mathbf{1}_0 X^\mu \mathbf{1}_0 \text{ except normalized}$$

so that the coefficient of $X^\mu \mathbf{1}_0$ is 1.

Macdonald's formula for the spherical functions on a p -adic group [Mac1, Theorem 4.1.2] is

$$P_\mu(X; q^{-2}) = \frac{1}{W_\mu(q^{-2})} \sum_{w \in W} w \left(X^\mu \prod_{\alpha \in R^+} \frac{1 - q^{-2} X^{-\alpha}}{1 - X^{-\alpha}} \right). \quad (4.13)$$

See [NR, Theorem 2.9a] for a proof in this context.

The following theorem gives additional formulas for $P_\lambda(X; q^{-2})$.

$$\text{A positively folded alcove walk is an alcove walk with no negative folds.} \quad (4.14)$$

In the following theorem we shall consider alcove walks which do not necessarily begin at A . This is the natural way to account for the sum over W^λ which appears in the definition of P_λ in (4.12). The *type* of p is the sequence of labels of the folds and the wall crossings of p .

Theorem 4.2. *For $\lambda \in P^+$ let $t_\lambda \in \widetilde{W}$ be the translation in λ and let n_λ be the maximal length element in the double coset $W t_\lambda W$.*

(a) [Sc, Theorem 1.1] *Let $\lambda \in P^+$ and fix a minimal length walk $p_\lambda = c_{i_1}^+ \cdots c_{i_\ell}^+$ from A to $\lambda + A$. Let*

$$B_q(p_\lambda) = \{\text{positively folded alcove walks of type } (i_1, \dots, i_\ell) \text{ which begin at } wA \mid w \in W^\lambda\}$$

Then

$$P_\lambda(X; q^{-2}) = \sum_{p \in B_q(p_\lambda)} q^{-(\ell(\iota(p)) + \ell(\varphi(p)) - f(p))} (1 - q^{-2})^{f(p)} X^{\text{wt}(p)},$$

where $\iota(p)$ is the alcove where p begins, $\text{wt}(p) + \varphi(p)A$ is the alcove where p ends, and $f(p)$ is the number of folds in p .

(b) Let $\lambda \in P^+$. Then

$$q^{\ell(w_0)}W_0(q^{-2})P_\lambda\mathbf{1}_0 = \sum_{x \in Wt_\lambda W} q^{\ell(x) - \ell(n_\lambda)}T_x.$$

Proof. (a) The proof is accomplished by using Theorem 3.3 to expand the sum in (4.12). Since all crossings in the walk p_λ are positive crossings Theorem 3.3 gives

$$\left(\sum_{w \in W^\lambda} q^{-\ell(w)}T_{w^{-1}} \right) X^\lambda = \sum_{w \in W^\lambda} q^{-\ell(w)} \sum_{\substack{p \in B_q(p_\lambda) \\ \iota(p)=w}} (q - q^{-1})^{f(p)} X^{\text{wt}(p)} T_{\varphi(p)}^{-1}.$$

Hence

$$P_\lambda\mathbf{1}_0 = \sum_{p \in B_q(\lambda)} q^{-\ell(\iota(p))} (q - q^{-1})^{f(p)} X^{\text{wt}(p)} q^{-\ell(\varphi(p))} \mathbf{1}_0.$$

(b) Let $\lambda \in P^+$. Let $W_\lambda = \text{Stab}(\lambda)$ and let w_0 and w_λ be the maximal length elements in W and W_λ , respectively. Let m_λ and n_λ be the minimal and maximal length elements respectively in the double coset $Wt_\lambda W$. If $\lambda = 2\omega_2$ in type C_2 , then $W_\lambda = \{1, s_1\}$, $w_\lambda = s_1$, $w_0 = s_1s_2s_1s_2$, $\ell(t_\lambda) = 6$, $\ell(m_\lambda) = 3$, and $\ell(n_\lambda) = 10$. Labeling the alcove wA by the element w , the 32 alcoves wA with $w \in Wt_\lambda W$ make up the four shaded diamonds.

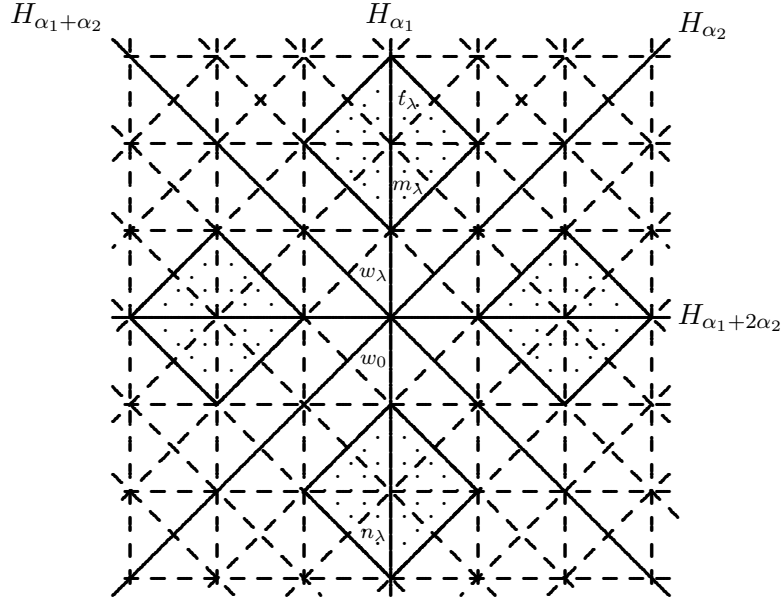

Then

$$\begin{aligned}
q^{\ell(w_0)}W_0(q^{-2})P_\lambda\mathbf{1}_0 &= q^{\ell(w_0)}W_0(q^{-2})q^{-2\ell(w_0)+2\ell(w_\lambda)}\left(\sum_{u\in W^\lambda}q^{\ell(u)}T_u\right)X^\lambda\mathbf{1}_0 \\
&= q^{\ell(w_0)}q^{-2\ell(w_0)}W_0(q^2)q^{-2\ell(w_0)+2\ell(w_\lambda)}\left(\sum_{u\in W^\lambda}q^{\ell(u)}T_u\right)T_{m_\lambda}T_{w_0w_\lambda}\mathbf{1}_0 \\
&= q^{-3\ell(w_0)+2\ell(w_\lambda)}\left(\sum_{u\in W^\lambda}q^{\ell(u)}T_u\right)T_{m_\lambda}q^{\ell(w_0)-\ell(w_\lambda)}\left(\sum_{w\in W}q^{\ell(w)}T_w\right) \\
&= q^{-2\ell(w_0)+\ell(w_\lambda)}\left(\sum_{\substack{u\in W^\lambda \\ w\in W}}q^{\ell(u)+\ell(w)}T_{um_\lambda w}\right) \\
&= q^{-2\ell(w_0)+\ell(w_\lambda)}\left(\sum_{x\in Wt_\lambda W}q^{\ell(x)-\ell(m_\lambda)}T_x\right),
\end{aligned}$$

and the result follows from the identity $\ell(n_\lambda) = \ell(w_0) + \ell(t_\lambda) = \ell(w_0) + \ell(w_0) - \ell(w_\lambda) + \ell(m_\lambda)$. \square

Remark 4.3. The set $B_q(p_\lambda)$ appearing in Theorem 4.2a is heavily dependent on the choice of p_λ . One way to make this seem less dependent on this choice is to consider the region

$$[\lambda] = \{x = \sum_i x_i \omega_i \mid 0 \leq x_i \leq \lambda_i\}, \quad \text{where} \quad \lambda = \sum_i \lambda_i \omega_i.$$

This region is a union of alcoves and any minimal length walk p_λ from A to $\lambda + w_0A$ lies in $[\lambda]$. Foldings of the walk p_λ are then produced by folding the region $[\lambda]$ along the ‘‘creases’’ formed by the hyperplanes. This process produces a bijection between the paths in $B_q(p_\lambda)$ and the set $B_q([\lambda])$ of ‘‘positively folded foldings’’ of the region $[\lambda]$, and the set $B_q([\lambda])$ does not depend the choice of an initial path. The moral is that the best way to forget the choice of the initial path p_λ is to remember all the possible initial paths all at once. This translation of foldings was explained to me by J. Ramage in Fall 2000.

Remark 4.4. Let $B_q(p_\lambda)$ be as in Theorem 4.2a and let $p \in B_q(p_\lambda)$. Suppose that p has f folds. For $0 \leq i \leq f$, let $p^{(i)}$ be the positively folded walk in $B_q(p_\lambda)$ which coincides with p up to the i th fold and is unfolded thereafter. Then $p^{(0)}, \dots, p^{(f)}$ is a sequence of positively folded walks such that

$$p^{(f)} = p, \quad \iota(p^{(i)}) = \iota(p), \quad \varphi(p^{(0)}) = \iota(p), \quad \text{and} \quad \varphi(p^{(i)}) = s_\alpha \varphi(p^{(i-1)})$$

if the i th fold is on the hyperplane $H_{\alpha, j}$. Since

$$\varphi(p^{(i-1)}) > \varphi(p^{(i)}) \quad \text{and} \quad (-1)^{\ell(\varphi(p^{(i)}))} = (-1)^{\ell(s_\alpha)}(-1)^{\varphi(p^{(i-1)})} = (-1)(-1)^{\varphi(p^{(i-1)})},$$

$\ell(\varphi(p^{(i-1)})) - \ell(\varphi(p^{(i)})) - 1$ is an even integer ≥ 0 . It follows that

$$\begin{aligned}
\ell(\iota(p)) + \ell(\varphi(p)) - f(p) &= \ell(\iota(p)) - \ell(\varphi(p^{(1)})) - 1 \\
&\quad + \ell(\varphi(p^{(1)})) - \ell(\varphi(p^{(2)})) - 1 \\
&\quad + \ell(\varphi(p^{(2)})) - \ell(\varphi(p^{(3)})) - 1 \\
&\quad + \dots + \ell(\varphi(p^{(f-1)})) - \ell(\varphi(p^{(f)})) - 1 \quad + 2\ell(\varphi(p))
\end{aligned}$$

is an even integer ≥ 0 . This proves that $f(p) \leq \ell(\iota(p)) - \ell(\varphi(p))$ and that $P_\lambda(X; q^{-2})$ really is a polynomial in the variable q^{-2} .

4.2 Demazure operators

The group W acts on $\mathbb{K}[P] = \text{span}\{X^\lambda \mid \lambda \in P\}$ by

$$wX^\lambda = X^{w\lambda}, \quad \text{for } w \in W, \lambda \in P. \quad (4.15)$$

For each $1 \leq i \leq n$, define *Demazure operators*

$$\Delta_i: \mathbb{K}[P] \longrightarrow \mathbb{K}[P] \quad \text{and} \quad \tilde{\Delta}_i: \mathbb{K}[P] \longrightarrow \mathbb{K}[P]$$

by

$$\Delta_i f = \frac{1}{1 - X^{-\alpha_i}}(1 - s_i)f \quad \text{and} \quad \tilde{\Delta}_i f = \frac{1}{X^{\alpha_i} - 1}(X^{\alpha_i} - s_i)f, \quad (4.16)$$

respectively.

Via the isomorphism in (4.2), the vector space $\mathbb{K}[P]$ is an \tilde{H} -module. Let

$$C_i = q^{-2} + q^{-1}T_{s_i} = 1 + q^{-1}T_{s_i}^{-1} = (1 + q^{-2})\mathbf{1}_i, \quad (4.17)$$

where $\mathbf{1}_i$ is the element of H such that $\mathbf{1}_i^2 = \mathbf{1}_i$ and $T_{s_i}^{-1}\mathbf{1}_i = q^{-1}\mathbf{1}_i$. The element $\mathbf{1}_i$ is the rank 1 version of the element $\mathbf{1}_0$ in (4.1).

The following proposition shows that, at $q^{-2} = 0$, the action of C_i on $\mathbb{K}[P]$ is the Demazure operator $\tilde{\Delta}_i$. In geometry, the Demazure operators arise naturally as push-pull operators on the K-theory of the flag variety (see [PR, Proposition]).

Proposition 4.5. *Let $\rho = \omega_1 + \cdots + \omega_n$ as in (2.16). As operators on $\mathbb{K}[P]$,*

(a) $\tilde{\Delta}_i = X^{-\rho}\Delta_i X^\rho = \Delta_i + s_i,$

(b) $C_i = (1 - q^{-2})\Delta_i + (s_i + q^{-2}) = (1 + s_i) \left(\frac{1 - q^{-2}X^{-\alpha_i}}{1 - X^{-\alpha_i}} \right),$

Proof. (a) Let $\lambda \in P$. Since $s_i\rho = \rho - \langle \rho, \alpha_i^\vee \rangle \alpha_i = \rho - \alpha_i,$

$$(X^{-\rho}\Delta_i X^\rho)(X^\lambda) = X^{-\rho} \frac{X^{\lambda+\rho} - X^{s_i\lambda+\rho-\alpha_i}}{1 - X^{-\alpha_i}} = \frac{X^\lambda - X^{s_i\lambda-\alpha_i}}{1 - X^{-\alpha_i}} = \tilde{\Delta}_i(X^\lambda),$$

and, as operators,

$$\Delta_i + s_i = \frac{1}{1 - X^{-\alpha_i}}(1 - s_i) + s_i = \frac{1}{1 - X^{-\alpha_i}}(1 - s_i + s_i - X^{-\alpha_i}s_i) = \tilde{\Delta}_i.$$

(b) Using Proposition 3.2e,

$$\begin{aligned} q^{-1}T_{s_i}X^\lambda\mathbf{1}_0 &= \left(q^{-1}X^{s_i\lambda}T_{s_i} + (1 - q^{-2})\frac{X^\lambda - X^{s_i\lambda}}{1 - X^{-\alpha_i}} \right) \mathbf{1}_0 = \left(X^{s_i\lambda} + (1 - q^{-2})\frac{X^\lambda - X^{s_i\lambda}}{1 - X^{-\alpha_i}} \right) \mathbf{1}_0 \\ &= \left(\frac{X^{s_i\lambda} - X^{s_i\lambda-\alpha_i} + X^\lambda - X^{s_i\lambda} - q^{-2}(X^\lambda - X^{s_i\lambda})}{1 - X^{-\alpha_i}} \right) \mathbf{1}_0 \\ &= (\tilde{\Delta}_i - q^{-2}\Delta_i)(X^\lambda)\mathbf{1}_0, \end{aligned}$$

and the first formula in (b) now follows from the second formula in (a). Then

$$\begin{aligned} C_i &= (q^{-2} + \tilde{\Delta}_i - q^{-2}\Delta_i) = \frac{1}{1 - X^{-\alpha_i}}(q^{-2} - q^{-2}X^{-\alpha_i} + 1 - X^{-\alpha_i}s_i - q^{-2} + q^{-2}s_i) \\ &= \frac{1 - q^{-2}X^{-\alpha_i}}{1 - X^{-\alpha_i}} + s_i \frac{q^{-2} - X^{\alpha_i}}{1 - X^{\alpha_i}} = (1 + s_i) \left(\frac{1 - q^{-2}X^{-\alpha_i}}{1 - X^{-\alpha_i}} \right). \end{aligned}$$

□

Remark 4.6. Slightly renormalizing the generators of the affine Hecke algebra by setting $\tilde{T}_i = q^{-1}T_{s_i}$ allows one to let $q^{-1} = 0$ so that \tilde{T}_i acts on $\mathbb{K}[P]$ by $\tilde{\Delta}_i$. This is the action of the *nil affine Hecke algebra* on $\mathbb{K}[P]$. Since the \tilde{T}_i satisfy the braid relations so do the $\tilde{\Delta}_i$. The first formula in Proposition 4.1 shows that Δ_i is a conjugate of $\tilde{\Delta}_i$ and so the Δ_i also satisfy the braid relations. Although C_i equals $\tilde{\Delta}_i$ at $q^{-2} = 0$, the operators C_i do *not* satisfy the braid relations. Furthermore, if $w_0 = s_{i_1} \cdots s_{i_\ell}$ is a reduced word for the longest element then

$$C_{i_1} \cdots C_{i_\ell} = W_0(q^{-2})\mathbf{1}_0 + q^{-2}(\text{extra terms}).$$

In contrast to the case for Weyl characters (when $q^{-2} = 0$), because of the $q^{-2}(\text{extra terms})$ the Hall-Littlewood polynomial cannot be generated by applying the product $C_{i_1} \cdots C_{i_\ell}$ unless one somehow knows how to throw away the extra terms.

Remark 4.7. As operators on $\mathbb{K}[P]$,

$$q - T_{s_i} = \left(\frac{q^{-1} - qX^{-\alpha_i}}{1 - X^{-\alpha_i}} \right) (1 - s_i) \quad \text{and} \quad \mathbf{1}_0 = \frac{1}{W_0(q^{-2})} \sum_{w \in W} w \left(\prod_{\alpha \in R^+} \frac{1 - q^{-2}X^{-\alpha}}{1 - X^{-\alpha}} \right).$$

The second formula is equivalent to Macdonald's spherical function formula (4.13).

4.3 Root operators

The idea of root operators is to give an alcove walk interpretation of the action of the operator C_i on $\mathbb{K}[P]$ by considering the projections of the alcove walks onto the line perpendicular to H_{α_i} . The main point is the identity (4.21) which gives a combinatorial description of the action of C_i on $\mathbb{K}[P]$. The appropriate combinatorics is more or less forced by the *Leibnitz rule* or *tensor product rule* for the operator C_i given in (4.27).

If \bar{p} is the walk in (4.16) then

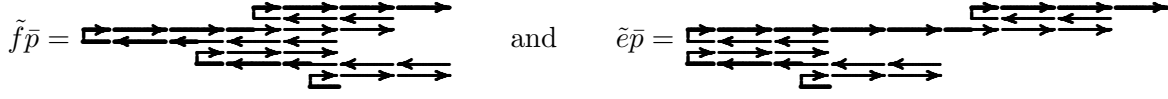

The precise rules for the limiting cases, when $d^+(\bar{p})$ or $d^-(\bar{p}) = 0$, are illustrated by the following example, where the dashed arrows indicate the action of \tilde{e} and \tilde{f} .

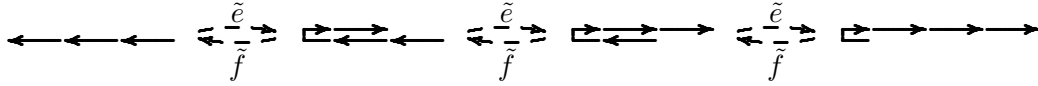

with $\tilde{f}(\leftarrow\leftarrow\leftarrow) = 0$ and $\tilde{e}(\rightarrow\rightarrow\rightarrow) = 0$.

With notations for $d^+(\bar{p})$ and $d^-(\bar{p})$ as in (4.18) and (4.19), define

$$d_i^+(p) = d^+(\bar{p}) \quad \text{and} \quad d_i^-(p) = d^-(\bar{p}), \quad (4.20)$$

where \bar{p} is the projection of p onto the line perpendicular to α_i . The walks $\tilde{e}_i p$ and $\tilde{f}_i p$ are the walks obtained from p by changing the corresponding edges p (so that the projections of $\tilde{e}_i p$ and $\tilde{f}_i p$ are $\tilde{e}\bar{p}$ and $\tilde{f}\bar{p}$, respectively).

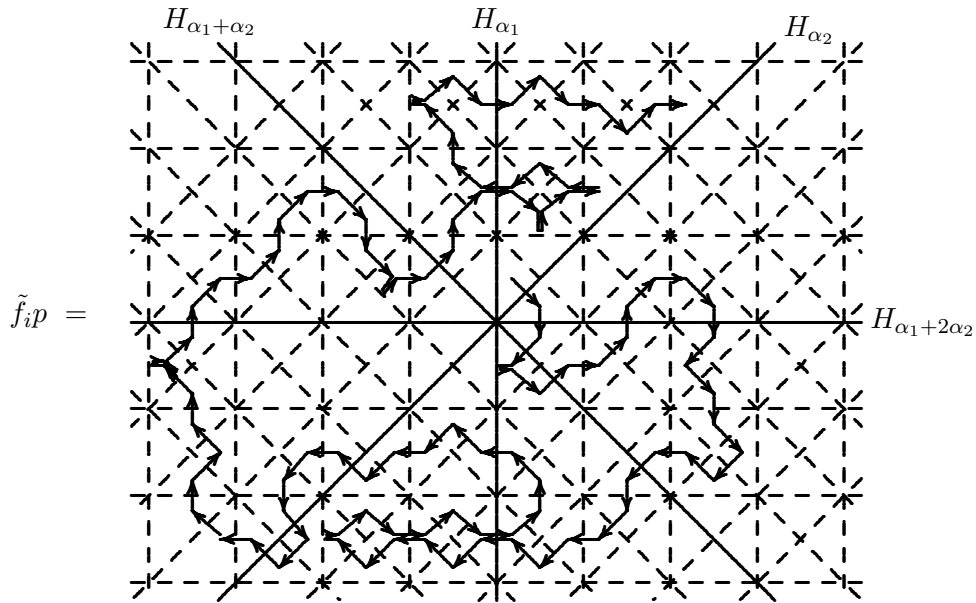

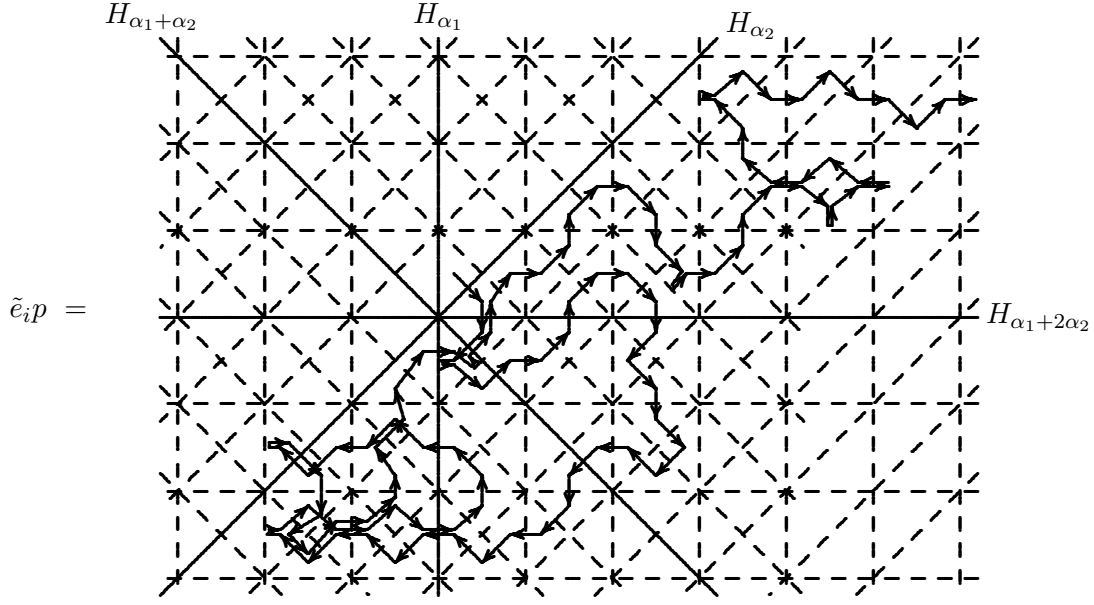

The i -string of p $S_i(p)$ is the set of paths generated from p by applying the root operators \tilde{e}_i and \tilde{f}_i . The head of the i -string is the path h in $S_i(p)$ which has $d_i^-(h) = 0$. If $\text{wt}(h) = \lambda$ and λ is on the positive side of H_{α_i} then

$$C_i X^\lambda = q^{-1} X^{s_i \lambda} T_{s_i}^{-1} + (1 - q^{-2})(X^{s_i \lambda} + X^{s_i \lambda + \alpha_i} + \dots + X^{\lambda - \alpha_i}) + X^\lambda, \quad (4.21)$$

and the terms in this sum correspond to the paths in the i -string $S_i(h)$.

4.4 q -Crystals

The q -crystals provide a combinatorial model for the spherical Hecke algebra $\mathbf{1}_0 \tilde{H} \mathbf{1}_0$ in the basis of Hall-Littlewood polynomials. Three structural properties motivate the definition of q -crystals:

- (a) The Hall-Littlewood polynomials are normalized versions of the basis $\mathbf{1}_0 X^\lambda \mathbf{1}_0$.
- (b) The element $\mathbf{1}_0$ is characterized by the property that $C_i \mathbf{1}_0 = (1 + q^{-2}) \mathbf{1}_0$.
- (c) The action of C_i on $\tilde{H} \mathbf{1}_0 \cong \mathbb{K}[P]$ is captured in the combinatorics of i -strings.

These properties indicate that the combinatorics of Hall-Littlewood polynomials can be captured with the root operators.

Let

$$B_{\text{univ}} \text{ be the set of positively folded alcove walks which begin in the } 0\text{-polygon } WA. \quad (4.22)$$

If B is a finite subset of B_{univ} the character of B is

$$\text{char}(B) = \sum_{p \in B} q^{-(\iota(p) + \varphi(p) - f(p))} (1 - q^{-2})^{f(p) - c(p)} X^{\text{wt}(p)}. \quad (4.23)$$

where p has $f(p)$ folds, $\iota(p)A$ is the alcove where p begins, $\text{wt}(p) + \varphi(p)A$ is the alcove where p ends and

$$c(p) \text{ the number of folds of } p \text{ touching one of the hyperplanes } H_{\alpha_1}, \dots, H_{\alpha_n}. \quad (4.24)$$

A q -crystal is a finite subset B of B_{univ} which is closed under the action of the root operators.

A positively folded alcove walk is i -dominant if it never touches the hyperplane $H_{\alpha_i, -1}$. The head h of an i -string $S_i(p)$ is i -dominant and $S_i(h) = S_i(p)$. A positively folded alcove walk

$$p \text{ is dominant if } p \subseteq C - \rho, \quad (4.25)$$

where

$$C - \rho = \{\mu \in \mathfrak{h}_{\mathbb{R}}^* \mid \langle \mu, \alpha_i^\vee \rangle > -1 \text{ for } 1 \leq i \leq n\}$$

In other words, a positively folded alcove walk p is dominant if it is i -dominant for all i , $1 \leq i \leq n$.

Theorem 4.8. *Let B be a q -crystal. Then, with notations as in (4.23-4.25),*

$$\text{char}(B) = \sum_{\substack{p \in B \\ p \subseteq C - \rho}} q^{-(\iota(p) + \varphi(p) - f(p))} (1 - q^{-2})^{f(p) - c(p)} P_{\text{wt}(p)}.$$

Proof. If p is a dominant walk let

$$B_q(p) \text{ be the } q\text{-crystal generated by } p$$

under the action of the root operators \tilde{e}_i and \tilde{f}_i . The point is that the set of all positively folded alcove walks is partitioned into “equivalence classes” given by the sets $B_q(p)$ such that $p \in B_{\text{univ}}$ is dominant and p is the unique dominant walk in $B_q(p)$. Because $\mathbf{1}_0$ is characterized by the property that $C_i \mathbf{1}_0 = (1 + q^{-2}) \mathbf{1}_0$ and the action of C_i is modeled by the combinatorics of i -strings (4.24), this equivalence relation is generated by the relations $p \sim \tilde{f}_i p$ and $p \sim \tilde{e}_i p$. \square

4.5 Products and restrictions

The results in this section are generalizations of the Littlewood-Richardson rules. These are obtained as corollaries of Theorem 4.8.

The combinatorial definition of the root operators given above is essentially a consequence of the *Leibnitz rule* for the Demazure operator,

$$\Delta_i(fg) = \Delta_i(f)g + (s_i f)(\Delta_i g), \quad \text{for } f, g \in \mathbb{K}[P]. \quad (4.26)$$

The corresponding rule for the operators C_i is

$$C_i(fg) = (C_i f)g + (s_i f)((C_i - (1 + q^{-2}))g), \quad \text{for } f, g \in \mathbb{K}[P]. \quad (4.27)$$

This identity is implicit in the additivity in λ of the relation in Proposition 3.2e (the product $T_{s_i} X^{\lambda+\mu} = (T_{s_i} X^\lambda) X^\mu$ can be expanded in two different ways using Proposition 3.2e).

In order to define the product of $p_1 \otimes p_2$ of walks $p_1, p_2 \in B_{\text{univ}}$ the final direction $\varphi(p_1)$ of p_1 and the initial direction $\iota(p_2)$ of p_2 need to be taken into account. (To properly model the multiplication of Hall-Littlewood polynomials we must account for the effect of $\mathbf{1}_0$ in the product $P_\mu \mathbf{1}_0 P_\nu \mathbf{1}_0$ and we cannot just concatenate walks as in the alcove walk algebra). Define $p_1 \otimes p_2$, recursively, by

$$\begin{array}{ll} \text{If } \varphi(p_1) = \iota(p_2) & \text{then } p_1 \otimes p_2 = p_1 p_2, \text{ the concatenation of } p_1 \text{ and } p_2, \text{ and} \\ \text{if } \varphi(p_1) \neq \iota(p_2) & \text{then } p_1 \otimes p_2 = p'_1 \otimes p_2, \end{array}$$

where p'_1 is the alcove walk constructed by the following procedure. Let $c_{i_1}^{\varepsilon_1} \cdots c_{i_r}^{\varepsilon_r}$ be a minimal length walk from $\varphi(p_1)$ to $\iota(p_2)$. If $\varepsilon_1 = -$ let $p'_1 = p_1 c_{i_1}^-$. If $\varepsilon_1 = +$ let H_{α_j} be the hyperplane

crossed by the last step of $p_1 c_{i_1}^+$ and change the last negative crossing of $H_{\alpha, j}$ in p_1 to a fold to obtain a new path p'_1 with $\varphi(p'_1) = \varphi(p_1 c_{i_1}^+)$.

In terms of root operators, the Leibnitz rule (4.27) translates to the property

$$\begin{aligned} \tilde{e}_i(p_1 \otimes p_2) &= \begin{cases} (\tilde{e}_i p_1) \otimes p_2, & \text{if } d_i^+(p_1) \geq d_i^-(p_2), \\ p_1 \otimes (\tilde{e}_i p_2), & \text{if } d_i^+(p_1) < d_i^-(p_2), \end{cases} \quad \text{and} \\ \tilde{f}_i(p_1 \otimes p_2) &= \begin{cases} (\tilde{f}_i p_1) \otimes p_2, & \text{if } d_i^+(p_1) > d_i^-(p_2) \quad (\overline{p_1 \otimes p_2} = \text{---} \overrightarrow{\text{---}} \text{---}), \\ p \otimes (\tilde{f}_i q), & \text{if } d_i^+(p) \leq d_i^-(q) \quad (\overline{p \otimes q} = \text{---} \overrightarrow{\text{---}} \text{---}), \end{cases} \end{aligned} \quad (4.28)$$

for $p_1, p_2 \in B_{\text{univ}}$. It follows from this version of the Leibnitz rule that if B_1 and B_2 are q -crystals then the product

$$B_1 \otimes B_2 = \{p_1 \otimes p_2 \mid p_1 \in B_1, p_2 \in B_2\} \quad \text{is also a } q\text{-crystal,} \quad (4.29)$$

and

$$\text{char}(B_1 \otimes B_2) = \text{char}(B_1)\text{char}(B_2). \quad (4.30)$$

This last property is not completely trivial. The general case follows from the rank one case (projecting onto the line perpendicular to H_α). More importantly, the definition of the product \otimes is forced by (4.28-4.30).

The following theorem is a version of [Sc, Theorem 1.2] and results in [KM] and [Ha].

Theorem 4.9. *Recall the notations from Theorem 4.2. If $\lambda \in P^+$ let $B_q(p_\lambda)$ be the q -crystal generated by p_λ , where p_λ is a fixed minimal length alcove walk from A to $\lambda + A$. For $\mu, \nu \in P^+$,*

$$P_\mu P_\nu = \sum_{\substack{p \in B_q(p_\nu) \\ p_\mu \otimes p \subseteq C - \rho}} q^{-(\ell(\iota(p)) + \ell(\varphi(p)) - f(p))} (1 - q^{-2})^{f(p) - c(p)} P_{\mu + \text{wt}(p)}.$$

Proof. Using (4.29) and (4.30) and applying Theorem 4.8 to the q -crystal $B_q(p_\mu) \otimes B_q(p_\nu)$ gives

$$\begin{aligned} P_\mu P_\nu \mathbf{1}_0 &= \text{char}(B_q(p_\mu))\text{char}(B_q(p_\nu))\mathbf{1}_0 = \text{char}((B_q(p_\mu) \otimes B_q(p_\nu))\mathbf{1}_0) \\ &= \sum_{\substack{p = p_1 \otimes p_2 \in B_q(p_\mu) \otimes B_q(p_\nu) \\ p_1 \otimes p_2 \subseteq C - \rho}} q^{-(\ell(\iota(p)) + \ell(\varphi(p)) - f(p))} (1 - q^{-2})^{f(p) - c(p)} P_{\mu + \text{wt}(p_2)} \mathbf{1}_0 \end{aligned}$$

since every path in $p_1 \in B_q(p_\mu)$ which is contained in $C - \rho$ has weight μ (so that $\text{wt}(p_1 \otimes p_2) = \mu + \text{wt}(p_2)$.) \square

Fix $J \subseteq \{1, 2, \dots, n\}$. The subgroup of W generated by the reflections in the hyperplanes H_{α_j} , $j \in J$,

$$W_J = \langle s_j \mid j \in J \rangle, \quad \text{acts on } \mathfrak{h}_{\mathbb{R}}^*, \quad \text{with} \quad C_J = \{\mu \in \mathfrak{h}_{\mathbb{R}}^* \mid \langle \mu, \alpha_j^\vee \rangle > 0 \text{ for } j \in J\}$$

as a fundamental chamber. Let $H_J = \text{span}\{T_w^{-1} \mid w \in W_J\}$ and let $\mathbf{1}_J \in H_J$ be given by

$$\mathbf{1}_J^2 = \mathbf{1}_J \quad \text{and} \quad T_w^{-1} \mathbf{1}_J = q^{-\ell(w)} \mathbf{1}_J, \quad \text{for } w \in W_J.$$

For $\mu \in P$ let W_μ^J be the stabilizer of μ under the W_J action on P and

$$\text{define } P_\mu^J(X; q^{-2}) \in \mathbb{K}[P]^{W_J} \quad \text{by} \quad P_\mu^J(X; q^{-2})\mathbf{1}_0 = \left(\sum_{w \in W_\mu^J} q^{-\ell(w)} T_{w^{-1}}^{-1} \right) X^\mu \mathbf{1}_0, \quad (4.31)$$

where W_μ^J is a set of minimal length coset representatives for the cosets in W_J/W_μ^J . Then

$$\text{up to normalization } P_\lambda^J(X, q^{-2})\mathbf{1}_0 \quad \text{equals} \quad \mathbf{1}_J X^\lambda \mathbf{1}_0, \quad (4.32)$$

and

$$\mathbf{1}_J \tilde{H} \mathbf{1}_0 \quad \text{has basis} \quad \{P_\lambda^J \mathbf{1}_0 \mid \lambda \in P_J^+\}, \quad \text{where } P_J^+ = P \cap \overline{C_J}. \quad (4.33)$$

with $\overline{C_J} = \{\mu \in \mathfrak{h}_\mathbb{R}^* \mid \langle \mu, \alpha_j^\vee \rangle > 0 \text{ for } j \in J\}$.

Theorem 4.10. *Recall the notations from Theorem 4.2. If $\mu \in P^+$ let $B_q(p_\mu)$ be the q -crystal generated by p_μ , where p_μ is a fixed minimal length alcove walk from A to $\mu + A$. Let $\lambda \in P^+$ and let $J \subseteq \{1, 2, \dots, n\}$. Then*

$$P_\lambda = \sum_{\substack{p \in B(\lambda) \\ p \subseteq C_J - \rho_J}} q^{-(\ell(\iota(p)) + \ell(\varphi(p)) - f(p))} (1 - q^{-2})^{f(p) - c_J(p)} P_{\text{wt}(p)}^J,$$

where $C_J - \rho_J = \{\mu \in \mathfrak{h}_\mathbb{R}^* \mid \langle \mu, \alpha_j^\vee \rangle > -1 \text{ for } j \in J\}$ and $c_J(p)$ is the number of folds of p which touch a hyperplane H_{α_j} with $j \in J$.

Proof. A J -crystal is a set of positively folded alcove walks B which is closed under the operators \tilde{e}_j, \tilde{f}_j , for $j \in J$. Since $P_\lambda \mathbf{1}_0 = \text{char}(B_q(p_\lambda))\mathbf{1}_0$, the statement follows by applying Theorem 4.8 to $B_q(p_\lambda)$ viewed as a J -crystal. \square

5 Weyl characters and crystals

Section 5.1 is an exposition of the theory of Weyl characters analogous to the theory of Schur functions in [Mac2, Ch. 1]. The element a_ρ in Theorem 5.1 is the *Weyl denominator*, Lemma 5.2 is a generalization of the *Jacobi-Trudi formula* and the formulas in Proposition 5.3 are the *quantum dimension formula* and the *Weyl dimension formula*, respectively. The results in Proposition 5.4b and 5.4c are the *Kostant partition function formula* and the *Brauer-Klimyk formula*, respectively. Sections 5.2–5.6 give an elementary exposition of the theory of crystals and the path model and Section 5.7 explains the relationship between crystals and column strict tableaux. The presentation here is designed to make clear the relationship between the general path model and the crystal operators of Lascoux and Schützenberger used in the type A case [LS] (see [Ki] for a nice presentation).

The relationship between the path model used in this section and the alcove walks used in Sections 3 and 4 is as follows. Let $r \in \mathbb{R}_{>0}$. The *dilation* which replaces the fundamental alcove A by $\frac{1}{r}A$ induces important maps between the corresponding affine Hecke algebras,

$$\tilde{H}_A \hookrightarrow \tilde{H}_{\frac{1}{r}A} \quad \text{and} \quad \tilde{H}_{\frac{1}{r}A} \longrightarrow \tilde{H}_A,$$

corresponding to stretching the walks by a factor of r . As r gets large the alcove gets small and alcove walks become continuous paths in the limit. At $q^{-1} = 0$ the formula for the Hall-Littlewood polynomial in Theorem 4.2a becomes the path model for Weyl characters discovered by P. Littelmann [Lil-3]. In other words, the q -crystals become “classical” crystals in the limit.

5.1 Schur functions

Use notations for the Weyl group W and the lattice P as in Section 2. The *group algebra* of P is the ring

$$\mathbb{Z}[P] \quad \text{with basis} \quad \{X^\lambda \mid \lambda \in P\} \quad \text{and product} \quad X^\lambda X^\mu = X^{\lambda+\mu},$$

for $\lambda, \mu \in P$. The group W acts on $\mathbb{Z}[P]$ by

$$wX^\lambda = X^{w\lambda}, \quad \text{for } w \in W, \lambda \in P.$$

The ring of *symmetric functions* and *Fock space* are

$$\begin{aligned} \mathbb{Z}[P]^W &= \{f \in \mathbb{Z}[P] \mid wf = f \text{ for all } w \in W\} \quad \text{and} \\ \mathbb{Z}[P]^{\det} &= \{f \in \mathbb{Z}[P] \mid wf = \det(w)f \text{ for all } w \in W\}, \end{aligned} \quad (5.1)$$

respectively. For $\lambda \in P$ define

$$m_\lambda = \sum_{\gamma \in W\lambda} X^\gamma \quad \text{and} \quad a_\lambda = \sum_{w \in W} \det(w)X^{w\lambda}. \quad (5.2)$$

The straightening laws for these elements are

$$m_{w\lambda} = m_\lambda \quad \text{and} \quad a_{w\lambda} = \det(w)a_\lambda, \quad \text{for } w \in W \text{ and } \lambda \in P. \quad (5.3)$$

The second relation implies that $a_\lambda = 0$ if there exists $w \in W_\lambda$ with $\det(w) \neq 1$, and it follows from the straightening laws that

$$\begin{aligned} \mathbb{Z}[P]^W &\text{ has basis } \{m_\lambda \mid \lambda \in P^+\}, \quad \text{and} \\ \mathbb{Z}[P]^{\det} &\text{ has basis } \{a_{\lambda+\rho} \mid \lambda \in P^+\}, \end{aligned} \quad (5.4)$$

where P^+ and ρ are as in (2.14) and (2.16), respectively.

The *Weyl characters* or *Schur functions* are defined by

$$s_\lambda = \frac{a_{\lambda+\rho}}{a_\rho}, \quad \text{for } \lambda \in P. \quad (5.5)$$

The following theorem shows that the s_λ are elements of $\mathbb{Z}[P]$ and that

$$\mathbb{Z}[P]^W \quad \text{has basis} \quad \{s_\lambda \mid \lambda \in P^+\}. \quad (5.6)$$

Theorem 5.1. *Fock space $\mathbb{Z}[P]^{\det}$ is a free $\mathbb{Z}[P]^W$ module with generator*

$$a_\rho = x^\rho \prod_{\alpha \in R^+} (1 - x^{-\alpha}) \quad \text{and the map} \quad \begin{array}{ccc} \mathbb{Z}[P]^W & \longrightarrow & \mathbb{Z}[P]^{\det} \\ f & \longmapsto & a_\rho f \\ s_\lambda & \longmapsto & a_{\lambda+\rho} \end{array}$$

is a $\mathbb{Z}[P]^W$ module isomorphism.

Proof. Let $f \in \mathbb{Z}[P]^{\det}$ and let $\alpha \in R^+$. If f_γ is the coefficient of x^γ in f then

$$\sum_{\gamma \in P} f_\gamma x^\gamma = f = -s_\alpha f = \sum_{\gamma \in P} -f_\gamma x^{s_\alpha \gamma}, \quad \text{and so} \quad f = \sum_{\substack{\gamma \in P \\ \langle \gamma, \alpha^\vee \rangle \geq 0}} f_\gamma (x^\gamma - x^{s_\alpha \gamma}),$$

since $f_{s_\alpha \gamma} = -f_\gamma$. Since each term $x^\gamma - x^{s_\alpha \gamma}$ is divisible by $1 - x^{-\alpha}$, f is divisible by $1 - x^{-\alpha}$, and thus

$$\text{each } f \in \mathbb{Z}[P]^{\det} \text{ is divisible by } x^\rho \prod_{\alpha \in R^+} (1 - x^{-\alpha}) \quad (5.7)$$

since the polynomials $1 - x^{-\alpha}$, $\alpha \in R^+$ are coprime in $\mathbb{Z}[P]$ and x^ρ is a unit in $\mathbb{Z}[P]$. Comparing coefficients of the maximal terms in a_ρ and $x^\rho \prod_{\alpha \in R^+} (1 - x^{-\alpha})$ shows that

$$a_\rho = x^\rho \prod_{\alpha \in R^+} (1 - x^{-\alpha}).$$

Thus each $f \in \mathbb{Z}[P]^{\det}$ is divisible by a_ρ and so the inverse of multiplication by a_ρ is well defined. \square

The *dot action* of S_n on P is given by

$$w \circ \mu = w(\mu + \rho) - \rho, \quad \text{for } w \in S_n, \mu \in P. \quad (5.8)$$

The straightening law

$$s_{w \circ \mu} = \det(w) s_\mu, \quad \text{for } \mu \in P, w \in W. \quad (5.9)$$

for the Schur functions follows from the straightening law for the a_μ in (5.3).

Lemma 5.2. *Let $f \in \mathbb{Z}[P]^W$ and write $f = \sum_{\gamma} f_\gamma x^\gamma$ so that f_γ is the coefficient of x^γ in f .*

Then

$$f = \sum_{\mu \in P^+} f_\mu m_\mu = \sum_{\lambda \in P^+} \eta^\lambda s_\lambda, \quad \text{where} \quad \eta^\lambda = \sum_{w \in W} \det(w) f_{\lambda + \rho - w\rho}.$$

Proof. The first equality is immediate from the definition of m_μ . Since $f \in \mathbb{Z}[P]^W$ and the s_λ , $\lambda \in P^+$, are a basis of $\mathbb{Z}[P]^W$, the element f can be written as a linear combination of s_λ . Then, since $e^{\lambda + \rho}$ is the unique dominant term in $a_{\lambda + \rho}$,

$$\begin{aligned} \eta_\lambda &= (\text{coefficient of } s_\lambda \text{ in } f) = (\text{coefficient of } a_{\lambda + \rho} \text{ in } f a_\rho) \\ &= \left(\text{coefficient of } e^{\lambda + \rho} \text{ in } \sum_{\mu \in P} \sum_{w \in W} \det(w) f_\mu e^{\mu + w\rho} \right). \end{aligned}$$

\square

Proposition 5.3. *If $\nu \in \mathfrak{h}_{\mathbb{R}}^*$ and $f = \sum_{\mu \in P} f_\mu e^\mu \in \mathbb{Z}[P]$ define $f(e^\nu) = \sum_{\mu \in P} f_\mu e^{\langle \mu, \nu \rangle}$. Let $\lambda \in P^+$,*

$t \in \mathbb{R}_{>0}$, $q = e^t$ and $\rho^\vee = \frac{1}{2} \sum_{\alpha \in R^+} \alpha^\vee$. Then

$$s_\lambda(q^{\rho^\vee}) = \prod_{\alpha \in R^+} \frac{[\langle \lambda + \rho, \alpha^\vee \rangle]}{[\langle \rho, \alpha^\vee \rangle]} \quad \text{and} \quad s_\lambda(1) = \prod_{\alpha \in R^+} \frac{\langle \lambda + \rho, \alpha^\vee \rangle}{\langle \rho, \alpha^\vee \rangle}$$

where $[k] = (q^k - 1)/(q - 1)$ for an integer $k \neq 0$.

Proof.

$$\begin{aligned} a_{\lambda+\rho}(e^{t\rho^\vee}) &= \sum_{w \in W} \det(w) e^{\langle w(\lambda+\rho), t\rho^\vee \rangle} = \sum_{w \in W} \det(w) e^{\langle w\rho^\vee, t(\lambda+\rho) \rangle} \\ &= a_{\rho^\vee}(e^{t(\lambda+\rho)}) = e^{\langle \rho^\vee, t(\lambda+\rho) \rangle} \prod_{\alpha \in R^+} (1 - e^{\langle -\alpha^\vee, t(\lambda+\rho) \rangle}). \end{aligned}$$

Thus

$$s_\lambda(e^{t\rho^\vee}) = \frac{a_{\lambda+\rho}(e^{t\rho^\vee})}{a_\rho(e^{t\rho^\vee})} = \frac{e^{\langle \rho^\vee, t(\lambda+\rho) \rangle}}{e^{\langle \rho^\vee, t\rho \rangle}} \prod_{\alpha \in R^+} \frac{1 - e^{\langle -\alpha^\vee, t(\lambda+\rho) \rangle}}{1 - e^{\langle -\alpha^\vee, t\rho \rangle}} = q^{-\langle \lambda, \rho^\vee \rangle} \prod_{\alpha \in R^+} \frac{q^{\langle \lambda+\rho, \alpha^\vee \rangle} - 1}{q^{\langle \rho, \alpha^\vee \rangle} - 1}$$

and

$$s_\lambda(1) = \lim_{q \rightarrow 1} s_\lambda(q^{\rho^\vee}) = \prod_{\alpha \in R^+} \frac{\langle \lambda + \rho, \alpha^\vee \rangle}{\langle \rho, \alpha^\vee \rangle}.$$

□

The *weight multiplicities* are the integers $K_{\lambda\gamma}$, $\lambda \in P^+$, $\gamma \in P$, defined by the equations

$$s_\lambda = \sum_{\gamma \in P} K_{\lambda\gamma} x^\gamma = \sum_{\mu \in P^+} K_{\lambda\mu} m_\mu. \quad (5.10)$$

The *tensor product multiplicities* are the integers $c_{\mu\nu}^\lambda$, $\mu, \nu, \lambda \in P^+$, defined by the equations

$$s_\mu s_\nu = \sum_{\lambda \in P^+} c_{\mu\nu}^\lambda s_\lambda. \quad (5.11)$$

The *partition function* is the function $p: P \rightarrow \mathbb{Z}_{\geq 0}$ defined by the equation

$$\prod_{\alpha \in R^+} \frac{1}{1 - x^{-\alpha}} = \sum_{\gamma \in P} p(\gamma) x^{-\gamma}. \quad (5.12)$$

Proposition 5.4. *Let $\lambda, \mu, \nu \in P^+$.*

(a) $K_{\lambda\lambda} = 1$, $K_{\lambda, w\mu} = K_{\lambda\mu}$, for $w \in W$, and $K_{\lambda\mu} = 0$ unless $\mu \leq \lambda$.

(b) $K_{\lambda\mu} = \sum_{w \in W} \det(w) p(w(\lambda + \rho) - (\mu + \rho))$.

(c) $c_{\mu\nu}^\lambda = \sum_{v, w \in W} \det(vw) p(v(\mu + \rho) + w(\nu + \rho) - (\lambda + \rho) - \rho)$.

Proof. (a) The equality $K_{\lambda, w\mu} = K_{\lambda\mu}$ follows from the definition and the fact that $s_\lambda \in \mathbb{Z}[P]^W$. If $w \neq 1$ then $w(\lambda + \rho) < \lambda + \rho$ so that $w(\lambda + \rho) - \rho < \lambda$ and

$$s_\lambda = \left(\sum_{w \in W} \det(w) x^{w(\lambda+\rho)-\rho} \right) \cdot \prod_{\alpha \in R^+} \frac{1}{1 - x^{-\alpha}} = x^\lambda + (\text{lower terms in dominance order}).$$

Thus $K_{\lambda\lambda} = 1$ and $K_{\lambda\mu} = 0$ unless $\mu \leq \lambda$.

(b) The coefficient of x^μ in

$$s_\lambda = \left(\sum_{w \in W} \det(w) x^{w(\lambda+\rho)-\rho} \right) \prod_{\alpha \in R^+} \frac{1}{1 - x^{-\alpha}} = \sum_{\substack{w \in W \\ \gamma \in Q^+}} \det(w) p(\gamma) x^{w(\lambda+\rho)-\rho-\gamma},$$

has a contribution $\det(w)p(\gamma)$ when $w(\lambda + \rho) - \rho - \gamma = \mu$ so that $\gamma = w(\lambda + \rho) - (\mu + \rho)$.

(c) Let $\varepsilon = \sum_{w \in W} \det(w)w$. Since $c_{\mu\nu}^\lambda$ is the coefficient of $x^{\nu+\rho}$ in

$$\begin{aligned} s_\mu s_\nu a_\rho &= \frac{\varepsilon(x^{\mu+\rho})\varepsilon(x^{\nu+\rho})}{a_\rho} = \left(\sum_{v,w \in W} \det(vw)x^{v(\mu+\rho)+w(\nu+\rho)-\rho} \right) \left(\prod_{\alpha \in R^+} \frac{1}{1-x^{-\alpha}} \right) \\ &= \sum_{\substack{v,w \in W \\ \gamma \in Q^+}} \det(vw)p(\gamma)x^{v(\mu+\rho)+w(\nu+\rho)-\gamma-\rho}, \end{aligned}$$

there is a contribution $\det(vw)p(\gamma)$ to the coefficient $c_{\mu\nu}^\lambda$ when $\lambda + \rho = v(\mu + \rho) + w(\nu + \rho) - \gamma - \rho$ so that $\gamma = v(\mu + \rho) + w(\nu + \rho) - (\lambda + \rho) - \rho$. \square

Fix $J \subseteq \{1, 2, \dots, n\}$. The subgroup of W generated by the reflections in the hyperplanes H_{α_j} , $j \in J$,

$$W_J = \langle s_j \mid j \in J \rangle, \quad \text{acts on } \mathfrak{h}_{\mathbb{R}}^*, \quad \text{with} \quad C_J = \{\mu \in \mathfrak{h}_{\mathbb{R}}^* \mid \langle \mu, \alpha_j^\vee \rangle > 0 \text{ for } j \in J\} \quad (5.13)$$

as a fundamental chamber. The group W_J acts on P and

$$\mathbb{Z}[P]^{W_J} = \{f \in \mathbb{Z}[P] \mid wf = f \text{ for } w \in W_J\} \quad (5.14)$$

is a subalgebra of $\mathbb{Z}[P]$ which contains $\mathbb{Z}[P]^W$. If $\overline{C}_J = \{\mu \in \mathfrak{h}_{\mathbb{R}}^* \mid \langle \mu, \alpha_j^\vee \rangle \geq 0 \text{ for } j \in J\}$,

$$P_J^+ = P \cap \overline{C}_J, \quad \rho_J = \sum_{j \in J} \omega_j, \quad (5.15)$$

$$a_\mu^J = \sum_{w \in W_J} \det(w)wX^\mu, \quad \text{for } \mu \in P, \quad \text{and} \quad s_\lambda^J = \frac{a_{\lambda+\rho_J}^J}{a_{\rho_J}^J}, \quad \text{for } \lambda \in P, \quad (5.16)$$

then

$$\{s_\lambda^J \mid \lambda \in P_J^+\} \text{ is a basis of } \mathbb{Z}[P]^{W_J}.$$

The *restriction multiplicities* are the integers $c_{J,\nu}^\lambda$ given by

$$s_\lambda = \sum_{\nu \in P_J^+} c_{J,\nu}^\lambda s_\nu^J. \quad (5.17)$$

5.2 Paths

Let $\lambda \in P$. The *straight line path* to λ is the map

$$p_\lambda: [0, 1] \rightarrow \mathfrak{h}_{\mathbb{R}}^* \quad \text{given by} \quad p_\lambda(t) = \lambda t. \quad (5.18)$$

Let $\ell_1, \ell_2 \in \mathbb{R}_{\geq 0}$. The *concatenation* of maps $p_1: [0, \ell_1] \rightarrow \mathfrak{h}_{\mathbb{R}}^*$ and $p_2: [0, \ell_2] \rightarrow \mathfrak{h}_{\mathbb{R}}^*$ is the map $p_1 \otimes p_2: [0, \ell_1 + \ell_2] \rightarrow \mathfrak{h}_{\mathbb{R}}^*$ given by

$$(p_1 \otimes p_2)(t) = \begin{cases} p_1(t), & \text{for } t \in [0, \ell_1], \\ p_1(\ell_1) + p_2(t - \ell_1), & \text{for } t \in [\ell_1, \ell_1 + \ell_2]. \end{cases} \quad (5.19)$$

Let $r, \ell \in \mathbb{R}_{\geq 0}$. The *r-stretch* of a map $p: [0, \ell] \rightarrow \mathfrak{h}_{\mathbb{R}}^*$ is the map $rp: [0, r\ell] \rightarrow \mathfrak{h}_{\mathbb{R}}^*$ given by

$$(rp)(t) = r \cdot p(t/r). \quad (5.20)$$

The *reverse* of a map $p: [0, \ell] \rightarrow \mathfrak{h}_{\mathbb{R}}^*$ is the map $p^*: [0, \ell] \rightarrow \mathfrak{h}_{\mathbb{R}}^*$ given by

$$p^*(t) = p(\ell - t) - p(\ell). \quad (5.21)$$

The *weight* of a map $p: [0, \ell] \rightarrow \mathfrak{h}_{\mathbb{R}}^*$ is the endpoint of p ,

$$\text{wt}(p) = p(\ell). \quad (5.22)$$

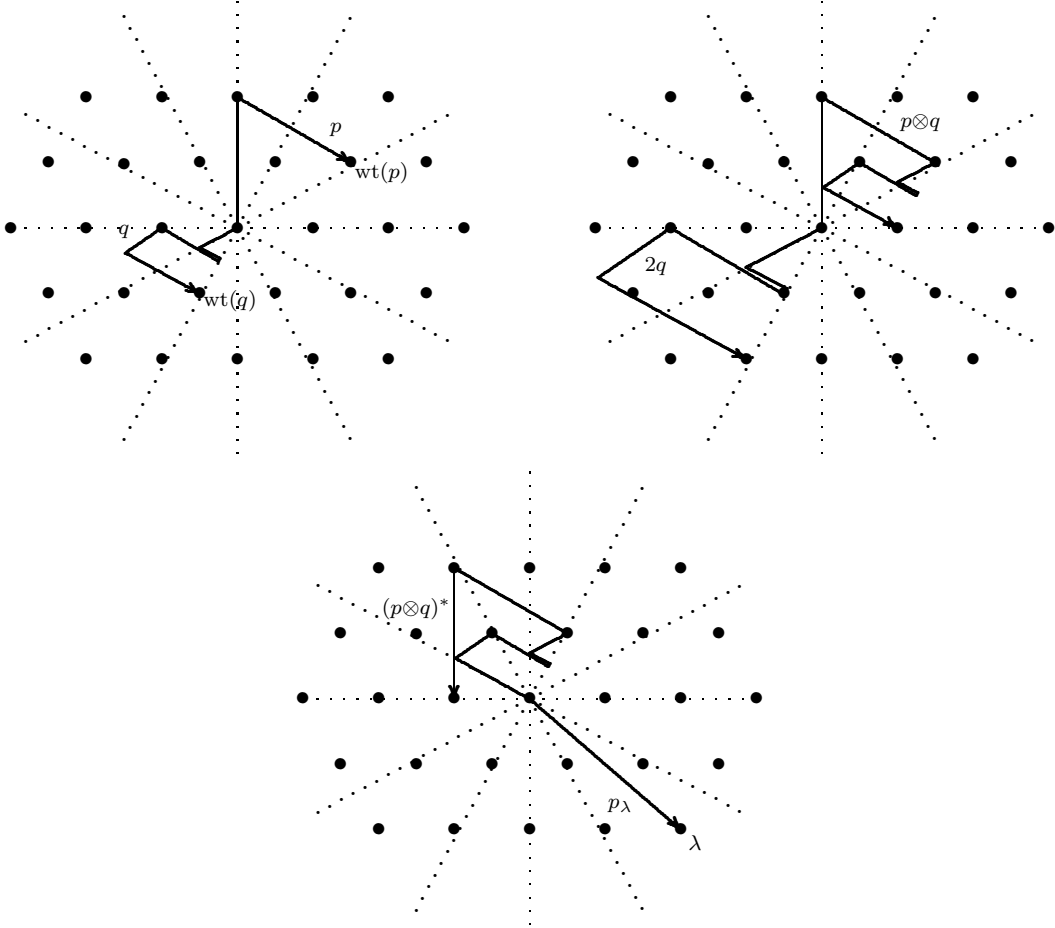

Let

$$B_{\text{univ}} \quad \text{be the set of maps generated by the straight line paths} \quad (5.23)$$

by operations of concatenation, reversing and stretching.

A *path* is an element $p: [0, \ell] \rightarrow \mathfrak{h}_{\mathbb{R}}^*$ in B_{univ} . Let B be a set of paths (a subset of B_{univ}). The *character* of B is the element of $\mathbb{Z}[P]$ given by

$$\text{char}(B) = \sum_{p \in B} X^{\text{wt}(p)}. \quad (5.24)$$

A *crystal* is a set of paths B that is closed under the action of the *root operators*

$$\tilde{e}_i: B_{\text{univ}} \longrightarrow B_{\text{univ}} \cup \{0\} \quad \text{and} \quad \tilde{f}_i: B_{\text{univ}} \longrightarrow B_{\text{univ}} \cup \{0\}, \quad 1 \leq i \leq n, \quad (5.25)$$

which are defined and constructed below, in Proposition 5.7 and Theorem 5.8. The *crystal graph* of B is the graph with

$$\text{vertices } B \quad \text{and} \quad \text{labeled edges } p' \xleftarrow{i} p \quad \text{if } p' = \tilde{f}_i p. \quad (5.26)$$

5.3 i -strings

Let B be a crystal. Let $p \in B$ and fix i ($1 \leq i \leq n$). The i -string of p is the set of paths $S_i(p)$ generated from p by applications of the operators \tilde{e}_i and \tilde{f}_i .

The *head* of $S_i(p)$ is $h \in S_i(p)$ such that $\tilde{e}_i h = 0$.

The *tail* of $S_i(p)$ is $t \in S_i(p)$ such that $\tilde{f}_i t = 0$.

The weights of the paths in $S_i(p)$ are

$$\text{wt}(t) = s_i \text{wt}(h) = \text{wt}(h) - \langle \text{wt}(h), \alpha_i^\vee \rangle \alpha_i, \quad \dots, \quad \text{wt}(h) - 2\alpha_i, \quad \text{wt}(h) - \alpha_i, \quad \text{wt}(h),$$

and the crystal graph of $S_i(p)$ is

$$\begin{array}{ccccccc} \leftarrow & & \xrightarrow{d_i^-(p)} & & \leftarrow & & \xrightarrow{d_i^+(p)} \\ \leftarrow^i t & \xleftarrow{i} \tilde{e}_i t & \xleftarrow{i} \dots & \xleftarrow{i} \tilde{f}_i p & \xleftarrow{i} p & \xleftarrow{i} \tilde{e}_i p & \xleftarrow{i} \dots & \xleftarrow{i} \tilde{f}_i h & \xleftarrow{i} h \\ & & & & \leftarrow & & & & \rightarrow \end{array}$$

where

$$d_i^+(p) = (\text{distance from } h \text{ to } p) \quad \text{and} \quad d_i^-(p) = (\text{distance from } p \text{ to } t),$$

so that $\tilde{e}_i^{d_i^+(p)} p = h$ and $\tilde{f}_i^{d_i^-(p)} p = t$,

5.4 Highest weight paths

A *highest weight path* is a path p such that

$$\tilde{e}_i p = 0, \quad \text{for all } 1 \leq i \leq n. \tag{5.27}$$

A highest weight path is a path p such that, for each $1 \leq i \leq n$, p is the head of the i -string $S_i(p)$. Thus $\langle p(t), \alpha_i^\vee \rangle > -1$ for all t and all $1 \leq i \leq n$. So a path p is a highest weight path if and only if

$$p \subseteq C - \rho, \quad \text{where } C - \rho = \{\mu - \rho \mid \mu \in C\}. \tag{5.28}$$

Following the example at the end of Section 2, for the root system of type C_2 the picture is

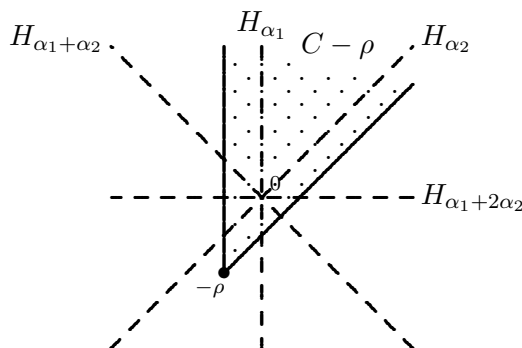

the region $C - \rho$

If p is a highest weight path with $\text{wt}(p) \in P$ then, necessarily, $\text{wt}(p) \in P^+$. The following theorem gives an expression for the character of a crystal in terms of the basis $\{s_\lambda \mid \lambda \in P^+\}$ of $\mathbb{Z}[P]^W$.

Theorem 5.5. *Let B be a crystal. Let $\mathop{\mathrm{char}}(B)$ be as in (5.24) and s_λ as in (5.5). Then*

$$\mathop{\mathrm{char}}(B) = \sum_{\substack{p \in B \\ p \subseteq C - \rho}} s_{\mathrm{wt}(p)},$$

where the sum is over highest weight paths $p \in B$.

Proof. Fix i , $1 \leq i \leq n$. If $p \in B$ let $s_i p$ be the element of the i -string of p which satisfies

$$\mathrm{wt}(s_i p) = s_i \mathrm{wt}(p).$$

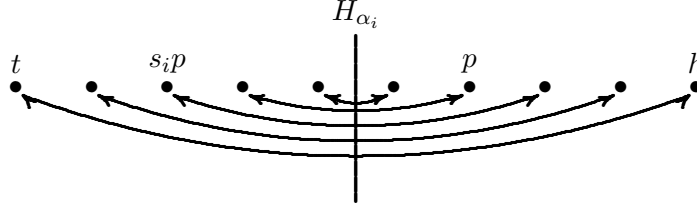

Then $s_i(s_i p) = p$ and

$$s_i \mathop{\mathrm{char}}(B) = \sum_{p \in B} X^{s_i \mathrm{wt}(p)} = \sum_{p \in B} X^{\mathrm{wt}(s_i p)} = \mathop{\mathrm{char}}(B).$$

Hence $\mathop{\mathrm{char}}(B) \in \mathbb{Z}[P]^W$.

Let

$$\varepsilon = \sum_{w \in W} \det(w) w \quad \text{so that} \quad a_\mu = \varepsilon(X^\mu), \quad \text{for } \mu \in P.$$

Since $\mathop{\mathrm{char}}(B) \in \mathbb{Z}[P]^W$,

$$\mathop{\mathrm{char}}(B) a_\rho = \mathop{\mathrm{char}}(B) \varepsilon(X^\rho) = \varepsilon(\mathop{\mathrm{char}}(B) X^\rho)$$

and

$$\begin{aligned} \mathop{\mathrm{char}}(B) &= \frac{1}{a_\rho} \mathop{\mathrm{char}}(B) a_\rho = \frac{\varepsilon(\mathop{\mathrm{char}}(B) X^\rho)}{a_\rho} \\ &= \sum_{p \in B} \frac{\varepsilon(X^{\mathrm{wt}(p) + \rho})}{a_\rho} = \sum_{p \in B} \frac{a_{\mathrm{wt}(p) + \rho}}{a_\rho} = \sum_{p \in B} s_{\mathrm{wt}(p)}. \end{aligned} \tag{5.29}$$

There is some cancellation which can occur in this sum. Assume $p \in B$ such that $p \not\subseteq C - \rho$ let t be the first time that p leaves the cone $C - \rho$. In other words let $t \in \mathbb{R}_{>0}$ be minimal such that there exists an i with

$$p(t) \in H_{\alpha_i, -1} \quad \text{where} \quad H_{\alpha_i, -1} = \{\lambda \in \mathfrak{h}_{\mathbb{R}}^* \mid \langle \lambda, \alpha_i^\vee \rangle = -1\}.$$

Let i be the minimal index such that the point $p(t) \in H_{\alpha_i, -1}$ and define $s_i \circ p$ to be the element of the i -string of p such that

$$\mathrm{wt}(s_i \circ p) = s_i \circ p.$$

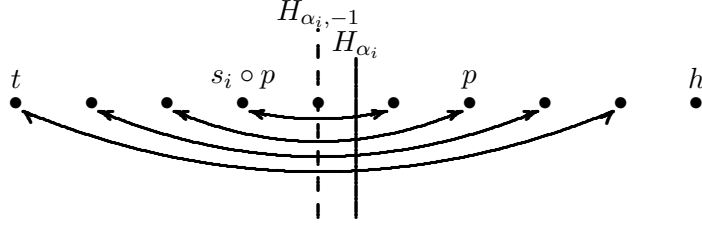

Note that since $\langle p_i(t), \alpha_i^\vee \rangle = -1$, p is not the head of its i -string and $s_i \circ p$ is well defined. If $q = s_i \circ p$ then the first time t that q leaves the cone $C - \rho$ is the same as the first time that p leaves the cone $C - \rho$ and $p(t) = q(t)$. Thus $s_i \circ q = p$ and $s_i \circ (s_i \circ p) = p$. Since

$$s_{\text{wt}(s_i \circ p)} = s_{s_i \circ \text{wt}(p)} = -s_{\text{wt}(p)}$$

the terms $s_{\text{wt}(s_i \circ p)}$ and $s_{\text{wt}(p)}$ cancel in the sum in (5.29). Thus

$$\text{char}(B) = \sum_{\substack{p \in B \\ p \subseteq C - \rho}} s_{\text{wt}(p)}.$$

□

Theorem 5.6. Recall the notations for Weyl characters, tensor product multiplicities, restriction multiplicities and paths from (5.5), (5.11), (5.17) and (5.22). For each $\lambda \in P^+$ fix a highest weight path p_λ^+ with endpoint λ and let

$B(\lambda)$ be the crystal generated by p_λ^+ .

Let $\lambda, \mu, \nu \in P^+$ and let $J \subseteq \{1, 2, \dots, n\}$. Then

$$s_\lambda = \sum_{p \in B(\lambda)} X^{\text{wt}(p)}, \quad s_\mu s_\nu = \sum_{\substack{q \in B(\nu) \\ p_\mu^+ \otimes q \subseteq C - \rho}} s_{\mu + \text{wt}(q)}, \quad \text{and} \quad s_\lambda = \sum_{\substack{p \in B(\lambda) \\ p \subseteq C_{J-\rho, J}}} s_{\text{wt}(p)}^J.$$

Proof. (a) The path p_λ^+ is the unique highest weight path in $B(\lambda)$. Thus, by Theorem 5.5, $\text{char}(B(\lambda)) = s_\lambda$.

(b) By the ‘‘Leibnitz formula’’ for the root operators in Theorem 5.8c the set

$$B(\mu) \otimes B(\nu) = \{p \otimes q \mid p \in B(\mu), q \in B(\nu)\}$$

is a crystal. Since $\text{wt}(p \otimes q) = \text{wt}(p) + \text{wt}(q)$,

$$\begin{aligned} s_\mu s_\nu &= \text{char}(B(\mu))\text{char}(B(\nu)) = \text{char}((B(\mu) \otimes B(\nu))) \\ &= \sum_{\substack{p \otimes q \in B(\mu) \otimes B(\nu) \\ p \otimes q \subseteq C - \rho}} s_{\text{wt}(p) + \text{wt}(q)} = \sum_{\substack{q \in B(\nu) \\ p_\mu^+ \otimes q \subseteq C - \rho}} s_{\mu + \text{wt}(q)}, \end{aligned}$$

where the third equality is from Theorem 5.5 and the last equality is because the path p_μ^+ has $\text{wt}(p_\mu^+) = \mu$ and is the only highest weight path in $B(\mu)$.

(c) A J -crystal is a set of paths B which is closed under the operators \tilde{e}_j, \tilde{f}_j , for $j \in J$. Since $s_\lambda = \text{char}(B(\lambda))$ the statement follows by applying Theorem 5.5 to $B(\lambda)$ viewed as a J -crystal. □

5.5 Root operators for the rank 1 case

Let

$$B^{\otimes k} = \{b_1 \otimes \cdots \otimes b_k \mid b_i \in B\}, \quad \text{where} \quad B = \{+1, -1, 0\}.$$

Define

$$\tilde{f}: B^{\otimes k} \rightarrow B^{\otimes k} \cup \{0\} \quad \text{and} \quad \tilde{e}: B^{\otimes k} \rightarrow B^{\otimes k} \cup \{0\}$$

as follows. Let $b = b_1 \otimes \cdots \otimes b_k \in B^{\otimes k}$. Ignoring 0s successively pair adjacent unpaired $(+1, -1)$ pairs to obtain a sequence of unpaired -1 s and $+1$ s

$$-1 \quad -1 \quad -1 \quad -1 \quad -1 \quad -1 \quad -1 \quad +1 \quad +1 \quad +1 \quad +1$$

(after pairing and ignoring 0s). Then

$$\begin{aligned} \tilde{f}b &= \text{same as } b \text{ except the leftmost unpaired } +1 \text{ is changed to } -1, \\ \tilde{e}b &= \text{same as } b \text{ except the rightmost unpaired } -1 \text{ is changed to } +1. \end{aligned} \tag{5.30}$$

If there is no unpaired $+1$ after pairing then $\tilde{f}b = 0$.

If there is no unpaired -1 after pairing then $\tilde{e}b = 0$.

These operators coincide with the operators used in the type A case by Lascoux and Schützenberger [LS] (see the nice exposition in [Ki]). The $(+1, -1)$ pairing procedure is equivalent to the process of taking the “outer edge” of the path (4.18-4.19). In the context of Section 4 this is natural since only the outer edge of the path contributes nontrivially to the image of the path in the affine Hecke algebra.

Let $\mathfrak{h}_{\mathbb{R}}^* = \mathbb{R}$. By identifying $+1, -1, 0$ with the straight line paths

$$\begin{array}{ccc} \xrightarrow{p_1} & \xleftarrow{p_{-1}} & \bullet^{p_0} \\ p_1: [0, 1] \rightarrow \mathfrak{h}_{\mathbb{R}}^* & p_{-1}: [0, 1] \rightarrow \mathfrak{h}_{\mathbb{R}}^* & p_0: [0, 1] \rightarrow \mathfrak{h}_{\mathbb{R}}^* \\ t \mapsto t, & t \mapsto -t, & t \mapsto 0, \end{array}$$

respectively, the set $B^{\otimes k}$ is viewed as a set of maps $p: [0, k] \rightarrow \mathfrak{h}_{\mathbb{R}}^*$. Let $B^{\otimes 0} = \{\phi\}$ with $\tilde{f}\phi = 0$ and $\tilde{e}\phi = 0$. Then

$$T_{\mathbb{Z}}(B) = \bigsqcup_{k \in \mathbb{Z}_{\geq 0}} B^{\otimes k} \tag{5.31}$$

is a set of paths closed under products, reverses and r -stretches ($r \in \mathbb{Z}_{\geq 0}$) and the action of \tilde{e} and \tilde{f} . For $p \in B$ let

$$\begin{aligned} d^+(p) &= (\text{number of unpaired } +1\text{s after pairing}), \\ d^-(p) &= (\text{number of unpaired } -1\text{s after pairing}). \end{aligned} \tag{5.32}$$

See the picture in (5.33). These are the nonnegative integers such that

$$\tilde{f}^{d^+(p)}p \neq 0 \quad \text{and} \quad \tilde{f}^{d^+(p)+1}p = 0, \quad \text{and} \quad \tilde{e}^{d^-(p)}p \neq 0 \quad \text{and} \quad \tilde{e}^{d^-(p)+1}p = 0.$$

Proposition 5.7. *Use notations for $T_{\mathbb{Z}}(B)$ as in (5.30-5.32).*

(a) *If $p \in T_{\mathbb{Z}}(B)$ and $\tilde{f}p \neq 0$ then $\tilde{e}\tilde{f}p = p$.*

If $p \in T_{\mathbb{Z}}(B)$ and $\tilde{e}p \neq 0$ then $\tilde{f}\tilde{e}p = p$.

is a rank 1 path (an element of $T_{\mathbb{R}}(B)$). The rank 1 path p_{α} is the projection of p onto the line perpendicular to the hyperplane H_{α} . Define operators

$$\tilde{e}_{\alpha}: B_{\text{univ}} \rightarrow B_{\text{univ}} \cup \{0\} \quad \text{and} \quad \tilde{f}_{\alpha}: B_{\text{univ}} \rightarrow B_{\text{univ}} \cup \{0\} \quad (5.36)$$

by

$$\tilde{e}_{\alpha}p = p + \frac{1}{2}(\tilde{e}p_{\alpha} - p_{\alpha})\alpha \quad \text{and} \quad \tilde{f}_{\alpha}p = p - \frac{1}{2}(p_{\alpha} - \tilde{f}p_{\alpha})\alpha, \quad (5.37)$$

and set

$$\tilde{e}_i = \tilde{e}_{\alpha_i} \quad \text{and} \quad \tilde{f}_i = \tilde{f}_{\alpha_i}, \quad \text{for } 1 \leq i \leq n. \quad (5.38)$$

The operators \tilde{e}_i and \tilde{f}_i are designed so that after projection onto the line perpendicular to H_{α_i} they are the operators \tilde{e} and \tilde{f} .

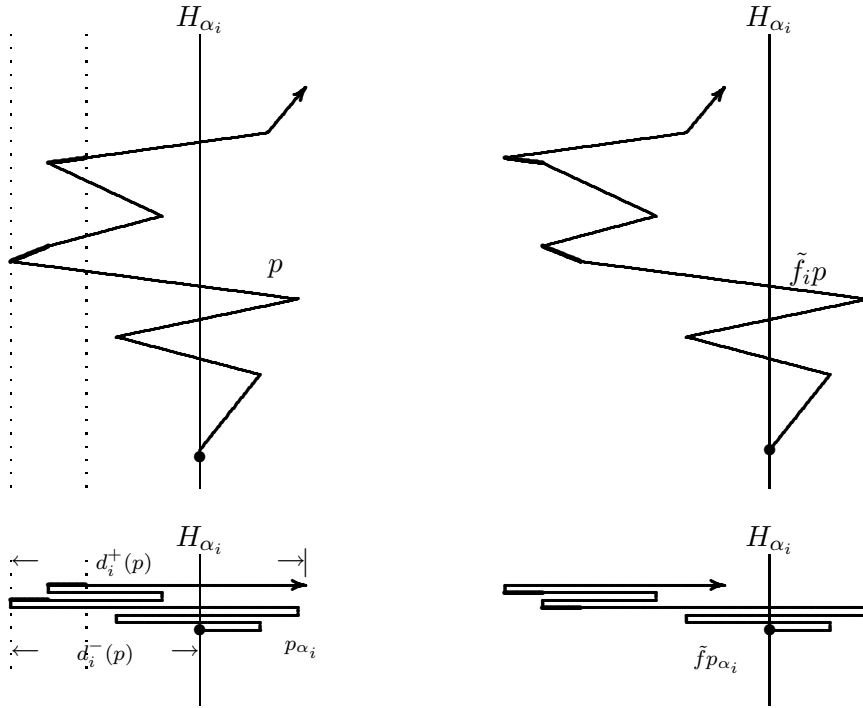

The dark parts of the path p are reflected (in a mirror parallel to H_{α_i}) to form the path $\tilde{f}_i p$. The left dotted line is the affine hyperplane parallel to H_{α_i} which intersects the path p at its leftmost (most negative) point (relative to H_{α_i}) and the distance between the dotted lines is exactly the distance between lines of lattice points in P parallel to H_{α_i} .

The following theorem is a consequence of Proposition 5.7 and the definition in (5.34). The uniqueness of the operators \tilde{f}_i and \tilde{e}_i is forced by the properties (b), (c) and (d) in Theorem 5.8.

Theorem 5.8. *The operators \tilde{e}_i and \tilde{f}_i defined in (5.38) are the unique operators such that*

(a) *If $p \in B_{\text{univ}}$ and $\tilde{f}_i p \neq 0$ then $\tilde{e}_i \tilde{f}_i p = p$.*

If $p \in B_{\text{univ}}$ and $\tilde{e}_i p \neq 0$ then $\tilde{f}_i \tilde{e}_i p = p$.

(b) *If $\lambda \in P$ and $\langle \lambda, \alpha_i^\vee \rangle \in \mathbb{Z}_{>0}$ then*

$$\tilde{f}_i^{\langle \lambda, \alpha_i^\vee \rangle} p_\lambda = p_{s_i \lambda}.$$

(c) If $p, q \in B_{\text{univ}}$ then

$$\tilde{f}_i(p \otimes q) = \begin{cases} \tilde{f}_i p \otimes q, & \text{if } d_i^+(p) > d_i^-(q), \\ p \otimes \tilde{f}_i q, & \text{if } d_i^+(p) \leq d_i^-(q), \end{cases} \quad \text{and}$$

$$\tilde{e}_i(p \otimes q) = \begin{cases} \tilde{e}_i p \otimes q, & \text{if } d_i^+(p) \geq d_i^-(q), \\ p \otimes \tilde{e}_i q, & \text{if } d_i^+(p) < d_i^-(q). \end{cases}$$

where $d_i^\pm(p) = d^\pm(p_{\alpha_i})$ with d^\pm as in (5.33) and p_{α_i} as in (5.35).

(d) If $p \in B_{\text{univ}}$ and $r \in \mathbb{Z}_{\geq 0}$ then

$$\tilde{f}_i^r(rp) = r(\tilde{f}_i p) \quad \text{and} \quad \tilde{e}_i^r(rp) = r(\tilde{e}_i p).$$

(e) If $p \in B_{\text{univ}}$ then

$$\tilde{f}_i p^* = (\tilde{e}_i p)^* \quad \text{and} \quad \tilde{e}_i p^* = (\tilde{f}_i p)^*.$$

(f) If $p \in B_{\text{univ}}$ and $\tilde{f}_i p \neq 0$ then $\text{wt}(\tilde{f}_i p) = \text{wt}(p) - \alpha_i$.

If $p \in B_{\text{univ}}$ and $\tilde{e}_i p \neq 0$ then $\text{wt}(\tilde{e}_i p) = \text{wt}(p) + \alpha_i$.

5.7 Column strict tableaux

A *letter* is an element of $B(\varepsilon_1) = \{\varepsilon_1, \dots, \varepsilon_n\}$ and a *word of length k* is an element of

$$B(\varepsilon_1)^{\otimes k} = \{\varepsilon_{i_1} \otimes \dots \otimes \varepsilon_{i_k} \mid 1 \leq i_1, \dots, i_k \leq n\}.$$

For $1 \leq i \leq n-1$ define

$$\tilde{f}_i: B(\varepsilon_1)^{\otimes k} \longrightarrow B(\varepsilon_1)^{\otimes k} \cup \{0\} \quad \text{and} \quad \tilde{e}_i: B(\varepsilon_1)^{\otimes k} \longrightarrow B(\varepsilon_1)^{\otimes k} \cup \{0\}$$

as follows. For $b \in B(\varepsilon_1)^{\otimes k}$,

$$\begin{aligned} & \text{place } +1 \text{ under each } \varepsilon_i \text{ in } b, \\ & \text{place } -1 \text{ under each } \varepsilon_{i+1} \text{ in } b, \text{ and} \\ & \text{place } 0 \text{ under each } \varepsilon_j, j \neq i, i+1. \end{aligned} \tag{5.39}$$

Ignoring 0s, successively pair adjacent $(+1, -1)$ pairs to obtain a sequence of unpaired -1 s and $+1$ s

$$-1 \ -1 \ -1 \ -1 \ -1 \ -1 \ -1 \ +1 \ +1 \ +1 \ +1 \tag{5.40}$$

(after pairing and ignoring 0s). Then

$\tilde{f}_i b$ = same as b except the letter corresponding to the leftmost unpaired $+1$ is changed to ε_{i+1} ,

$\tilde{e}_i b$ = same as b except the letter corresponding to the rightmost unpaired -1 is changed to ε_i .

If there is no unpaired $+1$ after pairing then $\tilde{f}_i b = 0$.

If there is no unpaired -1 after pairing then $\tilde{e}_i b = 0$.

A *partition* is a collection μ of boxes in a corner where the convention is that gravity goes up and to the left. As for matrices, the rows and columns of μ are indexed from top to bottom and left to right, respectively.

$$\begin{aligned} \text{The parts of } \mu \text{ are } & \mu_i = (\text{the number of boxes in row } i \text{ of } \mu), \\ \text{the length of } \mu \text{ is } & \ell(\mu) = (\text{the number of rows of } \mu), \\ \text{the size of } \mu \text{ is } & |\mu| = \mu_1 + \cdots + \mu_{\ell(\mu)} = (\text{the number of boxes of } \mu). \end{aligned} \tag{5.41}$$

Then μ is determined by (and identified with) the sequence $\mu = (\mu_1, \dots, \mu_\ell)$ of positive integers such that $\mu_1 \geq \mu_2 \geq \cdots \geq \mu_\ell > 0$, where $\ell = \ell(\mu)$. For example,

$$(5, 5, 3, 3, 1, 1) = \begin{array}{cccccc} \square & \square & \square & \square & \square & \square \\ \square & \square & \square & \square & \square & \square \\ \square & \square & \square & \square & \square & \square \\ \square & \square & \square & \square & \square & \square \\ \square & \square & \square & \square & \square & \square \\ \square & \square & \square & \square & \square & \square \end{array} .$$

Let λ be a partition and let $\mu = (\mu_1, \dots, \mu_n) \in \mathbb{Z}_{\geq 0}^n$ be a sequence of nonnegative integers. A *column strict tableau of shape λ and weight μ* is a filling of the boxes of λ with μ_1 1s, μ_2 2s, \dots , μ_n ns, such that

- (a) the rows are weakly increasing from left to right,
- (b) the columns are strictly increasing from top to bottom.

If p is a column strict tableau write $\text{shp}(p)$ and $\text{wt}(p)$ for the shape and the weight of p so that

$$\begin{aligned} \text{shp}(p) &= (\lambda_1, \dots, \lambda_n), & \text{where } \lambda_i &= \text{number of boxes in row } i \text{ of } p, & \text{and} \\ \text{wt}(p) &= (\mu_1, \dots, \mu_n), & \text{where } \mu_i &= \text{number of } i \text{ s in } p. \end{aligned}$$

For example,

$$p = \begin{array}{cccccccc} 1 & 1 & 1 & 1 & 1 & 1 & 1 & 2 & 2 \\ 2 & 2 & 2 & 2 & 3 & 3 & 4 & & \\ 3 & 3 & 3 & 4 & 4 & 4 & 5 & & \\ 4 & 5 & 5 & 6 & & & & & \\ 6 & 7 & & & & & & & \\ 7 & & & & & & & & \end{array} \quad \text{has } \begin{aligned} \text{shp}(p) &= (9, 7, 7, 4, 2, 1, 0) & \text{and} \\ \text{wt}(p) &= (7, 6, 5, 5, 3, 2, 2). \end{aligned}$$

For a partition λ and a sequence $\mu = (\mu_1, \dots, \mu_n) \in \mathbb{Z}_{\geq 0}^n$ of nonnegative integers write

$$\begin{aligned} B(\lambda) &= \{\text{column strict tableaux } p \mid \text{shp}(p) = \lambda\}, \\ B(\lambda)_\mu &= \{\text{column strict tableaux } p \mid \text{shp}(p) = \lambda \text{ and } \text{wt}(p) = \mu\}. \end{aligned} \tag{5.42}$$

Let λ be a partition with k boxes and let

$$B(\lambda) = \{\text{column strict tableaux of shape } \lambda\}.$$

The set $B(\lambda)$ is a subset of $B(\varepsilon_1)^{\otimes k}$ via the injection

$$\begin{array}{ccc} B(\lambda) & \hookrightarrow & B(\varepsilon_1)^{\otimes k} \\ p & \longmapsto & (\text{the arabic reading of } p) \end{array}$$

$$\begin{array}{ccc} \begin{array}{cccc} i_{\lambda_1} & \cdots & & i_2 & i_1 \\ i_{\lambda_1+\lambda_2} & \cdots & i_{\lambda_1+1} & & \\ \dots & & & & \\ i_k & & & & \end{array} & \longmapsto & \varepsilon_{i_1} \otimes \varepsilon_{i_2} \otimes \cdots \otimes \varepsilon_{i_k} \end{array} \tag{5.43}$$

with the effect that the entries in any configuration of boxes of the form

+1	+1	⋯	+1
-1	-1	⋯	-1

will be removed. Additional $+1, -1$ pairs will also be removed and the final sequence

$$\underbrace{-1 \ -1 \ \cdots \ -1}_{d_i^-(p)} \underbrace{+1 \ +1 \ \cdots \ +1}_{d_i^+(p)} \quad (5.44)$$

will correspond to a configuration of the form

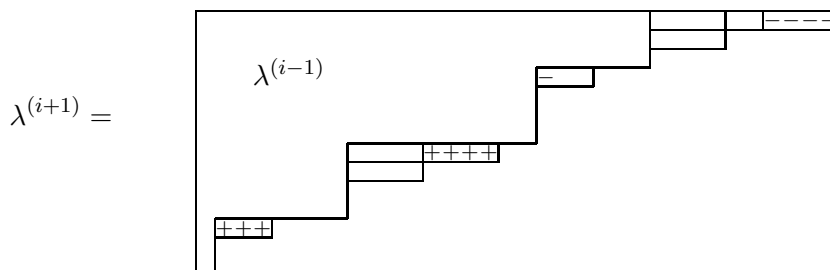

The rightmost -1 in the sequence (5.40) corresponds to a box in $\lambda^{(i+1)}/\lambda^{(i)}$ which is leftmost in its row and which does not cover a box of $\lambda^{(i)}/\lambda^{(i-1)}$. Similarly the leftmost $+1$ in the sequence (5.40) corresponds to a box in $\lambda^{(i)}/\lambda^{(i-1)}$ which is rightmost in its row and which does not have a box of $\lambda^{(i+1)}/\lambda^{(i)}$ covering it. These conditions guarantee that $\tilde{e}_i P$ and $\tilde{f}_i P$ are column strict tableaux.

(b) The tableau P is obtained from P_λ by applying a sequence of \tilde{f}_i in the following way. Applying the operator

$$\tilde{f}_{n,i} = \tilde{f}_{n-1} \cdots \tilde{f}_{i+1} \tilde{f}_i \quad \text{to } P_\lambda$$

will change the rightmost i in row i to n . A sequence of applications of

$$\tilde{f}_{n,i}, \quad \text{as } i \text{ decreases (weakly) from } n-1 \text{ to } 1,$$

can be used to produce a column strict tableau P_n in which

- (1) the entries equal to n match the entries equal to n in P , and
- (2) the subtableau of P_n containing the entries $\leq n-1$ is $P_{\lambda^{(n-1)}}$.

Iterating the process and applying a sequence of operators

$$\tilde{f}_{n-1,i}, \quad \text{as } i \text{ decreases (weakly) from } n-2 \text{ to } 1,$$

to the tableau P_n can be used to produce a tableau P_{n-1} in which

- (1) the entries equal to n and $n-1$ match the entries equal to n and $n-1$ in P , and
- (2) the subtableau of P_{n-1} containing the entries $\leq n-2$ is $P_{\lambda^{(n-2)}}$.

The tableau P is obtained after a total of n iterations of this process. □

References

- [BD] Y. Billig and M. Dyer, *Decompositions of Bruhat type for the Kac-Moody groups*, Nova J. Algebra Geom. **3** no. 1 (1994), 11–31.
- [Br] M. Brion, *Positivity in the Grothendieck group of complex flag varieties*, J. Algebra **258** no. 1 (2002), 137–159.
- [GL] S. Gaussent and P. Littelmann, *LS galleries, the path model, and MV cycles*, Duke Math. J. **127** no. 1 (2005), 35–88.
- [GR] S. Griffeth and A. Ram, *Affine Hecke algebras and the Schubert calculus*, European J. Combin. **25** no. 8 (2004), 1263–1283.
- [Ha] T. Haines, *Structure constants for Hecke and representation rings*, Int. Math. Res. Not. **39** (2003), 2103–2119.
- [IM] N. Iwahori and H. Matsumoto, *On some Bruhat decomposition and the structure of the Hecke rings of p -adic Chevalley groups*, Inst. Hautes Études Sci. Publ. Math. **25** (1965), 5–48.
- [Ki] K. Killpatrick, *A Combinatorial Proof of a Recursion for the q -Kostka Polynomials*, J. Comb. Th. Ser. A **92** (2000), 29–53.
- [KM] M. Kapovich and J.J. Millson, *A path model for geodesics in Euclidean buildings and its applications to representation theory*, arXiv: math.RT/0411182.
- [LS] A. Lascoux and M.P. Schützenberger, *Le monoïde plaxique*, Quad. Ricerce Sci. **109** (1981), 129–156.
- [LP] C. Lenart and A. Postnikov, *Affine Weyl groups in K -theory and representation theory*, arXiv: math.RT/0309207.
- [Li1] P. Littelmann, *A Littlewood-Richardson rule for symmetrizable Kac-Moody algebras*, Invent. Math. **116** (1994), 329–346.
- [Li2] P. Littelmann, *Paths and root operators in representation theory*, Ann. Math. **142** (1995), 499–525.
- [Li3] P. Littelmann, *Characters of representations and paths in $\mathfrak{h}_{\mathbb{R}}^*$* , Proc. Symp. Pure Math. **61** (1997), 29–49.
- [Lu] G. Lusztig, *Affine Hecke algebras and their graded version*, J. Amer. Math. Soc. **2** (1989), 599–635.
- [Mac1] I.G. Macdonald, *Spherical functions on a group of p -adic type*, Publ. Ramanujan Institute No. 2, Madras (1971).
- [Mac2] I.G. Macdonald, *Symmetric functions and Hall polynomials*, Oxford Mathematical Monographs, Oxford Univ. Press, New York (second edition, 1995)
- [PR] H. Pittie and A. Ram, *A Pieri-Chevalley formula in the K -theory of a G/B -bundle*, Electronic Research Announcements **5** (1999), 102–107, and *A Pieri-Chevalley formula for $K(G/B)$* , arXiv: math.RT/0401332.

[Sc] C. Schwer, *Galleries, Hall-Littlewood polynomials and structure constants of the spherical Hecke algebra*, arXiv: math.CO/0506287.