

# CLASSIFICATION OF LOG ENRIQUES SURFACES WITH $\delta = 1$

S. A. KUDRYAVTSEV

ABSTRACT. Log Enriques surfaces with  $\delta = 1$  are classified.

## Introduction

Let  $S$  be a projective surface with klt singularities and with numerically trivial canonical class  $K_S \equiv 0$ . Then  $S$  is called a *log Enriques surface*.

Let us consider the following invariant

$$\delta(S) = \#\left\{E \mid E \text{ is exceptional divisor with discrepancy } a(E, 0) \leq -\frac{6}{7}\right\}.$$

By theorem [7, 5.1] we have  $0 \leq \delta(S) \leq 2$ . In this paper the classification of such surfaces with  $\delta = 1$  is given. The classification of log Enriques surfaces with  $\delta = 2$  was obtained in [3].

The classification method for surfaces with  $\delta = 1$  doesn't distinguish from one in the case  $\delta = 2$ . Moreover, the classification of exceptional log Del Pezzo surfaces easily implies the classification of log Enriques surfaces.

The log Enriques surfaces often appear in many problems. Such of them are the following ones: the study of Calabi–Yao varieties, the study of  $K3$  surfaces (in particular, see section 1.5) and the problem of inductive classification of strictly log canonical singularities.

In the latter problem log Enriques surfaces can be realized as the exceptional divisors of purely log terminal blow-ups of three-dimensional strictly log canonical singularities.

The research was partially supported by a grant 02-01-00441 from the Russian Foundation of Basic Research and a grant INTAS-OPEN 2000#269.

## 1. Preliminary facts and results

All varieties are algebraic and are assumed to be defined over  $\mathbb{C}$ , the complex number field. The main definitions, terminology and notations used in the paper are given in [2], [6].

The general hypersurface of degree  $d$  in  $\mathbb{P}^3$  is denoted by  $X_d$ . In many cases it is enough to require the irreducibility and reducibility of  $X_d$ . In the case  $p_a(C) = 1$  the curve  $X_d$  must have an ordinary double point. More exactly about a structure of  $X_d$  see remark 2.2 [4].

**Theorem 1.1.** *Let  $S$  be a log Enriques surface with  $\delta = 1$ . Denote the exceptional curve with discrepancy  $a(\tilde{C}, 0) = -a \leq -\frac{6}{7}$  by  $\tilde{C}$ . Let  $f: \tilde{S} \rightarrow S$  be an extraction of  $\tilde{C}$  (i.e.  $f$  is a birational contraction such that  $\text{Exc } f = \tilde{C}$ ).*

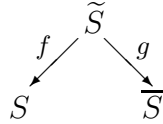

Then there exists a birational contraction  $g: \tilde{S} \rightarrow \bar{S}$  with the following properties:  $\rho(\bar{S}) = 1$ ,  $g$  doesn't contract the curve  $\tilde{C}$ . Put  $C = g(\tilde{C})$ . Then the pair  $(\bar{S}, aC)$  is one of the following ones:

1.  $\bar{S} = \mathbb{P}(1, 2, 3)$  and  $aC = \frac{6}{7}X_7$ . It is the case  $6 - 2(\text{ell})$ .
2.  $\bar{S} = \mathbb{P}(1, 3, 4)$  and  $aC = \frac{8}{9}X_9$ . It is the case  $8 - 1(\text{ell})$ .
3.  $\bar{S} = \mathbb{P}(1, 3, 5)$  and  $aC = \frac{9}{10}X_{10}$ . It is the case  $9 - 1(\text{ell})$ .
4.  $\bar{S} = \mathbb{P}(1, 5, 8)$  and  $aC = \frac{7}{8}X_{16}$ . It is the case  $22 - 1(\text{ell})$ .
5. The minimal resolution of  $\bar{S}$  is one of the following ones.

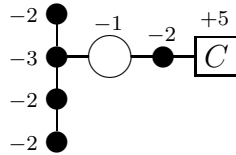

Case 51 - 2(ell)

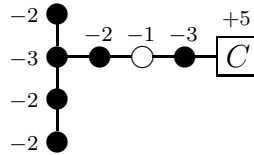

Case 51 - 6(ell)

We have  $a = \frac{10}{11}$  and  $a = \frac{7}{8}$  in the cases 51 - 2(ell) and 51 - 6(ell) respectively.

6.  $\bar{S} = \mathbb{P}(2, 3, 7)$  and  $aC = \frac{6}{7}X_{14}$ . It is the case  $52 - 2(\text{ell})$ .
7. The minimal resolution of  $\bar{S}$  is one of the following ones.

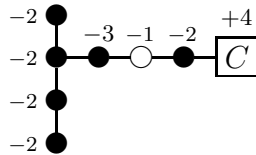

Case 53 - 2(ell)

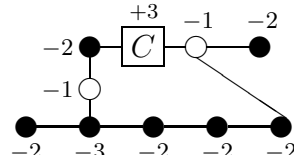

Case 54(ell)

We have  $a = \frac{8}{9}$  and  $a = \frac{6}{7}$  in the cases  $53 - 2(\text{ell})$  and  $54(\text{ell})$  respectively.

8.  $\overline{S} = \mathbb{P}(3, 4, 5)$  and  $aC = \frac{12}{13}X_{13}$ . It is the case  $18 - 1(+1)$ .
9.  $\overline{S} = \mathbb{P}(3, 5, 7)$  and  $aC = \frac{15}{17}X_{17}$ . It is the case  $25 - 1(+1)$ .
10. The minimal of  $\overline{S}$  is one of the following ones.

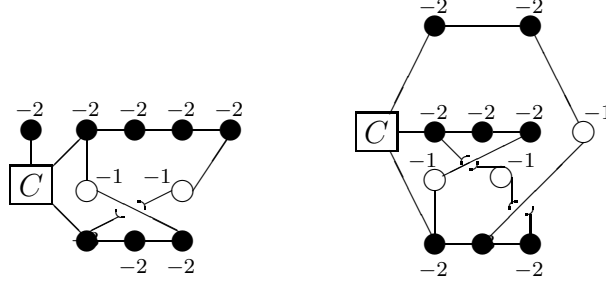

Case 55(0)

Case 56(0)

We have  $a = \frac{10}{11}$  and  $a = \frac{6}{7}$  in the cases  $55(0)$  and  $56(0)$  respectively.

If  $p_a(C) = 1$  then the curve  $C$  must have an ordinary double point.

*Proof.* This theorem immediately follows from theorem 2.1 [4]. If we write  $\text{ell}$  in the brackets then  $p_a(C) = 1$ . If we write  $q$  in the brackets then  $p_a(C) = 0$  and the self-intersection index of proper transform of  $C$  on a minimal resolution of  $\overline{S}$  is equal to  $q$ . The case  $p_a(C) = 0$  is rewritten from theorem 2.1 [4] completely. In the case  $p_a(C) = 1$  the curve  $C$  must be rational. Hence it must have an ordinary double point. By lemma 1.2 the log surfaces with  $p_a(C) = 1$  are rewritten from theorem 2.1 [4] only if  $a(\tilde{C}, 0) = -\frac{k-1}{k}$ , where  $k \in \mathbb{Z}_{\geq 2}$ .  $\square$

**Lemma 1.2.** *Let  $(\mathbb{C}^2, a\{xy = 0\})$  be a klt pair. Then there exists a blow-up with the discrepancy of exceptional divisor being equal to 0 if and only if  $a = \frac{k-1}{k}$ , where  $k \in \mathbb{Z}_{\geq 2}$ .*

*Proof.* It is easy to prove that the required blow-up is toric, i.e. it is a weighted blow-up of  $\mathbb{C}^2$  with weights  $(\alpha, \beta)$ . Then  $a(E, 0) = \alpha + \beta - 1 - (\alpha + \beta)a$ , where  $E$  is an exceptional divisor. Hence  $a(E, 0) = 0 \iff a = 1 - \frac{1}{\alpha + \beta}$ .  $\square$

**Definition 1.3.** Let  $S$  be a log Enriques surface. A canonical index  $I = I(S)$  is called the following number  $I = \min\{n \in \mathbb{Z}_{>0} \mid nK_S \sim 0\}$ . It is known that  $I \leq 21$  [1], [8].

**Corollary 1.4.** *Let  $S$  be a log Enriques surface with  $\delta = 1$ . Then  $I \in \{7, 8, 9, 10, 11, 13, 17\}$ .*

So, the problem of classification of log Enriques surfaces with  $\delta = 1$  is to describe the following procedures. At first we consider the extraction  $\tilde{S} \rightarrow \bar{S}$  such that every exceptional divisor  $E_i$  has the discrepancy  $a(E_i, aC) = 0$ . Then we contract the proper transform of  $C$ . The number of such procedures is finite by the following easy fact.

Let  $(X, D)$  be a klt pair. Then the number of divisors  $E$  of the function field  $\mathcal{K}(X)$  with  $a(E, D) \leq 0$  is finite [6, lemma 3.1.9].

### 1.5. Log Enriques surfaces and K3 surfaces.

Let  $S$  be a log Enriques surface with  $\delta = 1$ . Consider its canonical cover  $\varphi: \hat{S} = \text{Spec}_{\mathcal{O}_S}(\oplus_{i=0}^{I-1} \mathcal{O}_S(-iK_S)) \rightarrow S$ , where  $I$  is an index of  $S$ . Since  $I \geq 7$  (see corollary 1.4) then  $\hat{S}$  is a K3 surface with at worst Du Val singularities [1], [8] and

1.  $\varphi$  is cyclic Galois cover of degree  $I$ , which is etale over  $S \setminus \text{Sing } S$ .
2. There exists a generator  $g$  of  $\text{Gal}(\hat{S}/S) \cong \mathbb{Z}_I$  such that  $g^* \omega_{\hat{S}} = \varepsilon_I \omega_{\hat{S}}$ , where  $\varepsilon_I = \exp(2\pi\sqrt{-1}/I)$  is a primitive root and  $\omega_{\hat{S}}$  is a nowhere vanishing regular 2-form on  $\hat{S}$ .

Let  $\Delta(S)$  be an exceptional set of  $\chi$ , where  $\chi$  is a minimal resolution of  $\hat{S}$ . Then  $\Delta(S)$  is a disconnected sum of divisors of Dynkin's type  $\mathbb{A}_i$ ,  $\mathbb{D}_j$ ,  $\mathbb{E}_k$ . So  $\Delta(S) = (\oplus \mathbb{A}_\alpha) \oplus (\oplus \mathbb{D}_\beta) \oplus (\oplus \mathbb{E}_\gamma)$ . Let us define  $\text{rank } \Delta(S) = \sum \alpha + \sum \beta + \sum \gamma$ .

## 2. Classification of log Enriques surfaces with $\delta = 1$

Let  $S$  be a log Enriques surface with  $\delta = 1$ . Then  $S$  can be constructed by the following way: at first we extract some set  $\mathcal{T}$  of exceptional curves with discrepancy 0 for the corresponding model of theorem 1.1. After it we contract the proper transform of  $C$ . So, the classification of log Enriques surfaces with  $\delta = 1$  is reduced to the description of sets  $\mathcal{T}$ . The curves from  $\mathcal{T}$  are enumerated by the natural numbers in the corresponding figures.

**Definition 2.1.** Let  $T_i = |\mathcal{T}_i|$  be a number of elements of set  $\mathcal{T}_i$ ,  $\underline{T}_i = \min\{t \mid t \in \mathcal{T}_i\}$  and  $\overline{T}_i = \max\{t \mid t \in \mathcal{T}_i\}$ .

**Definition 2.2.** Let  $p_a(C) = 1$ . These are the cases (1)–(7) from theorem 1.1. Then  $\mathcal{T} = \mathcal{T}_1 \cup \mathcal{T}_2 \cup \mathcal{T}_3$ , where  $\mathcal{T}_1$  consists of the curves, which are contracted to the singular points of  $\bar{S}$  lying on  $C$ ,  $\mathcal{T}_2$  consists of the curves, which are contracted to the singular point of  $C$ , and  $\mathcal{T}_3$  consists of the curves, which are contracted to the singular points of  $\bar{S}$  not lying on  $C$ . The set  $\mathcal{T}_2$  is considered up to symmetry. For example, if  $4 \in \mathcal{T}_2$  then  $9 \in \mathcal{T}_2$  in the notation of theorem 2.3. Note that  $\mathcal{T}_2 \neq \emptyset$ .

**Theorem 2.3.** *In the case  $6 - 2(\text{ell})$  the set  $\mathcal{T}$  must be one of the following ones.*

1. Let  $T_1 = 0$ . Then  $T_2 \geq 2$  and  $4 \in \mathcal{T}_2$ .
2. Let  $\mathcal{T}_1 = \{1\}$ . Then  $\{4, 5\} \cap \mathcal{T}_2 \neq \emptyset$ .
3. Let  $\mathcal{T}_1 = \{3\}$ . Then  $4 \in \mathcal{T}_2$ .
4. Let  $\mathcal{T}_1 = \{2\}$  or  $T_1 \geq 2$ . Then  $\mathcal{T}_2 \neq \emptyset$ .

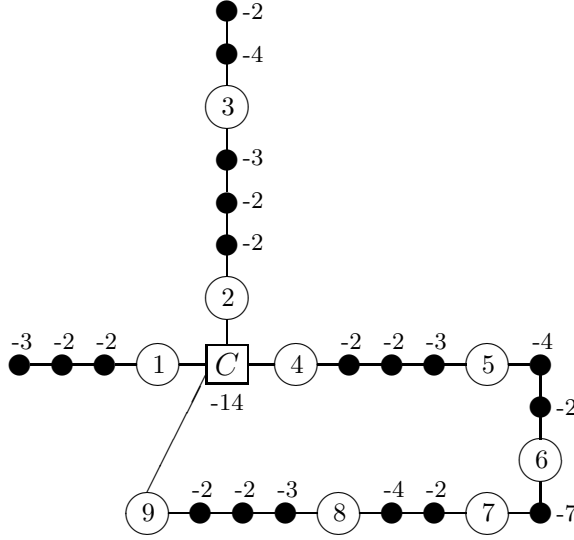

*Proof.* In the figure it is shown the extraction of all curves with discrepancy 0 for the pair  $(\tilde{S}, \frac{6}{7}C)$ . The required curves are enumerated and they are  $(-1)$  curves on a minimal resolution. The extraction process was described in proposition 2.1 [3].

Let  $f: \tilde{S} \rightarrow S$  be an extraction of some set  $\mathcal{T}$ . The proper transform of  $C$  is denoted by  $\tilde{C}$ . The obvious requirement for the set  $\mathcal{T}$  is  $\tilde{C}^2 < 0$ . A necessary and sufficient condition for the set  $\mathcal{T}$  is that the configuration of curves including  $\tilde{C}$  be contracted to a log terminal singularity. Therefore all such configurations must have the type  $\mathbb{A}_n, \mathbb{D}_n, \mathbb{E}_6, \mathbb{E}_7$  or  $\mathbb{E}_8$ . Using these facts the reader will easily prove this theorem.  $\square$

**Corollary 2.4.** *In the case  $6 - 2(\text{ell})$  we have  $I = 7, 2 \leq \rho(S) \leq 9$  and  $\text{rank } \Delta(S) + \rho(S) = 10$ .*

*Proof.* It is proved as theorem 2.8 [3].  $\square$

*Remark 2.5.* The remained statements are proved similarly. The proofs are left to the reader.

**Theorem 2.6.** *In the case  $8 - 1(\text{ell})$  the set  $\mathcal{T}$  must be one of the following ones.*

1. Let  $T_1 = 0$ . Then either  $3 \in \mathcal{T}_2$ , or  $\{4, 7\} \subset \mathcal{T}_2$ .



**Theorem 2.12.** *In the case  $51 - 2(\text{ell})$  the set  $\mathcal{T}$  must be one of the following ones.*

1. Let  $\mathcal{T}_1 = 0$ . Then either  $\{2, 3\} \cap \mathcal{T}_2 \neq \emptyset$ , or  $4 \in \mathcal{T}_2$  and  $\overline{\mathcal{T}_2} \geq 7$ .
2. Let  $\mathcal{T}_1 = \{1\}$ . Then  $\mathcal{T}_2 \neq \emptyset$ .

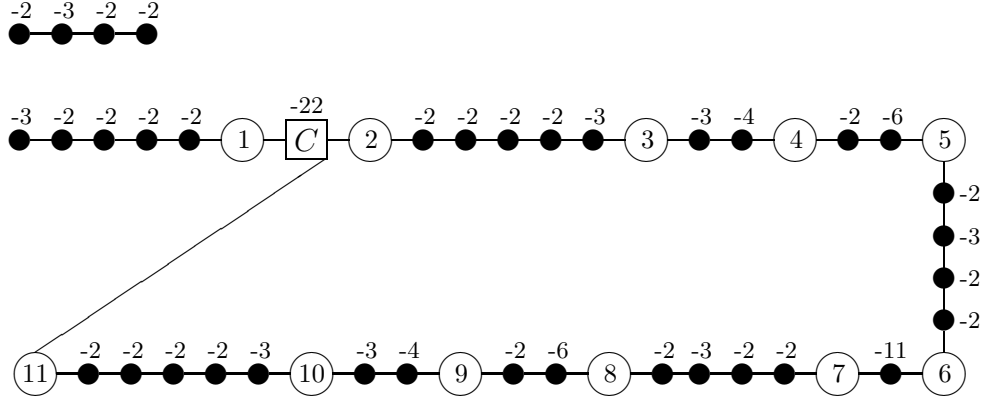

**Corollary 2.13.** *In the case  $51 - 2(\text{ell})$  we have  $I = 11$ ,  $1 \leq \rho(S) \leq 11$  and  $\text{rank } \Delta(S) + \rho(S) = 12$ .*

*Remark 2.14.* The  $K3$  surfaces with the automorphisms of order 11 and hence the log Enriques surfaces with index  $I = 11$  were described in [5].

**Theorem 2.15.** *In the case  $51 - 6(\text{ell})$  the set  $\mathcal{T}$  must satisfy the following condition: either  $2 \in \mathcal{T}_2$ , or  $\mathcal{T}_1 = \{1\}$  and  $\mathcal{T}_2 \neq \emptyset$ .*

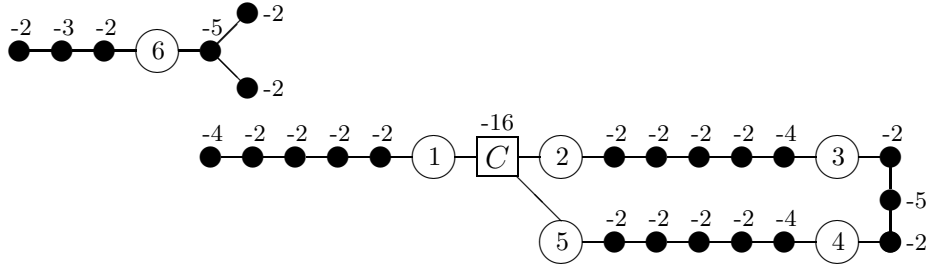

**Corollary 2.16.** *In the case  $51 - 6(\text{ell})$  we have  $I = 8$ ,  $1 \leq \rho(S) \leq 6$  and  $\text{rank } \Delta(S) + \rho(S) = 12$ .*

**Theorem 2.17.** *In the case  $52 - 2(\text{ell})$  the set  $\mathcal{T}$  must satisfy the following condition: either  $\{3, 4\} \cap \mathcal{T}_2 \neq \emptyset$ , or  $\mathcal{T}_1 \geq 1$  and  $\mathcal{T}_2 \neq \emptyset$ .*

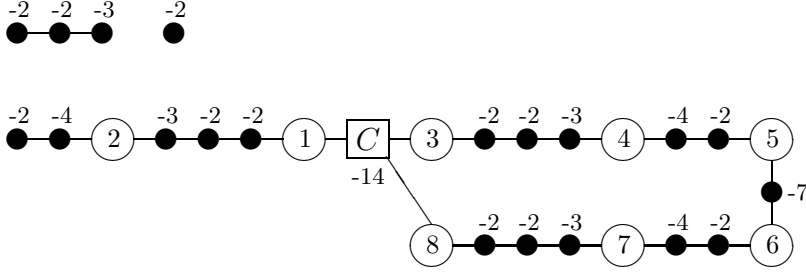

**Corollary 2.18.** *In the case  $52 - 2(\text{ell})$  we have  $I = 7$ ,  $1 \leq \rho(S) \leq 8$  and  $\text{rank } \Delta(S) + \rho(S) = 10$ .*

**Theorem 2.19.** *In the case  $53 - 2(\text{ell})$  the set  $\mathcal{T}$  must be one of the following ones.*

1. Let  $\mathcal{T}_1 = 0$ . Then  $\{2, 3\} \cap \mathcal{T}_2 \neq \emptyset$ .
2. Let  $\mathcal{T}_1 = \{1\}$ . Then  $\mathcal{T}_2 \neq \emptyset$ .

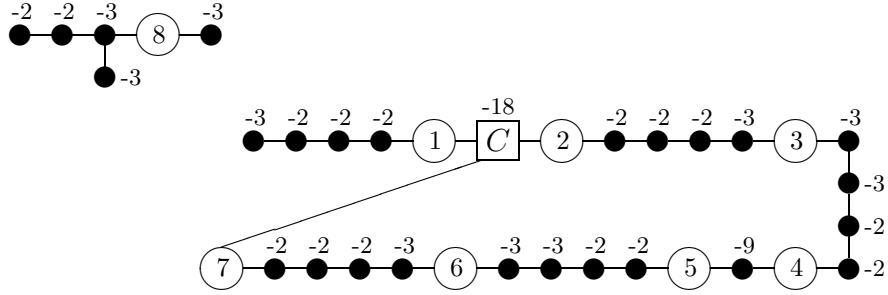

**Corollary 2.20.** *In the case  $53 - 2(\text{ell})$  we have  $I = 9$ ,  $1 \leq \rho(S) \leq 8$  and  $\text{rank } \Delta(S) + \rho(S) = 12$ .*

**Theorem 2.21.** *In the case  $54(\text{ell})$  the set  $\mathcal{T}$  must satisfy the following condition:  $\mathcal{T}_2 \neq \emptyset$ .*

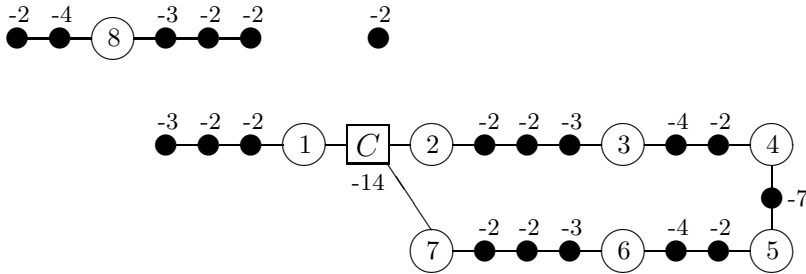

**Corollary 2.22.** *In the case  $54(\text{ell})$  we have  $I = 7$ ,  $1 \leq \rho(S) \leq 8$  and  $\text{rank } \Delta(S) + \rho(S) = 10$ .*

**Definition 2.23.** Let  $p_a(C) = 0$ . These are the cases (8)–(10) of theorem 1.1. In all cases the surface  $\bar{S}$  has only three singular points



lying on  $C$ . In the corresponding figures these points are enumerated from top to bottom of the figure. Then  $\mathcal{T} = \mathcal{T}_1 \cup \mathcal{T}_2 \cup \mathcal{T}_3$ , where  $\mathcal{T}_i$  consists of curves, which contract to the singular point of  $\bar{S}$  with the number  $i$ .

**Theorem 2.24.** *In the case  $18 - 1(+1)$  the set  $\mathcal{T}$  must be one of the following ones.*

1. Let  $T_1 = 0$ . Then either  $\{3, 4\} \cap \mathcal{T}_2 \neq \emptyset$ , or  $\{6, 7\} \cap \mathcal{T}_3 \neq \emptyset$ .
2. Let  $1 \in \mathcal{T}_1$ . Then  $\mathcal{T}_2$  and  $\mathcal{T}_3$  are arbitrary.
3. Let  $\mathcal{T}_1 = \{2\}$ . Then either  $\mathcal{T}_2 \neq \emptyset$ , or  $\underline{T}_3 \leq 8$ .

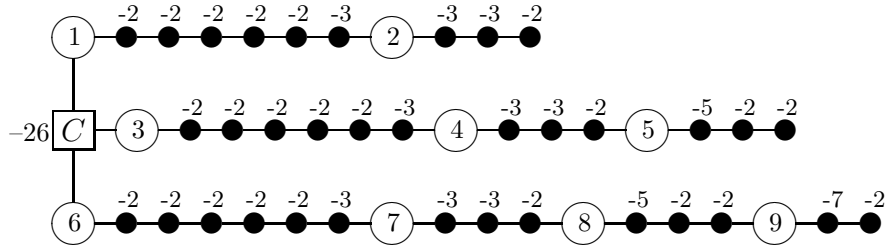

**Corollary 2.25.** *In the case  $18 - 1(+1)$  we have  $I = 13$ ,  $1 \leq \rho(S) \leq 9$  and  $\text{rank } \Delta(S) + \rho(S) = 10$ .*

**Theorem 2.26.** *In the case  $25 - 1(+1)$  the set  $\mathcal{T}$  must be one of the following ones..*

1. Let  $T_1 = 0$ . Then either  $2 \in \mathcal{T}_2$ , or  $4 \in \mathcal{T}_3$ .
2. Let  $\mathcal{T}_1 = \{1\}$ . Then  $\mathcal{T}_2$  and  $\mathcal{T}_3$  are arbitrary.

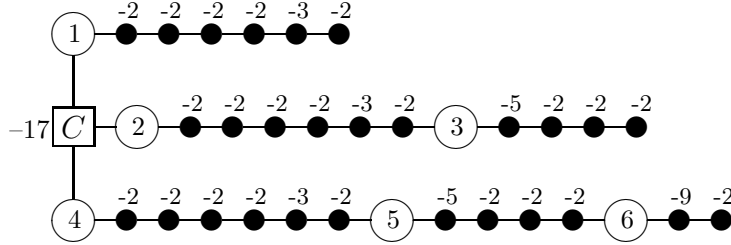

**Corollary 2.27.** *In the case  $25 - 1(+1)$  we have  $I = 17$ ,  $1 \leq \rho(S) \leq 6$  and  $\text{rank } \Delta(S) + \rho(S) = 6$ .*

**Theorem 2.28.** *In the case  $55(0)$  the set  $\mathcal{T}$  must be one of the following ones.*

1. Let  $T_1 = 0$ . Then either  $\{2, 3\} \cap \mathcal{T}_2 \neq \emptyset$ , or  $\underline{T}_3 \leq 8$ , or  $4 \in \mathcal{T}_2$  and  $\underline{T}_3 \leq 10$ .
2. Let  $\mathcal{T}_1 = \{1\}$ . Then  $\mathcal{T}_2$  and  $\mathcal{T}_3$  are arbitrary.

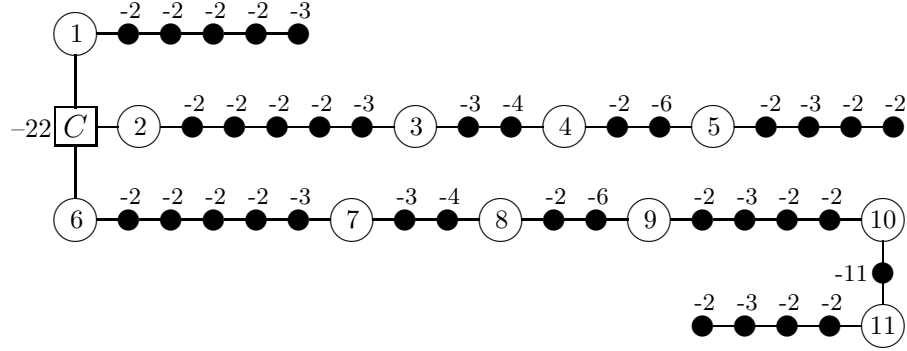

**Corollary 2.29.** *In the case 55(0) we have  $I = 11$ ,  $1 \leq \rho(S) \leq 11$  and  $\text{rank } \Delta(S) + \rho(S) = 12$ .*

**Theorem 2.30.** *In the case 56(0) the set  $\mathcal{T}$  must satisfy the following condition:  $1 \in \mathcal{T}_1$ .*

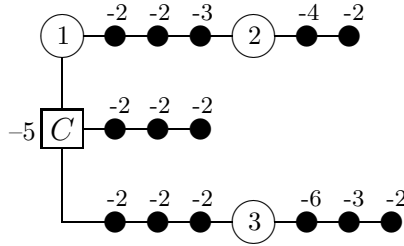

**Corollary 2.31.** *In the case 56(0) we have  $I = 7$ ,  $1 \leq \rho(S) \leq 3$  and  $\text{rank } \Delta(S) + \rho(S) = 13$ .*

## REFERENCES

- [1] *Blache R.* The structure of l.c. surfaces of Kodaira dimension zero // J. Algebraic Geom. 1995. V. 4. P. 137–179.
- [2] *Kollar J. et al* Flips and abundance for algebraic threefolds // Astérisque 1992. V. 211.
- [3] *Kudryavtsev S. A.* Classification of log Enriques surfaces with  $\delta = 2$  // appear in Math. Notes; e-print math.AG/0204083.
- [4] *Kudryavtsev S. A.* Classification of log Del Pezzo surfaces with  $\delta = 1$ . e-print math.AG/0207269.
- [5] *Oguiso K., Zhang D.-Q.* K3 surfaces with order 11 automorphisms. e-print math.AG/9907020.
- [6] *Prokhorov Yu. G.* Lectures on complements on log surfaces // MSJ Memoirs V. 10. 2001.
- [7] *Shokurov V. V.* Complements on surfaces // J. of Math. Sci. 2000. V. 102. No. 2. P. 3876–3932.
- [8] *Zhang D.-Q.* Logarithmic Enriques surfaces // J. Math. Kyoto Univ. 1991. V. 31. P. 419–466.

DEPARTMENT OF ALGEBRA, FACULTY OF MATHEMATICS, MOSCOW STATE  
LOMONOSOV UNIVERSITY, 117234 MOSCOW, RUSSIA  
*E-mail address:* kudryav@mech.math.msu.su