

# Scale- and gauge-independent mixing angles for scalar particles

J.R. Espinosa<sup>1,2\*</sup> and Y. Yamada<sup>3†</sup>

<sup>1</sup> I.M.A.F.F. (CSIC), Serrano 113 bis, 28006 Madrid, Spain

<sup>2</sup> I.F.T. C-XVI, U.A.M., 28049 Madrid, Spain

<sup>3</sup> Department of Physics, Tohoku University, Sendai 980-8578, Japan

## Abstract

The existing definitions of mixing angles (one-loop radiatively corrected and renormalization-scale independent) for scalar particles turn out to be gauge dependent when used in gauge theories. We show that a scale- and gauge-independent mixing angle can be obtained if the scalar self-energy is improved by the pinch technique, and give two relevant examples in the Minimal Supersymmetric Standard Model: the mixing of CP-even Higgs scalars and of top squarks. We also show that the recently proposed definition of mixing angle that uses the (unpinched) scalar two-point function evaluated at a particular value of the external momentum [ $p_*^2 = (M_1^2 + M_2^2)/2$ , where  $M_{1,2}$  are the masses of the mixed particles] computed in the Feynman gauge coincides with the gauge-invariant pinched result. In alternative definitions (*e.g.* in the on-shell scheme), the improved Higgs mixing angle is different from that in the Feynman gauge. Some freedom in the pinch technique for scalar-scalar-gauge couplings is also discussed.

July 2002

---

\*E-mail address: [espinosa@makoki.iem.csic.es](mailto:espinosa@makoki.iem.csic.es)

†E-mail address: [yamada@tuhep.phys.tohoku.ac.jp](mailto:yamada@tuhep.phys.tohoku.ac.jp)

# 1 Introduction

The mixing among fermions with the same quantum numbers is a very important aspect of the Standard Model (in the quark and neutrino sectors). In this paper we focus on the mixing of scalar particles that will play a similarly important role if the world is supersymmetric at low energy. In particular, the Minimal Supersymmetric Standard Model (MSSM) [1] accommodates two main examples of interest: the mixing among Higgs bosons (of the two CP-even scalars if CP is conserved; of three states if CP violation in the Higgs sector is important) and the mixing among squarks (with the case of top squarks being the one in which such effects are expected to be larger). Both cases are sensitive to the large top Yukawa coupling and radiative corrections to the mixing matrices are significant.

There have been several proposals for the renormalized mixing matrix of scalar bosons, which both are independent of the renormalization scale [unlike what happens in the modified minimal subtraction ( $\overline{\text{MS}}$ ) scheme], and do not rely on the specific process considered. One is the on-shell scheme [2]. Another, which we call the  $p_*$  scheme, was recently proposed in Ref. [3]. In both schemes (discussed in more detail in section 2) the counterterm for the mixing matrix is constructed from the off-diagonal self-energies  $\Pi_{ij}(p^2)$  of the scalar bosons. Unfortunately, the on-shell scheme was shown to be dependent on the gauge fixing parameters  $\xi$  in general  $R_\xi$  gauges [4] (the same happens with the on-shell fermion mixing matrices [5,6]). This is also the case for the latter scheme [3] as we show in section 2.

One way of avoiding this difficulty is to apply a procedure to build gauge-independent self-energies, so that the counterterm of the mixing matrix given in terms of these improved self-energies is automatically gauge independent. We perform this improvement by using the well known pinch technique [7–9]. In section 3 we carry out this program for the top squark sector, while in section 4 we do the same for the (CP-conserving) Higgs sector, after showing explicitly the gauge dependence of the Higgs boson self-energies in the  $R_\xi$  gauge. In both cases we arrive at an improved definition (in either the on-shell or the  $p_*$  scheme) of mixing matrices (or, equivalently, mixing angles) that is not only scale and process independent but also gauge independent. There is, however, some freedom regarding the inclusion of some pinched contributions in the improved self-energies. This problem is addressed, by using the background field

method, in section 5 where we arrive at a prescription to determine what contributions to include in the pinched self-energies. A brief summary and our conclusions regarding the prescription to obtain gauge-independent mixing angles are presented in section 6.

## 2 Scale-independent renormalization schemes for the mixing matrix of scalars

In this section we review two schemes for the renormalization of the mixing matrices of scalar particles that are independent of the renormalization scale  $Q$ , and show that both of them are generally dependent on the gauge fixing parameters. We first consider the running of the mixing matrix of  $n$  real scalar particles, in the  $\overline{\text{MS}}$  [or dimensional reduction  $\overline{\text{DR}}$  for supersymmetric theories] renormalization scheme. It is assumed that these particles do not mix with massive gauge bosons. The generalization for complex scalars is straightforward.

Let  $\phi_\alpha$  ( $\alpha = 1, \dots, n$ ) be real scalar fields in the gauge eigenstate basis, related to the bare fields  $\phi_{\alpha 0}$  by

$$\phi_{\alpha 0} = \left( \delta_{\alpha\beta} + \frac{1}{2} \delta Z_{\alpha\beta} \right) \phi_\beta . \quad (1)$$

(Unless otherwise indicated, a sum over repeated indices is always understood.) The running mass matrix  $M_{\alpha\beta}^2$ , related to bare parameters and counterterms by

$$M_{\alpha\beta}^2 = M_{\alpha\beta 0}^2 - \delta M_{\alpha\beta}^2 + \frac{1}{2} (\delta Z_{\gamma\alpha} M_{\gamma\beta}^2 + M_{\alpha\gamma}^2 \delta Z_{\gamma\beta}) , \quad (2)$$

is diagonalized by a real orthogonal mixing matrix  $R$  as

$$m_i^2 \delta_{ij} = R_{i\alpha} M_{\alpha\beta}^2 R_{j\beta} \quad (3)$$

(with no sum over  $i$ ). The relation between the gauge eigenstates  $\phi_\alpha$  and the mass eigenstates  $\phi_i$ , with (running) masses  $m_i$ , is then expressed as

$$\phi_i = R_{i\alpha} \phi_\alpha , \quad \phi_\alpha = R_{i\alpha} \phi_i , \quad (4)$$

with  $R_{i\alpha} R_{i\beta} = \delta_{\alpha\beta}$  and  $R_{i\alpha} R_{j\alpha} = \delta_{ij}$ .

The  $Q$  dependence of the running mixing matrix  $R_{i\alpha}$  is determined from the  $i \neq j$  parts of Eq. (3). Using

$$\frac{d\phi_\alpha}{d \ln Q^2} = \gamma_{\alpha\beta} \phi_\beta , \quad (5)$$

$$\frac{dM_{\alpha\beta}^2}{d \ln Q^2} = \beta_{\alpha\beta}^0 - M_{\alpha\rho}^2 \gamma_{\rho\beta} - \gamma_{\rho\alpha} M_{\rho\beta}^2 , \quad (6)$$

where  $\beta_{\alpha\beta}^0 = -d\delta M_{\alpha\beta}^2/d\ln Q^2$ , we obtain

$$\frac{d}{d\ln Q^2} R_{i\alpha} = \sum_{j \neq i} X_{ij} R_{j\alpha} , \quad (7)$$

$$X_{ij} = \frac{1}{m_i^2 - m_j^2} [\beta_{ij}^0 - (m_i^2 + m_j^2)\gamma_{ij}] . \quad (8)$$

In this expression  $\beta_{ij}^0$  and  $\gamma_{ij}$  are obtained from  $\beta_{\alpha\beta}^0$  and  $\gamma_{\alpha\beta}$ , respectively, by rotating with  $R$ . For  $R$  to be orthogonal at any  $Q$ ,  $X_{ij}$  must satisfy  $X_{ij} + X_{ji} = 0$ , as is realized in Eq. (8).

Although the  $\overline{\text{MS}}$  ( $\overline{\text{DR}}$ ) running mixing matrix is simple, it is often convenient to introduce an effective mixing matrix that is independent of the renormalization scale  $Q$ . In addition, to be independent of specific processes that involve  $\phi_i$  fields, it is desirable to construct the counterterm  $\delta R$  using the self-energy  $\Pi_{ij}(p^2)$ , after discarding the absorptive part. Here we show two examples of such schemes for the case of two mixed particles ( $n = 2$ ; in this case,  $R_{i\alpha}$  is parametrized by one number, the mixing angle). The first example is the on-shell scheme [2], where  $\delta R$  is fixed to absorb the anti-hermitian part of the wave function correction  $\delta Z_{ij}$  for an external on-shell particle  $\phi_j$ . Its relation to the running  $R$  is

$$R_{i\alpha}^{OS} = R_{i\alpha} - \sum_{j \neq i} \frac{\Pi_{ij}(m_i^2) + \Pi_{ij}(m_j^2)}{2(m_i^2 - m_j^2)} R_{j\alpha} . \quad (9)$$

The bare one-loop two-point functions  $\Pi_{\alpha\beta 0}(p^2)$  are in general ultraviolet (UV) divergent. In the  $\overline{\text{MS}}$  ( $\overline{\text{DR}}$ ) scheme, this divergence leads to a dependence on the renormalization scale  $Q$  of the renormalized two-point function  $\Pi_{\alpha\beta}(p^2)$  given by

$$\frac{\partial}{\partial \ln Q^2} \Pi_{\alpha\beta}(p^2) = \beta_{\alpha\beta}^0 - p^2(\gamma_{\alpha\beta} + \gamma_{\beta\alpha}) . \quad (10)$$

To show this, relate the renormalized one-loop inverse propagator  $\Gamma_{\alpha\beta}(p^2)$  to the bare inverse propagator  $\Gamma_{\alpha\beta 0}(p^2)$  to get

$$\Gamma_{\alpha\beta 0}(p^2) = p^2 \delta_{\alpha\beta} - M_{\alpha\beta}^2 + \Pi_{\alpha\beta}(p^2) - \frac{1}{2} p^2 (\delta Z_{\alpha\beta} + \delta Z_{\beta\alpha}) + \frac{1}{2} (M_{\alpha\gamma}^2 \delta Z_{\gamma\beta} + M_{\gamma\beta}^2 \delta Z_{\gamma\alpha}) . \quad (11)$$

From the condition that the bare inverse propagator  $\Gamma_{\alpha\beta 0}(p^2)$  is  $Q$  independent, and using Eqs. (5) and (6), Eq. (10) follows. Now, using Eqs. (10) and (7),  $R^{OS}$  is shown to be  $Q$  independent.

More recently, Ref. [3] proposed another definition of the mixing angle as the one that appears in the rotation that diagonalizes the effective mass matrix (for  $n = 2$ ),

$$\overline{M}_{\alpha\beta}^2(p^2) \equiv M_{\alpha\beta}^2 - \Pi_{\alpha\beta}(p^2). \quad (12)$$

This mixing matrix is

$$[R(p^2)]_{i\alpha} = R_{i\alpha} - \sum_{j \neq i} \frac{\Pi_{ij}(p^2)}{m_i^2 - m_j^2} R_{j\alpha}. \quad (13)$$

Using Eqs. (10) and (7), it is seen that  $[R(p^2)]$  becomes  $Q$  independent at  $p^2 = p_*^2 \equiv (m_1^2 + m_2^2)/2$ . A scale-independent renormalized mixing angle ( $p_*$  scheme) is then given by the elements of  $[R(p_*^2)]_{i\alpha}$ .

In gauge theories, individual vertex functions generally depend on the gauge fixing, while the total corrections to physical quantities (masses, cross sections, etc.) and the gauge-symmetric  $\overline{\text{MS}}$  ( $\overline{\text{DR}}$ ) parameters do not. It is therefore necessary to examine the gauge dependence of the scale-independent mixing angles defined above. Working in the  $R_\xi$  gauge, the dependence of  $\Pi_{ij}(p^2)$  on the gauge parameter  $\xi$  is given by the Nielsen identity [10,11],

$$\partial_\xi \Pi_{ij}(p^2) = \Lambda_{ij}(p^2)(p^2 - m_j^2) + (p^2 - m_i^2)\Lambda_{ji}^*(p^2), \quad (14)$$

where  $\Lambda_{ij}(p^2)$  are some one-loop scalar functions. This identity is crucial to show that pole masses are gauge independent and can be used to study also the gauge dependence of mixing angles. In both the on-shell and the  $p_*$  schemes, the  $\xi$  dependence remains in  $\delta R$ , implying the gauge dependence of these schemes. More explicitly, one gets

$$\partial_\xi R_{i\alpha}^{OS} = -\frac{1}{2} \sum_{j \neq i} R_{j\alpha} [\Lambda_{ij}(m_i^2) - \Lambda_{ji}^*(m_j^2)] \neq 0 \quad (15)$$

for the on-shell mixing matrix and

$$\partial_\xi [R(p_*^2)]_{i\alpha} = -\frac{1}{2} \sum_{j \neq i} R_{j\alpha} [\Lambda_{ij}(p_*^2) - \Lambda_{ji}^*(p_*^2)] \neq 0 \quad (16)$$

for the  $p_*$  scheme (in general,  $\Lambda$  is not a hermitian matrix). The gauge-dependent parts of  $\delta R$  are UV finite [4,6] and numerically rather small, but not satisfactory from the theoretical point of view.

Nevertheless, we may modify these scale-independent mixing angles to be gauge independent. This is done by splitting the gauge-dependent parts from the off-diagonal

self-energies  $\Pi_{ij}(p^2)$  by a definite procedure, and then using the remaining, gauge-independent parts for the definitions (9) and (13). In the following two sections, we perform such a modification for two cases in the MSSM, adopting the pinch technique: the left-right mixing of top squarks and the mixing of two CP-even Higgs bosons.

### 3 Mixing angle of top squarks

The gauge eigenstates  $\tilde{t}_\alpha = (\tilde{t}_L, \tilde{t}_R)$  of top squarks mix with each other to give the mass eigenstates  $\tilde{t}_i$  ( $i = 1, 2$ ). Their relation is given by  $\tilde{t}_i = R_{i\alpha}^{\tilde{t}} \tilde{t}_\alpha$  with the left-right mixing matrix

$$R_{i\alpha}^{\tilde{t}} = \begin{pmatrix} \cos \theta_{\tilde{t}} & \sin \theta_{\tilde{t}} \\ -\sin \theta_{\tilde{t}} & \cos \theta_{\tilde{t}} \end{pmatrix}. \quad (17)$$

We first consider the gauge dependence of the scale-independent renormalization of the left-right mixing angle of the top squarks  $\tilde{t}$  in general  $R_\xi$  gauges, and later on discuss its improvement by the pinch technique.

The unrenormalized two-point function  $\Pi_{ij}^{\tilde{t}}(p^2)$  is gauge dependent. Its dependence on  $\xi_Z$  and  $\xi_W$ , expressed as the difference from the Feynman gauge result [12], takes the following form [4]

$$\begin{aligned} \Pi_{ij}^{\tilde{t}}(p^2) &= \Pi_{ij}^{\tilde{t}}(p^2) \Big|_{\xi_Z=\xi_W=1} \\ &+ \frac{g_Z^2}{16\pi^2} (1 - \xi_Z) \chi_{ik}^Z \chi_{jk}^Z \left[ -f_{ij}(p^2) \alpha_Z + g_{ij}(p^2, m_{\tilde{t}_k}^2) \beta_{Z\tilde{t}_k}^{(0)}(p^2) \right] \\ &+ \frac{g_2^2}{8\pi^2} (1 - \xi_W) \chi_{ik}^W \chi_{jk}^W \left[ -f_{ij}(p^2) \alpha_W + g_{ij}(p^2, m_{\tilde{b}_k}^2) \beta_{W\tilde{b}_k}^{(0)}(p^2) \right]. \end{aligned} \quad (18)$$

Here  $g_Z^2 = g_1^2 + g_2^2$ , with  $g_1$  and  $g_2$  the gauge coupling constants of  $U(1)_Y$  and  $SU(2)_L$ , respectively, and we have defined the quantities ( $R_{i\alpha}^{\tilde{b}}$  is the mixing matrix of bottom squarks)

$$\chi_{ik}^Z \equiv \frac{1}{2} R_{iL}^{\tilde{t}} R_{kL}^{\tilde{t}} - \frac{2}{3} \delta_{ik} \sin^2 \theta_W, \quad (19)$$

$$\chi_{ik}^W \equiv \frac{1}{2} R_{iL}^{\tilde{t}} R_{kL}^{\tilde{b}}, \quad (20)$$

the functions

$$f_{ij}(p^2) \equiv \frac{1}{2} (2p^2 - m_i^2 - m_j^2), \quad (21)$$

$$g_{ij}(p^2, m^2) \equiv (p^2 - m^2)(2p^2 - m_i^2 - m_j^2) - (p^2 - m_i^2)(p^2 - m_j^2), \quad (22)$$

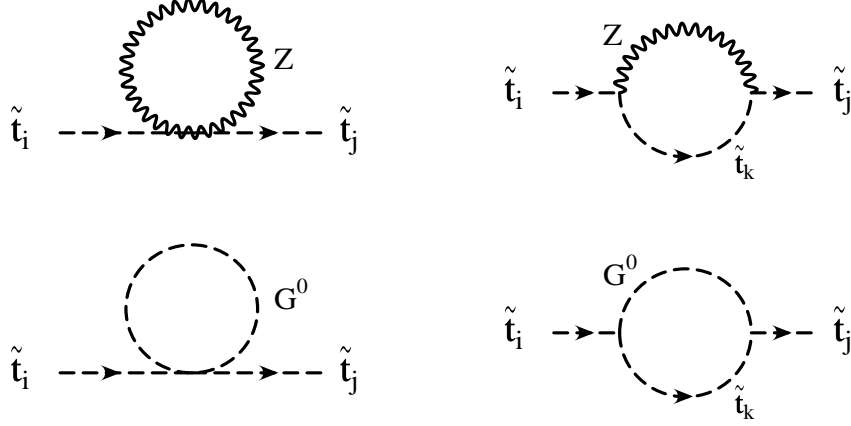

Figure 1: One-loop corrections to the top squark self-energies that introduce a  $\xi_Z$  dependence in  $R_\xi$  gauges. Diagrams with  $\xi_W$  dependence are quite similar (with  $Z \rightarrow W$ ,  $G^0 \rightarrow G^\pm$ ,  $\tilde{t}_k \rightarrow \tilde{b}_k$ ) and not shown.

and the loop integrals

$$\frac{i}{16\pi^2}\alpha_i \equiv \int \frac{d^D q}{(2\pi)^D} \frac{1}{(q^2 - m_i^2)(q^2 - \xi_i m_i^2)}, \quad (23)$$

$$\frac{i}{16\pi^2}\beta_{ij}^{(0)}(p^2) \equiv \int \frac{d^4 q}{(2\pi)^4} \frac{1}{(q^2 - m_i^2)(q^2 - \xi_i m_i^2)[(q+p)^2 - m_j^2]}, \quad (24)$$

where  $D = 4 - 2\epsilon$ .

The Feynman diagrams that cause the gauge dependence of top squark self-energies are depicted in Fig. 1. Although this figure shows only the diagrams that introduce a  $\xi_Z$  dependence, the  $\xi_W$ -dependent ones are quite similar. We do not treat the  $\xi_\gamma$  and  $\xi_g$  dependences since they are irrelevant for the renormalization of the mixing angle. In addition, one should include the gauge-dependent shifts of the vacuum expectation values (VEVs)  $v_\alpha$  of the two Higgs bosons by tadpole graphs, for the gauge-independent renormalization of the VEVs [4,13,14]. The final result, given by Eq. (18), satisfies the Nielsen identity (14).

The two definitions of the scale-independent renormalized  $\theta_{\tilde{t}}$  given in section 2 are gauge dependent, as can be shown by direct substitution of Eq. (18) into Eq. (9) or Eq. (13). In more detail, for the on-shell scheme, although

$$f_{ij}(m_i^2) + f_{ij}(m_j^2) = 0, \quad (25)$$

one has

$$g_{ij}(m_i^2, m_k^2)\beta_{Z\tilde{t}_k}^{(0)}(m_i^2) + g_{ij}(m_j^2, m_k^2)\beta_{Z\tilde{t}_k}^{(0)}(m_j^2) \neq 0, \quad (26)$$

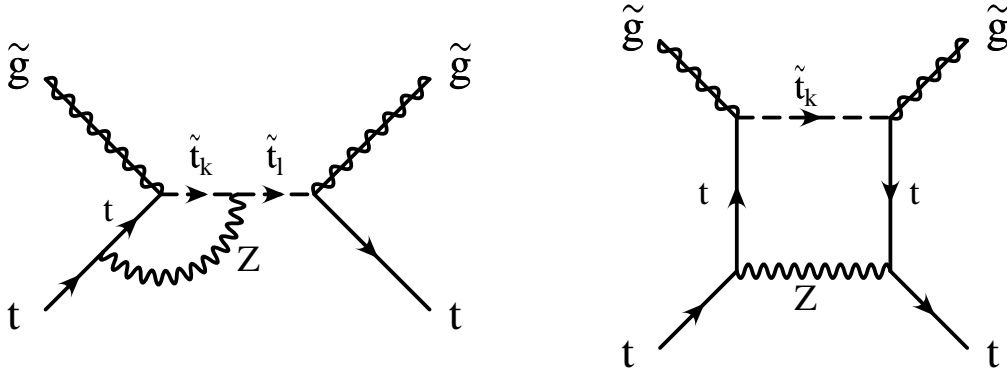

Figure 2: One-loop vertex and box corrections to the process  $\tilde{g}t \rightarrow \tilde{g}t$  that involve the  $Z^0$  gauge boson and contribute to the pinched top squark self-energies. Diagrams with  $W^\pm$  corrections are quite similar; simply replace  $Z \rightarrow W$ ,  $t \rightarrow b$ ,  $\tilde{t}_k \rightarrow \tilde{b}_k$  in internal lines.

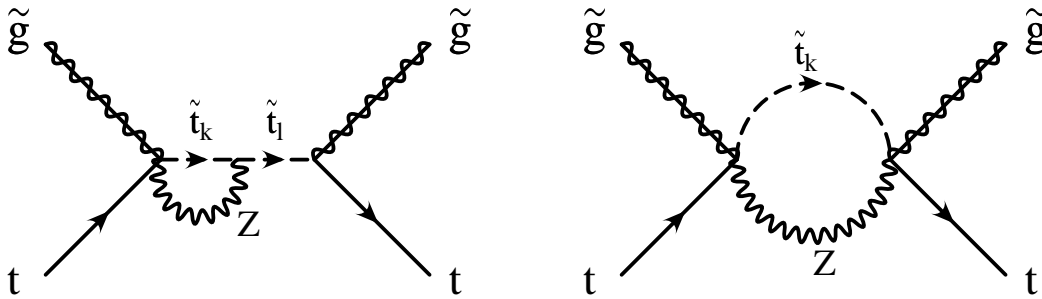

Figure 3: Diagrammatic representation of the pinched parts of the diagrams in fig. 2.

(and a similar equation for the  $W$  contribution); while for the  $p_*$  scheme, again

$$f_{ij}(p_*^2) = 0 \quad (27)$$

goes well, but

$$g_{ij}(p_*^2)\beta_{Z\tilde{t}_k}^{(0)}(p_*^2) = \frac{1}{4}(m_i^2 - m_j^2)^2\beta_{Z\tilde{t}_k}^{(0)}(p_*^2) \neq 0, \quad (28)$$

even if it gets “closer” than Eq. (26) to being zero. (Of course, if  $m_i^2 = m_j^2$  the mixing angle is not well determined.)

When the top squark self-energies are embedded in the calculation of some cross section at one loop, we know that their gauge dependence should be cancelled by other one-loop contributions to the same process. Processes with external on-shell top squarks were discussed in [4]. Here we consider a more general case with off-shell top squarks. To avoid complications due to the mixing of external particles, we use the scattering amplitude of  $t\tilde{g} \rightarrow t\tilde{g}$  with s-channel top squark exchange. In this



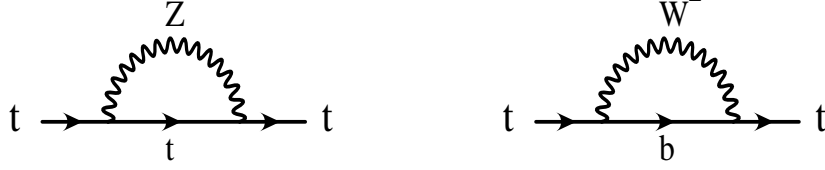

Figure 4: One-loop wave-function-renormalization corrections for the top quark that involve the  $Z^0$  and  $W^\pm$  gauge bosons.

particular case, the gauge dependence of the self-energy corrections just discussed must be cancelled by that of the vertex and box corrections (Fig. 2). The so-called pinch technique [7–9] extracts “propagator-like” contributions out of the vertex and box corrections. By triggering Ward-Takahashi identities at the gauge interaction vertices multiplied by longitudinal momenta, internal propagators in the loop are cancelled (or “pinched”), giving contributions that can be interpreted as shifts in the top squark self-energies. More precisely, in computing vertex corrections such as the one in Fig. 2 one uses identities like

$$\frac{1}{m_t - \not{q} - \not{q}_i} \not{q} = -1 + \frac{1}{m_t - \not{q} - \not{q}_i} (m_t - \not{q}_i), \quad (29)$$

where  $q$  is the momentum of the virtual  $Z$ , and  $q_i$  is the momentum of the incoming top quark. The  $\not{q}$ -independent operator  $(m_t - \not{q}_i)$ , moved to the right until it acts on the wave function of the external top quark, gives zero or something proportional to  $m_t$  depending on the operators that stand in its way. In the first term of Eq. (29) the internal top propagator has been cancelled giving rise to a pinched contribution. Figure 3 represents the pinched parts of the diagrams in Fig. 2, with the internal propagator of the top quark pinched. The improved self-energies  $\Pi_{ij}^P(p^2)$  that include these pinched terms are then gauge independent, do not modify the positions of the poles and are process independent.

Some pinch contributions come from the  $(1 - \xi_V)q_\mu q_\nu$  parts of the gauge boson propagators. The contribution from vertex corrections (including wave function corrections of external on-shell fermions, see Fig. 4) is

$$\begin{aligned} \Delta\Pi_{ij}^{\bar{t}}(V) &= \frac{1}{16\pi^2} (2p^2 - m_{\bar{t}_i}^2 - m_{\bar{t}_j}^2) \\ &\times \left\{ g_Z^2 (1 - \xi_Z) \chi_{ik}^Z \chi_{jk}^Z \left[ \frac{1}{2} \alpha_Z - (p^2 - m_{\bar{t}_k}^2) \beta_{Z\bar{t}_k}^{(0)}(p^2) \right] \right. \\ &\quad \left. + 2g_W^2 (1 - \xi_W) \chi_{ik}^W \chi_{jk}^W \left[ \frac{1}{2} \alpha_W - (p^2 - m_{\bar{b}_k}^2) \beta_{W\bar{b}_k}^{(0)}(p^2) \right] \right\}. \quad (30) \end{aligned}$$

In addition, the pinched box contribution is

$$\begin{aligned} \Delta\Pi_{ij}^{\tilde{t}}(B) &= \frac{1}{16\pi^2}(p^2 - m_{\tilde{t}_i}^2)(p^2 - m_{\tilde{t}_j}^2) \\ &\times \left[ g_Z^2(1 - \xi_Z)\chi_{ik}^Z\chi_{jk}^Z\beta_{Z\tilde{t}_k}^{(0)}(p^2) + 2g_2^2(1 - \xi_W)\chi_{ik}^W\chi_{jk}^W\beta_{W\tilde{b}_k}^{(0)}(p^2) \right]. \end{aligned} \quad (31)$$

Adding to the original self-energy (18) the pinched contributions (30) and (31), the gauge dependence exactly cancels and the improved pinched self-energies, as well as the improved scale-independent mixing angle  $\theta_{\tilde{t}}$ , are equal to the simple  $\xi = 1$  results in the conventional calculation:

$$\Pi_{ij}^{\tilde{t}}(p^2) + \Delta\Pi_{ij}^{\tilde{t}}(V) + \Delta\Pi_{ij}^{\tilde{t}}(B) \equiv \Pi_{ij}^{\tilde{t}P}(p^2) = \Pi_{ij}^{\tilde{t}}(p^2)\Big|_{\xi_Z=\xi_W=1}. \quad (32)$$

This is consistent with previous results [4] for general on-shell scalar particles (other than Higgs bosons).

However, there is another possible source of longitudinal momenta for pinching: the momentum-dependent  $\tilde{t}^*\tilde{t}Z$  (and  $\tilde{t}\tilde{b}W$ ) couplings in Fig. 2. More explicitly, the factor  $(2p+q)_\mu$  from the vertex  $\tilde{t}^*(-p-q)\tilde{t}(p)Z_\mu(q)$  triggers the identity

$$\frac{1}{m_t - \not{q} - \not{q}_i}(2\not{p} + \not{q}) = -1 + \frac{1}{m_t - \not{q} - \not{q}_i}[(m_t + \not{q}_i) + 2(\not{p} - \not{q}_i)], \quad (33)$$

which also gives a pinched contribution. [The  $\not{q}$ -independent operators  $(m_t + \not{q}_i)$  and  $(\not{p} - \not{q}_i)$  do not induce further pinching.] This type of additional pinch operation is known to be necessary to obtain gauge-independent self-energies for the Goldstone bosons in the Standard Model [9]. Notice that now this pinched contribution does not depend on  $\xi_{Z,W}$ . Therefore, applying this additional pinching, the resulting improved self-energy is then different from the  $\xi = 1$  result by

$$\begin{aligned} \Delta_P\Pi_{ij}^{\tilde{t}}(\tilde{t}\tilde{t}Z, \tilde{t}\tilde{b}W) &= -\frac{1}{16\pi^2}(2p^2 - m_{\tilde{t}_i}^2 - m_{\tilde{t}_j}^2) \\ &\times \left[ g_Z^2\chi_{ik}^Z\chi_{jk}^Z B_0(p^2, m_Z^2, m_{\tilde{t}_k}^2) + 2g_2^2\chi_{ik}^W\chi_{jk}^W B_0(p^2, m_W^2, m_{\tilde{b}_k}^2) \right], \end{aligned} \quad (34)$$

with

$$\frac{i}{16\pi^2}B_0(p^2, m_i^2, m_j^2) = \int \frac{d^D q}{(2\pi)^D} \frac{1}{(q^2 - m_i^2)[(q+p)^2 - m_j^2]}. \quad (35)$$

This might be regarded as a source of non-uniqueness of the pinch technique in theories with many scalar fields. The decomposition of the scalar-scalar-gauge vertices is necessary for the Goldstone boson self-energies in the Standard Model to be gauge

independent and satisfy the naive Ward-Takahashi identities [9], but such arguments do not apply in the case of squarks (or other sfermions) and CP-even Higgs bosons.

It is easily seen that this additional term (34) does not affect the cancellation of the divergent correction to the mixing angle in the schemes in section 2 [see Eqs. (25) and (27)]. Also, when applied to the gauge boson exchange contribution to the  $e^+e^- \rightarrow \tilde{t}\tilde{t}^*$  amplitudes, it is seen that the decomposition of the  $(\tilde{t}\tilde{t}Z, \tilde{t}\tilde{b}W)$  vertices does not produce any additional contributions to be added to the gauge boson self-energies. It is therefore not clear whether or not this type of pinching should be applied in this particular case. We will go back to this problem in section 5.

We finally address the modification of the scale-independent mixing angle by the pinch technique rearrangement. Substituting the forms of the pinched corrections, Eqs. (30) and (31), into the counterterms in Eqs. (9) and (13), it is amusing to note that the  $p_*$  scheme is not affected by the vertex contribution, while the on-shell scheme is not affected by the box contribution. An interesting point of the  $p_*$  scheme is that it is insensitive to the arbitrariness in the treatment of scalar-scalar-gauge vertices in the pinch operation. In particular, if the pinched term (34) is added to the top squark self-energies then the  $p_*$  definition of a scale- and gauge-independent mixing angle for top squarks is not affected (with respect to the naive  $\xi = 1$  result) while the on-shell definition should be modified to take into account the effect of the contribution (34).

## 4 Mixing angle of CP-even Higgs bosons

The two CP-even Higgs scalars  $\eta_\alpha \equiv \sqrt{2}\text{Re}H_\alpha^0 - v_\alpha$  ( $\alpha = 1, 2$ ) in the MSSM mix with each other [1,16] to form the mass eigenstates  $h_i = (H^0, h^0)$ . They are related by a rotation matrix  $R$  as

$$\eta_\alpha = R_{\alpha i} h_i = \begin{pmatrix} \cos \alpha & -\sin \alpha \\ \sin \alpha & \cos \alpha \end{pmatrix} \begin{pmatrix} H^0 \\ h^0 \end{pmatrix}. \quad (36)$$

The scale-independent renormalization of the mixing angle  $\alpha$ , along the lines explained in section 2, inherits the gauge dependence of the self-energy  $\Pi_{ij}^h(p^2)$ . In this section, we perform the improvement of  $\Pi_{ij}^h(p^2)$  by the pinch technique. In contrast to the case of top squarks, the improved self-energies differ from the conventional  $\xi = 1$  results, as is the case of the Higgs boson self-energy in the Standard Model [15]. We note in passing that the gauge-independent Higgs boson self-energies are useful not only

for a proper definition of a scale-independent Higgs mixing angle  $\alpha$ , but also for the treatment of s-channel resonant production of  $(h^0, H^0)$  at photon [17] or muon [18] colliders.

Following the previous analysis in [15], we consider  $f\bar{f} \rightarrow f'\bar{f}'$  scatterings mediated by the CP-even Higgs bosons. Working in the  $R_\xi$  gauge, we obtain that the Higgs boson self-energies depend on the gauge parameters through the following expression

$$\begin{aligned} \Pi_{ij}^h(p^2) &= \Pi_{ij}^h(p^2) \Big|_{\xi_W=\xi_Z=1} \\ &+ \frac{g_Z^2}{64\pi^2}(1-\xi_Z) \left\{ g_{ij}(p^2, m_A^2) \mathcal{O}_{ij}^{(1)} \beta_{ZA}^{(0)}(p^2) - f_{ij}(p^2) \delta_{ij} \alpha_Z \right. \\ &\quad \left. + \frac{1}{2} g_{ij}(p^2, 0) \mathcal{O}_{ij}^{(2)} \left[ \beta_{ZZ}^{(0)}(p^2) + \beta_{Z,\xi_Z}^{(0)}(p^2) \right] \right\} \\ &+ \frac{g_2^2}{32\pi^2}(1-\xi_W) \left\{ g_{ij}(p^2, m_{H^\pm}^2) \mathcal{O}_{ij}^{(1)} \beta_{WH^\pm}^{(0)}(p^2) - f_{ij}(p^2) \delta_{ij} \alpha_W \right. \\ &\quad \left. + \frac{1}{2} g_{ij}(p^2, 0) \mathcal{O}_{ij}^{(2)} \left[ \beta_{WW}^{(0)}(p^2) + \beta_{W,\xi_W}^{(0)}(p^2) \right] \right\} , \quad (37) \end{aligned}$$

where  $f_{ij}$  and  $g_{ij}$  have been defined in Eqs. (21,22) and we have introduced the operators

$$\mathcal{O}_{ij}^{(1)} \equiv (R_{1i}^h \sin \beta - R_{2i}^h \cos \beta)(R_{1j}^h \sin \beta - R_{2j}^h \cos \beta) , \quad (38)$$

$$\mathcal{O}_{ij}^{(2)} \equiv (R_{1i}^h \cos \beta + R_{2i}^h \sin \beta)(R_{1j}^h \cos \beta + R_{2j}^h \sin \beta) . \quad (39)$$

Notice in particular that these operators satisfy  $\mathcal{O}_{ij}^{(1)} + \mathcal{O}_{ij}^{(2)} = \delta_{ij}$  and  $\mathcal{O}_{ij}^{(1)} \mathcal{O}_{jk}^{(2)} = 0$ .

The Feynman diagrams that introduce a dependence on  $\xi_Z$  are presented in Fig. 5. Those that give a  $\xi_W$ -dependent contribution are quite similar and not shown. As in the case of top squarks in the previous section, we also included the gauge-dependent shifts of the two Higgs boson VEVs by the corresponding tadpole graphs. In fact, the result (37) holds whenever the parameters  $(m_Z, m_A, \tan \beta)$  in the tree-level mass matrix of  $\eta_\alpha$  are renormalized in gauge-independent ways.

The ‘‘propagator-like’’ terms that correct the previous self-energies are extracted from vertex and box corrections by the pinch technique. The necessary diagrams are given in Figs. 6 and 7 for the case of  $\mu^+\mu^- \rightarrow b\bar{b}$  scattering. Note that one also has to analyze processes with external up-type ( $I_3 = +1/2$ ) fermions for the correct assignment of pinch terms to  $\Pi_{11}^h$ ,  $\Pi_{22}^h$ , and  $\Pi_{12}^h$ . Box diagrams with  $(Z, h_i)$ , as well as parts of the box diagrams with  $W^\pm$ , give propagator-like terms with pseudoscalar couplings to fermions. These are pinch terms for self-energies of gauge and  $(A^0, G^0)$

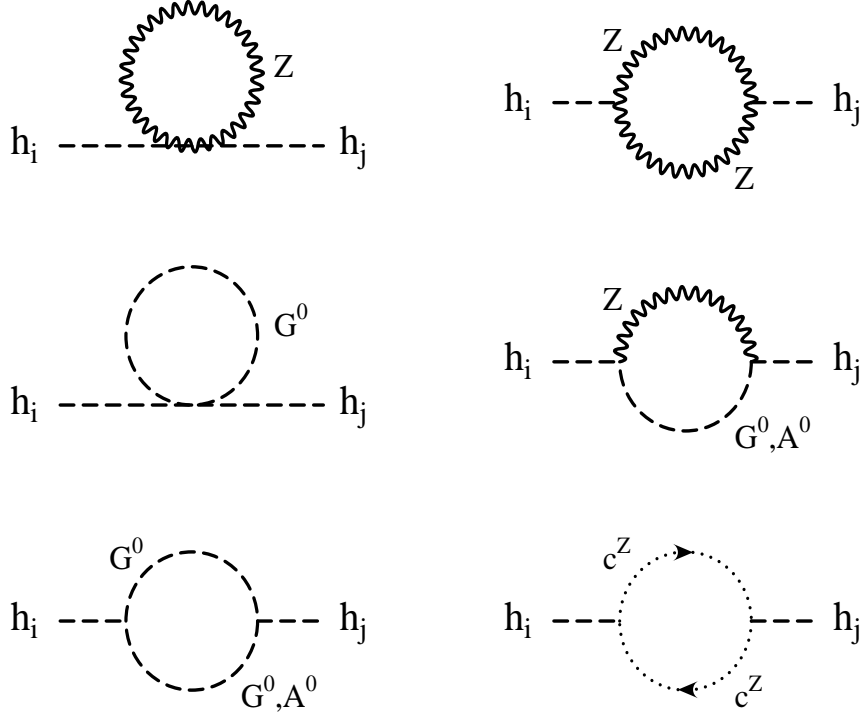

Figure 5: One-loop corrections to the Higgs boson self-energies that introduce a  $\xi_Z$  dependence in  $R_\xi$  gauges. Diagrams with  $\xi_W$  dependence are quite similar (with  $Z \rightarrow W$ ,  $G^0 \rightarrow G^\pm$ ,  $A^0 \rightarrow H^\pm$  and  $c^Z \rightarrow c^W$ ) and not shown.

bosons, and not relevant for our study. In addition to the diagrams shown, one should also include the pinching coming from wave function renormalization of external legs.

As in the previous section, there are two sources of momenta for pinching: the  $(1 - \xi_V)q_\mu q_\nu$  parts of the gauge boson propagators and gauge-scalar-scalar vertices. The former parts generate the following pinch terms from vertex corrections (including fermion wave function corrections):

$$\begin{aligned}
\Delta\Pi_{ij}^h(V) &= -\frac{1}{128\pi^2}(2p^2 - m_i^2 - m_j^2) \\
&\times \left[ g_Z^2(1 - \xi_Z) \left\{ 2(p^2 - m_A^2)\mathcal{O}_{ij}^{(1)}\beta_{ZA}^{(0)}(p^2) - \delta_{ij}\alpha_Z \right. \right. \\
&\quad \left. \left. + \mathcal{O}_{ij}^{(2)} \left[ (p^2 + 2m_Z^2)\beta_{ZZ}^{(0)}(p^2) + p^2\beta_{Z,\xi Z}^{(0)}(p^2) \right] \right\} \right. \\
&\quad \left. + 2g_2^2(1 - \xi_W) \left\{ 2(p^2 - m_{H^\pm}^2)\mathcal{O}_{ij}^{(1)}\beta_{WH^\pm}^{(0)}(p^2) - \delta_{ij}\alpha_W \right. \right. \\
&\quad \left. \left. + \mathcal{O}_{ij}^{(2)} \left[ (p^2 + 2m_W^2)\beta_{WW}^{(0)}(p^2) + p^2\beta_{W,\xi W}^{(0)}(p^2) \right] \right\} \right] , \quad (40)
\end{aligned}$$

and from box correction diagrams

$$\Delta\Pi_{ij}^h(B) = \frac{1}{64\pi^2}(p^2 - m_i^2)(p^2 - m_j^2)$$

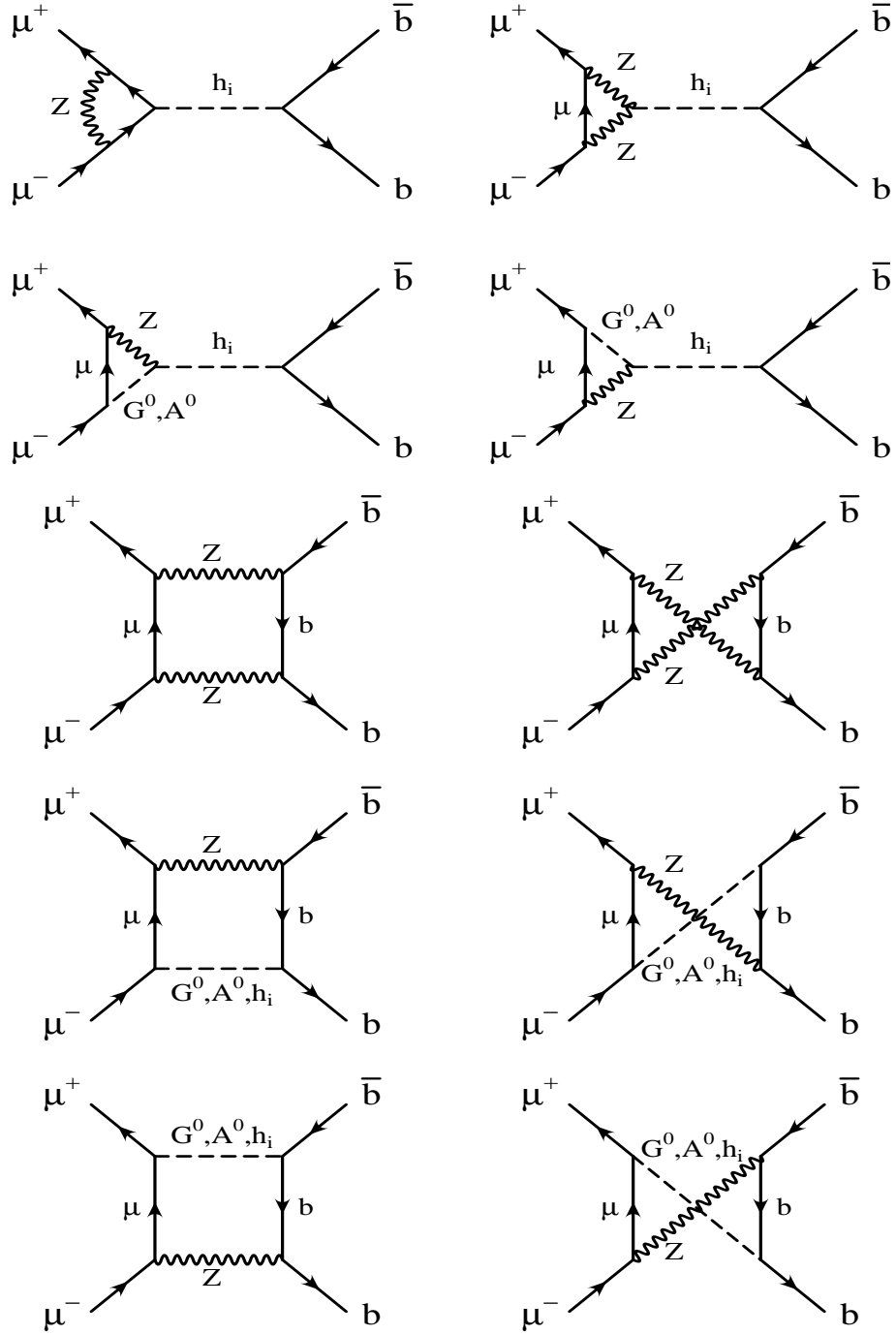

Figure 6: One-loop vertex and box corrections to the process  $\mu^+\mu^- \rightarrow b\bar{b}$  that involve the  $Z^0$  gauge boson and contribute to the pinched Higgs boson self-energies. Diagrams with corrections to the  $h_i b\bar{b}$  vertex are quite similar to those with  $h_i \mu^+ \mu^-$  vertex corrections and are not shown.

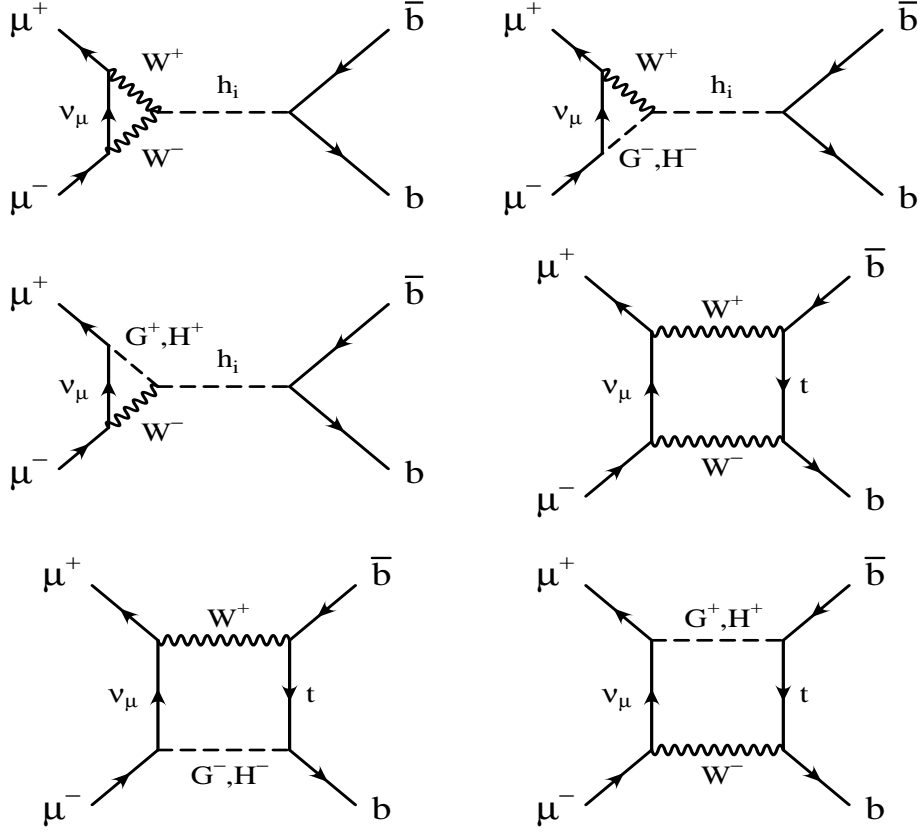

Figure 7: One-loop vertex and box corrections to the process  $\mu^+\mu^- \rightarrow b\bar{b}$  that involve the  $W^\pm$  gauge bosons and contribute to the pinched Higgs boson self-energies. Diagrams with corrections to the  $h_i b\bar{b}$  vertex are quite similar to those with  $h_i \mu^+ \mu^-$  vertex corrections and are not shown.

$$\begin{aligned}
& \times \left[ g_Z^2(1 - \xi_Z) \left\{ \mathcal{O}_{ij}^{(1)} \beta_{ZA}^{(0)}(p^2) + \frac{1}{2} \mathcal{O}_{ij}^{(2)} \left[ \beta_{ZZ}^{(0)}(p^2) + \beta_{Z,\xi Z}^{(0)}(p^2) \right] \right\} \right. \\
& \left. + 2g_2^2(1 - \xi_W) \left\{ \mathcal{O}_{ij}^{(1)} \beta_{WH^\pm}^{(0)}(p^2) + \frac{1}{2} \mathcal{O}_{ij}^{(2)} \left[ \beta_{WW}^{(0)}(p^2) + \beta_{W,\xi W}^{(0)}(p^2) \right] \right\} \right]. \quad (41)
\end{aligned}$$

Comparing to Eq. (37) one sees that the above two contributions are not enough to cancel the  $\xi$  dependence of  $\Pi_{ij}^h$ . In fact, pinching by the momenta in the  $G^0$ - $Z$ - $h_i$  and  $G^\pm$ - $W^\mp$ - $h_i$  vertices in the vertex corrections of Figs. 6 and 7, is necessary to obtain gauge-independent self-energies, as in previous studies of the self-energies for massive gauge bosons and their Goldstone modes [9], as well as the Standard Model Higgs boson [15]. This type of pinching generates additional contributions to the Higgs boson self-energies:

$$\begin{aligned}
\Delta\Pi_{ij}^h(hZG^0, hW^\pm G^\mp) &= -\frac{1}{64\pi^2} (2p^2 - m_i^2 - m_j^2) \mathcal{O}_{ij}^{(2)} \\
&\times \left[ g_Z^2 B_0(p^2, m_Z^2, \xi_Z m_Z^2) + 2g_2^2 B_0(p^2, m_W^2, \xi_W m_W^2) \right]. \quad (42)
\end{aligned}$$

As a result, the modified self-energies become  $\xi$  independent, but different from the

$\xi = 1$  form (unlike what happened for top squarks in section 3) by

$$\begin{aligned}\Delta_P \Pi_{ij}^h(p^2) &= -\frac{1}{64\pi^2}(2p^2 - m_i^2 - m_j^2)\mathcal{O}_{ij}^{(2)} \\ &\times \left[ g_Z^2 B_0(p^2, m_Z^2, m_Z^2) + 2g_2^2 B_0(p^2, m_W^2, m_W^2) \right].\end{aligned}\quad (43)$$

Although all the gauge dependence is now cancelled, the improved self-energy has one unsatisfactory property. The anomalous dimensions of  $h_i$  determined by the pinched self-energy  $\Pi_{ij}^h + \Delta_P \Pi_{ij}^h$  are not diagonal in the gauge eigenbasis  $\eta_\alpha$ , and this might cause problems in renormalization.

We now consider the last possible source for pinching: the  $A^0$ - $Z$ - $h_i$  and  $H^\pm$ - $W^\mp$ - $h_i$  vertices in vertex corrections (Figs. 6 and 7). As in the case of top squarks, there is the freedom of whether or not to perform the pinching by these momenta. Since the additional pinch terms are gauge independent, it looks unnecessary to include these contributions. However, if one includes them, the resulting self-energies are

$$\begin{aligned}\Pi_{ij}^{hP}(p^2) &\equiv \Pi_{ij}^h(p^2) + \Delta\Pi_{ij}^h(V, B) + \Delta\Pi_{ij}^h(hZG^0, hW^\pm G^\mp) + \Delta\Pi_{ij}^h(hZA^0, hW^\pm H^\mp) \\ &= \Pi_{ij}^h(p^2)_{\xi=1} - \frac{1}{64\pi^2}(2p^2 - m_i^2 - m_j^2) \\ &\times \left[ g_Z^2 \left\{ \mathcal{O}_{ij}^{(2)} B_0(p^2, m_Z^2, m_Z^2) + \mathcal{O}_{ij}^{(1)} B_0(p^2, m_Z^2, m_A^2) \right\} \right. \\ &\quad \left. + 2g_2^2 \left\{ \mathcal{O}_{ij}^{(2)} B_0(p^2, m_W^2, m_W^2) + \mathcal{O}_{ij}^{(1)} B_0(p^2, m_W^2, m_{H^\pm}^2) \right\} \right]\end{aligned}\quad (44)$$

and the anomalous dimensions then become diagonal in the gauge basis. Moreover, these modified anomalous dimensions match with the running of the Higgs boson VEVs  $v_\alpha$  in the  $\xi = 1$  gauge: the discrepancy between the running of  $\eta_\alpha$  and of  $v_\alpha$  [19,20] is cancelled by the additional term in Eq. (44). We therefore conclude that Eq. (44) gives the form of the gauge-independent self-energies that should be preferred. In the next section, these nice features of the self-energies (44) are explained in the framework of the background field method.

It is quite reasonable to adopt the well motivated definition of the Higgs boson self-energies given by Eq. (44) to compute scale-independent Higgs mixing angles that are also gauge independent (as explained in section 2). As was discussed at the end of the previous section for the case of the mixing angle between top squarks, in the  $p_*$  scheme this modification of the self-energies does not affect the definition of the mixing angle (it is the same as computed from the non-pinched two-point function in the  $\xi = 1$  gauge). In contrast, the scale-independent definition in the on-shell scheme gets additional corrections from the new terms in Eq. (44).



## 5 Relation to the background field method

It has been shown [21,22] that the self-energies of gauge bosons improved by the pinch technique can be obtained as a special  $\xi = 1$  case of the background field method [23]. This relation also holds for the self-energy of the standard model Higgs boson [15]. In this section, we consider the background field method in theories with many scalar fields, such as the MSSM, and show that the freedom in the treatment of the scalar-scalar-gauge vertices in the pinch technique, discussed in previous sections, corresponds to freedom in the choice of the gauge fixing function.

In the background field method, one first splits the gauge bosons  $V_\mu^a$  ( $a$  is the gauge group index of the adjoint representation) and scalar bosons  $\Phi_I$  ( $I$  denotes one gauge multiplet) into background (with hat) and quantum (without hat) fields, as

$$V_\mu^a \rightarrow \widehat{V}_\mu^a + V_\mu^a, \quad \Phi_I \rightarrow \widehat{\Phi}_I + \Phi_I. \quad (45)$$

The splitting of fermions is trivial and not shown here. When the scalar bosons have nonvanishing VEVs, these are assigned to the background fields  $\widehat{\Phi}_I$ . (In other words, quantum fields have no VEVs.)

The essential point of the background field method is a clever choice of the gauge fixing function  $F^a$ ,

$$F^a = \partial^\mu V_\mu^a - ig[\widehat{V}^\mu, V_\mu]^a - ig\xi_V \sum_I (\widehat{\Phi}_I^\dagger T^{(I)a} \Phi_I - \Phi_I^\dagger T^{(I)a} \widehat{\Phi}_I), \quad (46)$$

where  $T^{(I)a}$  is the group generator for  $\Phi_I$ . This is a natural extension of the usual  $R_\xi$  gauge fixing and manifestly keeps local gauge invariance for background fields. Note that we have to set  $\xi_Z = \xi_W = \xi_\gamma$  to preserve the  $SU(2) \times U(1)$  gauge symmetry.

The one-particle-irreducible vertex functions, given by the loops with external background fields, then satisfy the naive, tree-level-like Ward-Takahashi identities [21–23]. In the standard model, the background field method with  $\xi = 1$  gives the same one-loop self-energies and vertex functions as the pinch technique [15,21,22]. This result can be understood by observing that the change of the propagators and three-point functions, in going from the conventional  $R_\xi$  to the gauge in Eq. (46), corresponds to the splitting of longitudinal momenta for the pinching.

In applying the gauge fixing (46) to theories with many scalar fields, like the MSSM, there is one novel source of arbitrariness which is irrelevant for the standard model. The

gauge fixing function  $F^a$  should include the scalar fields which have gauge-symmetry-breaking VEVs, exactly as in Eq. (46), to cancel the mixing of gauge and scalar bosons. However, one may also include scalar fields with no VEVs into Eq. (46). Unlike what happens in the conventional  $R_\xi$  gauge, this inclusion causes a nontrivial change of the Feynman rules in the scalar-scalar-gauge vertices. If a scalar field  $\phi$  is not included in  $F^a$ , the vertex  $\phi^*(-p-q)\widehat{\phi}(p)V_\mu(q)$  is proportional to  $(2p+q)_\mu$ . On the other hand, if  $\phi$  is included in  $F^a$ , the same vertex becomes proportional to  $2p_\mu$ . Compared to the calculation in sections 3 and 4, it is clearly seen that this modification just amounts to the additional pinching by the momentum from the  $\phi^*\phi V_\mu$  gauge vertex. In the rearrangement of loop corrections by the pinch technique, consequently, the momentum in the  $\phi^*\phi V_\mu$  gauge vertex, with one  $\phi$  not carrying loop momentum, should be used for pinching if and only if  $\phi$  is included in the gauge fixing function  $F^a$ .

In the MSSM, all sources of gauge symmetry breaking can be put together into one “standard-like” scalar doublet,

$$H_{\text{SM}} \equiv \cos\beta(-H_1^+, H_1^{0*}) + \sin\beta(H_2^+, H_2^0), \quad (47)$$

which contains a combination  $\phi_{\text{SM}} = \cos(\alpha - \beta)H^0 - \sin(\alpha - \beta)h^0$ , the Goldstone modes  $G^+$ ,  $G^0$  and the VEV  $v = \sqrt{v_1^2 + v_2^2}$ :

$$H_{\text{SM}} = [G^+, (\phi_{\text{SM}} + v + iG^0)/\sqrt{2}]. \quad (48)$$

The minimal choice for the background gauge fixing is to include only the above  $H_{\text{SM}}$  into Eq. (46). This choice reproduces the first version [Eq. (43)] of the pinched self-energies for Higgs bosons. In this choice, the gauge fixing (46) has hard breaking of a discrete symmetry under  $(H_1, H_2) \rightarrow (-H_1, H_2)$ , causing non-diagonal anomalous dimensions in Eq. (43). Alternatively, we may include both  $H_1$  and  $H_2$  in  $F^a$  with equal weight, as  $(\widehat{H}_1^\dagger T^a H_1 + \widehat{H}_2^\dagger T^a H_2 - \text{h.c.})$ . This choice reproduces the theoretically preferable result in Eq. (44). Since this gauge fixing preserves the discrete symmetry shown above, the improved anomalous dimensions given by (44) should be diagonal in the gauge basis. Moreover, unlike what happens in the conventional  $R_\xi$  gauge [19], there are no sources of discrepancy between the running of  $\eta_\alpha$  and that of  $v_\alpha$ . We therefore conclude that, in using the pinch technique for the MSSM, we should decompose all Higgs-Higgs-gauge vertices for the pinching.

We finally comment on the same kind of freedom in the top squark self-energies discussed in section 3, due to the possible additional pinching by momenta in the  $\tilde{t}^*\tilde{t}Z$

and  $\tilde{t}^*\tilde{b}W$  couplings [Eq. (34)]. It is now evident that this freedom exactly corresponds to that of including or not including squarks into  $F^a$  in the background field method. In contrast with the case of the Higgs bosons just discussed, we could find no theoretical arguments for the inclusion of squarks in the gauge fixing function. Therefore, for simplicity, we prefer not to use for pinching the momenta in the scalar-scalar-gauge couplings, except for the Higgs bosons.

## 6 Summary and conclusions

In this paper we have shown how to improve existing definitions of mixing angles for scalar particles that are renormalization-scale and process independent to make them also gauge independent. This we achieve by applying the pinch technique in order to obtain gauge-independent self-energies from which gauge-independent mixing angles are obtained. Further assistance from the background field method was required to sort out some arbitrariness (that the pinch technique by itself could not resolve) concerning what pinched corrections to include.

We applied this procedure to two particular cases in the framework of the Minimal Supersymmetric Standard Model where such improvement will be relevant: the mixing of top squarks and of Higgs bosons. From our one-loop calculation of the pinched contributions to the self-energies in the  $R_\xi$  gauge we conclude the following.

For the top squark sector, we advocate a simple self-energy improved by pinching that exactly coincides with the unpinched self-energy evaluated in the Feynman gauge. The prescription for a scale-independent top squark mixing angle that is also gauge-independent is therefore to use either the on-shell [2] or the  $p_*$  scheme [3] with the usual (unpinched) self-energies in the Feynman gauge.

For the Higgs boson sector, the self-energy improved by pinching does not coincide with the unpinched self-energy in the Feynman gauge but contains additional pinched terms. In the on-shell scheme, these new terms modify the counterterm (9) of the mixing angle from the form in the Feynman gauge. In contrast, these new terms vanish in the  $p_*$  scheme and therefore in that scheme the gauge-independent definition of the Higgs boson mixing angle is again obtained from the unpinched self-energies in the Feynman gauge.

**Acknowledgments:** J.R.E. thanks Ignacio Navarro for participating in the early stages of this work, Alberto Casas for a careful reading of the manuscript and Fantina Madricardo for useful correspondence. Y.Y. was supported in part by the Grant-in-aid for Scientific Research from the Ministry of Education, Culture, Sports, Science, and Technology of Japan, No. 14740144.

## References

- [1] H. P. Nilles, Phys. Rept. **110** (1984) 1;  
H. E. Haber and G. L. Kane, Phys. Rept. **117** (1985) 75;  
S. P. Martin, [hep-ph/9709356].
- [2] J. Guasch, J. Solà and W. Hollik, Phys. Lett. B **437** (1998) 88 [hep-ph/9802329];  
H. Eberl, S. Kraml and W. Majerotto, JHEP **9905** (1999) 016 [hep-ph/9903413];  
J. Guasch, W. Hollik and J. Solà, Phys. Lett. B **510** (2001) 211 [hep-ph/0101086].
- [3] J. R. Espinosa and I. Navarro, Phys. Rev. D **66** (2002) 016004 [hep-ph/0109126].
- [4] Y. Yamada, Phys. Rev. D **64** (2001) 036008 [hep-ph/0103046].
- [5] P. Gambino, P. A. Grassi and F. Madricardo, Phys. Lett. B **454** (1999) 98 [hep-ph/9811470];  
B. A. Kniehl, F. Madricardo and M. Steinhauser, Phys. Rev. D **62** (2000) 073010 [hep-ph/0005060];  
A. Barroso, L. Brücher and R. Santos, Phys. Rev. D **62** (2000) 096003 [hep-ph/0004136].
- [6] A. Pilaftsis, Phys. Rev. D **65** (2002) 115013 [hep-ph/0203210].
- [7] J. M. Cornwall, in *Proceedings of the French-American Seminar on Theoretical Aspects of Quantum Chromodynamics*, Marseille, France, 1981, edited by J.W. Dash (Centre de Physique Théorique, Marseille, 1982); Phys. Rev. D **26** (1982) 1453;  
J. M. Cornwall and J. Papavassiliou, Phys. Rev. D **40** (1989) 3474.
- [8] J. Papavassiliou, Phys. Rev. D **41** (1990) 3179;  
G. Degrassi and A. Sirlin, Phys. Rev. D **46** (1992) 3104;  
G. Degrassi, B. A. Kniehl and A. Sirlin, Phys. Rev. D **48** (1993) 3963;  
J. Papavassiliou and A. Pilaftsis, Phys. Rev. Lett. **75** (1995) 3060 [hep-ph/9506417]; Phys. Rev. D **53** (1996) 2128 [hep-ph/9507246]; Phys. Rev. D **54** (1996) 5315 [hep-ph/9605385];  
D. Binosi and J. Papavassiliou, Phys. Rev. D **66** (2002) 025024 [hep-ph/0204128];  
Phys. Rev. D **66** (2002) 076010 [hep-ph/0204308].

- [9] J. Papavassiliou, Phys. Rev. D **50** (1994) 5958 [hep-ph/9406258].
- [10] N. K. Nielsen, Nucl. Phys. B **101** (1975) 173;  
O. Piguet and K. Sibold, Nucl. Phys. B **253** (1985) 517.
- [11] P. Gambino and P. A. Grassi, Phys. Rev. D **62** (2000) 076002. [hep-ph/9907254].
- [12] D. M. Pierce, J. A. Bagger, K. T. Matchev and R.-J. Zhang, Nucl. Phys. B **491** (1997) 3 [hep-ph/9606211].
- [13] G. Degrossi and A. Sirlin, Nucl. Phys. B **383** (1992) 73;  
R. Hempfling and B. A. Kniehl, Phys. Rev. D **51** (1995) 1386, [hep-ph/9408313].
- [14] A. Freitas and D. Stöckinger, Phys. Rev. D **66** (2002) 095014 [hep-ph/0205281].
- [15] J. Papavassiliou and A. Pilaftsis, Phys. Rev. D **58** (1998) 053002 [hep-ph/9710426].
- [16] J. F. Gunion and H. E. Haber, Nucl. Phys. B **272** (1986) 1 [Erratum-ibid. B **402** (1993) 567].
- [17] D. L. Borden, D. A. Bauer and D. O. Caldwell, Phys. Rev. D **48** (1993) 4018;  
J. F. Gunion and H. E. Haber, Phys. Rev. D **48** (1993) 5109.
- [18] V. D. Barger, M. S. Berger, J. F. Gunion and T. Han, Phys. Rev. Lett. **75** (1995) 1462 [hep-ph/9504330]; Phys. Rept. **286** (1997) 1 [hep-ph/9602415]; Phys. Rev. Lett. **78** (1997) 3991 [hep-ph/9612279];  
A. Pilaftsis, Phys. Rev. Lett. **77** (1996) 4996 [hep-ph/9603328].
- [19] M. Okawa, Prog. Theor. Phys. **60** (1978) 1175;  
A. Schilling and P. van Nieuwenhuizen, Phys. Rev. D **50** (1994) 967 [hep-th/9408125].
- [20] P. H. Chankowski, S. Pokorski and J. Rosiek, Phys. Lett. B **274** (1992) 191; Nucl. Phys. B **423** (1994) 437 [hep-ph/9303309].
- [21] S. Hashimoto, J. Kodaira, Y. Yasui and K. Sasaki, Phys. Rev. D **50** (1994) 7066 [hep-ph/9406271].
- [22] A. Denner, G. Weiglein and S. Dittmaier, Phys. Lett. B **333** (1994) 420 [hep-ph/9406204]; Nucl. Phys. B **440** (1995) 95 [hep-ph/9410338].

- [23] B. S. Dewitt, Phys. Rev. **162** (1967) 1195;  
G. 't Hooft, Acta Universitatis Wratislavenensis **368** (1976) 345;  
H. Kluberg-Stern and J. B. Zuber, Phys. Rev. D **12** (1975) 482; Phys. Rev. D **12**  
(1975) 3159;  
L. F. Abbott, Nucl. Phys. B **185** (1981) 189; Acta Phys. Polon. B **13** (1982) 33.