

Market price simulator based on analog electrical circuit

Aki-Hiro Sato^{1*} and Hideki Takayasu²

Department of Applied Mathematics and Physics,
Kyoto University, Kyoto 606-8501, Japan, and

² Sony Computer Science Lab., Takanawa Muse Bldg., 3-14-13,
Higashi-Gotanda, Shinagawa-ku, Tokyo 141-0022, Japan.

October 25, 2018

Abstract

We constructed an analog electrical circuit which generates fluctuations in which probability density function has power law tails. In the circuit fluctuations with an arbitrary exponent of the power law can be obtained by adjusting the resistance. With this low cost circuit the random fluctuations which have the similar statistics to foreign exchange rates can be generated as fast as an expensive digital computer.

Key words. random multiplicative process, power law, foreign currency rate, analog electrical circuit

1 Introduction

Random multiplicative process (RMP) is attracting researchers as a new mechanism of generating fat tails in the distribution of price changes in open markets recently (Takayasu et al. 1997, Jögi et al. 1998, Sato et al. 2000).

*Electronic mail: aki@sawada.riec.tohoku.ac.jp

One of the mechanisms of the fat tails is a feedback mechanism of both positive and negative in a random manner. The positive feedback plays a role of amplification while the negative one plays a role of damping. In the presence of positive feedback one may consider that the system is unstable, however, this is not always correct. When the damping effects dominates the amplification the system can generate statistically stationary fluctuations.

Recently fat tails in the distribution have been confirmed in the market price fluctuation (Mantegna et al. 1995). Among several approaches to this phenomena (Bak et al. 1997, Lux et al. 1999), the authors demonstrated that RMP can be derived from a microscopic artificial dealer's market simulation model (Sato et al. 1998). The RMP has also been derived from a macroscopic theoretical analysis of the critical dynamics of the balance of demand and supply (Takayasu et al. 1999). The multiplicative effect of the market comes from the dealer's forecasting which follows the trend of the latest market price changes, which obviously enhances the fluctuations in price.

In this article we review the analog electrical circuit which generates power law fluctuations based on the RMP theory. The application of this circuit is to generate fluctuation which is statistically similar to market price change in inexpensive way at high speed. The goal of this study is a risk estimator that calculates realizations of market prices directly by parallel processing units and calculates a statistical feature of the fluctuation from these simulated data in the meaning of an ensemble (see. fig. 1.).

The outline of this article is the followings. In sec. 2 we analyze tick data of yen/dollar exchange rates, and show that a probability density function of the market price changes has fat tails of roughly power law. In sec. 3 a random multiplicative process is formalized by a stochastic differential equation with a multiplicative noise. It is indicated that the probability density of a dynamical variable follows a power law distribution. In sec. 4 an example of electrical circuit diagram is shown and an equivalent equation of the proposed circuit is described. In sec. 5 we show the result of observation and we will discuss them. Sec. 6 is devoted to the concluding remarks.

2 Statistical properties of foreign currency rate

Mantegna et al. investigated time series of stock market index of S&P500 and reported in their famous paper (Mantegna et al. 1995) that a probability density function of changes obeys a power law distribution. They indicated that the power law exponent is estimated as 1.4. However, it is clarified that the exponent is not universal by other researches. Besides stock market prices it is known that the probability density function of foreign exchange rates also follows a power law distribution (Takayasu et al. 2000). We analyze tick data of yen/dollar exchange rate of 578,508 data points from January to March 1999. Let us denote the rate of the s th tick as r_s . The change of the rate is defined as $\Delta r_s = r_s - r_{s-1}$. Fig. 2 shows typical examples of time series of yen-dollar exchange rates and corresponding changes. The cumulative distribution function (CDF), which is defined by

$$F(\geq |x|) = \int_{-\infty}^{-|x|} p(x')dx' + \int_{|x|}^{\infty} p(x')dx', \quad (1)$$

is shown in fig. 3. It is clear that the CDF has a liner slope with a quick decay by 1 yen in log-log plots. From the liner slope in log-log plots we can estimated the exponent of the power law distribution,

$$F(\geq |x|) \propto |x|^{-\beta}. \quad (2)$$

The best fit value of β we obtain from the exchange rate is $\beta = 1.8$.

3 Theory

In this section we show a brief outline of a continuous time version of random multiplicative process. The random multiplicative process is given by a stochastic differential equation,

$$\frac{dv}{dt} = \nu(t)v(t) + \xi(t), \quad (3)$$

where $v(t)$ is a dynamic variable and $\nu(t)$ and $\xi(t)$ represent a multiplicative noise and an additive noise, respectively. Denoting an ensemble average by

$\langle \dots \rangle$, we assume the following relations for both multiplicative and additive noises based on the Gaussian white noise theory.

$$\langle \nu(t) \rangle = \bar{\nu}, \quad (4)$$

$$\langle [\nu(t_1) - \bar{\nu}][\nu(t_2) - \bar{\nu}] \rangle = 2D_\nu \delta(t_1 - t_2), \quad (5)$$

$$\langle \xi(t) \rangle = 0, \quad (6)$$

$$\langle \xi(t_1)\xi(t_2) \rangle = 2D_\xi \delta(t_1 - t_2), \quad (7)$$

where $\bar{\nu}$ represents an average of the multiplicative noise, and D_ν and D_ξ represent the strength of the multiplicative noise and that of the additive noise, respectively.

The probability density function of $v(t)$ in eq. (3) is denoted as $p(v, t)$, is known to follow the generalized Fokker-Planck equation (Deutsch 1994, Venkataramani et al. 1996, Nakao 1998).

$$\frac{\partial}{\partial t} p(v, t) = \frac{\partial}{\partial v} \left[-(\bar{\nu} + D_\nu)v p(v, t) + \frac{\partial}{\partial v} (D_\nu v^2 + D_\xi) p(v, t) \right]. \quad (8)$$

By solving eq. (8) for a steady state $\frac{\partial}{\partial t} p(v, t) = 0$ and boundary condition, $\frac{\partial}{\partial v} p(\pm v_u, t) = 0$, we get the stationary distribution.

$$p(v) \propto (D_\xi + D_\nu v^2)^{\frac{\bar{\nu}}{2D_\nu} - \frac{1}{2}}, \quad (9)$$

which has power law tails for large v ,

$$p(v) \propto |v|^{-\beta-1}, \quad (10)$$

where $\beta = -\frac{\bar{\nu}}{D_\nu}$. In other words the power law exponent is given by a simple function of the average and variance of the multiplicative random noise.

4 The Circuit

From the assumption for the multiplicative noise in the RMP theory described in sec. 3, it is important that $\nu(t)$ takes both positive and negative values to realize the power law tails. With an electrical analog circuit this means that it is necessary for the circuit to include both positive and negative feedbacks in the meaning of probability. We solve this problem by using an

analog multiplier. Our block diagram of circuit and an implemented noise generator are shown in fig. 4. v_o in the figure represents an output voltage, and $\mu(t)$ is an output directly from the noise generator. As it is seen from this figure the circuit contains the noise generator, an analog multiplier (Analog devices, 10MHz, 4-quadrant) and an operational amplifier (National Semiconductor, LF157) for integrator (Sato et al. 2000).

The output of the noise generator plays a role of the multiplicative noise in eq. (3). In the noise generator a shot noise of the zener diode in fig. 4 is amplified by an operational amplifier, and it is output from generator through high pass filter. LF157 has the 20M product of a voltage gain (G) and a bandwidth (B). The bandwidth is given by $B=200\text{kHz}$ in the noise generator because we put $G=100$. Thus we expect a frequency characteristics of the noise generator to be up to 200kHz . Let us explain how to realize both positive and negative feedbacks in the meaning of probability. We realize both positive and negative feedbacks by multiplying v_o with the output of the noise generator $\mu(t)$ in the analog multiplier and by connecting the product to the negative input of the operational amplifier for integrator. Although the additive noise term, $\xi(t)$, is not explicitly added in the circuit, it derives from either thermal noises of the operational amplifier or from an external electro-magnetic noises.

An equation equivalent to the circuit diagram of fig. 4 is given as

$$\frac{dv_o}{dt} = \left(\frac{1}{R_f C} + \frac{k}{R_v C} \mu(t) \right) v_o + \xi(t), \quad (11)$$

where k is a factor of the multiplier and $k = 1/10$. $\xi(t)$ represents the additive noise effect. The strength of multiplicative noise $\mu(t)$ depends on the value of a variable resistor R_v in fig. 4 because R_v is a factor of $\mu(t)$ in eq. (11). Therefore, we expect that the power law exponent for the output is a function of R_v .

5 Results of observation and discussion

We measure the output of the circuit v_o for R_v since we expect that the power law exponent β is a function of R_v from the above discussion. We obtained the output through a 12-bit AD converter (Microscience, ADM-652AT) and

processed it as digital data in digital computer. A sampling frequency is 125kHz throughout all the observations.

We show a typical example of time series of v_o at $R_v = 50\Omega$ and 100Ω in fig. 5. The time series at $R_v = 50\Omega$ sometimes exhibits larger fluctuations than $R_v = 100\Omega$. We show log-log plots of CDF of $v(t)$ at $R_v = 25, 50, 75, 100\Omega$ in fig. 6. Log-log plots of the CDF have linear parts for about a decade. We clearly find that the exponent β depends on R_v as expected qualitatively. Moreover as shown in fig. 7 we find a linear relation between β and R_v . The autocorrelation function $R(\tau)$ and the volatility autocorrelation function $R^{(2)}(\tau)$ are defined by

$$R(\tau) = \langle v_o(t + \tau)v_o(t) \rangle - \langle v_o(t + \tau) \rangle \langle v_o(t) \rangle, \quad (12)$$

$$R^{(2)}(\tau) = \langle v_o(t + \tau)^2 v_o(t)^2 \rangle - \langle v_o(t + \tau)^2 \rangle \langle v_o(t)^2 \rangle. \quad (13)$$

We show the autocorrelation function and volatility autocorrelation function in fig. 8. Both autocorrelation function and volatility autocorrelation function have quick decay. It is known that the volatility autocorrelation function of real market price changes has a long time correlation. The disagreement of the volatility autocorrelation occurs because the model equation is too simple to describe time structure of fluctuations. We need to study higher order differential equations with multiplicative noises.

6 Conclusions

We proposed an analog electrical circuit as an analog generator of power law fluctuations. We described a theoretical equation representing the electrical circuit and showed that the probability density function of a dynamical variable has power law tails. We measured the output of the circuit and observed its cumulative distribution functions. The cumulative distribution of output voltage has power law tails. The power law exponent can be tuned by controlling the variable resistance R_v . We expect that the proposed circuit is applicable to generate fluctuations having power law distribution in a much cheaper way than any digital computing methods. Moreover, fluctuations of the circuit may be of use for risk estimation in foreign exchange or stock market in the near future.

Acknowledgment

One of the authors (A.-H. Sato) thanks to Yoshihiro Hayakawa for stimulative discussion. This research is partially supported by Japan Society for the Promotion of Science.

References

- [1] Bak P., Paczuski M. and Shubik M. (1997) Price variations in a stock market with many agents. *Physica A* **246**:430–453.
- [2] Deutsch J.M. (1994) Probability distributions for one component equations with multiplicative noise. *Physica A* **208**:433–444.
- [3] Jögi P., Sornette D. and Blank M. (1998) Fine structure and complex exponents in power-law distribution from random maps. *Phys. Rev. E* **57**:120–134.
- [4] Kuramoto Y. and Nakao H. (1996) Origin of power-law spatial correlations in distributed oscillators and maps with nonlinear coupling. *Phys. Rev. Lett.* **76**:4352–4355.
- [5] Lux T. and Marchesi M. (1999) Scaling and criticality in a stochastic multi-agent model of a financial market. *Nature (London)* **397**:498–500.
- [6] Mantegna R.N. and Stanley H.E. (1995) Scaling behavior in the dynamics of an economics index. *Nature (London)* **376**:46–49.
- [7] Nakao H. (1998) Asymptotic power law of moments in a random multiplicative process with weak additive noise. *Phys. Rev. E* **58**:1591–1601.
- [8] Sato A.-H. and Takayasu H. (1998) Dynamic numerical models of stock market price: from microscopic determinism to macroscopic randomness. *Physica A* **250**:231–252.
- [9] Sato A.-H., Takayasu H. and Sawada Y. (2000) Invariant power law distribution of Langevin systems with colored multiplicative noise. *Phys. Rev. E* **61**:1081–1087.
- [10] Sato A.-H., Takayasu H. and Sawada Y. (2000) Power law fluctuation generator based on analog electrical circuit. *Fractals* **8**:219–225.

- [11] Takayasu H., Sato A.-H. and Takayasu M. (1997) Stable infinite variance fluctuations in randomly amplified Langevin systems. *Phys. Rev. Lett.* **79**:966–969.
- [12] Takayasu H. and Takayasu M. (1999) Critical fluctuations of demand and supply. *Physica A* **269**:24–29.
- [13] Takayasu H., Takayasu M., Okazaki M.P., Marumo K. and Shimizu T. (2000) Fractal properties in economics. In: Novak M. (Ed.) *Paradigms of Complexity*, World Scientific, 243–257.
- [14] Venkataramani S.C., Antonsen Jr. T.M., Ott E. and Sommerer J.C. (1996) On-off intermittency: Power spectrum and fractal properties of time series. *Physica D* **96**:66–99.

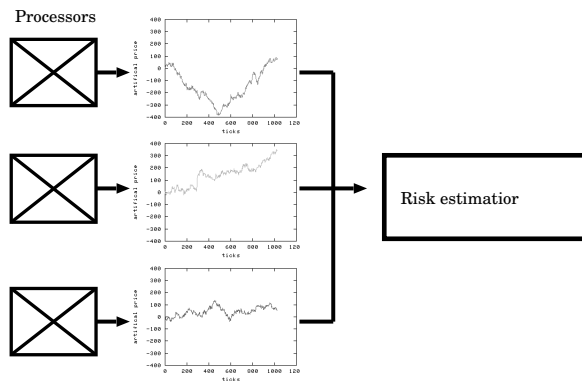

Figure 1: Conceptual illustration of risk estimator that calculates realizations of market prices directly by parallel processing units.

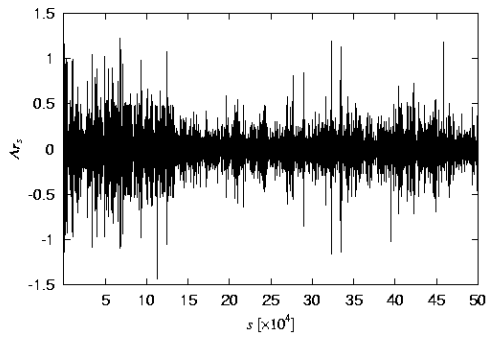
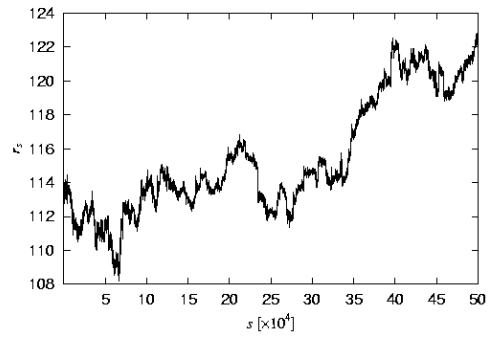

Figure 2: Typical examples of yen/dollar exchange rates (the above) and its changes (the bellow) from January 1999 to March 1999.

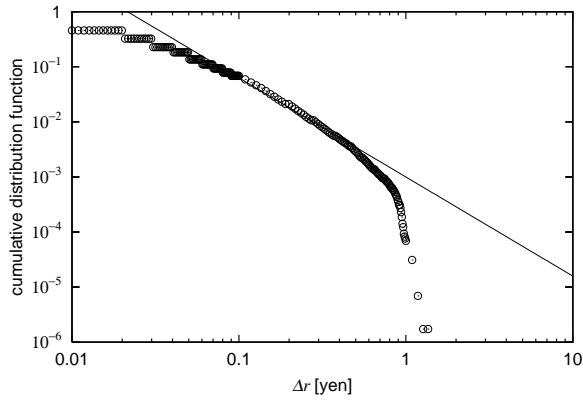

Figure 3: The log-log plots of the cumulative distribution function of yen/dollar exchange rates. A solid line represents the power law with $\beta = 1.8$.

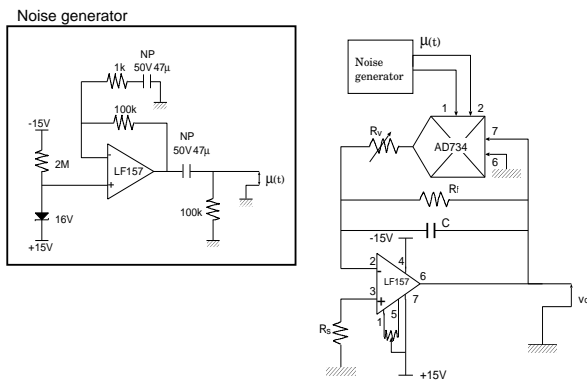

Figure 4: Block diagram of the circuit with a noise generator. The circuit contains a noise generator, an analog multiplier and an operational amplifier for integration. $R_f = 100\text{k}\Omega$, $C = 10\text{pF}$, $R_v = 200\Omega$. A variable resistor under the operational amplifier is for adjustment of the offset.

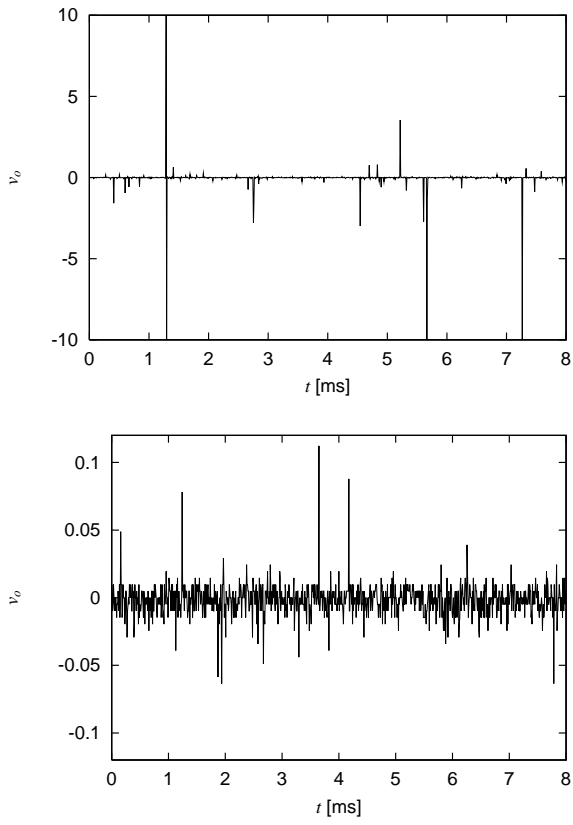

Figure 5: Typical examples of time series at $R_v = 50\Omega$ and 100Ω .

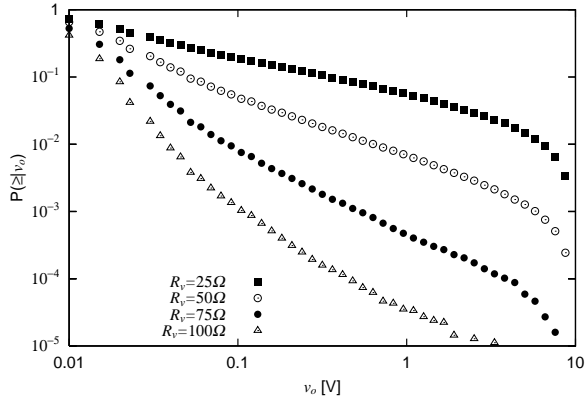

Figure 6: Log-log plots of CDF of the output $v_o(t)$ at $R_v = 25, 50, 75, 100\Omega$. Each CDF shows straight lines with different slopes between a decade.

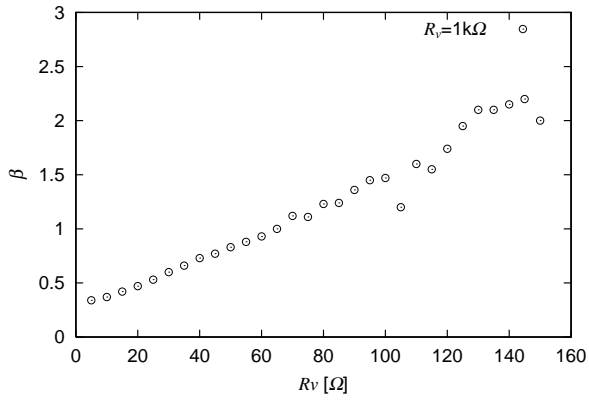

Figure 7: The power law exponent β plotted against values of a variable resistance R_v . The power law exponent β is numerically estimated from a slope of a liner part in log-log plots of CDF.

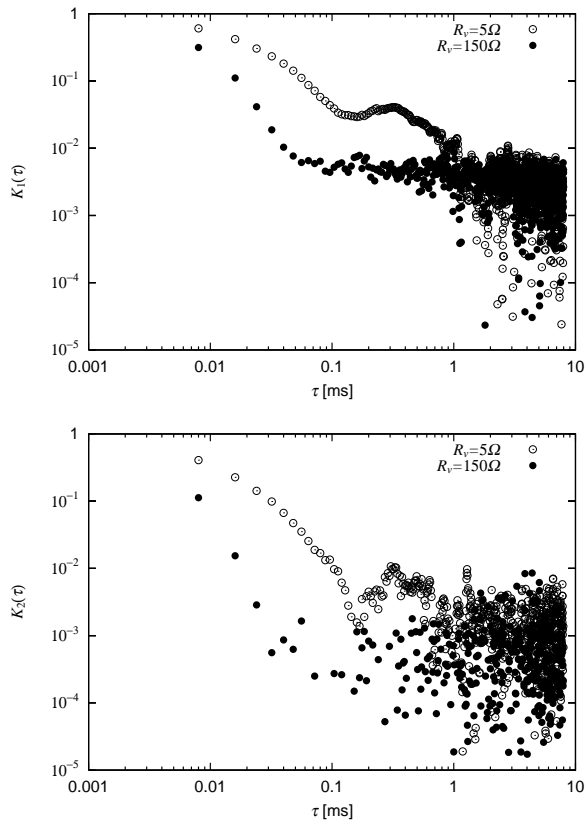

Figure 8: Autocorrelation function and volatility autocorrelation function of output $v_o(t)$.