

Random Variables, Conditional Independence and Categories of Abstract Sample Spaces

Dario Stein

iHub, Radboud Universiteit Nijmegen

Nijmegen, The Netherlands

ORCID 0009-0002-1445-4508

Abstract—Two high-level “pictures” of probability theory have emerged: one that takes as central the notion of random variable, and one that focuses on distributions and probability channels (Markov kernels). While the channel-based picture has been successfully axiomatized, and widely generalized, using the notion of Markov category, the categorical semantics of the random variable picture remain less clear. Simpson’s probability sheaves are a recent approach, in which probabilistic concepts like random variables are allowed vary over a site of sample spaces. Simpson has identified rich structure on these sites, most notably an abstract notion of conditional independence, and given examples ranging from probability over databases to nominal sets.

We aim bring this development together with the generality and abstraction of Markov categories: We show that for any suitable Markov category, a category of sample spaces can be defined which satisfies Simpson’s axioms, and that a theory of probability sheaves can be developed purely synthetically in this setting. We recover Simpson’s examples in a uniform fashion from well-known Markov categories, and consider further generalizations.

Index Terms—conditional independence, category theory, probability theory, nominal sets, separation logic

I. INTRODUCTION

Two pictures (or formalisms) of stochastic computation have emerged: The classical treatment (e.g. [14]) focuses on the notion of *random variable*. Traditionally, one considers a *sample space* (Ω, \mathcal{E}, P) consisting of a measurable space (Ω, Σ) and a probability measure $P : \mathcal{E} \rightarrow [0, 1]$. A random variable is then a measurable function $\Omega \rightarrow V$ into a space of interest (typically \mathbb{R}).

Another picture, prominent in theoretical computer science and physics, has taken the notion of *probability channel* or *Markov kernel* $\kappa : (X, \mathcal{E}) \rightsquigarrow (Y, \mathcal{F})$ between measurable spaces as primitive. This is a parameterized probability distribution, associating to every $x \in X$ a probability measure $\kappa(x, -)$ on Y in a measurable way. A channel between finite discrete spaces can be described as a stochastic matrix (a.k.a. conditional probability table). In this picture, it is studied how distributions and channels compose and decompose without postulating random variables. Distributions are a special case of channels with trivial input $X = 1$.

The two pictures have different strengths and weaknesses as they emphasize different notions. Equality in distribution and conditional distributions is natural to express using channels, while equality almost surely or conditional expectation are more naturally phrased using random variables.

The channel-based picture is very amenable to the language of category theory. Recent efforts in categorical probability have succeeded in re-phrasing various probabilistic concepts in a categorical form (e.g. [1], [6], [9]–[12], [23]). Notably, the abstract notion of *Markov categories* [7] has encapsulated important aspects of channel-based probability and opened them up to substantial generalizations. There are a wide variety of Markov categories capturing different structural models of channel-based probability, such as Gaussian probability, nondeterminism or fresh name generation. Channel-based probability also has close ties to the denotational semantics of probabilistic programs (e.g. [29], [30]).

How to recover the random-variable picture from the channel-based one is less clear: One difficulty, noted by Tao [32], is that the formal status sample space Ω is somewhat ephemeral. Often, this sample space is extended on-the-fly, and the (implicit) promise is that all meaningful constructions remain invariant under these extensions. Alex Simpson has proposed to model random variables using *probability sheaves* over categories \mathbb{S} in which the sample space varies [26], [28]. This is similar to fresh name generation and various forms of generativity in computer science, which use sheaves over ‘many worlds’ to capture information available at different stages (the classical example is the Schanuel topos [24]). These sheaf-theoretic constructions guarantee equivariance, that is everything is consistent with respect to extension of sample spaces.

Simpson’s work has identified rich structure on these categories \mathbb{S} of sample spaces. Crucially, they carry atomic topologies [28] and admit an axiomatic notion of conditional independence [27] called *independent pullbacks*. He has given an array of example categories satisfying his assumptions, for example **FinProb** (discrete probability), **Prob** (Borel probability), **FinSurj** (nondeterminism). It makes sense to think of these categories as *abstract categories of sample spaces*.

The goal of this work is to connect Simpson’s analysis with the Markov-categorical picture. We define, for any suitable Markov category \mathbb{C} , a category of sample spaces $\mathbb{S}(\mathbb{C})$ and show that a theory of conditional independence and probability sheaves can be developed purely synthetically on these categories. Concretely,

- 1) we recall probability spaces $\mathbb{P}(\mathbb{C})$ and sample spaces $\mathbb{S}(\mathbb{C})$ in Section II

- 2) we define the independent pullback structure on $\mathbb{S}(\mathbb{C})$, and prove that it satisfy the axioms of [28] (Section IV)
- 3) we recover Simpson’s example categories as instances of our construction for the well-known Markov categories $\mathbb{C} = \mathbf{FinStoch}, \mathbf{BorelStoch}, \mathbf{FinSetMulti}$ (Section III). While Simpson used a mix of abstract and model-specific arguments, our proofs rely solely on synthetic proofs and notions involving the category \mathbb{C}
- 4) we obtain new examples of sample spaces by analyzing Markov categories such as **Gauss** (Gaussian probability) and **StrongName** (fresh name generation). Their categories of sample spaces turn out to be well-known and interesting: they are equivalent to **CoIso** (Euclidean co-isometries) and \mathbf{Inj}^{op} (opposite of finite sets and injections)
- 5) we begin developing the theory probability sheaves abstractly over our category of sample spaces $\mathbb{S}(\mathbb{C})$ in Section V. This development generalizes the construction of the Schanuel topos for fresh name generation [24]. The relation between nominal techniques and stochastic independence has recently been of interest in probabilistic separation logics [18].

a) Probability spaces: A probability space is the same object (Ω, \mathcal{E}, P) as a sample space, but the notion of morphism between them is different: A morphism of probability spaces is known as a *coupling*, sometimes also *kernel* or *joint distribution* [3], [16]. Probability spaces are of course a ubiquitous notion in all of probability theory and functional analysis, but recently abstract properties of categories of probability spaces have been highlighted and used to great effect [6], [21], [23].

Bayesian inversion [1], one could argue, is the most fundamental operation of machine learning, as it expresses the updating of our state of knowledge given a new observation. Probability spaces are a natural setting to study this operation, as Bayesian inversion forms a *dagger functor* on this category, i.e. a contravariant involution.

Probability spaces $\mathbb{P}(\mathbb{C})$ have been defined abstractly for Markov categories \mathbb{C} [7]. As sample spaces form a subcategory $\mathbb{S}(\mathbb{C}) \subseteq \mathbb{P}(\mathbb{C})$, our work develops the theory of both categories in tandem. There is some interesting interplay between morphisms of probability spaces (couplings) and of sample spaces (extensions), which is absent in earlier work of Simpson.

b) Conditional independence: Conditional independence is a crucial assumption for statistical modelling, and for reasoning about and optimizing probabilistic programs [17]. There are various interrelated axiomatizations of conditional independence, most prominently semigraphoids [22], but also conditional products [5] or the independence structures considered by Simpson [27]. From a more generalized point of view, independence relations are pervasive to many contexts: stochastic independence, logical independence, and separation (freshness, separation logic). As was the case in [27], all these aspects are modelled by our various examples.

II. CATEGORIES OF ABSTRACT SAMPLE SPACES

In this section, we recall the notion of *Markov category*, which is a general framework for nondeterministic processes, such as probability, nondeterminism or fresh name generation. We then recall the derived notions of *probability space* and *sample space* over a suitable Markov category \mathbb{C} , which are our central objects of study. We recall abstract categorical characterizations of *conditionals* and *almost-sure equality* as auxiliary notions. Readers familiar with these notions may wish to skip to section III which discusses and recovers Simpson’s examples.

A. Recap: Markov Categories

Markov categories capture some fundamental aspects of probabilistic computations: They can be composed in sequence (categorical composition \circ), in parallel (monoidal composition \otimes), and information can be copied and discarded by means of distinguished maps $\text{copy}_X : X \rightarrow X \otimes X$ and $\text{del}_X : X \rightarrow I$. The copy maps are *not* natural, which allows for differentiating between correlation (copying) and independence (re-computing). As is standard, we will use string diagrams [25] alongside ordinary categorical composition to manipulate complex composites in a visually appealing form. Unless otherwise indicated, the material in this background section stems from [7].

Definition 1. A *Markov category* is a *semicartesian symmetric monoidal category* (\mathbb{C}, \otimes, I) where each object is equipped with the structure of a *commutative comonoid* $(X, \text{copy}_X, \text{del}_X)$ compatible with the monoidal structures (see Figure 1 for the full axioms). We render (iterated) copy and delete as follows

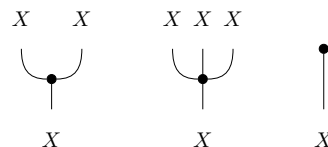

Note that terminality of I implies that deletion is natural.

The prototypical examples of Markov categories come from probability theory; the formalism encompasses various “flavors”, such as discrete, topologically continuous, measure-theoretic probability.

Example 1 (Discrete probability). *The Markov category **FinStoch** has as objects finite sets X , and as morphisms stochastic matrices $p \in \mathbb{R}^{Y \times X}$, meaning $p(y|x) \geq 0$ and*

$$\forall x \in X, \sum_y p(y|x) = 1$$

Composition is matrix multiplication.

Example 2 (Borel probability). *The category **BorelStoch** has as objects standard Borel spaces (X, Σ_X) , and morphisms are Markov kernels, i.e. maps $\kappa : X \times \Sigma_Y \rightarrow [0, 1]$ such that $\kappa(x, A)$ is measurable in $x \in X$ and a probability measure in $A \in \Sigma_Y$. Composition is integration*

$$(\kappa \circ \tau)(x, A) = \int \kappa(y, A) \tau(x, dy)$$

Certain subcategories of **BorelStoch** admit a simple description without measure theory. A notable case is *Gaussian probability*, which is the study of affine-linear maps with Gaussian (multivariate normal) noise.

Example 3 (Gaussian probability). *The category **Gauss** has as objects the spaces \mathbb{R}^n , and morphisms $\mathbb{R}^m \rightarrow \mathbb{R}^n$ are triples (A, b, Σ) where $A \in \mathbb{R}^{m \times n}$, $b \in \mathbb{R}^n$ and $\Sigma \in \mathbb{R}^{n \times n}$ is positive semidefinite (written $\Sigma \succcurlyeq 0$). The triple represents the probability kernel informally written $f(x) = Ax + \mathcal{N}(b, \Sigma)$. Composition is given by the rule*

$$(A, b, \Sigma) \circ (C, d, \Xi) = (AC, b + Ad, \Sigma + A\Xi A^T)$$

Now for non-probabilistic examples:

Example 4 (Nondeterminism). *The category **FinSetMulti** has as objects finite sets X , and morphisms $X \rightarrow Y$ are left-total relations $R \subseteq X \times Y$, meaning $\forall x \exists y, (x, y) \in R$. Composition is relation composition.*

We can view morphisms in **FinSetMulti** as computations which may choose between one or more possible outputs nondeterministically. Another example due to [30] formalizes fresh name generation as a Markov category.

Example 5 (Fresh name generation). *The category **StrongName** has as objects strong nominal sets X , and morphisms $X \rightarrow Y$ are maps which may potentially generate fresh names. We present this category in more detail in the appendix (Section VIII-B).*

As noted in [7, Example 3], the Kleisli category of a commutative and affine monad will have the structure of a Markov category. Our previous examples arise from monads, namely the distribution monad D , Giry monad \mathcal{G} , nonempty powerset \mathcal{P}^+ , and the name-generation monad (free restriction set) N . **Gauss** does not seem to be associated to any monad.

B. Probabilistic Notions in Markov categories

Let \mathbb{C} be a Markov category. We call morphisms $p : I \rightarrow X$ states. We use the abbreviation $\langle f, g \rangle = (f \otimes g) \circ \text{copy}$ for pairing of morphisms. The deletion maps induces canonical projections $X \xleftarrow{\pi_X} X \otimes Y \xrightarrow{\pi_Y} Y$. A morphism $f : X \rightarrow Y$ is called *deterministic* [7, Definition 10.1] if it commutes with copying

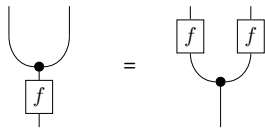

A Markov category \mathbb{C} has *conditionals* [7, Definition 11.5] if for every $f : A \rightarrow X \otimes Y$ there exists a factorization of the form

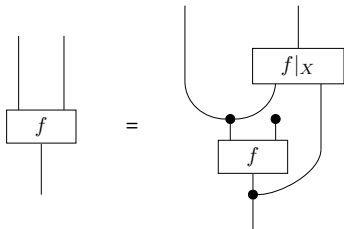

A special case of conditionals is the *Bayesian inverse*: For every $f : X \rightarrow Y$ and $p : I \rightarrow X$, there exists $f_p^\dagger : Y \rightarrow X$ such that

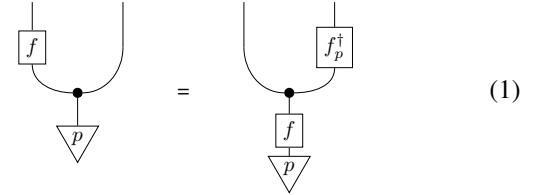

All running examples have conditionals (see [7], the case for **StrongName** is in the appendix). For **BorelStoch**, conditionals correspond precisely to *regular conditional probabilities*.

We will now relativize Markov-categorical notions with respect to a state $p : I \rightarrow X$: Two morphisms $f, g : X \rightarrow Y$ are called *p-almost surely equal*, written $f =_p g$, if we have the following equality of states

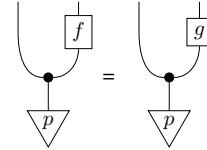

This definition captures the usual mathematical meaning of almost sure equality in our examples. For example in **FinStoch**, we have $f =_p g$ if $f(y|x) = g(y|x)$ for all x, y with $p(x) > 0$. A morphism $f : X \rightarrow Y$ is called *p-almost surely deterministic* if

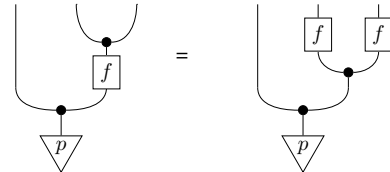

In a Markov category with conditionals, several important *proof principles* are derivable [8]:

- 1) every isomorphism is deterministic
- 2) *positivity*¹: this expresses that deterministic variables are independent of everything. if $f : A \rightarrow X \otimes Y$ has a deterministic marginal (e.g. $\pi_1 \circ f$ is deterministic) then f is the product of its marginals $f = \langle \pi_1 \circ f, \pi_2 \circ f \rangle$
- 3) *relative positivity*: if $f : A \rightarrow X \otimes Y$ has a p -almost surely deterministic marginal, then $f =_p \langle \pi_X \circ f, \pi_2 \circ f \rangle$

C. Probability Spaces, Couplings, Sample Spaces

Let \mathbb{C} be a Markov category with conditionals.

Definition 2 (Probability spaces). *We define the category $\mathbb{P}(\mathbb{C})$ of probability spaces as follows*

- 1) A probability space in \mathbb{C} is a pair $\Omega = (\Omega, p)$ of an object Ω and a state $p : I \rightarrow \Omega$
- 2) A morphism of probability spaces $(\Omega, p) \rightarrow (\Omega', q)$ is an equivalence class $[f]_p$ of morphisms $f : \Omega \rightarrow \Omega'$, up

¹the name is due to the fact that this property fails if negative probabilities were allowed

to p -almost sure equality, which preserve the state, i.e. $f \circ p = q$.

- 3) *Composition is composition in \mathbb{C} on representatives, which is well-defined because $[f]_{gp} \circ [g]_p = [f \circ g]_p$.*

In abstract terms, almost sure equality defines a congruence relation on the slice category I/\mathbb{C} , and $\mathbb{P}(\mathbb{C})$ the quotient under this congruence. By slight abuse of notation, we will simply write f instead of $[f]$. The construction $\mathbb{P}(\mathbb{C})$ is known under the names **ProbStoch**(\mathbb{C}), **PS**, or \mathcal{S} in [6], [7], [21].

Central to our development is the category of *sample spaces* $\mathbb{S}(\mathbb{C})$. It has the same objects as $\mathbb{P}(\mathbb{C})$, but the morphisms are restricted to be almost surely deterministic.

Definition 3 (Sample spaces). *The category of sample spaces is defined as the wide subcategory $\mathbb{S}(\mathbb{C}) \subseteq \mathbb{P}(\mathbb{C})$ consisting of the morphisms $f : (\Omega, p) \rightarrow (\Omega', q)$ which are p -almost surely deterministic.*

For brevity, we will refer to morphisms of sample spaces as *deterministic* (the state p can be read off from the domain). We will also refer to those morphisms as *maps* of sample spaces, as opposed to *channels* which may be nondeterministic (i.e. lie in $\mathbb{P}(\mathbb{C})$). We recall some structure of the categories $\mathbb{P}(\mathbb{C})$ and $\mathbb{S}(\mathbb{C})$.

Proposition 1 ([7, Section 13]). *The category $\mathbb{P}(\mathbb{C})$ is semicartesian monoidal with $(X, p) \otimes (Y, q) = (X \otimes Y, p \otimes q)$. Bayesian inversion $f \mapsto f^\dagger$ is a contravariant involutive functor on $\mathbb{P}(\mathbb{C})$ making it a dagger category (e.g. [15])*

In particular, the chain rule for Bayesian inversion

$$(g \circ f)_p^\dagger = g_{fp}^\dagger \circ f_p^\dagger$$

simplifies to mere contravariance $(g \circ f)^\dagger = f^\dagger \circ g^\dagger$ when formulated in the category $\mathbb{P}(\mathbb{C})$. We recall some terminology in dagger categories: A morphism $f : X \rightarrow Y$ is called

- an *isometry* if $f^\dagger \circ f = \text{id}_X$
- a *co-isometry* if $f \circ f^\dagger = \text{id}_Y$
- *unitary* if it is both isometry and co-isometry (it is an isomorphism with $f^{-1} = f^\dagger$).

An equivalence of dagger categories (dagger equivalence) consists of dagger-preserving functors and natural isomorphisms $FG \cong 1$, $GF \cong 1$ with unitary components [15].

It is well-known that $\mathbb{P}(\mathbb{C})$ is dagger equivalent to the category of *couplings* (sometimes *kernels*, *joint distributions*) where morphisms $(X, p) \rightarrow (Y, q)$ are states $\gamma : I \rightarrow X \otimes Y$ with $\pi_1 \circ \gamma = p$ and $\pi_2 \circ \gamma = q$ [7, Remark 12.10]. The dagger on couplings is given by composing with the swap isomorphism $\gamma \mapsto \sigma_{X,Y} \circ \gamma$.

Proposition 2. *The following are equivalent for a morphism f in $\mathbb{P}(\mathbb{C})$*

- 1) f is deterministic
- 2) f is a co-isometry, i.e. satisfies $f \circ f^\dagger = \text{id}$
- 3) f is split epic

Furthermore, if $f \circ g$ is deterministic, so is f .

Proof. The equivalence of the first two statements is [6, Proposition 2.5], and co-isometries are split epic. The statement $f \circ g$ deterministic $\Rightarrow f$ deterministic is precisely [7, Remark 13.17]. In particular, if f is split epic then $f \circ g = \text{id}$ is deterministic, so f is deterministic. \square

It follows that $\mathbb{S}(\mathbb{C})$ can be identified as the subcategory of co-isometries of $\mathbb{P}(\mathbb{C})$. By the last point, every isomorphism in $\mathbb{P}(\mathbb{C})$ is unitary and deterministic, hence lies in $\mathbb{S}(\mathbb{C})$: That means if two probability spaces are isomorphic, they are also isomorphic as *sample spaces*.

Proposition 3. *The category $\mathbb{S}(\mathbb{C})$ is semicartesian monoidal. Every morphism is epic. The canonical projections*

$$\mathbf{X} \leftarrow \mathbf{X} \otimes \mathbf{Y} \rightarrow \mathbf{Y}$$

are jointly monic.

Example 6. *The projection map $\pi_1 : (X \otimes Y, p) \rightarrow (X, p_1)$ serves as our prototypical intuition for a map of sample spaces. We can think of it as describing a consistent extension of the sample space (X, p_1) to a larger sample space (this perspective is important in Section V).*

In contrast to Proposition 3, the canonical projections are generally *not* jointly monic in $\mathbb{P}(\mathbb{C})$. This can however be remedied for channels that have a deterministic marginal:

Lemma 1. *In a diagram in $\mathbb{P}(\mathbb{C})$,*

$$\begin{array}{ccccc} & & \Omega & & \\ & \swarrow g & \Downarrow \phi, \psi & \searrow f & \\ \mathbf{Y} & \xleftarrow{\pi_2} & \mathbf{X} \otimes \mathbf{Y} & \xrightarrow{\pi_1} & \mathbf{X} \end{array}$$

if either f or g is deterministic, then $\phi = \psi$.

Proof. This is an application of relative positivity. The maps ϕ has a deterministic marginal f , hence it is almost surely equal to the tupling of its marginals, i.e. $\phi =_{\Omega} \langle f, g \rangle$. The same is true for ψ , $\phi =_{\Omega} \psi$. \square

III. EXAMPLES

We will now recover concrete descriptions of the categories $\mathbb{P}(\mathbb{C})$ and $\mathbb{S}(\mathbb{C})$ for our example Markov categories, up to equivalence of (dagger) categories. An important aid is Proposition 4, which enables us to drop almost sure equivalence classes in many cases.

Definition 4. *We call a probability space (Ω, p) faithful if for all $f, g : \Omega \rightarrow X$, $f =_p g$ implies $f = g$.*

We consider the full subcategories $\mathbb{P}_f(\mathbb{C})$ and $\mathbb{S}_f(\mathbb{C})$ whose objects are faithful probability spaces. Those are considerably easier to work with, as we no longer need to take equivalence classes of morphisms, and almost sure determinism coincides with plain determinism.

Proposition 4. *The following are equivalent*

- 1) every probability space is isomorphic to a faithful one

- 2) the inclusions $\mathbb{P}_f(\mathbb{C}) \rightarrow \mathbb{P}(\mathbb{C})$ and $\mathbb{S}_f(\mathbb{C}) \rightarrow \mathbb{S}(\mathbb{C})$ are part of an equivalence of (dagger) categories
- 3) every state $p : I \rightarrow X$ has a split support in the sense of [9], [30], i.e. there are morphisms $i : S \rightarrow X$, $\pi : X \rightarrow S$ such that
 - $\pi i = \text{id}_S$
 - $i\pi = {}_p \text{id}_X$
 - for all $f, g : X \rightarrow Y$, $f = {}_p g \Leftrightarrow fi = gi$

Proof. The first two points are equivalent by the usual characterization of equivalence of categories by means of an essentially surjective, full and faithful functor. For an equivalence of dagger categories, certain isomorphisms need to be unitary, but this is automatic in our setting (Proposition 2). It remains to show the equivalence of the first and third point. Take a probability space (X, p) and choose an isomorphism

$$(X, p) \xrightleftharpoons[i]{\pi} (S, \sigma) \quad (2)$$

with a faithful (S, σ) . We claim that this is a split support.

- we have $\pi i = {}_\sigma \text{id}_S$ because π, i are inverses, but σ is faithful, so $\pi i = \text{id}_S$
- we have $i\pi = {}_p \text{id}_X$ because π, i are inverses
- assume $fi = gi$, then $f = {}_p g$ because

$$f = f \circ \text{id}_X = {}_p fi\pi = gi\pi = {}_p g \circ \text{id}_X = g$$

- conversely if $f = {}_p g$, then by precomposition $fi = {}_\sigma gi$ so $fi = gi$ by faithfulness of σ

Conversely, if p has a split support, then (2) is an isomorphism for $\sigma = \pi p$. It remains to argue why σ is faithful: For any $f, g : S \rightarrow Y$ with $f = {}_\sigma g$, we have $f\pi = {}_p g\pi$ by precomposition. By assumption on the support this implies $f\pi i = g\pi i$, but $\pi i = \text{id}_S$ so $f = g$. \square

The ‘support-inclusion’ $i : S \rightarrow X$ identifies the support of the distribution p , in the sense that p -almost sure equality can be tested by pulling back along i . A probability space is faithful if its distribution is supported on all of X .

All our example categories except **BorelStoch** are known to have split supports of states [9]; in those cases, it suffices to study faithful probability spaces:

Proposition 5 (Discrete probability).

- 1) A probability space (Ω, p) in **FinStoch** is faithful iff $p(\omega) > 0$ for all $\omega \in \Omega$
- 2) The category $\mathbb{P}(\mathbf{FinStoch})$ is dagger equivalent to the category which has as objects faithful probability spaces (Ω, p) , and morphisms are stochastic matrices preserving the state. This was known as $\mathcal{S}^+(\mathbf{FinStoch})$ in [20].
- 3) The category $\mathbb{S}(\mathbf{FinStoch})$ is equivalent to **FinProb** of [27]: objects are faithful probability spaces, and morphisms $(\Omega, p) \rightarrow (\Omega', q)$ are surjective functions $f : \Omega \rightarrow \Omega'$ with

$$q(\omega') = \sum_{\omega \in f^{-1}(\omega')} p(\omega)$$

Proposition 6 (Gaussian probability).

- 1) A sample space $(\mathbb{R}^n, \mathcal{N}(\mu, \Sigma))$ in **Gauss** is faithful iff Σ has full rank, i.e. is positive definite. Every such sample space is isomorphic to a standard sample space of the form $(\mathbb{R}^n, \mathcal{N}(0, I_n))$ by means of Cholesky decomposition.
- 2) The category $\mathbb{S}(\mathbf{Gauss})$ is equivalent to the category **CoIso** of Euclidean co-isometries, where
 - objects are natural numbers $n \in \mathbb{N}$
 - morphisms $m \rightarrow n$ are matrices $A \in \mathbb{R}^{n \times m}$ with $AA^T = I_n$.
- 3) The category $\mathbb{P}(\mathbf{Gauss})$ is dagger equivalent to the following category
 - objects are natural numbers $n \in \mathbb{N}$
 - morphisms $m \rightarrow n$ are matrices $A \in \mathbb{R}^{n \times m}$ with $1_n - AA^T \succ 0$
 - The dagger is transposition $A \mapsto A^T$

Proof. Elaborated in Section VIII-A. \square

Proposition 7 (Nondeterminism).

- 1) A sample space (X, R) with $\emptyset \neq R \subseteq X$ in **FinSetMulti** is faithful iff $R = X$.
- 2) The category $\mathbb{P}(\mathbf{FinSetMulti})$ is dagger equivalent to the category **TotRel** of finite sets and total relations. Dagger is the relational converse.
- 3) The category $\mathbb{S}(\mathbf{FinSetMulti})$ is equivalent to **FinSur** (see [27]) of finite sets and surjective functions.

Proposition 8 (Fresh name generation).

- 1) A sample space (X, W) in **StrongName** consists of a strong nominal set X and an orbit $W \subseteq X$. The sample space is faithful iff $W = X$
- 2) Each sample space is isomorphic to one of the form $(\mathbb{A}^{*n}, \mathbb{A}^{*n})$ for $n \in \mathbb{N}$
- 3) The category $\mathbb{S}(\mathbf{StrongName})$ is equivalent to **FinInj^{op}**, the opposite category of finite sets and injections.

Proof. Elaborated in Section VIII-B. \square

We remark that in **BorelStoch**, not every sample space is isomorphic to a faithful one, so we don’t obtain a simplified description via Proposition 4. We simply work with the definition of $\mathbb{S}(\mathbf{BorelStoch})$ as-is.

IV. THE INDEPENDENCE STRUCTURE ON SAMPLE SPACES

Now that we have introduced and characterized categories of sample spaces $\mathbb{S}(\mathbb{C})$, we can study notions of conditional independence on them. We will recall Simpson’s axioms for independent pullbacks, show that they apply to our categories $\mathbb{S}(\mathbb{C})$, and recover the independence structures given in the examples in [27]. The independence structure will play a crucial role when using $\mathbb{S}(\mathbb{C})$ as a site for probability sheaves in V.

Consider a category \mathbb{S} equipped with a distinguished collection of commutative squares that are called “independent”. A commuting square

$$\begin{array}{ccc} X & \xrightarrow{f} & Y \\ g \downarrow & & \downarrow u \\ Z & \xrightarrow{v} & W \end{array}$$

is called an *independent pullback* if it is independent, and it satisfies the universal property of a pullback with respect to other independent squares, i.e. whenever the outer kite is independent, there exists a unique mediating map

$$\begin{array}{ccc} X' & \xrightarrow{f'} & Y \\ \exists! \downarrow & \swarrow & \downarrow u \\ X & \xrightarrow{f} & Y \\ g \downarrow & & \downarrow u \\ Z & \xrightarrow{v} & W \end{array}$$

Definition 5 ([28]). A system of independent pullbacks on a category \mathbb{S} is a collection of commuting squares called *independent*, satisfying the following axioms

(IP1) every square of the following form is independent

$$\begin{array}{ccc} X & \longrightarrow & Y \\ \downarrow & & \downarrow \\ Z & \xrightarrow{\text{id}_Z} & Z \end{array}$$

(IP2) if the left square is independent, so is the right

$$\begin{array}{ccc} X & \xrightarrow{f} & Y \\ g \downarrow & & \downarrow v \\ Z & \xrightarrow{u} & W \end{array} \quad \begin{array}{ccc} X & \xrightarrow{g} & Z \\ f \downarrow & & \downarrow u \\ Y & \xrightarrow{v} & W \end{array}$$

(IP3) if (A) and (B) are independent, then so is (AB)

$$\begin{array}{ccc} \bullet & \longrightarrow & \bullet \\ \downarrow & & \downarrow \\ \bullet & \longrightarrow & \bullet \\ \downarrow & & \downarrow \\ \bullet & \longrightarrow & \bullet \end{array} \quad \begin{array}{ccc} \bullet & \longrightarrow & \bullet \\ \downarrow & & \downarrow \\ \bullet & \longrightarrow & \bullet \\ \downarrow & & \downarrow \\ \bullet & \longrightarrow & \bullet \end{array}$$

(IP4) If (AB) is independent and (B) is an independent pullback, then (A) is independent

(IP5) Every cospan $Y \xrightarrow{u} W \xleftarrow{v} Z$ has a completion to an independent pullback

Definition 6. We call a commutative square in $\mathbb{S}(\mathbb{C})$

$$\begin{array}{ccc} \Omega & \xrightarrow{f} & \mathbf{X} \\ g \downarrow & \searrow d & \downarrow u \\ \mathbf{Y} & \xrightarrow{v} & \mathbf{Z} \end{array}$$

(3)

independent if the maps f, g are conditionally independent given d in the sense of [7, 12.1], written $f \perp g | d$. That means there exist channels $\phi : Z \rightarrow X$ and $\psi : Z \rightarrow Y$ in \mathbb{C} such that

$$\begin{array}{c} \begin{array}{ccc} \downarrow & \downarrow & \downarrow \\ \boxed{f} & \boxed{d} & \boxed{g} \\ \downarrow & \downarrow & \downarrow \\ \bullet & & \bullet \\ \downarrow & & \downarrow \\ \Omega & & \Omega \end{array} \\ = \\ \begin{array}{ccc} \downarrow & & \downarrow \\ \boxed{\phi} & & \boxed{\psi} \\ \downarrow & & \downarrow \\ \bullet & & \bullet \\ \downarrow & & \downarrow \\ \Omega & & \Omega \end{array} \end{array} \quad (4)$$

We can simplify this condition considerably using the following characterization.

Lemma 2. For any commutative square as in (3), the following composites (I)-(VI) are equal

$$\begin{array}{ccc} \text{(I)} & \text{(II)} & \text{(III)} \\ \begin{array}{ccc} \downarrow & \downarrow & \downarrow \\ \boxed{u^\dagger} & \boxed{v^\dagger} & \downarrow \\ \downarrow & \downarrow & \downarrow \\ \bullet & & \bullet \\ \downarrow & & \downarrow \\ \Omega & & \Omega \end{array} & = & \begin{array}{ccc} \downarrow & \downarrow & \downarrow \\ \boxed{f} & \boxed{g} & \downarrow \\ \downarrow & \downarrow & \downarrow \\ \boxed{d^\dagger} & \boxed{d^\dagger} & \bullet \\ \downarrow & \downarrow & \downarrow \\ \bullet & & \bullet \\ \downarrow & & \downarrow \\ \Omega & & \Omega \end{array} & = & \begin{array}{ccc} \downarrow & & \downarrow \\ & & \boxed{v^\dagger} \\ \downarrow & & \downarrow \\ \bullet & & \bullet \\ \downarrow & & \downarrow \\ \Omega & & \Omega \end{array} \\ \\ \text{(IV)} & \text{(V)} & \text{(VI)} \\ \begin{array}{ccc} \downarrow & \downarrow & \downarrow \\ \boxed{u^\dagger} & \downarrow & \downarrow \\ \downarrow & \downarrow & \downarrow \\ \boxed{v} & \downarrow & \bullet \\ \downarrow & \downarrow & \downarrow \\ \bullet & & \bullet \\ \downarrow & & \downarrow \\ \Omega & & \Omega \end{array} & = & \begin{array}{ccc} \downarrow & \downarrow & \downarrow \\ \downarrow & \downarrow & \downarrow \\ \boxed{f} & \boxed{v^\dagger} & \downarrow \\ \downarrow & \downarrow & \downarrow \\ \bullet & & \bullet \\ \downarrow & & \downarrow \\ \Omega & & \Omega \end{array} & = & \begin{array}{ccc} \downarrow & \downarrow & \downarrow \\ \downarrow & \downarrow & \downarrow \\ \boxed{f} & \boxed{v^\dagger} & \downarrow \\ \downarrow & \downarrow & \downarrow \\ \boxed{f} & \boxed{v} & \downarrow \\ \downarrow & \downarrow & \downarrow \\ \boxed{f} & \boxed{g} & \bullet \\ \downarrow & \downarrow & \downarrow \\ \bullet & & \bullet \\ \downarrow & & \downarrow \\ \Omega & & \Omega \end{array} \end{array}$$

for arbitrary choices of Bayesian inverses. Furthermore, the square (3) is independent if and only if the joint state

$$\begin{array}{ccc} \downarrow & \downarrow \\ \boxed{f} & \boxed{g} \\ \downarrow & \downarrow \\ \bullet & \bullet \\ \downarrow & \downarrow \\ \Omega & \Omega \end{array}$$

is equal to any (equivalently: all) of the composites (I)-(VI).

Proof. The equality of (I)-(VI) is straightforward calculation (see Appendix VII). We prove that independence is equivalent to the equation $\langle f, g \rangle \circ p_\Omega = (I)$.

1) Assume the square is independent, with channels ϕ, ψ witnessing equation (4). By marginalization, one sees

that ϕ is a choice of Bayesian inverse u^\dagger (and ψ is v^\dagger). By marginalizing the middle wire, we obtain as desired

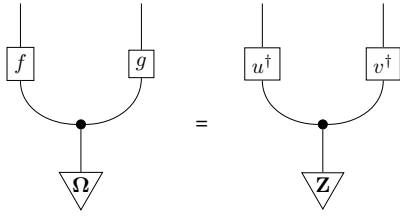

2) Conversely, assuming equation (1), we construct the following factorization

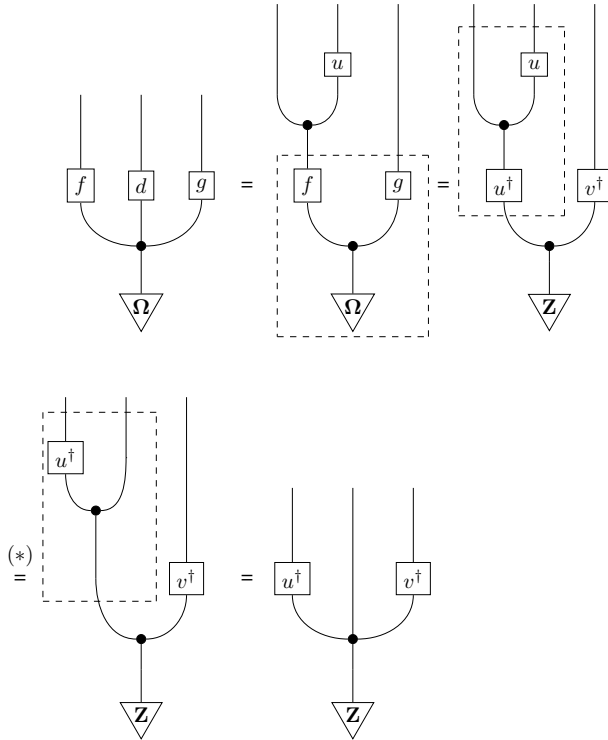

where equations used are determinism of f , the hypothesis, and the step (*) which asserts that $\langle \text{id}_X, u \rangle u^\dagger = \langle u^\dagger, \text{id}_Z \rangle$. This is an application of relative positivity. \square

Matthew Di Meglio and Paolo Perrone have been working on a way to characterize independence in a purely dagger-categorical setup². We include their characterization here and provide a proof for reference.

Proposition 9. *A commutative square (3) in $\mathbb{S}(\mathbb{C})$ is independent if and only if the following equation holds in $\mathbb{P}(\mathbb{C})$*

$$gf^\dagger = v^\dagger u \quad (5)$$

²personal communication

Proof. Assume (5), then using the definition of Bayesian inverse, we have

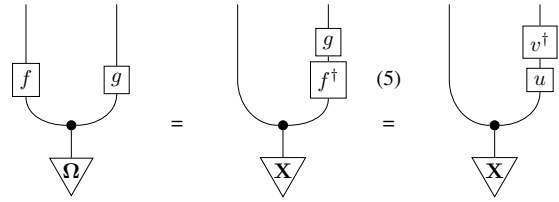

which establishes independence by Lemma 2 Criterion (III). The same argument shows that for an independent square, we have $gf^\dagger =_{\mathbf{X}} v^\dagger u$ and hence equality in the quotient $\mathbb{P}(\mathbb{C})$. \square

Example 7. *Our synthetic definition of independence recovers the concrete ones defined in [27]. Spelling this out*

- 1) in the probabilistic examples, this is the usual notion conditional independence [27, Examples 5.1,5.2]
- 2) for **FinSur**, (3) is independent if for all $x \in X, y \in Y$ with $u(x) = v(y)$ there exists $\omega \in \Omega$ with $f(\omega) = x$ and $g(\omega) = y$. This is, the square is a weak pullback in **Set**. This notion is related to variation independence in database theory [4], [27].
- 3) following Proposition 9, a commuting square of matrices in **CoIso** is independent if it satisfies $GF^T = V^T U$.

At last, we observe that independent squares are pushouts, which we will return to in Section V.

Proposition 10. *Independent squares are pushouts in $\mathbb{S}(\mathbb{C})$.*

Proof. Let the top square be independent; we need to show that a unique map k exists.

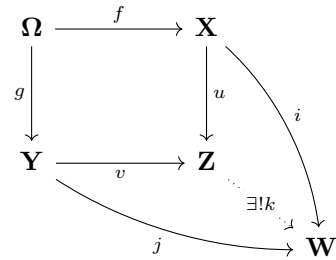

It suffices to show that $k = i \circ u^\dagger = j \circ v^\dagger$ holds and makes the diagram commute. This completes the proof, because any such k is automatically unique (because u is epic) and deterministic (by Proposition 2). Using Lemma 2 we have

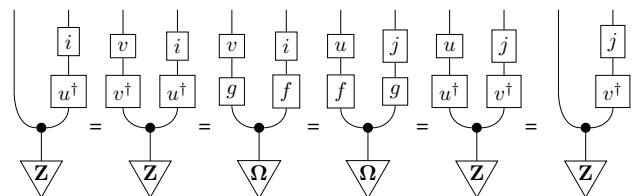

We now show that $k \circ u = i$, namely

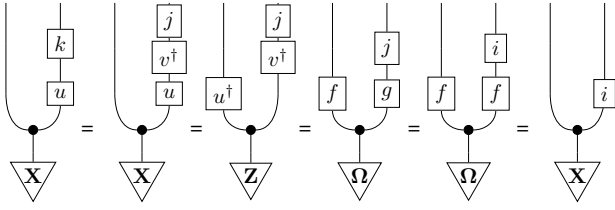

where we use $k = j \circ v^\dagger$, Bayesian inversion, Lemma 2 and determinism of f , respectively. The equation $k \circ v = j$ is shown analogously by instantiating $k = i \circ u^\dagger$. \square

A. Independent Pullbacks

We will now show that the independence structure thus defined has independent pullbacks, which are given by the relative product construction.

Definition 7. Given a cospan $\mathbf{X}_1 \xrightarrow{u_1} \mathbf{Y} \xleftarrow{u_2} \mathbf{X}_2$ of sample spaces, its relative product

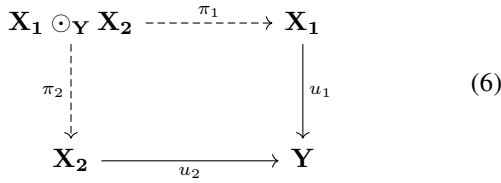

is defined as the sample space $(X_1 \otimes X_2, \rho)$ where

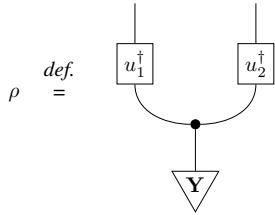

The relative product is closely related to the notion of *conditional product* as defined by Dawid and Studený [5], and studied in Markov categories by Fritz [7, Definition 12.8]. The conditional product is a state of type $X_1 \otimes Y \otimes X_2$, from which the relative product is obtained by marginalization over Y . Our use of the relative product generalizes its use in [27].

Proposition 11. The relative product square (6) commutes and is independent.

Proof. We need to show $u_1 \pi_1 =_\rho u_2 \pi_2$, which upon some simplification and rearrangement requires us to show that

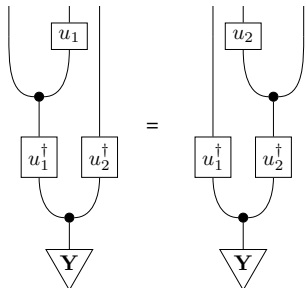

Using the definition of the Bayesian inverse and determinism of u_1 , we transform the left hand side as follows

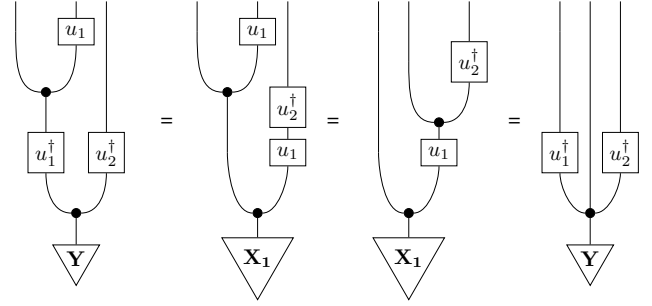

The analogous transformation is possible for the right-hand side, proving the desired equality. To show independence of the square, we establish form (I) of Lemma 2.

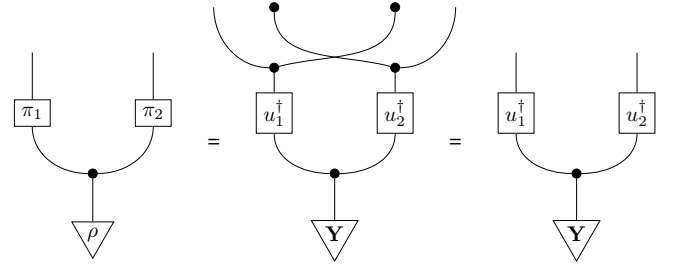

Proposition 12. The relative product square is an independent pullback.

Proof. Assume that in the following diagram the outer kite is independent. We claim there exists a unique mediating map h as shown.

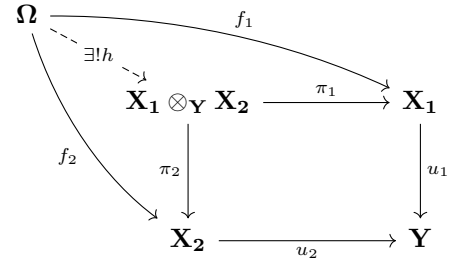

Uniqueness is clear because the projections are jointly monic on deterministic maps (Lemma 1). In fact, we are forced to choose $h = \langle f_1, f_2 \rangle$ to make the diagram commute. It remains to show that this choice of h is a valid morphism in \mathbb{S} (i.e. measure-preserving): $\langle f_1, f_2 \rangle \circ p_\Omega = \rho$. But this is precisely criterion (I) for the independence in Lemma 2. \square

B. Weakness and Descent

In Simpson's work, the categories \mathbb{S} and their independence structures were studied in isolation. In our setting, because $\mathbb{S}(\mathbb{C})$ is derived from Markov category, we can study the interplay of independent pullbacks not just with deterministic maps but also general (nondeterministic) channels from the supercategory $\mathbb{P}(\mathbb{C})$. This reveals a certain analogy between arbitrary independent squares and *weak pullbacks*.

Proposition 13 (Weak independent pullbacks). *Consider two independent squares in $\mathbb{S}(\mathbb{C})$ over the same cospan*

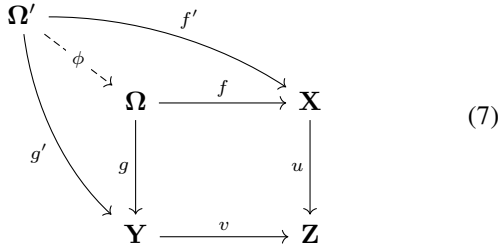

Then there exists a measure-preserving channel $\phi : \Omega' \rightarrow \Omega$ (not necessarily deterministic, nor unique) making the diagram commute in $\mathbb{P}(\mathbb{C})$.

Proof. It suffices to construct a map $\mathbf{X} \otimes_{\mathbf{Z}} \mathbf{Y} \rightarrow \Omega$. The general case can then be solved using the composite $\Omega' \rightarrow \mathbf{X} \otimes_{\mathbf{Z}} \mathbf{Y} \rightarrow \Omega$. Consider the diagram

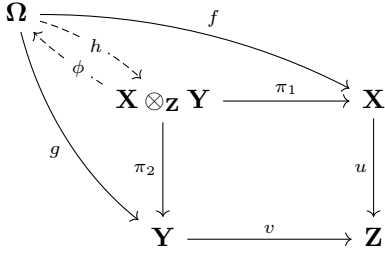

where h be the mediating unique map into the independent pullback, and define the channel $\phi = h^\dagger$ as its Bayesian inverse. This is measure-preserving and satisfies $h\phi = \text{id}$ by determinism. Therefore, ϕ makes the diagram commute as $f\phi = \pi_1 h\phi = \pi_1$ and $g\phi = \pi_2 h\phi = \pi_2$. \square

Proposition 14 (Nondeterministic Descent). *Consider a diagram of commutative squares in $\mathbb{S}(\mathbb{C})$ as follows,*

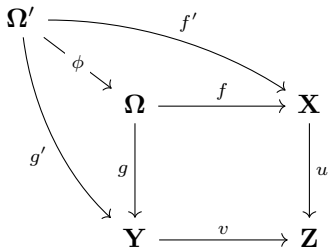

Then the outer kite is independent if and only if the inner square is. The statement remains true if the mediating map ϕ is allowed to be a channel, i.e. lie in $\mathbb{P}(\mathbb{C})$.

Proof. The map $\langle f, g \rangle \circ \phi$ has the deterministic marginals f', g' , so by Lemma 1 it is the product of its marginals,

$\langle f, g \rangle \circ \phi =_{\Omega'} \langle f', g' \rangle$. Hence we have an equality

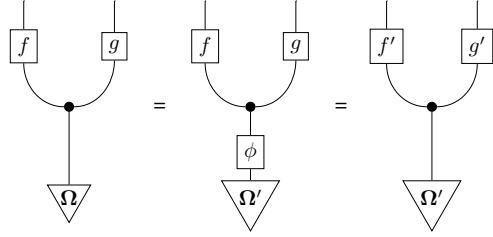

By criterion (I) of 2, if one of the squares is independent so is the other. \square

This proposition strengthens the descent property of [28] which mentions maps instead of channels. Similarly, we can also strengthen the universal property of the independent pullback to quantify over mediating channels:

Proposition 15. *In the situation (7), the inner square is an independent pullback if and only if whenever the outer kite is independent, then there exists a unique mediating channel ϕ .*

Proof. If the inner square is an independent pullback, there exists a mediating map h . To show uniqueness among channels, replace without loss of generality Ω with $\mathbf{X} \otimes_{\mathbf{Z}} \mathbf{Y}$. By 1, any other mediating channel ϕ must be deterministic, hence equal to h by ordinary uniqueness for independent pullbacks.

Conversely, let $h : \Omega \rightarrow \mathbf{X} \otimes_{\mathbf{Z}} \mathbf{Y}$ be the mediating map into the relative product. Then $hh^\dagger = \text{id}$ by determinism, and the following diagram commutes

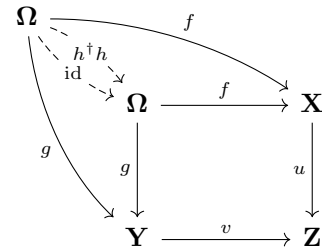

By uniqueness of mediating channels, we have $h^\dagger h = \text{id}_{\Omega}$, i.e. h is an isomorphism. \square

C. Verification of the Axioms

We can now proceed to verify Simpson's axioms (IP1)-(IP5) for our notion of independence. Most of these are straightforward, with (IP4) taking the most work.

Proposition 16 (IP1). *Every square of the following form is independent*

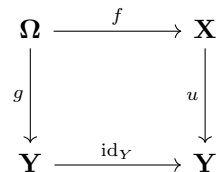

Proof. Using determinism of f and criterion (III) of Lemma 2:

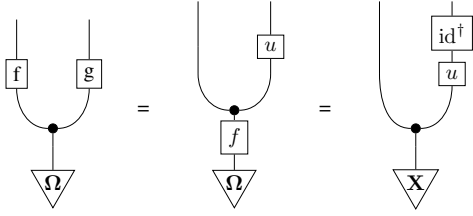

Proposition 17 (IP2).

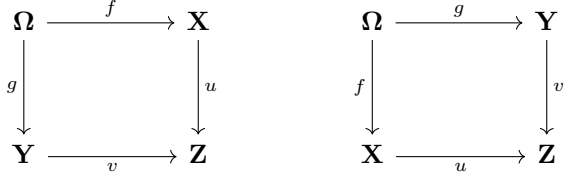

Proof. Immediate from commutativity of the copy maps. \square

Proposition 18 (IP3). If (A) and (B) are independent composable squares, as in

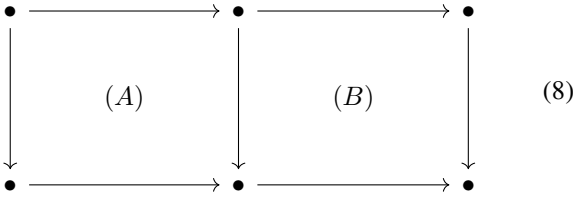

then the large rectangle (AB) is independent.

Proof. We label the squares as follows

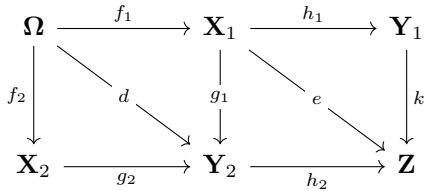

We can now verify criterion (I) by applying Lemma 2 to the independent squares (A) and (B)

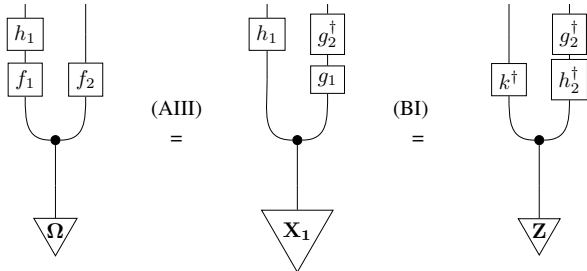

The following property (IP4) requires the most machinery to prove. Using Proposition 14, we can adapt the usual proof strategy for the following variant of the pullback lemma: If (AB) is a weak pullback and (B) a pullback, then (A) is a weak pullback.

Proposition 19 (IP4). In the same situation (8), if the composite rectangle (AB) is independent and (B) is an independent pullback, then (A) is independent.

Proof. By Proposition 14, it suffices to construct a mediating channel ϕ into (A) from an arbitrary independent square Ω' .

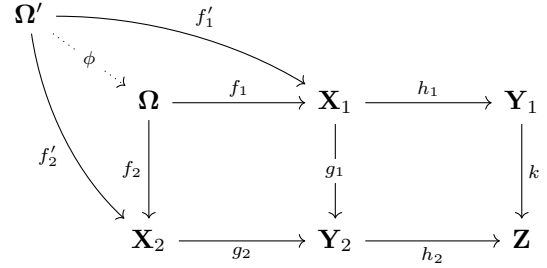

Because the outer square (AB) is independent, there exists a mediating channel ϕ which makes the following diagram commute

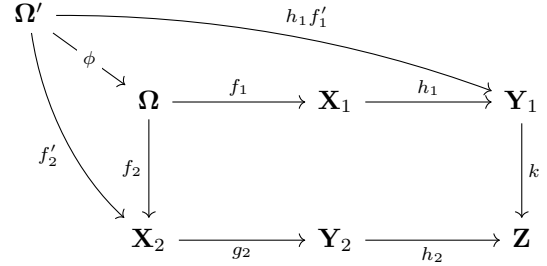

We claim that ϕ also mediates the smaller square (A), i.e. additionally satisfies $f_1\phi = f'_1$. For this, note that the following diagram commutes with two mediating maps

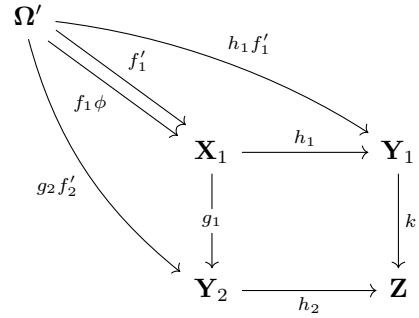

By Proposition 15, we conclude that any two mediating channels must be equal, hence $f_1\phi = f'_1$ as desired. \square

Proposition 20 (IP5). Every cospan $\mathbf{X}_1 \rightarrow \mathbf{Y} \leftarrow \mathbf{Y}_2$ admits a completion to an independent pullback.

Proof. Given by the relative product construction. \square

V. PROBABILITY SHEAVES AND RANDOM VARIABLES

We now begin recreate Simpson's treatment of probability sheaves [26], [28]. Recall that a presheaf is a contravariant functor $P : \mathbb{S}^{\text{op}} \rightarrow \mathbf{Set}$ where the (essentially) small category \mathbb{S} is called a *site*. For probability presheaves, that site will be the category of sample spaces $\mathbb{S}(\mathcal{C})$. That is, a presheaf P consists of a family of sets $P(\Omega)$ indexed over arbitrary sample spaces. If $\pi : \Omega' \rightarrow \Omega$ is a morphism in $\mathbb{S}(\mathcal{C})$ and

$x \in P(\Omega)$ is an element, then we denote the functorial action of P as

$$x \cdot \pi \stackrel{\text{def}}{=} P(\pi)(x) \in F(\Omega')$$

In accordance with Example 6, we can see this action as an extension of the element x to the larger probability space Ω' . A morphism of presheaves $f : P \rightarrow Q$ is a natural transformation; the naturality condition says that the action of f is equivariant with respect to extension: for all $x \in P(\Omega)$ and $\pi : \Omega' \rightarrow \Omega$ we have

$$f_{\Omega'}(x \cdot \pi) = f_{\Omega}(x) \cdot \pi$$

We write $\text{Psh}(\mathbb{S}(\mathbb{C}))$ for the topos of presheaves.

A. Presheaf of Random Elements

For any set X , we write \underline{X} for the constant presheaf with $\underline{X}(\Omega) = X$. Unlike constant presheaves, the concept of random element depends on the underlying sample space Ω . We formalize this as follows:

Definition 8. For each object V of \mathbb{C} , we define a presheaf of random elements valued in V , $\text{RE}(V)$, as follows

1) we define

$$\text{RE}(V)(\Omega, p) = \{[f] : \Omega \rightarrow V \text{ p-a.s. det} \}$$

to consist of p -almost sure equivalence classes of p -almost-surely deterministic morphisms in \mathbb{C} . Note that there is no measure-preservation condition on these f .

2) the extension action is given by precomposition on representatives. If $f : \Omega \rightarrow V$ and $\pi : \Omega' \rightarrow \Omega$, then

$$[f] \cdot \pi \stackrel{\text{def}}{=} [f \circ \pi]$$

Example 8. We have a well-defined natural transformation $\text{Law} : \text{RE}(V) \rightarrow \underline{\mathbb{C}(I, V)}$ which assigns a random element $[f] : \Omega \rightarrow V$ to its law

$$\text{Law}_{\Omega}([f]) = f \circ p_{\Omega}$$

The presheaf $\text{RE}(V)$ is closely related to the representable presheaves on $\mathbb{S}(\mathbb{C})$: If Ω' is a sample space, then $\mathbf{y}(\Omega') = \mathbb{S}(\mathbb{C})(-, \Omega')$ is a sub-presheaf of $\text{RE}(\Omega')$ consisting of those random elements whose law is equal to $p_{\Omega'}$. Conversely, $\text{RE}(V)$ is isomorphic to the coproduct of representables

$$\text{RE}(V) \cong \bigsqcup_{p: I \rightarrow X} \mathbb{S}(\mathbb{C})(-, (V, p))$$

Proposition 21. The random element construction defines a functor $\text{RE} : \mathbb{C}_{\text{det}} \rightarrow \text{Psh}(\mathbb{S}(\mathbb{C}))$ where $\mathbb{C}_{\text{det}} \subseteq \mathbb{C}$ is the subcategory of deterministic morphisms. For $h : V \rightarrow W$ deterministic we define the natural transformation

$$\text{RE}(h) : \text{RE}(V) \rightarrow \text{RE}(W), \quad \text{RE}(h)([f])_{\Omega} \stackrel{\text{def}}{=} [h \circ f]$$

Furthermore the tensor product on \mathbb{C}_{det} is a cartesian product, and the RE functor preserves it

$$\text{RE}(U \otimes V) \cong \text{RE}(U) \times \text{RE}(V)$$

B. Sheaf Conditions

In this section, we will show that the presheaves $\text{RE}(V)$ and $\mathbb{S}(\mathbb{C})(-, \Omega)$ are always *sheaves* with respect to the *atomic topology* on $\mathbb{S}(\mathbb{C})$. This makes the Grothendieck topos of atomic sheaves $\text{Sh}(\mathbb{S}(\mathbb{C}))$ a natural setting for probability sheaves. Sheaf conditions guarantee a well-behaved interplay between the values that a presheaf P takes on different sample spaces Ω , and are intimately related with the independence structure (Propositions 25, 26). Simpson has extensively studied the logical structure of atomic sheaves and their relationship with independence in [28].

Here, we will only introduce what is strictly needed about for atomic topologies, following [28]. For a general introduction to sheaf toposes, we refer to [19]. Let \mathbb{S} be a site. The atomic topology is the Grothendieck topology where every singleton family $\{\Omega' \xrightarrow{\pi} \Omega\}$ is covering. For this topology to be well-defined, one requires the *right Ore condition* on \mathbb{S} : Every cospan can be completed to a commuting square. We have established this for $\mathbb{S}(\mathbb{C})$ in (IP5).

Let $P : \mathbb{S}^{\text{op}} \rightarrow \mathbf{Set}$ be a presheaf and $\pi : Y \rightarrow X$ be map in \mathbb{S} . An element $y \in P(Y)$ is called π -invariant if for any parallel pair of maps $\rho, \rho' : Z \rightarrow Y$ with $\pi \circ \rho = \pi \circ \rho'$, we have $y \cdot \rho = y \cdot \rho'$.

Definition 9. A presheaf $P \in \text{Psh}(\mathbb{S})$ is separated if for all $\pi : Y \rightarrow X$ and $x, y \in P(X)$, if $x \cdot \pi = y \cdot \pi$ then $x = y$.

Definition 10. A presheaf $P \in \text{Psh}(\mathbb{S})$ is an atomic sheaf if for every map $\pi : Y \rightarrow X$ and every π -invariant $y \in P(Y)$, there is a unique $x \in P(X)$ with $y = x \cdot \pi$.

Proposition 22. The presheaves $\text{RE}(V)$ and $\mathbf{y}(V)$ are separated.

Proof. Let $X, Y : \Omega \rightarrow V$ be almost surely deterministic and let $\pi : \Omega' \rightarrow \Omega$ be an extension such that $X \circ \pi =_{\Omega'} Y \circ \pi$. By almost-sure determinism of π , we reason $X =_{\Omega} Y$ as

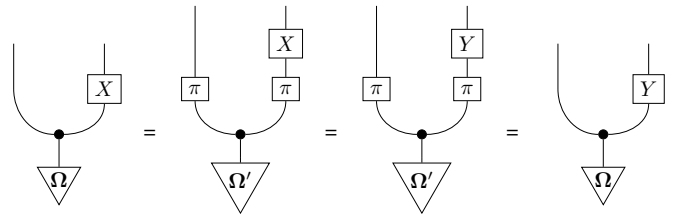

□

The following characterization of π -invariant random elements is helpful and makes connections with the notion of *conditional expectation operator*. In categorical probability theory, conditional expectations can be identified with the composites $e = \pi^{\dagger} \circ \pi$ where π is almost surely deterministic [6], [23]. The map e is a *dagger idempotent*, meaning $e \circ e = e$ and $e^{\dagger} = e$.

Proposition 23. A random element Y is π -invariant if and only if it satisfies $Y = Y \circ e$, where $e = \pi^{\dagger} \circ \pi$ is the conditional expectation associated with π .

Proof. Necessity is clear; if $Y = Y \circ \pi^\dagger \circ \pi$ and $\pi \circ \rho = \pi \circ \rho'$, then $Y \circ \rho = Y \circ \rho'$. For sufficiency, we apply π -invariance to the pair of projections $\rho_1, \rho_2 : (\Omega' \otimes \Omega', \psi) \rightarrow (\Omega', q)$, where $\psi = \langle \text{id}, e \rangle \circ p_{\Omega'}$.

- 1) ρ_1, ρ_2 are measure-preserving, because e is an endomorphism on $\Omega' \rightarrow \Omega'$, hence $e \circ p_{\Omega'} = p_{\Omega'}$.
- 2) we need to check that $\pi \rho_1 =_\psi \pi \rho_2$. This simplifies to verifying that

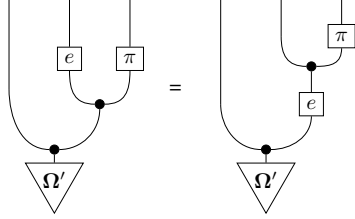

For this, it suffices to note that $\langle \text{id}, \pi \rangle \circ e =_{\Omega'} \langle e, \pi \rangle$ by relative positivity. This is related to e being a *strong idempotent* in the sense of [9, Definition 4.11].

- 3) from π -invariance, we now obtain that $Y \circ \rho_1 =_\psi Y \circ \rho_2$, which means

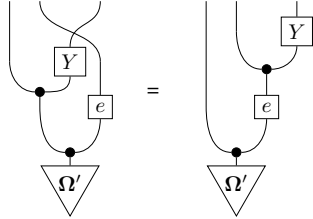

Marginalizing the middle wire gives $Y =_{\Omega'} Y \circ e$ as desired. \square

Proposition 24. *The presheaves $\text{RE}(V)$ and $\mathbf{y}(V)$ are atomic sheaves.*

Proof. Let $Y : \Omega' \rightarrow V$ be π -invariant for $\pi : \Omega' \rightarrow \Omega$; we claim that there exists a unique $X : \Omega \rightarrow V$ with $Y = X \cdot \pi$. Uniqueness follows from separation. For existence, define $X = Y \circ \pi^\dagger$. By Proposition 23, we have $Y = Y \pi^\dagger \pi = X \pi$, and X is almost surely deterministic because $X \pi$ is (Proposition 2). \square

We can compare our direct proofs with two general propositions of [28] about presheaves on a site \mathbb{S} with an independent pullback structure. They illuminate the relationship between the independence structure and the atomic topology.

Proposition 25 ([28, Theorem 6.4]). *The following are equivalent for $P \in \text{Psh}(\mathbb{S})$*

- 1) P is an atomic sheaf
- 2) P maps independent squares in $\mathbb{S}(\mathbb{C})$ to pullbacks in Set

Proposition 26 [28, Corollary 6.6]). *The following are equivalent*

- 1) representable presheaves are atomic sheaves
- 2) independent squares in \mathbb{S} are pushouts

As we have shown that independent squares in $\mathbb{S}(\mathbb{C})$ are pushouts (Proposition 10), this gives another way proving that representable presheaves are sheaves.

Our development has now come full circle. Starting with the theory of fresh name generation **StrongName**, the category of sample spaces $\mathbb{S}(\text{StrongName})$ is equivalent to $\mathbf{FinInj}^{\text{op}}$. Its atomic sheaf topos $\text{Sh}(\mathbf{FinInj}^{\text{op}})$ is the Schanuel topos, which is again equivalent to the category **Nom** of nominal sets [24].

VI. CONCLUSION AND FUTURE WORK

We have replicated substantial parts of Simpson's development on independence and probability sheaves in the synthetic setting of a sample spaces over a Markov category. We have phrased everything in terms of abstract notions and proof principles, without relying on specific details of the individual models. We have recovered known examples from probability theory, nondeterminism and fresh name generation in this setting, as well generalized the theory to novel ones such as Gaussian probability.

This line of work is only at the beginning, and several directions have been left for future work: It will be interesting to study the intrinsic logical notions of atomic sheaf toposes (supports, atomic equivalence etc. [28]) in our setting. Similarly, a treatment of random variables with a notion of expectation/averaging and conditional expectations is future work.

A monad \mathcal{M} can be defined on probability sheaves which models the allocation of fresh random variables, defined in [26] as

$$\mathcal{M}P(\Omega) = \int^{\Omega'} \mathbb{S}(\Omega', \Omega) \times P(\Omega')$$

This monad is a direct generalization of the name generation monad N on the Schanuel topos. Connections between probabilistic separation logic and nominal techniques are an active area of research [17], [18]. Given our characterization $\mathbb{S}(\mathbf{Gauss}) \cong \mathbf{CoIso}$, the category of atomic sheaves on isometries $\text{Sh}(\mathbf{CoIso}) \cong [\mathbf{Iso}, \mathbf{Set}]_{\text{at}}$ seems to be of interest as a linear-algebraic generalization of the Schanuel topos that seems tightly related to Gaussian probability.

Lastly, we have seen that the categories $\mathbb{S}(\mathbb{C})$ and $\mathbb{P}(\mathbb{C})$ often admit, up to equivalence, very simple descriptions, sometimes simpler than the Markov category \mathbb{C} . We wonder to which extent the category \mathbb{C} can be reconstructed from such a description, or which kind of additional information is required to do so. Unfortunately, the categories \mathbb{C} and $\mathbb{P}(\mathbb{C})$ are not related by a forgetful functor or opfibration; there is however a *cofunctor* between them in the sense of [2].

Acknowledgements: I am grateful for the feedback and fruitful discussions about this work with many people, particularly Alex Simpson, Matthew Di Meglio, Paolo Perrone and Chris Heunen. A preliminary version of this work was presented at ItaCa Fest 2024.

REFERENCES

- [1] Kenta Cho and Bart Jacobs. Disintegration and bayesian inversion via string diagrams. *Mathematical Structures in Computer Science*, 29(7):938–971, 2019.
- [2] Bryce Clarke. Internal lenses as functors and cofunctors. *arXiv preprint arXiv:2009.06835*, 2020.
- [3] Fredrik Dahlqvist and Dexter Kozen. Semantics of higher-order probabilistic programs with conditioning. *Proceedings of the ACM on Programming Languages*, 4(POPL):1–29, 2019.
- [4] A Philip Dawid. Separoids: A mathematical framework for conditional independence and irrelevance. *Annals of Mathematics and Artificial Intelligence*, 32:335–372, 2001.
- [5] A Philip Dawid and Milan Studený. Conditional products: An alternative approach to conditional independence. In *Seventh International Workshop on Artificial Intelligence and Statistics*, pages 27–35. PMLR, 1999.
- [6] Noé Ensarguet and Paolo Perrone. Categorical probability spaces, ergodic decompositions, and transitions to equilibrium. *arXiv preprint arXiv:2310.04267*, 2023.
- [7] Tobias Fritz. A synthetic approach to Markov kernels, conditional independence and theorems on sufficient statistics. *Adv. Math.*, 370:107239, 2020.
- [8] Tobias Fritz, Tomáš Gonda, Nicholas Gauguin Houghton-Larsen, Antonio Lorenzin, Paolo Perrone, and Dario Stein. Dilations and information flow axioms in categorical probability. *Mathematical Structures in Computer Science*, 33(10):913–957, 2023.
- [9] Tobias Fritz, Tomáš Gonda, Antonio Lorenzin, Paolo Perrone, and Dario Stein. Absolute continuity, supports and idempotent splitting in categorical probability. 2023. arXiv:2308.00651.
- [10] Tobias Fritz, Tomáš Gonda, and Paolo Perrone. De finetti’s theorem in categorical probability. *arXiv preprint arXiv:2105.02639*, 2021.
- [11] Tobias Fritz and Andreas Klingler. The d-separation criterion in categorical probability. *Journal of Machine Learning Research*, 24(46):1–49, 2023.
- [12] Tobias Fritz and Eigil Fjeldgren Rischel. Infinite products and zero-one laws in categorical probability. *Compositionality*, 2, 2020.
- [13] Murdoch Gabbay and Andrew Pitts. A new approach to abstract syntax involving binders. In *Proceedings. 14th Symposium on Logic in Computer Science (Cat. No. PR00158)*, pages 214–224. IEEE, 1999.
- [14] Olav Kallenberg and Olav Kallenberg. *Foundations of modern probability*, volume 2. Springer, 1997.
- [15] Martti Karvonen. The way of the dagger. *arXiv preprint arXiv:1904.10805*, 2019.
- [16] Dexter Kozen, Alexandra Silva, and Erik Voogd. Joint distributions in probabilistic semantics. *Electronic Notes in Theoretical Informatics and Computer Science*, 3, 2023.
- [17] John M. Li, Amal Ahmed, and Steven Holtzen. Lilac: A modal separation logic for conditional probability. *Proc. ACM Program. Lang.*, 7(PLDI), June 2023.
- [18] John M. Li, Jon Aytac, Philip Johnson-Freyd, Amal Ahmed, and Steven Holtzen. A nominal approach to probabilistic separation logic. In *Proceedings of the 39th Annual ACM/IEEE Symposium on Logic in Computer Science*, LICS ’24, New York, NY, USA, 2024. Association for Computing Machinery.
- [19] Saunders MacLane and Ieke Moerdijk. *Sheaves in geometry and logic: A first introduction to topos theory*. Springer Science & Business Media, 2012.
- [20] Arthur J Parzygnat. Reversing information flow: retrodiction in semi-cartesian categories. *arXiv preprint arXiv:2401.17447*, 2024.
- [21] Arthur J Parzygnat and Francesco Buscemi. Axioms for retrodiction: achieving time-reversal symmetry with a prior. *Quantum*, 7:1013, 2023.
- [22] Judea Pearl and Azaria Paz. Graphoids: Graph-based logic for reasoning about relevance relations or when would x tell you more about y if you already know z? In *Probabilistic and Causal Inference: The Works of Judea Pearl*, pages 189–200. 2022.
- [23] Paolo Perrone and Ruben Van Belle. Convergence of martingales via enriched dagger categories. *arXiv preprint arXiv:2404.15191*, 2024.
- [24] Andrew M Pitts. *Nominal sets: Names and symmetry in computer science*. Cambridge University Press, 2013.
- [25] Peter Selinger. A survey of graphical languages for monoidal categories. *New structures for physics*, pages 289–355, 2011.
- [26] Alex Simpson. Probability sheaves and the giry monad. In *7th Conference on Algebra and Coalgebra in Computer Science (CALCO 2017)*. Schloss-Dagstuhl-Leibniz Zentrum für Informatik, 2017.
- [27] Alex Simpson. Category-theoretic structure for independence and conditional independence. *Electronic Notes in Theoretical Computer Science*, 336:281–297, 2018. The Thirty-third Conference on the Mathematical Foundations of Programming Semantics (MFPS XXXIII).
- [28] Alex Simpson. Equivalence and conditional independence in atomic sheaf logic. In *Proceedings of the 39th Annual ACM/IEEE Symposium on Logic in Computer Science*, LICS ’24, New York, NY, USA, 2024. Association for Computing Machinery.
- [29] Sam Staton. Commutative semantics for probabilistic programming. In *Programming Languages and Systems: 26th European Symposium on Programming, ESOP 2017, Held as Part of the European Joint Conferences on Theory and Practice of Software, ETAPS 2017, Uppsala, Sweden, April 22–29, 2017, Proceedings 26*, pages 855–879. Springer, 2017.
- [30] Dario Stein. *Structural Foundations for Probabilistic Programming Languages*. PhD thesis, University of Oxford, 2021.
- [31] Dario Stein and Sam Staton. Compositional semantics for probabilistic programs with exact conditioning. In *2021 36th Annual ACM/IEEE Symposium on Logic in Computer Science (LICS)*, pages 1–13. IEEE, 2021.
- [32] Terence Tao. 254a, notes 0: A review of probability theory. <https://terrytao.wordpress.com/2010/01/01/254a-notes-0-a-review-of-probability-theory/> Mar 2015. Accessed: 5-12-2024.
- [33] Nikos Tzevelekos. Nominal game semantics. 2009.

VII. APPENDIX: PROOFS

Proof of Lemma 2. We verify the equalities of the composites (I)–(VI). By the characteristic property of Bayesian inversion, we have

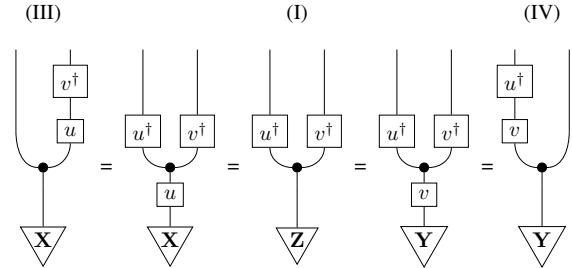

Because f and g are co-isometries, we have

$$\begin{aligned} u^\dagger &= f f^\dagger u^\dagger = f (u f)^\dagger = f d^\dagger \\ v^\dagger &= g g^\dagger v^\dagger = g (v g)^\dagger = g d^\dagger \end{aligned}$$

showing (I) = (II). Again, by determinism of f , we have

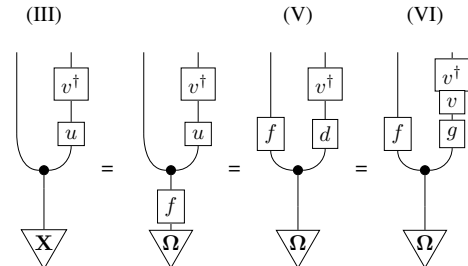

□

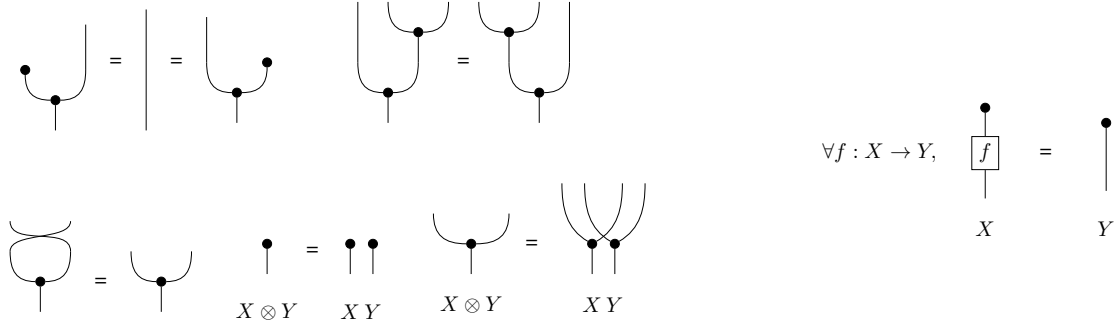

Fig. 1. The axioms for Markov categories

VIII. APPENDIX: EXAMPLE CATEGORIES

In this appendix, we spell out definitions and examples in more detail. Independent squares will be labelled

$$\begin{array}{ccc}
 \Omega & \xrightarrow{f} & X \\
 g \downarrow & & \downarrow u \\
 Y & \xrightarrow{v} & Z
 \end{array} \quad (9)$$

A. Gaussian Probability

Given a Gaussian sample space, we can replace it up to isomorphism by a simpler sample space in two stages: first by a faithful one, and then by a *standard sample space* which has covariance matrix I_k .

Let $\mathcal{N}(\mu, \Sigma)$ be a Gaussian distribution which is supported on the subspace $S = \mu + \text{im}(\Sigma)$. Let $k = \dim(S) = \text{rank}(\Sigma)$ be its dimension, and choose an affine isomorphism $i: \mathbb{R}^k \rightarrow S$. Then i is a split support inclusion as shown in [31, III.10]. A sample space $(\mathbb{R}^n, \mathcal{N}(\mu, \Sigma))$ is therefore faithful if and only if Σ has full rank (i.e. is positive definite).

Assume now that Σ has full rank; we call a *standard sample space* one equipped with a standard normal distribution, i.e. $(\mathbb{R}^n, \mathcal{N}(0, I_n))$. By Cholesky decomposition, there is a decomposition $\Sigma = LL^T$ where $L \in \mathbb{R}^{n \times n}$ is invertible. Thus, the affine map $f(x) = Lx + \mu$ defines an isomorphism of sample spaces

$$(\mathbb{R}^n, \mathcal{N}(0, I_n)) \xrightarrow{f} (\mathbb{R}^n, \mathcal{N}(\mu, \Sigma))$$

This shows that every sample space in $\mathbb{S}(\mathbf{Gauss})$ is isomorphic to a standard sample space.

A channel in $\mathbb{P}(\mathbf{Gauss})$ between standard sample spaces

$$f: (\mathbb{R}^m, \mathcal{N}(0, I_m)) \rightarrow (\mathbb{R}^n, \mathcal{N}(0, I_n))$$

is necessarily of the form $f(x) = Ax + \mathcal{N}(0, \Sigma)$ where measure preservation imposes

$$AA^T + \Sigma = I_n \quad (10)$$

Because we can read off Σ from (10), we can identify such channels with matrices $A \in \mathbb{R}^{n \times m}$ such that $I_n - AA^T \succcurlyeq 0$. Such a channel is deterministic iff $\Sigma = 0$, i.e. $AA^T =$

I_n . Therefore, the category $\mathbb{S}(\mathbf{Gauss})$ is equivalent to the category \mathbf{CoIso} of Euclidean co-isometries.

To compute the Bayesian inverse of f , we apply an ansatz $f^\dagger(y) = By + \mathcal{N}(0, \Phi)$ and solve equation (1), which reads

$$\begin{pmatrix} I_m & A^T \\ A & AA^T + \Sigma \end{pmatrix} = \begin{pmatrix} BB^T + \Phi & B \\ B^T & I_n \end{pmatrix}$$

We obtain $B = A^T$ and $\Phi = I_m - A^T A$.

Independence structure: Using characterization (9), a commutative square in $\mathbb{S}(\mathbf{Gauss})$ is independent if and only if the corresponding square in \mathbf{CoIso}

$$\begin{array}{ccc}
 \mathbb{R}^w & \xrightarrow{F} & \mathbb{R}^m \\
 G \downarrow & & \downarrow U \\
 \mathbb{R}^n & \xrightarrow{V} & \mathbb{R}^k
 \end{array}$$

satisfies $GF^T = V^T U$. Note that the category of co-isometries \mathbf{CoIso} is equivalent to the opposite category of isometries \mathbf{Iso}^{op} by means of the transposition functor $A \mapsto A^T$. A square of isometries

$$\begin{array}{ccc}
 \mathbb{R}^w & \xleftarrow{A} & \mathbb{R}^m \\
 B \uparrow & & \uparrow J \\
 \mathbb{R}^n & \xleftarrow{K} & \mathbb{R}^k
 \end{array}$$

is considered independent if $B^T A = KJ^T$. The category of probability sheaves over \mathbf{Gauss} can thus be identified with covariant functors $\mathbf{Inj} \rightarrow \mathbf{Set}$ taking independent squares to pullbacks.

B. Nominal Sets

We briefly recall the notion of nominal sets [13], [24]. Let \mathbb{A} be a countably infinite set of names, and $\text{Perm}(\mathbb{A})$ be the group of finite permutations of \mathbb{A} . If X is a set with a $\text{Perm}(\mathbb{A})$ -action $(\pi, x) \mapsto \pi \cdot x$, we say that a finite set of names $A \subseteq \mathbb{A}$ *supports* $x \in X$ if

$$\forall \pi \in \text{Perm}(\mathbb{A}), (\forall a \in A, \pi(a) = a) \Rightarrow \pi \cdot x = x$$

We say that A *strongly supports* $x \in X$ if

$$\forall \pi \in \text{Perm}(\mathbb{A}), (\forall a \in A, \pi(a) = a) \Leftrightarrow \pi \cdot x = x$$

A *nominal set* is a $\text{Perm}(\mathbb{A})$ -set X in which every element is supported by some finite set of names. A *strong nominal set* is one where each element is strongly supported by a set of names [33]. Nominal sets and strong nominal sets form categories \mathbf{Nom} and \mathbf{sNom} respectively, where morphisms $f : X \rightarrow Y$ are equivariant functions.

The *orbit* $\text{orb}(x)$ of an element $x \in X$ is the subset $\{\pi \cdot x \mid \pi \in \text{Perm}(\mathbb{A})\}$. We write $\Pi_0(X)$ for the set of orbits of X . A nominal set X is called *atomic* if it consists only of a single orbit. Each nominal set is the coproduct of its orbits

$$X \cong \bigsqcup_{W \in \Pi_0(X)} W$$

Lemma 3. *Let $x \in X$ and $y \in Y$ be elements of nominal sets, where X is strong and atomic. Then there exists at most one equivariant function $f : X \rightarrow Y$ with $f(x) = y$, and it exists if and only if $\text{supp}(y) \subseteq \text{supp}(x)$.*

Proof. By applying [24, Proposition 15.11]; the stabilizer condition is discharged by X being strong. \square

An important role is played by the atomic nominal sets \mathbb{A}^{*n} ,

$$\mathbb{A}^{*n} = \{(a_1, \dots, a_n) \text{ distinct names}\}$$

We call a nominal set X *representable* if it is isomorphic to \mathbb{A}^{*n} for some $n \in N$ (this is related to the Yoneda lemma [24, Exercise 6.1]).

If $x \in X$ is strongly supported by $A = \{a_1, \dots, a_n\}$, then the orbit $\text{orb}(x)$ is isomorphic to \mathbb{A}^{*n} . This follows immediately from Lemma 3, by extending the assignment $f(x) = (a_1, \dots, a_n)$ under equivariance. As a consequence, strong nominal sets are precisely the coproducts of representables. Products and coproducts of strong nominal sets are strong.

Schanuel topos: It is well-known that \mathbf{Nom} is equivalent to the Schanuel topos $\text{Sh}(\mathbf{FinInj}^{\text{op}})$ [24]. Concretely, the Schanuel topos consists of covariant functors $P : \mathbf{FinInj} \rightarrow \mathbf{Set}$ preserving pullbacks. Under the equivalence, the nominal sets \mathbb{A}^{*n} correspond to the representable presheaves $\mathbf{FinInj}(n, -)$. In particular

$$\mathbf{Nom}(\mathbb{A}^{*m}, \mathbb{A}^{*n}) \cong \mathbf{FinInj}(n, m) \quad (11)$$

by the Yoneda lemma.

Name generation: There is monad $N : \mathbf{Nom} \rightarrow \mathbf{Nom}$ which models fresh name generation (known as the name-generation monad, or free restriction set monad) [24, Section 9.5]. The elements of $N(X)$ are equivalence classes of pairs (A, x) where A is a finite set of names and $x \in X$. Two such pairs (A, x) and (A', x') are considered equivalent if $x' = \pi \cdot x$ for some permutation π which only interchanges names mentioned in A, A' . This models α -equivalence; we write the equivalence

class of (A, x) as $\langle A \rangle x$. For example, we have $\langle a, b \rangle a = \langle c \rangle c$ by the renaming $\pi = (a c)$.

If X is strong so is $N(X)$, and it holds that $\text{supp}(\langle A \rangle x) = \text{supp}(x) \setminus A$. The monad restricts to $N : \mathbf{sNom} \rightarrow \mathbf{sNom}$. We denote by $\mathbf{StrongName}$ its Kleisli category, which has the structure of a Markov category.

Proposition 27. *To give a state $I \rightarrow X$ in $\mathbf{StrongName}$ is to give an orbit $\text{orb}(x)$.*

Proof. We have $\mathbf{Nom}(I, N(X)) \cong \Pi_0(X)$: To give a point $1 \rightarrow N(X)$ is to give an element with empty support in $N(X)$, and those are of the form $\langle A \rangle x$ where $A = \text{supp}(x)$. Two such elements are α -equivalent iff they lie in the same orbit. \square

For example, the nominal set $\mathbb{A} \times \mathbb{A}$ has two states in $\mathbf{StrongName}$: two independent fresh names $\langle a, b \rangle (a, b)$, and a single shared fresh name $\langle a \rangle (a, a)$.

Proposition 28. *$\mathbf{StrongName}$ has conditionals.*

Proof sketch. Given $f : A \rightarrow N(X \times Y)$, we use Lemma 3 to define the conditional on orbit-by-orbit. If $f(a) = \langle C \rangle (x, y)$, we define

$$f|_X(a, x) = \langle C' \rangle y \text{ where } C' = C \setminus \{\text{supp}(x)\}$$

and extend by equivariance. \square

Note that strongness is a crucial assumption to use Lemma 3. The Kleisli category of N on \mathbf{Nom} does *not* have all conditionals [30, Proposition 25.21].

Proposition 29. *Sample spaces in $\mathbf{StrongName}$ can be described as pairs (X, W) where $W \subseteq X$ is an orbit. The inclusion $(W, W) \rightarrow (X, W)$ is a support inclusion, and the sample space is faithful if and only if $W = X$.*

Proof. If $W = \text{orb}(x)$ is an orbit, two equivariant functions $f, g : X \rightarrow N(Y)$ are W -almost surely equal if $f(x) = g(x)$. The support projection $\pi : X \rightarrow N(W)$ is given by

$$\pi(x) = \begin{cases} \langle \rangle x, & x \in W \\ \langle \text{supp}(w) \rangle w, & x \notin W \end{cases}$$

where w is an arbitrary element of W . \square

Proposition 30. *$\mathbb{S}(\mathbf{StrongName})$ is equivalent to $\mathbf{FinInj}^{\text{op}}$*

Proof. By Proposition 4, every sample space in $\mathbb{S}(\mathbf{StrongName})$ is isomorphic to a faithful sample space of the form $(\mathbb{A}^{*n}, \mathbb{A}^{*n})$. By (11), to give a map $\mathbb{A}^{*m} \rightarrow \mathbb{A}^{*n}$ is to give an injection $f : n \rightarrow m$, and every such map is automatically state-preserving. \square