

Multi-Tenant SmartNICs for In-Network Preprocessing of Recommender Systems

Yu Zhu
ETH Zürich

Wenqi Jiang
ETH Zürich

Gustavo Alonso
ETH Zürich

Abstract

Keeping ML-based recommender models up-to-date as data drifts and evolves is essential to maintain accuracy. As a result, online data preprocessing plays an increasingly important role in serving recommender systems. Existing solutions employ multiple CPU workers to saturate the input bandwidth of a single training node. Such an approach results in high deployment costs and energy consumption. For instance, a recent report from industrial deployments shows that data storage and ingestion pipelines can account for over 60% of the power consumption in a recommender system. In this paper, we tackle the issue from a hardware perspective by introducing PIPER, a flexible and network-attached accelerator that executes data loading and preprocessing pipelines in a streaming fashion. As part of the design, we define MiniPipe, the smallest pipeline unit enabling multi-pipeline implementation by executing various data preprocessing tasks across the single board, giving PIPER the ability to be reconfigured at runtime. Our results, using publicly released commercial pipelines, show that PIPER, prototyped on a power-efficient FPGA, achieves a 39~105 \times speedup over a server-grade, 128-core CPU and 3~17 \times speedup over GPUs like RTX 3090 and A100 in multiple pipelines. The experimental analysis demonstrates that PIPER provides advantages in both latency and energy efficiency for preprocessing tasks in recommender systems, providing an alternative design point for systems that today are in very high demand.

1 Introduction

Efficient data loading and preprocessing are essential for optimizing the performance of machine learning (ML) systems. Data loading is needed for retrieving data from various sources, potentially in different formats. Data preprocessing enhances model accuracy by performing tasks like normalization, feature encoding, and data augmentation, which significantly influence the quality and effectiveness of ML models [9, 11, 43, 47, 61, 62, 82]. Modern ML systems typically

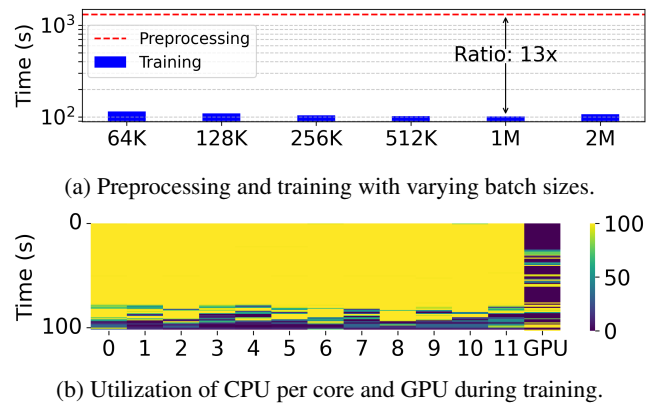

Figure 1: Performance analysis for DLRM training in A100 machine, including preprocessing phase (CPU) and training phase (CPU for data loading, GPU for training).

adopt a hybrid CPU-GPU architecture, where the CPU handles the loading and preprocessing tasks and then transfers the processed data to the GPU for training [14, 15, 27, 69, 98, 111]. This configuration leverages the strengths of CPUs (flexibility, general-purpose functionality) for data preparation and those of GPUs (computational power) for model training. However, GPU performance has seen rapid advancements in recent years [16], while CPU performance has lagged behind. As a result, data preprocessing is often a bottleneck in ML training systems due to the increasing performance gap between CPUs and GPUs, as recently discussed in the context of large scale commercial cloud deployments [112, 113].

To analyze the problem in more detail, we have conducted a number of initial experiments using publicly available pipelines for Deep Learning Recommender Models (DLRM) implemented by Meta [113] to understand the gap between the CPU and the GPU. We compare the time to train one epoch on the GPU for different configurations on Google Cloud (1 Nvidia A100 GPU, 12-core CPU, see experimental section for details) with the time needed for data preprocessing on the CPU (Figure 1a). There is more than an order of

magnitude difference between the two, with preprocessing being the biggest bottleneck. In addition, Figure 1b shows the utilization of CPU per core and GPU during the training phase with a batch size 1M, where all cores of the CPU are fully utilized to load the preprocessed data, while the GPU remains idle for a substantial portion of the time, indicating the potential for improvement. These results confirm reports from Meta [113] and motivate us to accelerate the CPU part to optimize the overall end-to-end performance while achieving higher levels of efficiency, both in performance as well as in energy consumption and resource used.

Traditionally, the preprocessing and the training steps are executed sequentially, a practice known as *offline preprocessing* [26, 60, 77], which simplifies scheduling and allows designers to focus on the training part. However, as the size of the data grows [65, 104, 107, 113], this approach becomes less attractive due to its excessive storage overhead. Additionally, updates to the source datasets require more frequent updates to the models, with the offline approach leading to a significant model update latency (e.g., dozens of minutes), which adversely affects Service-Level Objectives (SLOs) [91], such as the freshness and quality of the recommendation results for online shopping. As an alternative, *online preprocessing* [24, 64, 83, 84, 91] has gained popularity because it enables an end-to-end dataflow, from the storage node to the final training node, to run in a pipelined fashion without requiring additional memory buffers. This solution necessitates a high-throughput preprocessing stage, as production training jobs in recommender models typically process the new data in a single epoch [113].

To address the performance gap illustrated in Figure 1a, platforms such as the Distributed PreProcessing Service (DPP) [113] have been developed, combining various distributed and parallel processing techniques to improve the overall throughput [2, 38, 70, 112, 113]. A common approach is to use multiple machines to process the data needed to feed one GPU [38, 113] which provides the required performance, but it leads to a huge increase in the resources needed and negatively impacts the overall efficiency and cost. The power consumption for data storage and ingestion pipelines can be as high as 60% of the overall system [17, 113], which makes it the main target for improvement in order to make recommender systems more sustainable.

In this paper, we propose an alternative using specialized hardware in the form of PIPER, an efficient, network-attached data loader and preprocessing engine for recommender systems, which excels in online conditions while maintaining strong performance in offline scenarios. The design of PIPER builds on several observations from deployed systems. On the one hand, once a robust preprocessing pipeline is established for a specific type of task, like online shopping or video recommendation, users can often reuse it across different model iterations with only minor adjustments [23, 28]. This requires a system that can be modified at run time, allowing updates

to preprocessing logic without disrupting operations. On the other hand, online preprocessing allows a design capable of processing data directly streamed from the network or storage, a task that is particularly challenging for a CPU to handle efficiently. This requires a flexible architecture that is easily deployable on either a network attached device (e.g., a SmartNIC [37, 48, 54, 99, 109]) or on computational storage.

We have evaluated PIPER using a variety of pipelines derived from publicly available DLRM models developed by Meta and Google [22, 80, 113]. Compared to the columnar processing performance of a server-grade 128-core CPU, PIPER achieves an acceleration ratio of 39~105 \times , depending on whether the pipeline is stateless or not. It also outperforms high-end GPUs, such as the Nvidia RTX 3090 and A100, in both latency and power efficiency, resulting in lower energy consumption. PIPER achieves a speedup of 3~17 \times against GPUs by leveraging its fully pipelined execution and is more power-efficient by a significant margin: 2.9~6.4 \times . With these capabilities, PIPER effectively serves as a network-or storage-attached accelerator for online preprocessing pipelines of recommender systems, offering exceptional performance and energy efficiency.

This paper makes the following contributions:

- PIPER uses an innovative hardware design that can be used flexibly as an intermediate preprocessing layer for data coming from storage, memory, or from the network.
- PIPER illustrates and exemplifies how to implement high-performance preprocessing operators for real-world applications, demonstrating its potential to evolve into a comprehensive library for hardware-acceleration of recommender system preprocessing pipelines.
- PIPER introduces MiniPipe, a mechanism to support multiple pipelines concurrently on the same device, offering versatility for scalable performance targets.
- PIPER outperforms server-grade CPUs and GPUs in both latency and power consumption, for both stateless and stateful pipelines. It thereby provides an alternative architectural option for building more efficient data centers for recommender systems.

2 Background and Motivation

ML training systems are inherently complex, driven by the increasing demands of large models, massive datasets, and stringent performance requirements (Figure 2). These systems involve a variety of hardware platforms, including CPUs, GPUs, and specialized accelerators, each with distinct architectures, which often necessitate distributed computation across multiple nodes. In what follows, we discuss each one of these aspects and how they influence the proposed design.

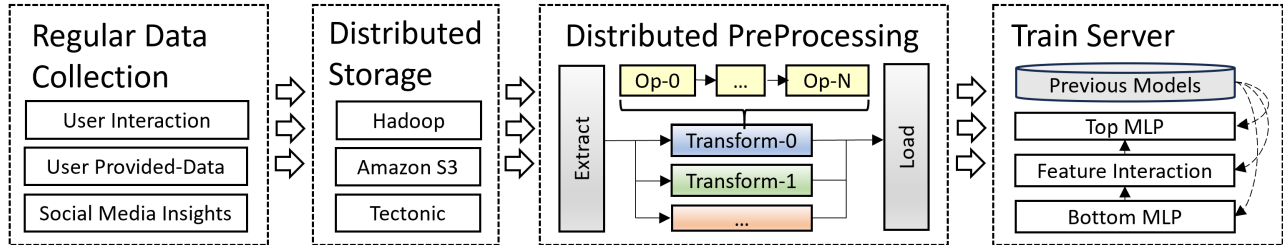

Figure 2: System overview for distributed online training of ML-based recommender models. Engineers regularly collect data from various sources, store it in distributed file systems, process it through distributed preprocessing nodes, and finally send it to computing servers to update the pre-trained models.

2.1 Dynamic Datasets

Real-world machine learning datasets are often dynamic, especially for applications like recommender systems, as they continuously grow with the collection of new samples [25, 35, 40, 92, 115]. Datasets can experience two common types of changes: data evolution and data drift [7, 24]. Data evolution refers to natural changes like the introduction of new features, classes, or an increase in data volume, while data drift involves changes in the distribution of inputs, labels, or the relationships between inputs and outputs, which can lead to model performance degradation. To address these challenges, it is crucial to detect such changes, retrain or update models as needed, and ensure that data pipelines remain robust to maintain the accuracy and reliability of models in dynamic environments. For instance, daily retraining of models at the GrubHub food delivery platform can lead to a 20% increase in purchase rates compared to not retraining the models [24]. Similarly, a high-performance data loader can greatly improve the end-to-end system performance [3, 10, 49, 76, 95, 117], highlighting the need for efficient preprocessing pipelines.

2.2 Preprocessing for Embeddings

The input contents for ML-based recommender systems are diverse and include numerical values, texts, images, graphs, audio, and more. Training, however, operates on embeddings, an efficient representation method for features in a low-dimensional continuous vector space [114]. Thus, the preprocessing pipeline often involves a series of transformations to generate such embeddings from the raw input data, converting non-trainable parameters into trainable representations.

Input feature vectors for recommender models are divided into *dense* and *sparse* features, both contributing significantly to the training process [12, 41, 73]. Dense features, such as a user’s age, item pricing, or a movie’s average rating, are usually well-defined and ready for direct analysis. Normalizing these features to achieve zero mean and unit variance greatly improves model performance by facilitating faster and more stable convergence. Sparse features, which normally originate from categorical data, provide valuable insights although

Table 1: Transformation operators for different features.

Op Name	Description	Category
Neg2Zero	Change negative values to zero.	dense, stateless
Logarithm	Do $\log(x+1)$ operation.	dense, stateless
Hex2Int	Convert hex strings to decimal.	sparse, stateless
Modulus	Compute positive modulus.	sparse, stateless
VocabGen	Create tables from unique values.	sparse, stateful
VocabMap	Map values to generated indices.	sparse, stateful

they often contain many zeros or missing values. Examples of sparse features include one-hot-encoded user IDs and advertisement categories. By transforming these sparse features into binary vectors and embedding them into dense representations, they can be used to enhance training quality.

Table 1 presents the operators utilized in this paper, which are drawn from Meta’s and Google’s open-source recommender models [22, 80]. We will discuss these operators in more details in Section 3.4. For dense features, we enhance data quality by clipping negative values to zero and applying a logarithmic transformation to reduce skewness. For sparse features, we efficiently handle data by converting hexadecimal strings into decimal values, followed by a positive modulus operation to constrain the range of values. Subsequently, we extract unique feature-index pairs into a vocabulary table according to the appearing sequence, and iterate through the dataset again to map all features to their corresponding indices, which are then utilized to access the trainable embedding tables in the training phase.

2.3 Data Preprocessing Platforms

The selection of preprocessing platforms for recommender systems are essential for efficiently managing large-scale datasets. CPU-based solutions remain prevalent in actual deployments [112, 113], while GPU-based approaches have been explored in research [20, 21, 34, 77, 89].

CPUs offer flexibility for preprocessing tasks and various innovative approaches have been proposed to enhance performance, especially in the data loading stages. We focus on

(A) evolving data loaders and (B) columnar processing in the following two paragraphs.

(A) Frameworks like TensorFlow introduced the *tf.data* API [70] to streamline the training process by offering a robust and scalable framework for constructing efficient and reusable data input pipelines, eliminating the need for users to manually load, preprocess, and feed data to the model. Similarly, PyTorch developed the *DataLoader* and *Dataset* classes [18], facilitating parallelism through multiple workers and supporting asynchronous data loading. Both frameworks have continued to evolve, prioritizing support for streaming datasets and distributed data pipelines. In both cases, and as we do in this paper, hardware specialization has also been proposed for particular use cases, such as TensorFlow’s *tf.image* [46] or PyTorch’s *torchvision* [105] leveraging hardware-accelerated backends for improved performance.

(B) Columnar formats, such as Parquet [106], are highly advantageous for machine learning training, particularly in managing structured data. These formats enable optimized access to specific features. Additionally, columnar formats are well-suited for distributed file systems commonly used in the cloud, including HDFS [96] and Amazon S3 [30]. In our design, we focus as well on columnar formats.

GPUs are highly efficient in both training and inference, due to their exceptional parallel processing capabilities. GPUs can also work for data preprocessing to, for example, allow overlapping data transfer with computation, making the process more efficient overall. For instance, NVIDIA provides GPU-accelerated libraries, such as the Data Loading Library (DALI) [63] for image preprocessing tasks like cropping and resizing, Merlin framework [77] for high-performing recommender systems, or the RAPIDS suite [85] which covers Extract-Transform-Load (ETL) tasks. Furthermore, GPUDirect Storage [93] introduces direct memory transfers between GPUs and storage devices, effectively bypassing the CPU to achieve lower latency. These tools help maximize GPU utilization by moving the preprocessing to the GPU. However, the GPU is now often the critical part of the system and the one in the highest demand. Increasing its utilization in this way may not be the most efficient use of such a scarce and expensive resource. Besides, in Section 4, we show that the performance of GPU for the stateful pipeline drops significantly, whereas PIPER achieves a $3\sim 17\times$ speedup against the acceleration in the GPU for diverse pipelines.

2.4 Training vs. Preprocessing

As pointed out above, most deployed preprocessing pipelines are implemented on CPUs, which are flexible but also comparatively slow and incur additional data movements. It has been shown that existing deployments require many CPUs across several machines to feed the training stages on GPUs [112, 113], where the number of CPUs can only be determined at runtime. Besides, the training techniques on GPUs are still

evolving. For example, utilizing reduced precision like BF16, FP16, FP8 can significantly increase the training throughput in the latest GPU platforms [13, 51, 67, 72, 94]. Consequently, the gap between the performance of preprocessing and training may continue to widen.

Based on these observations, we propose an alternative approach that leverages FPGAs to address the limitations of CPUs and GPUs, such as the latency, scalability and power efficiency. FPGAs benefit from its fully pipelined execution manner, and they are also appealing due to their flexibility in supporting diverse data precisions, such as INT4 or non-regular data types, which is not inherently supported by CPUs [8]. In summary, the proposed design should integrate seamlessly with different memory types to reduce the data movement overhead, deliver preprocessing performance surpassing the training phase, and adapt to evolving pipeline modifications. These goals can be achieved through our dedicated hardware specialization.

3 PIPER: Hardware Accelerated Data Loader

In this section, we describe the architecture of PIPER as currently prototyped on an FPGA. We present the overall design and proceed to introduce the more complex features step by step: (1) the implementation of pipeline operators using device-attached off-chip memory; (2) the support for in-memory preprocessing (IMP) by integrating DMA with the host and in-network preprocessing (INP) through RDMA to access remote nodes; and (3) the introduction of MiniPipe, a fine-grained pipeline unit that facilitates the concurrent execution of multiple pipelines dynamically within a unified memory environment [52, 56, 57].

3.1 Overall Architecture

Many variations of cloud systems exist for ML training. We show typical examples in Figure 3 and compare them with the design of PIPER.

Figure 3a presents the standard platform in which computing nodes, equipped with GPUs, retrieve data from storage nodes, which are equipped with HDDs for storage. In this setup, the CPUs in the storage nodes, which are normally less powerful, handle tasks related to data storage, management, and movement. Conversely, the CPUs in the computing nodes possess higher computational capabilities and larger memory capacity, enabling them to manage data loading and preprocessing effectively. These CPUs benefit from higher clock speeds, which enhance their performance in compute-intensive operations. However, as pointed out before [112, 113], these CPUs are often overloaded and unable to process data quickly enough to fully utilize the computational power of the GPUs, leading to suboptimal GPU utilization.

Figure 3b illustrates the core idea of Meta’s DPP [113] as well as other distributed CPU solutions [2, 38, 39, 102, 112],

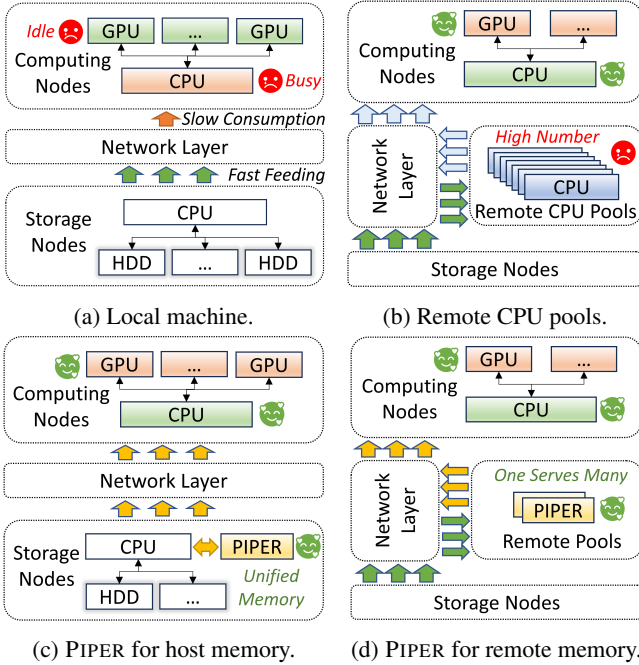

Figure 3: Various configurations for distributed ML training systems where PIPER can work in both in-memory or in-network modes.

in which additional CPU pools are introduced to support preprocessing tasks for the computing nodes. This approach enables the computing nodes to increase performance by using the extra CPUs. It improves utilization of the GPUs, enhancing the overall performance at the cost of extra CPUs.

PIPER can be deployed in two ways. Figure 3c illustrates the deployment of PIPER as part of the storage nodes to implement computational storage. PIPER complements the CPU in the preprocessing tasks, and transmits data through the network layer to the target machine. This design offers the advantage of moving the preprocessing near the data. Figure 3d shows the network-attached version of PIPER, where remote nodes handle the preprocessing tasks, similar to the design of DPP but using the accelerator instead of the CPU. This design leverages a remote pool of PIPER instances rather than concurrently operating a large number of CPUs to function as an intermediate preprocessing layer between storage nodes and computing nodes. This approach achieves high performance, and also provides scalability advantages. Importantly, it can integrate into existing cloud infrastructures based on RDMA networks, ensuring minimal disruption while offering enhanced functionality.

3.2 Data Loading

Memory accesses play a critical role in the performance of ML systems, significantly affecting the speed, scalability, and efficiency of data processing. Efficient memory access con-

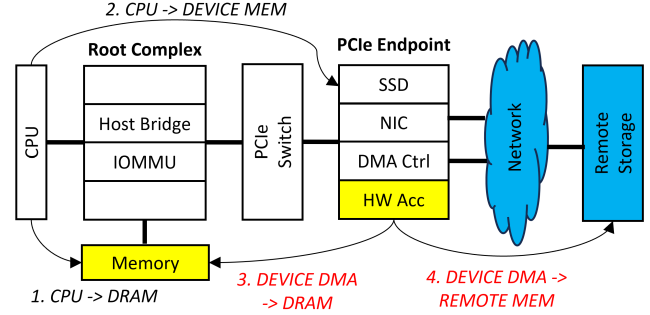

Figure 4: Data access pattern for PCIe-attached hardware accelerator in the host system.

tributes to eliminating unnecessary overhead, especially in scenarios involving large-scale data, real-time operations, and systems that demand high throughput and minimal latency.

However, understanding data access patterns is a non-trivial task. Figure 4 illustrates the data flow architecture utilized by PIPER, showcasing a high-performance system where the CPU can offload compute-intensive tasks to specialized hardware while managing data transfers through PCIe and hierarchical memory structures. On the host side, the CPU can directly access DRAM or interact with PCIe-connected SSDs. PCIe-attached hardware accelerators, such as FPGAs or GPUs, can access local host memory through a DMA controller and extend their reach to remote memory via network interfaces. The integration of remote memory access enhances scalability, enabling utilization beyond local resources, which is particularly advantageous in cloud and data center environments. In the subsequent contents, we will demonstrate the distinct characteristics of accessing various types of memory.

Device-attached Memory. Modern data-center FPGAs are equipped with off-chip memory, such as DDR or HBM, with capacities reaching tens of GB [101]. These advanced memory systems enable high-performance applications, such as DLRM inference [50, 116], to efficiently leverage concurrent multi-channel reading, particularly with the high-throughput capabilities of HBM. Despite these advantages, certain challenges hinder their integration into current ML frameworks. First, the memory capacity remains relatively small when compared to the scale of PB-level datasets. Second, non-pipelined data transfers from the host to the accelerator can be costly. In our experiments, the time required for data transfer is nearly the same as the time it takes to finish preprocessing pipelines.

Host Memory. FPGAs are normally connected to the host system through PCIe, providing an efficient pathway for data transfer. An appealing approach is to directly access the dataset from DRAM in the host side, leveraging its substantial capacity. In server-grade CPUs, the host memory can reach sizes of hundreds of gigabytes, significantly exceeding the capacity of the FPGA off-chip memory. To enable this, the FPGA requires a DMA engine, such as the Xilinx DMA/Bridge Subsystem for PCI Express [33] or Intel PCIe

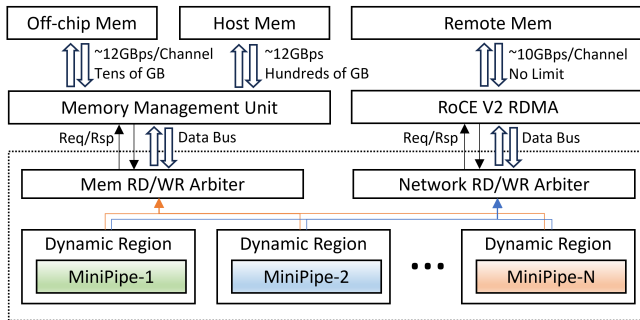

Figure 5: Hierarchical abstractions for memory access.

with DMA IP core [32], which facilitates PCIe communication and handles memory read/write requests. The DMA engine enables high-throughput, streaming data transfers between the host memory and the FPGA dataflow. This kind of configuration presents multiple challenges. First, the PCIe lane bandwidth, typically in the range of tens of GBps, is physically hard to increase. Second, the host memory inherently has size limitations. Alternatively, SSDs could be used as supplementary storage to host DRAM, providing higher capacity at the cost of increased latency and reduced bandwidth [59].

Remote Memory. In modern data centers, storage nodes and computing nodes are often physically separated. This design facilitates greater scalability, which is essential for distributed applications, particularly in ML training. Inspired by this architecture, PIPER leverages remote memory over the network and enables data access across multiple nodes. For the network protocol, RDMA with a custom hardware network stack is an efficient choice [44, 90]. RDMA achieves exceptional throughput by allowing FPGAs to directly access memory on remote systems via optimized network interface, thereby eliminating the overhead of TCP/IP protocols. We will discuss the challenges of this remote design in Section 4, including: (a) significant resource contention when running applications in the same FPGA board, and (b) the processing capability being limited by network throughput.

PIPER supports various memory access patterns, allowing it to be combined with other system components easily. As shown in Figure 3c, PIPER can serve in the storage layer, working in the local mode, similar to Amazon AQUA system [1]. PIPER can also support network-based solution [71], handling data within the network domain, or it works like a SmartNIC, transfers the results to a PCIe-connected device, like GPUs [29, 108] or other accelerators.

3.3 Flexible Pipeline Composition

Hardware-accelerated solutions are often tailored to specific designs, which may pose challenges in adapting to diverse requirements. This perspective raises several important questions, especially when we want to provide a solution that is

user-friendly for software engineers.

- **Q1:** How to support different preprocessing pipelines across clients on a single FPGA?
- **Q2:** How to scale the performance for each pipeline dynamically to meet varying performance requirement?

To address these two challenges, it is crucial to develop a flexible interface with pre-compiled bitstreams rather than recompiling and regenerating them. Given that feature engineering primarily emphasizes columnar processing, PIPER introduces an innovative processing unit to handle columns, called MiniPipe, with a fine-grained granularity of 64 bytes. For Q1 and Q2, conventional methods such as encapsulating code into RTL IP blocks are insufficient, as they necessitate recompilation for new bitstreams, a process that typically requires extensive time ranging from several hours to days. PIPER resolves these two challenges through the application of partial reconfiguration, enabling the concurrent execution of diverse dataflows [53, 57, 66].

Figure 5 shows the interface of PIPER, focusing on its versatile memory access capabilities. For on-device memory storage at the top, PIPER enables access to off-chip memory such as HBM or DDR, supporting multi-channel concurrent access. The access for these memory can be 12 GBps per channel, operating at a 200 MHz clock and a 64-byte wide memory port. The memory capacity can scale to tens of gigabytes, such as 16GB [101]. For the PCIe-attached host, PIPER facilitates a streaming-approach to access host memory [57]. Server-grade CPUs typically contain large DRAM capacities, reaching hundreds of gigabytes. Finally, PIPER supports integration with distributed storage nodes, enabling high-bandwidth access through advanced network topology [30, 78, 96].

Figure 5 highlights additional components of PIPER. (1) To facilitate communication with various memory storage systems, PIPER incorporates a Translation Lookaside Buffer (TLB) that unifies the memory space between the device and the host [57]. Furthermore, PIPER leverages RDMA to enhance network communication capabilities [44, 90]. (2) PIPER employs arbiters to isolate commands directed towards either local or remote memory. The header of each request contains meta-information to streamlined processing. (3) The final layer is the dynamic region, which is a critical component in PIPER. Each dynamic region hosts the implementation of MiniPipe, allowing each board to support multiple regions with concurrent execution. Dynamic regions introduce two key benefits: (a) They ensure the isolation of different applications, enhancing user safety. (b) They enable the dynamic configuration of MiniPipe, offering flexibility to balance performance between I/O and processing capabilities.

3.4 Various Pipeline Operators

The process of feature engineering for recommender systems is an important aspect of ensuring optimal system perfor-

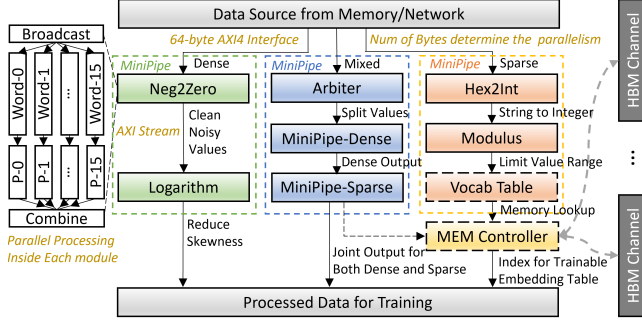

Figure 6: Dataflows for different pipelines.

mance. Figure 6 illustrates the comprehensive dataflow designed to manage diverse pipelines efficiently. To accommodate both dense and sparse features with a unified interface, the data width is set to 64 bytes, enabling PIPER to process multiple values in parallel.

3.4.1 Dense Features

Dense features contain important information across a continuous range. A standard preprocessing pipeline includes operators to clip negative values to zero and apply a logarithmic transformation to reduce skewness.

Neg2Zero. This operation clips negative input dense features to zero while retaining positive values in their original form. PIPER implements this operation using a ternary operator, achieving an Initiation Interval (II) of one cycle.

Logarithm. The logarithmic operation is effective in ML training, as it reduces skewness and manages extremely large values efficiently. PIPER computes the logarithm using a hardware math library, achieving an II of one cycle.

Both operators demonstrate excellent performance with minimal resource utilization. By executing in a pipelined manner, the overall dataflow achieves an II of one cycle.

3.4.2 Sparse Features

The processing of sparse features involves key operations such as converting hexadecimal values to integers and applying a positive modulus to constrain the range of feature values. Besides these stateless operators, maintaining a vocabulary table with a stateful operator plays a crucial role by mapping columns of features to a range of continuous indices, which enables further operations like frequency-based filtering and initialization of lookups in a trainable embedding table.

Hex2Int. Original categorical features are encoded as hexadecimal strings and converting them to integers is the first step. PIPER performs this operation by translating each ASCII code into its binary representation and concatenating these to produce the result. This approach achieves an II of one cycle.

Modulus. The modulus operation is designed to restrict the range of sparse feature values. PIPER realizes this operation with the default math library, achieving an II of one cycle.

VocabGen. Categorical features represent attributes with specific, discrete values, and ML models perform optimally when trained on continuous values [42], making it crucial to create a tailored vocabulary table with unique indices for different columns [22, 80]. Given that dynamic vocabulary tables are frequently updated with new data, ensuring the efficiency of this step is vital for the end-to-end dataflow [91]. PIPER accelerates this process by constructing the vocabulary table in a pipelined manner. It efficiently processes streaming data from upstream modules, extracting unique values in a list, where the length of the list is determined by the range of *Modulus*. The downstream module in PIPER tracks the appearing sequence of occurrences for each unique value, assigns a corresponding index, and stores the value-index pair in memory. The achieved II depends on the memory in use to store value-index pairs, with on-chip memory offering an II of two cycles due to Read-After-Write latency, and off-chip memory achieving an II of approximately six cycles.

VocabMap. The lookup process of mapping each value to its corresponding index makes PIPER iterate over the entire dataset once more, and the final output comprises the corresponding indices in sequence. PIPER achieves this functionality using the pre-generated vocabulary table, reaching an II of approximately six cycles when the table is stored in off-chip memory or one cycle when stored in on-chip memory. This operator represents the final stage in handling sparse features, and II of the overall dataflow is influenced by the memory type used for vocabulary table.

3.5 Implementation

For baselines, we rely on *pandas*, *numpy*, *joblib* to run columnar preprocessing tasks for Parquet in parallel on the CPU, and use *s-tui* [88] to monitor its power consumption. For the execution in GPU, we run with Nvidia Merlin *nvtubular* library, and use *nvidia-smi* to record the power and resource utilization in the GPU.

We use Vitis HLS [45], a high-level synthesis tool for Verilog/VHDL development, to implement the code for the memory interface and the preprocessing operator in PIPER. We use Xilinx XRT [87] to verify the functionality of hardware codes and convert to IP blocks for the next usage. We leverage an open-source FPGA shell, Coyote [57], to facilitate dynamic regions and partial reconfiguration with manual floorplanning. These dynamic regions empower clients to execute diverse preprocessing pipelines concurrently, and PIPER can complete the transition of pipelines within milliseconds. For RDMA communication, we rely on open-source hardware modules [90], which is written in Verilog and can be integrated into Coyote smoothly.

To illustrate the run time configurability, we use Pipeline I to show how to operate different pipelines concurrently. For this purpose, we integrate the generated IP blocks into Coyote, configure the memory interface and dynamic regions,

Table 2: Resource utilization for three pipelines (P-I, P-II, P-III in Section 4.2.1), full duplex RDMA stack, and pipelines with RDMA enabled (R-P-I, R-P-II, R-P-III) in PIPER.

Config	P-I	P-II	P-III	RDMA	R-P-I	R-P-II	R-P-III
CLB	17.6%	21.0%	26.9%	40.6%	44.1%	45.5%	52.4%
BRAM	9.9%	10.0%	24.5%	20.5%	21.3%	21.7%	26.3%
DSP	0.04%	2.3%	2.3%	0.0%	2.3%	2.3%	2.3%

and then complete the compilation flow. Based on an open source duplex RoCE v2 RDMA network protocol [90], PIPER directly accesses data from the remote node and processes it over RDMA data streams. The configured dynamic region efficiently routes incoming data from the network stack, executes the preprocessing pipeline, and writes the processed data to the target position. Table 2 displays the resource utilization for three preprocessing pipelines (local and remote) and RDMA hardware stack. Here we focus on the utilization of CLB, BRAM and DSP while neglecting unused URAM and other resources.

4 Evaluation

We evaluate PIPER to answer these questions:

- I. What is the performance and power consumption of PIPER compared to server-grade CPUs and modern GPUs? § 4.2.1 § 4.2.5
- II. Which operators benefit the most from PIPER? What is the performance difference between stateless and stateful operators? § 4.2.2
- III. How can PIPER be deployed in a cloud environment to scale its throughput dynamically? § 4.2.3

4.1 Experimental Setup

4.1.1 Dataset

We evaluate the effectiveness of PIPER on both real and synthetic datasets. For the real case, we leverage the Criteo Kaggle dataset [19], a well-known public dataset for recommender systems, containing multi-day online advertising data. The dataset is originally stored in UTF-8 format, which introduces additional overhead due to decoding and is targeted for row-based processing. To enhance performance, we extract binary data for memory alignment and verify the data format of each feature. For efficient columnar processing and to focus on the capabilities of preprocessing pipelines, we store the binary data as a Parquet file without compression for software solutions. We compare the speed of data loading and preprocessing to ensure that the data loading process does not become a bottleneck. In this transformation, dense features are represented as floating-point values, and sparse features

are represented as hexadecimal strings. The size of the transformed dataset is 17GB and it includes 45 million entries, consisting of 13 dense features and 26 sparse features. Furthermore, we create a synthetic dataset with 4 million entries to facilitate additional analysis. This synthetic dataset is expanded to include 504 dense features and 42 sparse features, with a size of 11GB [59, 113].

4.1.2 Hardware Platform

We evaluate CPU baseline on a two-socket server with AMD EPYC 7V13 CPU (128 cores, 512GB DRAM). We run GPU experiments in Nvidia A100 (40GB HBM, 12-core CPU, 85GB RAM, 500GB SSD) and RTX 3090 (24GB GDDR6X, 64-core CPU, 252GB RAM, 2TB SSD) respectively. For PIPER, we use Xilinx Alveo U55c equipped with 16GB HBM (32 memory channels, maximum throughput 460GB/s) and 43MB SRAM, and the attached CPU is an AMD EPYC 7302P 16-core Processor. Unless specified, the achieved kernel frequency of PIPER for the different pipelines is 200MHz.

4.1.3 Experiment Configuration

We present the evaluation of three preprocessing pipelines for recommender systems using two datasets, representing different kinds of configurations, including *a stateless pipeline*, *a stateful pipeline with low memory access* and *a stateful pipeline with high memory access*.

- **Pipeline I:** This pipeline processes both dense and sparse features simultaneously, managing stateless operators without vocabulary tables.
- **Pipelines II & III:** These pipelines handle dense and sparse features, incorporating small or large vocabulary tables for sparse features.

4.1.4 CPU Baseline

We have performed several optimizations on the software baseline to minimize unnecessary overheads on the CPU results. To ensure accuracy, we adopt the following steps: First, we perform several warm-up runs before measuring performance, ensuring that the dataset is fully cached into the CPU memory for efficient access. Second, we run each software experiment multiple times and utilize the average value along with variance to comprehensively characterize its performance. Third, prior to analyzing the performance of the entire dataset, Figure 7 illustrates the performance comparison of individual steps in the pipeline for dense and sparse features separately, to better understand the system bottlenecks. Our analysis highlights that loading dense features in floating point format is notably efficient compared to loading sparse features represented as strings. However, a comparison between *Dense* and *Sparse-I*, two pipelines with simple computation for dense and sparse features respectively, reveals a

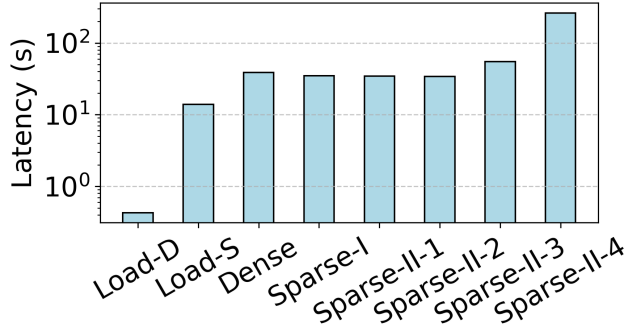

Figure 7: Performance comparison of various pipelines for processing a single column using one thread. The x-axis labels, from left to right, represent the following operations: (1) Loading a dense feature, (2) Loading a sparse feature, (3) A dense feature pipeline with Neg2Zero and Logarithm, (4) A sparse feature pipeline with Hex2Int and Modulus, (5) and (6) Generating a small or large vocabulary table for a sparse feature, (7) and (8) Using a small or large vocabulary table for mapping a sparse feature.

negligible difference in performance. This observation suggests that data loading of a non-compressed Parquet file is not a bottleneck in this CPU baseline. Instead, the preprocessing computation is what determines the overall performance.

Dense & Sparse Features. The CPU can use distinct pipelines to process dense and sparse features designed to suit their specific characteristics. In Figure 7, the performance of handling dense features is represented in the bar marked as *Dense*, where negative values are replaced with zero, followed by the transformation of $\log(x + 1)$. The performance of handling sparse features are tested in *Sparse I* and *Sparse II*. Hexadecimal strings are first converted to integers, then a modulus operation is applied to constrain values within a defined range, and finally values are mapped to indices according to the generated vocabulary table, which tracks the appearing sequence of those unique values. The performance of these operations, especially the unique value extraction for sparse features, relies heavily on the efficiency of memory access to perform lookups, making the pipeline stateful.

Increased Parallelism. The CPU can accelerate its computation through parallel processing of vectorized operations. By assigning tasks across multiple cores, it achieves a significant reduction of the overall execution time. State-of-the-art vectorized operations, supported by libraries like NumPy and Pandas, enable the processing of independent columns.

4.1.5 GPU Baseline

NVIDIA NVTabular is a GPU-accelerated library designed to enhance the preprocessing and feature engineering of large tabular datasets. Leveraging the GPU’s high parallelism and memory bandwidth, NVTabular can efficiently process data in

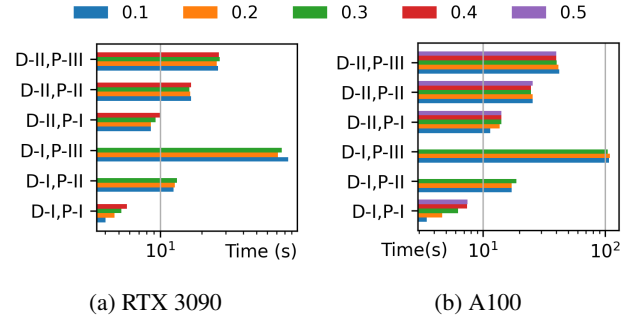

Figure 8: Impact of GPU memory fractions for various preprocessing configurations.

chunks, enabling it to handle datasets that exceed memory limits. It supports a wide range of transformations for both dense and sparse features, such as clipping, logarithmic transformations, modulus, and categorization, using highly optimized GPU kernels. Its columnar processing capability minimizes memory movement and enables parallel execution across columns, making it well-suited for high-performance data workflows in machine learning and deep learning pipelines.

In Figure 8, we illustrate the impact of assigning different fractions of GPU memory for preprocessing tasks on both RTX 3090 and A100 GPUs. Missing values occur due to out-of-memory (OOM) errors in CUDA, particularly with larger memory fractions. For P-I, all configurations achieve the best performance with a small value of fraction. This is because P-I involves stateless and lightweight computations, where smaller chunks provide more granular workloads that are easier to distribute across GPU cores, minimizing idle time and synchronization overhead. In contrast, P-II and P-III involve stateful computations that require storing and accessing intermediate results in GPU memory. This leads to more complex memory access patterns and higher memory bandwidth demands, making performance more sensitive to the allocated memory fraction. We compare the observed results across all configurations and select the optimal one as the baseline for subsequent comparisons with PIPER.

4.2 PIPER: Performance and Efficiency

Multiple factors contribute to a well-designed ML system, such as *flexibility*, *scalability*, *an easy-to-use interface*, etc. We evaluate PIPER to benchmark its performance against CPUs and GPUs, highlighting its significant advantages in low latency for different preprocessing tasks, either stateless or stateful. Our analysis compares the end-to-end performance of PIPER against optimized software baselines, provides a detailed performance breakdown for each operator, and demonstrates the benefits of utilizing PIPER as either a local or network-attached accelerator. We also provide insights about the dynamic scalability of pipelines during runtime to meet diverse I/O requirements.

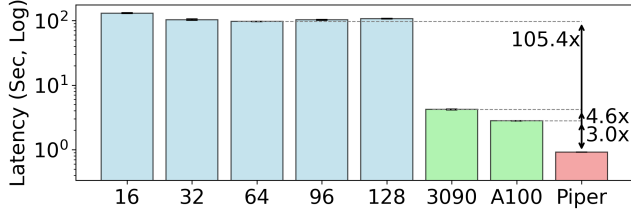

(a) Multi-core CPU (using 16 to 128 cores) vs two GPUs (3090 and A100) vs PIPER.

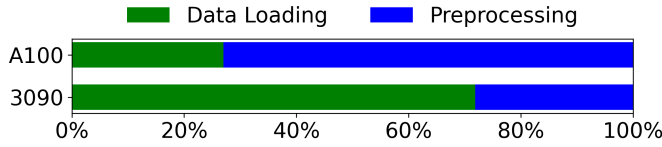

(b) The time breakdown of pipeline execution in the GPU.

Figure 9: The latency analysis of stateless Pipeline I.

4.2.1 End-to-end Performance

Figure 9a presents the results for Pipeline I, which is stateless and benefits the most from increased parallelism. The labels on the left side of the x-axis represent the number of threads utilized by the CPUs, achieving the lowest execution time with 64 threads. When the number of threads increases beyond this, the performance slightly decreases due to complex scheduling mechanisms, highlighting that the parallelism strategy in CPUs may not perfectly align with the requirements of preprocessing engines. The two green bars show the results obtained using high-performance GPUs, the RTX 3090 and the A100. Figure 9b provides a time breakdown of the performance on GPUs, showing that the contribution of data loading and preprocessing varies in different GPUs, yet neither can be overlooked. Compared to software solutions, PIPER achieves superior performance, reaching a $105\times$ improvement over the CPU baseline, and speedups of $4.6\times$ and $3.0\times$ compared to the RTX 3090 and A100, thanks to its fully pipelined execution mechanism.

Figure 10 presents the results for the stateful Pipelines II and III evaluated on two datasets. The data reveals that the

Table 3: Average utilization of resources in GPUs for two datasets (D-I & D-II) and three pipelines (P-I, P-II, P-III).

Configurations	Memory		Compute	
	RTX 3090	A100	RTX 3090	A100
D-I + P-I	10.5%	20.6%	3.8%	10.6%
D-I + P-II	31.5%	36.0%	10.8%	19.1%
D-I + P-III	38.7%	17.5%	21.1%	19.0%
D-II + P-I	7.3%	12.2%	4.2%	14.8%
D-II + P-II	15.1%	15.6%	6.1%	14.2%
D-II + P-III	20.5%	14.1%	5.7%	11.7%

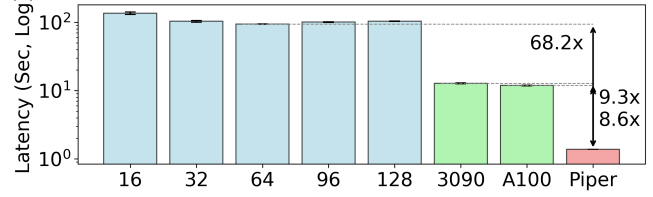

(a) Dataset I + Pipeline II.

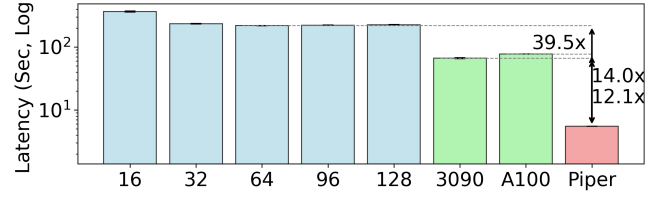

(b) Dataset I + Pipeline III.

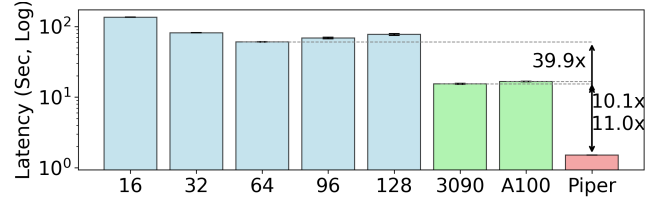

(c) Dataset II + Pipeline II.

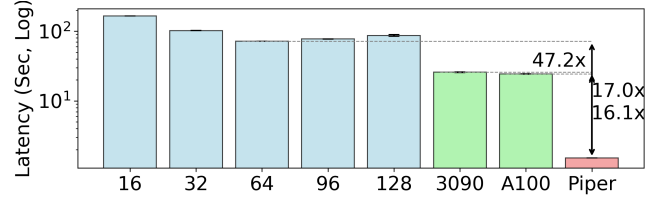

(d) Dataset II + Pipeline III.

Figure 10: The latency comparison of stateful Pipeline II and III in two datasets Dataset I and II in the multi-core CPU, two GPUs and PIPER.

CPU achieves optimal performance with 64 threads across all four configurations. This outcome is primarily attributed to memory contention, as the vocabulary table for multiple columns necessitates concurrent access to DRAM, hindering a better performance. For GPUs, both the RTX 3090 and A100 outperform the multi-threaded CPU, delivering $4\sim 10\times$ acceleration. PIPER demonstrates its advantages in all configurations, achieving over $39\times$ speedup compared to the CPU and over $8\times$ speedup relative to the best GPU. Table 3 summarizes the resource utilization observed during the transformation step in GPU experiments, showing that these preprocessing tasks in GPU are more memory-intensive. Similar to Pipeline I, data loading and fitting also dominates the total execution time in Pipeline II & III, and the proportion of data fitting increases due to the generation of vocabulary table. When comparing with the training performance in Figure 1, it shows that PIPER can be used to provide the preprocessing data for online training for up to thirty A100 GPUs, which

Table 4: Execution time comparison of operators for the full Dataset I (in seconds) across different platforms.

Operators	CPU	RTX 3090	A100	PIPER
Neg2Zero	4.20±0.01	0.029±3E-4	0.043±5E-4	0.23
Logarithm	475.28±2.31	0.01±4E-5	0.015±1E-4	0.23
Hex2Int	410.59±10.45	0.051±2E-3	0.059±1E-4	0.92
Modulus	354.25±2.42	0.017±2E-4	0.026±1E-4	0.46
VocabGen-8K	4.97±0.17	7.57±0.17	8.76±0.037	0.92
VocabMap-8K	21.94±0.13	0.02±1E-3	0.11±1E-3	0.46
VocabGen-512K	549.79±10.20	64.10±2.55	69.03±0.23	2.15
VocabMap-512K	2390.26±10.26	0.015±1E-3	0.11±1E-3	2.96

significantly reduces the system complexity, resource utilization, and energy consumption. When comparing the GPU performance in Figure 9a and 10b, it shows a difference of up to 16× due to the intensive memory access in the latter stateful pipeline, where the overhead of preprocessing is on the same order of magnitude as the training.

4.2.2 Operator Comparison

Table 4 presents a comparative analysis of operator performance across various platforms, evaluated over the entire dataset D-I. In this study, the CPU operates on a single thread, providing a baseline for understanding multi-core solutions.

PIPER shows substantial performance advantages over CPUs for the majority of operators. For instance, PIPER achieves a speedup over 2000× for Logarithm, 450× for Hex2Int, 770× speedup for Modulus. This trend also applies to large-scale vocabulary operations, such as VocabGen-512K and VocabMap-512K, where PIPER achieves speedups of 250× and 800× respectively. These results reveal the exceptional efficiency of PIPER and highlight its potential as an alternative to CPUs for distributed data preprocessing tasks.

GPUs like the RTX 3090 and A100 excel in lightweight tasks like Neg2Zero and Logarithm due to their extensive parallelism, however, PIPER demonstrates its advantages in creating large-scale vocabulary tables. For instance, in VocabGen-512K, PIPER completes the operation in two seconds, significantly outperforming the RTX 3090 and A100, achieving an exceptional 30× speedup. Furthermore, PIPER can run all operations in a fully pipelined manner, which greatly contributes to its end-to-end performance.

4.2.3 Multiple Pipelines

PIPER supports the deployment of independent pipelines on the same device for either higher parallelism or to support different use cases simultaneously. For this, it leverages the dynamic regions provided by Coyote and uses them as wrappers for each pipeline, enabling spatial parallelism. This also provides better scalability. For instance, the Alveo V80 card [103]

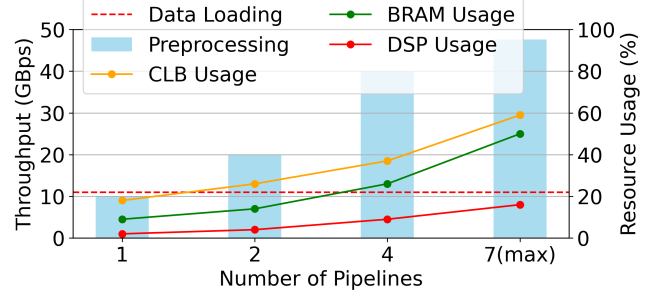

Figure 11: The preprocessing capability can scale almost linearly with the increased number of pipelines at the cost of linearly increased resources.

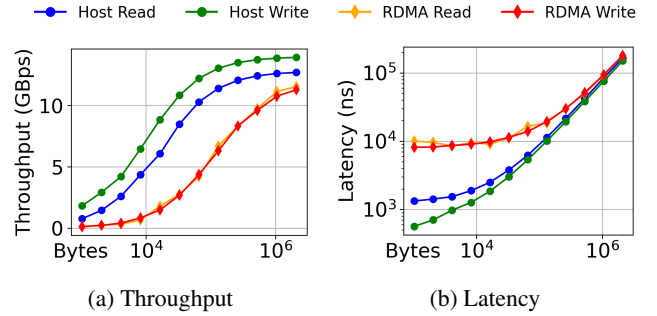

Figure 12: The measurement of throughput and latency to evaluate the data loading speed with the local/remote memory.

supports up to 800 Gbit/s network throughput, which can be exploited by running multiple pipelines in a single board.

We explore such a configuration using Pipeline I with Dataset II, which comprises 504 dense features and 42 sparse features. We deploy different numbers of MiniPipes, 1, 2, 4, or 7, where 7 is the maximum number of dynamic regions possible given the size of the design (limited by the number of AXI streams). Figure 11 shows the maximum achievable throughput against the data loading speed and the resource utilization. The throughput scales linearly when increasing the number of MiniPipes to 4 with a natural nearly linear increase in resources. The existing prototype can run up to 7 MiniPipes concurrently (with the frequency downgraded to 135MHz, which still allows to match the bandwidth available on the networks and the PCIe side, see below).

4.2.4 Data Loading

Many accelerators are bound by data movements for data-intensive applications [36, 110]. PIPER is not different and is currently bound by either the speed of the PCIe connection towards the GPU or/and by the bandwidth of the network supplying the data. Figure 12 compares the data loading speed of a PIPER kernel when accessing both the host memory and receiving data through RDMA. Figure 12a shows the throughput of both reading and writing: when accessing the host

Table 5: The average power consumption for different configurations in the CPU, GPU and PIPER. The static powers for the CPU, RTX 3090, A100 and PIPER are 150W, 33W, 43W, 17W respectively.

Configurations	CPU	RTX 3090	A100	PIPER
D-I + P-I	294W	92W	76W	24W
D-I + P-II	294W	124W	82W	25W
D-I + P-III	313W	143W	78W	26W
D-II + P-I	371W	99W	75W	24W
D-II + P-II	363W	113W	75W	25W
D-II + P-III	379W	119W	76W	26W

memory, the reading speed can reach 14GB/s and the writing 12GB/s; for RDMA access, the maximum achieved throughput is about 11GB/s, matching the available bandwidth on the network. Figure 12b shows the total latency to transfer a given amount of data, which is negligible in the end-to-end training pipeline. These results prove that the design of PIPER can easily saturate the I/O channels, whether PCIe or the network and there is room to spare by deploying multiple pipelines (Figure 11), making the system ready for improvements both on the network as well as on the PCIe side.

4.2.5 Power Efficiency

Table 5 compares the average power consumption across the entire dataset for various configurations. From the table, it is evident that PIPER achieves significantly lower power consumption than other configurations. This also highlights the efficiency of PIPER in reducing energy usage, where energy is calculated as the product of power and execution time. On the GPU side, preprocessing tasks are inherently more lightweight than training tasks, which explains why the GPU does not fully utilize its power capacity. Meta reports that data preprocessing accounts for a substantial portion of the overall power consumption [113], and this observation suggests that optimizing power usage for preprocessing tasks can enable more power to be allocated to the training nodes, thereby enhancing the overall system performance.

5 Related Work

Evolving Preprocessing Service. Modern machine learning frameworks, such as *tf.data* [70] and PyTorch’s *Dataloader* [18], optimize techniques like prefetching and effectively support streaming-like data loading. Researchers have focused on improving preprocessing performance at the software level, primarily on the CPU side [38, 55, 58, 79, 102]. In cloud environments, DPP [113] and GoldMiner [112] highlight distributed solutions for preprocessing tasks within end-to-end training workflows. We use such multi-core CPU based systems as baselines for evaluating the performance of PIPER.

Hardware for Efficient Network. Network devices are extensively deployed in cloud environments [29, 74, 75, 81, 100], playing a crucial role in facilitating efficient communication among nodes. Offloading CPU-intensive tasks, such as compression/decompression/replication/deduplication, to SmartNICs offers a promising solution to enhance the performance of distributed systems [48, 54, 99, 109]. Studies like FairNIC [37] and OSMOSIS [52] thoroughly analyze the multi-tenant capabilities in the network paths. We design and implement PIPER to demonstrate the benefits of integrating preprocessing services within on-path SmartNICs to support the training process.

P2P Communication. The paradigm of Peer-to-Peer (P2P) communication is popular in heterogeneous or distributed systems, where data can exchange directly between peers without passing through a centralized hub. Prior research [6, 97] has implemented GPUDirect RDMA on an FPGA to facilitate direct access to GPU memory, while FpgaNIC [108] further enhances this capability by enabling GPUs to trigger doorbell registers within an FPGA. Industry solutions, such as MangoBoost [31], offer DPU-accelerated NVMe/TCP solutions for communication between disaggregated remote storage systems and GPU servers, achieving near-local SSD performance. In our work, PIPER has shown its advantages for preprocessing tasks with both local and remote memory, and can be further integrated with GPUs or various storage devices to form a more comprehensive cloud system.

MLPerf Benchmark. MLPerf has long served as a widely recognized benchmark for both training and inference tasks [68, 86]. Recently, ML Commons emphasizes the importance of data storage and preprocessing for the overall system efficiency [4]. Traditional hardware-accelerated designs for preprocessing tasks rely on pre-compiled fixed bitstreams and it is hard to scale the performance to adapt to different models [5, 59]. PIPER verifies its functionality to support multiple pipelines encapsulated within dynamic regions, triggering the research of versatile hardware-accelerated preprocessing services for diverse applications.

6 Conclusion

Data loading and preprocessing pipelines are a critical bottleneck in recommender systems due to the performance mismatch between the preprocessing and the training steps. In this paper, we have described PIPER, a network-attached FPGA accelerator tailored to tackle the challenges of online preprocessing for rapidly growing datasets. PIPER demonstrates its ability to serve both stateless and stateful pipelines, highlighting its exceptional advantages in reduced latency and lower power consumption, along with its support for dynamic pipelines. Leveraging PIPER presents opportunities to explore innovative approaches for developing more efficient ML systems that support end-to-end training while optimizing resource utilization and minimizing energy consumption.

References

- [1] Amazon AQUA (Advanced Query Accelerator). <https://aws.amazon.com/blogs/aws/new-aqua-advanced-query-accelerator-for-amazon-redshift/>, 2024.
- [2] Andrew Audibert, Yang Chen, Dan Graur, Ana Klimovic, Jiří Šimša, and A Chandramohan. tf.data service: A case for disaggregating ml input data processing. 2023.
- [3] Youhui Bai, Cheng Li, Zhiqi Lin, Yufei Wu, Youshan Miao, Yunxin Liu, and Yinlong Xu. Efficient data loader for fast sampling-based gnn training on large graphs. *IEEE Transactions on Parallel and Distributed Systems*, 32(10):2541–2556, 2021.
- [4] Oana Balmau. Characterizing i/o in machine learning with mlperf storage. *ACM SIGMOD Record*, 51(3):47–48, 2022.
- [5] Olesia Barkovska, Inna Filippenko, Ivan Semenenko, Valentyn Korniienko, and Peter Sedlaček. Adaptation of fpga architecture for accelerated image preprocessing. *Radioelectronic and Computer Systems*, (2):94–106, 2023.
- [6] Ray Bittner, Erik Ruf, and Alessandro Forin. Direct gpu/fpga communication via pci express. *Cluster Computing*, 17:339–348, 2014.
- [7] Maximilian Böther, Ties Robroek, Viktor Gsteiger, Xianzhe Ma, Pinar Tözün, and Ana Klimovic. Modyn: Data-centric machine learning pipeline orchestration. In *Proceedings of the Conference on Management of Data (SIGMOD)*, 2025.
- [8] Andrew Boutros, Aman Arora, and Vaughn Betz. Field-programmable gate array architecture for deep learning: Survey & future directions. *arXiv preprint arXiv:2404.10076*, 2024.
- [9] Lukas Budach, Moritz Feuerpfeil, Nina Ihde, Andrea Nathansen, Nele Noack, Hendrik Patzlaff, Felix Nauemann, and Hazar Harmouch. The effects of data quality on machine learning performance. *arXiv preprint arXiv:2207.14529*, 2022.
- [10] Weicheng Cai, Jinkun Chen, Jun Zhang, and Ming Li. On-the-fly data loader and utterance-level aggregation for speaker and language recognition. *IEEE/ACM Transactions on Audio, Speech, and Language Processing*, 28:1038–1051, 2020.
- [11] Haihua Chen, Jiangping Chen, and Junhua Ding. Data evaluation and enhancement for quality improvement of machine learning. *IEEE Transactions on Reliability*, 70(2):831–847, 2021.
- [12] Heng-Tze Cheng, Levent Koc, Jeremiah Harmsen, Tal Shaked, Tushar Chandra, Hrishi Aradhye, Glen Anderson, Greg Corrado, Wei Chai, Mustafa Ispir, et al. Wide & deep learning for recommender systems. In *Proceedings of the 1st workshop on deep learning for recommender systems*, pages 7–10, 2016.
- [13] Stefano Cherubin and Giovanni Agosta. Tools for reduced precision computation: a survey. *ACM Computing Surveys (CSUR)*, 53(2):1–35, 2020.
- [14] Jack Choquette. Nvidia hopper h100 gpu: Scaling performance. *IEEE Micro*, 43(3):9–17, 2023.
- [15] Jack Choquette, Wishwesh Gandhi, Olivier Giroux, Nick Stam, and Ronny Krashinsky. Nvidia a100 tensor core gpu: Performance and innovation. *IEEE Micro*, 41(2):29–35, 2021.
- [16] William J Dally, Stephen W Keckler, and David B Kirk. Evolution of the graphics processing unit (gpu). *IEEE Micro*, 41(6):42–51, 2021.
- [17] Scaling data ingestion for machine learning training at Meta. <https://engineering.fb.com/2022/09/19/ml-applications/data-ingestion-machine-learning-training-meta/>, 2022.
- [18] Pytorch Dataloader. https://pytorch.org/tutorials/beginner/basics/data_tutorial.html, 2024.
- [19] Criteo Kaggle Dataset. <https://www.kaggle.com/datasets/mrkmakr/criteo-dataset>, 2024.
- [20] Gabriel de Souza Pereira Moreira, Sara Rabhi, Jeong Min Lee, Ronay Ak, and Even Oldridge. Transformers4rec: Bridging the gap between nlp and sequential/session-based recommendation. In *Proceedings of the 15th ACM conference on recommender systems*, pages 143–153, 2021.
- [21] Chris Deotte, Bo Liu, Benedikt Schifferer, and Gilberto Titericz. Gpu accelerated boosted trees and deep neural networks for better recommender systems. In *Proceedings of the Recommender Systems Challenge 2021*, pages 7–14. 2021.
- [22] Tensorflow DLRM. <https://github.com/tensorflow/models/tree/master/official/recommendation/ranking>, 2024.
- [23] Iddo Drori, Yamuna Krishnamurthy, Remi Rampin, Raoni de Paula Lourenco, Jorge Piazentin Ono, Kyunghyun Cho, Claudio Silva, and Juliana Freire. Alphad3m: Machine learning pipeline synthesis. *arXiv preprint arXiv:2111.02508*, 2021.

- [24] Alex Egg. Online learning for recommendations at grubhub. In *Proceedings of the 15th ACM Conference on Recommender Systems*, pages 569–571, 2021.
- [25] Magdalini Eirinaki, Jerry Gao, Iraklis Varlamis, and Konstantinos Tserpes. Recommender systems for large-scale social networks: A review of challenges and solutions, 2018.
- [26] Assaf Eisenman, Kiran Kumar Matam, Steven Ingram, Dheevatsa Mudigere, Raghuraman Krishnamoorthi, Krishnakumar Nair, Misha Smelyanskiy, and Murali Annavaram. {Check-N-Run}: A checkpointing system for training deep learning recommendation models. In *19th USENIX Symposium on Networked Systems Design and Implementation (NSDI 22)*, pages 929–943, 2022.
- [27] Zhe Fan, Feng Qiu, Arie Kaufman, and Suzanne Yoakum-Stover. Gpu cluster for high performance computing. In *SC'04: Proceedings of the 2004 ACM/IEEE conference on Supercomputing*, pages 47–47. IEEE, 2004.
- [28] Matthias Feurer, Aaron Klein, Katharina Eggenberger, Jost Springenberg, Manuel Blum, and Frank Hutter. Efficient and robust automated machine learning. *Advances in neural information processing systems*, 28, 2015.
- [29] Daniel Firestone, Andrew Putnam, Sambhrama Mundkur, Derek Chiou, Alireza Dabagh, Mike Andrewartha, Hari Angepat, Vivek Bhanu, Adrian Caulfield, Eric Chung, et al. Azure accelerated networking: Smartnics in the public cloud. In *15th {USENIX} Symposium on Networked Systems Design and Implementation ({NSDI} 18)*, pages 51–66, 2018.
- [30] Amazon S3 for Cloud Storage. <https://aws.amazon.com/s3/>, 2024.
- [31] MangoBoost for MLPerf Storage. <https://www.mangoboost.io/resources/blog/mangoboost-demonstrates-turn-key-storage-solution-for-ai-training-with-mlperf-r-storage-v1-0>, 2024.
- [32] Intel Multichannel DMA Intel FPGA IP for PCI Express. <https://www.intel.com/content/www/us/en/products/details/fpga/intellectual-property/interface-protocols/multichannel-dma-mcdma.html>, 2024.
- [33] Xilinx DMA/Bridge Subsystem for PCI Express v4.1. https://www.amd.com/content/dam/xilinx/support/documents/ip_documentation/xdma/v4_1/pg195-pcie-dma.pdf, 2024.
- [34] Accelerating ETL for Recommender Systems on NVIDIA GPUs with NVTabular. <https://developer.nvidia.com/blog/accelerating-etl-for-recsys-on-gpus-with-nvtabular/>, 2020.
- [35] Antonino Freno. Practical lessons from developing a large-scale recommender system at zalando. In *Proceedings of the eleventh ACM conference on recommender systems*, pages 251–259, 2017.
- [36] Mingyu Gao, Grant Ayers, and Christos Kozyrakis. Practical near-data processing for in-memory analytics frameworks. In *2015 International Conference on Parallel Architecture and Compilation (PACT)*, pages 113–124. IEEE, 2015.
- [37] Stewart Grant, Anil Yelam, Maxwell Bland, and Alex C Snoeren. Smartnic performance isolation with fairnic: Programmable networking for the cloud. In *Proceedings of the Annual conference of the ACM Special Interest Group on Data Communication on the applications, technologies, architectures, and protocols for computer communication*, pages 681–693, 2020.
- [38] Dan Graur, Damien Aymon, Dan Kluser, Tanguy Albrici, Chandramohan A Thekkath, and Ana Klimovic. Cachew: Machine learning input data processing as a service. In *2022 USENIX Annual Technical Conference (USENIX ATC 22)*, pages 689–706, 2022.
- [39] Dan Graur, Oto Mraz, Muyu Li, Sepehr Pourghanad, Chandramohan A Thekkath, and Ana Klimovic. Pecan: {Cost-Efficient}{ML} data preprocessing with automatic transformation ordering and hybrid placement. In *2024 USENIX Annual Technical Conference (USENIX ATC 24)*, pages 649–665, 2024.
- [40] Hongbo Guo, Ruben Naeff, Alex Nikulkov, and Zheqing Zhu. Evaluating online bandit exploration in large-scale recommender system. *arXiv preprint arXiv:2304.02572*, 2023.
- [41] Udit Gupta, Carole-Jean Wu, Xiaodong Wang, Maxim Naumov, Brandon Reagen, David Brooks, Bradford Cottel, Kim Hazelwood, Mark Hempstead, Bill Jia, et al. The architectural implications of facebook’s dnn-based personalized recommendation. In *2020 IEEE International Symposium on High Performance Computer Architecture (HPCA)*, pages 488–501. IEEE, 2020.
- [42] John T Hancock and Taghi M Khoshgoftaar. Survey on categorical data for neural networks. *Journal of big data*, 7(1):28, 2020.

- [43] Xin He, Kaiyong Zhao, and Xiaowen Chu. Automl: A survey of the state-of-the-art. *Knowledge-based systems*, 212:106622, 2021.
- [44] Zhenhao He, Dario Korolija, Yu Zhu, Benjamin Ramhorst, Tristan Laan, Lucian Petrica, Michaela Blott, and Gustavo Alonso. {ACCL+}: an {FPGA-Based} collective engine for distributed applications. In *18th USENIX Symposium on Operating Systems Design and Implementation (OSDI 24)*, pages 211–231, 2024.
- [45] Xilinx Vitis HLS. <https://www.amd.com/en/products/software/adaptive-socs-and-fpgas/vitis/vitis-hls.html>, 2024.
- [46] Tensorflow Image. https://www.tensorflow.org/api_docs/python/tf/image, 2024.
- [47] Abhinav Jain, Hima Patel, Lokesh Nagalapatti, Nitin Gupta, Sameep Mehta, Shanmukha Guttula, Shashank Mujumdar, Shazia Afzal, Ruhi Sharma Mittal, and Vitobha Munigala. Overview and importance of data quality for machine learning tasks. In *Proceedings of the 26th ACM SIGKDD international conference on knowledge discovery & data mining*, pages 3561–3562, 2020.
- [48] Houxiang Ji, Mark Mansi, Yan Sun, Yifan Yuan, Jinghan Huang, Reese Kuper, Michael M Swift, and Nam Sung Kim. {STYX}: Exploiting {SmartNIC} capability to reduce datacenter memory tax. In *2023 USENIX Annual Technical Conference (USENIX ATC 23)*, pages 619–633, 2023.
- [49] Danlin Jia, Geng Yuan, Xue Lin, and Ningfang Mi. A data-loader tunable knob to shorten gpu idleness for distributed deep learning. In *2022 IEEE 15th International Conference on Cloud Computing (CLOUD)*, pages 449–458. IEEE, 2022.
- [50] Wenqi Jiang, Zhenhao He, Shuai Zhang, Thomas B Preußer, Kai Zeng, Liang Feng, Jiansong Zhang, Tongxuan Liu, Yong Li, Jingren Zhou, et al. Microrec: efficient recommendation inference by hardware and data structure solutions. *Proceedings of Machine Learning and Systems*, 3:845–859, 2021.
- [51] Dhiraj Kalamkar, Dheevatsa Mudigere, Naveen Mellempudi, Dipankar Das, Kunal Banerjee, Sasikanth Avancha, Dharma Teja Vooturi, Nataraj Jammalamadaka, Jianyu Huang, Hector Yuen, et al. A study of bfloat16 for deep learning training. *arXiv preprint arXiv:1905.12322*, 2019.
- [52] Mikhail Khalilov, Marcin Chrapek, Siyuan Shen, Alessandro Vezzu, Thomas Benz, Salvatore Di Girolamo, Timo Schneider, Daniele De Sensi, Luca Benini, and Torsten Hoefer. {OSMOSIS}: Enabling {Multi-Tenancy} in datacenter {SmartNICs}. In *2024 USENIX Annual Technical Conference (USENIX ATC 24)*, pages 247–263, 2024.
- [53] Ahmed Khawaja, Joshua Landgraf, Rohith Prakash, Michael Wei, Eric Schkufza, and Christopher J Rossbach. Sharing, protection, and compatibility for reconfigurable fabric with {AmorphOS}. In *13th USENIX Symposium on Operating Systems Design and Implementation (OSDI 18)*, pages 107–127, 2018.
- [54] Jongyul Kim, Insu Jang, Waleed Reda, Jaeseong Im, Marco Canini, Dejan Kostić, Youngjin Kwon, Simon Peter, and Emmett Witchel. Linefs: Efficient smartnic offload of a distributed file system with pipeline parallelism. In *Proceedings of the ACM SIGOPS 28th Symposium on Operating Systems Principles*, pages 756–771, 2021.
- [55] Taeyoon Kim, ChanHo Park, Mansur Mukimbekov, Heelim Hong, Minseok Kim, Ze Jin, Changdae Kim, Ji-Yong Shin, and Myeongjae Jeon. Fusionflow: Accelerating data preprocessing for machine learning with cpu-gpu cooperation. *Proceedings of the VLDB Endowment*, 17(4):863–876, 2023.
- [56] Dario Korolija, Dimitrios Koutsoukos, Kimberly Keeton, Konstantin Taranov, Dejan Milojević, and Gustavo Alonso. Farview: Disaggregated memory with operator off-loading for database engines. *arXiv preprint arXiv:2106.07102*, 2021.
- [57] Dario Korolija, Timothy Roscoe, and Gustavo Alonso. Do {OS} abstractions make sense on {FPGAs}? In *14th USENIX Symposium on Operating Systems Design and Implementation (OSDI 20)*, pages 991–1010, 2020.
- [58] Michael Kuchnik, Ana Klimovic, Jiri Simsa, Virginia Smith, and George Amvrosiadis. Plumber: Diagnosing and removing performance bottlenecks in machine learning data pipelines. *Proceedings of Machine Learning and Systems*, 4:33–51, 2022.
- [59] Yunjae Lee, Hyeseong Kim, and Minsoo Rhu. Presto: An in-storage data preprocessing system for training recommendation models. In *2024 ACM/IEEE 51st Annual International Symposium on Computer Architecture (ISCA)*, pages 340–353. IEEE, 2024.
- [60] Adam Lerer, Ledell Wu, Jiajun Shen, Timothee Lacroix, Luca Wehrstedt, Abhijit Bose, and Alex Peysakhovich. Pytorch-biggraph: A large scale graph

- embedding system. *Proceedings of Machine Learning and Systems*, 1:120–131, 2019.
- [61] Peng Li, Xi Rao, Jennifer Blase, Yue Zhang, Xu Chu, and Ce Zhang. Cleanml: A study for evaluating the impact of data cleaning on ml classification tasks. In *2021 IEEE 37th International Conference on Data Engineering (ICDE)*, pages 13–24. IEEE, 2021.
- [62] Yang Li, Yu Shen, Wentao Zhang, Ce Zhang, and Bin Cui. Volcanoml: speeding up end-to-end automl via scalable search space decomposition. *The VLDB Journal*, 32(2):389–413, 2023.
- [63] Nvidia Data Loading Library. <https://github.com/NVIDIA/DALI/tree/main/dali/pipeline>, 2024.
- [64] Zhuoran Liu, Leqi Zou, Xuan Zou, Caihua Wang, Biao Zhang, Da Tang, Bolin Zhu, Yijie Zhu, Peng Wu, Ke Wang, et al. Monolith: real time recommendation system with collisionless embedding table. *RecSys*, 2022.
- [65] Lucy Ellen Lwakatare, Aiswarya Raj, Ivica Crnkovic, Jan Bosch, and Helena Holmström Olsson. Large-scale machine learning systems in real-world industrial settings: A review of challenges and solutions. *Information and software technology*, 127:106368, 2020.
- [66] Jiacheng Ma, Gefei Zuo, Kevin Loughlin, Xiaohu Cheng, Yanqiang Liu, Abel Mulugeta Eneyew, Zhengwei Qi, and Baris Kasikci. A hypervisor for shared-memory fpga platforms. In *Proceedings of the Twenty-Fifth International Conference on Architectural Support for Programming Languages and Operating Systems*, pages 827–844, 2020.
- [67] Stefano Markidis, Steven Wei Der Chien, Erwin Laure, Ivy Bo Peng, and Jeffrey S Vetter. Nvidia tensor core programmability, performance & precision. In *2018 IEEE international parallel and distributed processing symposium workshops (IPDPSW)*, pages 522–531. IEEE, 2018.
- [68] Peter Mattson, Christine Cheng, Gregory Diamos, Cody Coleman, Paulius Micikevicius, David Patterson, Hanlin Tang, Gu-Yeon Wei, Peter Bailis, Victor Bittorf, et al. Mlperf training benchmark. *Proceedings of Machine Learning and Systems*, 2:336–349, 2020.
- [69] Dheevatsa Mudigere, Yuchen Hao, Jianyu Huang, Zhihao Jia, Andrew Tulloch, Srinivas Sridharan, Xing Liu, Mustafa Ozdal, Jade Nie, Jongsoo Park, et al. Software-hardware co-design for fast and scalable training of deep learning recommendation models. In *Proceedings of the 49th Annual International Symposium on Computer Architecture*, pages 993–1011, 2022.
- [70] Derek G Murray, Jiri Simsa, Ana Klimovic, and Ihor Indyk. tf.data: A machine learning data processing framework. *arXiv preprint arXiv:2101.12127*, 2021.
- [71] Craig Mustard, Fabian Ruffy, Anny Gakhokidze, Ivan Beschastnikh, and Alexandra Fedorova. Jumpgate: {In-Network} processing as a service for data analytics. In *11th USENIX Workshop on Hot Topics in Cloud Computing (HotCloud 19)*, 2019.
- [72] SR Nandakumar, Manuel Le Gallo, Irem Boybat, Bipin Rajendran, Abu Sebastian, and Evangelos Eleftheriou. Mixed-precision architecture based on computational memory for training deep neural networks. In *2018 IEEE International Symposium on Circuits and Systems (ISCAS)*, pages 1–5. IEEE, 2018.
- [73] Maxim Naumov, Dheevatsa Mudigere, Hao-Jun Michael Shi, Jianyu Huang, Narayanan Sundaraman, Jongsoo Park, Xiaodong Wang, Udit Gupta, Carole-Jean Wu, Alisson G Azzolini, et al. Deep learning recommendation model for personalization and recommendation systems. *arXiv preprint arXiv:1906.00091*, 2019.
- [74] AMD Pensando Networking. <https://www.amd.com/en/products/accelerators/pensando.html>, 2024.
- [75] Nvidia ConnexX NICs. <https://www.nvidia.com/en-us/networking/ethernet-adapters/>, 2024.
- [76] Iason Ofeidis, Diego Kiedanski, and Leandros Tassioulas. An overview of the data-loader landscape: Comparative performance analysis. *arXiv preprint arXiv:2209.13705*, 2022.
- [77] Even Oldridge, Julio Perez, Ben Frederickson, Nicolas Koumchatzky, Minseok Lee, Zehuan Wang, Lei Wu, Fan Yu, Rick Zamora, Onur Yilmaz, et al. Merlin: a gpu accelerated recommendation framework. In *Proceedings of IRS*, 2020.
- [78] Satadru Pan, Theano Stavrinou, Yunqiao Zhang, Atul Sikaria, Pavel Zakharov, Abhinav Sharma, Mike Shuey, Richard Wareing, Monika Gangapuram, Guanglei Cao, et al. Facebook’s tectonic filesystem: Efficiency from exascale. In *19th USENIX Conference on File and Storage Technologies (FAST 21)*, pages 217–231, 2021.
- [79] Arnab Phani, Lukas Erlbacher, and Matthias Boehm. Uplift: parallelization strategies for feature transformations in machine learning workloads. *Proceedings of the VLDB Endowment*, 15(11):2929–2938, 2022.
- [80] Meta’s DLRM Preprocessing Pipeline. <https://github.com/facebookresearch/dlrm>, 2024.

- [81] Nvidia Bluefield Networking Platform. <https://www.nvidia.com/en-us/networking/products/data-processing-unit/>, 2024.
- [82] Danrui Qi, Jinglin Peng, Yongjun He, and Jiannan Wang. Auto-fp: An experimental study of automated feature preprocessing for tabular data. *arXiv preprint arXiv:2310.02540*, 2023.
- [83] Ziheng Qin, Zhaopan Xu, Yukun Zhou, Zangwei Zheng, Zebang Cheng, Hao Tang, Lei Shang, Baigui Sun, Xiaojiang Peng, Radu Timofte, Hongxun Yao, Kai Wang, and Yang You. Dataset growth. In *ECCV*, 2024.
- [84] Sergio Ramírez-Gallego, Bartosz Krawczyk, Salvador García, Michał Woźniak, and Francisco Herrera. A survey on data preprocessing for data stream mining: Current status and future directions. *Neurocomputing*, 239:39–57, 2017.
- [85] Nvidia Rapids. <https://developer.nvidia.com/rapids>, 2024.
- [86] Vijay Janapa Reddi, Christine Cheng, David Kanter, Peter Mattson, Guenther Schmuelling, Carole-Jean Wu, Brian Anderson, Maximilien Breughe, Mark Charlebois, William Chou, et al. Mlperf inference benchmark. In *2020 ACM/IEEE 47th Annual International Symposium on Computer Architecture (ISCA)*, pages 446–459. IEEE, 2020.
- [87] Xilinx Runtime. <https://xilinx.github.io/XRT/master/html/index.html>, 2024.
- [88] The Stress Terminal UI: s tui. <https://github.com/amanusk/s-tui>, 2024.
- [89] Benedikt Schifferer, Chris Deotte, and Even Oldridge. Tutorial: feature engineering for recommender systems. In *Proceedings of the 14th ACM Conference on Recommender Systems*, pages 754–755, 2020.
- [90] David Sidler, Zeke Wang, Monica Chiosa, Amit Kulकर्णी, and Gustavo Alonso. Strom: smart remote memory. In *Proceedings of the Fifteenth European Conference on Computer Systems*, pages 1–16, 2020.
- [91] Chijun Sima, Yao Fu, Man-Kit Sit, Liyi Guo, Xuri Gong, Feng Lin, Junyu Wu, Yongsheng Li, Haidong Rong, Pierre-Louis Aublin, et al. Ekko: A {Large-Scale} deep learning recommender system with {Low-Latency} model update. In *16th USENIX Symposium on Operating Systems Design and Implementation (OSDI 22)*, pages 821–839, 2022.
- [92] Linqi Song, Cem Tekin, and Mihaela Van Der Schaar. Online learning in large-scale contextual recommender systems. *IEEE Transactions on Services Computing*, 9(3):433–445, 2014.
- [93] Nvidia GPUDirect Storage. <https://developer.nvidia.com/blog/gpudirect-storage/>, 2024.
- [94] Xiao Sun, Jungwook Choi, Chia-Yu Chen, Naigang Wang, Swagath Venkataramani, Vijayalakshmi Viji Srinivasan, Xiaodong Cui, Wei Zhang, and Kailash Gopalakrishnan. Hybrid 8-bit floating point (hfp8) training and inference for deep neural networks. *Advances in neural information processing systems*, 32, 2019.
- [95] Ivan Svogor, Christian Eichenberger, Markus Spanring, Moritz Neun, and Michael Kopp. Profiling and improving the pytorch dataloader for high-latency storage: A technical report. *arXiv preprint arXiv:2211.04908*, 2022.
- [96] Apache Hadoop Distributed File System. <https://hadoop.apache.org/>, 2024.
- [97] Yann Thoma, Alberto Dassatti, and Daniel Molla. Fpga 2: An open source framework for fpga-gpu pcie communication. In *2013 international conference on reconfigurable computing and FPGAs (ReConFig)*, pages 1–6. IEEE, 2013.
- [98] Ajay Tirumala and Raymond Wong. Nvidia blackwell platform: Advancing generative ai and accelerated computing. In *2024 IEEE Hot Chips 36 Symposium (HCS)*, pages 1–33. IEEE Computer Society, 2024.
- [99] Maroun Tork, Lina Maudlej, and Mark Silberstein. Lynx: A smartnic-driven accelerator-centric architecture for network servers. In *Proceedings of the Twenty-Fifth International Conference on Architectural Support for Programming Languages and Operating Systems*, pages 117–131, 2020.
- [100] Xilinx Alveo U25. <https://www.xilinx.com/publications/product-briefs/alveo-u25-product-brief.pdf>, 2024.
- [101] Xilinx Alveo U55c. <https://www.amd.com/en/products/accelerators/alveo/u55c/a-u55c-p00g-pq-g.html>, 2024.
- [102] Taegeon Um, Byungsoo Oh, Byeongchan Seo, Minhyeok Kweun, Goeun Kim, and Woo-Yeon Lee. Fast-flow: Accelerating deep learning model training with smart offloading of input data pipeline. *Proceedings of the VLDB Endowment*, 16(5):1086–1099, 2023.
- [103] Xilinx Alveo V80. <https://www.amd.com/en/products/accelerators/alveo/v80.html>, 2024.
- [104] Pablo Villalobos, Jaime Sevilla, Lennart Heim, Tamay Besiroglu, Marius Hobbhahn, and Anson Ho. Will

we run out of data? an analysis of the limits of scaling datasets in machine learning. *arXiv preprint arXiv:2211.04325*, 1, 2022.

- [105] Torch Vision. <https://pytorch.org/vision/stable/index.html>, 2024.
- [106] Deepak Vohra and Deepak Vohra. Apache parquet. *Practical Hadoop Ecosystem: A Definitive Guide to Hadoop-Related Frameworks and Tools*, pages 325–335, 2016.
- [107] Meng Wang, Weijie Fu, Xiangnan He, Shijie Hao, and Xindong Wu. A survey on large-scale machine learning. *IEEE Transactions on Knowledge and Data Engineering*, 34(6):2574–2594, 2020.
- [108] Zeke Wang, Hongjing Huang, Jie Zhang, Fei Wu, and Gustavo Alonso. Fpganic: An fpga-based versatile 100gb smartnic for gpus. In *2022 USENIX Annual Technical Conference (ATC)*, 2022.
- [109] Xingda Wei, Rongxin Cheng, Yuhan Yang, Rong Chen, and Haibo Chen. Characterizing off-path {SmartNIC} for accelerating distributed systems. In *17th USENIX Symposium on Operating Systems Design and Implementation (OSDI 23)*, pages 987–1004, 2023.
- [110] Bowen Wu, Dimitrios Koutsoukos, and Gustavo Alonso. Efficiently processing large relational joins on gpus. *arXiv preprint arXiv:2312.00720*, 2023.
- [111] Qizhen Zhang, Yifan Cai, Xinyi Chen, Sebastian Angel, Ang Chen, Vincent Liu, and Boon Thau Loo. Understanding the effect of data center resource disaggregation on production dbms. *Proceedings of the VLDB Endowment*, 13(9), 2020.
- [112] Hanyu Zhao, Zhi Yang, Yu Cheng, Chao Tian, Shiru Ren, Wencong Xiao, Man Yuan, Langshi Chen, Kaibo Liu, Yang Zhang, et al. Goldminer: Elastic scaling of training data pre-processing pipelines for deep learning. *Proceedings of the ACM on Management of Data*, 1(2):1–25, 2023.
- [113] Mark Zhao, Niket Agarwal, Aarti Basant, Buğra Gedik, Satadru Pan, Mustafa Ozdal, Rakesh Komuravelli, Jerry Pan, Tianshu Bao, Haowei Lu, et al. Understanding data storage and ingestion for large-scale deep recommendation model training: Industrial product. In *Proceedings of the 49th Annual International Symposium on Computer Architecture*, pages 1042–1057, 2022.
- [114] Xiangyu Zhao, Maolin Wang, Xinjian Zhao, Jiansheng Li, Shucheng Zhou, Dawei Yin, Qing Li, Jiliang Tang, and Ruocheng Guo. Embedding in recommender systems: A survey. *arXiv preprint arXiv:2310.18608*, 2023.
- [115] Chang Zhou, Jianxin Ma, Jianwei Zhang, Jingren Zhou, and Hongxia Yang. Contrastive learning for debiased candidate generation in large-scale recommender systems. In *Proceedings of the 27th ACM SIGKDD Conference on Knowledge Discovery & Data Mining*, pages 3985–3995, 2021.
- [116] Yu Zhu, Zhenhao He, Wenqi Jiang, Kai Zeng, Jingren Zhou, and Gustavo Alonso. Distributed recommendation inference on fpga clusters. In *2021 31st International Conference on Field-Programmable Logic and Applications (FPL)*, pages 279–285. IEEE, 2021.
- [117] Mahdi Zolnouri, Xinlin Li, and Vahid Partovi Nia. Importance of data loading pipeline in training deep neural networks. *arXiv preprint arXiv:2005.02130*, 2020.