

Boosting the Accuracy of Stock Market Prediction via Multi-Layer Hybrid MTL Structure

Yuxi Hong

School of Economics and Management, Harbin Institute of Technology
Weihai 264209, China

2022210917@stu.hit.edu.cn

Abstract

Accurate stock market prediction provides great opportunities for informed decision-making, yet existing methods struggle with financial data's non-linear, high-dimensional, and volatile characteristics. Advanced predictive models are needed to effectively address these complexities. This paper proposes a novel multi-layer hybrid multi-task learning (MTL) framework aimed at achieving more efficient stock market predictions. It involves a Transformer encoder to extract complex correspondences between various input features, a Bidirectional Gated Recurrent Unit (Bi-GRU) to capture long-term temporal relationships, and a Kolmogorov-Arnold Network (KAN) to enhance the learning process. Experimental evaluations indicate that the proposed learning structure achieves great performance, with an MAE as low as 1.078, a MAPE as low as 0.012, and an R^2 as high as 0.98, when compared with other competitive networks.

1. Introduction

Accurate stock market prediction has long been a central focus in financial research [1]. For investors, precise forecasts provide critical insights for investment strategies, while for corporations, they enable effective capital allocation and strategic planning. Stock price data, characterized as complex, non-stationary, and non-linear time series with substantial noise, present a significant challenge for predictive modeling [2].

Early methods, including ARMA [3], ARIMA [4], and GARCH [5], primarily relied on historical price data and traditional statistical frameworks. However, these models exhibit limited performance with non-linear, non-stationary financial data and often require manual hyperparameter tuning, leading to suboptimal real-world predictions [6]. With the rise of artificial intelligence, the development of prediction models has shifted from basic statistical methods to

complex machine learning techniques. Verified by scholars, the accuracy of machine learning technology to predict stocks is significantly better than traditional ones [7].

With the advancement of computing power and data analysis methods, deep learning technology has deepened the number of hidden layers on the basis of neural networks. Multi-layer artificial neural networks can be used to approximate any nonlinear function. In stock market data prediction, it shows stronger learning and generalization ability than traditional machine learning [8]. The convolution neural networks [9], recurrent neural network [10] and variant models [11] have gradually received extensive attention in stock market price and return forecasting.

Nonetheless, conventional stock forecasting techniques primarily analyze individual stock time series in isolation, thereby overlooking the intricate relationships between different stocks. Empirical evidence suggests that integrating the 'spatial' dimension, which encompasses the relational information among stocks, can significantly enhance the predictive accuracy of models [12].

To achieve more accurate stock market predictions, it is crucial to consider the relationships between stocks. Indeed, a limited number of studies have employed graph neural network (GNN) methods to learn the impact of pairwise relationships on stock price prediction [13]. However, in the real market, the relationships between different stocks are often more complex than simple pairwise interactions.

Transformer models, leveraging their attention mechanism, excel at capturing complex relationships across multi-source data, making them ideal for stock prediction by understanding long-term dependencies and multidimensional features [14]. The self-attention mechanism is computationally expensive, especially for large datasets or long time series. Moreover, Transformers lack inductive bias for time-series data, making them less effective at capturing seasonality and trends inherent in financial data. Additionally, they struggle with very long sequences and high-dimensional data. [15].

To address these limitations, KAN (Knowledge-

Augmented Network) replaces traditional weight parameters with edge function parameters, improving the approximation of nonlinear functions. Its fine-grained node adjustments enable better handling of complex, high-dimensional stock data, significantly enhancing prediction accuracy.

Ensemble learning is a crucial method for improving prediction accuracy [16–18]. In the field of financial forecasting, ensemble learning has demonstrated increasingly significant advantages [19, 20]. Our algorithm can serve as a component within an ensemble learning framework to further enhance prediction precision.

Based on the above, we propose a multi-layer hybrid multi-task learning structure. The main contributions of our work are listed as follows:

- The paper introduces a new multi-layer hybrid MTL framework designed to achieve more efficient stock market predictions by addressing the non-linear, high-dimensional, and volatile characteristics of financial data. It combines the strengths of different layers, including a Transformer encoder, BiGRU, and KAN, to enhance overall predictive performance.
- The method can simultaneously extract the coupling relationship between different channel data and capture the strong correspondence in time series, so as to achieve joint optimization of all prediction tasks.
- The framework uses a Transformer encoder to extract complex correspondences among various input features, enabling the model to capture deeper associations within multidimensional data. It employs a BiGRU to capture long-term temporal relationships and a KAN to augment the learning process, resulting in superior performance at the metrics of MAE, MAPE and R^2 .

2. Related Work

Predicting stock market trends has long been of significant interest to both academics and practitioners due to its profound financial implications. The literature on stock market forecasting encompasses a wide array of methods, ranging from traditional statistical approaches to advanced machine learning models and hybrid systems that combine multiple techniques. Traditional methods have historically dominated the field. However, with the advent of sophisticated machine learning algorithms, including neural networks and deep learning architectures, there has been a shift towards more complex and adaptive predictive models. Furthermore, hybrid models that integrate the strengths of both traditional and modern techniques have emerged as promising solutions, offering enhanced accuracy and robustness in dynamic environments.

2.1. Traditional Methods

Traditional methods for addressing the problem of stock market forecasting can be categorized into traditional time series models and hidden Markov models. Regarding traditional time series models, Devi et al. [21] collected stock data spanning the past five years and, for the first time, utilized ARIMA models with varying parameters to predict future market trends. Khandarwal et al. [22] noted that the ARIMA model holds potential for satisfactory short-term stock price prediction. Marisetty et al. [23] employed a series of GARCH models to analyze the volatility dynamics of five major global financial indices over a decade, concluding that the GARCH model is the preferred choice for volatility prediction. Among hidden Markov models, a notable contribution is the work of Gupta et al. [24] who proposed a Maximum A Posteriori (MAP) estimator based on Hidden Markov Models (HMM) to predict the next day’s stock values using historical data. Their study concluded that this model exhibited higher performance compared to ARIMA and ANN models. Su et al. [25] further extended the HMM framework by adapting it from a discrete to a continuous form, essentially proposing a model for predicting stock price trends. Since these traditional statistical methods are fundamentally linear, they may hinder prediction performance in challenge scenarios involving sudden fluctuations in stock prices. Recent research efforts have focused on optimizing these traditional methods. For instance, Mattera et al. [26] introduced a dynamic network autoregressive conditional heteroskedasticity (ARCH) model, which greatly addresses the limitation that multivariate ARCH models are generally unsuitable for high-dimensional input data, thereby enhancing their total stock prediction accuracy.

2.2. Machine Learning Networks

In the current era of artificial intelligence, machine learning plays a relevant role in the prediction of time series. Through a comparative analysis of traditional methods and machine learning approaches, Bhattacharjee et al. [27] concluded that machine learning methods, particularly neural network models, exhibit the highest accuracy in stock price prediction. Vijn et al. [28] utilized artificial neural networks and random forest techniques to forecast the next day’s closing prices of five companies across different sectors. As a subset of machine learning, deep learning has emerged as a prominent area of research in stock prediction due to its superior handling of complex, nonlinear data. Mehtab et al. [29] employed eight machine learning and four LSTM-based deep learning regression models to predict stock index values and their change patterns over a weekly period, demonstrating that LSTM-based single-input deep learning models outperform machine learning-based models. However, the aforementioned research pri-

marily relies on single data inputs, which are insufficient to describe the interrelationships among multiple variables. Given the messy, dynamic nature of stock market data and its dependence on economic factors, Assaf et al. [30] demonstrated that multivariate deep learning can enhance stock market volatility prediction compared to single-input models. To validate the assertion, Tang et al. [31] proposed model based on a wavelet transform-based LSTM that incorporating multi-dimensional data inputs, achieving an accuracy rate of 72.19%, which surpasses that of single-input LSTM models. Deep et al. [32] introduced a novel multi-factor analysis model for stock market forecasting that extends beyond the use of deep learning models alone. This model integrates technical analysis, fundamental analysis, machine learning, and sentiment analysis, and demonstrates superior performance compared to single-factor models.

2.3. Hybrid Models

Given the inherent advantages and limitations of the techniques mentioned, some researchers have sought to enhance prediction accuracy through the development of hybrid learning models. Hybrid models, which are based on machine learning, combine the predictions of one or more methods to improve the accuracy of simple predictions and mitigate potential overfitting issues. The concept of ensemble models was first proposed in 2001. Abraham et al. [33] constructed one of the earliest hybrid models based on neural fuzzy logic and artificial neural networks (ANN), confirming that hybrid systems yield promising results for both prediction and trend forecasting, warranting further research and analysis. Subsequently, Shah et al. [34] discussed various forecasting methods that could aid in predicting stock prices, highlighting that a hybrid approach combining statistical and machine learning techniques might prove more effective for stock forecasting. Shui-Ling et al. [35] proposed a novel hybrid ARIMA-RNN model to predict stock prices, addressing the volatility issue of single models and avoiding the overfitting problem associated with neural networks.

In recent years, research focus has shifted toward hybrid models incorporating deep learning. Zhang et al. [36] introduced a stock index prediction model based on the ARIMA-CNN-LSTM architecture, demonstrating superior prediction accuracy and robustness compared to traditional models. Tian et al. [37] introduced a multi-layer bidirectional LSTM-BO-LightGBM model to address stock price volatility prediction, verifying its enhanced approximation and generalization capabilities relative to single models. Lv et al. [38] highlighted that there is still room for improving prediction accuracy by transitioning from single deep learning prediction models to hybrid models. They proposed a deep learning hybrid model, CEEMDAN-DAE-LSTM, for stock index prediction, introducing DAE as a feature extrac-

tion module for the first time. This module extracts more nonlinear features of the stock index, thereby enhancing the model’s prediction capability for volatile stock indices. These studies indicate that ensemble learning models have become a prevalent approach for improving prediction accuracy, particularly when dealing with complex and highly dynamic datasets. Moreover, these methods emphasize the necessity of continuing to develop and refine different hybrid models to address the challenges posed by changing market conditions and technological advancements.

3. The Proposed Method

3.1. Problem Statement

In this paper, the objective of stock price prediction is to develop an effective mapping function $f(A)$, such that for input $A = \{(x_1, \dots, x_m) | m = 1, 2, \dots\}$, where $x_m = (a_{m1}, a_{m2}, \dots, a_{mn})$, the function need to yield a set of predicted outputs $f(A) = (a_{mn} + 1, a_{mn} + 2, \dots, a_{mn} + T)$, in which denotes the steps we need to forecast. The goal is to ensure that the predicted outputs closely approximate the actual values.

3.2. Overview of the Multi-Layer Hybrid MTL Structure

The proposed structure integrates multiple dimensions of financial data to enhance predictive accuracy. The framework takes as input a variety of market indicators, including the opening price, closing price, lowest price, highest price, trading volume, and trading amount. These diverse inputs provide a comprehensive representation of the market dynamics, allowing the model to capture intricate relationships and patterns that are essential for accurate forecasting. Fig. 1 provides the proposed framework, which consists of several key components, including a Transformer encoder, a KAN layer, and a BiGRU layer. Table 1 illustrates the configuration of the structure, in which Transformer encoder is responsible for capturing the correspondences among various input features, enabling the model to handle high-dimensional data efficiently. KAN further refines the learning process, enhancing the model’s ability to extract meaningful representations from the input data. BiGRU component captures the long-term temporal dependencies present in financial time series data. By incorporating bidirectional information flow, the BiGRU ensures that both past and future contexts are considered simultaneously, thus providing a richer understanding of the temporal dynamics within the dataset. After processing through these layers, the model generates predictions for both trading volume and trading amount. This multi-task learning approach leverages the shared latent representations learned from the diverse input features to improve the overall stock predictive performance. By integrating these components,

the proposed MTL structure aims to deliver robust and accurate forecasts, addressing the complexities inherent in financial markets.

Table 1. Detailed configuration of the proposed structure.

Layer(type)	Output Shape	Param#
Input Layer	[(None, 5, 1)]	0
Transformer	[(None, 5, 32)]	4
KAN	[(None, 5, 25, 50)]	2
GRU	[(None, 5, 32)]	3360
Bidirectional	[(None, 5, 256)]	164864
Batch Normalization	[(None, 5, 256)]	1024
Dropout	[(None, 5, 256)]	0
Permute	[(None, 256, 5)]	0
Dense	[(None, 256, 5)]	30
Permute	[(None, 5, 256)]	0
Multiply	[(None, 5, 256)]	0
Batch Normalization	[(None, 5, 256)]	1024
Dropout	[(None, 5, 256)]	0
Flatten	[(None, 1280)]	0
Dropout	[(None, 1280)]	0
Dense	[(None, 1)]	1281

3.3. Transformer Encoder Layer

Each Transformer encoder layer comprises two sub-layers: a multi-head self-attention mechanism and a fully connected feed-forward network, both equipped with residual connections. Layer normalization operations are applied around each sub-layer. Fig. 2 illustrates the workflow of the attention mechanism, where the essence of the multi-head attention mechanism is the result of parallel computing of multiple independent attention mechanisms, and then integrated through the linear layer. Firstly, the input vector X is transformed into three vectors: Query (Q), Key (K) and Value (V) by different linear transformations.

$$Q = XW_Q, K = XW_K, V = XW_V \quad (1)$$

where W_Q, W_K and W_V are the weight matrices of different vectors respectively. These transformed matrices are then divided into the multiple heads. For each head $i=1, 2, \dots, h$, the corresponding query, key, value matrices are computed with,

$$Q_i = XW_Q^i, K_i = XW_K^i, V_i = XW_V^i \quad (2)$$

Each head independently calculates its attention weights using the scaled dot-product attention mechanism, defined as:

$$A_i = \text{softmax}\left(\frac{Q_i K_i^T}{\sqrt{d_k}}\right) \quad (3)$$

where d_k is the dimensionality of the key vectors. The attention weights A_i are used to compute the weighted sum of

the value vectors V_i , resulting in the output for the i -th head, which is $Z_i = A_i V_i - I$. The outputs from all the heads are concatenated into a single matrix and passed through a linear transformation with a weight matrix W_o to produce the output:

$$Z = \text{Concat}(Z_1, Z_2, \dots, Z_h)W_o \quad (4)$$

We use 4 attention heads to achieve more accurate prediction accuracy. By using multiple attention heads, the model can focus on different feature spaces of the input data, thereby enhancing its ability to capture complex patterns and improving the overall performance.

The Feed Forward Layer is made up of a fully connected feed-forward network (FNN). In each encoder sub-module, FNN enhances the learning ability of the model through nonlinear transformation. The layer is composed of two linear transformations and a ReLU activation function, which greatly introduces nonlinear characteristics. This enables the model to capture more complex feature relationships and improve its performance in processing complex time series data of the stock market. The expression of this layer is as follows.

$$FFN = \max(0, xW^1 + b^1)W^2 + b^2 \quad (5)$$

The Add/Normalize layer combines Layer Normalization and Residual Connection to reduce the problem of gradient disappearance or explosion. The output sequence of transformer will be transmitted as the input of KAN structure.

3.4. Detailed KAN Layer

Li et al. [39] extended the use of Kolmogorov-Arnold theorem in machine learning and constructed a new KAN neural network architecture. Compared with MLP, the activation function of KAN is located on the edge rather than the node (see Fig. 3). In addition, MLP uses predefined activation functions (such as ReLU or sigmoid), while KAN allows learning adaptive nonlinear functions. At the same time, KAN can set fine-grained nodes to improve the approximation accuracy.

The above characteristics make KAN have great advantages in dealing with smooth and nonlinear functions. After experimental verification, the curve of KAN can converge more quickly and reach a steady state, and it is better than the scaling curve of MLP, especially in the case of high dimension. It has been verified that it has improved prediction accuracy compared with traditional MLPs and is suitable for time series prediction [40]. The architecture revolves around an innovative concept: traditional weight parameters are replaced by univariate function parameters at the edge of the network. In KAN, each node summarizes the output of these functions without any nonlinear transformation. The KAN layer is

$$KAN(x) = (\Phi_{L-1} \odot \Phi_{L-2} \odot \dots \odot \Phi_0) \quad (6)$$

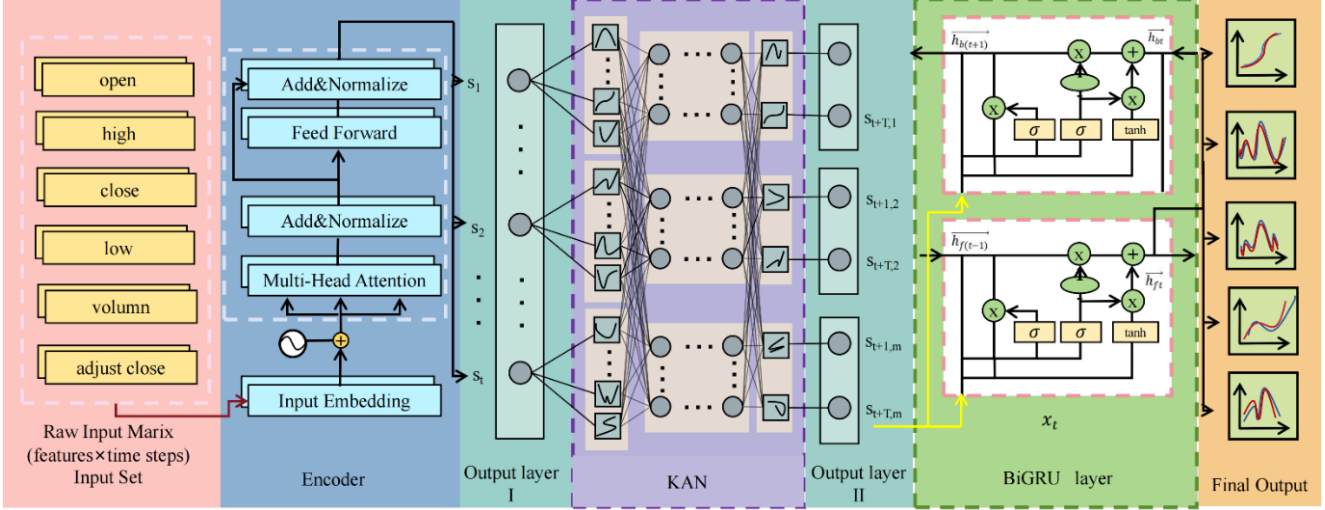

Figure 1. The multi-layer hybrid MTL structure for stock market prediction, involving an enhanced Transformer, KAN and BiGRU.

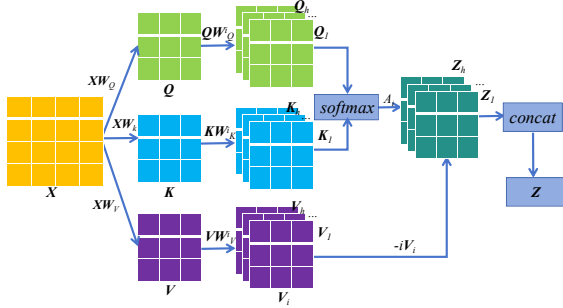

Figure 2. The multi-head attention in the Transformer structure.

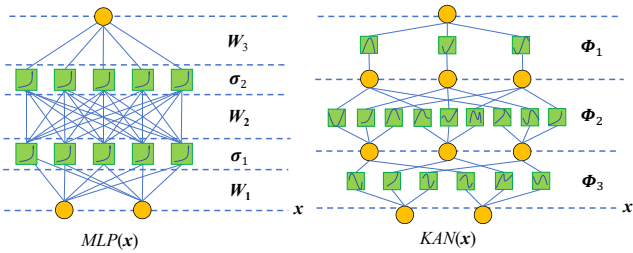

Figure 3. The detailed comparison of MLP and KAN structure

where Φ_1 is the function matrix (B-spline function matrix) corresponding to the first KAN layer, and x is the input matrix.

3.5. Detailed BiGRU Layer

Due to the complexity of the stock market and the volatility of the input data, this hybrid model adopts a two-way GRU structure. BiGRU is a multivariate time series prediction method based on bidirectional GRU. It can adapt to more complex sequence patterns, and can effectively capture the two-way dependencies in time series data and the interaction between multiple variables. The BiGRU model is composed of GRU networks in two directions. One network processes time series data from forward to backward, and the other network processes time series data from backward to forward. That is,

$$\vec{h}_{ft} = GRU(\vec{h}_{f(t-1)}, x_t) \quad (7)$$

$$\vec{h}_{bt} = GRU(\vec{h}_{b(t+1)}, x_t) \quad (8)$$

where \vec{h}_{ft} and \vec{h}_{bt} represent the hidden state from left to right and from right to left respectively. GRU represents the GRU unit, and x_t represents the t -th element in the input sequence. The final hidden state is the splicing of hidden states in two directions.

$$h_t = [\vec{h}_{ft}; \vec{h}_{bt}] \quad (9)$$

where $[\cdot; \cdot]$ denotes the splicing operation of vectors. Finally, the hidden state is passed to a fully connected layer to obtain the output y_t . The illustration of y_t can be expressed as,

$$y_t = softmax(W h_t + b) \quad (10)$$

where W and b denote the weight and bias of the fully connected layer, respectively, and $softmax$ is the SoftMax activation function.

4. EXPERIMENTAL EVALUATIONS

4.1. Experimental Design

To rigorously evaluate and demonstrate the effectiveness of our proposed method, we conducted two types of experiments. We first compared our model against several representative advanced methods, including those proposed by Seo et al. [41], Ma et al. [42], Gao et al. [43], and Hemajothi et al. [44]. Besides, we performed ablation experiments using five established models: KAN, Transformer, BiGRU, KAN-BiGRU, and Transformer-KAN. These comparisons were designed to provide a comprehensive assessment of the predictive performance and robustness of our proposed model in the context of stock price forecasting. The experiments involved multi-feature input and multi-objective prediction. The input features included the opening price (Open), closing price (Close), highest price (High), lowest price (Low), each of which impacts stock trading volume. In this study, the dataset contained all of the aforementioned input features, and the goal was to accurately predict and generate each target feature value across multiple future time steps.

4.2. Evaluating Indicator

To ensure a thorough evaluation, we employ four widely recognized metrics that collectively offer a multi-faceted view of model performance, including mean absolute error (MAE), root mean square error (RMSE), mean absolute percentage error (MAPE) and R-squared (R^2). If y represents the predicted value, y_i represents the true value, and \bar{y}_i is the number of samples, the representation of the four metrics are concluded as follows.

MAE evaluates the average absolute difference between predicted values and actual values of the model, which is very sensitive to outliers or large prediction errors. A smaller the MAE is, the stronger the prediction ability of the model is.

$$MAE = \frac{1}{m} \sum_{i=1}^m |y_i - \bar{y}_i| \quad (11)$$

RMSE restores the measurement of error to the same unit as the original data, making the results more intuitive and easier to understand. The representation is demonstrated as follow.

$$RMSE = \sqrt{MSE} \quad (12)$$

MAPE is a measure of the prediction accuracy of prediction methods in statistics. It provides a relative error measure that enables it to compare the performance of different models on data sets of different sizes. A lower MAPE indicates that the prediction accuracy of the model is higher.

$$MAPE = \frac{100\%}{n} \sum_{i=1}^m \left| \frac{y_i - \bar{y}_i}{y_i} \right| \quad (13)$$

R^2 measures the proportion of the variance that can be predicted by the independent variable, indicating that the model fits the input data well. It is illustrated as follow.

$$R^2 = I - \frac{SS_{residual}}{SS_{total}} \quad (14)$$

where $SS_{residual}$ is residual sum of squares, and that SS_{total} is the total sum of the squares. The four metrics are collected when finishing all the prediction experiments.

4.3. Result Evaluation and Analysis with Advanced Methods

Fig. 4, Fig.5, Fig.6, Fig. 7 and Fig 8 provides five representative comparison results of the stock features with different comparative advanced methods. The comparative results show that the proposed method maintains a high consistency with the real value in most time periods, especially in the interval of 0-50 and 120-200 time steps, which shows lower error than other methods. In contrast, other methods often lag or deviate too much in these intervals, and the proposed method can more accurately capture the overall trend and all the change inflection points. In the prediction of peaks and troughs, the proposed method also indicates obvious advantages. At multiple key points such as 40-60 and 170-200 time steps, it can not only accurately identify local highs and lows, but also avoid deviations from other methods under noise interference. In addition, the model shows good robustness in the high-frequency fluctuation region, which can effectively filter out noise and make the prediction curve smoother and closer to the real value.

Table 2 depicts the average values of the four evaluated metrics from all the comparative advanced methods. It demonstrates that the proposed method achieves significant improvements over all the comparative models. Specifically, the RMSE of the proposed prediction method is 39.820, indicating a 17.2% reduction compared to Hemajothi et al. [44], which shows greater robustness in handling large fluctuations and reducing the impact of outliers. Furthermore, the R^2 reaches 0.977, outperforming Gao et al. [43] and Hemajothi et al. [44] by 4.2% and 3.1%, respectively. This highlights the model's ability to accurately capture both short-term variations and long-term trends, reflecting superior its predictive performance. While improvements are also seen in MAE and MAPE, the gains in RMSE and R^2 are more critical. These results confirm that the method excels in error control and trend detection, making it well-suited for complex, noisy, and nonlinear time series forecasting.

4.4. Result Evaluation and Analysis with Ablation Methods

Fig. 9, Fig.10, Fig.11, Fig 12 as well as Fig. 11 illustrates four representative comparison results of the four stock fea-

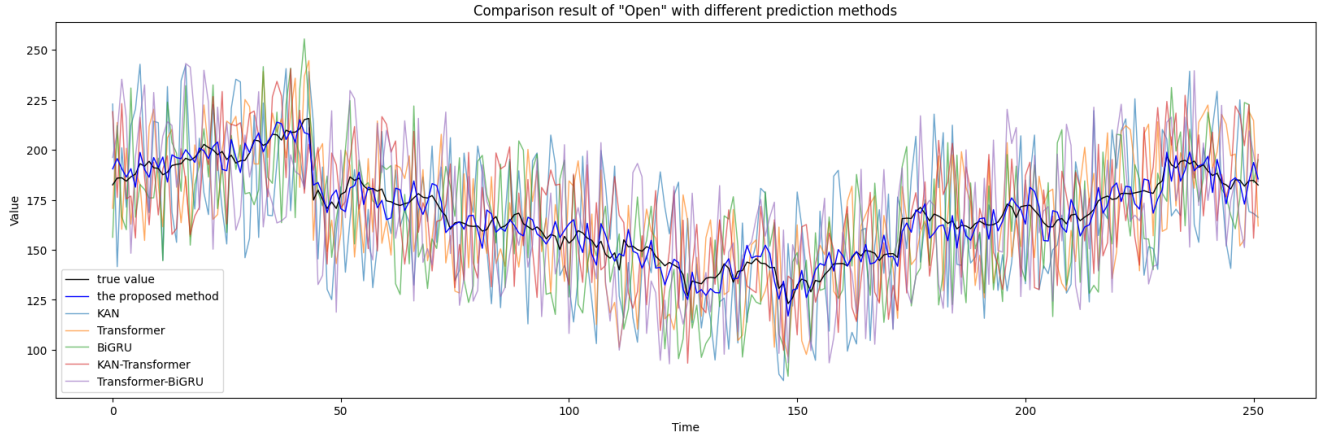

Figure 4. The multi-layer hybrid MTL structure for stock market prediction, involving an enhanced Transformer, KAN and BiGRU.

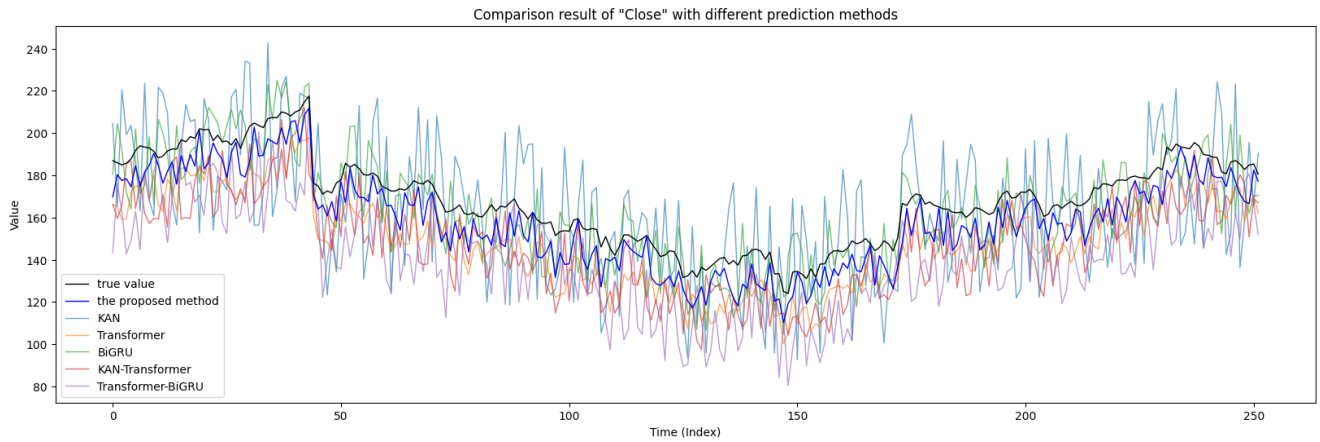

Figure 5. The multi-layer hybrid MTL structure for stock market prediction, involving an enhanced Transformer, KAN and BiGRU.

Table 2. The average values of the four evaluated metrics.

Methods	MAE	RMSE	MAPE	R^2
KAN	39.278	49.683	0.056	0.916
Transformer	39.047	42.917	0.063	0.935
BiGRU	32.741	47.050	0.045	0.940
KAN-Transformer	29.384	39.693	0.038	0.953
Transformer-BiGRU	27.046	34.821	0.051	0.950
Proposed method	18.410	21.004	0.031	0.968

tures with different comparative ablation methods. Compared with models, including KAN, Transformer, BiGRU, KAN-Transformer and Transformer-BiGRU, the proposed method shows significant advantages in prediction accuracy and stability. It can be observed from the figures that in the high-frequency fluctuation region, the prediction results of other models have obvious noise interference, their curve

fluctuates greatly, and there is a large deviation from the real value in many points. In contrast, the proposed method is not only smoother, but also highly consistent with the true value at most of the time steps. In terms of peak and trough capture, the proposed method shows strong sensitivity and accuracy. The prediction results of multiple key inflection points such as 50-70 and 170-200 time steps, showing that it can accurately track the changes of local highs and lows, while other models have certain prediction lag or over-fitting in these regions. In addition, in the trend recovery interval such as 150-250 time steps, the prediction curves of other models are often amplified by noise and produce large fluctuations. The proposed method can effectively filter out these noises and ensure that the prediction results are more stable.

Table 3 describes the average values of the four evaluated metrics from all the comparative ablation methods. It shows

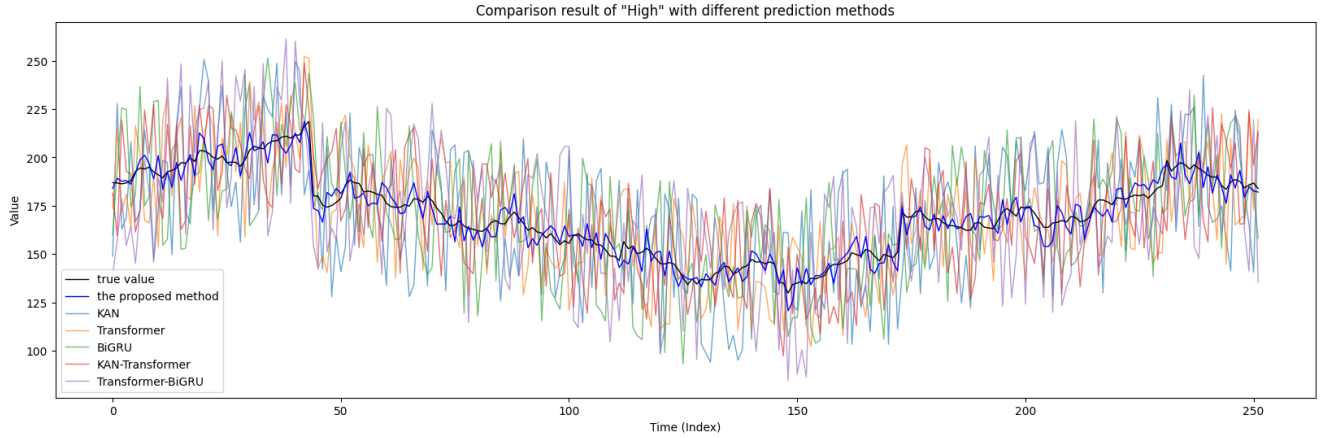

Figure 6. The multi-layer hybrid MTL structure for stock market prediction, involving an enhanced Transformer, KAN and BiGRU.

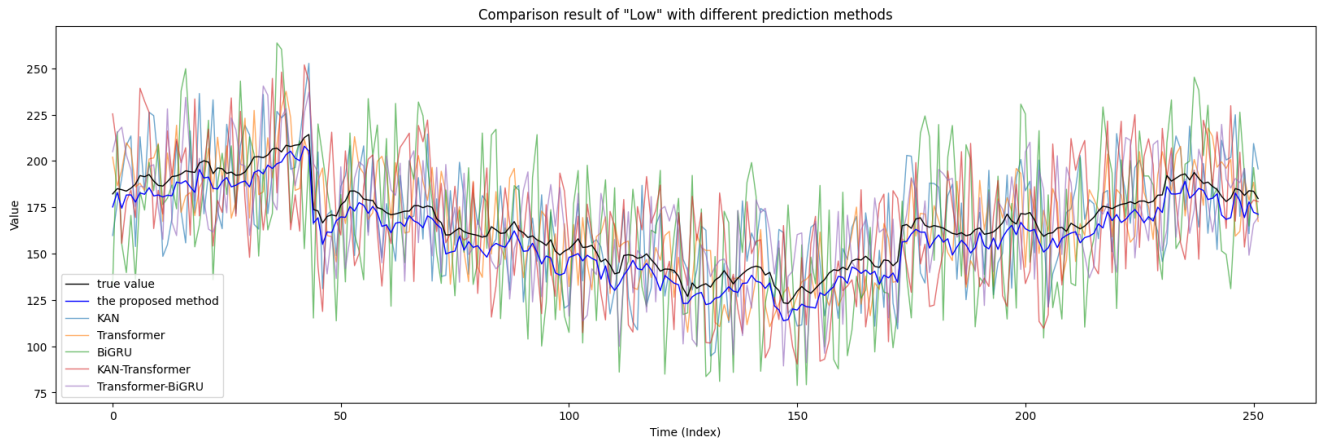

Figure 7. The multi-layer hybrid MTL structure for stock market prediction, involving an enhanced Transformer, KAN and BiGRU.

that the proposed method presents significant advantages in RMSE and R^2 , highlighting its robustness and trend capture ability in complex data environments. The RMSE is 21.004, which is 39.7 % less than the best performing Transformer-BiGRU, indicating that the model is more stable when dealing with different high volatility data, especially stock data. On R^2 , the proposed method reaches 0.968, which is significantly better than other comparison models, verifying its stronger fitting ability. Although MAE and MAPE have also improved, the improvement of RMSE and R^2 is particularly important. The performance of these key indicators proves that our model can not only effectively reduce errors, but also accurately capture long-term trends, providing more reliable support for series prediction tasks.

The intricate structure and computational processes of Transformer encoders and KAN layers often lead to elevated time complexity. However, our model effectively ad-

Table 3. The average values of the four evaluated metrics.

Methods	MAE	RMSE	MAPE	R^2
Seo et al. [41]	22.103	58.475	0.063	0.925
Ma et al. [42]	19.236	52.049	0.049	0.914
Gao et al. [43]	24.859	51.816	0.064	0.938
Hemajothi et al. [44]	20.934	48.068	0.051	0.948
Proposed method	16.007	39.820	0.032	0.977

dresses this limitation, demonstrating a significant improvement in inference efficiency compared to state-of-the-art methods. The detailed comparative results are presented in the table below.

Furthermore, we performed cross-validation on the experimental results and calculated the average values to ensure the robustness and reliability of our findings. The results of the cross-validation are consistent with the overall

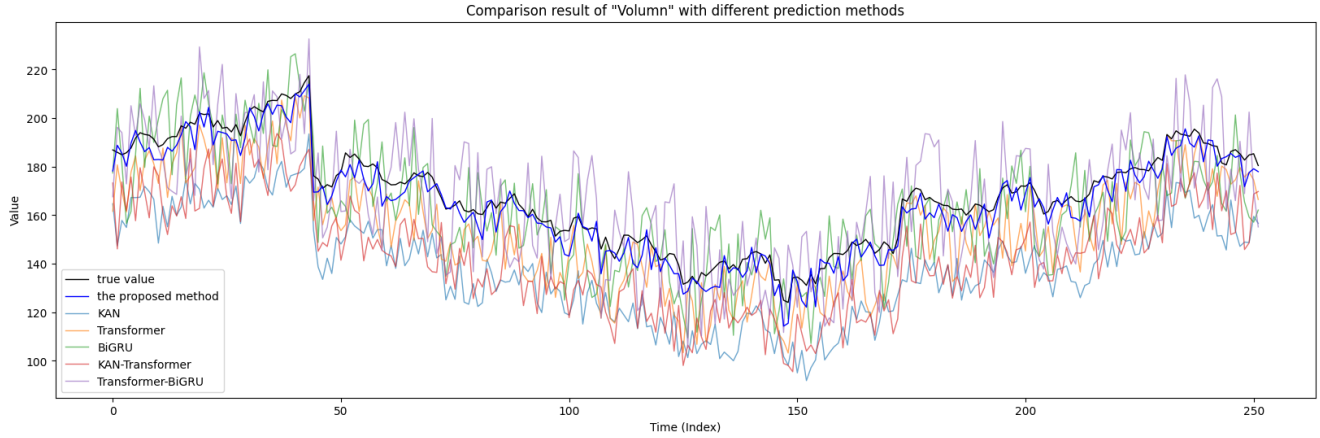

Figure 8. The multi-layer hybrid MTL structure for stock market prediction, involving an enhanced Transformer, KAN and BiGRU.

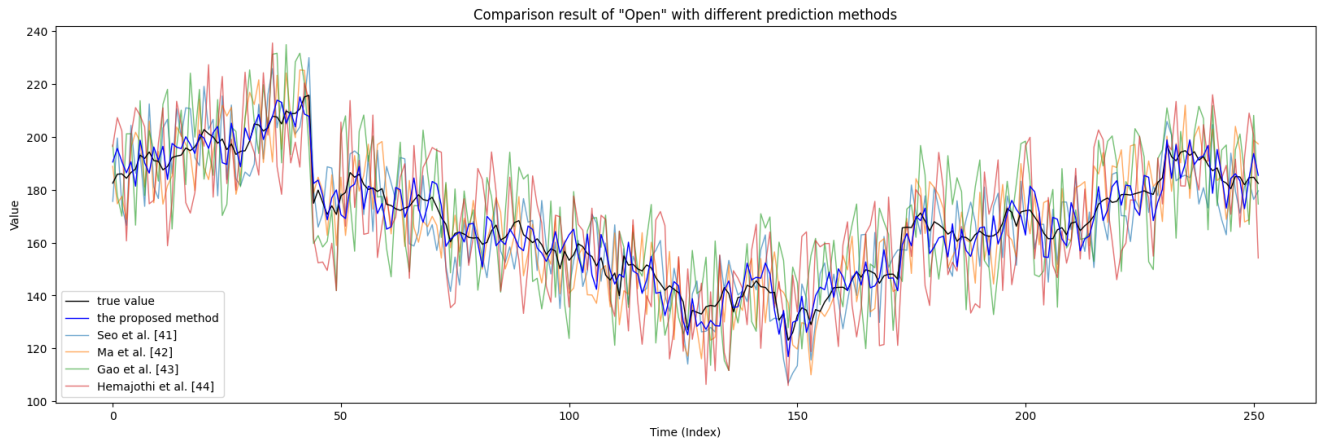

Figure 9. The multi-layer hybrid MTL structure for stock market prediction, involving an enhanced Transformer, KAN and BiGRU.

Table 4. The inference time of the four evaluated metrics

Methods	Time
Seo et al. [41]	0.0284
Ma et al. [42]	0.0199
Gao et al. [43]	0.0213
Hemajothi et al. [44]	0.0263
Proposed method	0.0193

performance, with an Average Test R^2 of 0.9831.

5. CONCLUSION

This study proposed a multi-layer hybrid MTL structure to address the challenges of multi-task stock price prediction caused by the market’s high volatility, complexity, and dynamic nature. The framework novelty integrates an en-

hanced Transformer encoder for feature extraction, a BiGRU for capturing long-term temporal dependencies, and a KAN to enhance the learning process. Experimental results demonstrate that the proposed learning network outperforms competitive models, achieving MAE as low as 0.45 and R^2 up to 0.98, highlighting its robustness and predictive accuracy. These results confirm the effectiveness of leveraging complementary learning techniques to capture complex relationships and improve forecasting performance. The framework offers a promising approach for future research and applications in stock market prediction.

References

- [1] Vineet Kukreti, Chandradeep Bhatt, and Rakesh Dani. A stock market trends analysis of reliance using machine learning techniques. In *2023 6th International Conference on Information Systems and Computer Networks (ISCON)*, pages

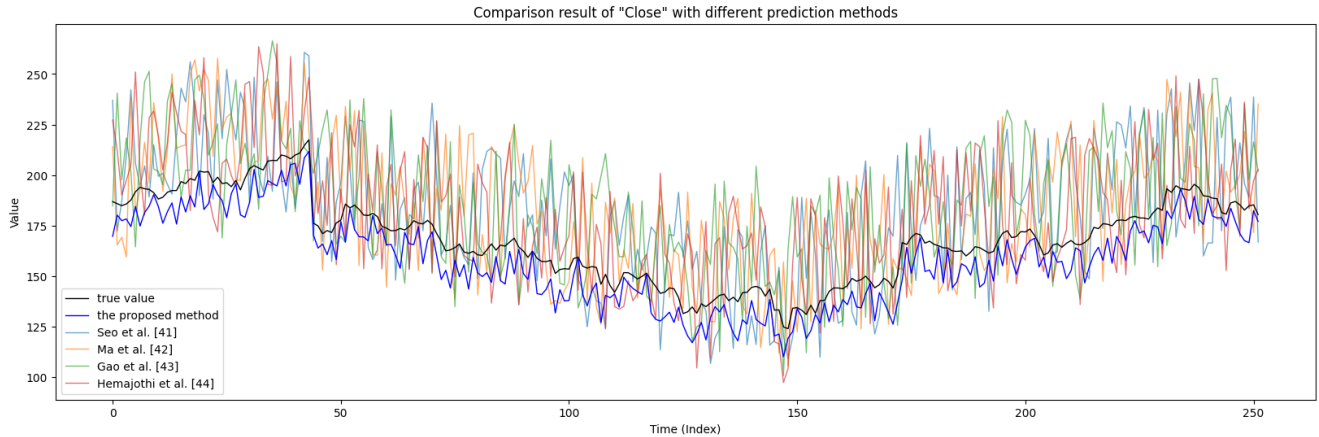

Figure 10. The multi-layer hybrid MTL structure for stock market prediction, involving an enhanced Transformer, KAN and BiGRU.

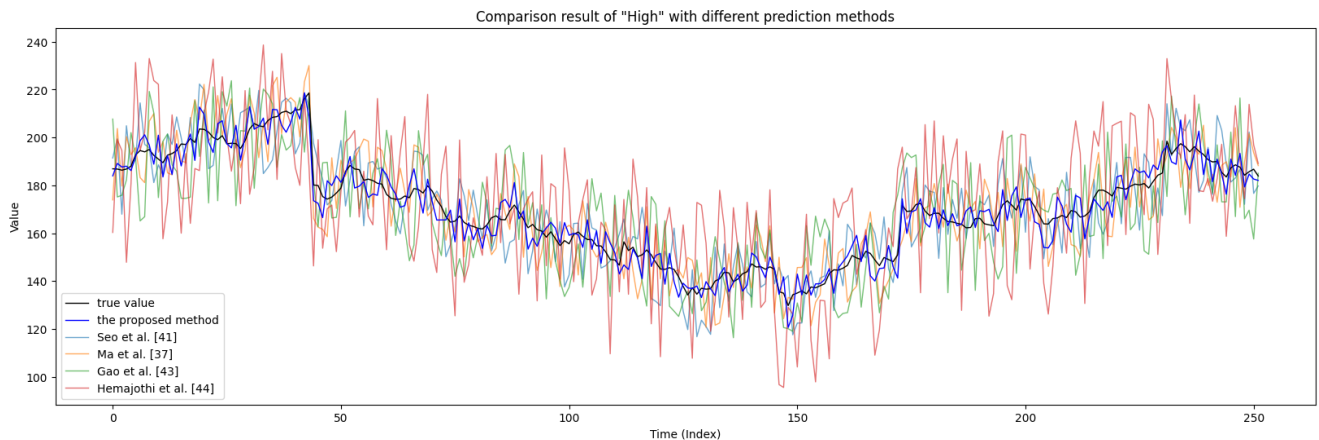

Figure 11. The multi-layer hybrid MTL structure for stock market prediction, involving an enhanced Transformer, KAN and BiGRU.

- 1–6. IEEE, 2023. **1**
- [2] Chuanjun Zhao, Meiling Wu, Jingfeng Liu, Zening Duan, Lihua Shen, Xuekui Shangguan, Donghang Liu, Yanjie Wang, et al. Progress and prospects of data-driven stock price forecasting research. *International Journal of Cognitive Computing in Engineering*, 4:100–108, 2023. **1**
- [3] Weijun Xu, Zhineng Fu, Hongyi Li, Jinglong Huang, Weidong Xu, and Yiyang Luo. A study of the impact of covid-19 on the chinese stock market based on a new textual multiple arma model. *Statistical Analysis and Data Mining: The ASA Data Science Journal*, 16(1):5–15, 2023. **1**
- [4] Adebiji A Ariyo, Adewumi O Adewumi, and Charles K Ayo. Stock price prediction using the arima model. In *2014 UKSim-AMSS 16th international conference on computer modelling and simulation*, pages 106–112. IEEE, 2014. **1**
- [5] Helmut Herwartz. Stock return prediction under garch—an empirical assessment. *International Journal of Forecasting*, 33(3):569–580, 2017. **1**
- [6] Dwi Susanti, Kirana Fara Labitta, and Sukono Sukono. Forecasting indonesian stock index using arma-garch model. *International Journal of Quantitative Research and Modeling*, 5(2):199–204, 2024. **1**
- [7] Qihang Ma. Comparison of arima, ann and lstm for stock price prediction. In *E3S Web of Conferences*, volume 218, page 01026. EDP Sciences, 2020. **1**
- [8] Yufeng Chen, Jinwang Wu, and Zhongrui Wu. China’s commercial bank stock price prediction using a novel k-means-lstm hybrid approach. *Expert Systems with Applications*, 202:117370, 2022. **1**
- [9] Melih Kirisci and Ozge Cagcag Yolcu. A new cnn-based model for financial time series: Taiex and ftse stocks forecasting. *Neural Processing Letters*, 54(4):3357–3374, 2022. **1**
- [10] Sahil Agarwal, Bosco Paul Alapatt, Akhil M Nair, and Fr Jossy George. Stock price prediction using rnns: A

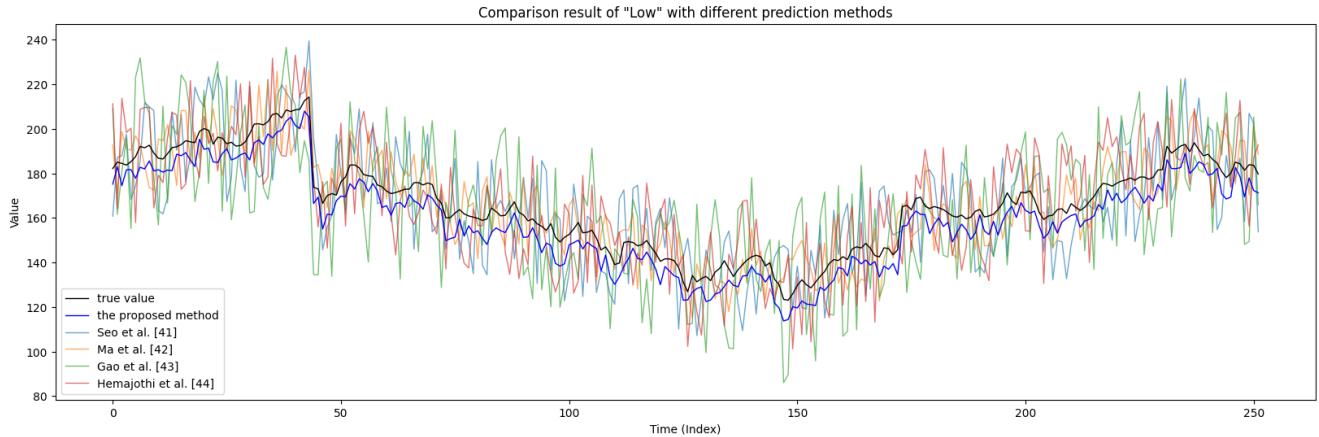

Figure 12. The multi-layer hybrid MTL structure for stock market prediction, involving an enhanced Transformer, KAN and BiGRU.

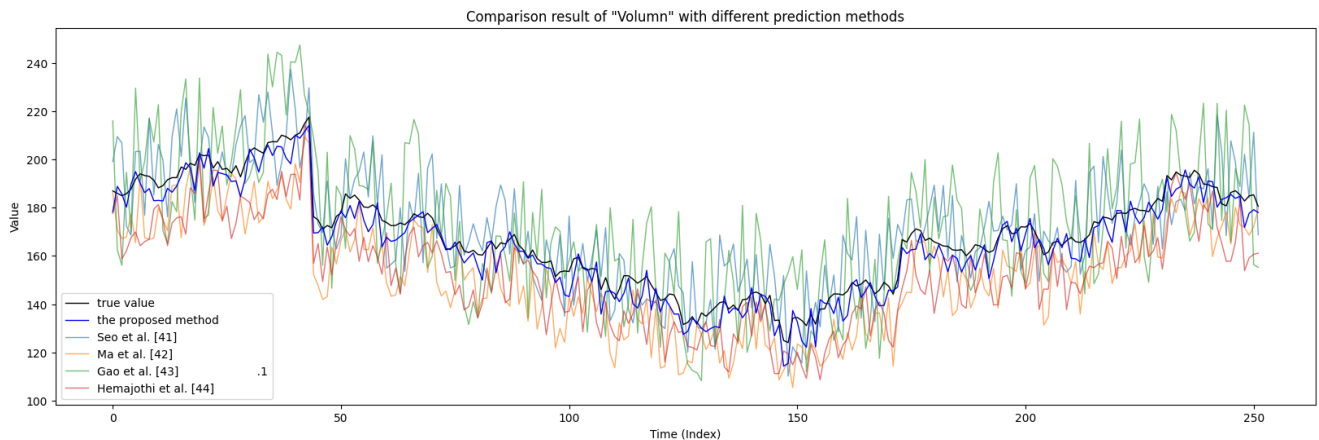

Figure 13. The multi-layer hybrid MTL structure for stock market prediction, involving an enhanced Transformer, KAN and BiGRU.

comparative analysis of rnn, lstm, gru, and birnn. In *2024 2nd International Conference on Sustainable Computing and Smart Systems (ICSCSS)*, pages 1074–1079. IEEE, 2024. 1

- [11] Jimmy Ming-Tai Wu, Zhongcui Li, Norbert Herencsar, Bay Vo, and Jerry Chun-Wei Lin. A graph-based cnn-lstm stock price prediction algorithm with leading indicators. *Multimedia Systems*, 29(3):1751–1770, 2023. 1
- [12] Tao Yin, Chenzhengyi Liu, Fangyu Ding, Ziming Feng, Bo Yuan, and Ning Zhang. Graph-based stock correlation and prediction for high-frequency trading systems. *Pattern Recognition*, 122:108209, 2022. 1
- [13] Yong Shi, Yunong Wang, Yi Qu, and Zhensong Chen. Integrated gcn-lstm stock prices movement prediction based on knowledge-incorporated graphs construction. *International Journal of Machine Learning and Cybernetics*, 15(1):161–176, 2024. 1
- [14] Camilo Yañez, Werner Kristjanpoller, and Marcel C Minutolo. Stock market index prediction using transformer neural

network models and frequency decomposition. *Neural Computing and Applications*, pages 1–21, 2024. 1

- [15] Wuzhida Bao, Yuting Cao, Yin Yang, Hangjun Che, Junjian Huang, and Shiping Wen. Data-driven stock forecasting models based on neural networks: A review. *Information Fusion*, page 102616, 2024. 1
- [16] Jinghui Yuan, Weijin Jiang, Zhe Cao, Fangyuan Xie, Rong Wang, Feiping Nie, and Yuan Yuan. Achieving more with less: A tensor-optimization-powered ensemble method. *arXiv preprint arXiv:2408.02936*, 2024. 2
- [17] Jinghui Yuan, Hao Chen, Renwei Luo, and Feiping Nie. A margin-maximizing fine-grained ensemble method. *arXiv preprint arXiv:2409.12849*, 2024. 2
- [18] Xibin Dong, Zhiwen Yu, Wenming Cao, Yifan Shi, and Qianli Ma. A survey on ensemble learning. *Frontiers of Computer Science*, 14:241–258, 2020. 2
- [19] Fang Liu, Shaobo Guo, Qianwen Xing, Xinye Sha, Ying Chen, Yuhui Jin, Qi Zheng, and Chang Yu. Application of

- an ann and lstm-based ensemble model for stock market prediction. In *2024 IEEE 7th International Conference on Information Systems and Computer Aided Education (ICISCAE)*, pages 390–395. IEEE, 2024. 2
- [20] Roberto Corizzo and Jacob Rosen. Stock market prediction with time series data and news headlines: a stacking ensemble approach. *Journal of Intelligent Information Systems*, 62(1):27–56, 2024. 2
- [21] B Uma Devi, Darshan Sundar, and P Alli. An effective time series analysis for stock trend prediction using arima model for nifty midcap-50. *International Journal of Data Mining & Knowledge Management Process*, 3(1):65, 2013. 2
- [22] Supriti Khanderwal and Debasis Mohanty. Stock price prediction using arima model. *International Journal of Marketing & Human Resource Research*, 2(2):98–107, 2021. 2
- [23] Nagendra Marisetty. Prediction of popular global stock indexes volatility by using arch/garch models. *GARCH Models (July 24, 2024)*, 2024. 2
- [24] Aditya Gupta and Bhuwan Dhingra. Stock market prediction using hidden markov models. In *2012 Students Conference on Engineering and Systems*, pages 1–4. IEEE, 2012. 2
- [25] Zhi Su and Bo Yi. Research on hmm-based efficient stock price prediction. *Mobile Information Systems*, 2022(1):8124149, 2022. 2
- [26] Raffaele Mattera and Philipp Otto. Network log-arch models for forecasting stock market volatility. *International Journal of Forecasting*, 2024. 2
- [27] Indronil Bhattacharjee and Pryonti Bhattacharja. Stock price prediction: a comparative study between traditional statistical approach and machine learning approach. In *2019 4th international conference on electrical information and communication technology (EICT)*, pages 1–6. IEEE, 2019. 2
- [28] Mehar Vijh, Deeksha Chandola, Vinay Anand Tikkiwal, and Arun Kumar. Stock closing price prediction using machine learning techniques. *Procedia computer science*, 167:599–606, 2020. 2
- [29] Sidra Mehtab, Jaydip Sen, and Abhishek Dutta. Stock price prediction using machine learning and lstm-based deep learning models. In *Machine Learning and Metaheuristics Algorithms, and Applications: Second Symposium, SoMMA 2020, Chennai, India, October 14–17, 2020, Revised Selected Papers 2*, pages 88–106. Springer, 2021. 2
- [30] Osama Assaf. *Multivariate and multi-task deep learning architectures for improved stock market prediction and risk management*. PhD thesis, University of Reading, 2024. 3
- [31] Pan Tang, Cheng Tang, and Keren Wang. Stock movement prediction: A multi-input lstm approach. *Journal of Forecasting*, 2024. 3
- [32] Akash Deep. A multifactor analysis model for stock market prediction. *International Journal of Computer Science and Telecommunications*, 14(1), 2023. 3
- [33] Ajith Abraham, Baikunth Nath, and Prabhat Kumar Mahanti. Hybrid intelligent systems for stock market analysis. In *Computational Science-ICCS 2001: International Conference San Francisco, CA, USA, May 28–30, 2001 Proceedings, Part II 1*, pages 337–345. Springer, 2001. 3
- [34] Dev Shah, Haruna Isah, and Farhana Zulkernine. Stock market analysis: A review and taxonomy of prediction techniques. *International Journal of Financial Studies*, 7(2):26, 2019. 3
- [35] YU Shui-Ling and Zhe Li. Stock price prediction based on arima-rnn combined model. In *4th International Conference on Social Science (ICSS 2017)*, pages 1–6, 2017. 3
- [36] Ziyang Zhang. Research on stock index prediction based on arima-cnn-lstm model. In *9th International Conference on Financial Innovation and Economic Development (ICFIED 2024)*, pages 558–565. Atlantis Press, 2024. 3
- [37] Liwei Tian, Li Feng, Lei Yang, and Yuankai Guo. Stock price prediction based on lstm and lightgbm hybrid model. *The Journal of Supercomputing*, 78(9):11768–11793, 2022. 3
- [38] Pin Lv, Yating Shu, Jia Xu, and Qinjuan Wu. Modal decomposition-based hybrid model for stock index prediction. *Expert Systems with Applications*, 202:117252, 2022. 3
- [39] Ziming Liu, Yixuan Wang, Sachin Vaidya, Fabian Ruehle, James Halverson, Marin Soljačić, Thomas Y Hou, and Max Tegmark. Kan: Kolmogorov-arnold networks. *arXiv preprint arXiv:2404.19756*, 2024. 4
- [40] Cristian J Vaca-Rubio, Luis Blanco, Roberto Pereira, and Mărius Caus. Kolmogorov-arnold networks (kans) for time series analysis. *arXiv preprint arXiv:2405.08790*, 2024. 4
- [41] Kanghyeon Seo and Jihoon Yang. Exploring the efficient market hypothesis for accurate stock movement prediction via feature-axis transformer. In *Proceedings of the 39th ACM/SIGAPP Symposium on Applied Computing*, pages 892–901, 2024. 6, 8, 9
- [42] Chi Ma, Jie Wu, Hui Hu, Yue Nai Chen, and Jing Yan Li. Predicting stock prices using hybrid lstm and arima model. *IAENG International Journal of Applied Mathematics*, 54(3), 2024. 6, 8, 9
- [43] Zidi Gao and Ercan Engin Kuruoğlu. Attention based hybrid parametric and neural network models for non-stationary time series prediction. *Expert Systems*, 41(2):e13419, 2024. 6, 8, 9
- [44] S Hemajothi, S Sivasaravana Babu, V Prathiksha, B Sangeetha, E Sivani, and K Soundari. Prediction of stock price model through the implementation of hybrid bilstm-gru. In *2024 International Conference on Recent Advances in Electrical, Electronics, Ubiquitous Communication, and Computational Intelligence (RAEEUCCI)*, pages 1–6. IEEE, 2024. 6, 8, 9