

---

# *PyPotteryLens*: AN OPEN-SOURCE DEEP LEARNING FRAMEWORK FOR AUTOMATED DIGITISATION OF ARCHAEOLOGICAL POTTERY DOCUMENTATION

---

A PREPRINT

**Lorenzo Cardarelli**   
Department of Antiquities  
Sapienza University of Rome  
Rome, RM, 135  
[lorenzo.cardarelli@uniroma1.it](mailto:lorenzo.cardarelli@uniroma1.it)

December 17, 2024

## ABSTRACT

Archaeological pottery documentation and study represents a crucial but time-consuming aspect of archaeology. While recent years have seen advances in digital documentation methods, vast amounts of legacy data remain locked in traditional publications. This paper introduces *PyPotteryLens*, an open-source framework that leverages deep learning to automate the digitisation and processing of archaeological pottery drawings from published sources. The system combines state-of-the-art computer vision models (YOLO for instance segmentation and EfficientNetV2 for classification) with an intuitive user interface, making advanced digital methods accessible to archaeologists regardless of technical expertise. The framework achieves over 97% precision and recall in pottery detection and classification tasks, while reducing processing time by up to 5× to 20× compared to manual methods. Testing across diverse archaeological contexts demonstrates robust generalisation capabilities. Also, the system’s modular architecture facilitates extension to other archaeological materials, while its standardised output format ensures long-term preservation and reusability of digitised data as well as solid basis for training machine learning algorithms. The software, documentation, and examples are available on GitHub (<https://github.com/Irnrcrd/PyPottery/tree/PyPotteryLens>).

**Keywords** Deep Learning • Pottery • Legacy Data • Archaeology

## 1 Introduction

Working with archaeological pottery is a time-consuming and resource-intensive process. Once unearthed, after a process of cleaning and cataloguing, archaeological ceramics are traditionally documented through technical drawings, which are then illustrated as plates or tables in publications. While new methods of digital documentation have been developed in recent years, allowing speed-up and standardisation of the drawing process (Demján, Pavúk, and Roosevelt 2023), there are hundreds of thousands of data already available in paper publications (or PDFs) that can be considered as *legacy data* (Allison 2008; Snow 2010). As archaeological ceramics are a key element in dating and interpreting archaeological contexts (Shepard 1985; Orton and Hughes 2013; Sinopoli 1991), it is important that this data is made digitally accessible and re-usable (Marwick et al. 2017). Traditionally, the retrieval of data from publications has involved a lengthy process of manual digitisation, starting with the extraction of the drawings using photo-editing software, which is then associated with a range of tabular information, usually managed in a spreadsheet or database. Clearly, this is a tedious, time-consuming and error-prone process, and it can become a particularly challenging task when dealing with very large datasets. Nevertheless, archaeological drawings represent a source of knowledge that is essentially (or highly) standardised as they contain information on the shape, decoration, and dimensions of artefacts and provide a highly analytical value that can be used in traditional or typological approaches (Clarke 1968; Adams and Adams 1991; Read 2009) and modern computational methods, including the application of machine learning (ML) (Navarro et al. 2021, 2022; Parisotto et al. 2022; L. Cardarelli 2022). Recently, the use of deep learning (DL)

techniques has become increasingly popular in archaeology (Bickler 2021; Cacciari and Pocobelli 2022), following trends in other fields, including non-scientific ones, such as arts or industries (Le et al. 2020; Ramesh et al. 2021; Maerten and Soydaner 2024). However, many applications have focused on specific research areas like site detection (Sakai et al. 2024; Caspari and Crespo 2019; Buławka, Orengo, and Berganzo-Besga 2024), artifact classification (Emmitt et al. 2022; Gualandi, Gattiglia, and Anichini 2021; Anichini et al. 2021) or heritage preservation (Cui et al. 2024; D’Orazio et al. 2024), while the retrieval and processing of *legacy data* has remained relatively unexplored. This gap is particularly significant given that the efficient and rapid retrieval of archaeological data from printed publications or PDFs is essential for the advancement of archaeological research, as we can use this ready-to-use data for both traditional analysis and the development of even more complex ML techniques that require even larger training datasets.

This paper presents *PyPotteryLens*, a specialised framework designed to transform legacy pottery documentation into standardised digital records while preserving scientific or analytical strength. The approach embraces DL techniques and makes three principal key contributions to pottery studies and digital heritage preservation:

- A robust methodology for automatically detecting and segmenting pottery drawings from publications, creating high-quality digital records suitable for long-term preservation.
- A classification system that standardises the orientation and preservation of pottery records, ensuring consistency across digital archives and prepare the data for the subsequent analysis.
- An interactive visualisation framework that enables users’ examination and validation providing accuracy in complex cases or errors.

The program requires no specific programming skills as it combines powerful DL techniques with an intuitive, easy-to-use, and scalable user interface. Totally open-source, the software is accessible, improvable and expandable by the archaeological community. In fact, although the system is designed for the recording of archaeological ceramics, it can be easily adapted for the analysis and documentation of other types of archaeological objects such as lithics, metals and so on.

Recent approaches to documenting archaeological material include work by Klein et al. (2024), who propose a method for analysing PDFs using computer vision techniques. Their method focuses on object detection across 14 classes of archaeological objects, including ceramics, using the ResNet-152 neural network (He et al. 2015). In this paper, a different approach is suggested: first, it propose a more vertical approach as it specialises in ceramics, allowing for more precise and targeted analysis; second, it employs the YOLO architecture, which offers significant advantages in processing speed and efficiency compared to ResNet-152. Most importantly, the proposed method implements instance segmentation rather than simple object detection, enabling precise contour tracing of pottery drawings (Figure 1). This segmentation-based approach provides several advantages: it allows for more accurate measurements, facilitates detailed shape analysis, and produces cleaner results suitable for both digital archives and further computational analysis. Additionally, the segmentation masks generated can be used to create new training data, enabling continuous improvement of the model’s performance and adaptability to different pottery styles and publication formats through a self-training approach (Amini et al. 2024).

Finally, the proposed methodology includes extensive documentation and a series of practical examples to facilitate the use of the software by archaeologists. This approach is designed to ensure that the software is accessible to all users, regardless of their technical background, and to facilitate integration with traditional archaeological working methods. The software, documentation and examples are available on GitHub (<https://github.com/lmrcrd/PyPottery/tree/PyPotteryLens>) to ensure maximum transparency and accessibility for the archaeological community and to encourage collaboration and further development.

## 2 Research aims

This paper provides a comprehensive analysis of the *PyPotteryLens* pipeline, with three key research objectives:

1. To introduce *PyPotteryLens* as a solution for automated pottery recording in archaeology, specifically: (1) Demonstrating its capacity to process and digitise legacy archaeological publications (2) Evaluating its effectiveness in reducing processing time compared to manual methods.
2. To present a detailed technical examination of the system architecture, focusing on (1) The implementation and performance of YOLO-based instance segmentation for pottery detection (2) The development and validation of a custom EfficientNetV2-based classification model for drawing orientation and fragmentation identification (3) Testing Gradio user interface as integration of DL models within a user-friendly interface.
3. To evaluate the system’s effectiveness through (1) Comprehensive testing on a diverse corpus of archaeological publications spanning different chronological periods and regions (2) Quantitative assessment of accuracy, precision, and recall rates for both detection and classification tasks (3) Analysis of the system’s ability to

handle variations in publication formats and drawing styles (4) Demonstration of the system’s potential for generating standardised training data for future deep learning applications in archaeology.

### 3 Methods

#### 3.1 General system architecture

*PyPotteryLens* is structured as a comprehensive framework for analysing archaeological pottery contained within PDF documents or images. At its core, the system integrates six main modules that work in concert: *Document Processing*, *Model Processing*, *Mask Extraction*, *Tabular Data Management*, *Post-processing* and *Self-Annotation*.

The system’s workflow progresses through several interconnected phases (Figure 2), beginning with the *Document Processing* stage where PDF documents are fed into the system. These inputs undergo initial processing and normalisation, with an integrated visualiser allowing users to directly assess image quality within the application. Moving into the *Model Processing* stage, the system applies YOLO model inference using a set of user-adjustable parameters, providing flexibility to accommodate varying document qualities and pottery styles (e.g., post-processing on segmentation masks or confidence threshold for the model). The resulting segmentation masks can be visually modified or supplemented through manual control, ensuring high accuracy in complex cases or errors. If the model fails to detect instances, new masks can be created manually. Moving to *Mask Extraction* step, each identified pottery instance is then extracted and established as an individual *.png* file, creating *discrete units* for subsequent analysis and processing. The *Tabular Data Management* enables the association of detailed metadata with each extracted instance, creating a dataset that combines image and contextual information through the creation of a spreadsheet (*.csv*) containing all the inserted information. In the *Post-processing* stage, *PyPotteryLens* employs a custom EfficientNetV2 (Tan and Le 2021) model to classify the extracted instances according to predefined categories. To ensure high performance, these classifications can be visualised and manually adjusted if needed. After this step, the recording process is completed, and the results can be indexed and exported as images and in optimised PDF format using a two-dimensional bin packing algorithm (Lodi, Martello, and Vigo 2002).

Finally, the *Self-Annotation* module allows users transform the extracted mask into a new fuel for training the computer vision model, creating a virtuous cycle of data generation and model improvement based on your specific needs.

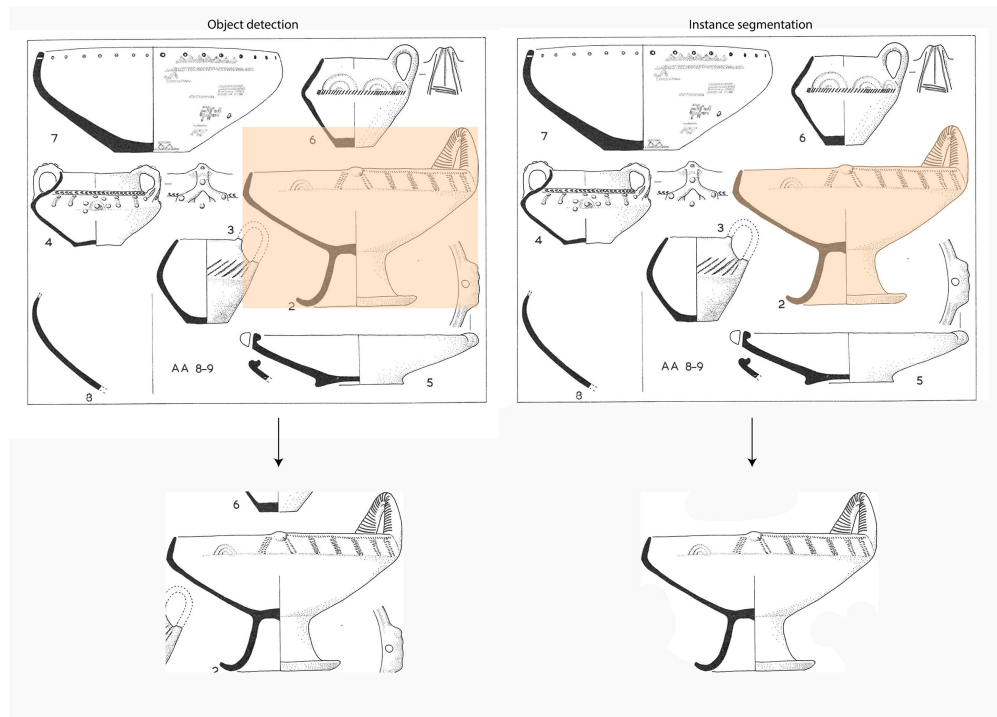

Figure 1: Object detection (left) *versus* instance segmentation (right). The example illustrates the principal benefits of the segmentation approach, which enables the removal of each element that falls outside the target area. Example by Moretti et al. (1963).

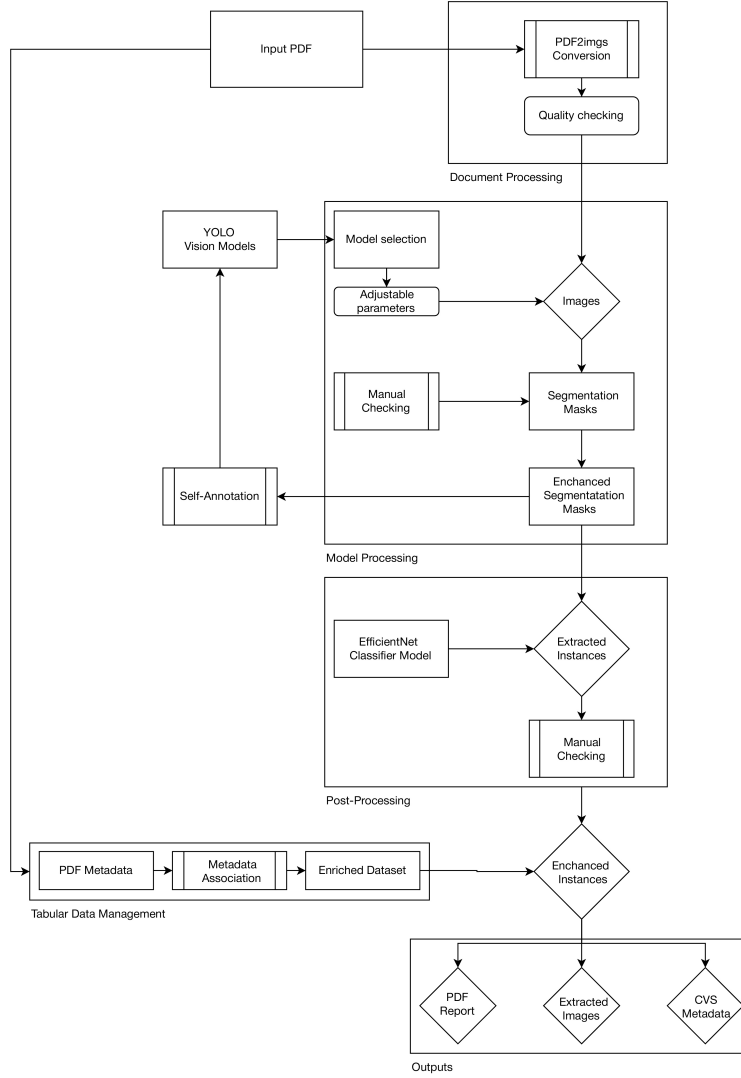

Figure 2: A schematic diagram shows the workflow of the proposed system. Made with [draw.io](https://draw.io).

### 3.2 Deep Learning Implementation

The application uses two deep learning models for image analysis: YOLO for image recognition and segmentation, and a custom EfficientNetV2 for classification.

#### 3.2.1 YOLO Model Architecture and Training Dataset

YOLO (Redmon et al. 2016; Jocher, Qiu, and Chaurasia 2023) is a popular open-source computer vision framework that includes a set of pre-trained models and architecture that can be used for various image analysis tasks, including object detection, instance segmentation, and pose detection. In this analysis, two models, YOLOv8 and YOLOv11, are compared to evaluate their performance. In both cases, the *Xlarge* version is used, which sacrifices execution speed for greater accuracy. The models are fine-tuned on a dataset of 4097 manually annotated archaeological pottery instances from 13 different publications from settlements and necropolises of the 2<sup>nd</sup> and 1<sup>st</sup> millennium BCE in continental Italy, covering a wide range of ceramic styles or types (Figure 3). In addition to the nature of the pottery itself, which can vary greatly in terms of shape, size and decoration, the publication of these data is faced with several stylistic and technical choices that pose a challenge to automatic analysis: for example, the profiles of the vessels can be sampled in different ways, as can the graphic rendering of the prospectus, especially shadows and decorations (Figure 4). It was therefore decided to use a heterogeneous dataset to ensure maximum generalisation of the model.

As customary, 80% of the images were used for training and the remaining 20% for validation. For both YOLOv8 and YOLOv11, an automatically defined batch number is used by the model to optimise the performance. In addition,

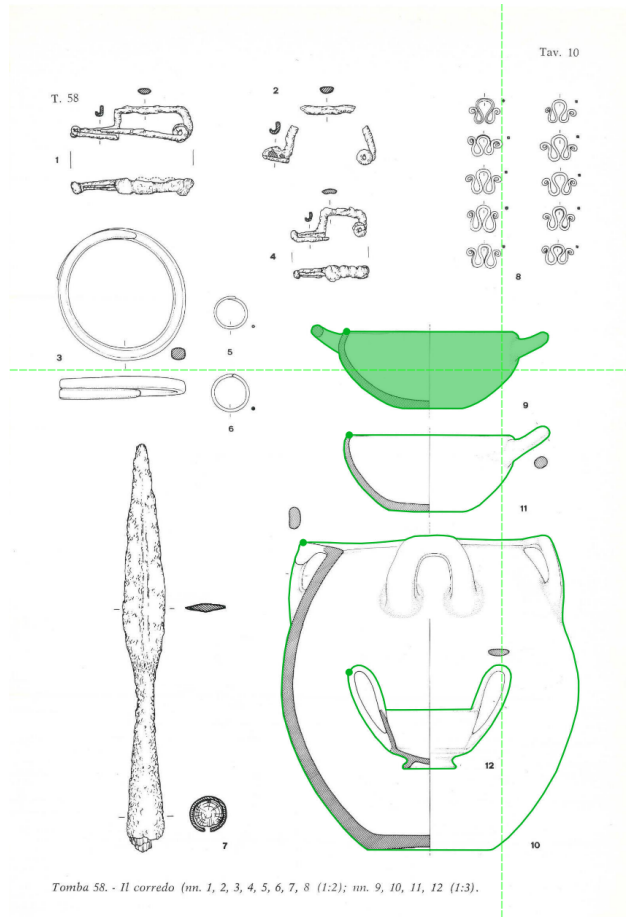

Figure 3: An annotated page by Parise Badoni and Ruggeri Giove (1980) using the software *LabelMe*.

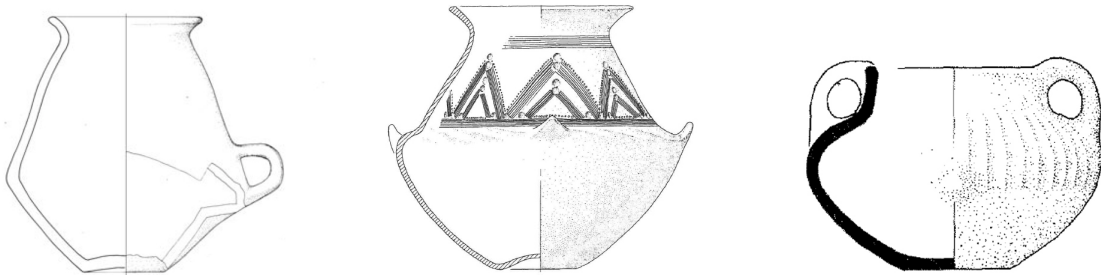

Figure 4: Some examples of the styles used in the representation of archaeological ceramics. From left to right: Bianco Peroni, Peroni, and Vanzetti (2010) pag. 105, tab. 62, AI; L. Salzani and Colonna (2010) pag. 326, tav. 11, B1; Moretti et al. (1963) pag. 108; tav. 36, c.

although a maximum number of epochs is set at 200, an early stopping parameter is set to avoid overfitting the model. The training configuration files are accessible on the GitHub repository. Due to copyright restrictions, the training dataset is not publicly available.

The table resume the dataset used for training the model (Table 1).

Table 1: The table shows the bibliographic references for the training dataset, as well as the number of annotations and the annotator (LC: Lorenzo Cardarelli; LP: Lucrezia Petrucci; AL: Annalisa Lapadula; DC: Dacia Cardarelli)

ID	References	Annotations	Annotator
ALF	Parise Badoni and Ruggeri Giove (1980)	136	LC
CMP_I	Chiaramonte Treré and D’Ercole (2003)	276	LC; LP
CMP_II	Chiaramonte Treré et al. (2010)	362	LP
FIAV	Perini (1994)	636	LP
FOSS_I	Cosentino, D’Ercole, and Mieli (2001)	104	AL
FOSS_II	Cosentino, D’Ercole, and Mieli (2004)	210	AL
LRS	Buranelli (1983)	170	DC
NRD	L. Salzani and Colonna (2010)	237	LC
MRN	Giaretti and Rubat Borel (2006)	109	LC
PDG	Bianco Peroni, Peroni, and Vanzetti (2010)	717	LC
QF_1963	Moretti et al. (1963)	306	LC
QF_1965	Ward-Perkins et al. (1965)	230	LC
TRRGLL	Pacciarelli (1999)	604	LC
Total		4097	

### 3.2.2 Classifications Model and Training

The second phase of the DL pipeline incorporates a classification model designed to standardise the presentation and interpretation of ceramic instances. This classification serves two primary purposes: (1) determining whether the instance represents a complete vessel (ENT) or a fragment (FRAG), and (2) standardising the orientation of each instance to ensure consistent presentation with the vessel’s mouth oriented upward (TOP/BOTTOM) and its section positioned to the left (LEFT/RIGHT).

The model’s training dataset includes different publications for a total of 4563 instances<sup>1</sup>, divided into the following categories:

- 2,428 fragmentary vessels
- 2,135 complete vessels

These base images are manually augmented to account for all possible orientation combinations (e.g., FRAG-TOP-RIGHT, FRAG-TOP-LEFT), resulting in 8 distinct configurations per instance and a comprehensive training set of 18,252 examples. In this training, 80% of the images are used for training and the remaining 20% for validation.

To effectively handle this multi-faceted classification task in a single network, a multi head architecture based on EfficientNetV2 is implemented. The multi head architecture consists of a shared backbone (EfficientNetV2) that extracts general features from the input images and three specialised classification heads, each dedicated to a specific categorisation task: vessel completeness (Type: ENT/FRAG), vertical orientation (Position: TOP/BOTTOM), and horizontal orientation (Rotation: LEFT/RIGHT). The model uses a combined loss function that aggregates the three individual losses to ensure balanced learning across all three tasks. Each loss is defined as the binary cross-entropy (Mao, Mohri, and Zhong 2023) between the prediction and the target from each classification head.

Further details on the model architecture and training configuration are available in the GitHub repository.

### 3.2.3 Self-Annotation Module

The *Self-Annotation* module is designed to facilitate the continuous improvement of the YOLO model through the generation of new training data. Once the model is applied and the manual corrections are made, the user can export the masks in a ready-to-use format for YOLO training (Figure 5). A script facilitates the fine-tuning of the model with the

<sup>1</sup>The publications used include Bietti Sestieri (1992), Weidig and Egg (2021), A. Cardarelli and Malnati (2003) in addition to the training dataset used for the YOLO model (Table 1). Dataset is handled to ensure consistency between fragmentary and complete vessels.



new data. Due to the complexity of the operation, this module is intended for users with a deeper understanding of DL concepts, no user interface is provided.

You can find the code and the documentation on the GitHub repository.

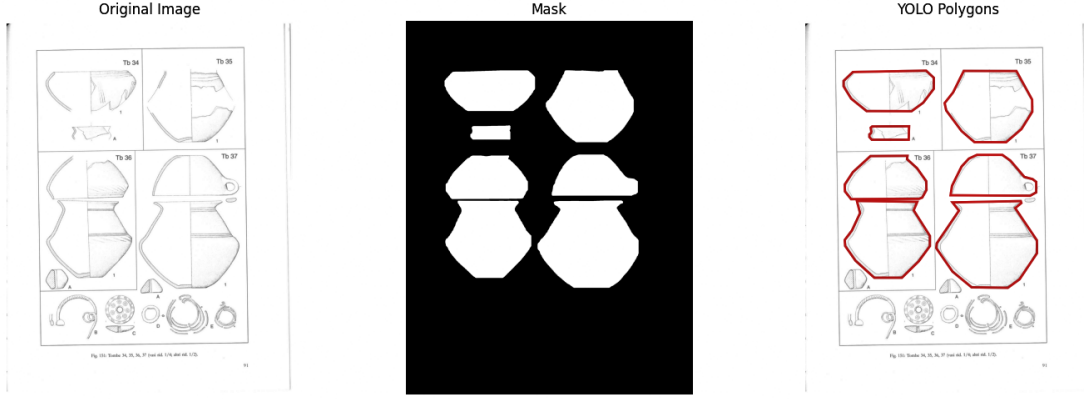

Figure 5: A plot showing how new training data is created by the *Self-Annotation* module.

### 3.3 The User Interface

A key goal of *PyPotteryLens* is to make advanced digital archaeology tools accessible to all practitioners, regardless of their technical background. While DL algorithms are traditionally developed and deployed using programming languages like Python, I recognise that many archaeologists may not have programming experience. This understanding drove the decision to develop an intuitive, user-friendly interface that bridges the gap between powerful ML capabilities and practical archaeological workflows and knowledge (Figure 6). In this sense, the graphical user interface serves two essential purposes. First, it democratises access to advanced analytical tools, allowing archaeologists to focus mainly on their expertise rather than technical implementation details. Second, it enables critical human-in-the-loop operations, such as manual corrections and verification of results, which are fundamental to maintaining high standards of archaeological documentation and difficult to implement through a line of code. The UI is built using Gradio (Abid et al. 2019), a modern web-based framework that runs in standard web browsers. This choice ensures that *PyPotteryLens* remains platform-independent and easily accessible across different operating systems. As you can see in the GitHub documentation page, five of the six main modules are accessible through the UI. The *Self-Annotation* module is instead accessible via a Python script, as it requires more specialised operations and is intended for users with a deeper understanding of DL concepts (Section 3.2.3).

### 3.4 Hardware and Software used

The software *LabelMe* (5.5.0) (Wada 2024) is used to manually annotate the dataset. Python 3.10 is used as the main programming language, for details on the libraries used see the *requirements.txt* file in the GitHub repository. The hardware used for training the YOLO models is a NVIDIA L40 GPU with 24GB of VRAM available on Google Colab. The training of the EfficientNetV2 model was performed on a NVIDIA RTX 3070Ti GPU with 8GB of VRAM.

System requirements and compatibility are provided in the GitHub documentation.

## 4 Results

### 4.1 Model Vision Performance

Since the proposed system identifies a single class, the metrics are evaluated according to the performance in box detection and mask segmentation. Before moving on to the analysis of the results, a brief introduction to the metrics used should be made.

The *Mean Average Precision (mAP)* measures the model’s accuracy in detecting and localising objects. It considers a detection as correct when the *Intersection over Union (IoU)*, (Equation 1) between the predicted bounding box  $B$  (or segmentation!) and the ground truth  $A$  exceeds a specific threshold.

$$IoU = \frac{Area_{intersection}}{Area_{union}} = \frac{|A \cap B|}{|A \cup B|} \quad (1)$$

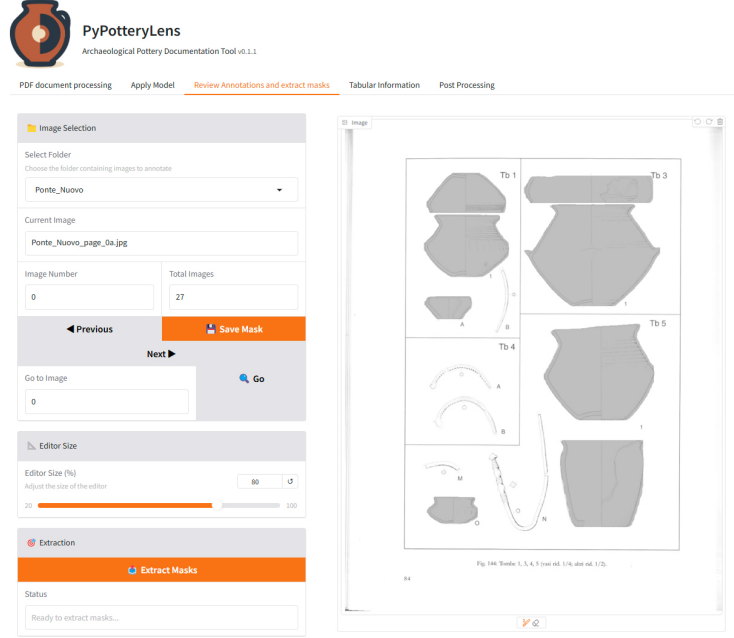

Figure 6: The user interface of *PyPotteryLens*. The tab for manual control of segmentation masks is shown.

In this analysis two key  $mAP$  variants are evaluated:

$mAP_{50}$  (Equation 2) : This metric considers detections to be successful if they achieve at least 50%  $IoU$  with ground truth.

$$mAP_{50} = \frac{1}{n} \sum_{i=1}^n AP_i^{50} \quad (2)$$

where  $AP_i^{50}$  is the *Average Precision* at  $IoU$  threshold of 0.5 for class  $i$

$mAP_{50-95}$  (Equation 3): This is a stricter metric that averages  $mAP$  values across different  $IoU$  thresholds from 50% to 95% (in steps of 5%).

$$mAP_{50:95} = \frac{1}{10} \sum_{t=0.5}^{0.95} mAP_t \quad (3)$$

where  $t$  increases in steps of 0.05

And also two classical metrics are evaluated:

**Precision** (Equation 4): it is a measure of the accuracy of positive predictions, calculated as the ratio of True Positive detections to all positive predictions (True Positives + False Positives). In other words, when the model identifies a pottery drawing, how often is it correct?

$$Precision = \frac{TP}{TP + FP} \quad (4)$$

Where  $TP$  are the True Positives and  $FP$  are the False Positives.

**Recall** (Equation 5): it measures the model's ability to find all relevant cases, calculated as the ratio of True Positive detections to all actual positive cases (True Positives + False Negatives). This indicates what percentage of actual pottery drawings in the documents are successfully detected by the model.



$$Recall = \frac{TP}{TP + FN} \quad (5)$$

The Table 2 shows the results obtained from the test set for the two models YOLOv8 and YOLOv11. All the metric can be also expressed as percentage.

Table 2: Performance metrics for YOLOv8 and YOLOv11 models on the test set,

Metric	YOLOv8		YOLOv11	
	Box	Segmentation	Box	Segmentation
$mAP50 - 95$	0.972	0.887	0.975	0.886
$mAP50$	0.99	0.989	0.989	0.988
<i>Precision</i>	0.972	0.972	0.966	0.963
<i>Recall</i>	0.967	0.967	0.967	0.964

Both models perform very well, with all parameters above 96% in both box and segmentation. The only exception was the segmentation  $mAP50 - 95$ , which achieved approximately 89% - still remarkably high considering that values above 50% are typically considered very good performance for this strict metric (Jegham et al. 2024). At first glance, therefore, the values obtained from the test set appear to give similar results. For our purposes, the segmentation scores best describe how the two models performed. Specifically, YOLOv8 has a higher Precision than YOLOv11 ( $\approx 10\%$ ), demonstrating greater resistance to False Positives.

Finally, to ensure the model’s compatibility with publications other than those used for training, including those from different historical periods and geographical locations, the model’s behaviour is evaluated on a test dataset composed of ceramics that differ in style and morphology from those used for training. Tables from the Hellenistic Roman period (Morel 1981) and a pre-Columbian site in Ecuador (Dyrdahl and Montalvo 2022) are chosen as test cases. For all contexts, analysis of performance distribution (Figure 7) reveals complementary strengths between the two models. While YOLOv11 demonstrates superior performance in  $mAP50 - 95$  metrics for both segmentation and box detection, YOLOv8 exhibits higher Precision and Recall values. This translates to greater resistance to False Positives and enhanced capability in detecting ceramic instances. These characteristics led to the selection of YOLOv8 for the final implementation, particularly as traditional mathematical morphology post-processing techniques (such as dilation) can effectively enhance the quality of its segmentation masks. Moving, to the model generalisation’s capabilities, the performance metrics on the test contexts aligned closely with training results, demonstrating robust generalisation capabilities across different archaeological materials (Figure 7).

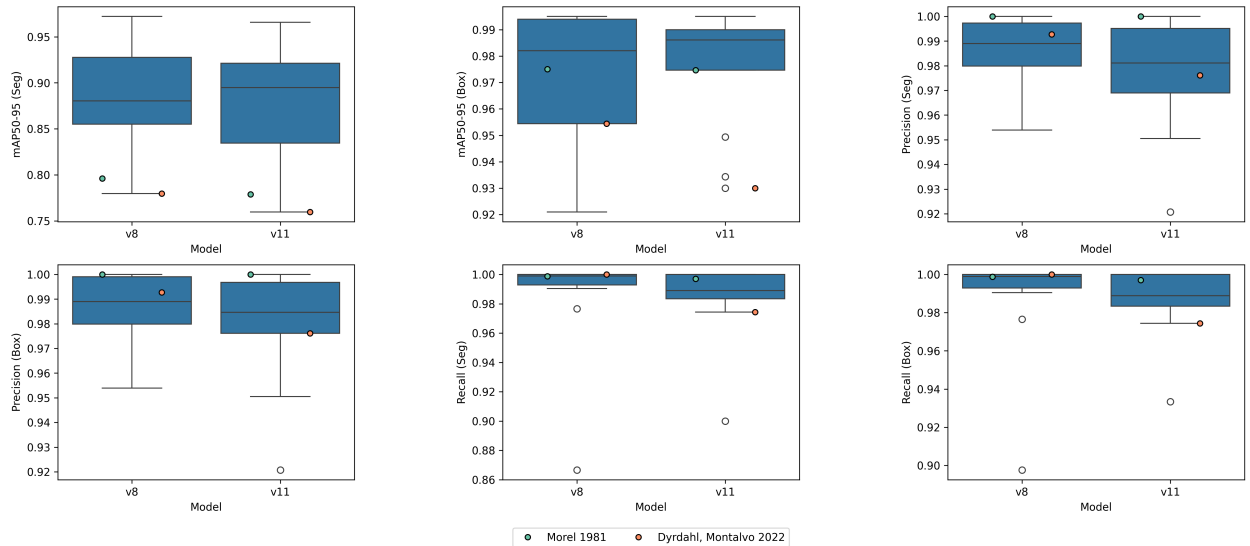

Figure 7: Series of boxplots showing model’s validation performance metrics. Specific extra-training set contexts are also plotted.

### 4.2 Model Classifier Performance

Based on the experiments performed, the classification model based on EfficientNetV2 performed successfully. The metrics calculated on the validation set are offered in the following plots (Figure 8).

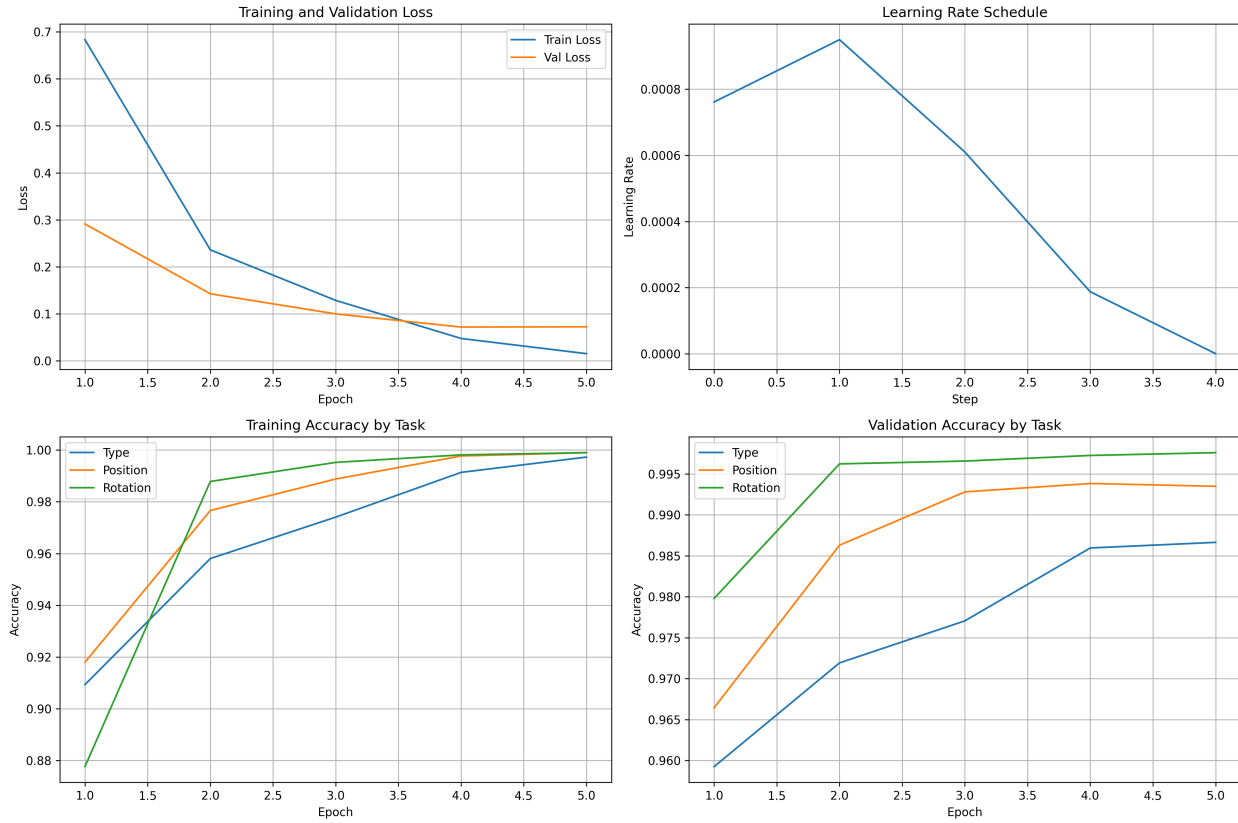

Figure 8: Series of plot showing different classification performance metrics, including Loss and Accuracy.

Although the Figure 8 shows a slight overfitting (especially from the end of epoch 4), the accuracy on the validation set continues to increase, reaching a value of around .995 for Rotation, .993 for Position and .986 for Type. The other metrics are Precision and Recall, which stand at values above .98 for all three classes (Table 3).

Table 3: Performance metrics for the multi-head EfficientNetV2 model on the validation set

	Type		Position		Rotation	
Metric	ENT	FRAG	BOTTOM	TOP	LEFT	RIGHT
Precision	0.984	0.983	0.996	0.997	0.997	0.996
Recall	0.980	0.991	0.997	0.996	0.996	0.997

In order to offer a more interpretable result, confusion matrices are shown for each class (Figure 9).

Analysis of performance metrics and confusion matrices indicates that vessel Type classification presents the highest complexity among all classification tasks. The model exhibits a bias towards classifying complete vessels as fragmentary, though the inverse misclassification occurs less frequently. Despite these minor classification biases, the overall performance metrics demonstrate robust classification reliability across all categories.

### 4.3 Case studies: Application examples

In this section I provide a series of application examples of the *PyPotteryLens* system to actual archaeological contexts and applications. The first example provides insight into the comparison between manual and automated recording, while the second example demonstrates the potential of the system for unsupervised analysis of archaeological pottery

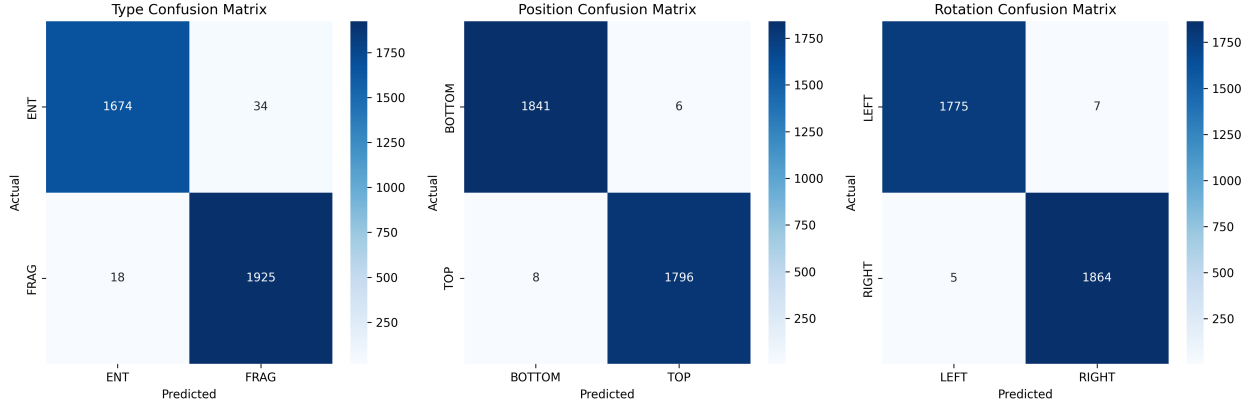

Figure 9: Confusion matrices for validation set

and, more generally, for the integration of DL techniques into archaeological research. All the experiments are performed on a desktop PC with an Intel i7-12700K CPU and 32GB of RAM.

**4.3.1 Comparison with manual recording: Ponte Nuovo case study**

To give a concrete idea of the time-savings compared to manual recording, a test was carried out on an archaeological context called Ponte Nuovo (Luciano Salzani 2005). The objective is to create drawing instances (more traditionally, cards), associate them with bibliographic tabular information (grave number, page, table and inventory) and create a PDF report. In the manual process, the author tried to create points of reference and comparison with the automatic recording, trying to maintain a sustainable rhythm. On the other hand, the author is an expert in manual archiving and is therefore familiar with the workflow and keyboard shortcuts of the several programs used (GIMP, Microsoft Excel) to speed up the process. The methods are compared on 6 main aspects (Table 4).

Table 4: Comparison of *PyPotteryLens* and manual processing steps for archaeological pottery filing

Step	<i>PyPotteryLens</i>	Manual recording
1. Document Processing	PDF to image conversion	Not required (direct PDF use)
2. Initial Processing	Vision model inference	Manual card creation
3. Cards Management	Annotation revision and mask extraction	Card cleaning (removing non-vessel elements)
4. Data Entry	Tabular information input	Tabular information input
5. Post-processing	Automated classification using ML model	Manual orientation correction
6. Final Output	Automated PDF report generation	Manual PDF report creation

The execution time (in seconds) for each step is shown in the barplot (Figure 10)

Excluding the Document Processing phase, which is not required for the manual approach, the time spent on documentation is significantly higher for the manual approach. This is somewhat predictable, but it is interesting to note in which operation there is the greatest gain in time. The most significant speed-ups include PDF creation: 1290x faster (2s vs 2580s); Post-processing: 136x faster (3s vs 409s); Vision Model/Card creation: 21x faster (51s vs 1077s). The moderate speed-ups include Cards Management: 3.3x faster (170s vs 560s) Tabular information: 1.8x faster (1237s vs 2252s). Simplifying, *PyPotteryLens* allowed a speed-up of 4.7x compared to manual recording. Eliminating the Tabular information input phase results in a speed-up of about 20x.

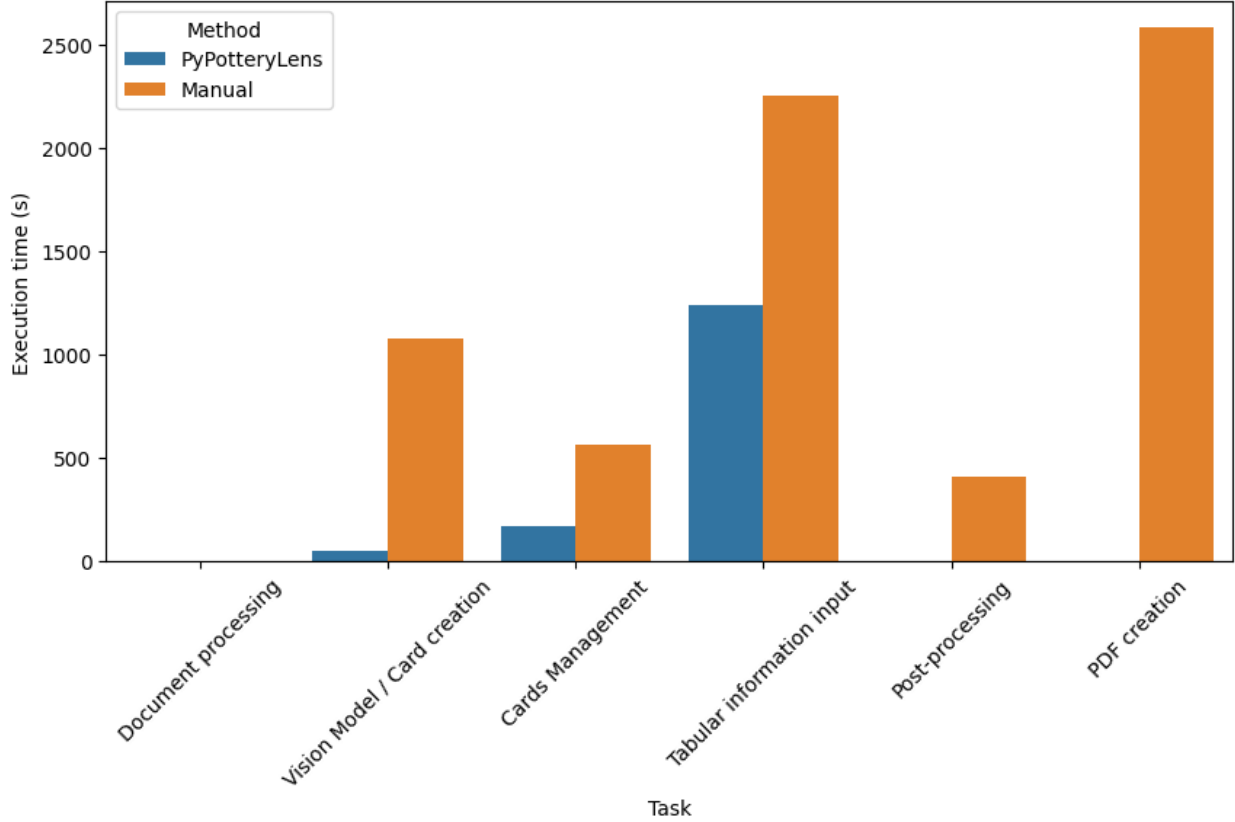

Figure 10: Barplot showing execution time (s) for each task

#### 4.3.2 Deep learning integration: unsupervised analysis of Ostia dell’Osa’s pottery

The files created through *PyPotteryLens* are highly standardised, semantically consistent and clean of other elements (Figure 1), making them ideal training data for DL applications. To demonstrate this capability, I implemented an unsupervised learning approach using a variational autoencoder (VAE) (Kingma and Welling 2013) architecture on pottery drawings from Osteria dell’Osa (Bietti Sestieri 1992), where over 2,300 instances are processed through the pipeline in about half an hour. The proposed VAE architecture combines the EfficientNetV2 (Section 4.2) as the encoder backbone with a specific designed decoder. The decoder implements a series of transposed convolutional layers with batch normalisation and ReLU activations, gradually reconstructing the encoded features back into pottery images (L. Cardarelli (2022)). The loss function used combines vanilla reconstruction loss (mean squared error) with the Kullback-Leibler divergence term (Equation 6):

$$\mathcal{L}(\theta, \phi) = \frac{1}{N} \sum_{i=1}^N (x_i - \hat{x}_i)^2 + \beta D_{KL}(q_\phi(z|x) || p(z)) \quad (6)$$

where  $x_i$  represents the input image,  $\hat{x}_i$  the reconstructed output,  $N$  is the batch size, and  $\beta$  weights the contribution of the Kullback-Leibler divergence term  $D_{KL}$  that regularises the latent space distribution, in this case defined as 0.00025. A latent dimension of 128 is selected to improve representational capacity.

To visualise the learned latent space, I employed UMAP (Uniform Manifold Approximation and Projection) (McInnes, Healy, and Melville 2018) in two configurations: a 2D projection for interpretable visualisation and a 5D embedding for more nuanced similarity analysis. The 2D projection reveals distinct clusters or groupings corresponding to different pottery typologies, while preserving global structure of the whole context, providing a useful and interpretable “map” of the assemblage (Figure 11).

The higher-dimensional embedding enables more precise similarity searches through  $k$ -nearest neighbor queries (Pinder, Shimada, and Gregory 1979). The effectiveness of the learned representations is validated through a qualitative analysis of nearest neighbors in latent space. For selected query vessels, a  $k$ -nearest neighbors ( $k=5$ ) is retrieved in the 5D UMAP

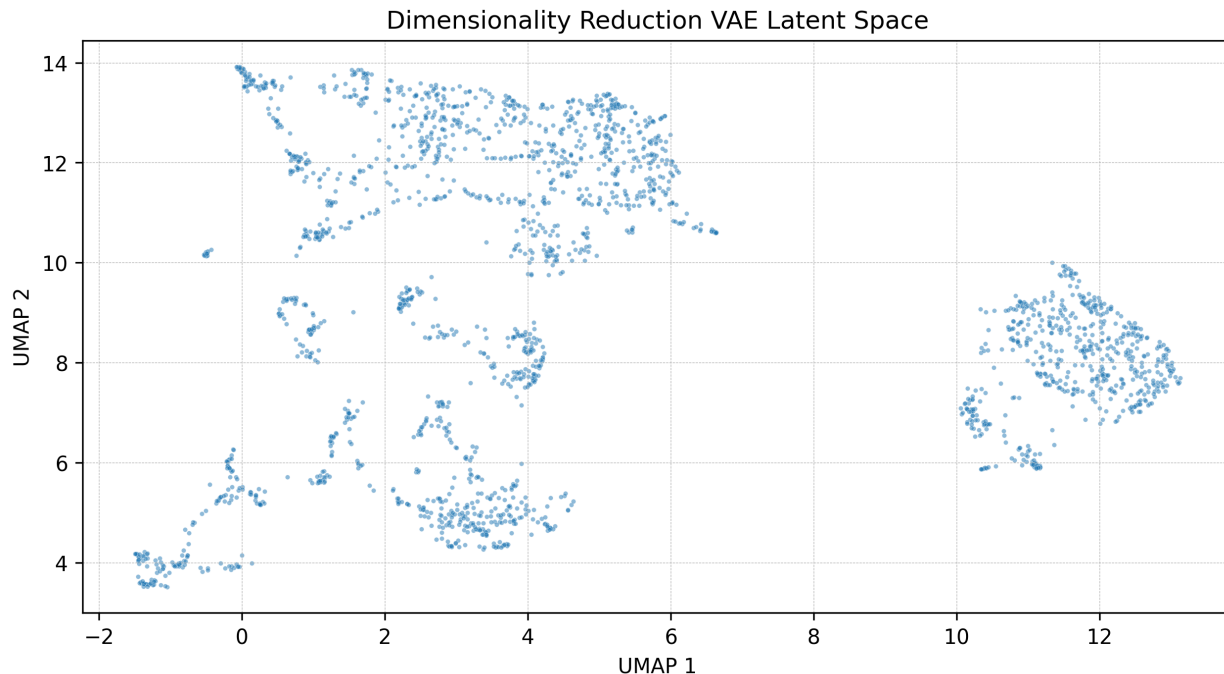

Figure 11: 2D embedding of the learned latent space. Clear groupings are visible and structured in an interpretable way.

space. The neighbors consistently exhibit similar morphological characteristics and decorative elements, suggesting the model learned meaningful pottery features without explicit supervision (Figure 12).

This capability has several significant archaeological implications, including the rapid identification of morphological parallels across large ceramic assemblages through unsupervised clustering and similarity analysis, and the quantitative assessment of ceramic variation within and between archaeological contexts. In addition, unlike previous approaches that focus solely on vessel profiles (Navarro et al. 2021; L. Cardarelli 2022; Parisotto et al. 2022), the method successfully captures and encodes the full visual information present in archaeological drawings, including decorative and handling elements. This approach opens up a more holistic perspective to pottery analysis, allowing the integration of multiple visual features into a single, unified (*latent*) representation.

## 5 Discussion

The evaluation results (Section 4.1) highlight the capabilities of *PyPotteryLens* in automating archaeological pottery documentation and recording. The system consistently achieves high performance metrics, with Precision and Recall values exceeding 95% in almost all cases. Only the  $mAP50 - 95$  for segmentation shows slightly lower values, though still maintaining robust and high performance. This high accuracy extends beyond the training dataset, as demonstrated by successful application to different archaeological contexts, indicating strong generalisation capabilities, even in the presence of diverse pottery styles and publication formats.

The classification model (Section 4.2) also shows high performance, with Precision and Recall values above 98% for all classes. The confusion matrices show small biases in the classification of vessel types, with a tendency to misclassify complete vessels as fragmentary. Despite these minor biases and the low complexity of the proposed classification task, the overall performance of the model is robust and reliable, and the proposed multi-head architecture allows for a good solution to multi-class classification tasks in archaeological reality.

Regarding the time-saving objective (Section 4.3.1), The Ponte Nuovo case study effectively illustrates the practical advantages of this automated approach. The significant reduction in processing time compared to manual documentation represents a substantial improvement in workflow efficiency. However, it's important to note that automation does not entirely eliminate the need for archaeological expertise. Rather, it transforms the role of the archaeologist from manual processor to expert validator, particularly in tasks requiring specialist knowledge and interpretation, such as chronological or typological classification. In fact, from an archaeological point of view, the impact of the system goes beyond mere time savings (although it does offer the possibility of increasing the sample size, for example). The automation of initial documentation and classification tasks allows archaeologists to focus more on interpretation and

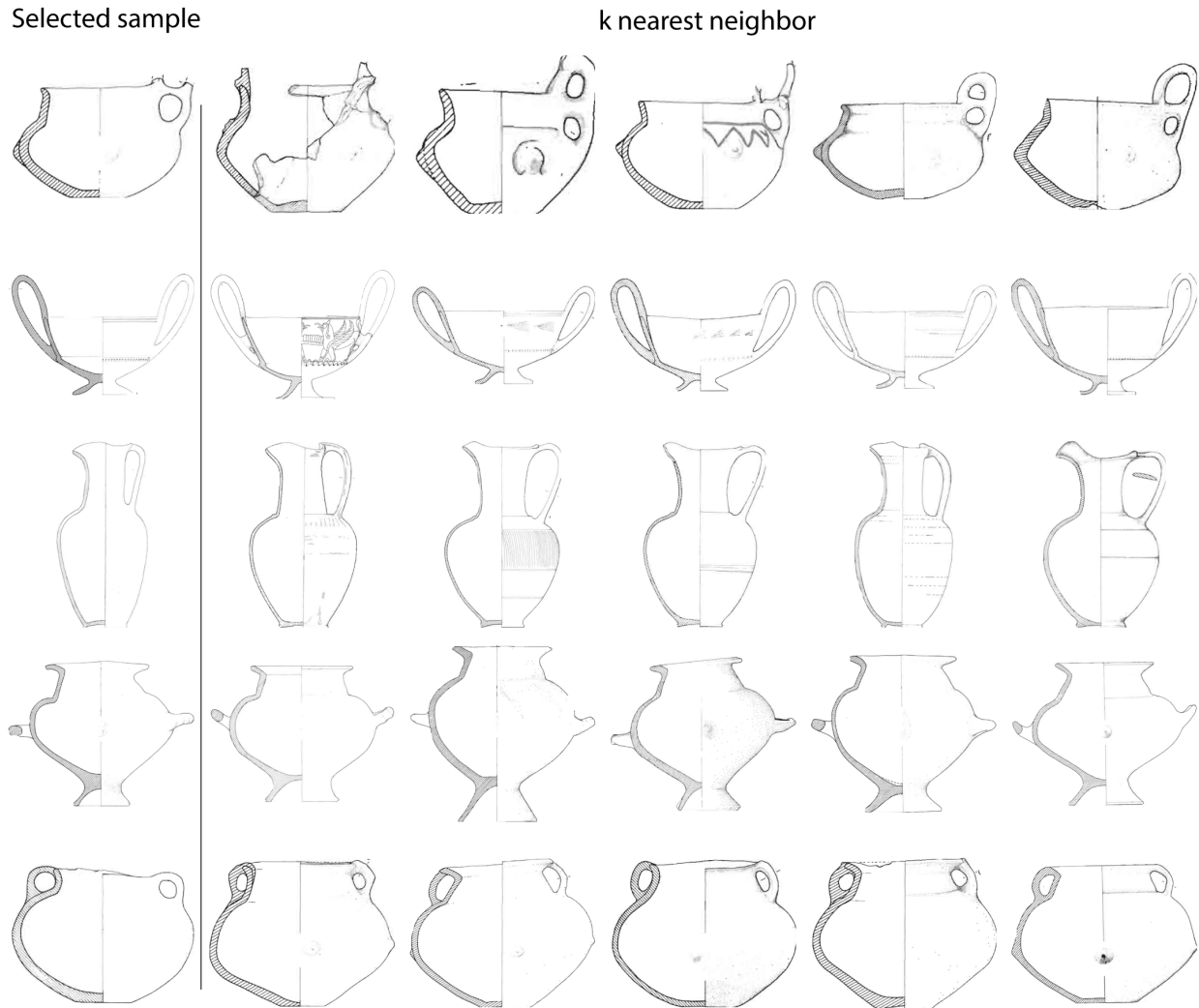

Figure 12:  $k$ -nearest neighbors of selected samples. Neighbors suggest clear morphological similarity

analysis, enhancing the quality of archaeological research. The inclusion of manual correction tools for both vision and classification models ensure that archaeological expertise remains a pivot point in the documentation process. A key challenge emerges in the processing of tabular information, where time savings are less pronounced compared to other tasks (Figure 10). This limitation stems from the inherent structure of archaeological publications, where contextual information is often presented in unstructured formats and may be physically separated from the associated images (e.g., in another chapter). While Large Language Models (LLMs) could potentially address this challenge, their implementation would require substantial computational resources. Another potential solution could involve the development custom YOLO models to detect page layouts and extract useful information (Zhao et al. 2024), speeding-up the tabular information input phase especially regarding bibliographic references input.

The Osteria dell’Osa example (Section 4.3.2), demonstrates the system’s potential as a base for further computational analysis. In this case, the data collection phase is completely automated. By analysing full images, our training data is generated from the system itself, eliminating a long and tedious documentation process. While a demonstration, the results are promising: using large training dataset the analysis can be expanded allowing for more complex and detailed analysis that include also decoration and handling elements. As a drawback, the use of images can be a limitation in the case of very different publication styles (Figure 4), where the system may struggle to generalise and focus on the style of the publication rather than the pottery itself. In this case, the use of a more complex model, such as a vision transformer (Ramachandran et al. (2019); Dosovitskiy et al. (2021)) or style-transfer (Dumoulin, Shlens, and Kudlur (2017); Jing et al. (2018); Zhu et al. (2020)), could be a solution, but it would require a more complex training process and a more powerful hardware. After all, more than 2,000 images were analysed in just over half an hour, making this



approach a powerful exploratory tool for archaeological analysis, allowing subsequent analyses to be more targeted and detailed. In this scenario, Data is power. What we can do with it is limited only by our imagination and our research questions.

Moving back to general considerations, the current focus on pottery, while potentially viewed as a limitation, actually demonstrates the system’s potential for expansion. *PyPotteryLens*’s modular architecture allows for adaptation to other material classes through targeted model training and vision model selection. It’s enough to train a new model on a dataset of a different material class, and the system can be easily adapted to a new task. The ability to process a single class of material can be seen as a weakness, as it limits the system’s versatility. However, this choice was made to ensure the system’s robustness and reliability in single-class documentation tasks, ensuring a straightforward and easy to develop solution.

Publishing the source code and documentation on GitHub ensures that the system is accessible and adaptable to the archaeological community, facilitating the development of new models, features and the application of the system to other materials.

## 6 Conclusion and Future Work

This study introduces *PyPotteryLens*, demonstrating how specialised DL approaches can transform archaeological pottery documentation while preserving its essential analytical value. The framework achieves exceptional performance metrics, reducing processing time by up to 20× compared to manual methods while maintaining high Precision and Recall rates across diverse archaeological contexts. Through the analysis of over 2,300 pottery instances from the Osteria dell’Osa assemblage, the system demonstrates remarkable capabilities for rapid and sophisticated unsupervised learning analysis, opening new pathways for exploring typological relationships and performs morphological analysis in standardised digital archives. The seamless integration of computer vision techniques with archaeological expertise creates a powerful tool that not only accelerates documentation processes but also enriches analytical capabilities through standardised data generation. Significantly, the framework’s modular, open-source architecture establishes a foundational methodology for computational archaeology that prioritises reproducibility, community engagement, and accessibility. Looking toward future developments, three key areas of improvement emerge as particularly promising: (1) Enhanced generalization through style-transfer approaches to accommodate the rich diversity of publication formats and drawing styles, particularly for autoencoding tasks; (2) Automated metadata extraction utilizing natural language processing and specialized YOLO-based models to capture contextual information from publication text; and (3) Expanded material coverage to adapt the framework for other archaeological materials, including lithics and metallurgical artifacts, while maintaining methodological consistency.

## 7 Data Availability

The software, documentation, and examples are available on [GitHub](#), while models are available on [HuggingFace](#). Due to copyright restrictions, the training dataset is not publicly available. Collaborations for the development of new datasets and software’s features are welcome.

## 8 Acknowledgements

The author would like to thank the annotators who contributed to the training dataset: Annalisa Lapadula, Dacia Cardarelli, Lucrezia Petrucci. The author would also like to thank Bruno Papa for the support in the development of the software.

## References

- Abid, Abubakar, Ali Abdalla, Ali Abid, Dawood Khan, Abdulrahman Alfozan, and James Zou. 2019. “Gradio: Hassle-Free Sharing and Testing of ML Models in the Wild.” <https://doi.org/10.48550/arXiv.1906.02569>.
- Adams, William Y., and Ernest W. Adams. 1991. *Archaeological Typology and Practical Reality: A Dialectical Approach to Artifact Classification and Sorting*. Cambridge: Cambridge University Press. <https://doi.org/10.1017/CBO9780511558207>.
- Allison, Penelope. 2008. “Dealing with Legacy Data - an Introduction.” *Internet Archaeology*, no. 24. <https://doi.org/10.11141/ia.24.8>.
- Amini, Massih-Reza, Vasilii Feofanov, Loic Pauletto, Lies Hadjadj, Emilie Devijver, and Yury Maximov. 2024. “Self-Training: A Survey.” arXiv. <https://doi.org/10.48550/arXiv.2202.12040>.
- Anichini, Francesca, Nachum Dershowitz, Nevio Dubbini, Gabriele Gattiglia, Barak Itkin, and Lior Wolf. 2021. “The Automatic Recognition of Ceramics from Only One Photo: The ArchAIDE App.” *Journal of Archaeological Science: Reports* 36 (April): 102788. <https://doi.org/10.1016/j.jasrep.2020.102788>.
- Bianco Peroni, Vera, Renato Peroni, and Alessandro Vanzetti. 2010. *La Necropoli Del Bronzo Finale Di Pianello Di Genga*. Grandi Contesti e Problemi Della Protostoria Italiana 13. Borgo San Lorenzo (FI) [i.e. Florence, Italy]: All’insegna del giglio.
- Bickler, Simon H. 2021. “Machine Learning Arrives in Archaeology.” *Advances in Archaeological Practice* 9 (2): 186–91. <https://doi.org/10.1017/aap.2021.6>.
- Bietti Sestieri, Anna Maria, ed. 1992. *La Necropoli Laziale Di Osteria Dell’osa*. Roma: Quasar.
- Buławka, Nazarij, Hector A. Orengo, and Iban Berganzo-Besga. 2024. “Deep Learning-Based Detection of Qanat Underground Water Distribution Systems Using HEXAGON Spy Satellite Imagery.” *Journal of Archaeological Science* 171 (November): 106053. <https://doi.org/10.1016/j.jas.2024.106053>.
- Buranelli, F. 1983. *La Necropoli Villanoviana "Le Rose" Di Tarquinia*. Quaderni Del Centro Di Studio Per l’archeologia Etrusco-Italica 6.
- Cacciari, I., and G. F. Pocobelli. 2022. “Machine Learning: A Novel Tool for Archaeology.” In *Handbook of Cultural Heritage Analysis*, edited by Sebastiano D’Amico and Valentina Venuti, 961–1002. Cham: Springer International Publishing. [https://doi.org/10.1007/978-3-030-60016-7\\_33](https://doi.org/10.1007/978-3-030-60016-7_33).
- Cardarelli, Andrea, and Luigi Malnati, eds. 2003. *Atlante Dei Beni Archeologici Della Provincia Di Modena. Volume III. Collina e Alta Pianura, Tomo 2*. Firenze: All’insegna del giglio.
- Cardarelli, Lorenzo. 2022. “A Deep Variational Convolutional Autoencoder for Unsupervised Features Extraction of Ceramic Profiles. A Case Study from Central Italy.” *Journal of Archaeological Science* 144 (August): 105640. <https://doi.org/10.1016/j.jas.2022.105640>.
- Caspari, Gino, and Pablo Crespo. 2019. “Convolutional Neural Networks for Archaeological Site Detection – Finding ‘Princely’ Tombs.” *Journal of Archaeological Science* 110 (October): 104998. <https://doi.org/10.1016/j.jas.2019.104998>.
- Chiaromonte Treré, Cristina, and Vincenzo D’Ercole. 2003. *La Necropoli Di Campovalanot. Ombe Orientalizzanti e Arcaiche. I*. BAR 1177. Oxford: J.; E. Hedges.
- Chiaromonte Treré, Cristina, Vincenzo D’Ercole, Cecilia Scotti, and Giorgio Baratti, eds. 2010. *La Necropoli Di Campovalano: Tombe Orientalizzanti e Arcaiche. II*. BAR International Series 2174. Oxford: Archaeopress.
- Clarke, David L. 1968. *Analytical Archaeology*. London: Routledge.
- Cosentino, Serena, Vincenzo D’Ercole, and Gianfranco Mieli, eds. 2001. *La Necropoli Di Fossa. Vol. 1: Le Testimonianze Più Antiche*. Documenti Dell’abruzzo Antico. Pescara: Carsa.
- . 2004. *La Necropoli Di Fossa. Vol. 2: I Corredi Orientalizzanti e Arcaici*. Pescara: Carsa.
- Cui, Jingwen, Ning Tao, Akam M. Omer, Cunlin Zhang, Qunxi Zhang, Yirong Ma, Zhiyang Zhang, et al. 2024. “Attention-Enhanced u-Net for Automatic Crack Detection in Ancient Murals Using Optical Pulsed Thermography.” *Journal of Cultural Heritage* 70 (November): 111–19. <https://doi.org/10.1016/j.culher.2024.08.015>.
- D’Orazio, Marco, Andrea Gianangeli, Francesco Monni, and Enrico Quagliarini. 2024. “Automatic Monitoring of the Biocolonisation of Historical Building’s Facades Through Convolutional Neural Networks (CNN).” *Journal of Cultural Heritage* 70 (November): 80–89. <https://doi.org/10.1016/j.culher.2024.08.012>.
- Demján, Peter, Peter Pavúk, and Christopher H. Roosevelt. 2023. “Laser-Aided Profile Measurement and Cluster Analysis of Ceramic Shapes.” *Journal of Field Archaeology* 48 (1): 1–18. <https://doi.org/10.1080/00934690.2022.2128549>.
- Dosovitskiy, Alexey, Lucas Beyer, Alexander Kolesnikov, Dirk Weissenborn, Xiaohua Zhai, Thomas Unterthiner, Mostafa Dehghani, et al. 2021. “An Image Is Worth 16x16 Words: Transformers for Image Recognition at Scale.” arXiv. <https://doi.org/10.48550/arXiv.2010.11929>.
- Dumoulin, Vincent, Jonathan Shlens, and Manjunath Kudlur. 2017. “A Learned Representation for Artistic Style.” arXiv. <https://doi.org/10.48550/arXiv.1610.07629>.

- Dyrdahl, Eric, and Carlos Montalvo. 2022. “Insights into a First Millennium BC (800 – 400 Cal BC) Social Network: Excavations at Las Orquídeas in the Northern Ecuadorian Sierra.” *Journal of Global Archaeology*, February, § 1–78 Seiten. <https://doi.org/10.34780/CYAS-A0WB>.
- Emmitt, Joshua, Sina Masoud-Ansari, Rebecca Phillipps, Stacey Middleton, Jennifer Graydon, and Simon Holdaway. 2022. “Machine Learning for Stone Artifact Identification: Distinguishing Worked Stone Artifacts from Natural Clasts Using Deep Neural Networks.” Edited by Jyotismita Chaki. *PLOS ONE* 17 (8): e0271582. <https://doi.org/10.1371/journal.pone.0271582>.
- Giaretti, M., and F. Rubat Borel. 2006. “Le Strutture e i Reperti Archeologici.” In *Navigando Lungo l’eridano. La Necropoli Protogolasecchiana Di Morano Sul Po*, edited by M. Venturino Gambari, 89–186.
- Gualandi, Maria Letizia, Gabriele Gattiglia, and Francesca Anichini. 2021. “An Open System for Collection and Automatic Recognition of Pottery Through Neural Network Algorithms.” *Heritage* 4 (1): 140–59. <https://doi.org/10.3390/heritage4010008>.
- He, Kaiming, Xiangyu Zhang, Shaoqing Ren, and Jian Sun. 2015. “Deep Residual Learning for Image Recognition.” arXiv. <https://doi.org/10.48550/arXiv.1512.03385>.
- Jegham, Nidhal, Chan Young Koh, Marwan Abdelatti, and Abdeltawab Hendawi. 2024. “Evaluating the Evolution of YOLO (You Only Look Once) Models: A Comprehensive Benchmark Study of YOLO11 and Its Predecessors.” arXiv. <https://doi.org/10.48550/arXiv.2411.00201>.
- Jing, Yongcheng, Yezhou Yang, Zunlei Feng, Jingwen Ye, Yizhou Yu, and Mingli Song. 2018. “Neural Style Transfer: A Review.” arXiv. <https://doi.org/10.48550/arXiv.1705.04058>.
- Jocher, Glenn, Jing Qiu, and Ayush Chaurasia. 2023. “Ultralytics YOLO.” <https://github.com/ultralytics/ultralytics>.
- Kingma, Diederik P., and Max Welling. 2013. “Auto-Encoding Variational Bayes.” arXiv. <https://doi.org/10.48550/arXiv.1312.6114>.
- Klein, Kevin, Alyssa Wohde, Alexander V. Gorelik, Volker Heyd, Ralf Lämmel, Yoan Diekmann, and Maxime Brami. 2024. “AutArch: An AI-Assisted Workflow for Object Detection and Automated Recording in Archaeological Catalogues.” arXiv. <https://doi.org/10.48550/arXiv.2311.17978>.
- Le, Quan, Luis Miralles-Pechuán, Shridhar Kulkarni, Jing Su, and Oisín Boydell. 2020. “An Overview of Deep Learning in Industry.” In *Data Analytics and AI*, by Jay Liebowitz, edited by Jay Liebowitz, 1st ed., 65–98. Auerbach Publications. <https://doi.org/10.1201/9781003019855-5>.
- Lodi, Andrea, Silvano Martello, and Daniele Vigo. 2002. “Recent Advances on Two-Dimensional Bin Packing Problems.” *Discrete Applied Mathematics* 123 (1): 379–96. [https://doi.org/10.1016/S0166-218X\(01\)00347-X](https://doi.org/10.1016/S0166-218X(01)00347-X).
- Maerten, Anne-Sofie, and Derya Soydaner. 2024. “From Paintbrush to Pixel: A Review of Deep Neural Networks in AI-Generated Art.” arXiv. <https://doi.org/10.48550/arXiv.2302.10913>.
- Mao, Anqi, Mehryar Mohri, and Yutao Zhong. 2023. “Cross-Entropy Loss Functions: Theoretical Analysis and Applications.” arXiv. <https://doi.org/10.48550/arXiv.2304.07288>.
- Marwick, Ben, Jade D’Alpoim Guedes, C Michael Barton, Lynsey Bates, Michael Baxter, Andrew Bevan, Elizabeth Bollwerk, et al. 2017. “Open Science in Archaeology.” *SAA Archaeological Record* 17 (September): 8–14. <https://doi.org/10.17605/OSF.IO/3D6XX>.
- McInnes, Leland, John Healy, and James Melville. 2018. “UMAP: Uniform Manifold Approximation and Projection for Dimension Reduction.” arXiv:1802.03426 [Cs, Stat]. <http://arxiv.org/abs/1802.03426>.
- Morel, Jean-Paul. 1981. *Céramique Campanienne: Les Formes*. Bibliothèque Des Écoles Françaises d’athènes Et de Rome [Ser. 1] 244. Roma: École Française.
- Moretti, M., A. De Agostino, J. B. Ward-Perkins, R. Staccioli, A. Vianello P., D. Ridgway, J. Close-Brooks, and M. T. Amorelli Falcioni. 1963. “Veio (Isola Farnese). – Scavi in Una Necropoli Villanoviana in Località «Quattro Fontanili».” *Notizie Degli Scavi Di Antichità XVII*: 77–272.
- Navarro, Pablo, Celia Cintas, Manuel Lucena, José Manuel Fuertes, Claudio Delrieux, and Manuel Molinos. 2021. “Learning Feature Representation of Iberian Ceramics with Automatic Classification Models.” *Journal of Cultural Heritage* 48 (March): 65–73. <https://doi.org/10.1016/j.culher.2021.01.003>.
- Navarro, Pablo, Celia Cintas, Manuel Lucena, José Manuel Fuertes, Rafael Segura, Claudio Delrieux, and Rolando González-José. 2022. “Reconstruction of Iberian Ceramic Potteries Using Generative Adversarial Networks.” *Scientific Reports* 12 (1): 10644. <https://doi.org/10.1038/s41598-022-14910-7>.
- Orton, Clive, and Michael Hughes. 2013. *Pottery in Archaeology*. 2nd ed. Cambridge University Press. <https://doi.org/10.1017/CBO9780511920066>.
- Pacciarelli, Marco. 1999. *Torre Galli: La Necropoli Della Prima Età Del Ferro: Scavi Paolo Orsi, 1922-23*. Studi e Testi. Soveria Mannelli (Catanzaro): Rubbettino.
- Parise Badoni, F., and M. Ruggeri Giove. 1980. *Alfedena, La Necropoli Di Campo Consolino. Scavi 1974-1979*.
- Parisotto, Simone, Ninetta Leone, Carola-Bibiane Schönlieb, and Alessandro Launaro. 2022. “Unsupervised Clustering of Roman Potsherds via Variational Autoencoders.” *Journal of Archaeological Science* 142 (June): 105598. <https://doi.org/10.1016/j.jas.2022.105598>.

- Perini, R. 1994. *Scavi Archeologici Nella Zona Palafitticola Di Fiave'-Carrera. Parte III Campagne 1969-1976. Resti Della Cultura Materiale Ceramica.*
- Pinder, David, Izumi Shimada, and David Gregory. 1979. "The Nearest-Neighbor Statistic: Archaeological Application and New Developments." *American Antiquity* 44 (3): 430–45. <https://doi.org/10.2307/279543>.
- Ramachandran, Prajit, Niki Parmar, Ashish Vaswani, Irwan Bello, Anselm Levskaya, and Jon Shlens. 2019. "Stand-Alone Self-Attention in Vision Models." In *Advances in Neural Information Processing Systems*. Vol. 32. Curran Associates, Inc. <https://proceedings.neurips.cc/paper/2019/hash/3416a75f4cea9109507cacd8e2f2aefc-Abstract.html>.
- Ramesh, Aditya, Mikhail Pavlov, Gabriel Goh, Scott Gray, Chelsea Voss, Alec Radford, Mark Chen, and Ilya Sutskever. 2021. "Zero-Shot Text-to-Image Generation." arXiv. <https://doi.org/10.48550/arXiv.2102.12092>.
- Read, Dwight W. 2009. *Artifact Classification: A Conceptual and Methodological Approach*. 1. paperback ed. Walnut Creek, Calif: Left Coast Press.
- Redmon, Joseph, Santosh Divvala, Ross Girshick, and Ali Farhadi. 2016. "You Only Look Once: Unified, Real-Time Object Detection." arXiv. <https://doi.org/10.48550/arXiv.1506.02640>.
- Sakai, Masato, Akihisa Sakurai, Siyuan Lu, Jorge Olano, Conrad M. Albrecht, Hendrik F. Hamann, and Marcus Freitag. 2024. "AI-Accelerated Nazca Survey Nearly Doubles the Number of Known Figurative Geoglyphs and Sheds Light on Their Purpose." *Proceedings of the National Academy of Sciences* 121 (40): e2407652121. <https://doi.org/10.1073/pnas.2407652121>.
- Salzani, L., and Cecilia Colonna, eds. 2010. *La Fragilità Dell'urna. I Recenti Scavi a Narde Necropoli Di Frattesina (XII-IX Sec. A.c.), Catalogo Della Mostra.*
- Salzani, Luciano. 2005. "La Necropoli Protostorica Di Ponte Nuovo a Gazzo Veronese." *Notizie Archeologiche Bergomensi* 13: 7–111.
- Shepard, Anna Osler. 1985. *Ceramics for the Archaeologist*. Repr. Publication / Carnegie Institution of Washington 609. Washington, DC: Carnegie Inst.
- Sinopoli, Carla M. 1991. *Approaches to Archaeological Ceramics*. Boston, MA: Springer US. <https://doi.org/10.1007/978-1-4757-9274-4>.
- Snow, Dean R. 2010. "Making Legacy Literature and Data Accessible in Archaeology." Edited by B. Frischer, Webb Crawford, and D. Koller. *Making History Interactive. Computer Applications and Quantitative Methods in Archaeology (CAA). Proceedings of the 37th International Conference, Williamsburg, Virginia, United States of America, March 22-26*, BAR international series S2079, 350–55.
- Tan, Mingxing, and Quoc V. Le. 2021. "EfficientNetV2: Smaller Models and Faster Training." arXiv. <https://doi.org/10.48550/arXiv.2104.00298>.
- Wada, Kentaro. 2024. "Labelme: Image Polygonal Annotation with Python." <https://doi.org/10.5281/zenodo.5711226>.
- Ward-Perkins, J. B., R. Staccioli, J. Close-Brooks, and A. Batchvarova. 1965. "Veio (Isola Farnese). – Continuazione Degli Scavi Nella Necropoli Villanoviana in Località «Quattro Fontanili»." *Notizie Degli Scavi Di Antichità* XIX: 49–236.
- Weidig, Joachim, and Markus Egg. 2021. *Bazzano – Ein Gräberfeld Bei l'aquila (Abruzzen)*. Propylaeum. <https://doi.org/10.11588/PROPYLAEUM.865>.
- Zhao, Zhiyuan, Hengrui Kang, Bin Wang, and Conghui He. 2024. "DocLayout-YOLO: Enhancing Document Layout Analysis Through Diverse Synthetic Data and Global-to-Local Adaptive Perception." arXiv. <https://doi.org/10.48550/arXiv.2410.12628>.
- Zhu, Jun-Yan, Taesung Park, Phillip Isola, and Alexei A. Efros. 2020. "Unpaired Image-to-Image Translation Using Cycle-Consistent Adversarial Networks." arXiv. <https://doi.org/10.48550/arXiv.1703.10593>.