

Towards Unbiased and Robust Spatio-Temporal Scene Graph Generation and Anticipation

Rohith Peddi
UT Dallas

Saurabh
IIT Delhi

Ayush Abhay Shrivastava
IIT Delhi

Parag Singla
IIT Delhi

Vibhav Gogate
UT Dallas

Abstract

*Spatio-Temporal Scene Graphs (STSGs) provide a concise and expressive representation of dynamic scenes by modeling objects and their evolving relationships over time. However, real-world visual relationships often exhibit a long-tailed distribution, causing existing methods for tasks like Video Scene Graph Generation (VidSGG) and Scene Graph Anticipation (SGA) to produce biased scene graphs. To this end, we propose **IMPARTAIL**, a novel training framework that leverages loss masking and curriculum learning to mitigate bias in the generation and anticipation of spatio-temporal scene graphs. Unlike prior methods that add extra architectural components to learn unbiased estimators, we propose an impartial training objective that reduces the dominance of head classes during learning and focuses on under-represented tail relationships. Our curriculum-driven mask generation strategy further empowers the model to adaptively adjust its bias mitigation strategy over time, enabling more balanced and robust estimations. To thoroughly assess performance under various distribution shifts, we also introduce two new tasks—Robust Spatio-Temporal Scene Graph Generation and Robust Scene Graph Anticipation—offering a challenging benchmark for evaluating the resilience of STSG models. Extensive experiments on the Action Genome dataset demonstrate the superior unbiased performance and robustness of our method compared to existing baselines.*

1. Introduction

Spatio-Temporal Scene Graphs (STSGs) are structured graphs where nodes correspond to objects and edges capture the evolving relationships between them over time [19, 25]. Unlike static scene graphs, STSGs offer nuanced video understanding, enabling autonomous systems to interpret interactions in real-time, anticipate changes, and make informed decisions [44]. Yet, constructing effective STSGs that mirror the intricacies of the dynamic, ever-changing real world remains an unsolved problem. In particular, real-world relationships follow a highly imbalanced, long-tailed distribution, with a handful of head classes appearing frequently

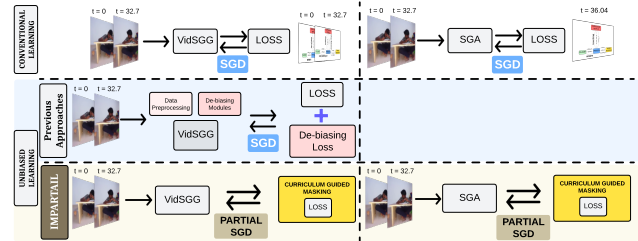

Figure 1. **Overview.** Row-1: Existing training pipelines in the literature for VidSGG/SGA tasks. Row-2: Prior unbiased learning work, exemplified by the supplementary architectural modules and loss functions. Row-3 (**IMPARTAIL**): A framework through which any prior object-centric, representation learning-based VidSGG/SGA method can be adapted to learn corresponding unbiased estimator. [2, 47]. In contrast, the vast majority of so-called tail classes are rare but essential for a detailed understanding. This imbalance often skews the learned models towards common relationships, yielding an incomplete, incorrect, unsafe, and distorted interpretation of the scene [45]. Addressing this challenge is vital: without a nuanced, detailed, and balanced representation, AI systems risk overlooking the subtle yet critical interpretations that define complex scenes.

To tackle this challenge, we introduce **IMPARTAIL**, a novel framework designed to overcome long-tail distribution bias in STSG generation. **IMPARTAIL** shifts attention from common head classes to tail classes, promoting a balanced representation that accurately captures all relationship types, not just the dominant ones. It employs a novel *loss masking* technique (similar in spirit to [2, 30]) that amplifies the influence of rare classes during training, ensuring an equitable learning process. This controlled shift towards tail classes allows models to address data distribution disparities without significantly compromising performance on head classes.

Real-world data poses an additional challenge beyond bias: *distributional shifts*. Factors such as lighting, occlusions, and background changes often degrade model performance, affecting the reliability of scene graphs in real-world applications [43, 57]. Conventional models struggle to generalize across these shifts, limiting their effectiveness in unpredictable conditions. To address this, we introduce two new

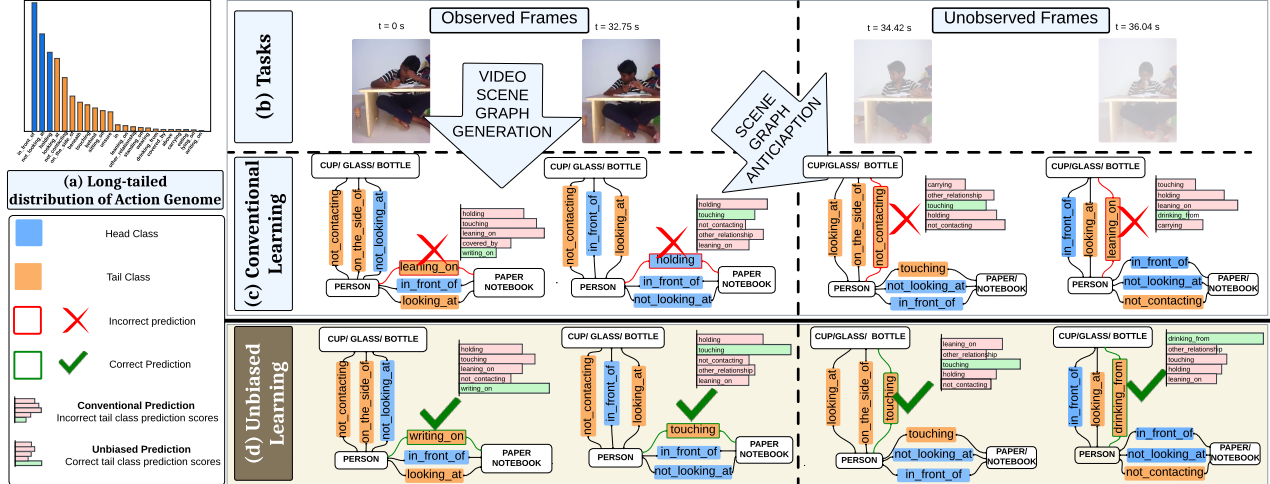

Figure 2. (a) **Long Tailed Distribution.** Predicates in Spatio-Temporal Scene Graph (STSG) datasets exhibit a long-tailed distribution; one such example is the Action Genome [19] dataset, whose distribution is described at the top left. (b) **Tasks.** We focus on two STSG tasks, including Video Scene Graph Generation (VidSGG) on the left and Scene Graph Anticipation (SGA) on the right. VidSGG entails the identification of fine-grained relationships between the objects observed in the video, such as *(Person, looking at, Paper Notebook)* and *(Person, not_looking_at, Paper Notebook)* in respective frames to the left. SGA aims to anticipate the evolution of these relationships to *(Person, touching, Cup)*, and eventually, *(Person, drinking_from, Cup)* [37]. (c) **Conventional Learning.** Due to the inherent long-tailed distribution of these datasets, models learnt using the conventional approaches focus more on the *head* classes and perform poorly on the *tail* classes as illustrated using the prediction scores of STTran [7] on *contacting* and *attention* relationships (refer middle row). (d) **Unbiased Learning.** To alleviate the dominance of *head* classes during training, in unbiased learning, we focus more on the *tail* classes, ensuring that the learnt models exhibit significantly better performance in predicting both *head* and *tail* classes (refer bottom row).

evaluation tasks—**Robust Spatio-Temporal Scene Graph Generation** and **Robust Scene Graph Anticipation**—that simulate realistic distributional shifts to assess model resilience under deployment-like conditions. Thus, this paper makes the following contributions¹:

- **IMPARTAIL.** We introduce a novel, effective, unbiased learning framework for generating and anticipating Spatio-Temporal Scene Graphs by leveraging Curriculum-Guided Masked Training with Partial Gradients [14, 31]. Our method is especially suited to address the challenges posed by the long-tailed distribution of real-world relationships.
- **Robustness Evaluation.** To assess the resilience of our model against real-world challenges, we systematically induce various corruptions in the input data [22, 45]. We thoroughly estimate the robustness and generalization capabilities by evaluating the model’s performance during the inference phase under these distribution shifts.
- **Empirical Validation.** We conduct extensive experiments on the Action Genome [19] benchmark dataset and compare it with existing state-of-the-art methods to empirically validate the efficacy of the proposed approach.

2. Related Work

Tasks. Image Scene Graph Generation (ImgSGG) focuses on representing static visual data—such as 2D and 3D images—as spatial graphs where objects are nodes and their relationships are edges. The field gained significant traction

with the foundational Visual Genome project [26]. Building upon this work, Kim et al. [25] extended the task to static 3D scene data by incorporating both RGB and depth information. Object interactions over time provide richer contextual information for dynamic visual content like videos. Transforming this content into structured Spatio-Temporal Scene Graphs (STSGs)—with nodes representing objects and edges capturing temporal relationships—is known as Video Scene Graph Generation (VidSGG). Research in VidSGG has concentrated on improving representation learning through advanced object-centric architectures such as STTran [7] and RelFormer [42]. Shifting the focus from the identification and generation of scene graphs, Peddi et al. [37] recently introduced the Scene Graph Anticipation (SGA) task, which aims to predict STSGs for future frames.

Unbiased Learning. TEMPURA [32] and FiCoDe[23] address the challenges posed by long-tailed datasets, such as those found in Action Genome [19] and VidVRD [41] and propose methods for unbiased VidSGG². Specifically, FiCoDe [23] mitigates bias by emphasizing temporal consistency and correcting the imbalanced distribution of visual relationships. Similarly, TEMPURA [32] addresses biases in relationship prediction with memory-guided training to generate balanced relationship representations and applies a Gaussian Mixture Model to reduce predictive uncertainty.

Long-Tail Learning. Long-tailed distributions with a few

¹Project: <https://rohithpeddi.github.io/#/impartail>

²To the best of our knowledge, we are the first to investigate biases in the SGA task and assess the robustness of both VidSGG and SGA models.

dominant classes (head classes) often overshadow a more significant number of underrepresented ones (tail classes). This class imbalance typically results in models that perform well on head classes but struggle to generalize to tail classes. To mitigate them, the research community has made significant strides in four directions, which include (a) Cost-Sensitive Learning [1, 8, 16, 34, 48, 48, 50, 53, 54], (b) Mixtures-Of-Experts [51], (c) Resampling Techniques [4, 9, 55], and (d) Specialized Architectures [55, 57].

Curriculum Learning (CL) is a training methodology that structures training by presenting simpler examples first and progressively introducing more complex ones. This approach aims to enhance learning efficiency by aligning the difficulty of training data with the model’s learning capacity at each stage [13–15, 27]. Despite its potential benefits, implementing CL presents significant challenges. A primary obstacle is the non-trivial task of distinguishing between *easy* and *hard* training samples. Difficulty measures can be predefined based on certain heuristics [18] or learned automatically during the training process [14, 20, 21, 27, 31, 38, 49]. Alongside difficulty assessment, a scheduling strategy is essential to determine when and how to introduce more challenging data [13].

3. Notation & Background

We borrow the notation from SceneSayer[37] and briefly present it below. Let \mathcal{D} correspond to the ground truth annotations of an STSG dataset. Consider a video segment V_1^T from a video V , modeled as a sequence of frames at discrete time steps $t = 1, 2, \dots, T$: $V_1^T = \{I^1, I^2, \dots, I^T\}$ where T denotes the total number of frames in the segment. In each frame I^t , we represent the scene using a **scene graph** that captures the visual objects and their pairwise relationships. Let $O^t = \{o_1^t, o_2^t, \dots, o_{N(t)}^t\}$ be the set of observed objects in frame I^t , where $N(t)$ is the number of objects in that frame. Each object o_k^t is characterized by: A bounding box $\mathbf{b}_k^t \in [0, 1]^4$, representing its spatial location and A category label $\mathbf{c}_k^t \in \mathcal{C}$, where \mathcal{C} is the set of object categories.

To describe relationships between objects, we define \mathcal{P} as the set of all predicate classes representing possible spatio-temporal relationships. For any pair of objects (o_i^t, o_j^t) , multiple predicates $\{p_{ijk}^t\}$ may be associated, where each predicate $p_{ijk}^t \in \mathcal{P}$. A **relationship instance** is then defined as the triplet: $r_{ijk}^t = (o_i^t, p_{ijk}^t, o_j^t)$. Thus, the scene graph \mathcal{G}^t for frame t consists of all such relationship triplets: $\mathcal{G}^t = \{r_{ijk}^t\}_{i,j,k}$. For each observed object o_i^t and each object pair (o_i^t, o_j^t) , we define probability distributions over object categories and predicate classes, respectively: $\hat{\mathbf{c}}_i^t \in [0, 1]^{|\mathcal{C}|}$ is the probability distribution over object categories for o_i^t and $\hat{\mathbf{p}}_{ij}^t \in [0, 1]^{|\mathcal{P}|}$ is the probability distribution over predicate classes for the pair (o_i^t, o_j^t) . These distributions are normalized, satisfying: $\sum_k \hat{\mathbf{c}}_k^t = 1$, $\sum_k \hat{\mathbf{p}}_{ijk}^t = 1$.

We distinguish and clarify the objectives of Video Scene

Graph Generation (VidSGG) and Scene Graph Anticipation (SGA) as follows: (a) **VidSGG**. The primary goal of **VidSGG** is to construct a sequence of scene graphs $\{\mathcal{G}^t\}_{t=1}^T$ corresponding to the observed video segment $V_1^T = \{I^t\}_{t=1}^T$. This involves: Identifying objects $\{o_k^t\}_{k=1}^{N(t)}$ within each frame I^t and Determining all possible pairwise relationships $\{r_{ijk}^t\}_{i,j,k}$ among the detected objects. (b) **SGA**. The main objective of **SGA** is to generate scene graphs $\{\mathcal{G}^t\}_{t=T+1}^{T+H}$ for future frames $V_{T+1}^{T+H} = \{I^t\}_{t=T+1}^{T+H}$ of the video, using information from the observed segment V_1^T . Here, H denotes the anticipation horizon³.

Graph Building Strategies. Following the literature in Video Scene Graph Generation (VidSGG) and Scene Graph Anticipation (SGA), we implement three distinct strategies for constructing scene graphs: (a) **With Constraint Strategy**: This strategy imposes a unique interaction constraint between every pair of objects within a scene. Specifically, for any two objects (o_i^t, o_j^t) , there exists exactly one relationship predicate p_{ij}^t (for each relationship category) that describes their interaction. We include these relationship triplets $\{r_{ij}^t\}_{ij}$ in the scene graph \mathcal{G}^t . (b) **No Constraint Strategy**: This approach allows for a more expressive graph structure by permitting multiple relationship predicates between any pair of interacting objects (o_i^t, o_j^t) . We incorporate all predicted relationship triplets $\{r_{ijk}^t\}_{i,j,k}$ into the scene graph \mathcal{G}^t . (c) **Semi-Constraint Strategy**: This strategy strikes a balance by permitting multiple relationships between object pairs (o_i^t, o_j^t) only if their confidence scores exceed a predefined threshold. Specifically, we add relationship triplets $\{r_{ijk}^t\}_{i,j,k}$ to the scene graph \mathcal{G}^t when the confidence score satisfies $\hat{p}_{ijk}^t > \theta_k$.

4. Technical Approach

In IMPARTAIL, we adopt an object-centric relationship representation processing pipeline as illustrated in Fig 3. Thus, it can be easily extended to de-bias any VidSGG/SGA method⁴ built on an object-centric relationship representation processing pipeline⁵. IMPARTAIL comprises four key components. (I) **Object Representation Processing Unit (ORPU)**: This module generates representations for objects detected in video frames. (II) **Spatio-Temporal Context Processing Unit (STPU)**: That constructs object-centric relationship representations tailored for two tasks: *observed relationships* for VidSGG and *anticipated relationships* for SGA. (III) **Relationship Predicate Decoders**: These decoders predict the

³Following the definition and assumptions from SceneSayer [37], we assume the continuity of observed objects in future frames.

⁴**Note: IMPARTAIL does not** train models for both tasks simultaneously. Instead, it adapts existing approaches for VidSGG/SGA **separately** and learns the corresponding VidSGG/SGA unbiased estimators.

⁵Most VidSGG [7, 11, 23, 32] and SGA [37] approaches share a similar object-centric relationship representation processing pipeline. We further note that recent SOTA VidSGG methods still rely on the object-centric pipelines introduced by STTran [7] and DSGDetr [11].

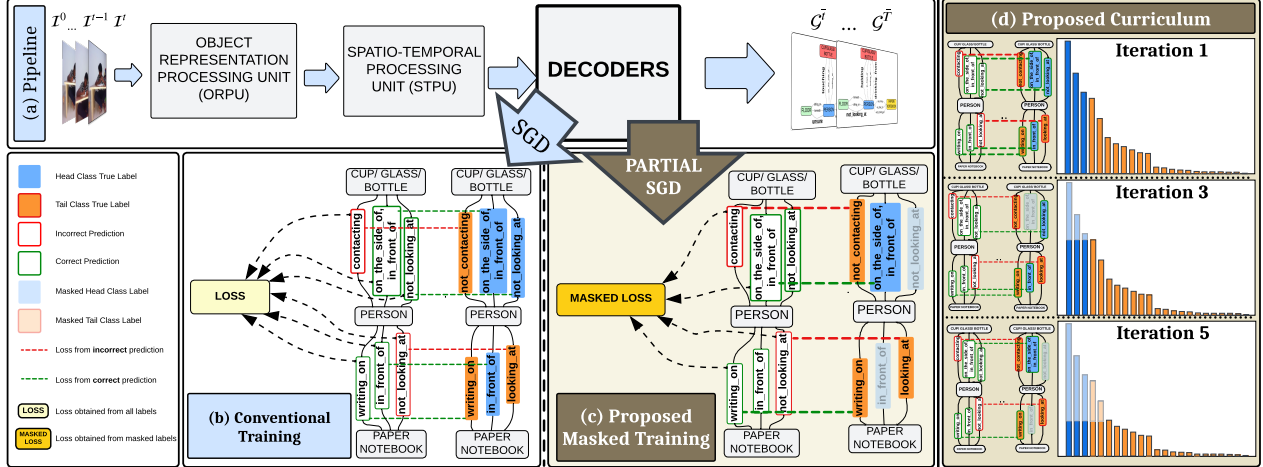

Figure 3. **Overview of IMPARTAIL** (a) **Pipeline**. The forward pass of IMPARTAIL begins with an ORPU, where initial object proposals are generated for each observed frame. These object representations are then fed to STPUs designed to construct spatio-temporal context-aware relationship representations of interacting objects. IMPARTAIL applied to both tasks VidSGG and SGA remains mostly the same, with an additional LDPU unit added for SGA to anticipate relationship representations for future frames. These observed (for VidSGG)/ anticipated (for SGA) relationship representations are then decoded to construct STSGs. (b) **Conventional Training**. Previous approaches estimated loss for all relationship predicates (head and tail classes). (c) **Masked Training**. With the inherent long-tailed nature of the STSG datasets, conventional training results in biased VidSGG and SGA models. Thus, to de-bias the training and learn an unbiased model, in IMPARTAIL, instead of estimating loss for all relationship predicates, we estimate a *masked loss*, where we selectively mask the labels corresponding to dominant head classes and void their contribution in learning. (d) **Curriculum-Guided Mask Generation**. In IMPARTAIL, we introduce a curriculum-based approach for masking relationship predicate labels during training. At each iteration, we adjust the selection of masked predicates to balance the class distribution progressively. As illustrated, initially, the model trains on the original, long-tailed distribution. As training advances, we systematically mask predicate labels from the *head* classes, gradually shifting the distribution toward uniformity.

relationship predicate labels corresponding to the observed or anticipated relationship representations⁶. (IV) **Masked Training with Partial Gradients**: We propose an impartial training objective based on loss masking that curbs the influence of dominant head classes. These are the classes that are over-represented in the dataset and often lead to biased predictions. Our approach aims to reduce their influence while focusing on under-represented tail relationships. Furthermore, our curriculum-driven mask generation method enables the model to iteratively refine its bias mitigation strategy over time, resulting in a balanced performance.

The following sections provide a comprehensive overview of the key components and training methodologies of IMPARTAIL. Specifically, In Sec. 4.1, we outline a detailed explanation of ORPU and STPU, including their respective inputs and outputs within a single training iteration. In Sec. 4.2, we provide a detailed description of the proposed Masked Training with Partial Gradients (refer Appendix Sec.4 for details on the specific changes employed to STSG methods).

4.1. IMPARTAIL Pipeline

Given that our approach builds upon existing object-centric VidSGG/SGA methods—most of which share similar representation processing pipelines—we detail the essential

⁶**Note:** As IMPARTAIL adapts existing VidSGG/SGA methods, we reuse the feature extraction strategy, ORPU, STPU and Predicate decoder blocks employed by corresponding object-centric VidSGG/SGA methods.

architectural components necessary for our framework to effectively adapt a method and learn an unbiased estimator⁷. (I) **Object Representation Processing Unit (ORPU)**: extracts visual features ($\{\mathbf{v}_i^t\}_{i=1}^{N(t)}$), bounding boxes ($\{\mathbf{b}_i^t\}_{i=1}^{N(t)}$), and object category distributions ($\{\mathbf{c}_i^t\}_{i=1}^{N(t)}$), for object proposals $\{o_i^t\}_{i=1}^{N(t)}$ in the observed frames utilizing a pre-trained object detector proposed by specific VidSGG/SGA method employed for adaptation. It then employs a transformer encoder [46] to integrate temporal information and generate temporally consistent object representations (see Eq. 1):

$$\mathbf{V}_i^{(n)} = \text{ObjectEncoder} \left(\mathbb{Q} = \mathbb{K} = \mathbb{V} = \mathbf{V}_i^{(n-1)} \right) \quad (1)$$

(II) **Spatio-Temporal Context Processing Unit (STPU)**: learns spatio-temporal context-aware relationship representations, it first constructs representations for interacting objects, then refines spatial context with an encoder, and finally use a transformer encoder to integrate spatio-temporal context information. Specifically, let the relationship representation for each observed frame I^t as \mathbf{z}_{ij}^t , where \mathbf{Z}^t is formed by stacking all relationship features $\{\mathbf{z}_{ij}^t\}_{ij}$ corresponding to the objects within the frame. \mathbf{Z}^t is then passed through the transformer encoder to produce spatial-context-aware representations. Next, it constructs the matrix \mathbf{Z}_{ij} by stacking

⁷Current methods in the literature typically incorporate at least one additional component beyond those specified here. IMPARTAIL directly integrates the ORPU, STPU units from them ignoring additional components

the relationship representations $\{\mathbf{z}_{ij}^t\}_{t=1}^T$ over all observed frames. This matrix \mathbf{Z}_{ij} is then passed through a temporal encoder, which aggregates temporal information across the representations (refer LDPU [37] for SGA task):

$$\begin{aligned} [\mathbf{Z}^t]^{(n)} &= \text{SpatialEncoder} \left(\mathbb{Q} = \mathbb{K} = \mathbb{V} = [\mathbf{Z}^t]^{(n-1)} \right) \\ \mathbf{Z}_{ij}^{(n)} &= \text{TemporalEncoder} \left(\mathbf{Q} = \mathbf{K} = \mathbf{V} = \mathbf{Z}_{ij}^{(n)} \right) \quad (2) \end{aligned}$$

(III) Relationship Predicate Decoders: Current VidSGG methods utilize a two-layer MLPs to decode the output relationship representations from STPU described as follows:

$$\hat{\mathbf{p}}_{ij}^t = \text{PredClassifier} \left(\mathbf{z}_{ij}^t \right), \forall t \in [1, \bar{T}] \quad (3)$$

We note that for SGA task, following SceneSayer [37], we employ two relationship predicate decoders. One for the observed relationship representations and the other for the anticipated representations described as follows:

$$\begin{aligned} \hat{\mathbf{p}}_{ij}^t &= \text{PredClassifier}_{\text{observed}} \left(\mathbf{z}_{ij}^t \right), \forall t \in [1, T] \\ \hat{\mathbf{p}}_{ij}^t &= \text{PredClassifier}_{\text{anticipated}} \left(\mathbf{z}_{ij}^t \right), \forall t \in [T+1, \bar{T}] \quad (4) \end{aligned}$$

4.2. Masked Training with Partial Gradients

Our approach stems from the observation that instead of re-weighting training data points which, in our case, entails uniformly adjusting the loss contributed by all relationship predicates derived from observed object pairs across all frames of video), selectively masking the loss contributed by head relationship classes helps learn unbiased estimators.

4.2.1. Masked Loss

During training, for epoch e and mask-ratio \mathcal{R}_m , Mask Generator generates a set of relationship predicate label masks $\mathcal{M}^{(e)} = \{\{\mathbf{m}_{ijk}^t\}_{ijk}\}_t$ where $\mathbf{m}_{ijk}^t \in \{0, 1\}$. Let $\mathcal{L}_{p_{ijk}^t}$ represent any loss defined over a relationship predicate⁸. A mask initialized i.e. setting $\mathbf{m}_{ijk}^t = 1$ voids the contribution of loss $\mathcal{L}_{p_{ijk}^t}$ and results in masked loss $\mathcal{L}_{p_{ij}^t}$ given by:

$$\mathcal{L}_{p_{ij}^t} = (1 - \mathbf{m}_{ijk}^t) * \mathcal{L}_{p_{ijk}^t} = \begin{cases} \mathcal{L}_{p_{ijk}^t} & \text{if } \mathbf{m}_{ijk}^t = 0 \\ 0 & \text{if } \mathbf{m}_{ijk}^t = 1 \end{cases} \quad (5)$$

VidSGG. models trained using IMPARTAIL, comprise the combination of (1) *Object Classification Loss* on the object representations and (2) *Masked Predicate Classification Loss* on the observed relationship representations as their training objective. The resultant objective is given in Eq 6:

$$\begin{aligned} \mathcal{L}_i &= \sum_{t=1}^{\bar{T}} \mathcal{L}_i^t; \quad \mathcal{L} = \sum_{t=1}^{\bar{T}} \mathcal{L}^t, \mathcal{L}^t = \sum_{ijk} \mathcal{L}_{p_{ijk}^t} \\ \underbrace{\hspace{10em}}_{(1)} & \quad \underbrace{\hspace{10em}}_{\text{Masked Predicate Classification Loss (2)}} \\ \mathcal{L} &= \sum_{t=1}^{\bar{T}} \left(\lambda_1 \mathcal{L}^t + \lambda_2 \sum_i \mathcal{L}_i^t \right) \quad (6) \end{aligned}$$

⁸(a) Two interacting objects (i,j) at time (t) can have multiple relationship predicates $\{p_{ijk}^t\}_k$ that describe the nature of the interaction; (b) We re-use the predicate loss $\mathcal{L}_{p_{ijk}^t}$ from the method employed for adaptation.

SGA. models trained using IMPARTAIL, comprise a combination of **masked losses** over two types of relationship representations: **(a) Observed Relationship Representations.** and **(b) Anticipated Relationship Representations.** and other method specific losses. Thus, the objective when **IMPARTAIL** is employed to SceneSayer [37] includes (1) Object Classification Loss, (2) Masked Predicate Classification Loss over observed relationship representations, (3) Masked Predicate Classification Loss over anticipated relationship representations, (4) Bounding Box Regression Loss and (5) Reconstruction Loss as shown in Eq 7.

$$\begin{aligned} \mathcal{L}_i &= \underbrace{\sum_{t=1}^{\bar{T}} \mathcal{L}_i^t}_{(1)}; \quad \mathcal{L}_{\text{gen}} = \underbrace{\sum_{t=1}^{\bar{T}} \mathcal{L}_{\text{gen}}^t, \mathcal{L}_{\text{gen}}^t = \sum_{ijk} \mathcal{L}_{p_{ijk}^t}}_{\text{Masked Observed Predicate Classification Loss (2)}} \\ \mathcal{L}_{\text{ant}}^{(1:T)} &= \underbrace{\sum_{t=T+1}^{\min(T+H, \bar{T})} \mathcal{L}_{\text{ant}}^t, \mathcal{L}_{\text{ant}}^t = \sum_{ijk} \mathcal{L}_{p_{ijk}^t}}_{\text{Masked Anticipated Predicate Classification Loss (3)}} \\ \mathcal{L} &= \sum_{t=1}^{\bar{T}} \left(\lambda_1 \mathcal{L}_{\text{gen}}^t + \lambda_2 \sum_i \mathcal{L}_i^t \right) + \\ & \sum_{T=3}^{\bar{T}-1} \left(\lambda_3 \mathcal{L}_{\text{ant}}^{(1:T)} + \lambda_4 \mathcal{L}_{\text{boxes}}^{(1:T)} + \lambda_5 \mathcal{L}_{\text{recon}}^{(1:T)} \right) \quad (7) \end{aligned}$$

4.2.2. Mask Generation

We observed that by tuning the **mask-ratio** (\mathcal{R}_m) (i.e., the fraction of annotations masked), **IMPARTAIL** can learn estimators along a spectrum, from those exhibiting bias to those that are unbiased. We propose **curriculum-guided** mask generation to enable models to progressively refine their bias mitigation strategy. Devising curriculum learning approaches for any problem necessitates precise, problem-specific definitions of three key components [31]: (a) the ability to rank tasks from easy to hard, (b) the capability to determine mastery over a specific task, and (c) a procedure that periodically integrates easier tasks with more challenging ones. Thus, **IMPARTAIL** employs a simple yet effective curriculum learning method to generate masks for relationship predicate labels to train VidSGG/SGA models.

Banking on the transformers' prowess in sequential processing tasks, we design the curriculum-guided mask generation process for VidSGG and SGA tasks using simple heuristics as follows: (a) *Ranking*: We assume that more data associated with a particular relationship predicate label indicates a better ability to predict that class. Therefore, we rank the hardness of relationship predicate learning based on the quantity of data available for them. (b) *Mastery*: We employ recall as the metric to assess mastery over predicting a specific relationship predicate class, while mean recall evaluates overall performance across all classes. (c) *Progressive*

Mixing: We propose a simple distributional strategy that progressively balances the class distribution, gradually moving toward an equilibrium where all classes are uniformly represented. Simply put, as training progresses, we stochastically mask the loss of head classes (easier examples), allowing the model to focus on learning about tail classes (harder examples) and the number of masks increases each epoch. The above discussion yields Alg 3.

Algorithm 1: Mask Generation

Input: Epoch: e , Sampling Ratio: \mathcal{R}_s , Dataset Annotations: \mathcal{D} , Total predicate labels: N , Total predicates: \mathcal{P} , Videos: \mathcal{V}
Output: Masks: $\mathcal{M}^{(e)}$

- 1 ***** Determine Target Counts [can also be a fixed input] *****
- 2 $\mathcal{R}_m = e \times \mathcal{R}_s$ **** Masking Ratio ****
- 3 $N_{\text{target}} = \text{round}(N \times \mathcal{R}_m)$
- 4 ***** Curriculum-based sampling probabilities $\text{Prob}[rel]$ *****
- 5 ***** Equally weighted distribution [can also be learnt] *****
- 6 Set $\text{Prob}[rel] = \frac{1}{|\mathcal{P}|}$
- 7 Sample target counts $Tar[rel]$ from Multinomial distribution:
 $Tar[rel] \sim \text{Multinomial}(N_{\text{target}}, \text{Prob}[rel])$
- 8 ***** Randomly sample instances of relationships in the dataset based on the target counts and construct filtered dataset *****
- 9 Construct filtered dataset \mathcal{F} **** See Appendix for details****
- 10 ***** Construct masks such that any relation present in the filtered dataset is unmasked, while all others are masked. *****
- 11 Initialize empty mask list $\mathcal{M}^{(e)}$
- 12 **foreach** Video v in \mathcal{V} **do**
- 13 Initialize video mask \mathcal{M}_v
- 14 **foreach** Frame f in v **do**
- 15 Initialize frame mask \mathcal{M}_f
- 16 **foreach** Object o in f **do**
- 17 Initialize object mask \mathcal{M}_o
- 18 Original relations \mathcal{R}_o from $\mathcal{D}[v][f]$
- 19 **foreach** Relation rel in \mathcal{R}_o **do**
- 20 **if** $rel \in \mathcal{F}[v][f]$ **then**
- 21 Set mask value $\mathcal{M}_o[rel] = 0$
- 22 **else**
- 23 Set mask value $\mathcal{M}_o[rel] = 1$
- 24 Add \mathcal{M}_o to \mathcal{M}_f
- 25 Add \mathcal{M}_f to \mathcal{M}_v
- 26 Add \mathcal{M}_v to $\mathcal{M}^{(e)}$

4.3. Robustness Evaluation

To evaluate the robustness of VidSGG and SGA models against distribution shifts caused by input corruptions, we introduce two tasks: Robust Video Scene Graph Generation and Robust Scene Graph Anticipation. Fig 4 illustrates the evaluation pipeline established to assess the trained models under these distribution shifts induced by input corruptions. As depicted in the figure, we employ a standard set of corruptions commonly used in adversarial robustness research.

5. Experiments

We apply IMPARTAIL to generate and anticipate STSGs on the Action Genome dataset [19]. We prepare the dataset by following the pre-processing steps described in [7, 37].

Evaluation Metric. We evaluate our models using the standard $\text{Recall}@K$ and $\text{meanRecall}@K$ metrics, where K

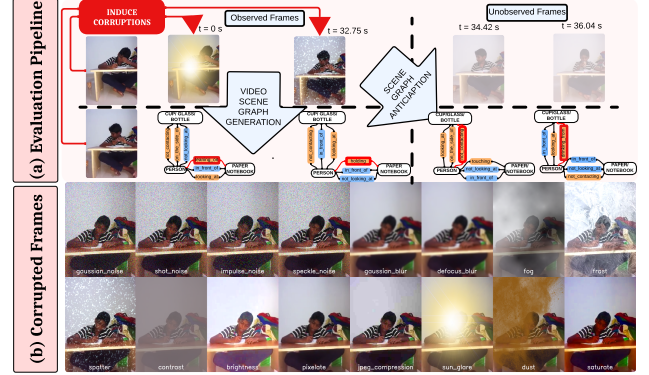

Figure 4. (a) **Robustness Evaluation Pipeline**: We present a methodology to assess the robustness of trained VidSGG and SGA models when faced with input distribution shifts. Specifically, we systematically introduce corruptions to the frames of test videos, which are then used as inputs for the trained models. (b) **Corrupted Frames**: We illustrate the frames obtained by inducing various categories of corruptions (see Appendix Sec.4 for details). takes values within the set $\{10, 20, 50\}$. The Recall@K metric measures the model’s capability to predict the relationships between observed objects in future frames. The long-tailed distribution of relationships in the training set [32] can generate biased scene graphs, causing frequently occurring relationships to dominate the Recall@K metrics. To address this imbalance, we utilize the mean recall metric introduced in [5], a more balanced metric that scores the model’s generalisation to all predictive classes.

In the following sections, we will assess the performance of IMPARTAIL on four tasks, namely: (a) **VidSGG**, (b) **SGA**, (c) **RobustVidSGG** and (d) **RobustSGA**. For each task, we first select previously published methods, train and evaluate them as per the instructions, then adapt them to IMPARTAIL framework, re-train and evaluate them. For VidSGG task, we selected STTran [7] and DSGDetr [11] as our baselines and for the SGA task, we selected STTran+ [37], STTran++ [37], DSGDetr+ [37], DSGDetr++ [37], SceneSayerODE [37], SceneSayerSDE [37] as our baselines.

Settings. We follow [7] and use three different settings to evaluate models for the VidSGG task. Each setting has a different level of information provided as input to the models. (a) **Scene Graph Detection (SGDET)**: We only provide frames of the video as input, (b) **Scene Graph Classification (SGCLS)**: Along with frames, bounding box information is provided as input to the model and (c) **Predicate Classification (PREDCLS)**: We provide frames, bounding boxes and object labels as input to the model. Similarly, for the SGA task, we follow SceneSayer [37] and use three different settings to evaluate models. (a) **Action Genome Scenes (AGS)**: In AGS, the model’s input is limited to raw frames of the video. (b) **Partially Grounded Action Genome Scenes (PGAGS)**: In this intermediate setting, along with raw video frames, we additionally input the model with precise bounding box information of active interacting objects observed in

Table 1. Mean Recall Results for VidSGG.

Mode	Method	With Constraint			No Constraint			Semi Constraint		
		mR@10	mR@20	mR@50	mR@10	mR@20	mR@50	mR@10	mR@20	mR@50
SGDET	STTran [7]	8.0	16.6	19.3	19.3	26.9	35.6	7.7	18.2	30.4
	+IMPARTAIL (Ours)	9.4 (+17.5%)	21.5 (+29.5%)	25.9 (+34.2%)	23.5 (+21.8%)	33.6 (+24.9%)	43.8 (+23.0%)	8.6 (+11.7%)	21.8 (+19.8%)	38.3 (+26.0%)
	DSGDetr [11]	6.7	14.7	19.1	23.3	29.8	36.0	6.5	16.0	30.4
	+IMPARTAIL (Ours)	7.5 (+11.9%)	17.8 (+21.1%)	23.7 (+24.1%)	27.5 (+18.0%)	35.2 (+18.1%)	43.3 (+20.3%)	7.3 (+12.3%)	18.4 (+15.0%)	36.6 (+20.4%)
SGCLS	STTran [7]	25.0	27.5	27.6	38.8	47.1	59.9	29.5	39.9	40.9
	+IMPARTAIL (Ours)	32.3 (+29.2%)	36.2 (+31.5%)	36.2 (+31.2%)	47.4 (+22.2%)	57.5 (+22.1%)	66.6 (+11.2%)	36.2 (+22.7%)	50.5 (+26.6%)	52.2 (+27.6%)
	DSGDetr [11]	25.6	28.1	28.1	39.9	49.4	64.6	30.1	40.6	41.6
	+IMPARTAIL (Ours)	32.2 (+25.8%)	36.0 (+28.1%)	36.0 (+28.1%)	48.8 (+22.3%)	59.6 (+20.6%)	70.1 (+8.5%)	36.8 (+22.3%)	52.4 (+29.1%)	54.9 (+32.0%)
PREDCLS	STTran [7]	30.5	34.7	34.8	45.7	63.4	80.5	36.6	51.8	53.8
	+IMPARTAIL (Ours)	44.0 (+44.3%)	52.7 (+51.9%)	52.9 (+52.0%)	65.5 (+43.3%)	82.0 (+29.3%)	93.0 (+15.5%)	47.7 (+30.3%)	69.7 (+34.6%)	73.4 (+36.4%)
	DSGDetr [11]	31.5	36.1	36.2	45.6	64.4	80.5	36.5	52.5	55.2
	+IMPARTAIL (Ours)	41.0 (+30.2%)	48.1 (+33.2%)	48.2 (+33.1%)	59.4 (+30.3%)	76.2 (+18.3%)	89.8 (+11.6%)	43.9 (+20.3%)	65.4 (+24.6%)	69.8 (+26.4%)

Table 2. Mean Recall Results for SGA.

\mathcal{F}	Method	AGS						PGAGS						GAGS					
		With Constraint			No Constraint			With Constraint			No Constraint			With Constraint			No Constraint		
		@10	@20	@50	@10	@20	@50	@10	@20	@50	@10	@20	@50	@10	@20	@50	@10	@20	@50
0.5	STTran++ [37]	7.9	16.4	18.4	13.9	21.3	38.5	14.3	15.8	15.8	20.9	32.5	50.1	17.8	20.9	21.0	25.2	39.4	63.5
	+IMPARTAIL (Ours)	9.3	18.7	20.9	12.1	20.0	39.6	20.2	22.0	22.0	24.0	34.9	50.5	19.9	22.7	22.8	23.7	39.2	64.1
	DSGDetr++ [37]	7.4	13.4	14.6	11.8	18.2	36.1	15.0	16.3	16.3	19.9	32.3	50.6	17.1	20.0	20.0	23.2	37.3	62.9
	+IMPARTAIL (Ours)	8.9	17.0	18.6	13.1	21.6	39.6	18.6	20.1	20.1	22.6	35.2	52.5	21.2	24.5	24.6	28.2	42.2	64.9
	SceneSayerODE [37]	5.8	12.6	16.9	14.0	22.3	36.5	11.2	12.8	12.8	16.9	26.3	45.7	17.5	20.7	20.9	24.9	38.0	61.8
	+IMPARTAIL (Ours)	6.8	16.1	22.0	15.6	24.8	39.7	14.5	16.4	16.4	22.7	33.6	49.7	19.3	23.2	23.5	26.5	40.9	63.2
0.7	SceneSayerSDE [37]	6.4	13.7	18.3	15.4	23.7	38.7	15.2	17.5	17.5	22.9	34.3	51.0	18.2	21.7	21.8	25.0	39.0	62.7
	+IMPARTAIL (Ours)	7.4	19.1	27.7	21.8	31.4	45.4	15.7	17.9	17.9	23.6	34.3	56.1	17.8	21.2	21.4	27.0	40.7	63.6
	STTran++ [37]	9.1	18.2	20.2	15.7	23.7	41.9	17.2	18.6	18.6	25.3	38.3	56.1	21.9	25.0	25.0	31.2	47.0	75.4
	+IMPARTAIL (Ours)	10.9	21.9	24.1	14.0	23.2	43.7	21.0	22.7	22.7	28.0	41.7	57.1	25.8	29.1	29.1	31.1	49.2	76.5
	DSGDetr++ [37]	8.4	14.8	16.0	13.2	20.0	38.8	18.1	19.4	19.4	24.8	39.5	57.3	20.8	23.8	23.8	28.6	46.1	73.8
	+IMPARTAIL (Ours)	10.5	19.5	21.2	14.9	24.8	43.9	20.6	21.8	21.8	26.3	41.0	58.1	28.3	32.5	32.5	31.4	49.7	75.7
	SceneSayerODE [37]	6.7	14.0	18.5	16.4	24.9	40.5	13.6	15.1	15.1	20.5	32.4	52.8	20.7	24.0	24.0	29.8	45.2	72.0
	+IMPARTAIL (Ours)	6.8	13.9	18.2	17.5	25.8	41.1	22.2	25.6	25.7	30.7	43.9	55.9	23.2	27.5	27.5	31.7	49.9	73.8
	SceneSayerSDE [37]	7.1	14.6	19.3	17.3	26.1	42.5	17.9	19.9	19.9	27.0	40.2	57.2	21.0	24.6	24.6	30.2	45.4	72.8
	+IMPARTAIL (Ours)	8.6	21.3	29.3	25.6	35.1	50.0	25.9	30.0	30.1	35.5	48.2	58.5	20.9	24.4	24.4	31.6	47.9	73.4

the scene. (c) **Grounded Action Genome Scenes (GAGS):** In this model takes precise bounding box information and the categories of the observed interacting objects as input.

Remark. Although IMPARTAIL is designed to learn estimators ranging from biased to unbiased through tuning the mask ratio in mask generation algorithm Alg 3, our experiments on ActionGenome revealed that a fixed Stochastic Masking Ratio of 0.9 delivered **similar performance** in mean recall metrics to a sequential strategy that started at a masking ratio of 0.6 and gradually increased to 0.9. Moreover, the fixed ratio also showed competitive results within fewer training epochs. Therefore, in the paper to report results, we opted for a fixed Masking Ratio of 0.9⁹. For completeness, we provide a thorough ablation in the Appendix.

5.1. Video Scene Graph Generation.

We first trained and evaluated the chosen baseline models. Next, we integrated IMPARTAIL into these baselines and conducted retraining and evaluation. Our experiments encompassed three VidSGG modes SGDET, SGCLS, and PREDCLS and each included three distinct settings: (1) With Constraint, (2) No Constraint, and (3) Semi Constraint. As

⁹Due to the skewed distribution of the dataset, using a 0.9 masking ratio creates a scenario where, in each training epoch, the model primarily samples head (easier) classes while leaving tail (harder) classes unaltered.

demonstrated in Table 1, models trained using IMPARTAIL consistently outperformed the chosen VidSGG baselines.

Insights: Our results indicate a significant improvement of approximately $\sim 12\%$ in mR@10 across all configurations for SGDET, a $\sim 22\%$ increase in mR@10 for the SGCLS mode, and at least $\sim 20\%$ improvement in mR@10 for the PREDCLS mode. Moreover, our results are on par and occasionally surpass SOTA unbiased learning methods [32]¹⁰.

5.2. Scene Graph Anticipation.

We employed a procedure for training and evaluating SGA models that closely mirrors our approach for VidSGG. First, we trained and evaluated the chosen baseline models. We then integrated these models into the IMPARTAIL framework, retrained them, and re-evaluated their performance. As demonstrated in Table 2, Models trained using IMPARTAIL consistently outperformed their baseline variants.

Insights: (1) The results demonstrate an improvement of $\sim 12\%$ in mR@10 metric across all modes in STTran++ and DSGDetr++. Although the performance is sometimes inferior, it closely aligns with the non-IMPARTAIL variants. (2) We also note that SceneSayer ODE/SDE models trained using IMPARTAIL demonstrated an improvement of $\sim 20\%$.

¹⁰**Note:** (a) SOTA at the time of writing this paper, (b) These improvements were achieved without introducing any new architectural components

Table 3. Robustness Evaluation Results for VidSGG.

S	Mode	Corruption	Method	With Constraint			No Constraint					Semi Constraint				
				mR@10	mR@20	mR@50	R@10	R@20	R@50	mR@10	mR@20	mR@50	mR@10	mR@20	mR@50	
3	SGCLS	Gaussian Noise	DSGDetr [11]	9.6	10.3	10.3	20.9	25.4	26.8	15.7	19.4	23.4	11.4	15.3	15.7	
			+IMPARTAIL (Ours)	13.7 (+42.7%)	14.9 (+44.7%)	15.0 (+45.6%)	21.0 (+40.5%)	27.3 (+7.5%)	30.1 (+12.3%)	20.8 (+32.5%)	25.4 (+30.9%)	29.1 (+24.4%)	15.6 (+36.8%)	21.5 (+40.5%)	22.2 (+41.4%)	
		Fog	DSGDetr [11]	22.6	24.9	24.9	47.8	58.4	62.0	35.5	43.4	54.6	26.6	36.1	37.2	
			+IMPARTAIL (Ours)	28.3 (+25.2%)	31.8 (+27.7%)	31.9 (+28.1%)	42.6 (-10.9%)	56.0 (-4.1%)	62.1 (+0.2%)	43.8 (+23.4%)	53.0 (+22.1%)	61.7 (+13.0%)	31.8 (+19.5%)	45.7 (+26.6%)	48.2 (+29.6%)	
		Frost	DSGDetr [11]	16.7	18.5	18.5	34.5	42.3	45.1	26.8	33.0	40.1	19.6	26.8	27.7	
			+IMPARTAIL (Ours)	22.4 (+34.1%)	25.0 (+35.1%)	25.1 (+35.7%)	31.9 (-7.5%)	42.0 (-0.7%)	47.1 (+4.4%)	34.9 (+30.2%)	42.3 (+28.2%)	48.2 (+20.2%)	25.9 (+32.1%)	36.5 (+36.2%)	38.4 (+38.6%)	
	Brightness	DSGDetr [11]	23.6	25.7	25.7	50.8	61.9	65.5	36.8	45.4	57.5	27.6	37.5	38.6		
		+IMPARTAIL (Ours)	29.8 (+26.3%)	33.2 (+29.2%)	33.2 (+29.2%)	45.5 (-10.4%)	59.9 (-3.2%)	66.1 (+0.9%)	45.0 (+22.3%)	55.4 (+22.0%)	65.3 (+13.6%)	33.7 (+22.1%)	48.1 (+28.3%)	50.6 (+31.1%)		
	Sun Glare	DSGDetr [11]	12.1	13.2	13.2	26.3	32.5	34.7	19.3	24.4	30.2	14.2	19.2	19.6		
		+IMPARTAIL (Ours)	17.3 (+43.0%)	19.4 (+47.0%)	19.4 (+47.0%)	25.8 (-1.9%)	34.3 (+5.5%)	38.5 (+11.0%)	26.6 (+37.8%)	32.2 (+32.0%)	37.3 (+23.5%)	19.4 (+36.6%)	27.6 (+43.7%)	29.0 (+48.0%)		
	5	PREDCLS	Gaussian Noise	STTran [7]	20.0	22.3	22.4	64.2	87.6	99.0	31.4	52.5	79.7	26.0	36.6	38.5
				+IMPARTAIL (Ours)	37.6 (+88.0%)	43.8 (+96.4%)	43.9 (+96.0%)	62.5 (-2.6%)	84.6 (-3.4%)	99.0 (0.0%)	57.5 (+83.1%)	77.7 (+48.0%)	92.7 (+16.3%)	42.2 (+62.3%)	60.0 (+63.9%)	62.9 (+63.4%)
Fog			STTran [7]	26.5	30.2	30.3	70.2	91.1	99.1	41.6	61.0	80.5	33.2	46.8	48.7	
			+IMPARTAIL (Ours)	42.6 (+60.8%)	50.9 (+68.5%)	51.1 (+68.6%)	64.8 (-7.7%)	86.3 (-5.3%)	98.8 (-0.3%)	63.8 (+53.4%)	80.2 (+31.5%)	92.7 (+15.2%)	46.2 (+39.2%)	65.5 (+40.0%)	68.2 (+40.0%)	
Frost			STTran [7]	25.6	29.2	29.2	69.4	90.7	99.1	41.0	60.9	80.5	32.7	46.1	48.0	
			+IMPARTAIL (Ours)	41.0 (+60.2%)	49.0 (+67.8%)	49.2 (+68.5%)	62.2 (-10.4%)	84.3 (-7.1%)	98.5 (-0.6%)	62.5 (+52.4%)	78.6 (+29.1%)	92.7 (+15.2%)	45.1 (+37.9%)	62.9 (+36.4%)	65.1 (+35.6%)	
Brightness		STTran [7]	28.2	32.0	32.1	71.3	91.6	99.2	42.8	62.0	80.4	34.5	49.0	51.2		
		+IMPARTAIL (Ours)	42.3 (+50.0%)	50.4 (+57.5%)	50.5 (+57.3%)	65.9 (-7.6%)	87.2 (-4.8%)	98.9 (-0.3%)	64.0 (+49.5%)	80.8 (+30.3%)	92.8 (+15.4%)	46.9 (+35.9%)	67.8 (+38.4%)	71.0 (+38.7%)		
Sun Glare		STTran [7]	22.5	25.1	25.2	66.7	89.9	99.1	36.7	56.7	80.0	28.9	40.5	42.3		
		+IMPARTAIL (Ours)	40.2 (+78.7%)	47.5 (+89.2%)	47.7 (+89.3%)	57.9 (-13.2%)	81.7 (-9.1%)	98.0 (-1.1%)	60.3 (+64.3%)	77.5 (+36.7%)	92.7 (+15.9%)	43.3 (+49.8%)	59.3 (+46.4%)	61.0 (+44.2%)		

Table 4. Robustness Evaluation Results for SGA.

F	Mode	Corruption	Method	With Constraint		
				mR@10	mR@20	mR@50
0.5	PGAGS	Gaussian Noise	STTran+ [37]	7.9	8.4	8.4
			+IMPARTAIL (Ours)	5.1 (-35.4%)	5.4 (-35.7%)	5.4 (-35.7%)
			DSGDetr+ [37]	5.5	5.8	5.8
			+IMPARTAIL (Ours)	7.5 (+36.4%)	8.0 (+37.9%)	8.0 (+37.9%)
			STTran++ [37]	5.9	6.4	6.4
			+IMPARTAIL (Ours)	9.4 (+59.3%)	10.2 (+59.4%)	10.2 (+59.4%)
	Frost	DSGDetr++ [37]	5.7	6.1	6.1	
		+IMPARTAIL (Ours)	8.3 (+45.6%)	8.8 (+44.3%)	8.8 (+44.3%)	
		STTran+ [37]	8.2	9.0	9.0	
		+IMPARTAIL (Ours)	8.3 (+1.2%)	8.7 (-3.3%)	8.7 (-3.3%)	
		DSGDetr+ [37]	9.0	9.9	9.9	
		+IMPARTAIL (Ours)	12.4 (+37.8%)	13.3 (+34.3%)	13.3 (+34.3%)	
	Brightness	STTran++ [37]	9.6	10.5	10.5	
		+IMPARTAIL (Ours)	13.8 (+43.7%)	15.3 (+45.7%)	15.3 (+45.7%)	
		DSGDetr++ [37]	9.9	10.8	10.8	
		+IMPARTAIL (Ours)	13.2 (+33.3%)	14.4 (+33.3%)	14.4 (+33.3%)	
		STTran+ [37]	11.0	12.1	12.1	
		+IMPARTAIL (Ours)	11.7 (+6.4%)	12.5 (+3.3%)	12.5 (+3.3%)	
PREDCLS	Gaussian Noise	DSGDetr+ [37]	12.2	13.5	13.5	
		+IMPARTAIL (Ours)	15.9 (+30.3%)	17.2 (+27.4%)	17.2 (+27.4%)	
		STTran++ [37]	12.8	14.1	14.1	
		+IMPARTAIL (Ours)	17.7 (+38.3%)	19.3 (+36.9%)	19.3 (+36.9%)	
		DSGDetr++ [37]	13.6	14.7	14.7	
		+IMPARTAIL (Ours)	16.6 (+22.1%)	18.1 (+23.1%)	18.1 (+23.1%)	

5.3. Robustness Evaluation.

We evaluated VidSGG and SGA models trained with **IMPARTAIL** and those trained using traditional approaches across 16 input corruption scenarios. Our experiments revealed that introducing noise to the inputs generally led to a decline in performance. However, models trained with **IMPARTAIL** exhibited a less severe performance drop than baseline models. For example, in the PREDCLS mode under the No Constraint setting with Gaussian Noise for STTran, the baseline model’s mR@10 decreased from 45.7 to 31.4. In contrast, the **IMPARTAIL**-trained model dropped from 65.5 to 57.5.

Insights: (1) We noticed that the drop in performance of both VidSGG and SGA models trained using **IMPARTAIL** is lower than the models trained with traditional approaches (see Tables 3, 4). (2) We also observed that models trained using **IMPARTAIL** not only exhibited consistent strong mean recall scores but also outperformed baselines in recall metrics sometimes (refer Tab 3). (3) **IMPARTAIL** yields models that exhibit: (a) **Comprehensive Relational Knowledge:** **IMPARTAIL** captures when certain relationships rarely co-

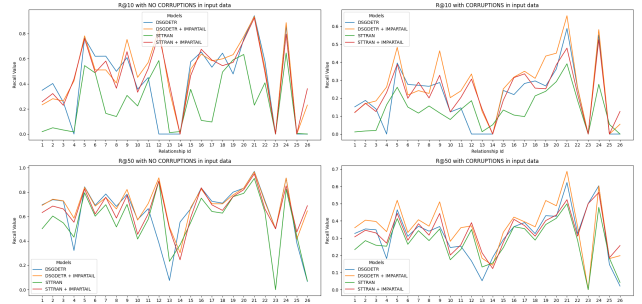

Figure 5. **Predicate Classification recall performance.** of models trained using existing VidSGG methods STTran, DSGDetr, and models trained using their **IMPARTAIL** adaptations. In each row, we compare the R@10/50 performance of each relationship category without corruptions(left) and with corruptions(right) in input data).

occur (e.g., (*sitting_on*, *in_front_of*)) and when they often appear together (e.g., (*sitting_on*, *beneath*), (*sitting_on*, *behind*)). Thus, **IMPARTAIL** trained models focus on a broader spatio-temporal context and other discovered associations to infer missing connections when frames are corrupted. (b) **Better Generalization:** By balancing out the data distribution, **IMPARTAIL** avoids overfitting to the most frequent object-relationship patterns (refer to Figure 5). This *regularizing effect* (similar in spirit to dropout) pushes the model to rely on shared patterns across categories, not just the apparent cues in dominant categories. Consequently, when inputs are noisy, the model is more likely to recover the underlying spatio-temporal relationships using generalized features.

6. Conclusion

We introduced **IMPARTAIL**, a framework that employs masked training with partial gradients to shift the focus of learning toward tail classes without sacrificing performance on head classes. To further evaluate the practical applicability of **IMPARTAIL**, we proposed two new tasks: Robust VidSGG and Robust SGA. Future work includes developing robust learning techniques [3, 17, 35] for both VidSGG and SGA tasks and exploring the application of unbiased

VidSGG and SGA in long-tailed regimes such as error recognition [36, 40], action anticipation [33], grasping [52] etc.

Acknowledgements

This work was supported by IBM AI Horizons Network (AIHN) grant and IBM SUR Award. Parag Singla was supported by Shanthi and K Ananth Krishnan Young Faculty Chair Professorship in AI. Rohith Peddi and Vibhav Gogate were supported in part by the DARPA Perceptually-Enabled Task Guidance (PTG) Program under contract number HR00112220005, by the DARPA Assured Neuro Symbolic Learning and Reasoning (ANSR) Program under contract number HR001122S0039, by the National Science Foundation grant IIS-1652835 and by the AFOSR award FA9550-23-1-0239. Further, this work was partially supported by the CSE Research Acceleration Fund of IIT Delhi. We would like to thank IIT Delhi HPC facility¹¹ for computational resources. We would also like to thank Saksham Singh for useful discussions during the initial phase of the project. We would like to express our gratitude to all the reviewers for their insightful comments and queries, which have substantially enhanced the quality of our manuscript.

References

- [1] Emanuel Ben Baruch, T. Ridnik, Nadav Zamir, Asaf Noy, Itamar Friedman, Matan Protter, and Lihi Zelnik-Manor. Asymmetric loss for multi-label classification. *2021 IEEE/CVF International Conference on Computer Vision (ICCV)*, pages 82–91, 2020. 3, 14
- [2] Kaidi Cao, Colin Wei, Adrien Gaidon, Nikos Aréchiga, and Tengyu Ma. Learning imbalanced datasets with label-distribution-aware margin loss. In *Neural Information Processing Systems*, 2019. 1, 14
- [3] Nicholas Carlini, Anish Athalye, Nicolas Papernot, Wieland Brendel, Jonas Rauber, Dimitris Tsipras, Ian Goodfellow, Aleksander Madry, and Alexey Kurakin. On evaluating adversarial robustness, 2019. 8
- [4] N. Chawla, K. Bowyer, Lawrence O. Hall, and W. Philip Kegelmeyer. Smote: Synthetic minority over-sampling technique. *ArXiv*, abs/1106.1813, 2002. 3, 14
- [5] Tianshui Chen, Weihao Yu, Riquan Chen, and Liang Lin. Knowledge-embedded routing network for scene graph generation, 2019. 6
- [6] Zuyao Chen, Jinlin Wu, Zhen Lei, Zhaoxiang Zhang, and Changwen Chen. Expanding scene graph boundaries: Fully open-vocabulary scene graph generation via visual-concept alignment and retention, 2023. 13
- [7] Yuren Cong, Wentong Liao, H. Ackermann, M. Yang, and B. Rosenhahn. Spatial-temporal transformer for dynamic scene graph generation. *IEEE International Conference on Computer Vision*, 2021. 2, 3, 6, 7, 8, 13, 28, 29, 44
- [8] Yin Cui, Menglin Jia, Tsung-Yi Lin, Yang Song, and Serge Belongie. Class-balanced loss based on effective number of samples, 2019. 3, 14
- [9] Chris Drummond and Robert C. Holte. C4.5, class imbalance, and cost sensitivity: Why under-sampling beats over-sampling, 2003. 3, 14
- [10] Jeffrey L. Elman. Learning and development in neural networks: the importance of starting small. *Cognition*, 48:71–99, 1993. 14
- [11] Shengyu Feng, Hesham Mostafa, Marcel Nassar, Somdeb Majumdar, and Subarna Tripathi. Exploiting long-term dependencies for generating dynamic scene graphs. *IEEE Workshop/Winter Conference on Applications of Computer Vision*, 2021. 3, 6, 7, 8, 28, 29, 43
- [12] Yoav Freund and Robert E. Schapire. A decision-theoretic generalization of on-line learning and an application to boosting. In *European Conference on Computational Learning Theory*, 1997. 14
- [13] Alex Graves, Marc G. Bellemare, Jacob Menick, Rémi Munos, and Koray Kavukcuoglu. Automated curriculum learning for neural networks. *ArXiv*, abs/1704.03003, 2017. 3, 14
- [14] Guy Hacoheh and Daphna Weinshall. On the power of curriculum learning in training deep networks. In *International Conference on Machine Learning*, 2019. 2, 3, 14
- [15] Yizeng Han, Yifan Pu, Zihang Lai, Chaofei Wang, Shiji Song, Junfen Cao, Wenhui Huang, Chao Deng, and Gao Huang. Learning to weight samples for dynamic early-exiting networks. *ArXiv*, abs/2209.08310, 2022. 3, 14
- [16] Chen Huang, Yining Li, Chen Change Loy, and Xiaoou Tang. Learning deep representation for imbalanced classification. *2016 IEEE Conference on Computer Vision and Pattern Recognition (CVPR)*, pages 5375–5384, 2016. 3, 14
- [17] Andrew Ilyas, Shibani Santurkar, Dimitris Tsipras, Logan Engstrom, Brandon Tran, and Aleksander Madry. Adversarial examples are not bugs, they are features, 2019. 8
- [18] Radu Tudor Ionescu, Bogdan Alexe, Marius Leordeanu, Marius Claudiu Popescu, Dim P. Papadopoulos, and Vittorio Ferrari. How hard can it be? estimating the difficulty of visual search in an image. *2016 IEEE Conference on Computer Vision and Pattern Recognition (CVPR)*, pages 2157–2166, 2016. 3, 14
- [19] Jingwei Ji, Ranjay Krishna, Li Fei-Fei, Fei-Fei Li, and Juan Carlos Niebles. Action genome: Actions as composition of spatio-temporal scene graphs. *arXiv: Computer Vision and Pattern Recognition*, 2019. 1, 2, 6, 13
- [20] Lu Jiang, Deyu Meng, Teruko Mitamura, and Alexander Hauptmann. Easy samples first: Self-paced reranking for zero-example multimedia search. *Proceedings of the 22nd ACM international conference on Multimedia*, 2014. 3, 14
- [21] Lu Jiang, Zhengyuan Zhou, Thomas Leung, Li-Jia Li, and Li Fei-Fei. Mentornet: Learning data-driven curriculum for very deep neural networks on corrupted labels. In *International Conference on Machine Learning*, 2017. 3, 14
- [22] Bingyi Kang, Saining Xie, Marcus Rohrbach, Zhicheng Yan, Albert Gordo, Jiashi Feng, and Yannis Kalantidis. Decoupling representation and classifier for long-tailed recognition. *ArXiv*, abs/1910.09217, 2019. 2, 14

¹¹<https://supercomputing.iitd.ac.in/>

- [23] Anant Khandelwal. Correlation debiasing for unbiased scene graph generation in videos, 2023. [2](#), [3](#), [13](#)
- [24] Kibum Kim, Kanghoon Yoon, Jaehyeong Jeon, Yeonjun In, Jinyoung Moon, Donghyun Kim, and Chanyoung Park. Llm4sgg: Large language model for weakly supervised scene graph generation, 2023. [13](#)
- [25] Ue-Hwan Kim, Jin-Man Park, Taek jin Song, and Jong-Hwan Kim. 3-d scene graph: A sparse and semantic representation of physical environments for intelligent agents. *IEEE Transactions on Cybernetics*, 50:4921–4933, 2019. [1](#), [2](#), [13](#)
- [26] Ranjay Krishna, Yuke Zhu, Oliver Groth, Justin Johnson, Kenji Hata, Joshua Kravitz, Stephanie Chen, Yannis Kalantidis, Li-Jia Li, David A. Shamma, Michael S. Bernstein, and Li Fei-Fei. Visual genome: Connecting language and vision using crowdsourced dense image annotations. *Int. J. Comput. Vis.*, 123(1):32–73, 2017. [2](#), [13](#)
- [27] M. Pawan Kumar, Ben Packer, and Daphne Koller. Self-paced learning for latent variable models. In *Neural Information Processing Systems*, 2010. [3](#), [14](#)
- [28] Lin Li, Jun Xiao, Guikun Chen, Jian Shao, Yueting Zhuang, and Long Chen. Zero-shot visual relation detection via composite visual cues from large language models, 2023. [13](#)
- [29] Mengke Li, Yiu-Ming Cheung, and Yang Lu. Long-tailed visual recognition via gaussian clouded logit adjustment. In *2022 IEEE/CVF Conference on Computer Vision and Pattern Recognition (CVPR)*, page 6919–6928. IEEE, 2022. [14](#)
- [30] Tsung-Yi Lin, Priya Goyal, Ross B. Girshick, Kaiming He, and Piotr Dollár. Focal loss for dense object detection. *2017 IEEE International Conference on Computer Vision (ICCV)*, pages 2999–3007, 2017. [1](#)
- [31] Tambet Matiisen, Avital Oliver, Taco Cohen, and John Schulman. Teacher–student curriculum learning. *IEEE Transactions on Neural Networks and Learning Systems*, 31:3732–3740, 2017. [2](#), [3](#), [5](#), [14](#)
- [32] Sayak Nag, Kyle Min, Subarna Tripathi, and Amit K Roy-Chowdhury. Unbiased scene graph generation in videos. In *Proceedings of the IEEE/CVF Conference on Computer Vision and Pattern Recognition*, pages 22803–22813, 2023. [2](#), [3](#), [6](#), [7](#), [13](#), [18](#), [20](#)
- [33] Megha Nawhal, Akash Abdu Jyothi, and Greg Mori. Rethinking learning approaches for long-term action anticipation, 2022. [9](#)
- [34] Wanli Ouyang, Xiaogang Wang, Cong Zhang, and Xiaokang Yang. Factors in finetuning deep model for object detection with long-tail distribution. *2016 IEEE Conference on Computer Vision and Pattern Recognition (CVPR)*, pages 864–873, 2016. [3](#), [14](#)
- [35] Rohith Peddi, Tahrira Rahman, and Vibhav Gogate. Robust learning of tractable probabilistic models. In *Proceedings of the Thirty-Eighth Conference on Uncertainty in Artificial Intelligence*, pages 1572–1581. PMLR, 2022. [8](#)
- [36] Rohith Peddi, Shivvrat Arya, Bharath Challa, Likhitha Pallapothula, Akshay Vyas, Bhavya Gouripeddi, Jikai Wang, Qifan Zhang, Vasundhara Komaragiri, Eric Ragan, Nicholas Ruozzi, Yu Xiang, and Vibhav Gogate. CaptainCook4D: A Dataset for Understanding Errors in Procedural Activities, 2024. [9](#)
- [37] Rohith Peddi, Saksham Singh, Saurabh, Parag Singla, and Vibhav Gogate. Towards scene graph anticipation. In *Computer Vision – ECCV 2024*, pages 159–175, Cham, 2025. Springer Nature Switzerland. [2](#), [3](#), [5](#), [6](#), [7](#), [8](#), [13](#), [23](#), [25](#), [31](#), [32](#), [33](#), [34](#), [35](#), [36](#), [37](#), [38](#), [39](#), [40](#), [41](#), [42](#), [45](#)
- [38] Mengye Ren, Wenyuan Zeng, Binh Yang, and Raquel Urtasun. Learning to reweight examples for robust deep learning. In *International Conference on Machine Learning*, 2018. [3](#), [14](#)
- [39] Andrew I. Schein and Lyle H. Ungar. Active learning for logistic regression. *Machine Learning*, 2005. [14](#)
- [40] Fadime Sener, Dibyadip Chatterjee, Daniel Shelepov, Kun He, Dipika Singhanian, Robert Wang, and Angela Yao. Assembly101: A large-scale multi-view video dataset for understanding procedural activities, 2022. [9](#)
- [41] Xindi Shang, Tongwei Ren, Jingfan Guo, Hanwang Zhang, and Tat-Seng Chua. Video visual relation detection. In *Proceedings of the 25th ACM International Conference on Multimedia*, page 1300–1308, New York, NY, USA, 2017. Association for Computing Machinery. [2](#), [13](#)
- [42] Suprosanna Shit, Rajat Koner, Bastian Wittmann, Johannes Paetzold, Ivan Ezhov, Hongwei Li, Jiazhen Pan, Sahand Sharifzadeh, Georgios Kaissis, Volker Tresp, and Bjoern Menze. Relationformer: A unified framework for image-to-graph generation, 2022. [2](#), [13](#)
- [43] Abhinav Shrivastava, Abhinav Kumar Gupta, and Ross B. Girshick. Training region-based object detectors with online hard example mining. *2016 IEEE Conference on Computer Vision and Pattern Recognition (CVPR)*, pages 761–769, 2016. [1](#), [14](#)
- [44] Wen Song, Hao Wang, and Dimitris N. Metaxas. Social ode: Multi-agent trajectory forecasting with neural ordinary differential equations. *European Conference on Computer Vision*, 2022. [1](#)
- [45] Jingru Tan, Changbao Wang, Buyu Li, Quanquan Li, Wanli Ouyang, Changqing Yin, and Junjie Yan. Equalization loss for long-tailed object recognition. *2020 IEEE/CVF Conference on Computer Vision and Pattern Recognition (CVPR)*, pages 11659–11668, 2020. [1](#), [2](#), [14](#)
- [46] Ashish Vaswani, Noam Shazeer, Niki Parmar, Jakob Uszkoreit, Llion Jones, Aidan N Gomez, Łukasz Kaiser, and Illia Polosukhin. Attention is all you need. In *Advances in Neural Information Processing Systems*. Curran Associates, Inc., 2017. [4](#)
- [47] Xudong Wang, Long Lian, Zhongqi Miao, Ziwei Liu, and Stella X. Yu. Long-tailed recognition by routing diverse distribution-aware experts. *ArXiv*, abs/2010.01809, 2020. [1](#)
- [48] Yu-Xiong Wang, Deva Ramanan, and Martial Hebert. Learning to model the tail. In *Neural Information Processing Systems*, 2017. [3](#), [14](#)
- [49] Daphna Weinshall and Gad Cohen. Curriculum learning by transfer learning: Theory and experiments with deep networks. In *International Conference on Machine Learning*, 2018. [3](#), [14](#)
- [50] Tong Wu, Qingqiu Huang, Ziwei Liu, Yu Wang, and Dahua Lin. Distribution-balanced loss for multi-label classification in long-tailed datasets. *ArXiv*, abs/2007.09654, 2020. [3](#), [14](#)
- [51] Liuyu Xiang and Guiguang Ding. Learning from multiple experts: Self-paced knowledge distillation for long-tailed

- classification. In *European Conference on Computer Vision*, 2020. [3](#), [14](#)
- [52] Yu Xiang, Sai Haneesh Allu, Rohith Peddi, Tyler Summers, and Vibhav Gogate. Grasping trajectory optimization with point clouds, 2024. [9](#)
- [53] Chong You, Chi Li, Daniel P. Robinson, and René Vidal. A scalable exemplar-based subspace clustering algorithm for class-imbalanced data. In *European Conference on Computer Vision*, 2018. [3](#), [14](#)
- [54] Xiao Zhang, Zhiyuan Fang, Yandong Wen, Zhifeng Li, and Yu Qiao. Range loss for deep face recognition with long-tailed training data. *2017 IEEE International Conference on Computer Vision (ICCV)*, pages 5419–5428, 2016. [3](#), [14](#)
- [55] X. Zhang, Z. Wu, Z. Weng, H. Fu, J. Chen, Y. Jiang, and L. S. Davis. Videolt: large-scale long-tailed video recognition. 2021. [3](#), [14](#)
- [56] Shu Zhao and Huijuan Xu. Less is more: Toward zero-shot local scene graph generation via foundation models, 2023. [13](#)
- [57] Boyan Zhou, Quan Cui, Xiu-Shen Wei, and Zhao-Min Chen. Bbn: Bilateral-branch network with cumulative learning for long-tailed visual recognition. *2020 IEEE/CVF Conference on Computer Vision and Pattern Recognition (CVPR)*, pages 9716–9725, 2019. [1](#), [3](#), [14](#)
- [58] Zijian Zhou, Miaoqing Shi, and Holger Caesar. Vlprompt: Vision-language prompting for panoptic scene graph generation, 2023. [13](#)

Appendices

7. Overview	13
7.1. Motivation	13
7.2. Motivational Drivers	13
7.3. Contributions	13
8. Extended Related Work	13
8.1. Structured Visual Representation	13
8.2. Learning Paradigms	14
9. Limitations	15
10 Approach	16
10.1 IMPARTAIL	16
10.2 Video Scene Graph Generation	17
10.3 Scene Graph Anticipation	21
11 Ablation-Overview	27
11.1 Video Scene Graph Generation	27
11.2 Scene Graph Anticipation	27
11.3 Robustness Evaluation.	27
12 Ablation Results	28
12.1 Video Scene Graph Generation	28
12.2 Scene Graph Anticipation	30
12.3 Robust Video Scene Graph Generation	43
12.4 Robust Scene Graph Anticipation	45

7. Overview

7.1. Motivation

1. **Long-Tailed Distributions:** Real-world visual relationships are dominated by a few frequent *head classes*, while many rare but critical *tail classes* are underrepresented. This imbalance leads to biased models that fail to generalize effectively across all relationship types, compromising nuanced and accurate scene understanding.
2. **Robustness to Distribution Shifts:** Models often struggle with real-world factors such as lighting variations, occlusions, or environmental changes. These distributional shifts degrade performance, limiting the applicability of scene graph models in dynamic and unpredictable environments.

7.2. Motivational Drivers

- **Improving Unbiasedness in Scene Understanding:** A long-tailed distribution skews model learning towards frequent classes, leading to biased predictions. Correctly predicting rare relationships is vital for tasks such as autonomous driving, human-robot interaction, and security surveillance, where underrepresented classes can carry critical contextual information.
- **Enhancing Real-World Applicability:** Distributional shifts are unavoidable in real-world scenarios. Ensuring robustness allows STSG models to remain reliable under practical deployment conditions, bolstering trust and usability.

7.3. Contributions

Thus, concisely, we re-iterate the contributions of the proposed work:

- **Unbiased Learning with Curriculum-Guided Masking:** The proposed **IMPARTAIL** framework leverages curriculum learning and loss masking to prioritize tail classes progressively during training.
- **Introduction of Robustness Metrics:** Two new tasks—*Robust Spatio-Temporal Scene Graph Generation* and *Robust Scene Graph Anticipation*—evaluate model resilience to input corruptions (a step towards analyzing the performance of STSG models under realistic conditions).

8. Extended Related Work

8.1. Structured Visual Representation

Tasks. Learning to represent static visual data like 2D and 3D images as spatial graphs, with objects as nodes and relationships as edges, is called Image Scene Graph Generation (ImgSGG). This field gained momentum with the foundational Visual Genome project [26], advancing 2D ImgSGG research. Building on this foundation, [25] expanded the task to encompass static 3D scene data, including RGB and depth information. Object interactions over time provide richer context when dealing with dynamic visual content like videos. Converting such content into structured Spatio-Temporal Scene Graphs (STSGs), where nodes represent objects and edges capture their temporal relationships, is called Video Scene Graph Generation (VidSGG). The research community has concentrated on improving representation learning through sophisticated object-centric architectures like STTran [7] and RelFormer [42]. These include Open-Vocabulary ImgSGG [6], which expands the range of recognizable objects and relationships. Weakly Supervised ImgSGG [24] to reduce the dependency on extensive labelled data by leveraging weak supervision techniques. Panoptic ImgSGG [58] where panoptic segmentation has been integrated to enhance scene graph representations. Zero-Shot ImgSGG [28, 56] to enable the detection of unseen visual relationships without explicit labels. Shifting gears from identification and generating scene graphs, recently, Peddi et al.[37] introduced the Scene Graph Anticipation (SGA) task to anticipate STSGs for future frames. Alongside these developments, foundation models have advanced various ImgSGG task variants [6, 24, 28, 56, 58].

Unbiased Learning. TEMPURA [32] and FICoDe[23] address the challenges posed by long-tailed datasets, such as those found in Action Genome [19] and VidVRD [41] and propose methods for unbiased VidSGG. Specifically, FloCoDe [23] mitigates bias by emphasizing temporal consistency and correcting the imbalanced distribution of visual relationships. Similarly, TEMPURA [32] addresses biases in relationship prediction with memory-guided training to generate balanced relationship representations and applies a Gaussian Mixture Model to reduce predictive uncertainty. **Note.** To the best of our knowledge, we are the first to systematically investigate model biases in the SGA task and assess the robustness of both VidSGG and SGA models. In contrast to the above methods, although **IMPARTAIL** shares the goal of training unbiased VidSGG models, it does so without additional architectural components. By modifying the training procedure, **IMPARTAIL** achieves comparable performance and occasionally exceeds the results of these existing methods.

8.2. Learning Paradigms

8.2.1. Long-Tail Learning.

Long-tailed distributions with a few dominant classes (head classes) often overshadow a more significant number of under-represented ones (tail classes). This class imbalance typically results in models that perform well on head classes but struggle to generalize to tail classes. To mitigate them, the research community has made significant strides in four directions, which include (a) Cost-Sensitive Learning [1, 8, 16, 34, 48, 48, 50, 53, 54], (b) Mixtures-Of-Experts [51], (c) Resampling Techniques [4, 9, 55], and (d) Specialized Architectures [55, 57].

(a) Cost-Sensitive Learning addresses class imbalance by adjusting the loss function to assign different costs to classes during training. Early approaches involved re-weighting samples inversely proportional to class frequency [16, 48], but this often led to suboptimal performance on real-world data [8]. To improve upon this, advanced methods like label-distribution-aware margin loss with Deferred Re-Weighting (DRW) were proposed [2]. Equalization Loss (EQL) [45] showed that ignoring discouraging gradients for tail classes can prevent adverse effects on model learning. The Class-Balanced (CB) loss [8] re-weights the loss based on the effective number of samples per class, achieving notable performance in single-label classification. Asymmetric Loss (ASL) [1] and Distribution-Balanced (DB) loss [50] focus on balancing positive and negative labels in multi-label classification. Other approaches include transferring knowledge from head to tail classes [34, 48] and designing better training objectives through metric learning [53, 54].

(b) Mixture-of-Experts (MoE) methods tackle class imbalance by distributing samples among specialized expert models. LFME [51] merges multiple experts using self-paced knowledge distillation, while RIDE employs diversity loss and dynamic routing for sample assignment.

(c) Resampling methods adjust the training data distribution by over-sampling tail classes or under-sampling head classes. Techniques like SMOTE [4] create synthetic samples for minority classes, while under-sampling methods reduce samples from majority classes [9]. Approaches, such as concatenating frames from different video clips [55], offer a different way to balance data, particularly spatio-temporal data.

(d) Specialized architectures aim to enhance feature representation and aggregation for tail classes. FrameStack [55] performs frame-level sampling guided by running average precision to improve tail class representation without explicitly differentiating classes at the feature level. The Bilateral-Branch Network (BBN) [57] uses cumulative learning to balance representation learning and classifier discrimination. Kang et al. [22] demonstrated that decoupling representation learning from classifier training prevents head classes from overshadowing tail classes. While Kang et al. [22] argued that resampling might not always be necessary if classifier training is focused correctly, Zhou et al. [57] showed that standard resampling could harm representation learning. Li et al. [29] proposed Gaussian Clouded Logit Adjustment to perturb class logits, adjusting decision boundaries for better generalization across classes.

8.2.2. Curriculum Learning (CL)

is a training methodology that structures training by presenting simpler examples first and progressively introducing more complex ones. This approach aims to enhance learning efficiency by aligning the difficulty of training data with the model’s learning capacity at each stage¹²[13–15, 27]. Despite its potential benefits, implementing CL presents significant challenges. A primary obstacle is distinguishing between *easy* and *hard* training samples. This differentiation often requires additional mechanisms, such as auxiliary neural networks acting as *teachers* or specialized algorithms. Difficulty measures can be predefined based on certain heuristics [18] or learned automatically during the training process [14, 20, 21, 27, 31, 38, 49]. Alongside difficulty assessment, a scheduling strategy is essential to determine when and how to introduce more challenging data [13]. The *starting small* concept influences our methodology [10], which recommends initiating learning with easier tasks. Unlike conventional Curriculum Learning (CL) methods that introduce data progressively, our approach utilizes the entire training dataset from the start. We adopt label selection to mask the loss function, offering a unique strategy that impacts the learning process while keeping all training examples in play. This approach not only streamlines the implementation of CL but also tackles the difficulties of determining and scheduling the complexity of training data.

¹²It’s important to differentiate CL from other dynamic sampling techniques such as self-paced learning [27], boosting [12], hard example mining [43], and active learning [39]. While these methods also adjust the training data based on certain criteria, they typically rely on the model’s current performance or hypotheses to select samples rather than following a predefined difficulty progression as in CL.

9. Limitations

1. **Limited Scope of Datasets:** Experiments are primarily conducted on the Action Genome dataset.
 - This is a primary concern of the field as the Action Genome is the only large-scale dataset available as a testbed for the Spatio-Temporal Scene Graph tasks.
2. **Model Robustness to Distribution Shifts:**
 - Although robustness is considered, the specific test corruptions may not cover all real-world scenarios. Instead, our work can be considered a starting point for further developing robust learning techniques.
3. **Bias Mitigation vs. Performance:**
 - In IMPARTAIL, balancing unbiased learning with high performance on head classes, although small, might result in a trade-off between performance over head and tail classes. We conjecture that adding an external memory block to our framework can help mitigate this issue.
4. **Limited Evaluation Metrics:**
 - Although metrics such as recall and mean recall provide us insights about the performance of the trained models. These might fail to capture the performance over higher-order spatial and temporal relationships.

10. Approach

10.1. IMPARTAIL

Here, we present the complete algorithm for the proposed unbiased learning framework. Our framework has four key components.

1. (I) **Object Representation Processing Unit (ORPU)**: This module extracts object representations for detected objects within video frames using a pre-trained object detector.
2. (II) **Spatio-Temporal Context Processing Unit (STPU)**: This unit creates object-centric relationship representations, tailored for two tasks: (i) *observed relationships* for VidSGG and (ii) *anticipated relationships* for SGA.
3. (III) **Relationship Predicate Decoders**: These decoders assign predicate labels to the observed or anticipated relationship representations. **Note**: ORPU, STPU, and the predicate decoders can be adapted from any VidSGG or SGA method following an object-centric framework.
4. (IV) **Curriculum-Guided Masked Loss**: This loss mechanism employs a curriculum-based masking strategy to exclude certain relationship predicate labels during training progressively. Focusing on underrepresented classes helps the model achieve a balanced class distribution.

(IV) Curriculum-Guided Masked Loss. This has two components as explained in the main paper: (a) **Curriculum-Guided Mask Generation** and (b) **Masked Predicate Classification Loss**. First, we provide the complete algorithm for *Mask Generation* and give an overview of the loss function employed. In the subsequent sections, we clearly explain and contrast the loss functions for the original and the proposed IMPARTAIL variants.

10.1.1. Curriculum Guided Mask Generation.

Algorithm 2: Filtered Dataset Construction

Input: Epoch: e , Sampling Ratio: \mathcal{R}_s , Dataset Annotations: \mathcal{D} , Total predicate labels: N , Total predicates: \mathcal{P} , Videos: \mathcal{V}

Output: Filtered Dataset: \mathcal{F}

- 1 ***** Determine Target Counts [can also be a fixed input] *****
- 2 $\mathcal{R}_m = e \times \mathcal{R}_s$ ***** Masking Ratio *****
- 3 $N_{\text{target}} = \text{round}(N \times \mathcal{R}_m)$
- 4 ***** Curriculum-based sampling probabilities $Prob[rel]$ *****
- 5 ***** Equally weighted distribution [can also be learnt] *****
- 6 Set $Prob[rel] = \frac{1}{|\mathcal{P}|}$
- 7 Sample target counts $Tar[rel]$ from Multinomial distribution: $Tar[rel] \sim \text{Multinomial}(N_{\text{target}}, Prob[rel])$
- 8 ***** Randomly sample instances of relationships in the dataset based on the target counts and construct filtered dataset *****
- 9 Initialize positions $\mathcal{P}[rel]$ to collect occurrences of rel
- 10 **foreach** v, f in \mathcal{D} **do**
- 11 **foreach** $Relation\ rel$ in $\mathcal{D}[v][f]$ **do**
- 12 Append position (v, f, index) to $\mathcal{P}[rel]$
- 13 Initialize empty set \mathcal{K}
- 14 ***** These relations are ignored and are omitted from the filtered dataset constructed below *****
- 15 **foreach** $Relation\ rel$ **do**
- 16 Randomly select $Tar[rel]$ positions which should be masked from $\mathcal{P}[rel]$ and add the remaining to \mathcal{K}
- 17 ***** Filter Data *****
- 18 Initialize filtered data \mathcal{F}
- 19 **foreach** v, f in \mathcal{D} **do**
- 20 Initialize filtered frame $\mathcal{F}[v][f]$
- 21 **foreach** $Relation\ at\ position\ (v, f, i)$ **do**
- 22 **if** $(v, f, i) \in \mathcal{K}$ **then**
- 23 Add relation to $\mathcal{F}[v][f]$

Algorithm 3: Mask Generation

Input: Epoch: e , Dataset Annotations: \mathcal{D} , Videos: \mathcal{V} , Filtered Dataset: \mathcal{F}

Output: Masks: \mathcal{M}

- 1 Initialize empty mask list \mathcal{M}
- 2 **foreach** $Video\ v$ in \mathcal{V} **do**
- 3 Initialize video mask \mathcal{M}_v
- 4 **foreach** $Frame\ f$ in v **do**
- 5 Initialize frame mask \mathcal{M}_f
- 6 **foreach** $Object\ o$ in f **do**
- 7 Initialize object mask \mathcal{M}_o
- 8 Original relations \mathcal{R}_o from $\mathcal{D}[v][f]$
- 9 **foreach** $Relation\ rel$ in \mathcal{R}_o **do**
- 10 **if** $rel \in \mathcal{F}[v][f]$ **then**
- 11 Set mask value $\mathcal{M}_o[rel] = 0$
- 12 **else**
- 13 Set mask value $\mathcal{M}_o[rel] = 1$
- 14 Add \mathcal{M}_o to \mathcal{M}_f
- 15 Add \mathcal{M}_f to \mathcal{M}_v
- 16 Add \mathcal{M}_v to $\mathcal{M}^{(e)}$

10.2. Video Scene Graph Generation

10.2.1. IMPARTAIL + STTran

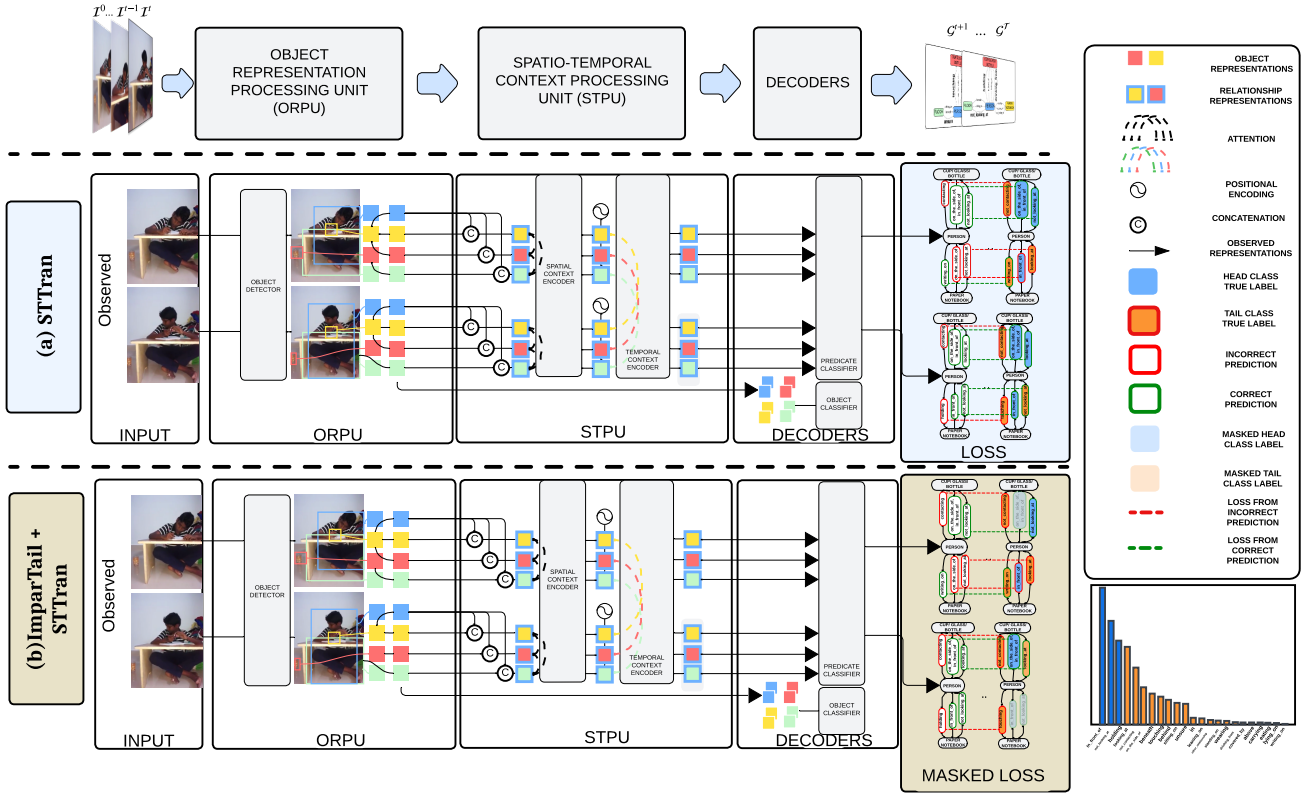

Figure 6. (a) **Architectural Components.** In **STTran**, the Object Representations Processing Unit (ORPU) primarily consists of an object detector and the visual features output by the object detector. Then, the Spatio-Temporal Context Processing Unit (STPU) takes these visual features as input and first constructs relationship representations utilizing the features of interacting objects; then, these relationship representations are fed to a spatial encoder and a transformer encoder. Thus, the spatio-temporal context-aware representations output by the temporal encoder are fed into the predicate classifier for final predictions. Finally, these representations are decoded for predicate classification. (b) **Loss Function.** The primary difference between **STTran** loss and the proposed **IMPARTAIL + STTran** loss is illustrated using highlighting the employed losses. We do not mask any predicate label in **STTran** loss. In contrast, in the proposed **IMPARTAIL + STTran** loss, we mask the losses corresponding to the *head* classes as generated by following the curriculum-based strategy.

Loss Function **STTran**

$$\begin{aligned}
 \mathcal{L}_i &= \sum_{t=1}^{\bar{T}} \mathcal{L}_i^t; & \mathcal{L}_{\text{gen}} &= \sum_{t=1}^{\bar{T}} \mathcal{L}_{\text{gen}}^t, \mathcal{L}_{\text{gen}}^t = \sum_{ij} \mathcal{L}_{p_{ij}}^t \\
 & \text{(1)} & & \text{Predicate Classification Loss (2)}
 \end{aligned}$$

$$\mathcal{L} = \sum_{t=1}^{\bar{T}} \left(\lambda_1 \mathcal{L}_{\text{gen}}^t + \lambda_2 \sum_i \mathcal{L}_i^t \right)$$

Loss Function IMPARTAIL + STTran

$$\begin{aligned}
 \mathcal{L}_i &= \underbrace{\sum_{t=1}^{\bar{T}} \mathcal{L}_i^t}_{(1)}; & \mathcal{L}_{\text{gen}} &= \underbrace{\sum_{t=1}^{\bar{T}} \mathcal{L}_{\text{gen}}^t, \mathcal{L}_{\text{gen}}^t = \sum_{ij} \mathbf{m}_{ij}^t * \mathcal{L}_{p_{ij}^t}}_{\text{Masked Predicate Classification Loss (2)}} \\
 \mathcal{L} &= \sum_{t=1}^{\bar{T}} \left(\lambda_1 \mathcal{L}_{\text{gen}}^t + \lambda_2 \sum_i \mathcal{L}_i^t \right)
 \end{aligned}$$

Here,

$$\hat{\mathbf{p}}_{ij}^t = \text{PredClassifier}_{\text{observed}}(\mathbf{z}_{ij}^t), \forall t \in [1, T] \quad (8)$$

Predicate Classification Loss (\mathcal{L}_{gen}). focuses on classifying the relationship representations between pairs of objects (o_i^t, o_j^t) across all frames ($t \in [1, \bar{T}]$) as detailed above. Here, $\mathcal{L}_{p_{ij}^t}$ represents multi-label margin loss and is computed as follows:

$$\mathcal{L}_{p_{ij}^t} = \sum_{u \in \mathcal{P}^+} \sum_{v \in \mathcal{P}^-} \max(0, 1 - \hat{\mathbf{p}}_{ij}^t[v] + \hat{\mathbf{p}}_{ij}^t[u]) \quad (9)$$

Implementation Details.

- **Training Epochs.** We have capped the number of training epochs for both models where one uses conventional loss and the other uses the proposed IMPARTAIL framework to 5 epochs.
- **Loss Function.** Results reported in the literature for the method STTran were not reproducible using the Multi-Label Margin Loss. However, we noticed we could reach closer numbers (still lower than reported) by employing BCE Loss and training to 10 epochs.
- **Hyperparameters.** We use the same hyperparameter settings described in the paper.

Insight. Our reported mean recall numbers closely match the numbers reported by the SOTA model TEMPURA [32] without any additional architectural changes just by changing how the model is learnt. We also emphasize that although our recall performance was hurt slightly, it is marginally lower than recall values compared to the original model and TEMPURA.

10.2.2. IMPARTAIL + DSGDetr

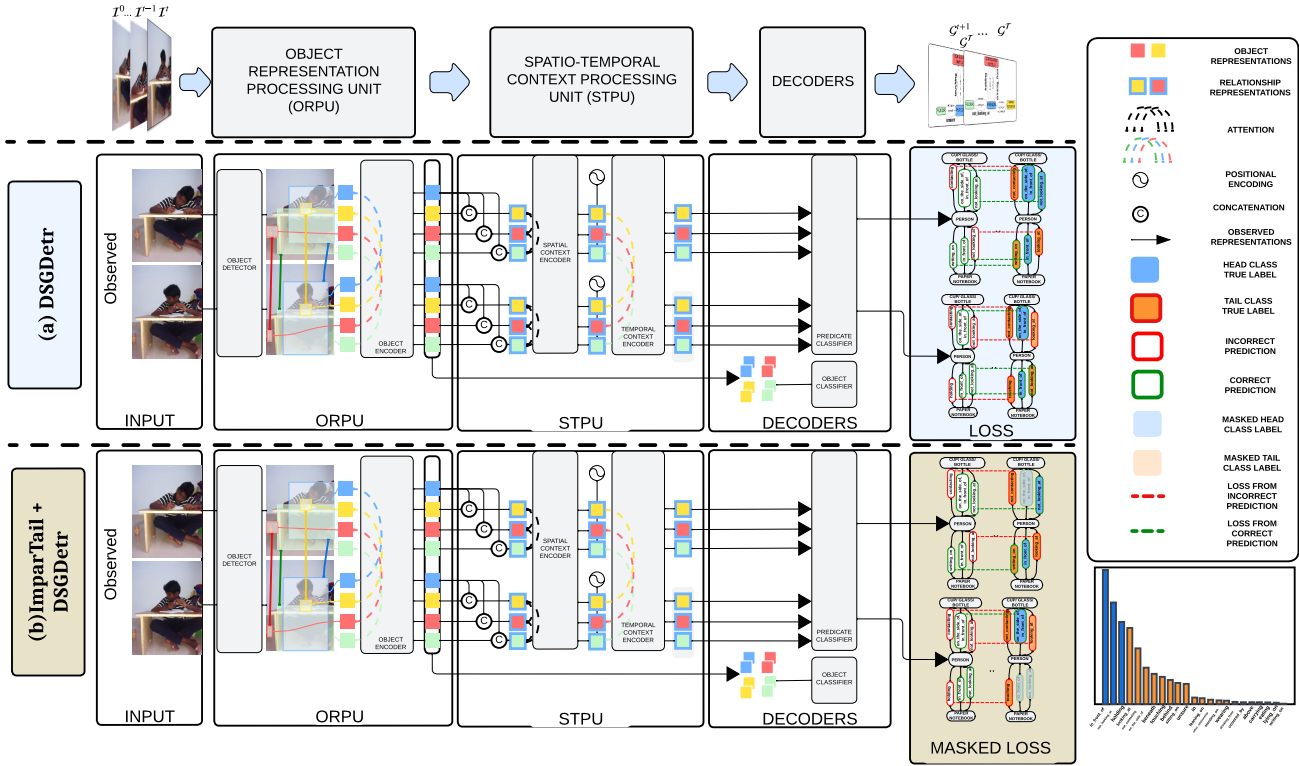

Figure 7. (a) **Architectural Components.** In **DSGDetr**, the Object Representations Processing Unit (ORPU) primarily consists of an object detector, an object tracker and an object encoder. The visual features output by the object detector are used to construct tracklets corresponding to each object, and these representations are further enhanced by passing them through an object encoder. Then, the Spatio-Temporal Context Processing Unit (STPU) takes these visual features as input and first constructs relationship representations utilizing the features of interacting objects; then, these relationship representations are fed to a spatial encoder and a transformer encoder. Thus, the spatio-temporal context-aware representations output by the temporal encoder are fed into the predicate classifier for final predictions. Finally, these representations are decoded for predicate classification. (b) **Loss Function.** The primary difference between **DSGDetr** loss and the proposed **IMPARTAIL + DSGDetr** loss is illustrated using highlighting the employed losses. We do not mask any predicate label in **DSGDetr** loss. In contrast, in the proposed **IMPARTAIL + DSGDetr** loss, we mask the losses corresponding to the *head* classes as generated by following the curriculum-based strategy.

Loss Function **DSGDetr**

$$\begin{aligned}
 \mathcal{L}_i &= \sum_{t=1}^{\bar{T}} \mathcal{L}_i^t; & \mathcal{L}_{\text{gen}} &= \sum_{t=1}^{\bar{T}} \mathcal{L}_{\text{gen}}^t, \mathcal{L}_{\text{gen}}^t = \sum_{ij} \mathcal{L}_{p_{ij}}^t \\
 & \underbrace{\hspace{10em}}_{(1)} & & \underbrace{\hspace{10em}}_{\text{Predicate Classification Loss (2)}} \\
 \mathcal{L} &= \sum_{t=1}^{\bar{T}} \left(\lambda_1 \mathcal{L}_{\text{gen}}^t + \lambda_2 \sum_i \mathcal{L}_i^t \right)
 \end{aligned}$$

Loss Function IMPARTAIL + DSGDetr

$$\underbrace{\mathcal{L}_i = \sum_{t=1}^{\bar{T}} \mathcal{L}_i^t}_{(1)}; \quad \underbrace{\mathcal{L}_{\text{gen}} = \sum_{t=1}^{\bar{T}} \mathcal{L}_{\text{gen}}^t, \mathcal{L}_{\text{gen}}^t = \sum_{ij} \mathbf{m}_{ij}^t * \mathcal{L}_{p_{ij}^t}}_{\text{Masked Predicate Classification Loss (2)}}$$

$$\mathcal{L} = \sum_{t=1}^{\bar{T}} \left(\lambda_1 \mathcal{L}_{\text{gen}}^t + \lambda_2 \sum_i \mathcal{L}_i^t \right)$$

Here,

$$\hat{\mathbf{p}}_{ij}^t = \text{PredClassifier}_{\text{observed}}(\mathbf{z}_{ij}^t), \forall t \in [1, T] \quad (10)$$

Predicate Classification Loss (\mathcal{L}_{gen}). focuses on classifying the relationship representations between pairs of objects (o_i^t, o_j^t) across all frames ($t \in [1, \bar{T}]$) as detailed above. Here, $\mathcal{L}_{p_{ij}^t}$ represents multi-label margin loss and is computed as follows:

$$\mathcal{L}_{p_{ij}^t} = \sum_{u \in \mathcal{P}^+} \sum_{v \in \mathcal{P}^-} \max(0, 1 - \hat{\mathbf{p}}_{ij}^t[v] + \hat{\mathbf{p}}_{ij}^t[u]) \quad (11)$$

Implementation Details.

- **Training Epochs.** We have capped the number of training epochs for both models where one uses conventional loss and the other uses the proposed IMPARTAIL framework to **5** epochs.
- **Loss Function.** Results reported in the literature for the method DSGDetr were not reproducible using the Multi-Label Margin Loss. However, we noticed we could reach closer numbers (still lower than reported) by employing BCE Loss and training to 10 epochs.
- **Hyperparameters.** We use the same hyperparameter settings described in the paper.

Insight. Our reported mean recall numbers closely match the numbers reported by the SOTA model TEMPURA [32] without any additional architectural changes just by changing how the model is learnt. We also emphasize that although our recall performance was hurt slightly, it is marginally lower than recall values compared to the original model and TEMPURA.

10.3. Scene Graph Anticipation

10.3.1. IMPARTAIL + STTran++

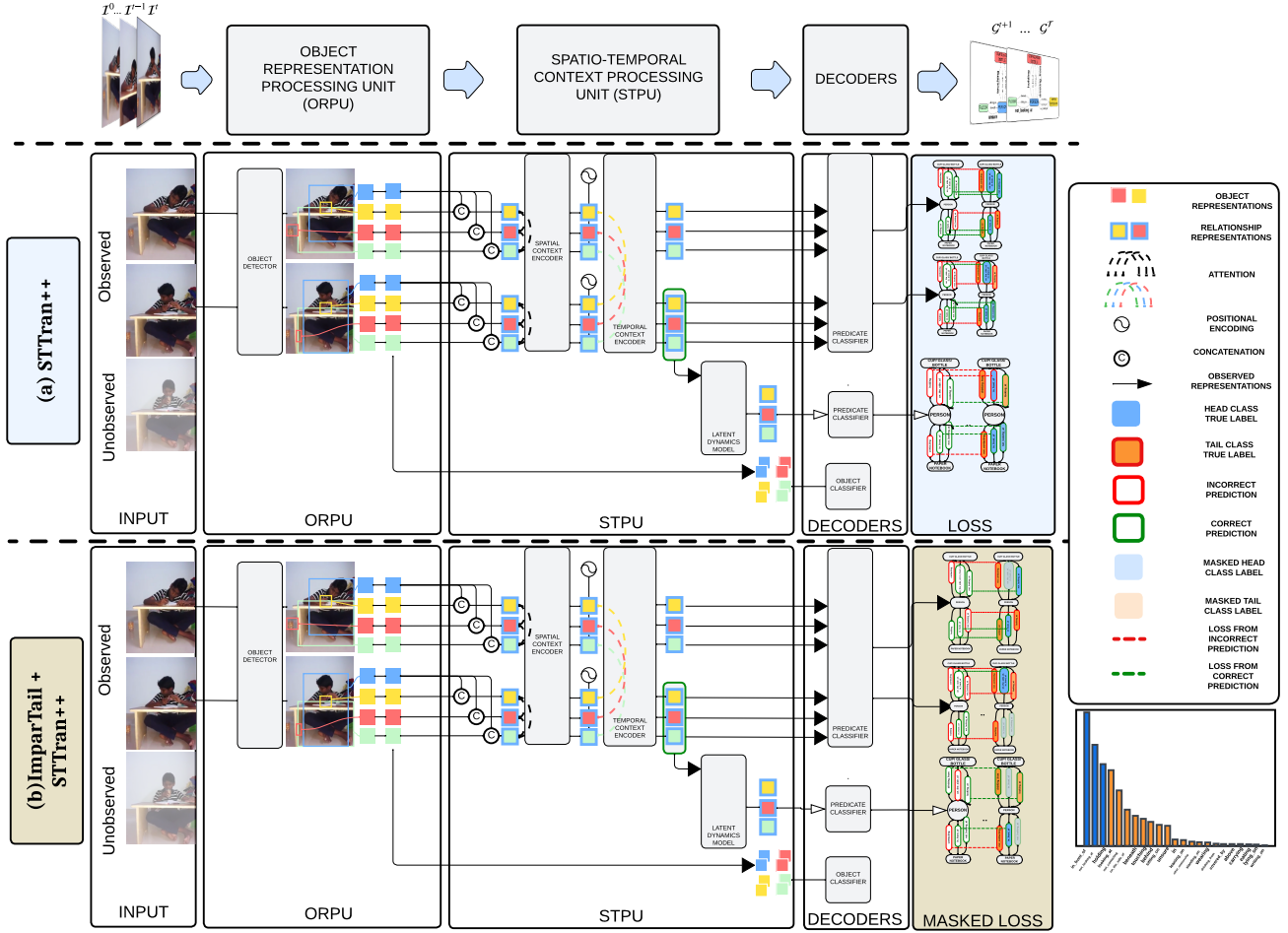

Figure 8. (a) **Architectural Components.** In STTran++, the Object Representations Processing Unit (ORPU) primarily consists of an object detector and the visual features output by the object detector. Then, the Spatio-Temporal Context Processing Unit (STPU) takes these visual features as input and first constructs relationship representations utilizing the features of interacting objects; then, these relationship representations are fed to a spatial encoder and a transformer encoder. Thus, the spatio-temporal context-aware representations output by the temporal encoder are fed as input to another transformer encoder to anticipate the future relationship representations corresponding to interacting objects. Thus, relationship representations from the temporal encoder and future relationship representations from the anticipatory transformer encoder are input to two predicate classifiers for final predictions. (b) **Loss Function.** The primary difference between STTran++ loss and the proposed IMPARTAIL + STTran++ loss is illustrated using highlighting the employed losses. We do not mask any predicate label in STTran++ loss. In contrast, in the proposed IMPARTAIL + STTran++ loss, we mask the losses corresponding to the *head* classes output by predicate classification heads corresponding to both observed and anticipated relationship representations.

Loss Function STTran++

$$\mathcal{L}_i = \sum_{t=1}^T \mathcal{L}_i^t, \quad \mathcal{L}_i^t = - \sum_{n=1}^{|C|} y_{i,n}^t \log(\hat{c}_{i,n}^t) \quad (12)$$

Object Classification Loss (l)

$$\overbrace{\mathcal{L}_{\text{gen}} = \sum_{t=1}^{\bar{T}} \mathcal{L}_{\text{gen}}^t, \quad \mathcal{L}_{\text{gen}}^t = \sum_{ij} \mathcal{L}_{p_{ij}}^t}^{\text{Predicate Classification Loss (II)}} \quad (13)$$

$$\overbrace{\mathcal{L}_{\text{ant}}^{(1:T)} = \sum_{t=T+1}^{\min(T+H, \bar{T})} \mathcal{L}_{\text{ant}}^t, \quad \mathcal{L}_{\text{ant}}^t = \sum_{ij} \mathcal{L}_{p_{ij}}^t}^{\text{Predicate Classification Loss (III)}} \quad (14)$$

$$\overbrace{\mathcal{L}_{\text{recon}}^{(1:T)} = \sum_{t=T+1}^{\min(T+H, \bar{T})} \mathcal{L}_{\text{recon}}^t, \quad \mathcal{L}_{\text{recon}}^t = \frac{1}{N(t) \times N(t)} \sum_{ij} \text{L}_{\text{smooth}}(\mathbf{z}_{ij}^t - \hat{\mathbf{z}}_{ij}^t)}^{\text{Reconstruction Loss (IV)}} \quad (15)$$

Thus, the total objective for training the proposed method can be written as:

$$\mathcal{L} = \underbrace{\sum_{t=1}^{\bar{T}} \left(\lambda_1 \mathcal{L}_{\text{gen}}^t + \lambda_2 \sum_i \mathcal{L}_i^t \right)}_{\text{Loss Over Observed Representations}} + \underbrace{\sum_{T=3}^{\bar{T}-1} \left(\lambda_3 \mathcal{L}_{\text{ant}}^{(1:T)} + \lambda_4 \mathcal{L}_{\text{recon}}^{(1:T)} \right)}_{\text{Loss Over Anticipated Representations}} \quad (16)$$

Loss Function IMPARTAIL + STTran++

$$\overbrace{\mathcal{L}_i = \sum_{t=1}^{\bar{T}} \mathcal{L}_i^t, \quad \mathcal{L}_i^t = - \sum_{n=1}^{|\mathcal{C}|} y_{i,n}^t \log(\hat{c}_{i,n}^t)}^{\text{Object Classification Loss (I)}} \quad (17)$$

$$\overbrace{\mathcal{L}_{\text{gen}} = \sum_{t=1}^{\bar{T}} \mathcal{L}_{\text{gen}}^t, \quad \mathcal{L}_{\text{gen}}^t = \sum_{ij} \mathbf{m}_{ij}^t * \mathcal{L}_{p_{ij}}^t}^{\text{Predicate Classification Loss (II)}} \quad (18)$$

$$\overbrace{\mathcal{L}_{\text{ant}}^{(1:T)} = \sum_{t=T+1}^{\min(T+H, \bar{T})} \mathcal{L}_{\text{ant}}^t, \quad \mathcal{L}_{\text{ant}}^t = \sum_{ij} \mathbf{m}_{ij}^t * \mathcal{L}_{p_{ij}}^t}^{\text{Predicate Classification Loss (III)}} \quad (19)$$

$$\overbrace{\mathcal{L}_{\text{recon}}^{(1:T)} = \sum_{t=T+1}^{\min(T+H, \bar{T})} \mathcal{L}_{\text{recon}}^t, \quad \mathcal{L}_{\text{recon}}^t = \frac{1}{N(t) \times N(t)} \sum_{ij} \text{L}_{\text{smooth}}(\mathbf{z}_{ij}^t - \hat{\mathbf{z}}_{ij}^t)}^{\text{Reconstruction Loss (IV)}} \quad (20)$$

Thus, the total objective for training the proposed method can be written as:

$$\mathcal{L} = \underbrace{\sum_{t=1}^{\bar{T}} \left(\lambda_1 \mathcal{L}_{\text{gen}}^t + \lambda_2 \sum_i \mathcal{L}_i^t \right)}_{\text{Loss Over Observed Representations}} + \underbrace{\sum_{T=3}^{\bar{T}-1} \left(\lambda_3 \mathcal{L}_{\text{ant}}^{(1:T)} + \lambda_4 \mathcal{L}_{\text{recon}}^{(1:T)} \right)}_{\text{Loss Over Anticipated Representations}} \quad (21)$$

Implementation Details.

- **Training Epochs.** We have capped the number of training epochs for both models, where one uses conventional loss, and the other uses the proposed **IMPARTAIL** framework to 5 epochs.
- **Loss Function.** Results reported in the literature for the method **STTran++** were reproducible using the Multi-Label Margin Loss. We sometimes achieved higher numbers than those reported in the original paper.
- **Hyperparameters.** We use the same hyperparameter settings described in the paper[37].

10.3.2. IMPARTAIL + DSGDetr++

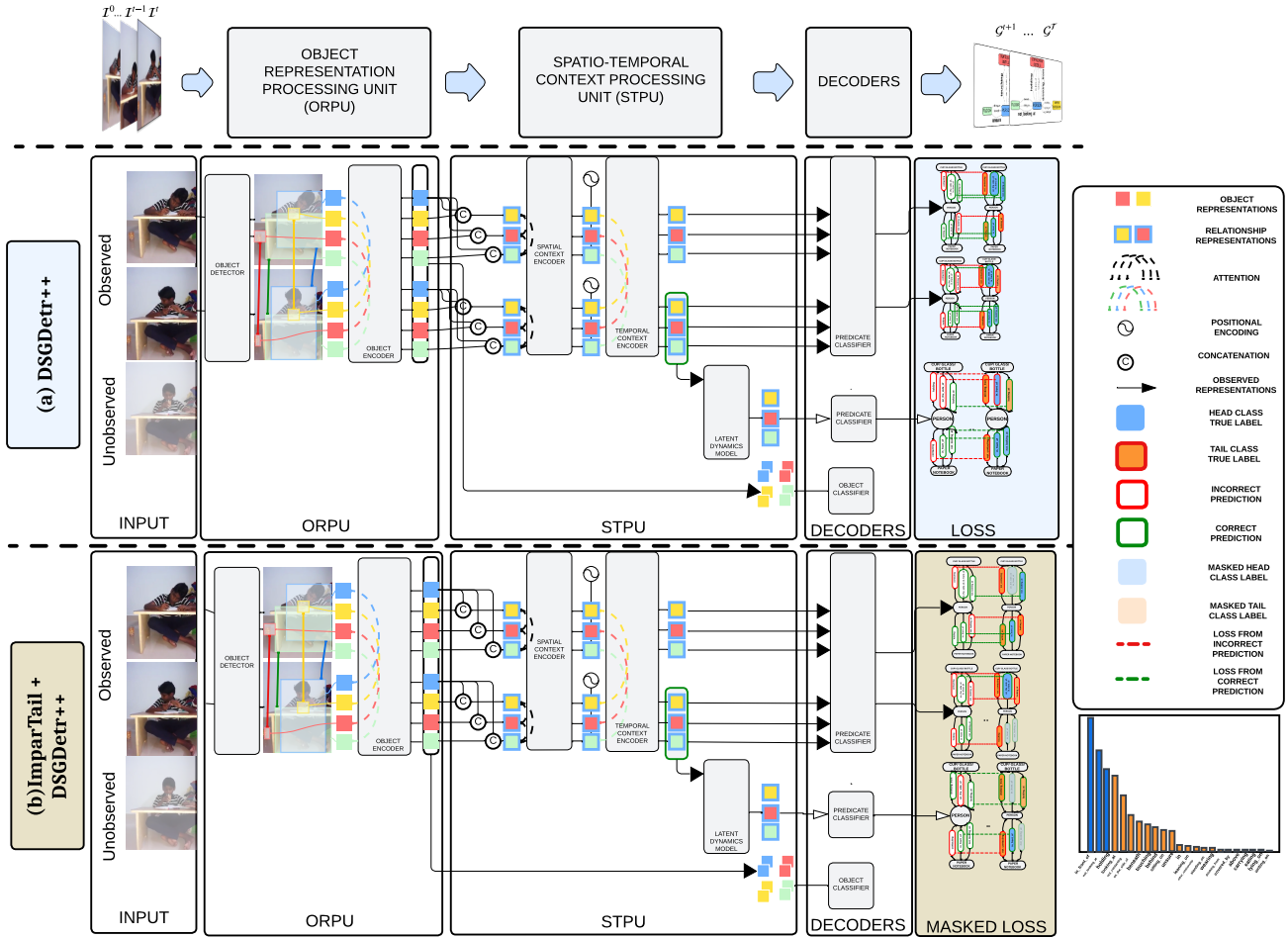

Figure 9. (a) **Architectural Components.** In **DSGDetr++**, the Object Representations Processing Unit (ORPU) primarily consists of an object detector, an object tracker, and an object encoder. The visual features output by the object detector are used to construct tracklets corresponding to each object, and these representations are further enhanced by passing them through an object encoder. Then, the Spatio-Temporal Context Processing Unit (STPU) takes these visual features as input and first constructs relationship representations utilizing the features of interacting objects; then, these relationship representations are fed to a spatial encoder and a transformer encoder. Thus, the spatio-temporal context-aware representations output by the temporal encoder are fed as input to another transformer encoder to anticipate the future relationship representations corresponding to interacting objects. Thus, relationship representations from the temporal encoder and future relationship representations from the anticipatory transformer encoder are input to two predicate classifiers for final predictions. (b) **Loss Function.** The primary difference between **DSGDetr++** loss and the proposed **IMPARTAIL + DSGDetr++** loss is illustrated using highlighting the employed losses. We do not mask any predicate label in **DSGDetr++** loss. In contrast, in the proposed **IMPARTAIL + DSGDetr++** loss, we mask the losses corresponding to the *head* classes output by predicate classification heads corresponding to both observed and anticipated relationship representations.

Loss Function DSGDetr++

$$\underbrace{\mathcal{L}_i = \sum_{t=1}^{\bar{T}} \mathcal{L}_i^t, \quad \mathcal{L}_i^t = - \sum_{n=1}^{|\mathcal{C}|} y_{i,n}^t \log(\hat{c}_{i,n}^t)}_{\text{Object Classification Loss (I)}} \quad (22)$$

$$\underbrace{\mathcal{L}_{\text{gen}} = \sum_{t=1}^{\bar{T}} \mathcal{L}_{\text{gen}}^t, \quad \mathcal{L}_{\text{gen}}^t = \sum_{ij} \mathcal{L}_{p_{ij}}^t}_{\text{Predicate Classification Loss (II)}} \quad (23)$$

$$\underbrace{\mathcal{L}_{\text{ant}}^{(1:T)} = \sum_{t=T+1}^{\min(T+H, \bar{T})} \mathcal{L}_{\text{ant}}^t, \quad \mathcal{L}_{\text{ant}}^t = \sum_{ij} \mathcal{L}_{p_{ij}}^t}_{\text{Predicate Classification Loss (III)}} \quad (24)$$

$$\underbrace{\mathcal{L}_{\text{recon}}^{(1:T)} = \sum_{t=T+1}^{\min(T+H, \bar{T})} \mathcal{L}_{\text{recon}}^t, \quad \mathcal{L}_{\text{recon}}^t = \frac{1}{N(t) \times N(t)} \sum_{ij} \mathbf{L}_{\text{smooth}}(\mathbf{z}_{ij}^t - \hat{\mathbf{z}}_{ij}^t)}_{\text{Reconstruction Loss (IV)}} \quad (25)$$

Thus, the total objective for training the proposed method can be written as:

$$\mathcal{L} = \underbrace{\sum_{t=1}^{\bar{T}} \left(\lambda_1 \mathcal{L}_{\text{gen}}^t + \lambda_2 \sum_i \mathcal{L}_i^t \right)}_{\text{Loss Over Observed Representations}} + \underbrace{\sum_{T=3}^{\bar{T}-1} \left(\lambda_3 \mathcal{L}_{\text{ant}}^{(1:T)} + \lambda_4 \mathcal{L}_{\text{recon}}^{(1:T)} \right)}_{\text{Loss Over Anticipated Representations}} \quad (26)$$

Loss Function IMPARTAIL + DSGDetr++

$$\underbrace{\mathcal{L}_i = \sum_{t=1}^{\bar{T}} \mathcal{L}_i^t, \quad \mathcal{L}_i^t = - \sum_{n=1}^{|\mathcal{C}|} y_{i,n}^t \log(\hat{c}_{i,n}^t)}_{\text{Object Classification Loss (I)}} \quad (27)$$

$$\underbrace{\mathcal{L}_{\text{gen}} = \sum_{t=1}^{\bar{T}} \mathcal{L}_{\text{gen}}^t, \quad \mathcal{L}_{\text{gen}}^t = \sum_{ij} \mathbf{m}_{ij}^t * \mathcal{L}_{p_{ij}}^t}_{\text{Predicate Classification Loss (II)}} \quad (28)$$

$$\underbrace{\mathcal{L}_{\text{ant}}^{(1:T)} = \sum_{t=T+1}^{\min(T+H, \bar{T})} \mathcal{L}_{\text{ant}}^t, \quad \mathcal{L}_{\text{ant}}^t = \sum_{ij} \mathbf{m}_{ij}^t * \mathcal{L}_{p_{ij}}^t}_{\text{Predicate Classification Loss (III)}} \quad (29)$$

$$\underbrace{\mathcal{L}_{\text{recon}}^{(1:T)} = \sum_{t=T+1}^{\min(T+H, \bar{T})} \mathcal{L}_{\text{recon}}^t, \quad \mathcal{L}_{\text{recon}}^t = \frac{1}{N(t) \times N(t)} \sum_{ij} \mathbf{L}_{\text{smooth}}(\mathbf{z}_{ij}^t - \hat{\mathbf{z}}_{ij}^t)}_{\text{Reconstruction Loss (IV)}} \quad (30)$$

Thus, the total objective for training the proposed method can be written as:

$$\mathcal{L} = \underbrace{\sum_{t=1}^{\bar{T}} \left(\lambda_1 \mathcal{L}_{\text{gen}}^t + \lambda_2 \sum_i \mathcal{L}_i^t \right)}_{\text{Loss Over Observed Representations}} + \underbrace{\sum_{T=3}^{\bar{T}-1} \left(\lambda_3 \mathcal{L}_{\text{ant}}^{(1:T)} + \lambda_4 \mathcal{L}_{\text{recon}}^{(1:T)} \right)}_{\text{Loss Over Anticipated Representations}} \quad (31)$$

Implementation Details.

- **Training Epochs.** We have capped the number of training epochs for both models, where one uses conventional loss, and the other uses the proposed IMPARTAIL framework to 5 epochs.
- **Loss Function.** Results reported in the literature for the method DSGDetr++ were reproducible using the Multi-Label Margin Loss. We sometimes achieved higher numbers than those reported in the original paper.
- **Hyperparameters.** We use the same hyperparameter settings described in the paper[37].

10.3.3. IMPARTAIL + SceneSayer

Loss Function SceneSayer

$$\begin{aligned}
 \mathcal{L}_i &= \sum_{t=1}^{\bar{T}} \mathcal{L}_i^t, & \mathcal{L}_i^t &= - \sum_{n=1}^{|\mathcal{C}|} y_{i,n}^t \log(\hat{c}_{i,n}^t); & \mathcal{L}_{\text{gen}} &= \sum_{t=1}^{\bar{T}} \mathcal{L}_{\text{gen}}^t, & \mathcal{L}_{\text{gen}}^t &= \sum_{ij} \mathcal{L}_{p_{ij}}^t \\
 & \underbrace{\hspace{10em}}_{\text{Object Classification Loss (I)}} & & & \underbrace{\hspace{10em}}_{\text{Predicate Classification Loss (II)}} \\
 \mathcal{L}_{\text{ant}}^{(1:T)} &= \sum_{t=T+1}^{\min(T+H, \bar{T})} \mathcal{L}_{\text{ant}}^t, & \mathcal{L}_{\text{ant}}^t &= \sum_{ij} \mathcal{L}_{p_{ij}}^t \\
 \mathcal{L}_{\text{boxes}}^{(1:T)} &= \sum_{t=T+1}^{\min(T+H, \bar{T})} \mathcal{L}_{\text{boxes}}^t, & \mathcal{L}_{\text{boxes}}^t &= \sum_{k \in \text{boxes}} \text{L}_{\text{smooth}}(b_k^t - \hat{b}_k^t) \\
 \mathcal{L}_{\text{recon}}^{(1:T)} &= \sum_{t=T+1}^{\min(T+H, \bar{T})} \mathcal{L}_{\text{recon}}^t, & \mathcal{L}_{\text{recon}}^t &= \frac{1}{N(t) \times N(t)} \sum_{ij} \text{L}_{\text{smooth}}(\mathbf{z}_{ij}^t - \hat{\mathbf{z}}_{ij}^t) \\
 \mathcal{L} &= \underbrace{\sum_{t=1}^{\bar{T}} \left(\lambda_1 \mathcal{L}_{\text{gen}}^t + \lambda_2 \sum_i \mathcal{L}_i^t \right)}_{\text{Loss Over Observed Representations}} + \underbrace{\sum_{T=3}^{\bar{T}-1} \left(\lambda_3 \mathcal{L}_{\text{ant}}^{(1:T)} + \lambda_4 \mathcal{L}_{\text{boxes}}^{(1:T)} + \lambda_5 \mathcal{L}_{\text{recon}}^{(1:T)} \right)}_{\text{Loss Over Anticipated Representations}}
 \end{aligned}$$

Loss Function IMPARTAIL + SceneSayer

$$\begin{aligned}
 \mathcal{L}_i &= \sum_{t=1}^{\bar{T}} \mathcal{L}_i^t, & \mathcal{L}_i^t &= - \sum_{n=1}^{|\mathcal{C}|} y_{i,n}^t \log(\hat{c}_{i,n}^t); & \mathcal{L}_{\text{gen}} &= \sum_{t=1}^{\bar{T}} \mathcal{L}_{\text{gen}}^t, & \mathcal{L}_{\text{gen}}^t &= \sum_{ij} \mathbf{m}_{ij}^t * \mathcal{L}_{p_{ij}}^t \\
 & \underbrace{\hspace{10em}}_{\text{Object Classification Loss (I)}} & & & \underbrace{\hspace{10em}}_{\text{Predicate Classification Loss (II)}} \\
 \mathcal{L}_{\text{ant}}^{(1:T)} &= \sum_{t=T+1}^{\min(T+H, \bar{T})} \mathcal{L}_{\text{ant}}^t, & \mathcal{L}_{\text{ant}}^t &= \sum_{ij} \mathbf{m}_{ij}^t * \mathcal{L}_{p_{ij}}^t \\
 \mathcal{L}_{\text{boxes}}^{(1:T)} &= \sum_{t=T+1}^{\min(T+H, \bar{T})} \mathcal{L}_{\text{boxes}}^t, & \mathcal{L}_{\text{boxes}}^t &= \sum_{k \in \text{boxes}} \text{L}_{\text{smooth}}(b_k^t - \hat{b}_k^t) \\
 \mathcal{L}_{\text{recon}}^{(1:T)} &= \sum_{t=T+1}^{\min(T+H, \bar{T})} \mathcal{L}_{\text{recon}}^t, & \mathcal{L}_{\text{recon}}^t &= \frac{1}{N(t) \times N(t)} \sum_{ij} \text{L}_{\text{smooth}}(\mathbf{z}_{ij}^t - \hat{\mathbf{z}}_{ij}^t) \\
 \mathcal{L} &= \underbrace{\sum_{t=1}^{\bar{T}} \left(\lambda_1 \mathcal{L}_{\text{gen}}^t + \lambda_2 \sum_i \mathcal{L}_i^t \right)}_{\text{Loss Over Observed Representations}} + \underbrace{\sum_{T=3}^{\bar{T}-1} \left(\lambda_3 \mathcal{L}_{\text{ant}}^{(1:T)} + \lambda_4 \mathcal{L}_{\text{boxes}}^{(1:T)} + \lambda_5 \mathcal{L}_{\text{recon}}^{(1:T)} \right)}_{\text{Loss Over Anticipated Representations}}
 \end{aligned}$$

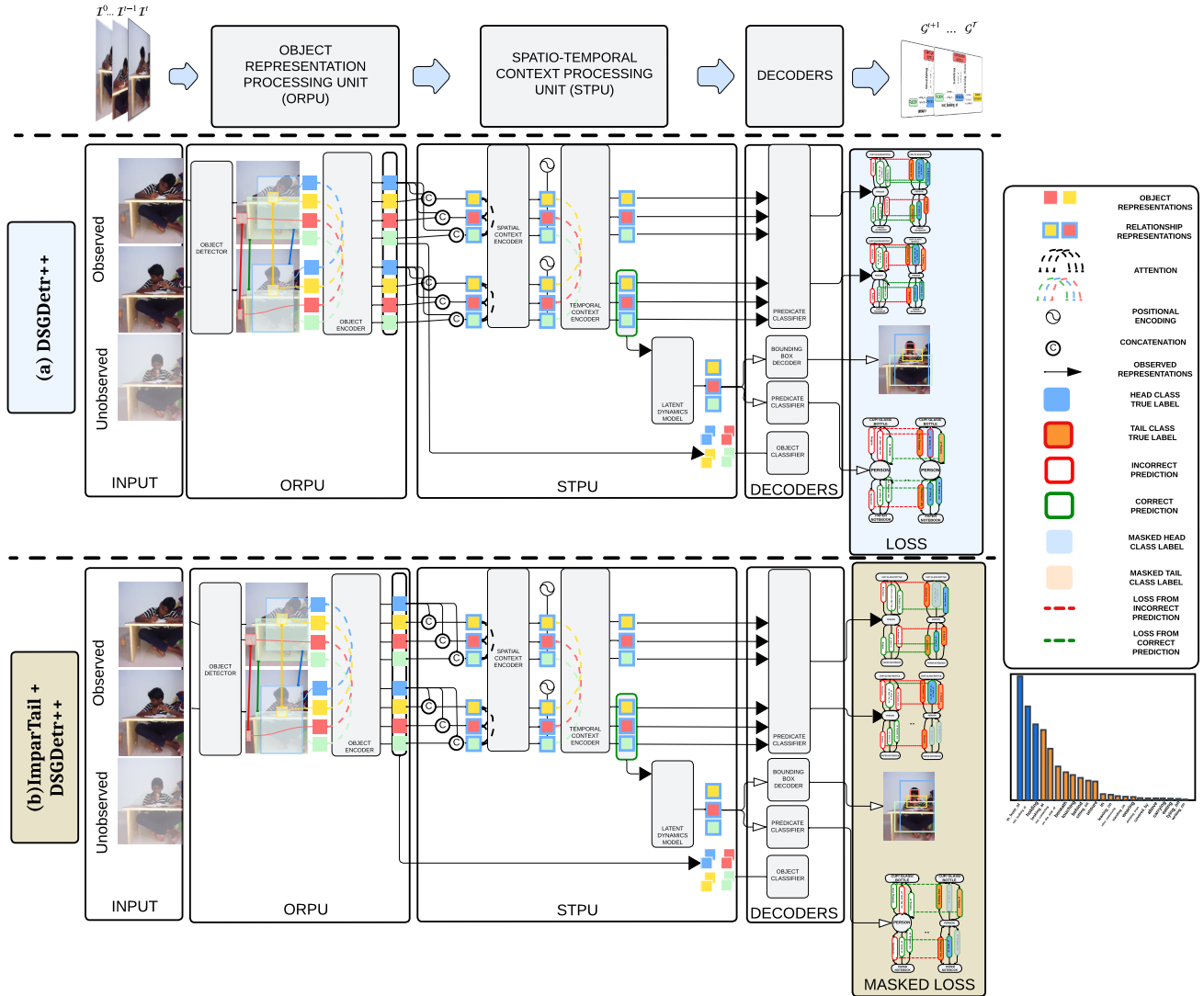

Figure 10. (a) **Architectural Components.** In **SceneSayer**, the Object Representations Processing Unit (ORPU) primarily consists of an object detector an object tracker and an object encoder. The visual features output by the object detector are used to construct tracklets corresponding to each object, and these representations are further enhanced by passing them through an object encoder. Then, the Spatio-Temporal Context Processing Unit (STPU) takes these visual features as input and first constructs relationship representations utilizing the features of interacting objects; then, these relationship representations are fed to a spatial encoder and a transformer encoder. Thus, the spatio-temporal context-aware representations output by the temporal encoder are used as initial values and an Ordinary Differential Equation/ Stochastic Differential Equation is solved to estimate the anticipated future relationship representations corresponding to the interacting objects. Thus, relationship representations from the temporal encoder and future relationship representations from the anticipatory transformer encoder are input to two predicate classifiers for final predictions. (b) **Loss Function.** The primary difference between **SceneSayer** loss and the proposed **IMPARTAIL + SceneSayer** loss is illustrated using highlighting the employed losses. We do not mask any predicate label in **SceneSayer** loss. In contrast, in the proposed **IMPARTAIL + SceneSayer** loss, we mask the losses corresponding to the *head* classes output by predicate classification heads corresponding to both observed and anticipated relationship representations.

11. Ablation-Overview

11.1. Video Scene Graph Generation

11.1.1. Modes

We evaluate the trained models corresponding to baseline variants `STTran`, `DSGDetr` and the proposed method

`IMPARTAIL + STTran`, `IMPARTAIL + DSGDetr` using three standard modes described in the literature. (1) **Scene Graph Detection (SGDET)**, (2) **Scene Graph Classification (SGCLS)** and (3) **Predicate Classification (PREDCLS)**.

- **Scene Graph Detection (SGDET)**: In this mode, the model is input with frames corresponding to videos. It is tasked to detect objects and predict the relationship predicates between the detected objects.
- **Scene Graph Classification (SGCLS)**: In this mode, the model is input with frames corresponding to videos along with bounding boxes of the objects. It is tasked to predict the relationship predicates between the objects.
- **Predicate Classification (PREDCLS)**: In this mode, the model is input with frames corresponding to videos along with bounding boxes of the objects and the object labels. It is tasked to predict the relationship predicates between the objects.

11.1.2. Implementation Details.

- **Min Threshold.** As `IMPARTAIL` proposes a curriculum-guided mask generation strategy, where the number of labels masked in each epoch increases monotonically.
 1. Thus, based on the maximum amount of masking applied, we train three variants of models - {70, 40, 10}.
 2. These models correspond to the following scenarios: (1) **70**: Start from the complete data and reach a {70%, 40%, 10%} masked settings in the last epochs, respectively.
- In section 12, we provide findings corresponding to the proposed training scenarios.

11.2. Scene Graph Anticipation

11.2.1. Modes

We evaluate the trained models corresponding to baseline variants `STTran++`, `DSGDetr++`,

`SceneSayerODE`, `SceneSayerSDE` and the proposed methods `IMPARTAIL + STTran++`, `IMPARTAIL + DSGDetr++`, `IMPARTAIL + SceneSayerODE`,

`IMPARTAIL + SceneSayerSDE` using three standard modes described in the literature. (1) **Action Genome Scenes (AGS)**, (2) **Partially Grounded Action Genome Scenes (PGAGS)** and (3) **Grounded Action Genome Scenes (GAGS)**.

- **Action Genome Scenes (AGS)**: In this mode, the model receives only the video frames and is tasked to detect objects and infer future relationships between them.
- **Partially Grounded Action Genome Scenes (PGAGS)**: In this mode, the model, along with frames, also receives the bounding boxes corresponding to the objects. It is tasked to use this information to infer relationships corresponding to future frames
- **Grounded Action Genome Scenes (GAGS)**: In this mode, the model, along with frames, also receives the bounding boxes corresponding to the objects and their labels. It is tasked to use this information to infer future relationships corresponding to interacting objects.

11.2.2. Implementation Details.

- **Min Threshold.** As `IMPARTAIL` proposes a curriculum-guided mask generation strategy, where the number of labels masked in each epoch increases monotonically.
 1. Thus, based on the maximum amount of masking applied, we train three variants of models - {70, 40, 10}.
 2. These models correspond to the following scenarios: (1) **70**: Start from the complete data and reach a {70%, 40%, 10%} masked settings in the last epochs, respectively.
- In section 12, we provide findings corresponding to the proposed training scenarios.

11.3. Robustness Evaluation.

In section 12, we evaluate the robustness of trained models corresponding to input corruptions and present the results for each mode described above.

12. Ablation Results

12.1. Video Scene Graph Generation

12.1.1. Findings

- Table 5** provides a comparative analysis under **NO CONSTRAINT** graph building strategy for different modes and methods for VidSGG, presenting results under various recall metrics (R@10, R@20, R@50, R@100) and mean recall metrics (mR@10, mR@20, mR@50, mR@100).
 - We observe that employing the proposed method, the mean recall metrics improved across all modes with only a marginal decrease in recall scores; for example, in the SGDET mode with the STTran method, R@10 slightly decreases from 20.30 to 20.20, conversely, mR@10 increases from 19.30 to 23.50.
 - We also observe that the mean recall scores follow a monotonic trend as we increase the masking ratio (avoiding more head classes). We note that the reduction in the recall values is very low.
- Table 6, Table 7** provides a comparative analysis under **WITH/SEMI CONSTRAINT** graph building strategy
 - We observe that the proposed method improves the mean recall significantly across most setups, though its effect on standard recall metrics is mixed, slightly resulting in a decrease.
- In **Table 6** for STTran under the SGCLS mode, while our method slightly reduced standard recall metrics @100 by 11.6%, there is a notable improvement in mean recall, mR@100 by 36.2%. PREDCLS mode shows less variability in recall changes using our method but substantially increases mean recalls @50 for STTran, jumping from 34.80 to 52.90. While **IMPARTAIL (Ours)** augmentation in constrained and semi-constrained results in decreases in R@50 by 15%, it boosts mR@50 by over 25%.

12.1.2. Results

Table 5. No Constraint Results for VidSGG.

Mode	Method	S	NO CONSTRAINT							
			R@10	R@20	R@50	R@100	mR@10	mR@20	mR@50	mR@100
SGCLS	STTran [7]	-	51.60	62.80	66.30	66.60	38.80	47.10	59.90	66.70
	+IMPARTAIL (Ours)	70	49.80 (-3.49%)	62.40 (-0.64%)	66.40 (+0.15%)	66.70 (+0.15%)	43.10 (+11.08%)	53.10 (+12.74%)	61.00 (+1.84%)	65.00 (-2.55%)
	+IMPARTAIL (Ours)	40	49.90 (-3.29%)	62.10 (-1.11%)	66.40 (+0.15%)	66.70 (+0.15%)	45.10 (+16.24%)	55.10 (+16.99%)	64.10 (+7.01%)	66.60 (-0.15%)
	+IMPARTAIL (Ours)	10	48.50 (-6.01%)	61.30 (-2.39%)	66.20 (-0.15%)	66.50 (-0.15%)	47.40 (+22.16%)	57.50 (+22.08%)	66.60 (+11.19%)	68.10 (+2.10%)
	DSGDetr [11]	-	55.50	68.00	72.40	72.80	39.90	49.40	64.60	72.70
	+IMPARTAIL (Ours)	70	53.30 (-3.96%)	67.30 (-1.03%)	72.10 (-0.41%)	72.60 (-0.27%)	42.90 (+7.52%)	53.10 (+7.49%)	66.10 (+2.32%)	72.20 (-0.69%)
	+IMPARTAIL (Ours)	40	50.90 (-8.29%)	66.10 (-2.79%)	72.10 (-0.41%)	72.60 (-0.27%)	45.00 (+12.78%)	55.50 (+12.35%)	67.20 (+4.02%)	71.40 (-1.79%)
	+IMPARTAIL (Ours)	10	50.20 (-9.55%)	65.30 (-3.97%)	71.90 (-0.69%)	72.70 (-0.14%)	48.80 (+22.31%)	59.60 (+20.65%)	70.10 (+8.51%)	72.20 (-0.69%)
SGDET	STTran [7]	-	20.30	31.10	45.90	48.40	19.30	26.90	35.60	39.70
	+IMPARTAIL (Ours)	70	19.80 (-2.46%)	30.20 (-2.89%)	45.80 (-0.22%)	48.60 (+0.41%)	20.80 (+7.77%)	29.50 (+9.67%)	38.70 (+8.71%)	42.00 (+5.79%)
	+IMPARTAIL (Ours)	40	20.20 (-0.49%)	30.80 (-0.96%)	45.30 (-1.31%)	48.20 (-0.41%)	22.60 (+17.10%)	31.10 (+15.61%)	39.10 (+9.83%)	42.10 (+6.05%)
	+IMPARTAIL (Ours)	10	20.00 (-1.48%)	30.10 (-3.22%)	45.10 (-1.74%)	48.50 (+0.21%)	23.50 (+21.76%)	33.60 (+24.91%)	43.80 (+23.03%)	47.00 (+18.39%)
	DSGDetr [11]	-	29.80	39.00	46.40	48.30	23.30	29.80	36.00	39.70
	+IMPARTAIL (Ours)	70	28.60 (-4.03%)	38.00 (-2.56%)	46.40	49.00 (+1.45%)	25.00 (+7.30%)	32.00 (+7.38%)	39.30 (+9.17%)	42.50 (+7.05%)
	+IMPARTAIL (Ours)	40	25.90 (-13.09%)	36.10 (-7.44%)	45.60 (-1.72%)	48.70 (+0.83%)	24.70 (+6.01%)	32.20 (+8.05%)	39.60 (+10.00%)	43.20 (+8.82%)
	+IMPARTAIL (Ours)	10	26.50 (-11.07%)	36.10 (-7.44%)	45.20 (-2.59%)	48.40 (+0.21%)	27.50 (+18.03%)	35.20 (+18.12%)	43.30 (+20.28%)	46.60 (+17.38%)
PREDCLS	STTran [7]	-	73.20	92.70	99.20	99.90	45.70	63.40	80.50	95.60
	+IMPARTAIL (Ours)	70	70.20 (-4.10%)	91.40 (-1.40%)	99.30 (+0.10%)	99.90	55.00 (+20.35%)	71.80 (+13.25%)	86.70 (+7.70%)	97.00 (+1.46%)
	+IMPARTAIL (Ours)	40	67.50 (-7.79%)	89.70 (-3.24%)	99.20	99.90	54.80 (+19.91%)	72.10 (+13.72%)	86.70 (+7.70%)	97.20 (+1.67%)
	+IMPARTAIL (Ours)	10	67.50 (-7.79%)	88.80 (-4.21%)	99.00 (-0.20%)	99.90	65.50 (+43.33%)	82.00 (+29.34%)	93.00 (+15.53%)	99.60 (+4.18%)
	DSGDetr [11]	-	72.80	92.40	99.20	99.90	45.60	64.40	80.50	94.70
	+IMPARTAIL (Ours)	70	67.70 (-7.01%)	89.60 (-3.03%)	99.20	99.90	56.00 (+22.81%)	72.60 (+12.73%)	85.90 (+6.71%)	97.30 (+2.75%)
	+IMPARTAIL (Ours)	40	68.00 (-6.59%)	90.10 (-2.49%)	99.20	99.90	54.50 (+19.52%)	71.80 (+11.49%)	86.40 (+7.33%)	97.30 (+2.75%)
	+IMPARTAIL (Ours)	10	65.80 (-9.62%)	87.70 (-5.09%)	98.90 (-0.30%)	99.90	59.40 (+30.26%)	76.20 (+18.32%)	89.80 (+11.55%)	98.10 (+3.59%)

Table 6. With Constraint Results for VidSGG.

Mode	Method	S	WITH CONSTRAINT							
			R@10	R@20	R@50	R@100	mR@10	mR@20	mR@50	mR@100
SGCLS	STTran [7]	-	44.90	46.50	46.50	46.50	25.00	27.50	27.60	27.60
	+IMPARTAIL (Ours)	70	42.00 (-6.46%)	43.30 (-6.88%)	43.30 (-6.88%)	43.30 (-6.88%)	25.90 (+3.60%)	28.70 (+4.36%)	28.80 (+4.35%)	28.80 (+4.35%)
	+IMPARTAIL (Ours)	40	42.40 (-5.57%)	43.70 (-6.02%)	43.80 (-5.81%)	43.80 (-5.81%)	27.80 (+11.20%)	30.60 (+11.27%)	30.70 (+11.23%)	30.70 (+11.23%)
	+IMPARTAIL (Ours)	10	39.90 (-11.14%)	41.10 (-11.61%)	41.10 (-11.61%)	41.10 (-11.61%)	32.30 (+29.20%)	36.20 (+31.64%)	36.20 (+31.16%)	36.20 (+31.16%)
	DSGDetr [11]	-	47.80	49.30	49.40	49.40	25.60	28.10	28.10	28.10
	+IMPARTAIL (Ours)	70	46.00 (-3.77%)	47.40 (-3.85%)	47.40 (-4.05%)	47.40 (-4.05%)	27.10 (+5.86%)	30.20 (+7.47%)	30.30 (+7.83%)	30.30 (+7.83%)
	+IMPARTAIL (Ours)	40	41.20 (-13.81%)	42.40 (-14.00%)	42.40 (-14.17%)	42.40 (-14.17%)	27.90 (+8.98%)	30.80 (+9.61%)	30.80 (+9.61%)	30.80 (+9.61%)
	+IMPARTAIL (Ours)	10	40.50 (-15.27%)	42.00 (-14.81%)	42.00 (-14.98%)	42.00 (-14.98%)	32.20 (+25.78%)	36.00 (+28.11%)	36.00 (+28.11%)	36.00 (+28.11%)
SGDET	STTran [7]	-	19.00	29.40	32.10	32.10	8.00	16.60	19.30	19.30
	+IMPARTAIL (Ours)	70	17.90 (-5.79%)	27.80 (-5.44%)	30.60 (-4.67%)	30.60 (-4.67%)	8.20 (+2.50%)	17.50 (+5.42%)	20.60 (+6.74%)	20.60 (+6.74%)
	+IMPARTAIL (Ours)	40	17.50 (-7.89%)	27.50 (-6.46%)	30.30 (-5.61%)	30.30 (-5.61%)	8.80 (+10.00%)	19.20 (+15.66%)	22.60 (+17.10%)	22.60 (+17.10%)
	+IMPARTAIL (Ours)	10	16.00 (-15.79%)	25.60 (-12.93%)	28.40 (-11.53%)	28.40 (-11.53%)	9.40 (+17.50%)	21.50 (+29.52%)	25.90 (+34.20%)	25.90 (+34.20%)
	DSGDetr [11]	-	17.10	28.80	33.90	33.90	6.70	14.70	19.10	19.10
	+IMPARTAIL (Ours)	70	16.30 (-4.68%)	27.50 (-4.51%)	32.50 (-4.13%)	32.60 (-4.83%)	7.40 (+10.45%)	17.60 (+19.73%)	23.20 (+21.47%)	23.20 (+21.47%)
	+IMPARTAIL (Ours)	40	14.10 (-17.54%)	23.40 (-18.75%)	27.40 (-19.17%)	27.50 (-18.88%)	7.30 (+8.96%)	16.80 (+14.29%)	22.40 (+17.28%)	22.40 (+17.28%)
	+IMPARTAIL (Ours)	10	15.40 (-9.94%)	25.70 (-10.76%)	30.10 (-11.21%)	30.10 (-11.21%)	7.50 (+11.94%)	17.80 (+21.09%)	23.70 (+24.08%)	23.80 (+24.61%)
PREDCLS	STTran [7]	-	66.40	69.90	69.90	69.90	30.50	34.70	34.80	34.80
	+IMPARTAIL (Ours)	70	61.50 (-7.38%)	64.80 (-7.30%)	64.80 (-7.30%)	64.80 (-7.30%)	34.30 (+12.46%)	39.70 (+14.41%)	39.80 (+14.37%)	39.80 (+14.37%)
	+IMPARTAIL (Ours)	40	57.20 (-13.86%)	60.20 (-13.88%)	60.30 (-13.73%)	60.30 (-13.73%)	37.40 (+22.62%)	43.60 (+25.65%)	43.80 (+25.86%)	43.80 (+25.86%)
	+IMPARTAIL (Ours)	10	57.70 (-13.10%)	60.80 (-13.02%)	60.80 (-13.02%)	60.80 (-13.02%)	44.00 (+44.26%)	52.70 (+51.87%)	52.90 (+52.01%)	52.90 (+52.01%)
	DSGDetr [11]	-	66.50	70.00	70.00	70.00	31.50	36.10	36.20	36.20
	+IMPARTAIL (Ours)	70	58.30 (-12.33%)	61.50 (-12.14%)	61.50 (-12.14%)	61.50 (-12.14%)	38.20 (+21.27%)	45.00 (+24.65%)	45.10 (+24.59%)	45.10 (+24.59%)
	+IMPARTAIL (Ours)	40	58.00 (-12.78%)	61.10 (-12.71%)	61.10 (-12.71%)	61.10 (-12.71%)	37.30 (+18.41%)	43.40 (+20.22%)	43.50 (+20.17%)	43.50 (+20.17%)
	+IMPARTAIL (Ours)	10	55.50 (-16.54%)	58.30 (-16.71%)	58.30 (-16.71%)	58.30 (-16.71%)	41.00 (+30.16%)	48.10 (+33.24%)	48.20 (+33.15%)	48.20 (+33.15%)

Table 7. Semi Constraint Results for VidSGG.

Mode	Method	S	SEMI CONSTRAINT							
			R@10	R@20	R@50	R@100	mR@10	mR@20	mR@50	mR@100
SGCLS	STTran [7]	-	49.90	55.80	56.20	56.20	29.50	39.90	40.90	40.90
	+IMPARTAIL (Ours)	70	49.00 (-1.80%)	55.60 (-0.36%)	56.20	56.20	32.50 (+10.17%)	45.80 (+14.79%)	47.60 (+16.38%)	47.60 (+16.38%)
	+IMPARTAIL (Ours)	40	48.60 (-2.61%)	54.80 (-1.79%)	55.20 (-1.78%)	55.20 (-1.78%)	34.30 (+16.27%)	48.40 (+21.30%)	50.00 (+22.25%)	50.00 (+22.25%)
	+IMPARTAIL (Ours)	10	46.40 (-7.01%)	52.40 (-6.09%)	52.80 (-6.05%)	52.80 (-6.05%)	36.20 (+22.71%)	50.50 (+26.57%)	52.20 (+27.63%)	52.20 (+27.63%)
	DSGDetr [11]	-	53.90	60.40	60.70	60.70	30.10	40.60	41.60	41.60
	+IMPARTAIL (Ours)	70	52.30 (-2.97%)	59.60 (-1.32%)	60.30 (-0.66%)	60.30 (-0.66%)	32.50 (+7.97%)	45.20 (+11.33%)	47.20 (+13.46%)	47.20 (+13.46%)
	+IMPARTAIL (Ours)	40	50.50 (-6.31%)	58.50 (-3.15%)	59.50 (-1.98%)	59.50 (-1.98%)	33.90 (+12.62%)	49.00 (+20.69%)	51.70 (+24.28%)	51.70 (+24.28%)
	+IMPARTAIL (Ours)	10	46.80 (-13.17%)	53.80 (-10.93%)	54.40 (-10.38%)	54.40 (-10.38%)	36.80 (+22.26%)	52.40 (+29.06%)	54.90 (+31.97%)	54.90 (+31.97%)
SGDET	STTran [7]	-	18.60	31.00	41.20	41.50	7.70	18.20	30.40	30.80
	+IMPARTAIL (Ours)	70	18.00 (-3.23%)	30.10 (-2.90%)	41.10 (-0.24%)	41.70 (+0.48%)	7.90 (+2.60%)	19.00 (+4.40%)	33.90 (+11.51%)	34.60 (+12.34%)
	+IMPARTAIL (Ours)	40	17.70 (-4.84%)	29.70 (-4.19%)	39.10 (-5.10%)	39.40 (-5.06%)	8.70 (+12.99%)	21.30 (+17.03%)	34.80 (+14.47%)	35.10 (+13.96%)
	+IMPARTAIL (Ours)	10	16.40 (-11.83%)	28.20 (-9.03%)	37.90 (-8.01%)	38.20 (-7.95%)	8.60 (+11.69%)	21.80 (+19.78%)	38.30 (+25.99%)	38.80 (+25.97%)
	DSGDetr [11]	-	16.40	28.70	40.70	41.50	6.50	16.00	30.40	31.50
	+IMPARTAIL (Ours)	70	15.80 (-3.66%)	27.90 (-2.79%)	40.20 (-1.23%)	41.20 (-0.72%)	6.90 (+6.15%)	17.30 (+8.12%)	34.20 (+12.50%)	35.60 (+13.02%)
	+IMPARTAIL (Ours)	40	14.10 (-14.02%)	25.20 (-12.20%)	37.30 (-8.35%)	38.70 (-6.75%)	6.90 (+6.15%)	16.70 (+4.38%)	33.40 (+9.87%)	35.20 (+11.75%)
	+IMPARTAIL (Ours)	10	15.20 (-7.32%)	26.80 (-6.62%)	37.90 (-6.88%)	39.00 (-6.02%)	7.30 (+12.31%)	18.40 (+15.00%)	36.60 (+20.39%)	38.40 (+21.90%)
PREDCLS	STTran [7]	-	71.80	82.50	83.30	83.30	36.60	51.80	53.80	53.80
	+IMPARTAIL (Ours)	70	69.60 (-3.06%)	81.30 (-1.45%)	82.60 (-0.84%)	82.60 (-0.84%)	41.60 (+13.66%)	61.90 (+19.50%)	65.60 (+21.93%)	65.60 (+21.93%)
	+IMPARTAIL (Ours)	40	66.40 (-7.52%)	77.90 (-5.58%)	79.30 (-4.80%)	79.30 (-4.80%)	42.10 (+15.03%)	62.40 (+20.46%)	66.20 (+23.05%)	66.20 (+23.05%)
	+IMPARTAIL (Ours)	10	63.80 (-11.14%)	74.20 (-10.06%)	75.20 (-9.72%)	75.20 (-9.72%)	47.70 (+30.33%)	69.70 (+34.56%)	73.40 (+36.43%)	73.40 (+36.43%)
	DSGDetr [11]	-	71.30	82.50	83.50	83.50	36.50	52.50	55.20	55.20
	+IMPARTAIL (Ours)	70	66.80 (-6.31%)	78.90 (-4.36%)	80.40 (-3.71%)	80.40 (-3.71%)	41.60 (+13.97%)	63.00 (+20.00%)	67.70 (+22.64%)	67.70 (+22.64%)
	+IMPARTAIL (Ours)	40	66.10 (-7.29%)	77.30 (-6.30%)	78.70 (-5.75%)	78.70 (-5.75%)	42.30 (+15.89%)	61.70 (+17.52%)	65.30 (+18.30%)	65.30 (+18.30%)
	+IMPARTAIL (Ours)	10	63.50 (-10.94%)	75.50 (-8.48%)	77.10 (-7.66%)	77.10 (-7.66%)	43.90 (+20.27%)	65.40 (+24.57%)	69.80 (+26.45%)	69.80 (+26.45%)

12.2. Scene Graph Anticipation

12.2.1. Findings

Here, \mathcal{S} - represents the amount of things included in the masked dataset. To be more precise, $\mathcal{S} = 10\%$ means that only 10% of the labels are included in training the model for the current epoch and 90% of the labels are masked, thus voiding their contribution to the loss. So $\mathcal{S} = 70\%$ has more labels contributing to the training loss and $\mathcal{S} = 10\%$ less number of labels contributing to the training loss.

1. Table 8, Table 9, Table 10, Table 11, compare proposed method’s performance across various base methods (STTran++, DSGDet++, SceneSayerODE, and SceneSayerSDE) at different \mathcal{F} values (0.3, 0.5, 0.7, and 0.9) for Scene Graph Generation (SGA) task, under the GAGS-No Constraint setting.
 - (a) In Table 8, SceneSayerODE shows the most consistent gain in lower recall metrics (R@10 and mR@10) when **IMPARTAIL** is included. For $\mathcal{S}=70$, improvements with **IMPARTAIL** are substantial, especially for STTran++ (e.g., +13.74% for R@10). Lower values of \mathcal{S} (e.g., $\mathcal{S}=10$) tend to result in less significant improvements. Metrics like mR@50 and mR@100 remain stable or show slight improvements, emphasizing **IMPARTAIL**’s balanced handling of long-tail distributions.
 - (b) In Table 9, Table 10, Table 11, **IMPARTAIL** continues to show consistent improvements, especially for mR metrics, with substantial gains seen in SceneSayerODE and SceneSayerSDE for mR@10 and mR@20. The relative improvement in metrics is more pronounced compared to Table 8, suggesting that **IMPARTAIL** is more impactful as the \mathcal{F} value increases.
2. Table 12, Table 13, Table 14, Table 15, evaluates **IMPARTAIL** under the Partially Grounded Action Genome Scenes (PGAGS) - No Constraint setting.
 - (a) As \mathcal{F} increases from 0.3 to 0.9, the improvements in mR metrics, particularly for mR@10 and mR@20, become more pronounced.
 - (b) **IMPARTAIL** improves both R metrics (favouring head classes) and mR metrics (favouring tail classes) as \mathcal{F} increases. For instance, significant gains in mR@10 and mR@20 consistently align with moderate or stable improvements in R@10 and R@20 across all models and configurations.
 - (c) All baseline methods (STTran++, DSGDet++, SceneSayerODE, and SceneSayerSDE) benefit from the inclusion of **IMPARTAIL (Ours)**, though the degree of improvement varies. The results also highlight **IMPARTAIL**’s compatibility with high \mathcal{S} , with significant gains observed at high \mathcal{F} values (e.g., +49.76% for mR@10 at $\mathcal{F}=0.7$).
3. Table 16, Table 17, Table 18, Table 19, present the performance evaluation of **IMPARTAIL**’s under the Action Genome Scenes (AGS) in No Constraint graph building strategy, for Scene Graph Generation (SGA).
 - (a) At lower \mathcal{F} values (e.g., $\mathcal{F}=0.3$), the improvements in mR metrics are moderate. At higher \mathcal{F} values (e.g., $\mathcal{F}=0.9$), mR metrics show substantial improvement, highlighting **IMPARTAIL**’s strong performance.
 - (b) For SceneSayerSDE (Table 19, $\mathcal{F}=0.9$), mR@10 increases from 19.10 to 29.30 (+53.40%) with **IMPARTAIL**.
 - (c) **IMPARTAIL** achieves balanced gains. For example in Table 17 ($\mathcal{F}=0.5$), for DSGDet++, **IMPARTAIL** improves R@10 from 21.9 to 22.8 (+4.11%) and mR@10 from 11.80 to 13.50 (+14.41%).
4. Table 20, Table 21, Table 22, Table 23, present the With Constraint evaluation results for Scene Graph Generation (SGA) for GAGS. Table 24, Table 25, Table 26, Table 27, present the With Constraint evaluation results for Scene Graph Generation (SGA) for PGAGS. Table 28, Table 29, Table 30, Table 31 present the With Constraint evaluation results for Scene Graph Generation (SGA) for GAGS.
 - (a) **IMPARTAIL** consistently improves under constrained settings but with smaller gains than the No Constraint scenario.
 - (b) GAGS (Tables 16-19) for fully grounded relationships and constraints result in consistent performance gains with **IMPARTAIL**, especially for SceneSayerSDE.
 - (c) Gains in mR metrics dominate, with the highest improvements observed at $\mathcal{F}=0.9$. In PGAGS, gains are moderate compared to GAGS, with mR metrics seeing smaller improvements.

12.2.2. Results - No Constraint Setting - Grounded Action Genome Scenes (GAGS)

Table 8. GAGS-No Constraint-0.3 results for SGA.

\mathcal{F}	Method	\mathcal{S}	NO CONSTRAINT							
			R@10	R@20	R@50	R@100	mR@10	mR@20	mR@50	mR@100
0.3	STTran++ [37]	-	39.30	55.60	65.20	65.80	23.10	35.50	59.20	70.60
	+IMPARTAIL (Ours)	70	44.70 (+13.74%)	57.60 (+3.60%)	65.00 (-0.31%)	65.80	24.60 (+6.49%)	37.60 (+5.92%)	59.50 (+0.51%)	70.60
	+IMPARTAIL (Ours)	40	40.20 (+2.29%)	55.10 (-0.90%)	64.80 (-0.61%)	65.80	21.50 (-6.93%)	33.50 (-5.63%)	56.20 (-5.07%)	69.80 (-1.13%)
	+IMPARTAIL (Ours)	10	40.50 (+3.05%)	55.20 (-0.72%)	64.60 (-0.92%)	65.70 (-0.15%)	21.70 (-6.06%)	35.70 (+0.56%)	59.90 (+1.18%)	70.60
	DSGDetr++ [37]	-	43.80	57.80	65.10	65.80	21.20	34.30	57.40	70.10
	+IMPARTAIL (Ours)	70	44.10 (+0.68%)	57.30 (-0.87%)	65.10	65.80	22.10 (+4.25%)	35.60 (+3.79%)	59.50 (+3.66%)	69.90 (-0.29%)
	+IMPARTAIL (Ours)	40	44.30 (+1.14%)	57.40 (-0.69%)	65.10	65.80	26.20 (+23.58%)	39.90 (+16.33%)	60.00 (+4.53%)	69.90 (-0.29%)
	+IMPARTAIL (Ours)	10	37.50 (-14.38%)	52.90 (-8.48%)	63.90 (-1.84%)	65.70 (-0.15%)	20.10 (-5.19%)	33.50 (-2.33%)	58.40 (+1.74%)	70.80 (+1.00%)
	SceneSayerODE [37]	-	40.30	54.00	63.80	65.70	22.20	34.50	56.70	68.20
	+IMPARTAIL (Ours)	70	40.70 (+0.99%)	55.70 (+3.15%)	64.70 (+1.41%)	65.70	25.10 (+13.06%)	38.40 (+11.30%)	60.30 (+6.35%)	69.70 (+2.20%)
	+IMPARTAIL (Ours)	40	39.70 (-1.49%)	53.80 (-0.37%)	63.80	65.60 (-0.15%)	20.00 (-9.91%)	31.50 (-8.70%)	54.40 (-4.06%)	67.80 (-0.59%)
	+IMPARTAIL (Ours)	10	28.70 (-28.78%)	44.60 (-17.41%)	61.50 (-3.61%)	65.40 (-0.46%)	22.80 (+2.70%)	35.90 (+4.06%)	57.40 (+1.23%)	69.50 (+1.91%)
	SceneSayerSDE [37]	-	46.40	58.80	65.20	65.80	23.10	35.70	57.70	68.60
	+IMPARTAIL (Ours)	70	44.60 (-3.88%)	58.20 (-1.02%)	65.20	65.80	28.80 (+24.68%)	43.70 (+22.41%)	62.80 (+8.84%)	71.20 (+3.79%)
	+IMPARTAIL (Ours)	40	46.10 (-0.65%)	58.90 (+0.17%)	65.20	65.80	24.90 (+7.79%)	37.80 (+5.88%)	58.60 (+1.56%)	68.90 (+0.44%)
	+IMPARTAIL (Ours)	10	38.90 (-16.16%)	54.00 (-8.16%)	64.80 (-0.61%)	65.80	31.60 (+36.80%)	44.60 (+24.93%)	64.50 (+11.79%)	71.20 (+3.79%)

Table 9. GAGS-No Constraint-0.5 results for SGA.

\mathcal{F}	Method	\mathcal{S}	NO CONSTRAINT							
			R@10	R@20	R@50	R@100	mR@10	mR@20	mR@50	mR@100
0.5	STTran++ [37]	-	45.10	63.30	73.40	74.00	25.20	39.40	63.50	75.30
	+IMPARTAIL (Ours)	70	50.50 (+11.97%)	64.90 (+2.53%)	73.30 (-0.14%)	74.00	27.30 (+8.33%)	41.60 (+5.58%)	64.50 (+1.57%)	75.40 (+0.13%)
	+IMPARTAIL (Ours)	40	45.60 (+1.11%)	62.60 (-1.11%)	73.00 (-0.54%)	74.00	23.90 (-5.16%)	37.40 (-5.08%)	60.70 (-4.41%)	74.90 (-0.53%)
	+IMPARTAIL (Ours)	10	45.40 (+0.67%)	61.90 (-2.21%)	72.60 (-1.09%)	73.90 (-0.14%)	23.70 (-5.95%)	39.20 (-0.51%)	64.10 (+0.94%)	75.00 (-0.40%)
	DSGDetr++ [37]	-	49.50	65.40	73.40	74.00	23.20	37.30	62.90	74.90
	+IMPARTAIL (Ours)	70	50.10 (+1.21%)	65.00 (-0.61%)	73.40	74.00	24.90 (+7.33%)	39.70 (+6.43%)	64.10 (+1.91%)	75.00 (+0.13%)
	+IMPARTAIL (Ours)	40	49.90 (+0.81%)	64.50 (-1.38%)	73.40	74.00	28.20 (+21.55%)	42.20 (+13.14%)	64.90 (+3.18%)	75.20 (+0.40%)
	+IMPARTAIL (Ours)	10	41.70 (-15.76%)	60.00 (-8.26%)	72.30 (-1.50%)	73.90 (-0.14%)	23.30 (+0.43%)	38.40 (+2.95%)	63.20 (+0.48%)	75.20 (+0.40%)
	SceneSayerODE [37]	-	47.20	62.40	72.50	73.90	24.90	38.00	61.80	74.30
	+IMPARTAIL (Ours)	70	46.80 (-0.85%)	63.30 (+1.44%)	73.00 (+0.69%)	74.00 (+0.14%)	27.90 (+12.05%)	42.50 (+11.84%)	65.20 (+5.50%)	75.40 (+1.48%)
	+IMPARTAIL (Ours)	40	46.60 (-1.27%)	62.30 (-0.16%)	72.30 (-0.28%)	73.90	22.00 (-11.65%)	35.10 (-7.63%)	60.50 (-2.10%)	73.60 (-0.94%)
	+IMPARTAIL (Ours)	10	34.50 (-26.91%)	52.70 (-15.54%)	70.40 (-2.90%)	73.80 (-0.14%)	26.50 (+6.43%)	40.90 (+7.63%)	63.20 (+2.27%)	74.90 (+0.81%)
	SceneSayerSDE [37]	-	52.00	66.20	73.40	74.00	25.00	39.00	62.70	73.70
	+IMPARTAIL (Ours)	70	50.10 (-3.65%)	65.30 (-1.36%)	73.50 (+0.14%)	74.00	31.80 (+27.20%)	46.70 (+19.74%)	67.50 (+7.66%)	75.40 (+2.31%)
	+IMPARTAIL (Ours)	40	51.80 (-0.38%)	66.20	73.40	74.00	27.00 (+8.00%)	40.70 (+4.36%)	63.60 (+1.44%)	74.80 (+1.49%)
	+IMPARTAIL (Ours)	10	44.00 (-15.38%)	61.10 (-7.70%)	73.00 (-0.54%)	74.00	34.60 (+38.40%)	49.00 (+25.64%)	68.50 (+9.25%)	75.30 (+2.17%)

Table 10. GAGS-No Constraint-0.7 results for SGA.

\mathcal{F}	Method	S	NO CONSTRAINT							
			R@10	R@20	R@50	R@100	mR@10	mR@20	mR@50	mR@100
0.7	STTran++ [37]	-	54.70	74.20	83.40	83.80	31.20	47.00	75.40	86.00
	+IMPARTAIL (Ours)	70	60.40 (+10.42%)	76.10 (+2.56%)	83.40	83.80	34.40 (+10.26%)	51.50 (+9.57%)	76.10 (+0.93%)	86.00
	+IMPARTAIL (Ours)	40	56.40 (+3.11%)	73.60 (-0.81%)	83.10 (-0.36%)	83.80	30.70 (-1.60%)	46.50 (-1.06%)	73.30 (-2.79%)	85.90 (-0.12%)
	+IMPARTAIL (Ours)	10	54.40 (-0.55%)	72.60 (-2.16%)	82.90 (-0.60%)	83.80	31.10 (-0.32%)	49.20 (+4.68%)	76.50 (+1.46%)	86.20 (+0.23%)
	DSGDetr++ [37]	-	59.60	76.10	83.40	83.80	28.60	46.10	73.80	85.80
	+IMPARTAIL (Ours)	70	60.20 (+1.01%)	75.80 (-0.39%)	83.40	83.80	32.40 (+13.29%)	49.70 (+7.81%)	76.00 (+2.98%)	86.00 (+0.23%)
	+IMPARTAIL (Ours)	40	59.90 (+0.50%)	75.50 (-0.79%)	83.40	83.80	35.70 (+24.83%)	53.20 (+15.40%)	76.50 (+3.66%)	85.80
	+IMPARTAIL (Ours)	10	50.40 (-15.44%)	70.90 (-6.83%)	82.80 (-0.72%)	83.80	31.40 (+9.79%)	49.70 (+7.81%)	75.70 (+2.57%)	86.10 (+0.35%)
	SceneSayerODE [37]	-	58.50	74.00	82.80	83.80	29.80	45.20	72.00	84.20
	+IMPARTAIL (Ours)	70	56.80 (-2.91%)	74.60 (+0.81%)	83.10 (+0.36%)	83.80	32.70 (+9.73%)	51.10 (+13.05%)	75.30 (+4.58%)	84.90 (+0.83%)
	+IMPARTAIL (Ours)	40	57.90 (-1.03%)	74.00	82.80	83.80	27.40 (-8.05%)	44.60 (-1.33%)	71.80 (-0.28%)	84.10 (-0.12%)
	+IMPARTAIL (Ours)	10	44.90 (-23.25%)	65.10 (-12.03%)	81.50 (-1.57%)	83.80	31.70 (+6.38%)	49.90 (+10.40%)	73.80 (+2.50%)	85.90 (+2.02%)
	SceneSayerSDE [37]	-	61.40	76.20	83.30	83.80	30.20	45.40	72.80	84.00
	+IMPARTAIL (Ours)	70	60.20 (-1.95%)	76.10 (-0.13%)	83.40 (+0.12%)	83.80	37.90 (+25.50%)	55.60 (+22.47%)	77.30 (+6.18%)	86.10 (+2.50%)
	+IMPARTAIL (Ours)	40	61.20 (-0.33%)	76.20	83.20 (-0.12%)	83.80	31.60 (+4.64%)	47.90 (+5.51%)	73.40 (+0.82%)	85.20 (+1.43%)
	+IMPARTAIL (Ours)	10	53.30 (-13.19%)	72.30 (-5.12%)	83.10 (-0.24%)	83.80	40.90 (+35.43%)	58.10 (+27.97%)	78.30 (+7.55%)	86.20 (+2.62%)

Table 11. GAGS-No Constraint-0.9 results for SGA.

\mathcal{F}	Method	S	NO CONSTRAINT							
			R@10	R@20	R@50	R@100	mR@10	mR@20	mR@50	mR@100
0.9	STTran++ [37]	-	68.70	86.80	93.50	93.80	42.50	60.80	84.80	94.90
	+IMPARTAIL (Ours)	70	74.30 (+8.15%)	88.00 (+1.38%)	93.50	93.80	47.50 (+11.76%)	64.70 (+6.41%)	89.00 (+4.95%)	94.90
	+IMPARTAIL (Ours)	40	70.50 (+2.62%)	86.20 (-0.69%)	93.50	93.80	43.00 (+1.18%)	61.00 (+0.33%)	88.50 (+4.36%)	94.70 (-0.21%)
	+IMPARTAIL (Ours)	10	67.50 (-1.75%)	85.20 (-1.84%)	93.40 (-0.11%)	93.80	46.30 (+8.94%)	64.40 (+5.92%)	91.40 (+7.78%)	94.90
	DSGDetr++ [37]	-	73.60	88.30	93.50	93.80	39.00	58.80	83.20	94.90
	+IMPARTAIL (Ours)	70	74.10 (+0.68%)	87.90 (-0.45%)	93.50	93.80	46.30 (+18.72%)	63.50 (+7.99%)	88.90 (+6.85%)	94.90
	+IMPARTAIL (Ours)	40	73.10 (-0.68%)	87.40 (-1.02%)	93.50	93.80	50.00 (+28.21%)	67.60 (+14.97%)	88.80 (+6.73%)	94.70 (-0.21%)
	+IMPARTAIL (Ours)	10	63.90 (-13.18%)	83.90 (-4.98%)	93.30 (-0.21%)	93.80	46.90 (+20.26%)	65.70 (+11.73%)	91.00 (+9.38%)	94.80 (-0.11%)
	SceneSayerODE [37]	-	73.00	87.20	93.30	93.80	37.20	54.30	81.50	94.70
	+IMPARTAIL (Ours)	70	70.50 (-3.42%)	86.40 (-0.92%)	93.30	93.80	40.80 (+9.68%)	57.80 (+6.45%)	84.70 (+3.93%)	94.80 (+0.11%)
	+IMPARTAIL (Ours)	40	72.50 (-0.68%)	86.70 (-0.57%)	93.20 (-0.11%)	93.80	34.40 (-7.53%)	52.10 (-4.05%)	83.60 (+2.58%)	94.40 (-0.32%)
	+IMPARTAIL (Ours)	10	61.60 (-15.62%)	81.40 (-6.65%)	93.00 (-0.32%)	93.80	39.90 (+7.26%)	58.60 (+7.92%)	87.00 (+6.75%)	94.90 (+0.21%)
	SceneSayerSDE [37]	-	73.70	87.30	93.30	93.80	37.30	54.00	80.50	94.70
	+IMPARTAIL (Ours)	70	73.00 (-0.95%)	87.40 (+0.11%)	93.50 (+0.21%)	93.80	45.50 (+21.98%)	63.10 (+16.85%)	89.80 (+11.55%)	94.90 (+0.21%)
	+IMPARTAIL (Ours)	40	73.30 (-0.54%)	87.30	93.40 (+0.11%)	93.80	38.70 (+3.75%)	56.50 (+4.63%)	82.30 (+2.24%)	94.80 (+0.11%)
	+IMPARTAIL (Ours)	10	67.00 (-9.09%)	84.80 (-2.86%)	93.30	93.80	49.00 (+31.37%)	67.30 (+24.63%)	91.40 (+13.54%)	94.90 (+0.21%)

12.2.3. Results - No Constraint Setting - Partially Grounded Action Genome Scenes (PGAGS)

Table 12. PGAGS-No Constraint-0.3 results for SGA.

\mathcal{F}	Method	\mathcal{S}	NO CONSTRAINT							
			R@10	R@20	R@50	R@100	mR@10	mR@20	mR@50	mR@100
0.3	STTran++ [37]	-	31.00	42.30	46.60	46.80	18.50	28.70	48.80	52.50
	+IMPARTAIL (Ours)	70	33.20 (+7.10%)	41.30 (-2.36%)	46.60	47.00 (+0.43%)	16.60 (-10.27%)	27.20 (-5.23%)	49.30 (+1.02%)	52.80 (+0.57%)
	+IMPARTAIL (Ours)	40	34.00 (+9.68%)	42.50 (+0.47%)	46.70 (+0.21%)	47.00 (+0.43%)	19.70 (+6.49%)	29.60 (+3.14%)	49.60 (+1.64%)	52.80 (+0.57%)
	+IMPARTAIL (Ours)	10	29.40 (-5.16%)	40.20 (-4.96%)	45.80 (-1.72%)	46.20 (-1.28%)	21.20 (+14.59%)	31.50 (+9.76%)	49.20 (+0.82%)	52.40 (-0.19%)
	DSGDetr++ [37]	-	35.60	44.00	48.20	48.50	17.90	28.60	49.20	53.80
	+IMPARTAIL (Ours)	70	34.40 (-3.37%)	43.50 (-1.14%)	48.20	48.50	21.10 (+17.88%)	30.50 (+6.64%)	49.70 (+1.02%)	53.80
	+IMPARTAIL (Ours)	40	32.20 (-9.55%)	41.80 (-5.00%)	47.50 (-1.45%)	47.80 (-1.44%)	18.10 (+1.12%)	28.40 (-0.70%)	49.00 (-0.41%)	52.80 (-1.86%)
	+IMPARTAIL (Ours)	10	32.20 (-9.55%)	42.00 (-4.55%)	47.70 (-1.04%)	48.00 (-1.03%)	21.00 (+17.32%)	31.60 (+10.49%)	50.80 (+3.25%)	53.50 (-0.56%)
	SceneSayerODE [37]	-	30.00	39.80	46.90	48.10	14.30	23.30	44.60	53.50
	+IMPARTAIL (Ours)	70	25.20 (-16.00%)	35.70 (-10.30%)	45.20 (-3.62%)	47.30 (-1.66%)	16.90 (+18.18%)	25.70 (+10.30%)	45.60 (+2.24%)	52.60 (-1.68%)
	+IMPARTAIL (Ours)	40	34.80 (+16.00%)	42.40 (+6.53%)	47.00 (+0.21%)	47.70 (-0.83%)	20.40 (+42.66%)	29.90 (+28.33%)	47.30 (+6.05%)	53.40 (-0.19%)
	+IMPARTAIL (Ours)	10	27.70 (-7.67%)	37.20 (-6.53%)	46.10 (-1.71%)	48.20 (+0.21%)	21.90 (+53.15%)	31.40 (+34.76%)	49.30 (+10.54%)	53.70 (+0.37%)
	SceneSayerSDE [37]	-	35.90	43.70	47.80	48.40	20.60	31.20	49.80	55.00
	+IMPARTAIL (Ours)	70	34.80 (-3.06%)	42.80 (-2.06%)	47.10 (-1.46%)	48.00 (-0.83%)	24.30 (+17.96%)	34.50 (+10.58%)	50.80 (+2.01%)	54.20 (-1.45%)
	+IMPARTAIL (Ours)	40	35.50 (-1.11%)	43.20 (-1.14%)	47.60 (-0.42%)	48.20 (-0.41%)	21.50 (+4.37%)	32.10 (+2.88%)	49.10 (-1.41%)	54.40 (-1.09%)
	+IMPARTAIL (Ours)	10	33.30 (-7.24%)	41.90 (-4.12%)	47.00 (-1.67%)	47.90 (-1.03%)	27.50 (+33.50%)	37.70 (+20.83%)	52.60 (+5.62%)	54.50 (-0.91%)

Table 13. PGAGS-No Constraint-0.5 results for SGA.

\mathcal{F}	Method	\mathcal{S}	NO CONSTRAINT							
			R@10	R@20	R@50	R@100	mR@10	mR@20	mR@50	mR@100
0.5	STTran++ [37]	-	34.30	46.70	51.50	51.60	20.90	32.50	50.10	53.20
	+IMPARTAIL (Ours)	70	36.60 (+6.71%)	45.70 (-2.14%)	51.10 (-0.78%)	51.50 (-0.19%)	18.70 (-10.53%)	30.70 (-5.54%)	49.40 (-1.40%)	52.70 (-0.94%)
	+IMPARTAIL (Ours)	40	37.30 (+8.75%)	46.90 (+0.43%)	51.10 (-0.78%)	51.30 (-0.58%)	21.90 (+4.78%)	33.20 (+2.15%)	50.00 (-0.20%)	52.30 (-1.69%)
	+IMPARTAIL (Ours)	10	32.50 (-5.25%)	44.10 (-5.57%)	50.40 (-2.14%)	50.80 (-1.55%)	24.00 (+14.83%)	34.90 (+7.38%)	50.50 (+0.80%)	52.70 (-0.94%)
	DSGDetr++ [37]	-	39.60	49.60	54.30	54.50	19.90	32.30	50.60	55.80
	+IMPARTAIL (Ours)	70	37.40 (-5.56%)	48.30 (-2.62%)	53.70 (-1.10%)	54.00 (-0.92%)	23.10 (+16.08%)	33.60 (+4.02%)	50.50 (-0.20%)	55.30 (-0.90%)
	+IMPARTAIL (Ours)	40	36.30 (-8.33%)	47.10 (-5.04%)	53.00 (-2.39%)	53.30 (-2.20%)	20.50 (+3.02%)	31.60 (-2.17%)	50.00 (-1.19%)	55.00 (-1.43%)
	+IMPARTAIL (Ours)	10	35.50 (-10.35%)	47.30 (-4.64%)	54.10 (-0.37%)	54.50	22.60 (+13.57%)	35.20 (+8.98%)	52.50 (+3.75%)	56.70 (+1.61%)
	SceneSayerODE [37]	-	34.10	45.10	52.80	54.10	16.90	26.30	45.70	54.00
	+IMPARTAIL (Ours)	70	29.00 (-14.96%)	41.40 (-8.20%)	51.90 (-1.70%)	54.10	19.70 (+16.57%)	29.70 (+12.93%)	47.40 (+3.72%)	54.40 (+0.74%)
	+IMPARTAIL (Ours)	40	39.10 (+14.66%)	48.00 (+6.43%)	53.40 (+1.14%)	54.20 (+0.18%)	22.70 (+34.32%)	33.60 (+27.76%)	49.70 (+8.75%)	55.60 (+2.96%)
	+IMPARTAIL (Ours)	10	32.10 (-5.87%)	42.90 (-4.88%)	52.20 (-1.14%)	54.10	25.00 (+47.93%)	36.00 (+36.88%)	50.40 (+10.28%)	55.40 (+2.59%)
	SceneSayerSDE [37]	-	39.90	48.90	53.70	54.50	22.90	34.30	51.00	56.20
	+IMPARTAIL (Ours)	70	38.70 (-3.01%)	47.90 (-2.04%)	53.30 (-0.74%)	54.00 (-0.92%)	26.90 (+17.47%)	37.70 (+9.91%)	52.70 (+3.33%)	56.70 (+0.89%)
	+IMPARTAIL (Ours)	40	39.70 (-0.50%)	48.40 (-1.02%)	53.50 (-0.37%)	54.20 (-0.55%)	23.60 (+3.06%)	34.30	50.60 (-0.78%)	56.00 (-0.36%)
	+IMPARTAIL (Ours)	10	37.00 (-7.27%)	46.80 (-4.29%)	52.80 (-1.68%)	53.90 (-1.10%)	30.30 (+32.31%)	40.90 (+19.24%)	52.30 (+2.55%)	55.00 (-2.14%)

Table 14. PGAGS-No Constraint-0.7 results for SGA.

\mathcal{F}	Method	S	NO CONSTRAINT							
			R@10	R@20	R@50	R@100	mR@10	mR@20	mR@50	mR@100
0.7	STTran++ [37]	-	41.40	54.90	59.60	59.70	25.30	38.30	56.10	58.40
	+IMPARTAIL (Ours)	70	44.80 (+8.21%)	54.40 (-0.91%)	59.30 (-0.50%)	59.50 (-0.34%)	24.40 (-3.56%)	38.70 (+1.04%)	56.40 (+0.53%)	59.90 (+2.57%)
	+IMPARTAIL (Ours)	40	45.50 (+9.90%)	55.50 (+1.09%)	59.60	59.70	28.00 (+10.67%)	41.70 (+8.88%)	57.10 (+1.78%)	59.30 (+1.54%)
	+IMPARTAIL (Ours)	10	39.60 (-4.35%)	53.00 (-3.46%)	59.10 (-0.84%)	59.50 (-0.34%)	29.80 (+17.79%)	43.90 (+14.62%)	57.60 (+2.67%)	59.40 (+1.71%)
	DSGDetr++ [37]	-	47.70	58.10	62.40	62.60	24.80	39.50	57.30	61.10
	+IMPARTAIL (Ours)	70	45.40 (-4.82%)	57.30 (-1.38%)	62.10 (-0.48%)	62.20 (-0.64%)	28.70 (+15.73%)	40.90 (+3.54%)	57.60 (+0.52%)	60.80 (-0.49%)
	+IMPARTAIL (Ours)	40	44.30 (-7.13%)	55.90 (-3.79%)	61.20 (-1.92%)	61.40 (-1.92%)	26.30 (+6.05%)	41.00 (+3.80%)	58.10 (+1.40%)	61.90 (+1.31%)
	+IMPARTAIL (Ours)	10	42.80 (-10.27%)	55.60 (-4.30%)	62.00 (-0.64%)	62.30 (-0.48%)	28.10 (+13.31%)	42.20 (+6.84%)	58.50 (+2.09%)	61.80 (+1.15%)
	SceneSayerODE [37]	-	40.90	53.00	60.40	61.60	20.50	32.40	52.80	60.10
	+IMPARTAIL (Ours)	70	35.30 (-13.69%)	49.00 (-7.55%)	59.40 (-1.66%)	61.30 (-0.49%)	23.40 (+14.15%)	36.10 (+11.42%)	52.70 (-0.19%)	59.60 (-0.83%)
	+IMPARTAIL (Ours)	40	46.00 (+12.47%)	56.00 (+5.66%)	61.20 (+1.32%)	61.90 (+0.49%)	27.10 (+32.20%)	40.00 (+23.46%)	56.40 (+6.82%)	61.20 (+1.83%)
	+IMPARTAIL (Ours)	10	40.40 (-1.22%)	52.20 (-1.51%)	60.60 (+0.33%)	62.00 (+0.65%)	30.70 (+49.76%)	43.90 (+35.49%)	55.90 (+5.87%)	60.20 (+0.17%)
	SceneSayerSDE [37]	-	47.40	57.00	61.90	62.50	27.00	40.20	57.20	61.70
	+IMPARTAIL (Ours)	70	46.50 (-1.90%)	56.10 (-1.58%)	61.30 (-0.97%)	62.10 (-0.64%)	32.10 (+18.89%)	45.20 (+12.44%)	60.40 (+5.59%)	63.50 (+2.92%)
	+IMPARTAIL (Ours)	40	47.30 (-0.21%)	56.90 (-0.18%)	62.00 (+0.16%)	62.60 (+0.16%)	28.40 (+5.19%)	40.50 (+0.75%)	57.90 (+1.22%)	63.50 (+2.92%)
	+IMPARTAIL (Ours)	10	44.30 (-6.54%)	55.20 (-3.16%)	61.00 (-1.45%)	62.00 (-0.80%)	35.50 (+31.48%)	48.20 (+19.90%)	58.50 (+2.27%)	61.20 (-0.81%)

Table 15. PGAGS-No Constraint-0.9 results for SGA.

\mathcal{F}	Method	S	NO CONSTRAINT							
			R@10	R@20	R@50	R@100	mR@10	mR@20	mR@50	mR@100
0.9	STTran++ [37]	-	50.00	61.60	64.40	64.50	32.40	46.90	60.60	62.60
	+IMPARTAIL (Ours)	70	54.00 (+8.00%)	62.30 (+1.14%)	65.00 (+0.93%)	65.00 (+0.78%)	35.10 (+8.33%)	48.70 (+3.84%)	61.40 (+1.32%)	63.10 (+0.80%)
	+IMPARTAIL (Ours)	40	53.30 (+6.60%)	62.20 (+0.97%)	65.00 (+0.93%)	65.10 (+0.93%)	36.80 (+13.58%)	49.60 (+5.76%)	62.10 (+2.48%)	63.40 (+1.28%)
	+IMPARTAIL (Ours)	10	48.20 (-3.60%)	60.50 (-1.79%)	64.90 (+0.78%)	65.10 (+0.93%)	40.90 (+26.23%)	52.10 (+11.09%)	63.80 (+5.28%)	64.60 (+3.19%)
	DSGDetr++ [37]	-	57.10	66.40	69.40	69.50	33.00	49.00	64.20	68.20
	+IMPARTAIL (Ours)	70	54.90 (-3.85%)	65.40 (-1.51%)	68.80 (-0.86%)	68.90 (-0.86%)	35.90 (+8.79%)	49.40 (+0.82%)	63.90 (-0.47%)	67.50 (-1.03%)
	+IMPARTAIL (Ours)	40	54.30 (-4.90%)	65.00 (-2.11%)	68.60 (-1.15%)	68.80 (-1.01%)	35.70 (+8.18%)	51.50 (+5.10%)	65.70 (+2.34%)	69.30 (+1.61%)
	+IMPARTAIL (Ours)	10	52.60 (-7.88%)	64.30 (-3.16%)	69.00 (-0.58%)	69.20 (-0.43%)	38.30 (+16.06%)	52.60 (+7.35%)	67.30 (+4.83%)	69.20 (+1.47%)
	SceneSayerODE [37]	-	50.60	62.00	68.50	69.70	27.40	41.70	61.10	69.30
	+IMPARTAIL (Ours)	70	44.80 (-11.46%)	58.50 (-5.65%)	68.30 (-0.29%)	70.00 (+0.43%)	29.90 (+9.12%)	42.60 (+2.16%)	60.80 (-0.49%)	68.50 (-1.15%)
	+IMPARTAIL (Ours)	40	54.70 (+8.10%)	64.30 (+3.71%)	68.80 (+0.44%)	69.50 (-0.29%)	32.90 (+20.07%)	46.60 (+11.75%)	62.00 (+1.47%)	69.10 (-0.29%)
	+IMPARTAIL (Ours)	10	51.20 (+1.19%)	63.00 (+1.61%)	69.20 (+1.02%)	70.30 (+0.86%)	37.80 (+37.96%)	52.90 (+26.86%)	65.20 (+6.71%)	69.60 (+0.43%)
	SceneSayerSDE [37]	-	56.30	65.70	69.50	70.00	33.20	48.20	64.30	69.50
	+IMPARTAIL (Ours)	70	55.20 (-1.95%)	65.00 (-1.07%)	69.20 (-0.43%)	69.90 (-0.14%)	38.10 (+14.76%)	51.50 (+6.85%)	65.70 (+2.18%)	69.10 (-0.58%)
	+IMPARTAIL (Ours)	40	56.30	65.70	69.90 (+0.58%)	70.60 (+0.86%)	34.10 (+2.71%)	48.10 (-0.21%)	65.70 (+2.18%)	71.80 (+3.31%)
	+IMPARTAIL (Ours)	10	53.70 (-4.62%)	64.20 (-2.28%)	69.10 (-0.58%)	70.20 (+0.29%)	42.00 (+26.51%)	54.50 (+13.07%)	66.40 (+3.27%)	69.30 (-0.29%)

12.2.4. Results - No Constraint Setting - Action Genome Scenes (AGS)

Table 16. AGS-No Constraint-0.3 results for SGA.

\mathcal{F}	Method	\mathcal{S}	NO CONSTRAINT							
			R@10	R@20	R@50	R@100	mR@10	mR@20	mR@50	mR@100
0.3	STTran++ [37]	-	22.90	36.00	51.30	55.20	13.10	20.20	36.20	49.90
	+IMPARTAIL (Ours)	70	22.70 (-0.87%)	35.80 (-0.56%)	50.50 (-1.56%)	55.20	12.20 (-6.87%)	19.00 (-5.94%)	35.70 (-1.38%)	50.30 (+0.80%)
	+IMPARTAIL (Ours)	40	22.10 (-3.49%)	35.50 (-1.39%)	50.50 (-1.56%)	55.00 (-0.36%)	12.80 (-2.29%)	21.10 (+4.46%)	37.50 (+3.59%)	51.10 (+2.40%)
	+IMPARTAIL (Ours)	10	19.50 (-14.85%)	30.40 (-15.56%)	48.50 (-5.46%)	54.90 (-0.54%)	11.10 (-15.27%)	18.50 (-8.42%)	36.50 (+0.83%)	51.10 (+2.40%)
	DSGDetr++ [37]	-	20.80	33.10	49.20	53.90	11.50	17.80	34.10	49.10
	+IMPARTAIL (Ours)	70	21.30 (+2.40%)	33.60 (+1.51%)	49.00 (-0.41%)	54.30 (+0.74%)	12.40 (+7.83%)	19.30 (+8.43%)	34.90 (+2.35%)	48.90 (-0.41%)
	+IMPARTAIL (Ours)	40	18.40 (-11.54%)	29.70 (-10.27%)	47.30 (-3.86%)	53.80 (-0.19%)	12.50 (+8.70%)	20.60 (+15.73%)	36.50 (+7.04%)	49.20 (+0.20%)
	+IMPARTAIL (Ours)	10	18.90 (-9.13%)	29.90 (-9.67%)	47.10 (-4.27%)	53.10 (-1.48%)	12.80 (+11.30%)	21.80 (+22.47%)	37.50 (+9.97%)	49.70 (+1.22%)
	SceneSayerODE [37]	-	22.60	31.60	44.50	51.70	12.60	19.30	32.70	44.30
	+IMPARTAIL (Ours)	70	20.50 (-9.29%)	29.50 (-6.65%)	42.50 (-4.49%)	49.90 (-3.48%)	13.40 (+6.35%)	20.40 (+5.70%)	33.90 (+3.67%)	45.00 (+1.58%)
	+IMPARTAIL (Ours)	40	26.70 (+18.14%)	36.10 (+14.24%)	47.40 (+6.52%)	52.60 (+1.74%)	14.30 (+13.49%)	21.50 (+11.40%)	35.50 (+8.56%)	45.80 (+3.39%)
	+IMPARTAIL (Ours)	10	22.60	32.10 (+1.58%)	45.20 (+1.57%)	52.20 (+0.97%)	14.20 (+12.70%)	22.60 (+17.10%)	37.50 (+14.68%)	47.50 (+7.22%)
	SceneSayerSDE [37]	-	26.30	35.70	47.20	52.40	14.30	22.00	36.40	46.80
	+IMPARTAIL (Ours)	70	25.90 (-1.52%)	35.30 (-1.12%)	47.20	52.90 (+0.95%)	17.50 (+22.38%)	26.60 (+20.91%)	40.80 (+12.09%)	50.70 (+8.33%)
	+IMPARTAIL (Ours)	40	26.50 (+0.76%)	35.50 (-0.56%)	47.20	52.40	15.30 (+6.99%)	22.90 (+4.09%)	37.10 (+1.92%)	47.60 (+1.71%)
	+IMPARTAIL (Ours)	10	22.80 (-13.31%)	32.20 (-9.80%)	44.60 (-5.51%)	51.20 (-2.29%)	20.20 (+41.26%)	29.30 (+33.18%)	43.30 (+18.96%)	51.30 (+9.62%)

Table 17. AGS-No Constraint-0.5 results for SGA.

\mathcal{F}	Method	\mathcal{S}	NO CONSTRAINT							
			R@10	R@20	R@50	R@100	mR@10	mR@20	mR@50	mR@100
0.5	STTran++ [37]	-	24.60	38.40	54.50	58.60	13.90	21.30	38.50	52.50
	+IMPARTAIL (Ours)	70	24.00 (-2.44%)	38.10 (-0.78%)	54.00 (-0.92%)	58.60	12.60 (-9.35%)	19.90 (-6.57%)	37.90 (-1.56%)	53.40 (+1.71%)
	+IMPARTAIL (Ours)	40	23.10 (-6.10%)	37.60 (-2.08%)	53.60 (-1.65%)	58.50 (-0.17%)	12.90 (-7.19%)	21.30	39.00 (+1.30%)	53.90 (+2.67%)
	+IMPARTAIL (Ours)	10	21.00 (-14.63%)	33.10 (-13.80%)	51.90 (-4.77%)	58.40 (-0.34%)	12.10 (-12.95%)	20.00 (-6.10%)	39.60 (+2.86%)	54.30 (+3.43%)
	DSGDetr++ [37]	-	21.90	34.70	52.10	57.30	11.80	18.20	36.10	52.70
	+IMPARTAIL (Ours)	70	22.80 (+4.11%)	36.10 (+4.03%)	52.90 (+1.54%)	58.30 (+1.75%)	13.10 (+11.02%)	20.60 (+13.19%)	37.80 (+4.71%)	55.60 (+5.50%)
	+IMPARTAIL (Ours)	40	20.00 (-8.68%)	32.30 (-6.92%)	51.30 (-1.54%)	57.50 (+0.35%)	13.10 (+11.02%)	21.60 (+18.68%)	39.60 (+9.70%)	56.40 (+7.02%)
	+IMPARTAIL (Ours)	10	20.00 (-8.68%)	32.10 (-7.49%)	50.50 (-3.07%)	56.70 (-1.05%)	13.50 (+14.41%)	22.90 (+25.82%)	40.70 (+12.74%)	52.60 (-0.19%)
	SceneSayerODE [37]	-	25.80	35.80	48.90	55.00	14.00	22.30	36.50	49.00
	+IMPARTAIL (Ours)	70	23.40 (-9.30%)	33.50 (-6.42%)	47.00 (-3.89%)	54.20 (-1.45%)	14.90 (+6.43%)	23.20 (+4.04%)	37.30 (+2.19%)	48.40 (-1.22%)
	+IMPARTAIL (Ours)	40	29.40 (+13.95%)	39.50 (+10.34%)	51.40 (+5.11%)	56.10 (+2.00%)	15.30 (+9.29%)	22.90 (+2.69%)	37.90 (+3.84%)	49.00
	+IMPARTAIL (Ours)	10	24.90 (-3.49%)	34.90 (-2.51%)	48.60 (-0.61%)	55.60 (+1.09%)	15.60 (+11.43%)	24.80 (+11.21%)	39.70 (+8.77%)	50.50 (+3.06%)
	SceneSayerSDE [37]	-	29.00	39.10	51.50	56.70	15.40	23.70	38.70	50.80
	+IMPARTAIL (Ours)	70	28.10 (-3.10%)	38.20 (-2.30%)	50.90 (-1.17%)	56.40 (-0.53%)	18.20 (+18.18%)	27.10 (+14.35%)	42.80 (+10.59%)	52.80 (+3.94%)
	+IMPARTAIL (Ours)	40	29.20 (+0.69%)	39.30 (+0.51%)	51.80 (+0.58%)	56.60 (-0.18%)	16.50 (+7.14%)	25.10 (+5.91%)	40.10 (+3.62%)	50.60 (-0.39%)
	+IMPARTAIL (Ours)	10	25.10 (-13.45%)	35.70 (-8.70%)	48.50 (-5.83%)	54.90 (-3.17%)	21.80 (+41.56%)	31.40 (+32.49%)	45.40 (+17.31%)	53.80 (+5.91%)

Table 18. AGS-No Constraint-0.7 results for SGA.

\mathcal{F}	Method	\mathcal{S}	NO CONSTRAINT							
			R@10	R@20	R@50	R@100	mR@10	mR@20	mR@50	mR@100
0.7	STTran++ [37]	-	27.20	42.10	59.70	63.90	15.70	23.70	41.90	57.50
	+IMPARTAIL (Ours)	70	26.80 (-1.47%)	43.00 (+2.14%)	59.70	63.90	14.90 (-5.10%)	23.90 (+0.84%)	42.60 (+1.67%)	58.30 (+1.39%)
	+IMPARTAIL (Ours)	40	25.80 (-5.15%)	41.80 (-0.71%)	59.30 (-0.67%)	63.80 (-0.16%)	14.90 (-5.10%)	24.70 (+4.22%)	44.00 (+5.01%)	58.90 (+2.43%)
	+IMPARTAIL (Ours)	10	23.60 (-13.24%)	36.50 (-13.30%)	57.00 (-4.52%)	63.50 (-0.63%)	14.00 (-10.83%)	23.20 (-2.11%)	43.70 (+4.30%)	59.60 (+3.65%)
	DSGDetr++ [37]	-	24.90	38.20	56.90	62.00	13.20	20.00	38.80	56.50
	+IMPARTAIL (Ours)	70	24.80 (-0.40%)	40.00 (+4.71%)	57.80 (+1.58%)	63.20 (+1.94%)	14.40 (+9.09%)	23.20 (+16.00%)	41.30 (+6.44%)	56.90 (+0.71%)
	+IMPARTAIL (Ours)	40	22.50 (-9.64%)	36.70 (-3.93%)	56.30 (-1.05%)	61.70 (-0.48%)	14.90 (+12.88%)	24.80 (+24.00%)	43.90 (+13.14%)	57.20 (+1.24%)
	+IMPARTAIL (Ours)	10	22.20 (-10.84%)	35.70 (-6.54%)	56.00 (-1.58%)	62.10 (+0.16%)	15.90 (+20.45%)	26.70 (+33.50%)	45.30 (+16.75%)	57.90 (+2.48%)
	SceneSayerODE [37]	-	31.70	42.10	55.10	60.50	16.40	24.90	40.50	53.00
	+IMPARTAIL (Ours)	70	28.90 (-8.83%)	39.50 (-6.18%)	53.30 (-3.27%)	59.90 (-0.99%)	17.80 (+8.54%)	27.00 (+8.43%)	41.60 (+2.72%)	53.40 (+0.75%)
	+IMPARTAIL (Ours)	40	34.00 (+7.26%)	44.30 (+5.23%)	56.00 (+1.63%)	60.60 (+0.17%)	17.50 (+6.71%)	25.80 (+3.61%)	41.10 (+1.48%)	52.60 (-0.75%)
	+IMPARTAIL (Ours)	10	29.20 (-7.89%)	40.00 (-4.99%)	53.40 (-3.09%)	60.00 (-0.83%)	18.90 (+15.24%)	29.40 (+18.07%)	43.80 (+8.15%)	53.90 (+1.70%)
	SceneSayerSDE [37]	-	33.80	43.90	56.40	61.10	17.30	26.10	42.50	54.00
	+IMPARTAIL (Ours)	70	33.40 (-1.18%)	43.70 (-0.46%)	56.00 (-0.71%)	61.10	21.10 (+21.97%)	31.40 (+20.31%)	46.80 (+10.12%)	57.20 (+5.93%)
	+IMPARTAIL (Ours)	40	34.20 (+1.18%)	44.40 (+1.14%)	56.80 (+0.71%)	61.40 (+0.49%)	19.00 (+9.83%)	27.80 (+6.51%)	43.60 (+2.59%)	54.40 (+0.74%)
	+IMPARTAIL (Ours)	10	30.00 (-11.24%)	41.20 (-6.15%)	54.20 (-3.90%)	60.30 (-1.31%)	25.60 (+47.98%)	35.10 (+34.48%)	50.00 (+17.65%)	58.00 (+7.41%)

Table 19. AGS-No Constraint-0.9 results for SGA.

\mathcal{F}	Method	\mathcal{S}	NO CONSTRAINT							
			R@10	R@20	R@50	R@100	mR@10	mR@20	mR@50	mR@100
0.9	STTran++ [37]	-	30.20	45.80	64.40	68.40	18.20	27.50	47.20	62.80
	+IMPARTAIL (Ours)	70	30.10 (-0.33%)	47.80 (+4.37%)	64.50 (+0.16%)	68.40	19.50 (+7.14%)	29.60 (+7.64%)	50.00 (+5.93%)	64.00 (+1.91%)
	+IMPARTAIL (Ours)	40	29.30 (-2.98%)	47.10 (+2.84%)	64.50 (+0.16%)	68.30 (-0.15%)	20.50 (+12.64%)	31.80 (+15.64%)	51.90 (+9.96%)	63.80 (+1.59%)
	+IMPARTAIL (Ours)	10	26.30 (-12.91%)	40.70 (-11.14%)	60.90 (-5.43%)	68.00 (-0.58%)	18.80 (+3.30%)	30.40 (+10.55%)	51.40 (+8.90%)	64.80 (+3.18%)
	DSGDetr++ [37]	-	28.70	43.40	62.70	67.10	15.50	23.80	44.90	61.70
	+IMPARTAIL (Ours)	70	27.90 (-2.79%)	45.10 (+3.92%)	63.90 (+1.91%)	68.40 (+1.94%)	18.50 (+19.35%)	28.70 (+20.59%)	48.50 (+8.02%)	62.00 (+0.49%)
	+IMPARTAIL (Ours)	40	27.40 (-4.53%)	43.80 (+0.92%)	62.90 (+0.32%)	67.40 (+0.45%)	20.50 (+32.26%)	32.30 (+35.71%)	52.40 (+16.70%)	63.00 (+2.11%)
	+IMPARTAIL (Ours)	10	26.20 (-8.71%)	40.60 (-6.45%)	61.40 (-2.07%)	67.60 (+0.75%)	21.20 (+36.77%)	32.10 (+34.87%)	51.20 (+14.03%)	61.70
	SceneSayerODE [37]	-	37.80	49.10	61.40	66.20	18.90	28.60	45.20	58.40
	+IMPARTAIL (Ours)	70	35.60 (-5.82%)	47.00 (-4.28%)	60.00 (-2.28%)	65.20 (-1.51%)	21.20 (+12.17%)	31.80 (+11.19%)	48.20 (+6.64%)	58.20 (-0.34%)
	+IMPARTAIL (Ours)	40	39.30 (+3.97%)	50.10 (+2.04%)	61.60 (+0.33%)	66.10 (-0.15%)	20.10 (+6.35%)	29.60 (+3.50%)	45.60 (+0.88%)	57.80 (-1.03%)
	+IMPARTAIL (Ours)	10	34.20 (-9.52%)	46.00 (-6.31%)	59.20 (-3.58%)	65.30 (-1.36%)	23.10 (+22.22%)	33.90 (+18.53%)	49.50 (+9.51%)	58.00 (-0.68%)
	SceneSayerSDE [37]	-	38.50	49.90	61.90	66.50	19.10	29.00	45.60	59.40
	+IMPARTAIL (Ours)	70	39.30 (+2.08%)	50.60 (+1.40%)	61.90	66.40 (-0.15%)	24.80 (+29.84%)	36.30 (+25.17%)	51.30 (+12.50%)	60.00 (+1.01%)
	+IMPARTAIL (Ours)	40	40.20 (+4.42%)	50.80 (+1.80%)	62.00 (+0.16%)	66.70 (+0.30%)	21.80 (+14.14%)	31.40 (+8.28%)	47.60 (+4.39%)	58.70 (-1.18%)
	+IMPARTAIL (Ours)	10	35.50 (-7.79%)	47.20 (-5.41%)	60.70 (-1.94%)	66.00 (-0.75%)	29.30 (+53.40%)	39.40 (+35.86%)	53.00 (+16.23%)	63.60 (+7.07%)

12.2.5. Results - With Constraint Setting - Grounded Action Genome Scenes (GAGS)

Table 20. GAGS-With Constraint-0.3 results for SGA.

\mathcal{F}	Method	\mathcal{S}	WITH CONSTRAINT							
			R@10	R@20	R@50	R@100	mR@10	mR@20	mR@50	mR@100
0.3	STTran++ [37]	-	26.50	29.50	29.60	29.60	15.90	18.50	18.60	18.60
	+IMPARTAIL (Ours)	70	36.60 (+38.11%)	39.70 (+34.58%)	39.80 (+34.46%)	39.80 (+34.46%)	18.70 (+17.61%)	21.40 (+15.68%)	21.40 (+15.05%)	21.40 (+15.05%)
	+IMPARTAIL (Ours)	40	32.60 (+23.02%)	35.60 (+20.68%)	35.60 (+20.27%)	35.60 (+20.27%)	17.00 (+6.92%)	19.40 (+4.86%)	19.40 (+4.30%)	19.40 (+4.30%)
	+IMPARTAIL (Ours)	10	33.30 (+25.66%)	35.80 (+21.36%)	35.80 (+20.95%)	35.80 (+20.95%)	17.80 (+11.95%)	20.40 (+10.27%)	20.40 (+9.68%)	20.40 (+9.68%)
	DSGDetr++ [37]	-	36.20	39.30	39.30	39.30	15.10	17.50	17.50	17.50
	+IMPARTAIL (Ours)	70	37.00 (+2.21%)	40.20 (+2.29%)	40.30 (+2.54%)	40.30 (+2.54%)	17.20 (+13.91%)	19.90 (+13.71%)	20.00 (+14.29%)	20.00 (+14.29%)
	+IMPARTAIL (Ours)	40	36.40 (+0.55%)	39.40 (+0.25%)	39.40 (+0.25%)	39.40 (+0.25%)	18.90 (+25.17%)	22.00 (+25.71%)	22.00 (+25.71%)	22.00 (+25.71%)
	+IMPARTAIL (Ours)	10	30.90 (-14.64%)	33.20 (-15.52%)	33.20 (-15.52%)	33.20 (-15.52%)	17.10 (+13.25%)	19.70 (+12.57%)	19.70 (+12.57%)	19.70 (+12.57%)
	SceneSayerODE [37]	-	34.60	37.30	37.30	37.30	15.20	17.90	18.00	18.00
	+IMPARTAIL (Ours)	70	33.20 (-4.05%)	36.00 (-3.49%)	36.00 (-3.49%)	36.00 (-3.49%)	17.40 (+14.47%)	21.10 (+17.88%)	21.20 (+17.78%)	21.20 (+17.78%)
	+IMPARTAIL (Ours)	40	33.70 (-2.60%)	36.40 (-2.41%)	36.40 (-2.41%)	36.40 (-2.41%)	13.30 (-12.50%)	15.90 (-11.17%)	15.90 (-11.67%)	15.90 (-11.67%)
	+IMPARTAIL (Ours)	10	23.10 (-33.24%)	24.70 (-33.78%)	24.70 (-33.78%)	24.70 (-33.78%)	16.50 (+8.55%)	19.80 (+10.61%)	19.90 (+10.56%)	19.90 (+10.56%)
SceneSayerSDE [37]	-	38.30	41.70	41.70	41.70	16.10	19.20	19.30	19.30	
+IMPARTAIL (Ours)	70	36.40 (-4.96%)	39.70 (-4.80%)	39.80 (-4.56%)	39.80 (-4.56%)	20.30 (+26.09%)	24.60 (+28.12%)	24.70 (+27.98%)	24.70 (+27.98%)	
+IMPARTAIL (Ours)	40	38.60 (+0.78%)	42.00 (+0.72%)	42.00 (+0.72%)	42.00 (+0.72%)	16.10	19.20	19.20 (-0.52%)	19.20 (-0.52%)	
+IMPARTAIL (Ours)	10	30.60 (-20.10%)	33.00 (-20.86%)	33.00 (-20.86%)	33.00 (-20.86%)	24.50 (+52.17%)	29.90 (+55.73%)	30.00 (+55.44%)	30.00 (+55.44%)	

Table 21. GAGS-With Constraint-0.5 results for SGA.

\mathcal{F}	Method	\mathcal{S}	WITH CONSTRAINT							
			R@10	R@20	R@50	R@100	mR@10	mR@20	mR@50	mR@100
0.5	STTran++ [37]	-	30.90	34.20	34.20	34.20	17.80	20.90	21.00	21.00
	+IMPARTAIL (Ours)	70	41.70 (+34.95%)	45.00 (+31.58%)	45.10 (+31.87%)	45.10 (+31.87%)	21.30 (+19.66%)	24.80 (+18.66%)	24.80 (+18.10%)	24.80 (+18.10%)
	+IMPARTAIL (Ours)	40	36.70 (+18.77%)	40.00 (+16.96%)	40.00 (+16.96%)	40.00 (+16.96%)	19.10 (+7.30%)	22.10 (+5.74%)	22.10 (+5.24%)	22.10 (+5.24%)
	+IMPARTAIL (Ours)	10	37.50 (+21.36%)	40.20 (+17.54%)	40.20 (+17.54%)	40.20 (+17.54%)	19.90 (+11.80%)	22.70 (+8.61%)	22.80 (+8.57%)	22.80 (+8.57%)
	DSGDetr++ [37]	-	41.20	44.60	44.70	44.70	17.10	20.00	20.00	20.00
	+IMPARTAIL (Ours)	70	41.90 (+1.70%)	45.40 (+1.79%)	45.40 (+1.57%)	45.40 (+1.57%)	19.90 (+16.37%)	23.10 (+15.50%)	23.10 (+15.50%)	23.10 (+15.50%)
	+IMPARTAIL (Ours)	40	41.20	44.50 (-0.22%)	44.50 (-0.45%)	44.50 (-0.45%)	21.20 (+23.98%)	24.50 (+22.50%)	24.60 (+23.00%)	24.60 (+23.00%)
	+IMPARTAIL (Ours)	10	34.70 (-15.78%)	37.40 (-16.14%)	37.40 (-16.33%)	37.40 (-16.33%)	21.10 (+23.39%)	24.50 (+22.50%)	24.50 (+22.50%)	24.50 (+22.50%)
	SceneSayerODE [37]	-	40.30	43.50	43.50	43.50	17.50	20.70	20.90	20.90
	+IMPARTAIL (Ours)	70	38.00 (-5.71%)	41.10 (-5.52%)	41.10 (-5.52%)	41.10 (-5.52%)	19.50 (+11.43%)	23.70 (+14.49%)	23.90 (+14.35%)	23.90 (+14.35%)
	+IMPARTAIL (Ours)	40	39.00 (-3.23%)	42.30 (-2.76%)	42.30 (-2.76%)	42.30 (-2.76%)	15.00 (-14.29%)	18.00 (-13.04%)	18.10 (-13.40%)	18.10 (-13.40%)
	+IMPARTAIL (Ours)	10	27.50 (-31.76%)	29.40 (-32.41%)	29.40 (-32.41%)	29.40 (-32.41%)	19.30 (+10.29%)	23.20 (+12.08%)	23.50 (+12.44%)	23.50 (+12.44%)
SceneSayerSDE [37]	-	43.70	47.40	47.40	47.40	18.20	21.70	21.80	21.80	
+IMPARTAIL (Ours)	70	40.90 (-6.41%)	44.40 (-6.33%)	44.40 (-6.33%)	44.40 (-6.33%)	22.40 (+23.08%)	27.00 (+24.42%)	27.30 (+25.23%)	27.30 (+25.23%)	
+IMPARTAIL (Ours)	40	43.20 (-1.14%)	46.90 (-1.05%)	46.90 (-1.05%)	46.90 (-1.05%)	17.80 (-2.20%)	21.20 (-2.30%)	21.40 (-1.83%)	21.40 (-1.83%)	
+IMPARTAIL (Ours)	10	35.30 (-19.22%)	37.90 (-20.04%)	37.90 (-20.04%)	37.90 (-20.04%)	27.60 (+51.65%)	33.40 (+53.92%)	33.60 (+54.13%)	33.60 (+54.13%)	

Table 22. GAGS-With Constraint-0.7 results for SGA.

\mathcal{F}	Method	\mathcal{S}	WITH CONSTRAINT							
			R@10	R@20	R@50	R@100	mR@10	mR@20	mR@50	mR@100
0.7	STTran++ [37]	-	37.30	40.50	40.50	40.50	21.90	25.00	25.00	25.00
	+IMPARTAIL (Ours)	70	49.50 (+32.71%)	52.70 (+30.12%)	52.70 (+30.12%)	52.70 (+30.12%)	26.20 (+19.63%)	30.10 (+20.40%)	30.10 (+20.40%)	30.10 (+20.40%)
	+IMPARTAIL (Ours)	40	44.80 (+20.11%)	47.70 (+17.78%)	47.70 (+17.78%)	47.70 (+17.78%)	24.00 (+9.59%)	26.90 (+7.60%)	26.90 (+7.60%)	26.90 (+7.60%)
	+IMPARTAIL (Ours)	10	43.70 (+17.16%)	46.20 (+14.07%)	46.20 (+14.07%)	46.20 (+14.07%)	25.80 (+17.81%)	29.10 (+16.40%)	29.10 (+16.40%)	29.10 (+16.40%)
	DSGDetr++ [37]	-	48.50	51.80	51.80	51.80	20.80	23.80	23.80	23.80
	+IMPARTAIL (Ours)	70	49.80 (+2.68%)	52.90 (+2.12%)	53.00 (+2.32%)	53.00 (+2.32%)	25.30 (+21.63%)	28.70 (+20.59%)	28.70 (+20.59%)	28.70 (+20.59%)
	+IMPARTAIL (Ours)	40	49.20 (+1.44%)	52.30 (+0.97%)	52.30 (+0.97%)	52.30 (+0.97%)	26.90 (+29.33%)	30.70 (+28.99%)	30.80 (+29.41%)	30.80 (+29.41%)
	+IMPARTAIL (Ours)	10	40.70 (-16.08%)	43.10 (-16.80%)	43.10 (-16.80%)	43.10 (-16.80%)	28.30 (+36.06%)	32.50 (+36.55%)	32.50 (+36.55%)	32.50 (+36.55%)
	SceneSayerODE [37]	-	48.50	51.50	51.50	51.50	20.70	24.00	24.00	24.00
	+IMPARTAIL (Ours)	70	45.50 (-6.19%)	48.50 (-5.83%)	48.50 (-5.83%)	48.50 (-5.83%)	23.50 (+13.53%)	27.80 (+15.83%)	27.90 (+16.25%)	27.90 (+16.25%)
	+IMPARTAIL (Ours)	40	47.50 (-2.06%)	50.60 (-1.75%)	50.60 (-1.75%)	50.60 (-1.75%)	18.10 (-12.56%)	21.30 (-11.25%)	21.30 (-11.25%)	21.30 (-11.25%)
	+IMPARTAIL (Ours)	10	34.30 (-29.28%)	36.20 (-29.71%)	36.20 (-29.71%)	36.20 (-29.71%)	23.20 (+12.08%)	27.50 (+14.58%)	27.50 (+14.58%)	27.50 (+14.58%)
	SceneSayerSDE [37]	-	50.90	54.10	54.10	54.10	21.00	24.60	24.60	24.60
	+IMPARTAIL (Ours)	70	48.50 (-4.72%)	51.70 (-4.44%)	51.70 (-4.44%)	51.70 (-4.44%)	26.50 (+26.19%)	31.40 (+27.64%)	31.50 (+28.05%)	31.50 (+28.05%)
	+IMPARTAIL (Ours)	40	50.50 (-0.79%)	53.80 (-0.55%)	53.80 (-0.55%)	53.80 (-0.55%)	20.90 (-0.48%)	24.40 (-0.81%)	24.40 (-0.81%)	24.40 (-0.81%)
	+IMPARTAIL (Ours)	10	41.50 (-18.47%)	43.90 (-18.85%)	43.90 (-18.85%)	43.90 (-18.85%)	32.10 (+52.86%)	38.40 (+56.10%)	38.50 (+56.50%)	38.50 (+56.50%)

Table 23. GAGS-With Constraint-0.9 results for SGA.

\mathcal{F}	Method	\mathcal{S}	WITH CONSTRAINT							
			R@10	R@20	R@50	R@100	mR@10	mR@20	mR@50	mR@100
0.9	STTran++ [37]	-	45.50	47.80	47.80	47.80	28.80	31.30	31.30	31.30
	+IMPARTAIL (Ours)	70	59.00 (+29.67%)	61.30 (+28.24%)	61.30 (+28.24%)	61.30 (+28.24%)	34.20 (+18.75%)	37.20 (+18.85%)	37.30 (+19.17%)	37.30 (+19.17%)
	+IMPARTAIL (Ours)	40	53.90 (+18.46%)	56.00 (+17.15%)	56.00 (+17.15%)	56.00 (+17.15%)	31.90 (+10.76%)	34.40 (+9.90%)	34.40 (+9.90%)	34.40 (+9.90%)
	+IMPARTAIL (Ours)	10	50.90 (+11.87%)	52.70 (+10.25%)	52.70 (+10.25%)	52.70 (+10.25%)	36.70 (+27.43%)	40.30 (+28.75%)	40.30 (+28.75%)	40.30 (+28.75%)
	DSGDetr++ [37]	-	57.70	60.00	60.00	60.00	27.00	29.40	29.40	29.40
	+IMPARTAIL (Ours)	70	59.20 (+2.60%)	61.40 (+2.33%)	61.40 (+2.33%)	61.40 (+2.33%)	34.20 (+26.67%)	36.90 (+25.51%)	36.90 (+25.51%)	36.90 (+25.51%)
	+IMPARTAIL (Ours)	40	57.00 (-1.21%)	59.10 (-1.50%)	59.10 (-1.50%)	59.10 (-1.50%)	37.00 (+37.04%)	40.10 (+36.39%)	40.10 (+36.39%)	40.10 (+36.39%)
	+IMPARTAIL (Ours)	10	46.10 (-20.10%)	47.60 (-20.67%)	47.60 (-20.67%)	47.60 (-20.67%)	38.70 (+43.33%)	42.80 (+45.58%)	42.80 (+45.58%)	42.80 (+45.58%)
	SceneSayerODE [37]	-	58.50	60.60	60.60	60.60	25.10	27.60	27.60	27.60
	+IMPARTAIL (Ours)	70	54.10 (-7.52%)	56.10 (-7.43%)	56.10 (-7.43%)	56.10 (-7.43%)	27.70 (+10.36%)	30.60 (+10.87%)	30.60 (+10.87%)	30.60 (+10.87%)
	+IMPARTAIL (Ours)	40	56.70 (-3.08%)	59.00 (-2.64%)	59.00 (-2.64%)	59.00 (-2.64%)	21.80 (-13.15%)	24.40 (-11.59%)	24.40 (-11.59%)	24.40 (-11.59%)
	+IMPARTAIL (Ours)	10	43.80 (-25.13%)	45.30 (-25.25%)	45.30 (-25.25%)	45.30 (-25.25%)	28.50 (+13.55%)	31.60 (+14.49%)	31.60 (+14.49%)	31.60 (+14.49%)
	SceneSayerSDE [37]	-	59.00	61.20	61.20	61.20	24.70	27.30	27.30	27.30
	+IMPARTAIL (Ours)	70	57.00 (-3.39%)	59.20 (-3.27%)	59.20 (-3.27%)	59.20 (-3.27%)	31.80 (+28.74%)	35.40 (+29.67%)	35.40 (+29.67%)	35.40 (+29.67%)
	+IMPARTAIL (Ours)	40	58.10 (-1.53%)	60.30 (-1.47%)	60.30 (-1.47%)	60.30 (-1.47%)	24.60 (-0.40%)	27.30	27.30	27.30
	+IMPARTAIL (Ours)	10	49.40 (-16.27%)	51.10 (-16.50%)	51.10 (-16.50%)	51.10 (-16.50%)	38.60 (+56.28%)	43.50 (+59.34%)	43.50 (+59.34%)	43.50 (+59.34%)

12.2.6. Results - With Constraint Setting - Partially Grounded Action Genome Scenes (PGAGS)

Table 24. PGAGS-With Constraint-0.3 results for SGA.

\mathcal{F}	Method	\mathcal{S}	WITH CONSTRAINT							
			R@10	R@20	R@50	R@100	mR@10	mR@20	mR@50	mR@100
0.3	STTran++ [37]	-	20.30	21.40	21.40	21.40	12.60	13.60	13.60	13.60
	+IMPARTAIL (Ours)	70	26.70 (+31.53%)	27.70 (+29.44%)	27.70 (+29.44%)	27.70 (+29.44%)	12.80 (+1.59%)	13.60	13.60	13.60
	+IMPARTAIL (Ours)	40	27.60 (+35.96%)	28.70 (+34.11%)	28.70 (+34.11%)	28.70 (+34.11%)	15.10 (+19.84%)	16.30 (+19.85%)	16.30 (+19.85%)	16.30 (+19.85%)
	+IMPARTAIL (Ours)	10	21.80 (+7.39%)	22.40 (+4.67%)	22.40 (+4.67%)	22.40 (+4.67%)	17.60 (+39.68%)	18.90 (+38.97%)	18.90 (+38.97%)	18.90 (+38.97%)
	DSGDetr++ [37]	-	28.10	29.30	29.30	29.30	13.00	14.00	14.00	14.00
	+IMPARTAIL (Ours)	70	26.50 (-5.69%)	27.60 (-5.80%)	27.60 (-5.80%)	27.60 (-5.80%)	14.70 (+13.08%)	15.80 (+12.86%)	15.80 (+12.86%)	15.80 (+12.86%)
	+IMPARTAIL (Ours)	40	24.60 (-12.46%)	25.80 (-11.95%)	25.80 (-11.95%)	25.80 (-11.95%)	13.90 (+6.92%)	14.90 (+6.43%)	14.90 (+6.43%)	14.90 (+6.43%)
	+IMPARTAIL (Ours)	10	25.30 (-9.96%)	26.30 (-10.24%)	26.30 (-10.24%)	26.30 (-10.24%)	16.40 (+26.15%)	17.80 (+27.14%)	17.80 (+27.14%)	17.80 (+27.14%)
	SceneSayerODE [37]	-	22.60	23.70	23.80	23.80	9.40	10.50	10.50	10.50
	+IMPARTAIL (Ours)	70	18.10 (-19.91%)	18.80 (-20.68%)	18.80 (-21.01%)	18.80 (-21.01%)	10.50 (+11.70%)	11.80 (+12.38%)	11.80 (+12.38%)	11.80 (+12.38%)
	+IMPARTAIL (Ours)	40	28.00 (+23.89%)	29.40 (+24.05%)	29.40 (+23.53%)	29.40 (+23.53%)	12.70 (+35.11%)	14.10 (+34.29%)	14.10 (+34.29%)	14.10 (+34.29%)
	+IMPARTAIL (Ours)	10	21.60 (-4.42%)	22.30 (-5.91%)	22.40 (-5.88%)	22.40 (-5.88%)	15.60 (+65.96%)	17.80 (+69.52%)	17.80 (+69.52%)	17.80 (+69.52%)
SceneSayerSDE [37]	-	29.30	30.80	30.80	30.80	13.50	15.20	15.20	15.20	
+IMPARTAIL (Ours)	70	27.70 (-5.46%)	29.20 (-5.19%)	29.20 (-5.19%)	29.20 (-5.19%)	16.50 (+22.22%)	18.50 (+21.71%)	18.50 (+21.71%)	18.50 (+21.71%)	
+IMPARTAIL (Ours)	40	28.60 (-2.39%)	30.10 (-2.27%)	30.10 (-2.27%)	30.10 (-2.27%)	14.10 (+4.44%)	15.80 (+3.95%)	15.80 (+3.95%)	15.80 (+3.95%)	
+IMPARTAIL (Ours)	10	25.60 (-12.63%)	26.80 (-12.99%)	26.80 (-12.99%)	26.80 (-12.99%)	20.30 (+50.37%)	23.90 (+57.24%)	23.90 (+57.24%)	23.90 (+57.24%)	

Table 25. PGAGS-With Constraint-0.5 results for SGA.

\mathcal{F}	Method	\mathcal{S}	WITH CONSTRAINT							
			R@10	R@20	R@50	R@100	mR@10	mR@20	mR@50	mR@100
0.5	STTran++ [37]	-	22.50	23.80	23.80	23.80	14.30	15.80	15.80	15.80
	+IMPARTAIL (Ours)	70	29.50 (+31.11%)	30.60 (+28.57%)	30.60 (+28.57%)	30.60 (+28.57%)	14.50 (+1.40%)	15.70 (-0.63%)	15.70 (-0.63%)	15.70 (-0.63%)
	+IMPARTAIL (Ours)	40	30.20 (+34.22%)	31.40 (+31.93%)	31.40 (+31.93%)	31.40 (+31.93%)	16.90 (+18.18%)	18.50 (+17.09%)	18.50 (+17.09%)	18.50 (+17.09%)
	+IMPARTAIL (Ours)	10	24.10 (+7.11%)	25.00 (+5.04%)	25.00 (+5.04%)	25.00 (+5.04%)	20.20 (+41.26%)	22.00 (+39.24%)	22.00 (+39.24%)	22.00 (+39.24%)
	DSGDetr++ [37]	-	31.70	33.00	33.00	33.00	15.00	16.30	16.30	16.30
	+IMPARTAIL (Ours)	70	28.70 (-9.46%)	29.90 (-9.39%)	29.90 (-9.39%)	29.90 (-9.39%)	16.80 (+12.00%)	18.30 (+12.27%)	18.30 (+12.27%)	18.30 (+12.27%)
	+IMPARTAIL (Ours)	40	28.30 (-10.73%)	29.50 (-10.61%)	29.50 (-10.61%)	29.50 (-10.61%)	16.00 (+6.67%)	17.40 (+6.75%)	17.40 (+6.75%)	17.40 (+6.75%)
	+IMPARTAIL (Ours)	10	28.50 (-10.09%)	29.50 (-10.61%)	29.50 (-10.61%)	29.50 (-10.61%)	18.60 (+24.00%)	20.10 (+23.31%)	20.10 (+23.31%)	20.10 (+23.31%)
	SceneSayerODE [37]	-	25.80	27.20	27.20	27.20	11.20	12.80	12.80	12.80
	+IMPARTAIL (Ours)	70	21.20 (-17.83%)	22.20 (-18.38%)	22.20 (-18.38%)	22.20 (-18.38%)	12.60 (+12.50%)	14.50 (+13.28%)	14.50 (+13.28%)	14.50 (+13.28%)
	+IMPARTAIL (Ours)	40	31.90 (+23.64%)	33.60 (+23.53%)	33.60 (+23.53%)	33.60 (+23.53%)	14.50 (+29.46%)	16.40 (+28.12%)	16.40 (+28.12%)	16.40 (+28.12%)
	+IMPARTAIL (Ours)	10	25.30 (-1.94%)	26.30 (-3.31%)	26.30 (-3.31%)	26.30 (-3.31%)	18.00 (+60.71%)	21.30 (+66.41%)	21.40 (+67.19%)	21.40 (+67.19%)
SceneSayerSDE [37]	-	33.00	34.80	34.80	34.80	15.20	17.50	17.50	17.50	
+IMPARTAIL (Ours)	70	31.20 (-5.45%)	32.80 (-5.75%)	32.80 (-5.75%)	32.80 (-5.75%)	18.40 (+21.05%)	21.00 (+20.00%)	21.10 (+20.57%)	21.10 (+20.57%)	
+IMPARTAIL (Ours)	40	32.30 (-2.12%)	34.10 (-2.01%)	34.10 (-2.01%)	34.10 (-2.01%)	15.70 (+3.29%)	17.90 (+2.29%)	17.90 (+2.29%)	17.90 (+2.29%)	
+IMPARTAIL (Ours)	10	28.90 (-12.42%)	30.30 (-12.93%)	30.30 (-12.93%)	30.30 (-12.93%)	22.20 (+46.05%)	26.50 (+51.43%)	26.50 (+51.43%)	26.50 (+51.43%)	

Table 26. PGAGS-With Constraint-0.7 results for SGA.

\mathcal{F}	Method	\mathcal{S}	WITH CONSTRAINT							
			R@10	R@20	R@50	R@100	mR@10	mR@20	mR@50	mR@100
0.7	STTran++ [37]	-	27.10	28.20	28.20	28.20	17.20	18.60	18.60	18.60
	+IMPARTAIL (Ours)	70	36.10 (+33.21%)	37.10 (+31.56%)	37.10 (+31.56%)	37.10 (+31.56%)	18.70 (+8.72%)	19.90 (+6.99%)	19.90 (+6.99%)	19.90 (+6.99%)
	+IMPARTAIL (Ours)	40	36.00 (+32.84%)	37.00 (+31.21%)	37.00 (+31.21%)	37.00 (+31.21%)	21.00 (+22.09%)	22.70 (+22.04%)	22.70 (+22.04%)	22.70 (+22.04%)
	+IMPARTAIL (Ours)	10	29.60 (+9.23%)	30.20 (+7.09%)	30.20 (+7.09%)	30.20 (+7.09%)	25.60 (+48.84%)	27.40 (+47.31%)	27.40 (+47.31%)	27.40 (+47.31%)
	DSGDetr++ [37]	-	37.30	38.50	38.50	38.50	18.10	19.40	19.40	19.40
	+IMPARTAIL (Ours)	70	34.30 (-8.04%)	35.40 (-8.05%)	35.40 (-8.05%)	35.40 (-8.05%)	20.70 (+14.36%)	22.10 (+13.92%)	22.10 (+13.92%)	22.10 (+13.92%)
	+IMPARTAIL (Ours)	40	33.90 (-9.12%)	34.90 (-9.35%)	34.90 (-9.35%)	34.90 (-9.35%)	20.60 (+13.81%)	21.80 (+12.37%)	21.80 (+12.37%)	21.80 (+12.37%)
	+IMPARTAIL (Ours)	10	33.40 (-10.46%)	34.50 (-10.39%)	34.50 (-10.39%)	34.50 (-10.39%)	23.60 (+30.39%)	25.50 (+31.44%)	25.50 (+31.44%)	25.50 (+31.44%)
	SceneSayerODE [37]	-	30.80	32.20	32.20	32.20	13.60	15.10	15.10	15.10
	+IMPARTAIL (Ours)	70	25.60 (-16.88%)	26.60 (-17.39%)	26.60 (-17.39%)	26.60 (-17.39%)	14.70 (+8.09%)	16.70 (+10.60%)	16.70 (+10.60%)	16.70 (+10.60%)
	+IMPARTAIL (Ours)	40	37.20 (+20.78%)	38.70 (+20.19%)	38.70 (+20.19%)	38.70 (+20.19%)	16.90 (+24.26%)	18.70 (+23.84%)	18.80 (+24.50%)	18.80 (+24.50%)
	+IMPARTAIL (Ours)	10	31.10 (+0.97%)	32.10 (-0.31%)	32.10 (-0.31%)	32.10 (-0.31%)	22.20 (+63.24%)	25.60 (+69.54%)	25.70 (+70.20%)	25.70 (+70.20%)
	SceneSayerSDE [37]	-	38.80	40.30	40.30	40.30	17.90	19.90	19.90	19.90
	+IMPARTAIL (Ours)	70	36.80 (-5.15%)	38.30 (-4.96%)	38.30 (-4.96%)	38.30 (-4.96%)	21.70 (+21.23%)	24.00 (+20.60%)	24.00 (+20.60%)	24.00 (+20.60%)
	+IMPARTAIL (Ours)	40	38.40 (-1.03%)	40.00 (-0.74%)	40.00 (-0.74%)	40.00 (-0.74%)	18.80 (+5.03%)	20.70 (+4.02%)	20.70 (+4.02%)	20.70 (+4.02%)
	+IMPARTAIL (Ours)	10	34.40 (-11.34%)	35.60 (-11.66%)	35.60 (-11.66%)	35.60 (-11.66%)	25.90 (+44.69%)	30.00 (+50.75%)	30.10 (+51.26%)	30.10 (+51.26%)

Table 27. PGAGS-With Constraint-0.9 results for SGA.

\mathcal{F}	Method	\mathcal{S}	WITH CONSTRAINT							
			R@10	R@20	R@50	R@100	mR@10	mR@20	mR@50	mR@100
0.9	STTran++ [37]	-	31.00	31.80	31.80	31.80	21.20	22.50	22.50	22.50
	+IMPARTAIL (Ours)	70	42.00 (+35.48%)	42.80 (+34.59%)	42.80 (+34.59%)	42.80 (+34.59%)	26.00 (+22.64%)	27.20 (+20.89%)	27.20 (+20.89%)	27.20 (+20.89%)
	+IMPARTAIL (Ours)	40	39.90 (+28.71%)	40.60 (+27.67%)	40.60 (+27.67%)	40.60 (+27.67%)	26.60 (+25.47%)	28.10 (+24.89%)	28.10 (+24.89%)	28.10 (+24.89%)
	+IMPARTAIL (Ours)	10	32.70 (+5.48%)	33.20 (+4.40%)	33.20 (+4.40%)	33.20 (+4.40%)	32.60 (+53.77%)	34.20 (+52.00%)	34.20 (+52.00%)	34.20 (+52.00%)
	DSGDetr++ [37]	-	43.10	44.00	44.00	44.00	22.20	23.40	23.40	23.40
	+IMPARTAIL (Ours)	70	40.00 (-7.19%)	40.80 (-7.27%)	40.80 (-7.27%)	40.80 (-7.27%)	24.90 (+12.16%)	26.20 (+11.97%)	26.20 (+11.97%)	26.20 (+11.97%)
	+IMPARTAIL (Ours)	40	39.60 (-8.12%)	40.50 (-7.95%)	40.50 (-7.95%)	40.50 (-7.95%)	26.20 (+18.02%)	27.50 (+17.52%)	27.50 (+17.52%)	27.50 (+17.52%)
	+IMPARTAIL (Ours)	10	38.50 (-10.67%)	39.20 (-10.91%)	39.20 (-10.91%)	39.20 (-10.91%)	30.90 (+39.19%)	32.20 (+37.61%)	32.20 (+37.61%)	32.20 (+37.61%)
	SceneSayerODE [37]	-	36.60	37.60	37.60	37.60	16.60	17.90	17.90	17.90
	+IMPARTAIL (Ours)	70	31.80 (-13.11%)	32.60 (-13.30%)	32.60 (-13.30%)	32.60 (-13.30%)	18.40 (+10.84%)	20.10 (+12.29%)	20.10 (+12.29%)	20.10 (+12.29%)
	+IMPARTAIL (Ours)	40	42.70 (+16.67%)	43.80 (+16.49%)	43.80 (+16.49%)	43.80 (+16.49%)	19.40 (+16.87%)	20.90 (+16.76%)	20.90 (+16.76%)	20.90 (+16.76%)
	+IMPARTAIL (Ours)	10	38.40 (+4.92%)	39.30 (+4.52%)	39.30 (+4.52%)	39.30 (+4.52%)	28.30 (+70.48%)	30.90 (+72.63%)	30.90 (+72.63%)	30.90 (+72.63%)
	SceneSayerSDE [37]	-	44.40	45.50	45.50	45.50	21.00	22.60	22.60	22.60
	+IMPARTAIL (Ours)	70	43.10 (-2.93%)	44.20 (-2.86%)	44.20 (-2.86%)	44.20 (-2.86%)	25.20 (+20.00%)	27.00 (+19.47%)	27.00 (+19.47%)	27.00 (+19.47%)
	+IMPARTAIL (Ours)	40	44.70 (+0.68%)	45.90 (+0.88%)	45.90 (+0.88%)	45.90 (+0.88%)	21.80 (+3.81%)	23.50 (+3.98%)	23.50 (+3.98%)	23.50 (+3.98%)
	+IMPARTAIL (Ours)	10	40.50 (-8.78%)	41.40 (-9.01%)	41.40 (-9.01%)	41.40 (-9.01%)	31.60 (+50.48%)	34.70 (+53.54%)	34.70 (+53.54%)	34.70 (+53.54%)

12.2.7. Results - With Constraint Setting - Action Genome Scenes (AGS)

Table 28. AGS-With Constraint-0.3 results for SGA.

\mathcal{F}	Method	S	WITH CONSTRAINT							
			R@10	R@20	R@50	R@100	mR@10	mR@20	mR@50	mR@100
0.3	STTran++ [37]	-	19.40	31.10	33.50	33.50	7.60	15.30	16.90	16.90
	+IMPARTAIL (Ours)	70	19.70 (+1.55%)	30.20 (-2.89%)	32.40 (-3.28%)	32.40 (-3.28%)	7.80 (+2.63%)	15.10 (-1.31%)	16.80 (-0.59%)	16.80 (-0.59%)
	+IMPARTAIL (Ours)	40	19.20 (-1.03%)	30.30 (-2.57%)	32.60 (-2.69%)	32.60 (-2.69%)	8.40 (+10.53%)	16.80 (+9.80%)	18.60 (+10.06%)	18.60 (+10.06%)
	+IMPARTAIL (Ours)	10	18.30 (-5.67%)	27.40 (-11.90%)	29.30 (-12.54%)	29.30 (-12.54%)	8.90 (+17.11%)	17.90 (+16.99%)	19.70 (+16.57%)	19.70 (+16.57%)
	DSGDetr++ [37]	-	18.80	28.30	29.90	29.90	7.10	12.80	13.80	13.80
	+IMPARTAIL (Ours)	70	18.60 (-1.06%)	27.40 (-3.18%)	29.10 (-2.68%)	29.10 (-2.68%)	8.20 (+15.49%)	15.20 (+18.75%)	16.60 (+20.29%)	16.60 (+20.29%)
	+IMPARTAIL (Ours)	40	16.50 (-12.23%)	24.70 (-12.72%)	26.30 (-12.04%)	26.30 (-12.04%)	8.30 (+16.90%)	15.80 (+23.44%)	17.10 (+23.91%)	17.10 (+23.91%)
	+IMPARTAIL (Ours)	10	16.90 (-10.11%)	23.50 (-16.96%)	24.50 (-18.06%)	24.50 (-18.06%)	9.30 (+30.99%)	18.40 (+43.75%)	20.20 (+46.38%)	20.20 (+46.38%)
	SceneSayerODE [37]	-	15.10	25.70	30.10	30.20	5.50	11.90	19.00	19.00
	+IMPARTAIL (Ours)	70	13.80 (-8.61%)	23.00 (-10.51%)	26.80 (-10.96%)	26.80 (-11.26%)	5.80 (+5.45%)	12.80 (+7.56%)	16.40 (-13.68%)	16.40 (-13.68%)
	+IMPARTAIL (Ours)	40	16.30 (+7.95%)	28.20 (+9.73%)	33.70 (+11.96%)	33.80 (+11.92%)	5.80 (+5.45%)	12.50 (+5.04%)	16.00 (-15.79%)	16.10 (-15.26%)
	+IMPARTAIL (Ours)	10	14.80 (-1.99%)	24.80 (-3.50%)	29.10 (-3.32%)	29.10 (-3.64%)	6.60 (+20.00%)	15.40 (+29.41%)	20.40 (+7.37%)	20.40 (+7.37%)
SceneSayerSDE [37]	-	15.90	27.80	33.40	33.50	5.90	13.40	17.20	17.20	
+IMPARTAIL (Ours)	70	16.10 (+1.26%)	28.10 (+1.08%)	33.70 (+0.90%)	33.70 (+0.60%)	6.70 (+13.56%)	15.80 (+17.91%)	20.80 (+20.93%)	20.80 (+20.93%)	
+IMPARTAIL (Ours)	40	16.10 (+1.26%)	28.20 (+1.44%)	33.90 (+1.50%)	34.00 (+1.49%)	5.90	13.10 (-2.24%)	17.20	17.20	
+IMPARTAIL (Ours)	10	13.10 (-17.61%)	23.00 (-17.27%)	27.20 (-18.56%)	27.20 (-18.81%)	7.30 (+23.73%)	19.30 (+44.03%)	25.90 (+50.58%)	26.00 (+51.16%)	

Table 29. AGS-With Constraint-0.5 results for SGA.

\mathcal{F}	Method	S	WITH CONSTRAINT							
			R@10	R@20	R@50	R@100	mR@10	mR@20	mR@50	mR@100
0.5	STTran++ [37]	-	20.40	33.30	35.90	35.90	7.90	16.40	18.40	18.40
	+IMPARTAIL (Ours)	70	21.10 (+3.43%)	32.70 (-1.80%)	34.90 (-2.79%)	34.90 (-2.79%)	8.30 (+5.06%)	16.50 (+0.61%)	18.30 (-0.54%)	18.30 (-0.54%)
	+IMPARTAIL (Ours)	40	20.60 (+0.98%)	32.50 (-2.40%)	35.00 (-2.51%)	35.00 (-2.51%)	8.90 (+12.66%)	17.80 (+8.54%)	19.80 (+7.61%)	19.80 (+7.61%)
	+IMPARTAIL (Ours)	10	19.80 (-2.94%)	29.70 (-10.81%)	31.80 (-11.42%)	31.80 (-11.42%)	9.30 (+17.72%)	18.70 (+14.02%)	20.90 (+13.59%)	20.90 (+13.59%)
	DSGDetr++ [37]	-	19.80	30.00	31.90	31.90	7.40	13.40	14.60	14.60
	+IMPARTAIL (Ours)	70	20.10 (+1.52%)	29.60 (-1.33%)	31.50 (-1.25%)	31.50 (-1.25%)	8.70 (+17.57%)	16.40 (+22.39%)	17.90 (+22.60%)	17.90 (+22.60%)
	+IMPARTAIL (Ours)	40	18.10 (-8.59%)	27.00 (-10.00%)	28.80 (-9.72%)	28.80 (-9.72%)	8.90 (+20.27%)	17.00 (+26.87%)	18.60 (+27.40%)	18.60 (+27.40%)
	+IMPARTAIL (Ours)	10	18.10 (-8.59%)	25.30 (-15.67%)	26.70 (-16.30%)	26.70 (-16.30%)	9.80 (+32.43%)	19.80 (+47.76%)	21.90 (+50.00%)	21.90 (+50.00%)
	SceneSayerODE [37]	-	16.60	28.20	33.50	33.60	5.80	12.60	16.90	16.90
	+IMPARTAIL (Ours)	70	15.10 (-9.04%)	25.40 (-9.93%)	30.00 (-10.45%)	30.00 (-10.71%)	5.90 (+1.72%)	13.50 (+7.14%)	18.00 (+6.51%)	18.00 (+6.51%)
	+IMPARTAIL (Ours)	40	17.30 (+4.22%)	29.90 (+6.03%)	36.20 (+8.06%)	36.30 (+8.04%)	6.00 (+3.45%)	12.70 (+0.79%)	16.90	16.90
	+IMPARTAIL (Ours)	10	15.60 (-6.02%)	26.20 (-7.09%)	31.30 (-6.57%)	31.40 (-6.55%)	6.80 (+17.24%)	16.10 (+27.78%)	22.00 (+30.18%)	22.00 (+30.18%)
SceneSayerSDE [37]	-	17.50	30.00	36.50	36.50	6.40	13.70	18.30	18.30	
+IMPARTAIL (Ours)	70	16.90 (-3.43%)	29.70 (-1.00%)	36.20 (-0.82%)	36.20 (-0.82%)	6.80 (+6.25%)	16.10 (+17.52%)	21.90 (+19.67%)	21.90 (+19.67%)	
+IMPARTAIL (Ours)	40	17.40 (-0.57%)	30.20 (+0.67%)	36.70 (+0.55%)	36.70 (+0.55%)	6.30 (-1.56%)	13.70	18.40 (+0.55%)	18.40 (+0.55%)	
+IMPARTAIL (Ours)	10	14.50 (-17.14%)	24.80 (-17.33%)	29.90 (-18.08%)	30.00 (-17.81%)	7.40 (+15.62%)	19.10 (+39.42%)	27.70 (+51.37%)	27.80 (+51.91%)	

Table 30. AGS-With Constraint-0.7 results for SGA.

\mathcal{F}	Method	\mathcal{S}	WITH CONSTRAINT							
			R@10	R@20	R@50	R@100	mR@10	mR@20	mR@50	mR@100
0.7	STTran++ [37]	-	22.50	36.40	39.20	39.20	9.10	18.20	20.20	20.20
	+IMPARTAIL (Ours)	70	23.50 (+4.44%)	36.50 (+0.27%)	39.10 (-0.26%)	39.10 (-0.26%)	9.90 (+8.79%)	19.30 (+6.04%)	21.50 (+6.44%)	21.50 (+6.44%)
	+IMPARTAIL (Ours)	40	23.00 (+2.22%)	36.00 (-1.10%)	38.70 (-1.28%)	38.70 (-1.28%)	10.40 (+14.29%)	20.50 (+12.64%)	22.80 (+12.87%)	22.80 (+12.87%)
	+IMPARTAIL (Ours)	10	21.90 (-2.67%)	32.70 (-10.16%)	34.90 (-10.97%)	34.90 (-10.97%)	10.90 (+19.78%)	21.90 (+20.33%)	24.10 (+19.31%)	24.10 (+19.31%)
	DSGDetr++ [37]	-	22.20	33.20	35.10	35.10	8.40	14.80	16.00	16.00
	+IMPARTAIL (Ours)	70	22.40 (+0.90%)	32.60 (-1.81%)	34.50 (-1.71%)	34.50 (-1.71%)	10.10 (+20.24%)	18.40 (+24.32%)	20.10 (+25.63%)	20.10 (+25.63%)
	+IMPARTAIL (Ours)	40	20.50 (-7.66%)	30.60 (-7.83%)	32.60 (-7.12%)	32.60 (-7.12%)	10.50 (+25.00%)	19.50 (+31.76%)	21.20 (+32.50%)	21.20 (+32.50%)
	+IMPARTAIL (Ours)	10	20.20 (-9.01%)	28.10 (-15.36%)	29.60 (-15.67%)	29.60 (-15.67%)	11.50 (+36.90%)	23.10 (+56.08%)	25.20 (+57.50%)	25.20 (+57.50%)
	SceneSayerODE [37]	-	19.00	32.00	37.90	38.00	6.70	14.00	18.50	18.50
	+IMPARTAIL (Ours)	70	17.60 (-7.37%)	28.90 (-9.69%)	33.90 (-10.55%)	33.90 (-10.79%)	6.90 (+2.99%)	15.00 (+7.14%)	19.60 (+5.95%)	19.60 (+5.95%)
	+IMPARTAIL (Ours)	40	19.50 (+2.63%)	33.10 (+3.44%)	39.50 (+4.22%)	39.50 (+3.95%)	6.80 (+1.49%)	13.90 (-0.71%)	18.20 (-1.62%)	18.30 (-1.08%)
	+IMPARTAIL (Ours)	10	17.50 (-7.89%)	28.90 (-9.69%)	34.10 (-10.03%)	34.20 (-10.00%)	7.90 (+17.91%)	17.70 (+26.43%)	23.40 (+26.49%)	23.40 (+26.49%)
	SceneSayerSDE [37]	-	19.50	33.00	39.60	39.70	7.10	14.60	19.30	19.30
	+IMPARTAIL (Ours)	70	19.10 (-2.05%)	32.50 (-1.52%)	39.40 (-0.51%)	39.40 (-0.76%)	7.80 (+9.86%)	17.40 (+19.18%)	23.80 (+23.32%)	23.80 (+23.32%)
	+IMPARTAIL (Ours)	40	19.60 (+0.51%)	33.50 (+1.52%)	40.40 (+2.02%)	40.40 (+1.76%)	7.10	15.00 (+2.74%)	20.20 (+4.66%)	20.20 (+4.66%)
	+IMPARTAIL (Ours)	10	16.80 (-13.85%)	27.90 (-15.45%)	33.00 (-16.67%)	33.00 (-16.88%)	8.60 (+21.13%)	21.30 (+45.89%)	29.30 (+51.81%)	29.30 (+51.81%)

Table 31. AGS-With Constraint-0.9 results for SGA.

\mathcal{F}	Method	\mathcal{S}	WITH CONSTRAINT							
			R@10	R@20	R@50	R@100	mR@10	mR@20	mR@50	mR@100
0.9	STTran++ [37]	-	24.60	39.80	42.90	42.90	9.80	20.90	23.50	23.50
	+IMPARTAIL (Ours)	70	25.80 (+4.88%)	40.50 (+1.76%)	43.50 (+1.40%)	43.50 (+1.40%)	11.10 (+13.27%)	22.70 (+8.61%)	25.40 (+8.09%)	25.40 (+8.09%)
	+IMPARTAIL (Ours)	40	24.70 (+0.41%)	39.50 (-0.75%)	42.50 (-0.93%)	42.50 (-0.93%)	12.30 (+25.51%)	25.50 (+22.01%)	28.20 (+20.00%)	28.20 (+20.00%)
	+IMPARTAIL (Ours)	10	23.60 (-4.07%)	35.60 (-10.55%)	37.90 (-11.66%)	37.90 (-11.66%)	12.60 (+28.57%)	27.10 (+29.67%)	29.90 (+27.23%)	29.90 (+27.23%)
	DSGDetr++ [37]	-	24.80	37.50	39.70	39.70	9.50	17.70	19.20	19.20
	+IMPARTAIL (Ours)	70	24.70 (-0.40%)	37.10 (-1.07%)	39.50 (-0.50%)	39.50 (-0.50%)	11.90 (+25.26%)	22.50 (+27.12%)	24.90 (+29.69%)	24.90 (+29.69%)
	+IMPARTAIL (Ours)	40	24.00 (-3.23%)	36.20 (-3.47%)	38.50 (-3.02%)	38.50 (-3.02%)	12.40 (+30.53%)	24.80 (+40.11%)	27.00 (+40.62%)	27.00 (+40.62%)
	+IMPARTAIL (Ours)	10	23.10 (-6.85%)	32.30 (-13.87%)	33.90 (-14.61%)	33.90 (-14.61%)	13.60 (+43.16%)	27.80 (+57.06%)	30.20 (+57.29%)	30.20 (+57.29%)
	SceneSayerODE [37]	-	21.00	36.00	43.20	43.20	7.00	15.60	21.00	21.00
	+IMPARTAIL (Ours)	70	19.50 (-7.14%)	32.80 (-8.89%)	38.70 (-10.42%)	38.80 (-10.19%)	7.50 (+7.14%)	16.60 (+6.41%)	21.80 (+3.81%)	21.90 (+4.29%)
	+IMPARTAIL (Ours)	40	20.90 (-0.48%)	35.90 (-0.28%)	43.50 (+0.69%)	43.50 (+0.69%)	7.00	15.20 (-2.56%)	20.60 (-1.90%)	20.60 (-1.90%)
	+IMPARTAIL (Ours)	10	18.40 (-12.38%)	31.50 (-12.50%)	37.30 (-13.66%)	37.30 (-13.66%)	8.30 (+18.57%)	19.80 (+26.92%)	26.10 (+24.29%)	26.10 (+24.29%)
	SceneSayerSDE [37]	-	21.00	36.40	43.90	44.00	7.40	16.00	21.10	21.10
	+IMPARTAIL (Ours)	70	20.60 (-1.90%)	35.90 (-1.37%)	43.80 (-0.23%)	43.80 (-0.45%)	8.20 (+10.81%)	18.90 (+18.12%)	25.60 (+21.33%)	25.60 (+21.33%)
	+IMPARTAIL (Ours)	40	21.20 (+0.95%)	36.60 (+0.55%)	44.40 (+1.14%)	44.50 (+1.14%)	7.20 (-2.70%)	16.40 (+2.50%)	22.10 (+4.74%)	22.10 (+4.74%)
	+IMPARTAIL (Ours)	10	18.70 (-10.95%)	31.50 (-13.46%)	37.60 (-14.35%)	37.60 (-14.55%)	9.40 (+27.03%)	24.00 (+50.00%)	32.70 (+54.98%)	32.70 (+54.98%)

12.3. Robust Video Scene Graph Generation

12.3.1. Findings

Table 32, Table 33 present the Robustness Evaluation Results for SGCLS and PREDCLS for Scene Graph Generation (SGG) under various corruption scenarios. These experiments assess how well models, with and without **IMPARTAIL**, handle different levels of data corruption. The settings include 15 corruption types and three graph-building strategies (With Cosntraint, No Constraint, Semi Constraint). Results highlight the impact of **IMPARTAIL** in improving robustness across these scenarios. **IMPARTAIL** performs best against Fog, Brightness, Saturate and moderate gains under Defocus blur, Gaussian Blur. **IMPARTAIL** shows an average of 25% gains for With Constraint mR@50, 10% gains for No Constraint mR@50.

12.3.2. Results

Table 32. Robustness Evaluation Results for SGG.

Severity	Mode	Corruption	Method	With Constraint			No Constraint						Semi Constraint		
				mR@10	mR@20	mR@50	R@10	R@20	R@50	mR@10	mR@20	mR@50	mR@10	mR@20	mR@50
3	sgcls	Gaussian Noise	DSGDetr [11]	9.6	10.3	10.3	20.9	25.4	26.8	15.7	19.4	23.4	11.4	15.3	15.7
			+IMPARTAIL (Ours)	13.7 (+42.7%)	14.9 (+44.7%)	15.0 (+45.6%)	21.0 (+0.5%)	27.3 (+7.5%)	30.1 (+12.3%)	20.8 (+32.5%)	25.4 (+30.9%)	29.1 (+24.4%)	15.6 (+36.8%)	21.5 (+40.5%)	22.2 (+41.4%)
		Shot Noise	DSGDetr [11]	10.0	10.8	10.8	21.9	26.6	28.1	16.6	20.4	26.5	12.1	16.3	16.6
			+IMPARTAIL (Ours)	15.0 (+50.0%)	16.5 (+52.8%)	16.5 (+52.8%)	22.6 (+3.2%)	29.4 (+10.5%)	32.6 (+16.0%)	22.4 (+34.9%)	27.3 (+33.8%)	31.0 (+17.0%)	17.2 (+42.1%)	23.3 (+42.9%)	24.2 (+45.8%)
		Impulse Noise	DSGDetr [11]	8.7	9.4	9.5	19.2	23.4	24.7	14.4	17.7	23.4	10.4	14.2	14.6
			+IMPARTAIL (Ours)	12.4 (+42.5%)	13.7 (+45.7%)	13.7 (+44.2%)	19.4 (+1.0%)	25.3 (+8.1%)	27.9 (+13.0%)	18.5 (+28.5%)	22.8 (+28.8%)	26.2 (+12.0%)	13.9 (+33.7%)	19.2 (+35.2%)	20.1 (+37.7%)
		Speckle Noise	DSGDetr [11]	12.6	13.7	13.7	26.2	32.2	34.2	20.3	25.0	32.2	15.0	20.7	21.2
			+IMPARTAIL (Ours)	17.6 (+39.7%)	19.3 (+40.9%)	19.3 (+40.9%)	26.4 (+0.8%)	34.5 (+7.1%)	38.4 (+12.3%)	27.1 (+33.5%)	32.6 (+30.4%)	37.3 (+15.8%)	20.4 (+36.0%)	27.8 (+34.3%)	28.9 (+36.3%)
		Gaussian Blur	DSGDetr [11]	21.1	22.8	22.8	43.7	53.3	56.5	33.4	41.0	52.3	24.6	33.2	34.0
			+IMPARTAIL (Ours)	26.1 (+23.7%)	28.7 (+25.9%)	28.8 (+26.3%)	39.4 (-9.8%)	52.0 (-2.4%)	57.8 (+2.3%)	39.5 (+18.3%)	48.8 (+19.0%)	58.2 (+11.3%)	29.4 (+19.5%)	40.8 (+22.9%)	42.5 (+25.0%)
		Defocus Blur	DSGDetr [11]	20.9	22.6	22.6	43.2	52.8	55.9	32.7	40.4	51.7	24.3	32.7	33.5
			+IMPARTAIL (Ours)	25.6 (+22.5%)	28.1 (+24.3%)	28.1 (+24.3%)	39.0 (-9.7%)	51.4 (-2.7%)	57.3 (+2.5%)	38.6 (+18.0%)	47.7 (+18.1%)	57.0 (+10.3%)	28.7 (+18.1%)	40.0 (+22.3%)	41.7 (+24.5%)
		Fog	DSGDetr [11]	22.6	24.9	24.9	47.8	58.4	62.0	35.5	43.4	54.6	26.6	36.1	37.2
			+IMPARTAIL (Ours)	28.3 (+25.2%)	31.8 (+27.7%)	31.9 (+28.1%)	42.6 (-10.9%)	56.0 (-4.1%)	62.1 (+0.2%)	43.8 (+23.4%)	53.0 (+22.1%)	61.7 (+13.0%)	31.8 (+19.5%)	45.7 (+26.6%)	48.2 (+29.6%)
		Frost	DSGDetr [11]	16.7	18.5	18.5	34.5	42.3	45.1	26.8	33.0	40.1	19.6	26.8	27.7
			+IMPARTAIL (Ours)	22.4 (+34.1%)	25.0 (+35.1%)	25.1 (+35.7%)	31.9 (-7.5%)	42.0 (-0.7%)	47.1 (+4.4%)	34.9 (+30.2%)	42.3 (+28.2%)	48.2 (+20.2%)	25.9 (+32.1%)	36.5 (+36.2%)	38.4 (+38.6%)
		Spatter	DSGDetr [11]	18.6	20.3	20.3	41.4	51.0	54.3	29.0	36.5	48.0	21.7	29.3	30.1
			+IMPARTAIL (Ours)	24.7 (+32.8%)	27.4 (+35.0%)	27.5 (+35.5%)	38.6 (-6.8%)	50.6 (-0.8%)	56.1 (+3.3%)	37.4 (+29.0%)	46.1 (+26.3%)	55.8 (+16.2%)	27.9 (+28.6%)	39.3 (+34.1%)	41.4 (+37.5%)
		Contrast	DSGDetr [11]	20.0	21.8	21.8	42.4	52.2	55.5	31.3	38.6	48.8	23.6	31.9	32.9
			+IMPARTAIL (Ours)	24.9 (+24.5%)	27.7 (+27.1%)	27.8 (+27.5%)	36.9 (-13.0%)	49.0 (-6.1%)	54.6 (-1.6%)	37.9 (+21.1%)	46.0 (+19.2%)	54.3 (+11.3%)	27.5 (+16.5%)	38.6 (+21.0%)	40.6 (+23.4%)
		Brightness	DSGDetr [11]	23.6	25.7	25.7	50.8	61.9	65.5	36.8	45.4	57.5	27.6	37.5	38.6
			+IMPARTAIL (Ours)	29.8 (+26.3%)	33.2 (+29.2%)	33.2 (+29.2%)	45.5 (-10.4%)	59.9 (-3.2%)	66.1 (+0.9%)	45.0 (+22.3%)	55.4 (+22.0%)	65.3 (+13.6%)	33.7 (+22.1%)	48.1 (+28.3%)	50.6 (+31.1%)
		Pixelate	DSGDetr [11]	21.6	23.3	23.3	48.1	59.7	63.8	33.5	42.6	56.9	25.4	33.7	34.6
			+IMPARTAIL (Ours)	27.7 (+28.2%)	30.5 (+30.9%)	30.5 (+30.9%)	43.8 (-8.9%)	57.7 (-3.4%)	64.1 (+0.5%)	42.5 (+26.9%)	52.8 (+23.9%)	63.1 (+10.9%)	31.4 (+23.6%)	44.5 (+32.0%)	46.7 (+35.0%)
		Compression	DSGDetr [11]	19.9	21.5	21.6	45.0	55.7	59.5	31.3	40.1	52.4	23.4	31.2	32.1
			+IMPARTAIL (Ours)	26.6 (+33.7%)	29.3 (+36.3%)	29.4 (+36.1%)	41.9 (-6.9%)	55.1 (-1.1%)	61.5 (+3.4%)	40.8 (+30.4%)	50.5 (+25.9%)	60.2 (+14.9%)	29.8 (+27.4%)	42.1 (+34.9%)	44.0 (+37.1%)
		Sun Glare	DSGDetr [11]	12.1	13.2	13.2	26.3	32.5	34.7	19.3	24.4	30.2	14.2	19.2	19.6
			+IMPARTAIL (Ours)	17.3 (+43.0%)	19.4 (+47.0%)	19.4 (+47.0%)	25.8 (-1.9%)	34.3 (+5.5%)	38.5 (+11.0%)	26.6 (+37.8%)	32.2 (+32.0%)	37.3 (+23.5%)	19.4 (+36.6%)	27.6 (+43.7%)	29.0 (+48.0%)
		Dust	DSGDetr [11]	13.2	14.5	14.6	28.5	35.4	37.7	21.5	26.8	34.2	15.4	20.8	21.4
			+IMPARTAIL (Ours)	16.6 (+25.8%)	18.6 (+28.3%)	18.6 (+27.4%)	25.1 (-11.9%)	32.9 (-7.1%)	36.8 (-2.4%)	25.9 (+20.5%)	31.0 (+15.7%)	37.0 (+8.2%)	19.1 (+24.0%)	26.3 (+26.4%)	27.4 (+28.0%)
Saturate	DSGDetr [11]	25.9	28.4	28.4	54.6	66.2	69.9	40.7	49.3	62.4	30.6	41.7	42.9		
	+IMPARTAIL (Ours)	31.5 (+21.6%)	35.1 (+23.6%)	35.2 (+23.9%)	48.8 (-10.6%)	63.8 (-3.6%)	70.4 (+0.7%)	47.4 (+16.5%)	58.4 (+18.5%)	68.8 (+10.3%)	35.7 (+16.7%)	51.0 (+22.3%)	53.5 (+24.7%)		

Table 33. Robustness Evaluation Results for SGG.

Severity	Mode	Corruption	Method	With Constraint			No Constraint						Semi Constraint		
				mR@10	mR@20	mR@50	R@10	R@20	R@50	mR@10	mR@20	mR@50	mR@10	mR@20	mR@50
5	predcls	Gaussian Noise	STTran [7]	20.0	22.3	22.4	64.2	87.6	99.0	31.4	52.5	79.7	26.0	36.6	38.5
			+IMPARTAIL (Ours)	37.6 (+88.0%)	43.8 (+96.4%)	43.9 (+96.0%)	62.5 (-2.6%)	84.6 (-3.4%)	99.0 (0.0%)	57.5 (+83.1%)	77.7 (+48.0%)	92.7 (+16.3%)	42.2 (+62.3%)	60.0 (+63.9%)	62.9 (+63.4%)
		Shot Noise	STTran [7]	20.3	22.8	22.9	64.6	88.0	99.0	32.1	53.4	79.9	26.4	37.1	39.0
			+IMPARTAIL (Ours)	37.5 (+84.7%)	43.7 (+91.7%)	43.8 (+91.3%)	62.4 (-3.4%)	84.6 (-3.9%)	99.0 (0.0%)	57.1 (+77.9%)	77.9 (+45.9%)	92.8 (+16.1%)	42.2 (+59.8%)	60.5 (+63.1%)	63.6 (+63.1%)
		Impulse Noise	STTran [7]	20.3	22.8	22.9	64.6	88.0	99.0	31.9	52.9	79.8	26.3	37.2	39.1
			+IMPARTAIL (Ours)	37.7 (+85.7%)	43.8 (+92.1%)	43.9 (+91.7%)	62.4 (-3.4%)	84.7 (-3.8%)	99.0 (0.0%)	57.4 (+79.9%)	77.7 (+46.9%)	92.6 (+16.0%)	42.0 (+59.7%)	60.1 (+61.6%)	63.1 (+61.4%)
		Speckle Noise	STTran [7]	23.1	26.1	26.2	66.8	89.6	99.1	37.1	57.8	80.3	30.2	43.1	45.3
			+IMPARTAIL (Ours)	38.8 (+68.0%)	45.5 (+74.3%)	45.5 (+73.7%)	60.2 (-9.9%)	82.9 (-7.5%)	98.4 (-0.7%)	59.4 (+60.1%)	77.8 (+34.6%)	92.5 (+15.2%)	43.6 (+44.4%)	60.7 (+40.8%)	63.1 (+39.3%)
		Gaussian Blur	STTran [7]	25.3	28.5	28.6	67.9	89.2	99.0	38.2	57.6	79.9	30.6	43.1	44.9
			+IMPARTAIL (Ours)	38.7 (+53.0%)	45.7 (+60.4%)	45.9 (+60.5%)	65.0 (-4.3%)	85.7 (-3.9%)	99.0 (0.0%)	59.5 (+55.8%)	78.1 (+35.6%)	92.5 (+15.8%)	43.0 (+40.5%)	62.0 (+43.9%)	64.5 (+43.7%)
		Defocus Blur	STTran [7]	25.8	29.2	29.3	68.4	89.6	99.1	39.0	58.1	80.2	31.4	44.1	46.0
			+IMPARTAIL (Ours)	38.9 (+50.8%)	46.0 (+57.5%)	46.2 (+57.7%)	65.2 (-4.7%)	86.0 (-4.0%)	99.0 (-0.1%)	60.0 (+53.8%)	78.5 (+35.1%)	92.8 (+15.7%)	43.6 (+38.9%)	63.2 (+43.3%)	65.9 (+43.3%)
		Fog	STTran [7]	26.5	30.2	30.3	70.2	91.1	99.1	41.6	61.0	80.5	33.2	46.8	48.7
			+IMPARTAIL (Ours)	42.6 (+60.8%)	50.9 (+68.5%)	51.1 (+68.6%)	64.8 (-7.7%)	86.3 (-5.3%)	98.8 (-0.3%)	63.8 (+53.4%)	80.2 (+31.5%)	92.7 (+15.2%)	46.2 (+39.2%)	65.5 (+40.0%)	68.2 (+40.0%)
		Frost	STTran [7]	25.6	29.2	29.2	69.4	90.7	99.1	41.0	60.9	80.5	32.7	46.1	48.0
			+IMPARTAIL (Ours)	41.0 (+60.2%)	49.0 (+67.8%)	49.2 (+68.5%)	62.2 (-10.4%)	84.3 (-7.1%)	98.5 (-0.6%)	62.5 (+52.4%)	78.6 (+29.1%)	92.7 (+15.2%)	45.1 (+37.9%)	62.9 (+36.4%)	65.1 (+35.6%)
		Spatter	STTran [7]	25.7	29.2	29.3	69.5	91.1	99.2	40.0	60.0	80.3	32.0	45.0	47.0
			+IMPARTAIL (Ours)	41.3 (+60.7%)	48.8 (+67.1%)	48.9 (+66.9%)	58.8 (-15.4%)	82.3 (-9.7%)	98.0 (-1.2%)	62.0 (+55.0%)	78.6 (+31.0%)	92.5 (+15.2%)	44.6 (+39.4%)	62.0 (+37.8%)	64.3 (+36.8%)
		Contrast	STTran [7]	20.5	22.9	23.0	64.9	87.9	99.0	32.4	53.0	79.6	26.5	36.9	38.5
			+IMPARTAIL (Ours)	37.7 (+83.9%)	44.2 (+93.0%)	44.3 (+92.6%)	63.3 (-2.5%)	85.0 (-3.3%)	99.0 (0.0%)	56.4 (+74.1%)	76.0 (+43.4%)	92.0 (+15.6%)	41.2 (+55.5%)	57.6 (+56.1%)	59.6 (+54.8%)
		Brightness	STTran [7]	28.2	32.0	32.1	71.3	91.6	99.2	42.8	62.0	80.4	34.5	49.0	51.2
			+IMPARTAIL (Ours)	42.3 (+50.0%)	50.4 (+57.5%)	50.5 (+57.3%)	65.9 (-7.6%)	87.2 (-4.8%)	98.9 (-0.3%)	64.0 (+49.5%)	80.8 (+30.3%)	92.8 (+15.4%)	46.9 (+35.9%)	67.8 (+38.4%)	71.0 (+38.7%)
		Pixelate	STTran [7]	24.9	27.9	27.9	67.3	89.4	99.1	37.5	57.5	80.0	30.5	42.9	44.9
			+IMPARTAIL (Ours)	38.4 (+54.2%)	45.5 (+63.1%)	45.7 (+63.8%)	63.3 (-5.9%)	84.9 (-5.0%)	98.9 (-0.2%)	59.6 (+58.9%)	78.3 (+36.2%)	92.5 (+15.6%)	43.6 (+43.0%)	61.9 (+44.3%)	64.3 (+43.2%)
		Compression	STTran [7]	23.0	25.8	25.8	66.0	88.0	99.0	35.0	54.6	79.8	27.8	38.9	40.6
			+IMPARTAIL (Ours)	36.4 (+58.3%)	42.2 (+63.6%)	42.3 (+64.0%)	63.8 (-3.3%)	85.1 (-3.3%)	99.0 (0.0%)	54.9 (+56.9%)	75.8 (+38.8%)	92.4 (+15.8%)	41.0 (+47.5%)	58.6 (+50.6%)	61.7 (+52.0%)
		Sun Glare	STTran [7]	22.5	25.1	25.2	66.7	89.9	99.1	36.7	56.7	80.0	28.9	40.5	42.3
			+IMPARTAIL (Ours)	40.2 (+78.7%)	47.5 (+89.2%)	47.7 (+89.3%)	57.9 (-13.2%)	81.7 (-9.1%)	98.0 (-1.1%)	60.3 (+64.3%)	77.5 (+36.7%)	92.7 (+15.9%)	43.3 (+49.8%)	59.3 (+46.4%)	61.0 (+44.2%)

12.4. Robust Scene Graph Anticipation

12.4.1. Findings

Table 34, present the Robustness Evaluation Results for SGCLS for methods STTran+, DSGDetr+, STTran++, DSGDetr++ for Scene Graph Anticipation under various corruption scenarios. The results measure mR@10, mR@20, and mR@50, focusing on the impact of IMPARTAIL across different noise types. For Gaussian Noise, STTran++, mR@10 improves from 5.9 to 9.4 (+59.3%); for DSGDetr++, mR@20 improves from 5.7 to 8.8 (+44.4%). However, for STTran+ IMPARTAIL underperforms for all metrics. The same can be observed for Dust, Spatter, Frost and Impulse noises; for all other corruptions, IMPARTAIL outperforms existing methods with the highest increments seen for STTran++ with an average of 40% higher metrics.

12.4.2. Results

Table 34. Robustness Evaluation Results for SGA.

F	Mode	Corruption	Method	With Constraint						No Constraint					
				mR@10	mR@20	mR@50	mR@10	mR@20	mR@50	mR@10	mR@20	mR@50	mR@10	mR@20	mR@50
Gaussian	Noise	STTran+ [1]	13.2	13.5	13.5	7.9	8.4	8.4	22.1	27.2	28.7	13.1	18.9	25.7	
		+IMPARTAIL (Ours)	17.9 (40.2%)	21.1 (40.0%)	21.1 (40.0%)	11.3 (43.9%)	14.3 (50.0%)	14.3 (50.0%)	22.0 (20.0%)	22.0 (20.0%)	22.0 (20.0%)	13.7 (38.9%)	17.7 (38.9%)	19.1 (39.0%)	
		DSGDetr+ [1]	11.2 (10.9%)	11.4 (9.6%)	11.4 (9.6%)	7.5 (10.6%)	8.0 (10.7%)	8.0 (10.7%)	14.8 (12.0%)	20.1 (17.9%)	21.1 (15.3%)	8.7 (18.3%)	14.5 (40.5%)	21.6 (27.5%)	
		STTran++ [1]	8.2	8.5	8.5	5.2	5.6	5.6	15.2	21.4	22.6	15.2	19.9	22.6	
		+IMPARTAIL (Ours)	10.0 (1.0%)	10.3 (1.9%)	10.3 (1.9%)	9.4 (40.9%)	10.2 (40.6%)	10.2 (40.6%)	14.5 (4.0%)	20.1 (4.7%)	21.1 (1.9%)	11.4 (14.4%)	16.3 (47.3%)	23.0 (17.5%)	
		DSGDetr++ [1]	13.1	13.2	13.2	8.1	8.1	8.1	17.1	22.2	24.7	8.1	14.4	21.9	
	+IMPARTAIL (Ours)	12.1 (6.1%)	12.4 (6.7%)	12.4 (6.7%)	11.3 (45.0%)	11.6 (45.3%)	11.6 (45.3%)	15.1 (6.1%)	21.1 (6.9%)	21.1 (6.9%)	10.2 (10.5%)	15.0 (37.9%)	22.0 (35.0%)		
	Shot	STTran+ [1]	10.7	11.1	11.1	5.8	6.2	6.2	16.5	22.8	25.6	8.5	14.2	21.7	
		+IMPARTAIL (Ours)	9.4 (12.5%)	12.3 (11.8%)	12.3 (11.8%)	11.7 (73.5%)	14.6 (78.7%)	14.6 (78.7%)	15.0 (9.0%)	21.4 (5.7%)	21.4 (5.7%)	10.4 (19.5%)	16.0 (43.9%)	23.1 (44.4%)	
		DSGDetr+ [1]	10.4	10.8	10.8	6.6	7.2	7.2	15.2	21.8	24.8	7.9	14.0	21.1	
		STTran++ [1]	10.4 (0.0%)	10.7 (1.8%)	10.7 (1.8%)	9.3 (40.9%)	10.0 (38.9%)	10.0 (38.9%)	14.9 (4.1%)	20.6 (5.9%)	21.6 (6.0%)	11.4 (22.0%)	16.9 (43.9%)	23.1 (44.4%)	
		DSGDetr++ [1]	13.1	14.1	14.1	8.9	9.7	9.7	17.2	22.8	25.6	8.7	14.4	21.9	
+IMPARTAIL (Ours)		12.7 (7.7%)	13.1 (11.9%)	13.1 (11.9%)	11.6 (43.3%)	11.9 (43.3%)	11.9 (43.3%)	14.4 (13.3%)	22.1 (2.0%)	21.6 (4.0%)	10.3 (18.4%)	16.3 (41.9%)	24.1 (45.7%)		
Impulse	STTran+ [1]	9.7	10.2	10.2	5.1	5.6	5.6	14.8	20.0	22.1	7.6	13.4	21.4		
	+IMPARTAIL (Ours)	7.1 (26.8%)	7.2 (26.4%)	7.2 (26.4%)	4.7 (1.9%)	4.9 (12.9%)	4.9 (12.9%)	10.1 (26.2%)	13.9 (20.9%)	19.0 (10.0%)	6.1 (10.7%)	10.2 (27.9%)	17.4 (17.8%)		
	DSGDetr+ [1]	9.4 (6.9%)	9.7 (7.9%)	9.7 (7.9%)	6.1 (10.6%)	6.6 (17.9%)	6.6 (17.9%)	12.9 (12.2%)	17.1 (17.6%)	20.1 (14.0%)	8.1 (8.0%)	12.1 (4.7%)	19.1 (11.6%)		
	STTran++ [1]	9.8	10.0	10.0	5.9	6.3	6.3	15.4	20.8	22.8	8.5	14.1	21.0		
	+IMPARTAIL (Ours)	10.1 (1.0%)	10.3 (2.8%)	10.3 (2.8%)	8.1 (46.6%)	8.9 (41.3%)	8.9 (41.3%)	14.2 (13.0%)	19.1 (7.7%)	21.1 (1.5%)	10.4 (22.9%)	15.4 (40.2%)	21.4 (27.0%)		
	DSGDetr++ [1]	10.2 (0.8%)	12.4 (8.5%)	12.4 (8.5%)	7.4 (24.6%)	7.7 (25.2%)	7.7 (25.2%)	11.0 (11.0%)	20.1 (4.9%)	21.6 (3.8%)	8.1 (11.0%)	14.3 (47.4%)	21.0 (41.0%)		
Speckle	STTran+ [1]	11.4	11.9	11.9	6.4	7.5	7.5	17.7	24.7	27.6	10.2	17.0	23.8		
	+IMPARTAIL (Ours)	11.1 (4.4%)	11.4 (4.4%)	11.4 (4.4%)	7.8 (20.9%)	7.8 (20.9%)	7.8 (20.9%)	14.6 (11.5%)	21.1 (2.1%)	21.6 (6.0%)	9.2 (8.0%)	15.1 (7.0%)	21.0 (10.4%)		
	DSGDetr+ [1]	12.5	13.2	13.2	7.1	7.8	7.8	18.8	26.8	30.2	10.6	17.5	26.1		
	STTran++ [1]	12.6 (4.8%)	13.5 (5.3%)	13.5 (5.3%)	9.7 (6.6%)	10.4 (13.3%)	10.4 (13.3%)	11.1 (13.7%)	24.6 (8.2%)	29.1 (4.9%)	12.6 (10.9%)	19.3 (10.7%)	28.0 (20.0%)		
	DSGDetr++ [1]	12.1	12.7	12.7	7.9	8.7	8.7	19.4	26.8	29.7	11.9	17.9	26.3		
	+IMPARTAIL (Ours)	12.3 (0.0%)	12.5 (1.6%)	12.5 (1.6%)	10.5 (38.2%)	11.3 (38.1%)	11.3 (38.1%)	17.1 (9.0%)	23.4 (10.0%)	27.1 (4.5%)	12.8 (14.5%)	19.1 (46.5%)	27.7 (21.2%)		
Gaussian	STTran+ [1]	8.4	8.8	8.8	4.9	5.3	5.3	14.4	19.8	21.9	7.9	12.9	20.2		
	+IMPARTAIL (Ours)	11.7 (14.9%)	14.2 (16.0%)	14.2 (16.0%)	11.3 (48.0%)	11.3 (48.0%)	11.3 (48.0%)	11.1 (8.1%)	20.1 (16.0%)	20.1 (16.0%)	12.9 (6.1%)	21.0 (41.7%)	30.1 (50.0%)		
	DSGDetr+ [1]	10.1	20.2	20.2	11.1	12.4	12.4	24.1	39.8	44.8	14.4	26.2	40.8		
	STTran++ [1]	10.6 (2.0%)	20.2 (9.0%)	20.2 (9.0%)	14.4 (29.7%)	16.4 (25.8%)	16.4 (25.8%)	23.1 (9.9%)	33.1 (11.7%)	42.4 (4.9%)	18.1 (10.9%)	27.1 (45.7%)	41.7 (47.7%)		
	DSGDetr++ [1]	10.9	15.9	15.9	11.1	12.3	12.3	20.4	30.4	36.6	8.4	24.5	31.8		
	+IMPARTAIL (Ours)	17.4 (12.4%)	17.4 (9.8%)	17.4 (9.8%)	14.8 (45.6%)	14.8 (45.6%)	14.8 (45.6%)	21.9 (4.1%)	32.1 (6.9%)	37.7 (2.2%)	18.2 (13.9%)	24.6 (42.2%)	38.1 (39.1%)		
Defocus	STTran+ [1]	8.0	8.8	8.8	4.8	5.6	5.6	13.8	19.4	21.9	7.6	12.4	20.4		
	+IMPARTAIL (Ours)	11.7 (46.9%)	14.2 (16.0%)	14.2 (16.0%)	11.3 (46.9%)	11.3 (46.9%)	11.3 (46.9%)	11.1 (8.1%)	20.1 (16.0%)	20.1 (16.0%)	12.9 (16.5%)	21.0 (41.7%)	30.1 (50.0%)		
	DSGDetr+ [1]	10.1	20.2	20.2	11.1	12.4	12.4	24.1	39.8	44.8	14.4	26.2	40.8		
	STTran++ [1]	10.9 (2.0%)	20.2 (9.0%)	20.2 (9.0%)	14.4 (29.7%)	16.4 (25.8%)	16.4 (25.8%)	23.1 (9.9%)	33.1 (11.7%)	42.4 (4.9%)	18.1 (10.9%)	27.1 (45.7%)	41.7 (47.7%)		
	DSGDetr++ [1]	10.9	15.9	15.9	11.1	12.3	12.3	20.4	30.4	36.6	8.4	24.5	31.8		
	+IMPARTAIL (Ours)	17.4 (12.4%)	17.4 (9.8%)	17.4 (9.8%)	14.8 (45.6%)	14.8 (45.6%)	14.8 (45.6%)	21.9 (4.1%)	32.1 (6.9%)	37.7 (2.2%)	18.2 (13.9%)	24.6 (42.2%)	38.1 (39.1%)		
Fog	STTran+ [1]	8.0	8.8	8.8	4.8	5.6	5.6	13.8	19.4	21.9	7.6	12.4	20.4		
	+IMPARTAIL (Ours)	11.7 (46.9%)	14.2 (16.0%)	14.2 (16.0%)	11.3 (46.9%)	11.3 (46.9%)	11.3 (46.9%)	11.1 (8.1%)	20.1 (16.0%)	20.1 (16.0%)	12.9 (16.5%)	21.0 (41.7%)	30.1 (50.0%)		
	DSGDetr+ [1]	10.1	20.2	20.2	11.1	12.4	12.4	24.1	39.8	44.8	14.4	26.2	40.8		
	STTran++ [1]	10.6 (2.0%)	20.2 (9.0%)	20.2 (9.0%)	14.4 (29.7%)	16.4 (25.8%)	16.4 (25.8%)	23.1 (9.9%)	33.1 (11.7%)	42.4 (4.9%)	18.1 (10.9%)	27.1 (45.7%)	41.7 (47.7%)		
	DSGDetr++ [1]	10.9	15.9	15.9	11.1	12.3	12.3	20.4	30.4	36.6	8.4	24.5	31.8		
	+IMPARTAIL (Ours)	17.4 (12.4%)	17.4 (9.8%)	17.4 (9.8%)	14.8 (45.6%)	14.8 (45.6%)	14.8 (45.6%)	21.9 (4.1%)	32.1 (6.9%)	37.7 (2.2%)	18.2 (13.9%)	24.6 (42.2%)	38.1 (39.1%)		
Snow	STTran+ [1]	8.0	8.8	8.8	4.8	5.6	5.6	13.8	19.4	21.9	7.6	12.4	20.4		
	+IMPARTAIL (Ours)	11.7 (46.9%)	14.2 (16.0%)	14.2 (16.0%)	11.3 (46.9%)	11.3 (46.9%)	11.3 (46.9%)	11.1 (8.1%)	20.1 (16.0%)	20.1 (16.0%)	12.9 (16.5%)	21.0 (41.7%)	30.1 (50.0%)		
	DSGDetr+ [1]	10.1	20.2	20.2	11.1	12.4	12.4	24.1	39.8	44.8	14.4	26.2	40.8		
	STTran++ [1]	10.6 (2.0%)	20.2 (9.0%)	20.2 (9.0%)	14.4 (29.7%)	16.4 (25.8%)	16.4 (25.8%)	23.1 (9.9%)	33.1 (11.7%)	42.4 (4.9%)	18.1 (10.9%)	27.1 (45.7%)	41.7 (47.7%)		
	DSGDetr++ [1]	10.9	15.9	15.9	11.1	12.3	12.3	20.4	30.4	36.6	8.4	24.5	31.8		
	+IMPARTAIL (Ours)	17.4 (12.4%)	17.4 (9.8%)	17.4 (9.8%)	14.8 (45.6%)	14.8 (45.6%)	14.8 (45.6%)	21.9 (4.1%)	32.1 (6.9%)	37.7 (2.2%)	18.2 (13.9%)	24.6 (42.2%)	38.1 (39.1%)		
Dust	STTran+ [1]	8.0	8.8	8.8	4.8	5.6	5.6	13.8	19.4	21.9	7.6	12.4	20.4		
	+IMPARTAIL (Ours)	11.7 (46.9%)	14.2 (16.0%)	14.2 (16.0%)	11.3 (46.9%)	11.3 (46.9%)	11.3 (46.9%)	11.1 (8.1%)	20.1 (16.0%)	20.1 (16.0%)	12.9 (16.5%)	21.0 (41.7%)	30.1 (50.0%)		
	DSGDetr+ [1]	10.1	20.2	20.2	11.1	12.4	12.4	24.1	39.8	44.8	14.4	26.2	40.8		
	STTran++ [1]	10.6 (2.0%)	20.2 (9.0%)	20.2 (9.0%)	14.4 (29.7%)	16.4 (25.8%)	16.4 (25.8%)	23.1 (9.9%)	33.1 (11.7%)	42.4 (4.9%)	18.1 (10.9%)	27.1 (45.7%)	41.7 (47.7%)		
	DSGDetr++ [1]	10.9	15.9	15.9	11.1	12.3	12.3	20.4	30.4	36.6	8.4	24.5	31.8		
	+IMPARTAIL (Ours)	17.4 (12.4%)	17.4 (9.8%)	17.4 (9.8%)	14.8 (45.6%)	14.8 (45.6%)	14.8 (45.6%)	21.9 (4.1%)	32.1 (6.9%)	37.7 (2.2%)	18.2 (13.9%)	24.6 (42.2%)	38.1 (39.1%)		
Spatter	STTran+ [1]	8.0	8.8	8.8	4.8	5.6	5.6	13.8	19.4	21.9	7.6	12.4	20.4		
	+IMPARTAIL (Ours)	11.7 (46.9%)	14.2 (16.0%)	14.2 (16.0%)	11.3 (46.9%)	11.3 (46.9%)	11.3 (46.9%)	11.1 (8.1%)	20.1 (16.0%)	20.1 (16.0%)	12.9 (16.5%)	21.0 (41.7%)	30.1 (50.0%)		
	DSGDetr+ [1]	10.1	20.2	20.2	11.1	12.4	12.4	24.1	39.8	44.8	14.4	26.2	40.8		
	STTran++ [1]	10.6 (2.0%)	20.2 (9.0%)	20.2 (9.0%)	14.4 (29.7%)	16.4 (25.8%)	16.4 (25.8%)	23.1 (9.9%)	33.1 (11.7%)	42.4 (4.9%)	18.1 (10.9%)	27.1 (45.7%)	41.7 (47.7%)		
	DSGDetr++ [1]	10.9	15.9	15.9	11.1	12.3	12.3	20.4	30.4	36.6	8.4	24.5	31.8		
	+IMPARTAIL (Ours)	17.4 (12.4%)	17.4 (9.8%)	17.4 (9.8%)	14.8 (45.6%)	14.8 (45.6%)	14.8 (45.6%)	21.9 (4.1%)	32.1 (6.9%)	37.7 (2.2%)	18.2 (13.9%)	24.6 (42.2%)	38.1 (39.1%)		
Frost	STTran+ [1]	8.0	8.8	8.8	4.8	5.6	5.6	13.8	19.4	21.9	7.6	12.4	20.4		
	+IMPARTAIL (Ours)	11.7 (46.9%)	14.2 (16.0%)	14.2 (16.0%)	11.3 (46.9%)	11.3 (46.9%)	11.3 (46.9%)	11.1 (8.1%)	20.1 (16.0%)	20.1 (16.0%)	12.9 (16.5%)	21.0 (41.7%)	30.1 (50.0%)		
	DSGDetr+ [1]	10.1	20.2	20.2	11.1	12.4	12.4	24.1	39.8	44.8	14.4	26.2	40.8		
	STTran++ [1]	10.6 (2.0%)	20.2 (9.0%)	20.2 (9.0%)	14.4 (29.7%)	16.4 (25.8%)	16.4 (25.8%)	23.1 (9.9%)	33.1 (11.7%)	42.4 (4.9%)	18.1 (10.9%)	27.1 (45.7%)	41.7 (47.7%)		
	DSGDetr++ [1]	10.9	15.9	15.9	11.1	12.3	12.3	20.4	30.4	36.6	8.4	24.5	31.8		
	+IMPARTAIL (Ours)	17.4 (12.4%)	17.4 (9.8%)	17.4 (9.8%)	14.8 (45.6%)	14.8 (45.6%)	14.8 (45.6%)	21.9 (4.1%)	32.1 (6.9%)	37.7 (2.2%)	18.2 (13.9%)	24.6 (42.2%)	38.		