

Monotone Contractions

Eleni Batziou¹, John Fearnley¹, Spencer Gordon¹, Ruta Mehta², and Rahul Savani^{1,3}

¹University of Liverpool, {eleni.batziou, john.fearnley, rahul.savani}@liverpool.ac.uk

²University of Illinois at Urbana-Champaign, rutamehta@cs.illinois.edu

³Alan Turing Institute

November 18, 2024

Abstract

We study functions $f : [0, 1]^d \rightarrow [0, 1]^d$ that are both monotone and contracting, and we consider the problem of finding an ε -approximate fixed point of f . We show that the problem lies in the complexity class UEOPL. We give an algorithm that finds an ε -approximate fixed point of a three-dimensional monotone contraction using $O(\log(1/\varepsilon))$ queries to f . We also give a decomposition theorem that allows us to use this result to obtain an algorithm that finds an ε -approximate fixed point of a d -dimensional monotone contraction using $O((c \cdot \log(1/\varepsilon))^{\lceil d/3 \rceil})$ queries to f for some constant c . Moreover, each step of both of our algorithms takes time that is polynomial in the representation of f . These results are strictly better than the best-known results for functions that are only monotone, or only contracting.

All of our results also apply to Shapley stochastic games, which are known to be reducible to the monotone contraction problem. Thus we put Shapley games in UEOPL, and we give a faster algorithm for approximating the value of a Shapley game.

Contents

1	Introduction	3
2	MonotoneContraction and DMAC: Problem Definitions	6
3	Technical Overview	6
3.1	UEOPL containment of DMAC	7
3.2	Algorithmic Results for DMAC	8
4	Reducing MonotoneContraction to DMAC	16
4.1	Creating a DMAC instance	16
4.2	Mapping solutions back	17
5	DMAC is in UEOPL	19
5.1	DMAC with Unit Displacements	20
5.2	Verifiable Least Fixed Points	21
5.3	Reducing DMAC to OPDC	25
6	1DUniqueDMAC and Surfaces	33
6.1	Reducing DMAC to 1DUniqueDMAC	33
6.2	Surfaces	36
6.3	Forcing Boundary Points to Move Inward	38
7	A Decomposition Theorem	39
7.1	A Decomposition Theorem for LFP-solving DMAC	39
7.2	All 3D DMAC Algorithms Can LFP-Solve	41
8	An Algorithm for 3-dimensional DMAC	46
8.1	Preprocessing	46
8.2	Critical Boxes	47
8.3	Almost Square Critical Boxes	52
8.4	The States of the Algorithm	56
8.5	Algorithms for Left and Bottom Lobe States	58
8.6	The Algorithm for Diagonal States	61
8.7	The Algorithm for Full States	66
8.8	Moving Between Slices	71
8.9	The Main Algorithm	74
8.10	The Two-Slice Sub-Algorithm	76
8.11	The Terminal Phase	77
8.12	The Result	85

1 Introduction

In this paper we study monotone contractions. These are functions $f : [0, 1]^d \rightarrow [0, 1]^d$ that are simultaneously *monotone*, meaning that $f(x) \leq f(y)$ whenever $x \leq y$, and *contracting* in the ℓ_∞ -norm, meaning that $\|f(x) - f(y)\|_\infty \leq \lambda \cdot \|x - y\|_\infty$ for some $\lambda \in [0, 1)$.

Every function f that is a monotone contraction has a fixed point, which is a point x such that $x = f(x)$. This can be proved in two different ways. Tarski's fixed point theorem (also known as the Knaster-Tarski theorem), shows that any monotone function has a fixed point [26], and moreover the set of fixed points of a monotone function forms a complete lattice. Banach's fixed point theorem states that any contraction map has a *unique* fixed point [1]. Both of these theorems apply to a monotone contraction, so a monotone contraction also has a unique fixed point.

We are interested in the problem of finding a fixed point of a monotone contraction. Unfortunately however, there exist monotone contractions in which the unique fixed point has irrational coordinates [21]. So instead, we study the problem of finding an *approximate* fixed point of a monotone contraction f , which means that we seek a point x such that $\|x - f(x)\|_\infty \leq \varepsilon$ for a given approximation parameter ε .

While the combination of monotonicity and contraction may seem artificial at first, there are in fact important problems that naturally reduce to the problem of finding an approximate fixed point of a monotone contraction. Specifically, the problem of approximating the value of a Shapley stochastic game, and the problem of solving a simple-stochastic game can both be formulated as the problem of finding an approximate fixed point of a function that is both monotone and contracting in the ℓ_∞ -norm [9].

Shapley games. We are particularly interested in Shapley games in this paper, because the current best known algorithms for approximating the value of a Shapley game arise from the fact that they can be formulated as a monotone function, while ignoring the fact that the function is also contracting.

Shapley stochastic games [21] are a fundamental two-player zero-sum game model with both sequential and concurrent play. They have a central role in the Game Theory literature, see e.g. [25], as well as in the Computer Science literature where they are a model of formal verification of reactive systems with concurrency [19]. The computational complexity of approximating the value of a Shapley stochastic game was shown by Etessami and Yannakakis [10] to be in PPAD¹. It has more recently been observed that the problem also lies in PLS [9], which we now know means that the problem lies in CLS, since $\text{CLS} = \text{PPAD} \cap \text{PLS}$ [11]. Hansen et al. [16, 17] provided exponential time algorithms for solving Shapley games exactly.² Those results have been improved by Oliu-Barton [20].

The best known algorithm for finding an ε -approximation of the value of a Shapley game G with d states is $O((c \cdot \log(1/\varepsilon))^{\lceil d/2 \rceil + 1} \cdot \text{poly}(|G|))$, where c is some constant, and $|G|$ is the size of the representation of G . This result arises from applying the current best-known algorithm for monotone functions [3] to the monotone contraction that is defined by the game [9].

Monotone functions. There has recently been considerable research interest in the computational complexity of finding a fixed point of a monotone function. This work has focused on monotone functions $f : G \rightarrow G$ on the grid-lattice $G = \{1, 2, \dots, n\}^d$.

Dang et al. [6] provided an algorithm that finds a fixed point using $\log^d n$ queries to f . Etessami et al. [9] placed the problem in the complexity classes PPAD and PLS, which also implies that the problem lies in CLS [11]. They also showed that $\Omega(\log^2 N)$ queries are necessary for two-dimensional instances, thus showing that the algorithm of Dang et al. is tight in two-dimensions.

Both Dang et al. and Etessami et al. conjectured that the $\log^d n$ -query algorithm was tight for all dimensions d . However, Fearnley et al. disproved this by providing an algorithm that needs only $O(\log^2 N)$ queries in dimension three [15]. They also introduced a *decomposition theorem*, which showed that if the problem can be solved using q_1 queries in dimension d_1 , and q_2 queries in dimension d_2 , then it can be solved using $q_1 \cdot q_2$ queries in dimension $d_1 + d_2$. Applying this decomposition theorem to their three-dimensional algorithm gives an algorithm that solves d dimensional instances in $O((c \cdot \log n)^{2 \lceil d/3 \rceil})$ queries³, for some constant c .

¹They also showed that the problem of finding an exact solution is in FIXP, but our focus in this paper is on approximate solutions.

²Here solutions may be irrational and the task is to find a symbolic representation of the optimal strategies as algebraic numbers.

³We note that [15] claim that the algorithm uses $O(\log^{2 \lceil d/3 \rceil} n)$ queries, but this is not quite correct. They apply the decomposition theorem to an algorithm that uses $O(\log^2 n)$ queries to solve a three-dimensional instance, and when they do so, the constant that was hidden by the big-oh notation also gets powered by $2 \lceil d/3 \rceil$. This is a relatively minor distinction, however, since $c \cdot \log x = \log_{c'} x$ for some constant c' .

The current best-known algorithm for monotone functions was given by Chen et al. [3]. Internally, the algorithm of Fearnley et al. works by solving a relaxed problem for two-dimensional instances, and Chen et al. [3] call this problem TARSKI*. They gave a decomposition theorem for TARSKI*, and applying this to the original algorithm of Fearnley et al. gives an algorithm that solves the problem using $O((c \cdot \log n)^{\lceil d/2 \rceil + 1})$ queries, for some constant c .

Recently, Chen et al [4] showed that the query complexity of finding Tarski fixed points is the same as the query complexity of finding fixed points when the Tarski instance is promised to have a unique solution, and it is also promised that all sub-instances have unique solutions.

Contracting functions. There has also been considerable interest in the problem of finding the fixed point of a contracting function. Our focus in this paper is on functions that are contracting with respect to the infinity norm, since it is this type of contraction that arises from Shapley and Simple stochastic games [9]. As mentioned previously, there are infinity norm contraction maps whose fixed point uses irrational numbers, so the focus has been on finding an ε -approximate fixed point of a contraction map $f : [0, 1]^d \rightarrow [0, 1]^d$.

The problem naturally lies in PPAD, because it is a special case of finding a Brouwer fixed point, and also PLS, because $\|x - f(x)\|_\infty$ gives a natural potential function for the problem. The problem therefore lies in CLS [7, 11].

Fearnley et al. [14] studied contractions defined by piecewise linear arithmetic circuits (PL-contraction), which capture the problem of simple stochastic games, but not Shapley games. They showed that finding an exact fixed point of a PL-contraction lies in the complexity class UEOPL, which is a subclass of CLS that contains problems that have unique solutions. It remains open whether the contraction problem itself lies in UEOPL.

Shellman and Sikorski proved that the query complexity of finding an ε -fixed point of a contraction map in dimension two is $\log(\frac{1}{\varepsilon})$ [22], and used this as part of a recursive algorithm in higher dimensions [23].

In a striking recent result, Chen et al. [5] showed that the query complexity of finding an ε -fixed-point of a contraction map under the infinity norm is actually $O(d^2 \log(\frac{1}{\varepsilon}))$, so the query complexity of contraction is polynomial in d . However this result does come with a drawback: the time complexity of the algorithm is not polynomial, meaning that although the algorithm makes polynomially many queries, it may spend exponential time in between each of those queries.

While our focus here is on the ℓ_∞ -norm, due to the importance of this setting for game theory, we note that finding fixed points of contractions or non-expansions under other norms has also received considerable attention. Sikorski provides a survey of results for both the ℓ_∞ and ℓ_2 (Euclidean) norms in [24]. In the Euclidean norm, it is known that a fixed point of a contraction or non-expansion can be found in polynomial time even in non-constant dimension using algorithms based on the ellipsoid method [2, 18]. Fearnley et al. [13] gave a polynomial-time algorithm for finding an approximate fixed point of any contraction in the ℓ_p -norm with $p < \infty$ in any constant dimension.

The problem of finding an approximate fixed point of a contracting function has also been studied in the case where the function is contracting not with respect to the metric induced by a fixed norm, but where a metric or meta-metric is itself input to the problem. In those cases the problem is known to be CLS-complete [8, 12].

Our contribution. While both monotone and contracting functions have received a considerable amount of attention recently, monotone contractions have not yet been studied at all. This paper provides complexity results and algorithms for monotone contractions (for the ℓ_∞ -norm), and in doing so we improve the best-known results for approximating the value of a Shapley stochastic game.

Our main results can be stated as follows.

1. Finding an approximate fixed point of a monotone contraction lies in UEOPL.
2. There is an algorithm that finds an ε -approximate fixed point of a three-dimensional monotone contraction f using $O(\log(1/\varepsilon))$ queries to f , where each step runs in time that is polynomial in the representation of f .
3. There is an algorithm that finds an ε -approximate fixed point of a d -dimensional monotone contraction f using $O((c \cdot \log(1/\varepsilon))^{\lceil d/3 \rceil})$ queries to f , where each step runs in time that is polynomial in the representation of f .

Since Shapley stochastic games can be formulated as monotone contractions for the ℓ_∞ -norm, these results apply to Shapley games as well. So we place the problem of approximating the value of a Shapley game in UEOP, which was not previously known, and we also provide an algorithm that finds an ε -approximation of the value of a game G that has d states in time $O((c \cdot \log(1/\varepsilon))^{\lceil d/3 \rceil} \cdot \text{poly}(|G|))$, which is faster than the previous best algorithm.

The main theme of our results is that functions that are monotone and contracting appear to be easier than functions that are just monotone, or just contracting. From a complexity point of view we show that monotone contractions lie in UEOP, which is not known for only-monotone functions, and it is not known for only-contracting functions, except for the special case of PL-contraction. Our algorithm for monotone contractions is also faster than the best known algorithm for only-monotone functions, with the exponent decreasing from $\lceil d/2 \rceil + 1$ to $\lceil d/3 \rceil$, where for comparisons sake, if we applied the algorithms for monotone functions in a continuous setting, we would set $n = O(1/\varepsilon)$.

We do not beat the query complexity of the best-known algorithm for contraction under the infinity norm, because, as mentioned, Chen et al. [5] gave a $O(d^2 \log(\frac{1}{\varepsilon}))$ -query algorithm for the problem. However, their algorithm does not run in polynomial time. In fact, to the best of our knowledge there is no known polynomial-time algorithm for approximating the contraction problem in the ℓ_∞ -norm in any dimension higher than 2. Our result shows that if the function is also monotone, then we can solve the problem in polynomial time for any constant dimension.

Techniques. We show many interesting properties of monotone contractions on the way to proving our main results.

The first step that we take is to discretize the problem. We define the *discrete monotone approximate contraction* (DMAC) problem, which, like monotone functions, is defined by a function $f : G \rightarrow G$ over the discrete grid $G = \{1, 2, \dots, n\}^d$. The DMAC problem asks us to either find a fixed point of f , or a violation of monotonicity of f , or a strict violation of contraction (or more precisely, a violation of non-expansion) in f . So DMAC is a discrete problem that naturally captures both monotonicity and contraction. We show that ε approximating a d -dimensional monotone contraction reduces to d -dimensional DMAC with $n = O(1/\varepsilon)$.

We then show that DMAC can be placed in UEOP. Here the main challenge is that problems in UEOP are required to have a unique solution, while DMAC instances can have many fixed points, each of which can intuitively be mapped back to an approximate fixed point of a monotone contraction. However, we can use monotonicity to overcome this, because Tarski's theorem states that every monotone function has a least fixed point, so we can select this to be our unique solution.

We show that given a fixed point of a DMAC instance, we can verify in polynomial time whether it is a least fixed point. This is another distinction between monotone functions and monotone contractions, because Etessami et al. [9] have shown that verifying whether a fixed point is the least fixed point of a monotone function is NP-complete, even in one-dimensional instances. We circumvent this by using the extra contraction properties of a monotone contraction in our verification algorithm.

We then use this verification algorithm to implement a reduction from DMAC to the OPDC problem, which is known to lie in UEOP [14]. This reduction also handles violations, and all violations of the DMAC instance are mapped on to violation in the OPDC instance. This means that we have a promise-preserving reduction, as defined in [14].

We then prove that a decomposition theorem can be shown for monotone contractions, similar to the decomposition theorems that have been shown for monotone functions. But this comes with a catch: our decomposition theorem only works for algorithms that find the least fixed point of the DMAC instance, rather than just any fixed point. This has the potential to be problematic, because our algorithm for three-dimensional instances does not guarantee that it finds a least fixed point.

We are able to overcome this by showing that given a DMAC instance f , we can produce a DMAC instance f' in time that is polynomial in the representation of f such that f' has a unique fixed point, and that fixed point can be mapped back to the least fixed point of f . Thus, if we apply any DMAC algorithm to f' , we can recover the least fixed point of f .

Finally, we give an algorithm that solves a three-dimensional DMAC instance f in $O(\log n)$ queries and each step runs in time that is polynomial in the representation of f . This is another distinction between monotone functions and monotone contractions. For monotone functions, the query complexity of finding a fixed point of a three-dimensional instance is $\Theta(\log^2 n)$ [9, 15], but we show that if the function is also contracting then this can be improved to $O(\log n)$. The algorithm is by far the most technically complex part of the paper, and we give a full overview of the ideas used in it in Section 3. This algorithm combined with our decomposition theorem then gives us our two main algorithmic results stated above.

2 MonotoneContraction and DMAC: Problem Definitions

In this paper, we study the following problem.

Definition 1 (MonotoneContraction). Given $g : [0, 1]^d \rightarrow [0, 1]^d$ represented as a polynomial-time Turing machine, and constants $\lambda \in [0, 1)$ and $\varepsilon \in (0, 1)$, find one of the following.

- (M1) An ε -approximate fixed point, i.e., x such that $\|g(x) - x\|_\infty \leq \varepsilon$. [Approximate fixed point]
- (MV1) A pair of points x, y such that $x \leq y$ but $g(x) \not\leq g(y)$. [Monotonicity violation]
- (MV2) A pair of points x, y such that $\|g(x) - g(y)\|_\infty > \lambda \|x - y\|_\infty$. [Contraction violation]

Solutions of type (M1) are the approximate fixed points of g . Note, however, that given a function g , there is no easy way to determine whether g is monotone or contracting. Instead, we define the problem for all functions g , and we allow the algorithm to return a *violation solution* if a violation of monotonicity (MV1) or a violation of contraction (MV2) is detected. This ensures that the problem is *total*, meaning it always has a solution.

The first step towards showing our results will be to discretize the problem. Specifically, we will show that MonotoneContraction can be reduced in polynomial time to the following problem.

Definition 2 (Discrete Monotone Approximate Contraction (DMAC)). Let $G = \{1, 2, \dots, n\}^d$ be a d -dimensional grid on length n . Given a function $f : G \rightarrow G$ represented by a polynomial-time Turing machine, find one of the following.

- (D1) A point $x \in G$ such that $f(x) = x$. [Fixed point]
- (DV1) A pair of points $x, y \in G$ such that $x \leq y$ but $f(x) \not\leq f(y)$. [Monotonicity violation]
- (DV2) A pair of points $x, y \in G$ such that $\|f(x) - f(y)\|_\infty > \|x - y\|_\infty$. [Non-expansion violation]

Solutions of type (D1) encode fixed points of f , which under our reduction from MonotoneContraction will correspond to approximate fixed points of g . Violations of type (DV1) encode violations of monotonicity in f , while violations of type (DV2) encode pairs of points at which f is *strictly* non-contracting, i.e., expanding. Because non-expansion is allowed in DMAC, unlike in MonotoneContraction, there is no λ in the violations of type (DV2).

3 Technical Overview

In this section we give a high-level overview of our results and the techniques used to prove them. Full technical details can be found in subsequent sections.

Our results focus on the DMAC problem, for which we provide a UEOPL containment result and algorithms. The first step is to show that ε -approximating a MonotoneContraction $g : [0, 1]^d \rightarrow [0, 1]^d$ can be reduced to DMAC instance $f : \{1, 2, \dots, n\}^d \rightarrow \{1, 2, \dots, n\}^d$ where $n = O(1/\varepsilon)$. For this, we first discretize the space $[0, 1]^d$ using a grid of length $n = O(1/\varepsilon)$. Then for each point x in the grid and each dimension i , we inspect the displacement $g_i(x) - x_i$:

- If $|g_i(x) - x_i| < \varepsilon$ then we set $f_i(x) = x_i$.
- If $g_i(x) \leq x_i - \varepsilon$ then we set $f_i(x) = x_i - 1/n$.
- If $g_i(x) \geq x_i + \varepsilon$ then we set $f_i(x) = x_i + 1/n$.

In other words, if the displacement of g in dimension i is at least ε , then we round the displacement in that dimension down to the nearest adjacent grid point of G , while if the displacement of g in dimension i is strictly smaller than ε , we round the displacement in that dimension down to zero.

It is clear that any fixed point of f is an ε -approximate fixed point of g by construction. We also show in Section 4 that any DMAC violation for f can be mapped back to a MonotoneContraction violation in g .

3.1 UEOPL containment of DMAC

Our first main result is to show that DMAC is contained in the complexity class UEOPL. The main barrier to showing this is that DMAC captures the approximate fixed points of a monotone contraction map, and while Banach’s theorem ensures that there is always a unique exact fixed point of a contraction map, there can be many approximate fixed points. UEOPL captures problems that have unique solutions, so to show that DMAC is contained in it, we need some way of declaring one of the approximate fixed points to be the unique solution.

To do this, we use the fact that the instance is also monotone. This means that Tarski’s theorem ensures that there is a *least* approximate fixed point, which is unique. However, for monotone functions, it is known that verifying whether a fixed point is the least fixed point is NP-hard, even in one-dimensional instances [9]. Fortunately, monotone contraction maps have extra properties that allow us to circumvent this and efficiently verify least approximate fixed points.

Verifiable least fixed points. We show the following property: if x is a fixed point in a DMAC instance that is not a least fixed point, then there exists a fixed point y that is below x and at ℓ_∞ distance 1 from it, i.e., $y \leq x$ and $\|x - y\|_\infty = 1$. This gives us a relatively straightforward way of testing whether a given fixed point x is a least fixed point:

- Start at the point $y = x - \mathbf{1}$.
- If y is a fixed point then x is not a least fixed point.
- Otherwise, there is some dimension i such that $y_i \neq f_i(y)$. If $y_i > f_i(y)$ then we have a strict violation of contraction with x . If $y_i < f_i(y)$ then monotonicity implies that all points $z \geq y$ with $z_i = y_i$ should also satisfy $z_i < f_i(z)$, so none of them are fixed. Hence we can eliminate all such points, and repeat the process from $y' = x - \mathbf{1} + e_i$.

This process rules out one dimension in each step, so after d steps we have either found a fixed point less than x , or we have verified that x is the least fixed point. We call the path of points visited by this process the *verification sequence* of x .

This property allows us to use the least fixed point as the unique solution. However, to reduce to OPDC, we also need to be able to find unique solutions in each *slice* of the instance, where a slice of a DMAC instance is a sub-instance in which some of the coordinates have been fixed. We show that the least fixed point of the slice can be used for this, and the correctness of this crucially relies on the fact that least fixed points in DMAC instances are *hereditary* in the following sense: we show that if x is the least fixed point of a slice s , and s' is a sub-slice of s in which one or more dimensions of s have been fixed, then x is also a least fixed point of s' .

These properties are sufficient to show a reduction from promise DMAC to the promise version of UEOPL, where in both cases the promise is that neither instance contains a violation.

Handling violations. However, to show UEOPL containment for DMAC, we must also handle instances that contain violations. In particular, we show a *promise-preserving* reduction from DMAC to OPDC (which is in UEOPL). This means that all violations of the DMAC instance must be mapped onto a violation of the OPDC instance.

Note that the correctness of our verification algorithm relied on both contraction and monotonicity, so when we consider an instance that contains violations, it is possible that our algorithm might falsely declare x to be a least fixed point when it is in fact not. This will lead to violations in our OPDC instance caused by two distinct fixed points x and y , both of which have purportedly been verified to be the least fixed point by our verification algorithm. In this case, we show that a DMAC violation can be found by inspecting the verification sequences of x and y , and making at most polynomially many extra queries. This allows us to map any OPDC violation back to a DMAC violation in polynomial time.

Paths of fixed points. Before moving on, we note one interesting property of monotone contraction maps that arises from our reduction that will turn out to be useful later. Our verification algorithm used the fact that if x is not a least fixed point, then there is a fixed point $y \leq x$ with $\|x - y\|_\infty = 1$. Flipping all dimensions of the instance and applying the same reasoning implies that if x is not a greatest fixed point, then there is a fixed point $y \geq x$ with $\|x - y\|_\infty = 1$. If l and g are the least and greatest fixed points, respectively, then for any fixed point x , we can repeatedly apply these properties to generate

- a path of fixed points $l = p^1, p^2, \dots, p^k = x$ with $p^i \leq p^{i+1}$ and $\|p^i - p^{i+1}\|_\infty = 1$, and
- a path of fixed points $x = p^1, p^2, \dots, p^k = g$ with $p^i \leq p^{i+1}$ and $\|p^i - p^{i+1}\|_\infty = 1$.

In particular, this means that there is such a path of fixed points from the least fixed point to the greatest fixed point. We will use this fact crucially in the terminal phase of our algorithm.

3.2 Algorithmic Results for DMAC

Our two other main results give an algorithms for finding a fixed point of a DMAC instance, and for our algorithms we restrict ourselves to DMAC instances that are promised to be violation-free. We restrict ourselves to the promise problem here for two reasons. Firstly, the algorithms are already very complex, and finding violations in each of the steps would make the algorithms even more complex. Secondly, we envision that the algorithm would mainly be applied to DMAC instances that arise from problems that are known up front to be monotone and contracting, such as Shapley games. If the algorithm is applied to a function that has violations, then it may find a fixed point, or it may crash. If the algorithm does crash, then the user can be certain that the function has violations, and the only downside is that the algorithm will not actually produce an explicit violation.

3.2.1 1DUniqueDMAC and Surfaces

Before we describe the algorithm, we first introduce some useful concepts that we will use repeatedly.

1DUniqueDMAC. We introduce a restriction on DMAC instances that we call 1DUniqueDMAC. This restriction requires that a DMAC instance $f : G \rightarrow G$ satisfies the following properties.

- The instance has displacements that are at most unit length in the ℓ_∞ -norm. That is, we require that $\|x - f(x)\|_\infty \leq 1$ for all $x \in G$.
- Every one-dimensional slice of the instance has a unique one-dimensional fixed point. That is, if $x_i = f_i(x)$ for some dimension i , then for all c we have that $x_i + c \neq f_i(x + c \cdot e_i)$.

The first property is a technical requirement that simplifies our proofs. In fact we already show that this property can be assumed without loss of generality when we present our UEOPPL reduction, because we give a polynomial-time reduction that transforms an arbitrary DMAC instance f into a DMAC instance f' with $\|x - f'(x)\|_\infty \leq 1$ for all x .

The second property is the more important one, and it is what gives the name to the 1DUniqueDMAC problem. We show that a DMAC instance f can be reduced to a 1DUniqueDMAC instance in time that is polynomial in the representation of f . Note that this does not imply anything about higher-dimensional fixed points. Indeed, the instance may still have many distinct fixed points, even though all one-dimensional slices have a unique one-dimensional fixed point.

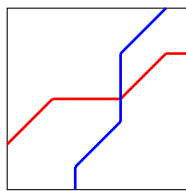

Figure 1: Surfaces in a two-dimensional DMAC instance.

Surfaces. Every one-dimensional slice of a 1DUniqueDMAC has a unique one-dimensional fixed point, and we think of these fixed points as a *surface* that spans the instance. Figure 1 shows the two surfaces that appear in a two-dimensional instance. The red line shows the unique one-dimensional fixed point in each slice that spans the up/down dimension, while the blue line shows the unique one-dimensional fixed point in each slice that spans the left/right dimension. Any point at which these two lines cross is therefore a two-dimensional fixed point.

More formally, the surface in dimension i as a function s_i that maps x_{-i} to a height in dimension i , where x_{-i} is the point x with dimension i removed. We show that the surfaces in a violation-free DMAC instance obey the following properties.

- The surface is monotone, meaning that $s_i(x_{-i}) \leq s_i(y_{-i})$ whenever $x_{-i} \leq y_{-i}$.
- The surface has gradient at most one, meaning that $\|s_i(x_{-i}) - s_i(y_{-i})\|_\infty \leq \|x_{-i} - y_{-i}\|_\infty$.

This can be seen in Figure 1. Here the red line moves weakly monotonically upward with gradient at most one, while the blue line moves weakly monotonically rightward with gradient at most one.

We also show that the converse holds. If all surfaces in a 1DUniqueDMAC instance are monotone with gradient at most one, and if one more technical condition holds on the one-dimensional slices of the instance (see Lemma 51 for details), then the instance is violation-free. We will use this property in our proofs when we are reducing DMAC to DMAC, because it is usually much easier to verify that the surfaces are monotone with gradient at most one, than it is to directly prove that the instance is violation-free.

3.2.2 The Decomposition Theorem

We say that an algorithm *LFP-solves* a DMAC instance if it finds a least fixed point of the instance or a violation. Our decomposition theorem states that if d_1 -dimensional DMAC can be LFP-solved using q_1 queries, and d_2 -dimensional DMAC can be LFP-solved using q_2 queries, then $(d_1 + d_2)$ -dimensional DMAC can be LFP-solved using $q_1 \cdot q_2$ queries. The decomposition theorem also applies to violation-free instances, in which case the algorithm is only required to find a least fixed point, and it is not required to produce a violation.

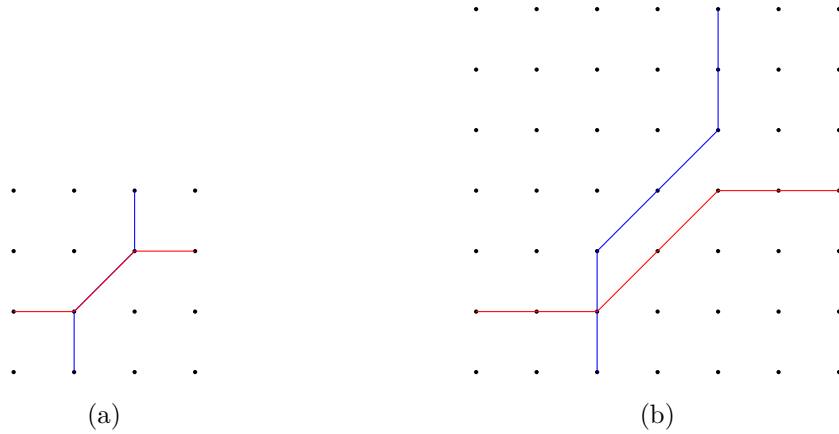

Figure 2: A reduction to ensure that a two-dimensional instance has a unique fixed point.

Our algorithm for three-dimensional instances does not necessarily find a least fixed point. We show that this is not a problem, because given an arbitrary 1DUniqueDMAC instance f , we can produce another 1DUniqueDMAC instance f' in time that is polynomial in the representation of f such that f' has a unique fixed point, and that fixed point can be mapped back to the least fixed point of f .

Here we give an overview of this reduction for two-dimensions. The full reduction for three-dimensional instances can be found in Section 7.2. We illustrate the reduction using Figure 2. Recall that we have a fixed point whenever all surfaces cross. In Figure 2 (a) we have a two-dimensional instance with two fixed points, and this is because the two surfaces track each other diagonally. The fact that the surfaces are monotone with gradient at most one ensures that this must always be the case: in a two-dimensional instance the only way for both surfaces to cross at multiple points is for both surfaces to track each other exactly diagonally between those points.

We transform the instance to create f' using the following two steps.

1. We refine the grid to $G' = \{1, 3/2, 2, 5/2, \dots, n\}^2$, where G' is the extension of G that contains points at half integers as well as whole integers, and then we interpolate the surfaces over G' .
2. We then shift the red surface downward by $1/2$ everywhere.

The result of applying these two steps is shown in Figure 2 (b).

The key property is that now the red and blue surfaces move along different diagonals in G' , and so they cannot track each other diagonally. Thus they cross at most once, so f' has a unique fixed point. We also show that since we shifted the surface downward, this unique fixed point lies in a small cube of width at most 1.5 below the least fixed point of f , and so if we find the unique fixed point of f' , we can search through constantly many points to recover the least fixed point of f .

The full reduction for three-dimensions (which is specified formally in Section 7.2) follows essentially the same approach. This time we blow up the grid so that we have points at integers i and $i + 1/4$, $i + 1/2$, and $i + 3/4$, and we interpolate in three dimensions, which requires a custom construction to ensure that the interpolated surfaces are monotone and have gradient at most one. Then we shift one surface down by $1/4$, another down by $1/2$, and we leave the final one unchanged. For three-dimensions, it is not the case that all three surfaces must track each other diagonally whenever there are multiple fixed points, but instead we show that if there are multiple fixed points, then there are at least two surfaces that track each other diagonally. Since the reduction ensures that all three surfaces use different diagonals, the resulting instance must have a unique fixed point, and we show that the fixed point must lie near the least fixed point of f , as before.

We should stress that surfaces are not actually used to implement the reduction from f to f' . This is because computing the value of the surface $s_i(x_{-i})$ requires a binary search in general, and making $\log n$ queries to f to answer a single query to f' is too expensive. Instead we implement the reduction manually, while ensuring that the surfaces of f' behave as we have described here. Once we have constructed f' , we can then use the fact that the surfaces of f' are monotone and have gradient at most one to prove that f' is violation-free.

3.2.3 The Algorithm

We show that a three-dimensional DMAC instance f can be solved in $O(\log n)$ queries, where each step runs in time that is polynomial in the representation of f .

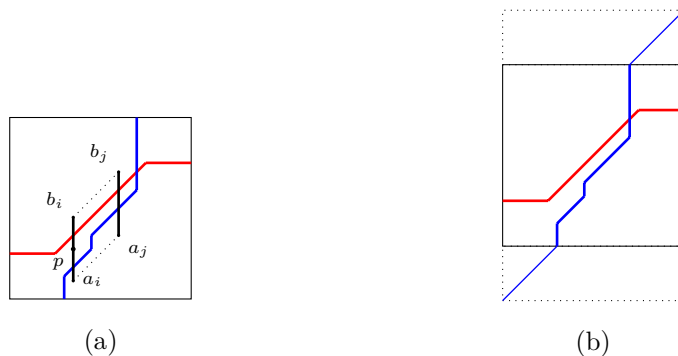

Figure 3: Carrying over information from one inner binary search to the next.

An algorithm for two-dimensions. As a warm-up, we will describe our ideas in a two-dimensional instance. We start by describing an algorithm that makes $O(\log^2 n)$ queries, which follows the approach of [15]. We define the *up-set* to be $\text{Up}(f) = \{x : x \leq f(x)\}$, which is the set of points at which f moves weakly upward, and the *down-set* to be $\text{Down}(f) = \{x : x \geq f(x)\}$, which is the set of points at which f moves weakly downward.

The idea is to carry out an *outer* binary search on the first coordinate. For a fixed slice $s_i = \{x : x_1 = i\}$, the algorithm uses an *inner* binary search to find some point in $\text{Up}(f) \cap s_i$ or $\text{Down}(f) \cap s_i$. If we find a point $x \in \text{Up}(f) \cap s_i$ then we can eliminate all points y with $y_1 < x_1$, while if we find a point $x \in \text{Down}(f) \cap s_i$ then we can eliminate all points y with $y_1 > x_1$. The justification for this can be found in [15]. We will not dwell on this point here, because it turns out we will actually need to use a different justification for our algorithm. Since the algorithm uses two levels of binary search, it makes $O(\log^2 n)$ queries overall.

Our key idea is that we can use the fact that our surfaces are monotone with gradient at most one to speed up this algorithm. Consider the instance shown in Figure 3 (a). Recall that each surface represents the one-dimensional fixed point of each one-dimensional slice. Moreover, since the instance is contracting, we must have that all points beneath the surface move upward under f , while all points above the surface move downward under f , because otherwise we would have a strict violation of contraction.

Our inner binary searches are searching for a point in $\text{Up}(f)$ or $\text{Down}(f)$, which therefore correspond to the points that lie between the red and blue lines. Specifically, whenever the red line is above the blue line, the region in between is $\text{Up}(f)$, while whenever the blue line lies above the red line, the region in between is $\text{Down}(f)$.

Suppose, as shown in Figure 3 (a), that we were carrying out a binary search on slice s_i . In the last iteration of this search, we had eliminated all but the region $[a_i, b_i]$, and we found point $p \in \text{Up}(f)$. Suppose further that the outer binary search moves to the slice $j > i$. If $a_j = a_i + (j - i)$ and $b_j = b_i + (j - 1)$, then we prove that $\text{Up}(f) \cap s_j$ must lie in the range $[a_j, b_j]$, as shown in Figure 3 (a).

This is due to the properties we have for surfaces. Since the blue line can move rightward with gradient at most one, it can get no closer to the line between a_i and a_j as we move rightward. Likewise, since the red line can move upward with gradient at most one, it can get no closer to the line between b_i and b_j . The only way for the red or blue lines to leave this region is for them to cross and exit the other side, but if the lines have crossed to the left of a slice j , then we have that $\text{Up}(f) \cap s_j$ is empty so our claim that $\text{Up}(f) \cap s_j$ is contained in the region $[a_j, b_j]$ holds trivially.

The key point here is that we can now initialize the binary search in slice j with the bounds $[a_j, b_j]$, and thereby carry over progress from one inner binary search to the next. So rather than doing $\log n$ separate binary searches, we do a single binary search that occasionally transfers itself to a new slice. So our query complexity is reduced from $O(\log^2 n)$ to $O(\log n)$.

We should remark that the algorithm needs to be slightly changed to accommodate this. The original algorithm used a single inner binary search that looked for a point either in $\text{Up}(f)$ or $\text{Down}(f)$. Here we run two independent binary searches: one binary search looks for a point in $\text{Up}(f)$ and maintains a bound on $\text{Up}(f)$, and the other looks for a point in $\text{Down}(f)$ and maintains a bound on $\text{Down}(f)$. Indeed, everything we have described holds symmetrically when we are seeking a point in $\text{Down}(f)$. Specifically, if we have a bound $[a_i, b_i]$ on $\text{Down}(f) \cap s_i$, then when we move to a slice $j < i$ we can set $a_j = a_i - (i - j)$ and $b_j = b_i - (i - j)$ to translate the bound diagonally downward to the slice j .

At a high level, our algorithm is as follows.

1. We first extend the instance vertically as shown in Figure 3 (b), to ensure that the blue line touches both the left and right boundaries of the instance. This enables us to ensure that our initial bounds entirely contain the up- and down-sets, while at most tripling the height of the instance.
2. Initialize $l = 1$ and $u = n$ to be the lower and upper bounds on the outer binary search, respectively. Let a and b be the minimum and maximum y -values of our extended instance. Initialize $b_1^{\text{up}} = (a, b)$ and $b_n^{\text{dn}} = (a, b)$ to be the trivial bounds on the up and down sets in slices 1 and n respectively.
3. Choose a new slice $i = \lfloor \frac{u-l}{2} \rfloor$. Set $b_i^{\text{up}} = b_l^{\text{up}} + (i - l) \cdot (1, 1)$, and set $b_i^{\text{dn}} = b_u^{\text{dn}} + (u - i) \cdot (-1, -1)$, where here we are applying our technique for translating bounds from one slice to the next.
4. Carry out two inner binary searches in parallel: one looking for a point in $\text{Up}(f)$ in slice i initialized with the bounds b_i^{up} , and a second looking for $\text{Down}(f)$ in slice i initialized with the bounds b_i^{dn} .
5. If the up-set binary search succeeds, then we set $l = i$ and b_i^{up} to be the last bounds considered by the binary search, and we move back to Step 3.
6. If the down-set inner algorithm succeeds, then we set $u = i$ and b_i^{dn} to be the last bounds considered by the binary search, and we move back to Step 3.

In particular, it is important that we run the two algorithms in Step 4 in lockstep, since we only consider the results of one of them, and throw the progress made by the other one away. So while we potentially waste the progress made by one binary search, this does not matter, because the other inner algorithm makes progress that we keep for the rest of the algorithm. So the overall number of steps made by the algorithm is still $O(\log n)$.

There are obviously many things that we need to prove to show that this approach is correct. Firstly we show that for every slice s_i we have $\text{Up}(f) \cap s_i \neq \emptyset$ or $\text{Down}(f) \cap s_i \neq \emptyset$, so one of the two binary searches always succeeds. Secondly we need to show that once the outer binary search has converged, meaning we have found a slice s_i with $\text{Up}(f) \cap s_i \neq \emptyset$ and $\text{Down}(f) \cap s_i \neq \emptyset$ then we can find a fixed point. For the two-dimensional case we can simply use one further binary search in the slice j to find a fixed point. For our three-dimensional algorithm we need an entirely separate *terminal algorithm* to do this job.

Bounding the up-set in a three-dimensional instance. We use the same setup in our three-dimensional algorithm. We carry out an outer binary search on dimension 3, and so each slice s_i that the algorithm visits is now a two-dimensional slice, rather than a one-dimensional slice.

For this to work, we need to be able to maintain succinct bounds on $\text{Up}(f) \cap s_i$ and $\text{Down}(f) \cap s_i$, and unfortunately the simple binary search bounds we used in the two-dimensional case are no longer

sufficient. Here we describe how a succinct bound on $\text{Up}(f) \cap s_i$ can be formulated for a two-dimensional slice s_i . Our bound on $\text{Down}(f) \cap s_i$ can be obtained by flipping both dimensions and applying the same ideas.



Figure 4: The structure of $\text{Up}(f)$ in a two-dimensional slice.

The structure of the up-set in a two-dimensional slice can be seen in Figure 4 (a). As before we have red and blue boundaries for dimensions 1 and 2. We also have the green line that represents the boundary between the points x with $x_3 > f_3(x)$, which lie below the green line, and the points y with $y_3 \leq f_3(y)$, which lie above it. Note that monotonicity implies that if x satisfies $x_3 > f_3(x)$, then all points p with $p \leq x$ and $p_3 = x_3$ also satisfy $p_3 > f_3(p)$. So we can always draw the green boundary as a line that starts on the left or top boundaries of the instance, and then moves weakly monotonically down, and weakly monotonically left until it reaches the right or bottom boundaries.

The region that we are interested in is labelled U in the diagram. This is the region that lies below the red line, to the left of the blue line, and above the green line, which is precisely the set of points that move weakly upward in all three dimensions, and therefore $U = \text{Up}(f) \cap s_i$. As can be seen, this region is not necessarily simple to describe, since there is no bound on the number of turns that any of the boundaries of U make. Nevertheless, we show that we can always find a relatively succinct upper bound on U .

We say that a box-shaped region is a *critical box* (defined formally in Definition 74) if it satisfies the following conditions.

- It only contains points in the up-set.
- It touches all three boundaries of the up-set in the sense that
 - The point directly to the right of the bottom-right corner of the box moves strictly down in dimension 1.
 - The point directly above the top-left corner of the box moves strictly down in dimension 2.
 - The point diagonally below the bottom-left corner of the box moves strictly down in dimension 3.

The region C is a critical box in Figure 4 (b). For each critical box we define three *lobes*: a left lobe that contains all points to the left of the box, a bottom lobe that contains all points beneath the box, and a diagonal lobe that contains all points diagonally above the box. These are shown as L , B , and D , respectively in the figure.

The key point is that, given any critical box, we have that $\text{Up}(f) \cap s_i$ is contained in the union of the box and its three lobes. Hence we can bound the up-set using at most three box-shaped regions and one diagonal region. Our algorithm will use bounds of this format.

Another crucial point that we will prove is that if $\text{Up}(f) \cap s_i$ is non-empty, then an *almost square* critical box always exists. Specifically, this means that if the box has height h and width w , then $|h - w| \leq 1$. The proof of this fact is actually quite involved, and will be covered in Section 8.3.

Refining a square-shaped region. So our bound on $\text{Up}(f) \cap s_i$ will take the form of a critical box and its three lobes. In the two-dimensional algorithm we had a bound $[a, b]$ on $\text{Up}(f) \cap s_i$, and we used binary search to reduce the size of this bound by one-half in each step. Analogously, in the three-dimensional algorithm, we have a critical box and its lobes, and we must make constantly many queries to f and then reduce the area covered by the bound by a constant fraction. This turns out to be quite a complex task, with several different cases that must be considered.

We start by considering the case where we have a square-shaped region that we know contains $\text{Up}(f) \cap s_i$, which would have, for example, at the start of the algorithm, where we can use the entire slice as a trivial bound on the up-set. We want to refine this square-shaped region to reduce the area of our bound $\text{Up}(f) \cap s_i$ by a constant fraction.

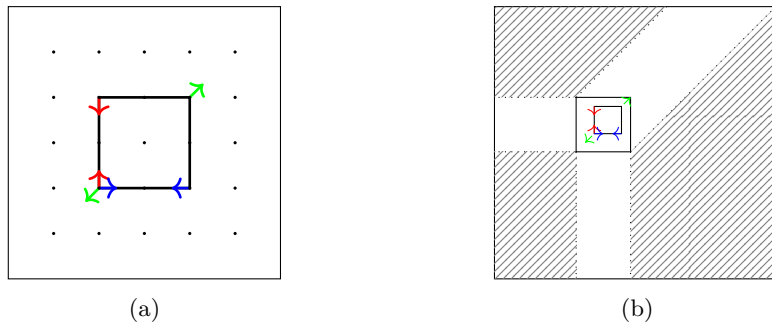

Figure 5: A CB-config, and the corresponding region that is ruled out.

We use a grid-search to achieve this. That is, we overlay a $k \times k$ grid with constantly many points over the square, and we query each point. This clearly uses constantly many queries. If we find a point in $\text{Up}(f)$ in our grid then we are done, and we can move to a new slice in the outer algorithm.

On the other hand, we know that if $\text{Up}(f) \cap s_i$ is non-empty, then an almost square critical box exists. If our grid search failed to find a point in $\text{Up}(f)$, then we know that all almost square critical boxes have height and width less than or equal to k , because every point in a critical box lies in $\text{Up}(f)$ and we did not find a point in $\text{Up}(f)$ in our grid. This means that the up-set must be contained in a much smaller region.

We proceed by searching for a *CB-config* (defined formally in Definition 94) in our grid, which is a 2×2 grid square satisfying the following properties.

- The lower-left corner of the square moves strictly downward in dimension 3, while the upper-right corner moves weakly upward.
- Either the top or bottom edge of the square has points that move toward each other in dimension 1, with the left point moving weakly right and the right point moving strictly left.
- Either the left or right edge of the square has points that move toward each other in dimension 2, with the lower point moving weakly upward and the upper point moving strictly downward.

Figure 5 (a) shows an example of a CB-config.

We prove that if an almost-square critical box exists, then the grid will contain a CB-config. So if we fail to find a CB-config we can declare that $\text{Up}(f) \cap s_i$ is empty. In this case we will prove that if $\text{Up}(f) \cap s_i$ is empty, then $\text{Down}(f) \cap s_i$ is non-empty, so the outer algorithm can proceed as if the down-set inner algorithm found a point in $\text{Down}(f) \cap s_i$.

If we do find a CB-config, then we prove that all almost square critical boxes must lie in a $7k \times 7k$ square region S surrounding the CB-config (which is specified formally in Lemma 96). Hence, if we take the union of the left, bottom, and diagonal lobes of S , then this union is guaranteed to contain all almost square critical boxes and all of their lobes, which themselves contain $\text{Up}(f)$. So this region is a new bound on $\text{Up}(f) \cap s_i$. As shown in Figure 5 (b), so long as k was chosen to be large enough, this rules out a significant fraction of the area of the original square.

We can now proceed by performing a more refined grid search on the square S . Since S contains all of the almost square critical boxes, and since an almost square critical box always exists so long as $\text{Up}(f) \cap s_i$ is non-empty, there is guaranteed to be a point in S that lies in $\text{Up}(f)$ whenever $\text{Up}(f) \cap s_i$ is non-empty. So it is valid for us to proceed in this way.

The procedure continues until we find a point⁴ in $\text{Up}(f) \cap s_i$, at which point we jump to a new slice.

⁴Or until we discover that $\text{Up}(f) \cap s_i$ is empty, or until the down-set inner algorithm, which is running parallel, finds a down-set point. In both of these cases we would throw away any progress we made here. We proceed in this section assuming that we do need to carry over the progress of the up-set inner algorithm.

Jumping to a new slice. When we jump to a new slice $j > i$, we transpose our existing bound on $\text{Up}(f) \cap s_i$ to the new slice. Our bound so far has been defined by a central box and its three lobes, and to transpose this bound to a new slice we simply translate all of the regions by $(j - i) \cdot (1, 1, 1)$. We will show that this gives us a valid bound on $\text{Up}(f)$ in the new slice.

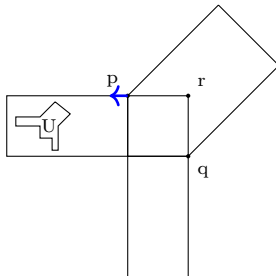

Figure 6: An example in which $\text{Up}(f) \cap s_i$ lies in a lobe.

However cannot proceed as before by refining the central square of this bound using a grid search. Figure 6 shows an example of why this is the case: in the example the entire up-set (labelled as U in the figure) is contained in one of the lobes, so we lose the invariant that all almost square critical boxes lie in the central square when we jump to a new slice.

So we must now use a different procedure to reestablish that invariant. For the example given in Figure 6, we can actually make a single query at the point p shown in the figure to determine that the up-set lies in the left lobe: if we find that $p_1 > f_1(p)$, then monotonicity implies that all points that lie directly below p also move strictly to the left, meaning that if $\text{Up}(f) \cap s_i$ exists, it must lie strictly within the left lobe. We can likewise make queries at the points q and r shown in Figure 6 to determine if $\text{Up}(f) \cap s_i$ lies entirely within the bottom or diagonal lobes.

In the case where the queries at p , q , and r do not tell us that $\text{Up}(f) \cap s_i$ lies entirely within one of the lobes, we prove that every almost square critical box must lie within a square region that encompasses the central square, whose area is at most a constant times the area of the central square. So we reestablish the invariant for this new larger square. The fact that we have increased the area in this case does not matter, because we perform this step only when we jump to a new slice, and we jump to a new slice at most $\log n$ times. Moreover, since the area is increased by a constant factor, constantly many reduction steps can cancel out this increase. So our overall $O(\log n)$ query complexity is not affected.

Dealing with non-square regions. If the jumping-slices procedure finds a square region, then we can proceed with a grid-search over this region as before. However, sometimes the jumping-slices procedure determines that the up-set lies in a lobe. If, for example, the up-set is contained in a left lobe, then it may be the case that the width of the lobe is more than a constant times the height, which means we cannot place a constant sized grid of squares over the lobe. So we cannot proceed via grid-search in this case, and we must instead use a different procedure.

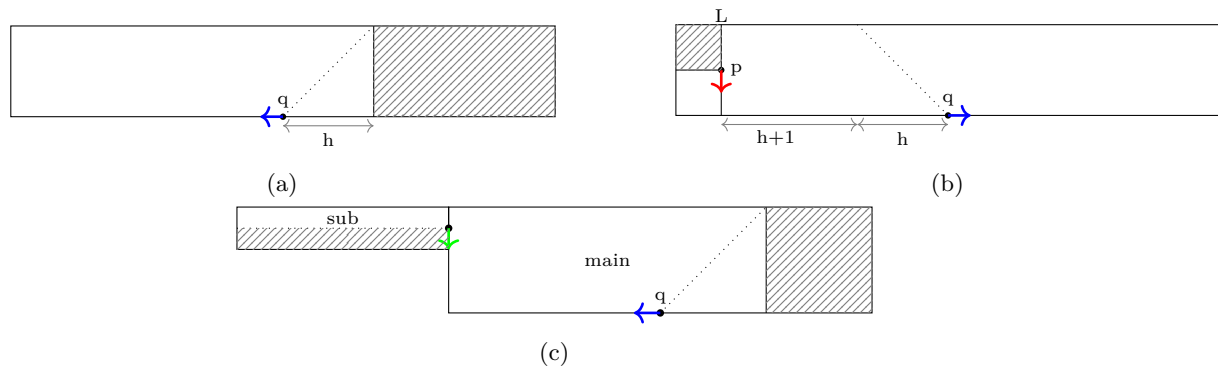

Figure 7: Handling left lobes.

Here we describe the procedure for a left lobe with width w and height h . The procedure for a bottom lobe is symmetric, and can be obtained by exchanging dimensions 1 and 2. The procedure for a diagonal lobe follows essentially the same approach, but has the added annoyance of working with diagonal regions.

The high-level idea is to use binary search to try to reduce the width of the lobe, while maintaining the invariant that the remaining space contains all almost square critical boxes. We keep doing this until $w \leq c \cdot h$ for some constant c . At which point we can continue via grid search, since we can now place a constant-sized grid of squares over the space.

To process a left lobe, we make a query at the point q shown in Figure 7, which is the point that lies half-way along the bottom of the lobe.

In Figure 7 (a) we have $q_1 > f_1(q)$. As has been observed in prior work on contraction maps [5], the point q induces the following *cone constraint*: any point x in the cone defined $x \geq q$ and $|x_2 - q_2| \leq x_1 - q_1$ must also satisfy $x_1 > f_1(x)$, because otherwise we would have a violation of contraction. Overlaying this cone onto the lobe shows us that once we move h units to the right of q , all points in the lobe will move strictly rightward. Thus we can eliminate all points to the right of $q + h \cdot e_1$, because none of these points can lie in $\text{Up}(f)$, and since we assume $h \ll w$, this roughly halves the area of the lobe.

The case where $q_1 \leq f_1(q)$ is more problematic, however. Here, as shown in Figure 7 (b), the cone-constraints applied to q imply that all points p in the lobe with $p_1 \leq q_1 - h$ satisfy $p_1 \leq f_1(p)$. Moreover, any almost square critical box must have height at most h , and so width at most $h + 1$. Since a critical box is required to touch a point p with $p_1 > f_1(p)$ on its right boundary, there cannot exist any almost square critical box whose lower-left corner x satisfies $x_1 \leq q_1 - 2h - 1$.

So if we consider the line L defined by points x with $x_1 = q_1 - 2h - 1$, we know that the area to the right of the line satisfies the invariant that the region contains all almost square critical boxes. However, we cannot remove the area to the left of L , because we are required to maintain a bound on the entire up-set, and the up-set may still exist to the left of L .

To solve this we make one further query at the point p shown in Figure 7 (b), which lies half-way along the line L . We show that the response to this query always allows us to rule out half of the remaining area. In the example given in the picture, the region above and to the left of p is excluded, for example.

We could attempt to perform binary search along the line L to rule out the entire space to the left of L , but this would cost us $\log n$ queries, which is too expensive. Instead, we will slowly reduce this remaining space over the subsequent iterations of the algorithm.

Specifically, we split the lobe into a *main lobe*, which is the area on the right of L , which always contains all of the almost square critical boxes, and a *sub-lobe*, which lies to the left of L and contains the rest of the up-set. In each step we reduce the size of the main-lobe by a constant fraction, and then if we create a new-sub lobe, we make some extra queries to merge it with the existing sub-lobe. Finally we make one extra query to reduce the size of the sub-lobe by a constant fraction. An example of this is shown in Figure 7 (c). Here, like in Figure 7 (a) we have eliminated a constant fraction of the main lobe, and we then make one additional query at the point r to rule out a constant fraction of the sub-lobe.

The actual regions considered by the algorithm. Eventually we will reduce the size of the main-lobe enough so that grid-search can once again be applied. However, we may still have a sub-lobe at this point, so our grid-search algorithm also needs to keep reducing the size of the sub-lobe in each step to ensure that our overall bound on the up-set keeps decreasing by a constant fraction.

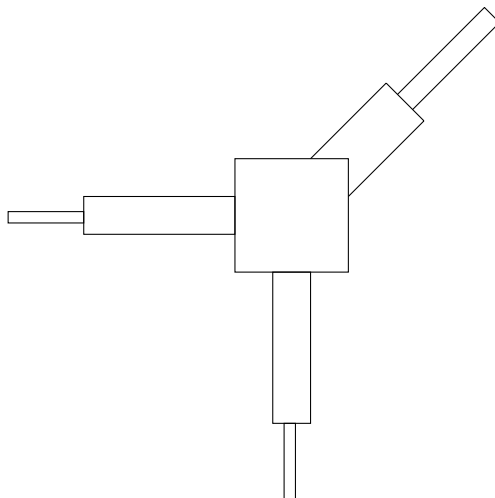

Figure 8: The shape of the regions that we consider.

Overall, the shape of our bound on the up-set can always be described by the shape shown in Figure 8 (which is defined formally in Definition 88). This shape has a central region that is roughly square shaped, meaning that the height and width are constant multiples of one another. The central region is surrounded by a left, bottom, and diagonal lobe, each of which have sub-lobes attached. Of course, in most scenarios we do not use the full generality of the shape. For example, when we are processing a left lobe, the central region and the bottom and diagonal lobes are both empty.

The main technical result that enables the algorithm is that, if we are given a region of the form shown in Figure 8, then we can make constantly many queries and either find a point in $\text{Up}(f) \cap s_i$, correctly declare that $\text{Up}(f) \cap s_i = \emptyset$, or find a new region of the same form in which the area has been reduced by a constant fraction. This then gives us our inner up-set algorithm that can be used with the outer binary search described earlier.

The terminal phase of the algorithm. The outer algorithm continues until it finds a slice s_i that contains both an up-set point and a down-set point. Now we must find a fixed point in this slice.

The first thing we must do is to prove that s_i actually contains a fixed point⁵. This might not be the case if f was just a monotone function. However, using the extra properties of a DMAC instance, we can show that this is indeed the case. Specifically, we can use the path of fixed points $l = p^1, p^2, \dots, p^k = g$ with $\|p^i - p^{i+1}\|_\infty = 1$ from the least fixed point l to the greatest fixed point g whose existence we proved when we put DMAC in UEOP. Since slice s_i contains an up-set point, by Tarski's theorem the greatest fixed point either lies in s_i or above it. Likewise, since s_i contains a down-set point, the least fixed point either lies in s_i or below it. If neither the greatest or least fixed points lie in s_i , then the path must pass through s_i , so there is indeed a fixed point in s_i .

Next we must actually find this fixed point. We design a specialized terminal phase algorithm for this task. We show that any query to the slice s_i either returns a fixed point, or rules out a vertical half-space, a horizontal half-space, or diagonal half-space that is aligned with the vector $(1, 1)$. We use this fact to build a $O(\log n)$ query algorithm that finds a fixed point in the slice.

Running time. In total, the algorithm makes $O(\log n)$ queries and returns a fixed point of f . Moreover, all of the steps of our algorithm run in time that is polynomial in the size of the representation of f

4 Reducing MonotoneContraction to DMAC

In this section, we present a promise-preserving polynomial-time reduction from MonotoneContraction to DMAC.

Prior work has defined the concept of a promise-preserving reduction from problem A to problem B, which ensures that if problem A has no violations, the corresponding instance of problem B must also remain free of violations [14]. In other words, we must never map a non-violation solution of A onto a violation solution of B.

4.1 Creating a DMAC instance

Let $g : [0, 1]^d \rightarrow [0, 1]^d$ be a (purported) monotone contraction map. Our reduction discretizes the continuous domain $[0, 1]^d$ of g and then applies rounding to the displacements of g at grid points, in order to define a DMAC instance f on the discrete domain $G = \{0, 1, 2, \dots, n\}^d$, which differs only from the Definition 2 in that we start from 0 rather than 1, which is for convenience in this section. This is otherwise inconsequential as it is just a relabelling. First, we set

$$\hat{\varepsilon} := 1 / \lceil 1/\varepsilon \rceil.$$

This choice gives two key properties: $\frac{1}{\hat{\varepsilon}} \in \mathbb{N}$ and $\hat{\varepsilon} \leq \varepsilon$. Then we discretize the $[0, 1]^d$ domain using a grid of width $\hat{\varepsilon}$ in each dimension, which defines a discrete grid:

$$\hat{G} = \{0, \hat{\varepsilon}, 2\hat{\varepsilon}, \dots, 1\}^d. \tag{1}$$

⁵The prior algorithm for monotone functions given in [15] ensured that the remaining space always lies between the up-set and down-set points that are found by the outer algorithm, which ensures that s_i must contain a fixed point. We are unable to maintain this invariant here, because if we try to reduce the remaining space by excluding all points that do not lie above some up-set point x , then we may change the set of almost-square critical boxes, and invalidate our bounds. So this extra step is necessary for our setting.

So G has grid width 1 and \hat{G} has grid width $\hat{\varepsilon}$. Every point in our DMAC domain G will be in one-to-one correspondence with points in \hat{G} according to the bijection $\text{stretch} : \hat{G} \mapsto G$ with $\text{stretch}(\hat{x}) = \frac{1}{\hat{\varepsilon}} \cdot \hat{x}$. We can define the inverse of the transformation as $\text{stretch}^{-1} : G \mapsto \hat{G}$ as $\text{stretch}^{-1}(x) = \hat{\varepsilon} \cdot x = \hat{x}$. To create $f : G \mapsto G$ we will first *clamp* displacements of g in each dimension using the following function $\text{clamp}_\varepsilon : [0, 1] \mapsto \{\pm\hat{\varepsilon}, 0\}$:

$$\text{clamp}_\varepsilon(\hat{z}) = \begin{cases} \hat{\varepsilon} & \text{if } \hat{z} \geq \hat{\varepsilon}, \\ 0 & \text{if } |\hat{z}| < \hat{\varepsilon}, \\ -\hat{\varepsilon} & \text{if } \hat{z} \leq -\hat{\varepsilon}. \end{cases}$$

This function rounds all values in the range $(-\hat{\varepsilon}, \hat{\varepsilon})$ to 0, while clamping values outside of the range to either $-\hat{\varepsilon}$ or $\hat{\varepsilon}$. We then stretch these values so that $-\hat{\varepsilon}$ becomes -1 and $\hat{\varepsilon}$ becomes 1 using stretch . We then define f via a dimension-wise displacement function h as follows.

Definition 3. For all $y \in G$, and any dimension $i \in [d]$, we define:

$$h_i(y) = \text{stretch}(\text{clamp}_\varepsilon(g_i(\hat{y}) - \hat{y}_i)), \text{ with } \hat{y} = \text{stretch}^{-1}(y). \quad (2)$$

To define h_i at a point $y \in G$, we first compute the displacement of g in dimension i for the point $\hat{y} \in \hat{G}$ corresponding to y in the domain \hat{G} . Then, we apply the clamp_ε function to this displacement, producing a value in $\{\pm\hat{\varepsilon}, 0\}$, which is finally mapped to displacement values $\{\pm 1, 0\}$ corresponding to the domain G using function stretch . The overall displacement h for a point $y \in G$ is then defined as:

$$h(y) := (h_1(y), h_2(y), \dots, h_d(y)).$$

Finally, we define $f : G \rightarrow G$ for the resulting DMAC instance as:

$$f(y) := y + h(y)$$

This completes a definition of how our reduction creates in polynomial time a DMAC instance from a **MonotoneContraction** instance. What is left to do is show that the solutions of the resulting DMAC instance can be mapped in polynomial time to solutions of the original **MonotoneContraction** instance. First we explain why we use both G and \hat{G} , and introduce some convenient notation to deal with this.

Different grid widths. We intentionally chose to make the grid width in DMAC equal to 1, rather than $\hat{\varepsilon}$. This makes our containment proofs of DMAC in UEOPPL and our complicated algorithm for 3d DMAC cleaner. It does make the proofs in this section, showing the correctness of the reduction from **MonotoneContraction** to DMAC, slightly more involved though. For convenience, we introduce functions \hat{f} and \hat{h} that are analogous to f and h but that keep the grid width as $\hat{\varepsilon}$ rather than 1. We also define \hat{x} as the point in \hat{G} that corresponds to $x \in G$, as we did in Definition 3.

Definition 4. For all $\hat{y} \in \hat{G}$, and any dimension $i \in [d]$, we define:

$$\hat{h}_i(\hat{y}) = \text{clamp}_\varepsilon(g_i(\hat{y}) - \hat{y}_i). \quad (3)$$

The overall displacement \hat{h} at \hat{y} is then $\hat{h}(\hat{y}) := (\hat{h}_1(\hat{y}), \hat{h}_2(\hat{y}), \dots, \hat{h}_d(\hat{y}))$. Then $\hat{f} : \hat{G} \rightarrow \hat{G}$ is defined as: $\hat{f}(\hat{y}) := \hat{y} + \hat{h}(\hat{y})$. Finally, given a point $y \in G$, we define $\hat{y} := \text{stretch}^{-1}(y) = \hat{\varepsilon} \cdot y \in \hat{G}$.

As stated in the following observation, we can easily relate the values of ℓ_∞ norms of interest within G and \hat{G} , as we have simply multiplied all terms used within the norm by $\hat{\varepsilon}$ when going from f to \hat{f} and from x, y to \hat{x}, \hat{y} , respectively.

Observation 5. We have that: $\hat{\varepsilon} \cdot \|x - y\|_\infty = \|\hat{x} - \hat{y}\|_\infty$ and $\hat{\varepsilon} \cdot \|f(y) - f(x)\|_\infty = \|\hat{f}(\hat{y}) - \hat{f}(\hat{x})\|_\infty$.

4.2 Mapping solutions back

We now show how each type of solution of the DMAC instance produced by our reduction can be mapped back, in polynomial time, to a solution of the original **MonotoneContraction** instance.

First, we will deal with actual fixed point solutions. We show how a (D1) solution for f trivially maps back to an (M1) solution.

Lemma 6. A point $y \in G$ is a (D1) solution of the DMAC instance arising from our reduction only if $\hat{y} = \hat{\varepsilon} \cdot y \in \hat{G}$ is an (M1) solution of the original **MonotoneContraction** instance.

Proof. Suppose we have a (D1) solution, $y \in G$ such that $f(y) = y$. By definition of f , this means that $h(y) = 0 \implies \hat{h}(\hat{y}) < |\hat{\varepsilon}|$. By definition of \hat{h} , this means that $\|g(\hat{y}) - \hat{y}\|_\infty < \hat{\varepsilon} \leq \varepsilon$, which completes the proof. \square

Now we deal with violation solutions. The following lemma states that if we can find a violation of monotonicity for f , then we can efficiently turn that into a violation of monotonicity for g . This means that if g is monotone, then f is also monotone.

Lemma 7. *If there exists a violation of type (DV1) for f , then we can find a violation of type (MV1) for g in polynomial time.*

Proof. Let $x, y \in G$ witness a violation of type (DV1), i.e., $x \leq y$ and $f(x) \not\leq f(y)$. Then there exists an $i \in [d]$ such that $f_i(y) < f_i(x)$. We already know that $x_i \leq y_i$. Suppose $y_i \geq x_i + 2$. Then since $|h_i(y)| \leq 1$ and $|h_i(x)| \leq 1$ we have that $f_i(y) \geq f_i(x)$, which is a contradiction, so $y_i \not\geq x_i + 2$. Thus, we have $x_i \leq y_i \leq x_i + 1$. There are two cases to consider. The first is where $y_i = x_i$. In this case, we have $h_i(y) < h_i(x)$, which is equivalent to

$$\text{clamp}_\varepsilon(g_i(\hat{y}) - \hat{y}_i) < \text{clamp}_\varepsilon(g_i(\hat{x}) - \hat{x}_i) = \text{clamp}_\varepsilon(g_i(\hat{x}) - \hat{y}_i) \implies g_i(\hat{y}) < g_i(\hat{x}),$$

so $g(\hat{x}) \not\leq g(\hat{y})$, giving us a violation of type (MV1) for the pair \hat{x}, \hat{y} .

The second case is where $y_i = x_i + 1$. Then we must have $h_i(x) = 1$ and $h_i(y) = -1$, which implies that

$$g_i(\hat{x}) \geq \hat{x}_i + \hat{\varepsilon} = \hat{y}_i \geq g_i(\hat{y}) + \hat{\varepsilon} > g_i(\hat{y}),$$

so $g(\hat{x}) \not\leq g(\hat{y})$, and we again have a violation of type (MV1) for the pair \hat{x}, \hat{y} . \square

Next we deal with violations of type (DV2), which occur whenever f is strictly non-contracting, i.e. expanding. In this case, we can efficiently map these violations onto (MV2) violations of contraction in g . This means that if g is contracting, then f is non-expansive. Given a pair of points x, y witnessing a violation of type (DV2) for f , we will show that \hat{x}, \hat{y} witness a violation of type (MV2) for g . To that end, we first show in Lemma 8 that there exists a dimension $i \in [d]$ where a violation of strict contraction is witnessed for the pair of points x, y and in which the displacement of \hat{f} cannot be more than $\hat{\varepsilon}$ smaller than the displacement of g at \hat{x}, \hat{y} .

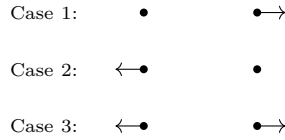

Figure 9: Cases constituting contraction violations.

Lemma 8. *Given a violation x, y of type (DV2) for f , then for some $i \in [d]$ we have that:*

$$|f_i(y) - f_i(x)| > \|y - x\|_\infty \geq 1. \quad (4)$$

and

$$|g_i(\hat{y}) - g_i(\hat{x})| \geq |\hat{f}_i(\hat{y}) - \hat{f}_i(\hat{x})| - \hat{\varepsilon}. \quad (5)$$

Proof. If $x, y \in G$ are a violation of type (DV2), i.e., $\|f(y) - f(x)\|_\infty > \|y - x\|_\infty$, then there exists a dimension, say $i \in [d]$, such that (4) holds. Recall that $f_i(y) = y_i + h_i(y)$. We use a case analysis on the values of $h_i(x)$ and $h_i(y)$.

First assume that $y_i > x_i$. Since $h_i(x), h_i(y) \in \{-1, 0, 1\}$, there are nine possibilities for the values of $(h_i(x), h_i(y))$. First we show that, under our assumption $y_i > x_i$, condition (4) implies that $h_i(y) > h_i(x)$. Towards a contradiction assume that $h_i(y) - h_i(x) \leq 0$. Since $|y_i - x_i| \leq \|y - x\|_\infty$, we require

$$|f_i(y) - f_i(x)| \geq |y_i - x_i| + 1.$$

But, as $y_i \geq x_i + 1$ and $h_i(y) - h_i(x) \in \{-2, -1, 0\}$, this is not possible, since

$$\begin{aligned} |f_i(y) - f_i(x)| - |y_i - x_i| &= |y_i + h_i(y) - x_i - h_i(x)| - |y_i - x_i| \\ &= |(y_i - x_i) + (h_i(y) - h_i(x))| - |y_i - x_i| \\ &\leq 0. \end{aligned}$$

Thus we have $h_i(y) > h_i(x)$, as claimed, i.e., the only three relevant cases, illustrated in Figure 9, are:

$$(h_i(x), h_i(y)) \in \{(0, 1), (-1, 0), (-1, 1)\}.$$

Assume that $(h_i(x), h_i(y)) = (0, 1)$, then the smallest that $|\hat{f}_i(\hat{y}) - \hat{f}_i(\hat{x})| - |g_i(\hat{y}) - g_i(\hat{x})|$ can be is when $g_i(\hat{x}) - \hat{x}$ is just slightly less than $\hat{\varepsilon}$ and $g_i(\hat{y}) = \hat{y} + \hat{\varepsilon}$. Then $|\hat{f}_i(\hat{y}) - \hat{f}_i(\hat{x})| = 2 \cdot \hat{\varepsilon}$ and $|g_i(\hat{y}) - g_i(\hat{x})| > \hat{\varepsilon}$, which implies (5).

The argument for the case that $(h_i(x), h_i(y)) = (-1, 0)$ is symmetric to the case for $(h_i(x), h_i(y)) = (0, 1)$, with the smallest gap $|\hat{f}_i(\hat{y}) - \hat{f}_i(\hat{x})| - |g_i(\hat{y}) - g_i(\hat{x})|$ occurring when $g_i(\hat{y}) = \hat{y} - \hat{\varepsilon}$ and when $g(\hat{x}) - \hat{x}$ is just slightly less than $-\hat{\varepsilon}$.

If $(h_i(x), h_i(y)) = (-1, 1)$, then the clamping done by h has (weakly) reduced both displacements for x and y , so in the \hat{G} domain we have the following inequality, which is stronger than (5):

$$|g_i(\hat{y}) - g_i(\hat{x})| \geq |\hat{f}_i(\hat{y}) - \hat{f}_i(\hat{x})|. \quad (6)$$

This completes the proof of the theorem under the assumption that $y_i > x_i$. The proof for the case of $y_i < x_i$ is symmetric.

Finally, assume that $y_i = x_i$. In this case, only two of the nine cases are relevant, i.e., are consistent with (4), namely where $(h_i(x), h_i(y)) \in \{(1, -1), (-1, 1)\}$. Intuitively, now because $x_i = y_i$ and dimension i witnesses $|f_i(y) - f_i(x)| \geq 2$, the displacements for x_i and y_i must go in strictly opposite directions. Formally, since we require $|f_i(y) - f_i(x)| = |y_i + h_i(y) - x_i - h_i(x)| = |h_i(y) - h_i(x)| \geq 2$, and $h_i(y), h_i(x) \in \{-1, 0, 1\}$, we must have $|h_i(y) - h_i(x)| = 2$. Now, since the absolute value of both displacements in \hat{G} was at least $\hat{\varepsilon}$, the clamping has weakly reduced the gap, and we have the stronger inequality (6) again, which completes the proof. \square

We can now prove the following.

Lemma 9. *If there exists a violation of type (DV2) for f , then we can find a violation of type (MV2) for g in polynomial time.*

Proof. Let x, y witness the (DV2) violation of f . We will use Lemma 8 to show that \hat{x}, \hat{y} is our desired (MV2) violation for g . First we choose $i \in [d]$ so that (4) and (5) from Lemma 8 both hold.

Note that we have $\|\hat{y} - \hat{x}\|_\infty + \hat{\varepsilon} \leq |\hat{f}_i(\hat{y}) - \hat{f}_i(\hat{x})|$, which is due to (4) and the fact that the grid width is $\hat{\varepsilon}$. Putting this together with (5), we have:

$$\begin{aligned} \|\hat{y} - \hat{x}\|_\infty + \hat{\varepsilon} &\leq |\hat{f}_i(\hat{y}) - \hat{f}_i(\hat{x})| \\ &\leq |g(\hat{y}) - g(\hat{x})| + \hat{\varepsilon} \\ &\leq \|g(\hat{y}) - g(\hat{x})\|_\infty + \hat{\varepsilon}, \end{aligned}$$

so we have

$$\|\hat{y} - \hat{x}\|_\infty \leq \|g(\hat{y}) - g(\hat{x})\|_\infty,$$

which shows that we get an (MV2) violation of strict contraction for points \hat{x}, \hat{y} , and which completes the proof. \square

To conclude, we have shown that each solution type of DMAC for f can be mapped onto a solution of MonotoneContraction for g . Furthermore, it is clear that f can be constructed from g in polynomial time, establishing the correctness of our reduction. Our reduction maps all approximate fixed points of g to fixed points of f , so we have proved the following theorem.

Theorem 10. *There is a promise-preserving polynomial-time reduction from MonotoneContraction to DMAC.*

5 DMAC is in UEOPL

In Section 3.1 we briefly outlined key features of our proof of containment of DMAC in UEOPL, which goes via a reduction to the problem OPDC. In this section, we give full details of our reduction from DMAC to OPDC.

Our very first step, in Section 5.1, is to show that we can reduce DMAC to a variant of it where all displacements have length at most 1 in the ℓ_∞ -norm. Our reduction from MonotoneContraction to DMAC

had this property, and here we show that any DMAC instance can be efficiently transformed into another instance with this property. It will make a number of subsequent proofs in this section simpler, and will also be used by our algorithm for 3d instance later in the paper. After Section 5.1, in the rest of the paper we will always assume that our DMAC instances have this property.

For a DMAC instance, the domain of the function f is a discrete grid, which is a complete lattice under the pointwise-minimum ordering). If the DMAC instance is violation-free then f is *monotone*, which is also known as *order preserving*. In Section 5.2, we first recall the Knaster-Tarski Theorem (henceforth just Tarski's Theorem), which implies that an order-preserving function that maps a complete lattice to itself has a *least fixed point*. Then, we describe a number of properties of least fixed points of monotone functions that are also *non-expansive*, as f will be in a DMAC instance with no violations. The properties will be used in our reduction from DMAC to OPDC. The reduction itself appears in Section 5.3.

5.1 DMAC with Unit Displacements

Here we show that DMAC can be reduced, in polynomial time, to DMAC in which all displacements have length at most 1 in the ℓ_∞ -norm. The reduction creates a new function $f' : G \rightarrow G$ defined as follows.

$$f'_i(x) = \begin{cases} x_i - 1 & \text{if } f_i(x) < x_i, \\ x_i & \text{if } f_i(x) = x_i, \\ x_i + 1 & \text{if } f_i(x) > x_i. \end{cases}$$

This function simply clamps the displacement of f so that it moves distance at most 1 in each dimension, in much the same way as we did when we reduced MonotoneContraction to DMAC. It is therefore clear that we have $\|f'(x) - x\|_\infty \leq 1$ for all $x \in G$.

The next lemma proves that this is a correct promise-preserving reduction.

Lemma 11. *Every fixed point of f' is a fixed point of f . Furthermore, if f is violation-free, if x, y is a (DV1) or (DV2) violation for f' , then it is also, respectively, the same type of violation for f .*

Proof. It is clear from the definition of f' that $f'(x) = x$ if and only if $f(x) = x$. So every fixed point of f' is a fixed point of f .

Next we deal with violations of type (DV1). Suppose we have points $x, y \in G$ with $x \leq y$ and $f'(x) \not\leq f'(y)$. Let i be a dimension in which $f'_i(x) > f'_i(y)$. Observe that we cannot have $f'_i(x) = x_i - 1$, since this would imply that $f'_i(y) < f'_i(x) = x_i - 1 \leq y_i - 1$, which contradicts the definition of f' . So we have $f'_i(x) \geq x_i$, and the definition of f' then implies $f_i(x) \geq f'_i(x)$, because each displacement in f' was generated by clamping a displacement in f . Applying the same argument symmetrically implies that we cannot have $f'_i(y) = y_i + 1$, since this would imply $f'_i(x) > f'_i(y) = y_i + 1 \geq x_i + 1$, which also contradicts the definition of f' . Therefore we have $f_i(y) \leq f'_i(y)$. Hence we have $f_i(x) \geq f'_i(x) > f'_i(y) \geq f_i(y)$, which implies that x and y are a violation of monotonicity in f as claimed.

Finally, we deal with violations of type (DV2). Suppose that x and y are a pair of points satisfying $\|f'(x) - f'(y)\|_\infty > \|x - y\|_\infty$. Let i be a dimension in which $|f'_i(x) - f'_i(y)| > \|x - y\|_\infty$, and suppose without loss of generality that $x_i \leq y_i$.

- If $x_i < y_i$, then note that we cannot have $f'_i(x) = x_i + 1$, because we have $y_i - 1 \leq f'_i(y) \leq y_i + 1$, and so this would imply that $|f'_i(x) - f'_i(y)| \leq \|x - y\|_\infty$. Therefore we have $f'_i(x) \leq x_i$, and then the definition of f' implies that $f_i(x) \leq f'_i(x)$. Applying the same argument symmetrically allows us to conclude that $f'_i(y) \geq y_i$, and therefore $f_i(y) \geq f'_i(y)$. So we have $|f_i(y) - f_i(x)| \geq |f'_i(y) - f'_i(x)| > \|x - y\|_\infty$, which implies that x and y violate non-expansion in f .
- If $x_i = y_i$, then note we have $|f'_i(x) - f'_i(y)| > \|x - y\|_\infty \geq 1$, where the second inequality holds because x and y are distinct. Since all displacements in f' are at most unit length by construction, the only way for this to be true is for $f'_i(x)$ and $f'_i(y)$ to move in opposite directions, and for both to move strictly away from each other. So let us assume without loss of generality that $f'_i(x) < x_i$ and $f'_i(y) > y_i$. The definition of f' then tells us that $f_i(x) \leq f'_i(x)$, and $f_i(y) \geq f'_i(y)$. So as before we have $|f_i(y) - f_i(x)| \geq |f'_i(y) - f'_i(x)| > \|x - y\|_\infty$, which implies that x and y violate non-expansion in f .

□

5.2 Verifiable Least Fixed Points

Formally, order preservation is defined as follows.

Definition 12. A function $f : L \rightarrow L$ defined over a complete lattice (L, \preceq) is called *order-preserving* w.r.t. \preceq if, for all $x, y \in L$, we have that $x \preceq y$ implies that $f(x) \preceq f(y)$.

Tarski theorem is the following.

Theorem 13 (Tarski [26]). *Let (L, \preceq) be a complete lattice, and let $f : L \rightarrow L$ by a function that is order-preserving w.r.t. \preceq . The set of fixed points of f form a complete lattice.*

A complete lattice cannot be empty, so this theorem guarantees that at least one fixed point of f exists. It also guarantees that, w.r.t. \preceq , a least and a greatest fixed point exist, which may be the same point.

In order to place the DMAC problem in UEOP, we need to have some notion of a unique solution for the problem. While a monotone contraction has a single fixed point, discretizing the problem into DMAC may result in multiple fixed points, each representing an approximate fixed point of the original function. Therefore, we require a way to distinguish one of these fixed points in order to designate it as the unique solution.

Initially, we will assume that we are given a DMAC instance defined by f that has no violations, and we will deal with violating instances at the very end of the reduction. When there are no violations of monotonicity, Theorem 13 says that f has a least (and greatest) fixed point. We would like to declare the least fixed point to be our distinguished unique solution.

However, prior work has shown that it is NP-hard to decide whether a given fixed point of a monotone function is the least fixed point⁶, even for one-dimensional instances [9]. We show that this is not the case for DMAC instances: we can leverage the non-expansion properties to build a polynomial-time algorithm that verifies whether a given fixed point is the least fixed point. In this section we provide that algorithm.

Contiguity of fixed points. A key property that allows for a polynomial-time verification algorithm is contiguity: if a given fixed point $x \in G$ is not the least fixed point, there must exist a lesser fixed point at distance at most 1 from x . To show the existence of these other fixed points, we will employ Tarski's theorem on suitable sub-lattices of the grid domain G . We use the following notation to refer to sublattices of the grid, defined between two points a and b , and we also introduce notation that is useful for working with dimension-wise displacements of functions.

Definition 14 (Sublattices and projections). For any two points $a, b \in G$ with $a \leq b$, let

$$L(a, b) := \{z \in G : a \leq z \leq b\}.$$

Sometimes we will write a sublattice $L(a, b)$ as just L , leaving its corners a and b implicit. For any $i \in [d]$, the projection along dimension i in a sublattice is defined as

$$\Pi_i(L(a, b)) := \{z_i \mid z \in L(a, b) \text{ and } a_i \leq z_i \leq b_i\},$$

where z_i denotes the i -th component of $z \in G$.

With this notation in hand, the following immediate observation states a condition that a function f must possess in order for f to map the sublattice to itself, which we will need to be able to apply Tarski's theorem on the sublattice.

Observation 15 (Closedness of Tarski function on a sublattice). *Suppose $L(a, b) \subseteq G$ is a sublattice. Then, if for every point $z \in L(a, b)$, we have $f_i(z) \in \Pi_i(L)$, then for all z we have $f(z) \in L(a, b)$.*

To show the property about lesser fixed points, we need one more bit of notation: For points in G , we define ℓ_∞ boxes as follows.

Definition 16. For any point $x \in G$ and $r \in \mathbb{N}$, we define the region centered at x of ℓ_∞ -radius r as:

$$B(x, r) := \{y \in G : \|x - y\|_\infty \leq r\}.$$

⁶Actually, their stated result is that the least fixed point is NP-hard to compute, but their proof technique also applies to the verification problem as well.

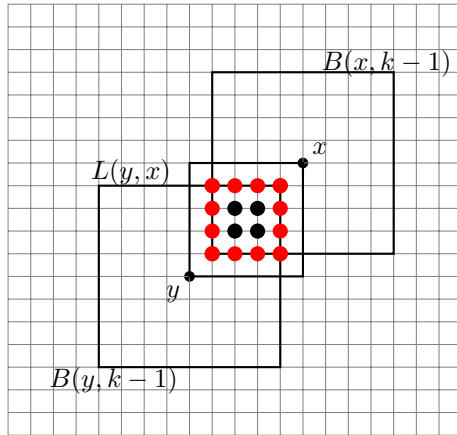

Figure 10: An illustration of the region $B(y, k-1) \cap B(x, k-1) \cap L(y, x)$ from Lemma 17 when y, x are at equal distance along all dimensions. Red points correspond to the boundary of the intersection.

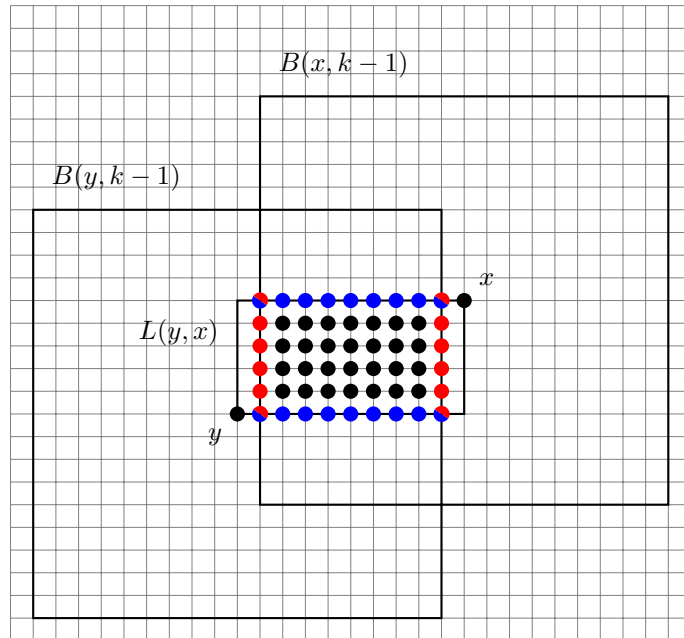

Figure 11: An illustration of the region $B(y, k-1) \cap B(x, k-1) \cap L(y, x)$ from Lemma 17. Red points are on the boundary of $B(y, k-1) \cap B(x, k-1)$, blue points are on the boundary of $L(y, x)$ and points that are both blue and red are on the boundary of both.

We next prove the following lemma, which states that between any two fixed points x and y , with $y \leq x$ that are at distance more than 1 from one another, there is another fixed point that is strictly between y and x . Our overview of the proof technique will use Figures 10 and 11. We draw an ℓ_∞ box around each of the points x and y , and intersect these two boxes also with the sublattice $L(y, x)$. The resulting region is itself a sublattice.

Because our DMAC instances have displacements with length at most 1, points in the interior of this region stay within this region when mapped by the Tarski function. We argue that every point on the boundary of this region points weakly inwards so these points stay in the region too. The proof deals with two cases.

Points on the boundaries of one of the two ℓ_∞ boxes (shown in red in Figures 10 and 11) must weakly point inward because otherwise we would violate the non-expansion property with either x or y . This argument works when the ℓ_∞ distance between the boundary points and one of the points x and y is only one less than the ℓ_∞ distance between x and y themselves. For Figure 10, this is true for all boundary points; for Figure 11, this is true only for the left and right boundary points.

Boundary points for which this is not true are those that are also on the boundary of the sublattice between y and x (shown in blue in Figure 11). For these points the argument that they point weakly inwards is based on monotonicity. In Figure 11, points that are directly to the right of y must point weakly upwards, while the points that are directly to the left of x must point weakly downward, because otherwise we would violate monotonicity with the two fixed points y and x , respectively.

These arguments show that f maps this sublattice region to itself. Furthermore, since f is monotone everywhere, it is also monotone within this sublattice, so we can apply Tarski's theorem to prove that there is a fixed point in this region. We now prove this formally.

Lemma 17. *Suppose f is a violation-free DMAC instance. Let x and y be fixed points of f with $y \leq x$ and $\|x - y\|_\infty > 1$. There exists a fixed point $z \in G$ of f in $L(y, x)$ with $\|z - y\|_\infty < \|x - y\|_\infty$ and $\|x - z\|_\infty < \|x - y\|_\infty$.*

Proof. Let $k := \|x - y\|_\infty$. We consider the region

$$R := B(y, k - 1) \cap B(x, k - 1) \cap L(y, x).$$

Because $L(y, x) \subseteq G$, we have $R \subseteq G$. By construction, R is non-empty and contains neither x nor y . We will show that there exists a fixed point of f in R , proving the lemma.

To do this, we first argue that for each $z \in R$ we have $f(z) \in R$. Consider any point $z \in R$. For each dimension $i \in [d]$, if z_i is in the interior of $\Pi_i(R)$, then $f_i(z)$ is in $\Pi_i(R)$ as well as by assumption it does not move by more than 1. If z_i is not in the interior then there are two (potentially overlapping) cases to consider: Either z_i is on the boundary of $\Pi_i(L(y, x))$ or z_i is on the boundary of $\Pi_i(B(y, k - 1) \cap B(x, k - 1))$. Figure 11 illustrates the two cases and the region in question.

Suppose that z_i is on the boundary of $\Pi_i(B(y, k - 1) \cap B(x, k - 1))$. Then either $z_i - y_i = k - 1$ or $x_i - z_i = k - 1$. Suppose towards a contradiction that $f_i(z) < z_i$ and $x_i - z_i = k - 1$. Then

$$\|f(x) - f(z)\|_\infty = \|x - f(z)\|_\infty = k > k - 1 = \|x - z\|,$$

which contradicts non-expansion of f . The same contradiction can be reached if we start from $f_i(z) > z_i$ and $z_i - y_i = k - 1$. We conclude that $f_i(z) \in \Pi_i(R)$.

Suppose z_i is on the boundary of $\Pi_i(L(y, x))$. Then we have $y_i \leq z_i \leq x_i$ with at least one equality. Suppose that $y_i = z_i \leq x_i$. Then $f_i(z) \geq y_i$ by monotonicity. If instead $y_i \leq z_i = x_i$, then $f_i(z) \leq x_i$ by monotonicity. We conclude that $f_i(z) \in \Pi_i(R)$.

We have thus shown that for all points z in the sublattice R and all dimensions $i \in [d]$, we have $f_i(z) \in \Pi_i(R)$. So, by Observation 15, we have that f maps R to itself. Now, since f is a monotone function over R , and since f maps R to itself, we can apply Theorem 13 to conclude that f has a fixed point in R , which completes the proof. \square

With Lemma 17 in hand, it is now straightforward to prove our desired property, namely that if we find a fixed point $x \in G$ that is not the least fixed point, then there is a fixed point $y \leq x$ such that $\|x - y\|_\infty = 1$, i.e., in the grid cell with x as its top right corner. We denote the vector of all ones by $\mathbf{1}$, where the dimension will be clear from the context.

Corollary 18. *Suppose f is a violation-free DMAC instance. If $x \in G$ is a fixed point of f other than the least fixed point of f , there exists a fixed point other than x in $L(x - \mathbf{1}, x)$.*

Proof. Let $x \in G$ be a fixed point of f that is not the least fixed point. Suppose for the sake of contradiction that $y \in G$ is the nearest lesser fixed point to x and $\|y - x\|_\infty > 1$. Then we can apply Lemma 17 to conclude that there exists a fixed point $z \in G$ with $y \leq z \leq x$ and $\|z - x\|_\infty < \|y - x\|_\infty$, which is a contradiction to y being the nearest lesser fixed point to x . \square

The verification algorithm. We have so far proved that if x is not a least fixed point, then there is another fixed point y that is in the d -dimensional cube below x at distance 1. We now provide an algorithm that, in a violation-free instance, finds y if it exists. Therefore if the algorithm does not find a lesser fixed point, it certifies that x is the least fixed point.

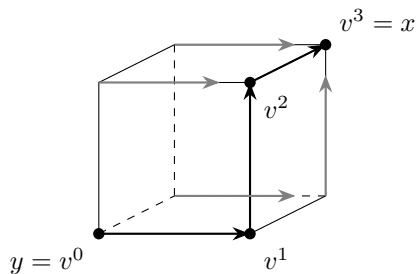

Figure 12: A verification sequence for x , where $(v^i := \text{VSeq}(x)_i)_{i=0}^k$. The black arrows are the witnesses to each of the verification sequence points not being fixed, and the gray arrows are the directions of the displacements that must exist at every point on the cube that are implied by the verification sequence displacements.

Let us start by considering the point $y = x - \mathbf{1}$, which is shown as v^0 in Figure 12.

- If y is a fixed point, then y is a fixed point that is less than x , which proves that x is not the least fixed point. So we can terminate.
- Otherwise, observe that we cannot have $f_i(y) < y_i$ in any dimension i , since this would be a violation of non-expansion with x . Since y is not fixed, it must therefore be the case that $f_i(y) > y_i$ for at least one dimension i . In Figure 12, this is represented by the edge from v^0 to v^1 .
- By monotonicity, any point $y' \geq y$ such that $y'_i = y_i$ must also satisfy $f_i(y') > y'_i$ and so y' is also not a fixed point. This allows us to rule out an entire face of the cube that lies beneath x , since no vertex of that face can contain a fixed point.
- Using this idea, we can walk a sequence of d steps in the cube beneath x . In Figure 12, v^1 is the point we reach after the first step of this sequence. When we reach a new point in the sequence, either it is fixed, and we have shown that x is not the least fixed point, or we rule out a face, move to the new point and repeat. If we reach x then we have proven that it is indeed the least fixed point.

To recap, in Figure 12, we start at $v^0 = y$, and the fact that $f(v^0)$ points right allows us to rule out the left face of the cube. The directions for f implied by monotonicity are shown in gray pointing away from that left face. We then move to v^1 , which is the least vertex of the remaining cube. Since $f(v^1)$ points up, we rule out the bottom face (of the right face), indicated by the black arrow and implied gray arrow that point from bottom to top. We are now at v^2 , and the arrow from v^2 to $v^3 = x$ complete the verification of x as the least fixed point.

We now prove formally that this approach works.

Lemma 19. *Suppose f is a violation-free DMAC instance. Given a fixed point of f , $x \in G$, we can verify in polynomial time whether x is the least fixed point.*

Proof. By Corollary 18, to check whether x is the least fixed point we need only to verify whether there is a lesser fixed point in $L(x - \mathbf{1}, x)$. Let $y := x - \mathbf{1}$. We will use Algorithm 1.

This algorithm runs in time that is polynomial in the representation of f . To see this, we first note that the representation of f must be of size at least d , which is the number of dimensions, because the input to f is of size $d \cdot \log n$. The algorithm makes at most d queries to f in total, noting that each query gives back the direction of all d edges at the current point in the verification sequence that we are

Algorithm 1: Algorithm to find a lesser fixed point.

```

1 procedure FindLesserFixedpoint( $f, y, x$ );
   Input :  $f, y, x$  satisfying  $f(x) = x$ ,  $y \leq x$ ,  $\|y - x\|_\infty = 1$ .
   Output: A fixed point  $z < x$  in  $L(y, x)$  if one exists, or  $x$  otherwise.
2 if there exists an  $i$  such that  $x_i > y_i$  and  $f_i(y) > y_i$  then
3   | return FindLesserFixedpoint( $f, y + e_i, x$ )
4 else
5   | return  $y$ 
6 end

```

building. We only use polynomial time to process such a point, to find one of the relevant edges that points away from the point if it exists, or to declare this point as the lesser fixed point that disproves that x is the least fixed point.

To see that the algorithm is correct, observe that if the condition on line 2 is true, then every point z_i on $L(y, x)$ with $z_i = y_i$ must have $f_i(z) > z_i$ by monotonicity, so none of those points can be fixed. Thus, any lesser fixed point must be contained on the sublattice $L(y + e_i, x)$. \square

Verification sequences. We will say that a fixed point x of f is a *verified* least fixed point (LFP) if our algorithm from Lemma 19 did not find a lesser fixed point in the cube below x . We should note that this only implies that x is the LFP if the instance has no violations. In an instance with violations, there may be verified LFPs that are not actually LFPs. We will deal with this point when we deal with the violation cases in our containment result.

As can be seen in Figure 12, the algorithm generates a sequence of points while verifying x . We refer to this sequence as x 's *verification sequence*, which we define as follows.

Definition 20 (Verification sequence). Given a verified LFP $x \in G$, let $\mathbf{VSeq}(x)$ we define the sequence of points encountered in the recursive calls to `FindLesserFixedpoint` when verifying x against the entire domain, i.e., where all coordinates of x and the initial y differ, as:

$$y = \mathbf{VSeq}(x)_0 < \mathbf{VSeq}(x)_1 < \dots < \mathbf{VSeq}(x)_d = x.$$

In our reduction from DMAC to OPDC in the next section, we will run `FindLesserFixedpoint`(f, y, x) in a slice rather than the entire domain, i.e., with a number of coordinates of y and x being identical. As a result, the verification sequence we get will have fewer than d points.

5.3 Reducing DMAC to OPDC

We will show UEOPPL containment by giving a polynomial-time reduction to the *One Permutation Discrete Contraction* problem (OPDC), which is known to lie in UEOPPL [14]. The containment result for DMAC in turn implies that `MonotoneContraction` is also in UEOPPL.

OPDC which we define formally below, like DMAC, uses as discrete grid as its domain. Our reduction from DMAC to OPDC will preserve the domain. The definition of OPDC uses the concept of i -slices, which we describe next. The same concept also applies to DMAC instances, and after we have defined OPDC, we will revisit DMAC and prove some properties about least fixed points and i -slices, before we present our reduction from DMAC to OPDC.

5.3.1 One Permutation Discrete Contraction

A *slice* refers to a subset of the grid domain where some of the dimensions are fixed. A slice s is obtained by fixing some coordinates, while letting the rest vary. We denote by $\mathbf{Slice}_d = ([0, 1] \cup \{*\})^d$ the set of all possible slices in dimension d . For a slice $s \in \mathbf{Slice}_d$, every point p within s must obey $p_i = s_i$ whenever $s_i \neq *$. A slice s is an i -*slice* if the first i -coordinates are not fixed, i.e., $s_1 = s_2 = \dots = s_i = *$, and the remaining coordinates are fixed, i.e., $s_j \neq *$ for $j > i$. Given a point $x \in G$, we write $\mathbf{slice}_i(x)$ for the unique i -slice containing x , so $\mathbf{slice}_i(x) = (*, \dots, *, x_{i+1}, \dots, x_d)$. We use $\mathbf{free}(s) \subseteq [d]$ to denote the coordinates of s set to $*$ and $\mathbf{nonfree}(s)$ to denote the coordinates that are not set to $*$. Given a slice s , we say that a slice s' is a *subslice* of s , denoted by $s' \subseteq s$ if $s'_j = s_j$ for each $j \in \mathbf{nonfree}(s)$, and $\mathbf{free}(s') \subseteq \mathbf{free}(s)$.

We are now ready to define the OPDC problem.

Definition 21 (OnePermutationDiscreteContraction). Given a family of direction functions $D = (D_i)_{i=1,\dots,d}$ over a domain $[k_1] \times [k_2] \times \dots \times [k_d]$, output one of the following:

- (O1) A point x such that $D_i(x) = \mathbf{zero}$ for all $i \in [d]$.
- (OV1) An i -slice s and two distinct points x, y on s such that $D_j(x) = D_j(y) = \mathbf{zero}$ for all $j \leq i$.
- (OV2) An i -slice s and two points x, y on s such that $x_i = y_i + 1$, $D_j(x) = D_j(y) = \mathbf{zero}$ for all $j < i$ and $D_i(x) = \mathbf{down}$, $D_i(y) = \mathbf{up}$.
- (OV3) An i -slice s and a point x on s such that $D_j(x) = \mathbf{zero}$ for $j < i$ and either
 - $x_i = 0$ and $D_i(x) = \mathbf{down}$, or
 - $x_i = k_i$ and $D_i(x) = \mathbf{up}$.

The high-level idea of the problem is that it encodes an instance in which every i -slice has a unique fixed point. Moreover, given a fixed point x of an i -slice, the function $D_i(x)$ should tell us the direction to move in dimension i to reach the unique fixed point of the $(i + 1)$ -slice that contains x .

Since every i -slice should have a unique fixed point, this means that the d -slice $(*, *, \dots, *)$ has a unique fixed point. Solutions of type (O1) ask us to find this point.

The violation solutions encode ways in which our promise might fail to be satisfied. Violations of type (OV1) encode a situation in which a single i -slice has two different fixed points, meaning that the fixed point is not unique. Violations of type (OV2) ask us to find two points in an i -slice that are adjacent in dimension i that point toward each other in dimension i . Since both of these points are required to point toward the fixed point of the $(i + 1)$ -slice, that fixed point should lie between the two points, so the violation captures the scenario where that fixed point is missing. Violations of type (OV3) ask us to find i -slice fixed points whose directions point outside the instance, meaning that the direction function fails to point towards the $(i + 1)$ -slice's fixed point.

5.3.2 Useful properties of DMAC i -slice least fixed points

Before we present the reduction, we first show some useful properties of least fixed points in violation-free DMAC instances.

Given a DMAC instance f and an i -slice s , we say that a point x is an i -fixed point if $f_j(x) = x_j$ for all $j \leq i$, or in other words, if x is a fixed point when we disregard all fixed dimensions of the i -slice.

The first observation is that if we have an i -fixed point x of an i -slice, and we consider any $j \geq i + 1$, then both of the neighbouring i -slices, where for we increase or decrease the value of the fixed coordinate x_j by 1, have i -fixed points that are within ℓ_∞ distance 1 of x . In the following lemmas, given j , we will denote these neighbouring slices of an i -slice s by $s' = s \pm e_j$, and similarly as $s \pm k \cdot e_j$ for integer k with $|k| > 1$ for neighbours that are further away. This lemma follows from Tarski's theorem, Theorem 13.

Observation 22. *Suppose that f is a violation-free DMAC instance. Let $i, j \in [d]$ with $j \geq i + 1$. If x is a fixed point of $s = \text{slice}_i(x)$, then for both of neighbouring slices $s' = s \pm e_j$, there exists an i -fixed point y of the neighbouring slice such that $\|y - x\|_\infty = 1$.*

Proof. The same proof works for either slice, $s' = s - e_j$ or $s' = s + e_j$. Assume s' is one of them, and let $R := B(x, 1) \cap s'$. For every point $y \in R$ we must have $f(y) \in R$, since otherwise we have a (DV2) violation of non-expansion. Since f is monotone on the whole domain it is also monotone on R . Thus, we have satisfied the conditions of Tarski's theorem for f on R , which guarantees the existence of the claimed fixed point. \square

We can show the same property for least fixed points: if x is the LFP of an i -slice, then the LFPs of the neighbouring i -slices must be within distance 1 of x . We can see an illustration in Figure 13, where d cannot be the LFP of s' because, by Observation 22 we know that at least one of a, b or c , which are below d , must be fixed in s' .

Lemma 23. *Suppose f is a violation-free DMAC instance. Let $i, j \in [d]$ with $j \geq i + 1$. If x is the LFP of $s = \text{slice}_i(x)$ and y the LFP of a slice $s' = s \pm e_j$, then $\|y - x\|_\infty = 1$.*

Proof. By Observation 22, there must be a fixed point z on s' with $\|x - z\| = 1$ and a fixed point z' on s with $\|y - z'\| = 1$. Suppose there is a coordinate l such that $y_l \leq x_l - 2$. Then $z' \not\geq x$, which contradicts x being the LFP of s . Suppose there is a coordinate l such that $x_l \leq y_l - 2$. Then $z \not\geq y$, which contradicts y being the LFP of s' . We conclude that $\|y - x\| = 1$. \square

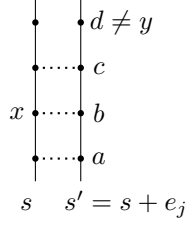

Figure 13: Distance between LFPs of neighboring slices. The LFP y of s' could be at a , b , or c , but cannot be a d as it is too far away from x .

As a corollary of this, if we have two i -slices that differ by k in dimension $j \geq i + 1$, then the LFPs of these slices can have distance at most k from one another.

Corollary 24. *Suppose f is a violation-free DMAC instance. Let $i, j \in [d]$ with $j \geq i + 1$. If x is the LFP of $s = \text{slice}_i(x)$ and y the LFP of $s' = s \pm k \cdot e_j$, with $k \in \mathbb{N}$, then $\|y - x\|_\infty \leq k$.*

Proof. The same proof works for either slice, $s' = s - k \cdot e_j$ or $s' = s + k \cdot e_j$. We proceed by induction on k . Let z be the LFP of the slice $s \pm (k - 1)e_j$. The base case $k = 1$ holds by Lemma 23. Then $\|z - x\|_\infty = (k - 1)$ by the inductive hypothesis and $\|y - z\|_\infty = 1$ by Lemma 23. Thus we have:

$$\|y - x\|_\infty \leq \|z - x\|_\infty + \|y - z\|_\infty = (k - 1) + 1 = k,$$

which completes the induction and proves the claim. \square

Least fixed points are hereditary. The most important result for our construction will be that LFPs are hereditary. Specifically, if x is the LFP of a slice s , then it is the LFP of all subslices $s' \subseteq s$. In order to prove this, we first prove the following technical lemma.

Lemma 25. *Suppose that f is a violation-free DMAC instance, and that y, x are such that $y < x$ and $\|y - x\|_\infty = 1$. Let s' be the smallest slice that contains both y and x , i.e., $\text{free}(s') = \{j : j \in [d], y_j \neq x_j\}$. Suppose that both y and x are fixed in s' , i.e. for all $j \in \text{free}(s')$, we have $f_j(y) = y$ and $f_j(x) = x$. Moreover, suppose that there exists $i \in \text{nonfree}(s')$ such that x is fixed in dimension i and y is not fixed in dimension i , i.e., $f_i(x) = x_i$ and $f_i(y) \neq y_i$. Then the point $z = y - e_i$ is fixed in the slice s with $\text{free}(s) = \text{free}(s') \cup \{i\}$.*

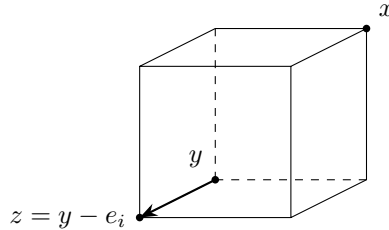

Figure 14: An illustration of Lemma 25.

Proof. By assumption $f_i(y) \neq y_i$. If $f_i(y) > y_i$, we would have a violation of monotonicity, since, by assumption $f_i(x) = x_i$ and $y < x$. Thus, we have $f_i(y) < y_i$ (shown as the arrow in Figure 14).

Now consider the point $z = y - e_i$. We have that:

- For all $j \in \text{free}(s)$, if $f_i(z) < z_i$ we would have a violation of non-expansion with x , since then we would have $|f_i(z) - f_i(x)| > \|z - x\|_\infty$.
- For all $j \in \text{free}(s)$, if $f_i(z) > z_i$, we would have a violation of monotonicity with y , since $z < y$ and the fact that $f_i(y) < y_i$, which we have already shown.

Thus $f_j(z) = z_j$ for all $j \in \text{free}(s)$, so z is fixed in slice s as claimed. \square

Now we can prove that LFPs are hereditary.

Theorem 26. *Suppose f is a violation-free DMAC instance. If x is the LFP of a slice s , it is also the LFP of all subslices $s' \subseteq s$ that contain x .*

Proof. Suppose x is not the LFP of a subslice s' that contains x . Then, by Corollary 18, there exists a fixed point y of s' below x in s' with $\|y - x\|_\infty = 1$. Moreover, by assumption y is not fixed in s as this would contradict the leastness of x . Let i be a dimension of $\text{free}(s)$ that is fixed at x but not y . Then Lemma 25 applies and says that $z = y - e_i$ is fixed in s . But z is below x , which contradicts that x is the LFP of s . \square

5.3.3 A reduction for the DMAC promise problem

As a warm-up, we first present a reduction from DMAC to OPDC where we assume that the DMAC instance has no violations, and we produce an OPDC instance that has no violations.

First, we define a predicate that will be used in constructing the direction function:

$$\text{IsLFP}(x, i) := [x = \text{FindLesserFixedpoint}(g, y, x)].$$

This predicate returns true whenever the `FindLesserFixedpoint` algorithm verifies that it is the least fixed point of its i -slice.

Note that we initialize the algorithm to with a point $y = x - \mathbf{1}_{\text{free}(\text{slice}_i(x))}$ for some i , so that algorithm is run within the i -slice s , and ignores all other dimensions, $\text{nonfree}(s)$.

Like in DMAC, the OPDC problem, defined formally below, also uses a discrete grid as its domain, and our reduction will not change the domain, which we will simply refer to as G for both problems. Starting from a DMAC with function f , our reduction first defines h similarly as we did in Section 4.

Definition 27. Given a DMAC function $f : G \rightarrow G$ with all displacements of length at most 1, for all $x \in G$ and $i \in [d]$ we define:

$$h_i(x) = f_i(x) - x_i.$$

The function for the overall displacement is thus $h(x) := (h_1(x), h_2(x), \dots, h_d(x))$. We proceed to define a function capturing the direction of f , indicated by the sign of h .

Definition 28. Given function $h_i : G \rightarrow \{\pm 1, 0\}$, for any $i \in [d]$, we define the *direction function* D_i as:

$$D_i(x) := \begin{cases} \text{up} & \text{if } h_i(x) = 1 \\ \text{down} & \text{if } h_i(x) = -1 \text{ or } h_i(x) = 0 \wedge \neg \text{IsLFP}(x, i) \\ \text{zero} & \text{if } h_i(x) = 0 \wedge \text{IsLFP}(x, i) \end{cases}$$

The idea here is that the direction points up whenever $f_i(x)$ points above x_i , and it points down whenever $f_i(x)$ points below x_i . When $f_i(x)$ points to x_i , we must be more careful: here we force D_i to point down, unless x is the least fixed point of the i -slice. This allows us to ensure that the i -slice has a unique fixed point, and our ability to determine whether a fixed point is a least fixed point is crucial here.

We refer to a point x such that $D_j(x) = \text{zero}$ for $j \leq i$ as an i -zero of D .

The following lemma formally proves that each i -slice has a unique i -zero. This implies that there is a unique (O1) solution, and rules out any (OV1) violations. Note also that an (O1) solution is a (D1) solution of the DMAC instance, since we have $D_j(x) = \text{zero}$ for all j only if $h_j(x) = 0$ for all j .

Lemma 29. *If f has no violation solutions, then D has a unique i -zero in each i -slice.*

Proof. Assume that f has no violation solutions. Any violation solution in a slice translates to a violation in f , hence restricting f to a slice implies that no properties are violated within each i -slice. We fix an i -slice s . Based on the monotonicity assumption, we can apply Tarski's theorem and get that f has a unique least fixed point in s , which we will denote by x . Monotonicity must additionally hold for any subslice $s' \subseteq s$ of the i -slice and the theorem can be similarly applied. Since x is the LFP of $\text{slice}_j(x)$, for each $j \leq i$, we have that $h_j(x) = 0$ and hence $D_j(x) = \text{zero}$. By Theorem 26, we have that x is the LFP of $\text{slice}_j(x)$ whenever it is the LFP of $\text{slice}_i(x)$, so we get that x is an i -zero of D .

Now suppose that there is another i -zero of D , $y \neq x$. In order for y to be an i -zero, we must have that y is the LFP of $\text{slice}_i(x)$, which is a contradiction. We conclude that x is the unique i -zero of D . \square

As an immediate corollary we get the following.

Corollary 30. *If f has no violation solutions, then D has no (OV1) violations.*

The next lemma shows that the direction function at each i -zero points towards the $(i - 1)$ -zero of the $(i - 1)$ -slice. This rules out any (OV2) solutions and crucially relies on the absence of violations in f .

Lemma 31. *Suppose that f has no violations. Let s' be an $(i - 1)$ -slice and s an i -slice, with $s' \subseteq s$. Let x be the unique i -zero of s , and y be the unique $(i - 1)$ -zero of s' . Then $D_i(y) = \text{up}$ if $y_i < x_i$, $D_i(y) = \text{down}$ if $y_i > x_i$.*

Proof. Suppose that f , x , y , s and s' satisfy the conditions of the lemma. Since x is the unique i -zero of s , it must hold that $D_j(x) = \text{zero}$ for all $j \leq i$, which in turn means that x is the LFP of s' .

Now assume that $y_i < x_i$. We want to show that this implies $D_i(y) = \text{up}$. Towards a contradiction, suppose $D_i(y) = \text{down}$. Note that $h_i(y) = 0$ would imply that y is an i -zero of s , but that contradicts the fact that x is the unique i -zero of s . This, we must have $h_i(y) = -1$. Note that since x is the unique i -zero of s , we have $D_i(x) = \text{zero}$ and thus $h_i(x) = 0$. Now we apply Corollary 24 with $j = i$ and $k = |y_i - x_i|$, which tells us that the ℓ_∞ distance between x and y is at most k . Thus we have

$$f_i(x) - f_i(y) = (x_i + h_i(x)) - (y_i - h_i(y)) = (x_i - y_i) + 1 = \|x - y\|_\infty + 1.$$

But this means that $\|f(x) - f(y)\|_\infty > \|x - y\|_\infty$, which is an (DV2) violation of non-expansion, contradicting the fact that f is violation free.

The proof for the case that $y_i > x_i$ is symmetric, and the proof is complete. \square

Since an i -slice has a unique fixed point by Lemma 29, and we have just shown that the i -zeros of $i - 1$ slices must point this fixed point in dimension i , we get as an immediate corollary that we get the following.

Corollary 32. *If f has no violation solutions, then D has no (OV2) violations.*

The fact that there are no (OV3) violations follows from the fact that f maps points on the grid to other points on the grid. This means that f can never move to a point outside the grid, and so our reduction will never create an (OV3) violation.

So we have proved that, if f has no violations, then the reduction will produce an instance with a unique (O1) solution that maps back to the LFP of f , and that there cannot be any violation solutions.

This establishes the following theorem.

Theorem 33. *There is a polynomial-time reduction from the promise version of DMAC to the promise version of OPDC.*

5.3.4 The full reduction: handling violations

We now give a full reduction between the non-promise versions of the problems. The reduction itself will be identical to the reduction used in the previous section, but we must now handle the case where the function f has violations. We recall that now when we say “verified LFP” this is only a *purported* LFP, as due to violations a successful run of the verification procedure does not mean that the inputted candidate LFP really is one. Nonetheless we still have the (full) verification sequence from the “successful” run of the verification procedure and will use this sequences to produce violations in the original DMAC instance in certain cases when we get a violation in our produced OPDC instance.

We produce that OPDC instance in exactly the same way as we did in the last section. Our arguments from the promise reduction still imply any solution of type (O1) can be mapped back to a solution of type (D1), but in contrast to the previous section, the OPDC instance may contain violation solutions, and we must map these back to violations of the DMAC instance.

In the rest of this section, we prove the following theorem.

Theorem 34. *There is a promise-preserving polynomial time reduction from DMAC to OPDC.*

We note that (OV3) violations are impossible by definition. This is because such a violation would have the direction function pointing outside the whole domain, but that is not possible since f maps G to itself in DMAC. Thus we rule out (OV3) violations.

We do need to deal with (OV1) violations and (OV2) violations. We consider each separately in the following two sections, and in each case we show that these violations can be efficiently mapped back to violations of DMAC. For both (OV1) and (OV2) violations, we may produce either (DV1) or (DV2) violation.

Handling (OV1) violations. Recall that in an (OV1) violation we are given two distinct i -zeros x and y of the same i -slice. This could not happen if the original DMAC instance was violation free because it would mean that the slice has two LFPs, which is impossible. Thus there must be some violation in the original DMAC instance. We will give a polynomial-time algorithm to find one such violation. We do this by considering three cases: where x and y are comparable and within distance 1; comparable but further apart; incomparable. The following lemmas will allow us to deal with these cases.

The next lemma deals with the case that the points are within distance 1 of each other so that one point is within the verification cube of the other. In this case we will produce a (DV1) violation of monotonicity in polynomial time.

Lemma 35. *Suppose we are given points x and y on slice s satisfying:*

1. x is a verified LFP of s ;
2. $y < x$ and $y \in L(x - \mathbf{1}, x)$; and
3. $f_i(y) - y_i \leq 0 \quad \forall i \in \text{free}(s)$.

Then we can find a violation of type (DV1) in polynomial time.

Proof. Let $k := |\text{free}(s)|$. Since x is a verified LFP, there is a verification sequence $x - \mathbf{1} = v^0 \leq v^1 \leq \dots \leq v^k = x$. Let i be the index such that $y \in L(v^i, x)$ but $y \notin L(v^{i+1}, x)$, which must exist since $y < x$ and $y \in L(x - \mathbf{1}, x)$. Let j be the dimension in which v^i and v^{i+1} differ. Since the verification algorithm moved from v^i to v^{i+1} , we have $f_j(v^i) > v_j^i$. By assumption 3, it must hold that $f_j(y) \leq y_j$, as j is a free dimension of the slice. Since v^i is the minimum element of $L(v^i, x)$ we have $v^i \leq y$ by definition of i . However, $f_j(v^i) \not\leq f_j(y)$, which corresponds to violation of type (DV1). \square

The next case is where x and y are comparable, with $y \leq x$, but they are not within distance 1 of each other. In this case, we will produce in polynomial time either a (DV1) monotonicity violation, or a (DV2) violation of non-expansion.

Lemma 36. *Suppose we are given points x and y on slice s satisfying:*

1. x is a verified LFP of s ;
2. $y < x$ and $y \notin L(x - \mathbf{1}, x)$; and
3. $f_i(y) - y_i \leq 0 \quad \forall i \in \text{free}(s)$.

Then we can find a violation of type (DV1) or (DV2) in polynomial time.

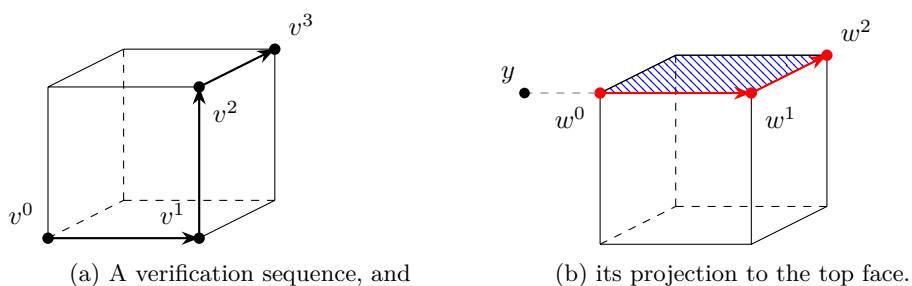

Figure 15: A verification sequence in (a) and its projection in (b), as used in the proof of Lemma 36. Here w^0 has a positive displacement towards w^1 because v^0 goes to v^1 and w^0 is directly above v^0 . Note that v^1 and v^2 are both projected to w^1 .

Proof. Suppose $y \leq x$ and $y \notin L(x - \mathbf{1}, x)$. Let s' be the unique minimal slice containing $L(y, x)$, i.e., where $\text{free}(s') = \{j : j \in [d], x_j \neq y_j\}$. Let $m := |\text{free}(s)|$. We have a verification sequence for x on slice s , say v^0, v^1, \dots, v^m . We do an orthogonal projection of this sequence onto s' , i.e., onto the hyperplane determined by the fixed coordinates of s' . Figure 15 provides an illustration.

Observe that if $v^{i+1} - v^i$ was normal to the hyperplane passing through s' , two points of the original verification sequence might be projected to the same point on s' . We define the sequence w^0, w^1, \dots, w^k as the distinct points of the projected sequence, where $k \leq |\text{free}(s')|$.

For $i \in [k]$, let $d_i \in \text{free}(s')$ denote the dimension travelled to get from w^{i-1} to w^i , so $w^i - w^{i-1} = e_{d_i}$. Every transition in the original verification sequence points upwards by definition, and if this does not persist after the projection, i.e., if there is any $i \in [k]$ such that $f_{d_i}(w^{i-1}) - w_{d_i}^{i-1} \not\geq 0$, then w^{i-1} together with its unique analogue in the original v sequence that went up in dimension d_i witness a (DV1) violation.

Thus, we now assume that $f_{d_i}(w^{i-1}) - w_{d_i}^{i-1} > 0$ for all $i \in [k]$.

Given two points $a, b \in G$, for $z = a - b$, let $\text{bind}(z)$ be the dimensions with largest absolute value: $\text{bind}(z) := \{i : \|z\|_\infty = |z_i|\}$. Since $\|y - x\|_\infty \geq 1$, there must be a step in the projected verification that increases that distance from y by 1, i.e., there exists a $j \in [k]$ such that:

$$\|y - w^j\|_\infty = \|y - w^{j-1}\|_\infty + 1.$$

For the binding dimension $d_j \in \text{bind}(w^{j-1} - y)$, we know that $f_{d_j}(w^{j-1}) - w_{d_j}^{j-1} > 0$. However, by assumption $f_{d_j}(y) - y_{d_j} \leq 0$, which leads to

$$|f_{d_j}(w^{j-1}) - f_{d_j}(y)| > |w_{d_j}^{j-1} - y_{d_j}|$$

which means that w^{j-1} and y constitute a violation of type (DV2). \square

The final case is for when x and y are incomparable. Here we will generate a new point z that is comparable (and beneath) both x and y . We then show that if we do not get a violation of monotonicity when we consider each relevant dimension in turn, then we can use either the pair x and z or the pair y and z with one of the two Lemmas 35 and 36 to produce the desired violation.

Lemma 37. *If x and y are both verified LFPs of an i -slice s , and x and y are incomparable, then we can find a violation of type (DV1) or (DV2) in polynomial time.*

Proof. We construct a point z such that, for each dimension $i \in [d]$, $z_i = \min(x_i, y_i)$. Since x and y are incomparable, we have $z < x$ and $z < y$. We consider each dimension $i \in \text{free}(s)$ in turn. If $z_i = x_i$ and $f_i(z) - z_i > 0$, we have a violation of type (DV1) between z and x , since $z < x$ and $f_i(z) > f_i(x)$. If $z_i = y_i$ and $f_i(z) - z_i > 0$, we have a violation of type (DV1) between z and y . If we do not find a violation through this process, then we have $f_i(z) - z_i \leq 0$ for all dimensions $i \in \text{free}(s)$.

Now we can pick the pair x and z or the pair y and z ; the argument is completely analogous in both cases. Let us take x and z . Now if $z \in L(x - \mathbf{1}, x)$ we can apply Lemma 35 to get the desired (DV1) or (DV2) violation; else $z \notin L(x - \mathbf{1}, x)$ and we can apply Lemma 36 to get the desired violation. \square

With the preceding three lemmas we have covered all possible cases and thereby shown the following.

Lemma 38. *If there exists a violation of type (OV1), then we can find a violation of type (DV1) or (DV2) in polynomial time.*

Handling (OV2) violations. We now turn to (OV2) violations, where we are given i -zeros from adjacent slices, that point towards each other in dimension $i + 1$.

As a first step, we show that, if we have a fixed point of an i -slice s , then for the slices s' that are adjacent to s , we can either find a fixed point of s' , or find a violation of the DMAC instance.

Lemma 39. *Suppose that x is an i -fixed point of some i -slice s . Let s' be an adjacent i -slice containing $y = x \pm e_{i+1}$. Then we can in polynomial time find either:*

1. an i -fixed point z of s' such that $\|z - y\|_\infty \leq 1$; or
2. a (DV1) or (DV2) violation.

Proof. Let $Z := B(x, 1) \cap s'$, and let z^0 be the bottom corner of Z . Starting from z^0 , we iterate f , which, for each $t = 1, 2, \dots$, gives a new point $z^t = f(z^{t-1}) = f^t(z^0)$. We conclude the process when one of the following conditions is met:

1. $z^t \not\geq z^{t-1}$;
2. $z^t \notin Z$;
3. z^t is an i -fixed point of s' .

First note that either $z^0 \leq f(z^0)$, or we have a (DV2) violation of non-expansion between z^0 and x , which is fixed in s . So, suppose we have $z^0 \leq f(z^0) = z^1$. Now, for $t > 1$, if the first condition is ever met, we have that $f(z^{t-1}) \not\leq f(z^{t-2})$ but $z^{t-1} \geq z^{t-2}$, which contradicts monotonicity of f and is a violation of type (DV1).

Next, note that if the second condition is ever met, we have a non-expansion violation of type (DV2) between z^{t-1} and x since $\|f(x) - f(z^{t-1})\|_\infty > 1$ while $\|x - z^{t-1}\|_\infty = 1$.

Finally, we observe that at most $2d$ iterations can be performed until the third condition is met, assuming that neither the first or second condition was met during the process. To see this note that in each iteration we have $z^t > z^{t-1}$, which implies that at least one coordinate of z^t has increased by 1 from z^{t-1} . But this can only happen at most $2d$ times since $B(x, 1)$ has width 2 in each dimension. The i -fixed point that we find in this case is the z that we are looking for, where the condition $\|z - y\|_\infty \leq 1$ follows from the definition of Z . This completes the proof. \square

We now use this lemma to show that we can handle all (OV2) violations.

Lemma 40. *If there exists a violation of type (OV2), then we can find a violation of type (DV1) or (DV2) in polynomial time.*

Proof. Let x and y be the witness of the (OV1) violation, so both are $(i-1)$ -zeros of an i -slice s , we have $x_i = y_i + 1$, and $D_i(x) = \text{down}$, $D_i(y) = \text{up}$. Since $x_i = y_i + 1$, we have that $\|x - y\|_\infty \geq 1$. We consider two cases:

1. There exists a $j \in \text{free}(s)$ such that $|x_j - y_j| \geq 2$.
2. For all $j \in \text{free}(s)$ we have $|x_j - y_j| \leq 1$.

We start with the first case, where there exists a $j \in \text{free}(s)$ such that $|x_j - y_j| \geq 2$. Suppose that $y_j \leq x_j - 2$ (the case $x_j \leq y_j - 2$ is symmetric). We use Lemma 39 to either find a DMAC violation, in which case we are done, or to find a fixed point z of the $(i-1)$ -slice that contains $y + e_i$ such that:

$$\|z - (y + e_i)\|_\infty \leq 1.$$

Observe that $z_j \leq x_j - 1$, which is implied by $\|z - (y + e_i)\|_\infty \leq 1$ and $y_j \leq x_j - 2$. Now consider the verification sequence of x , which we denote by v^0, v^1, \dots, v^k . There must be a $l \in [k]$ such that $v^l = v^{l-1} + e_j$, but now v^{l-1} and z are a (DV2) violation of non-expansion since $f_j(z) = z_j$ as z is an $(i-1)$ -fixed point of s , and j belongs to $\text{free}(s)$ while also being the binding dimension for $\|v^{l-1} - z\|_\infty$. That completes the proof for the first case.

We now consider the second case where $|x_j - y_j| \leq 1$ for all $j \in \text{free}(s)$. We consider two sub-cases.

1. We have $x_j = y_j$ for all $j \in \text{free}(s)$. In this case x and y are right next to each other and differ only in dimension i , so $y < x$. But then the fact that $D_i(x) = \text{down}$ and $D_i(y) = \text{up}$, together with the fact that x and y are $(i-1)$ -zeros, means that $f(x) < f(y)$, so we have a (DV1) violation of monotonicity and we are done with this sub-case.
2. There exists a $j \in \text{free}(s)$ such that $|x_j - y_j| = 1$.

For the second sub-case, we analyse two further sub-cases.

First, suppose that there exists a $j \in \text{free}(s)$ such that $x_j = y_j - 1$. Now consider the point $z := x - e_i$. Let v^0, v^1, \dots, v^k be the verification sequence for y . There must have been a point v^l that implies that z points up in dimension j , i.e., $f_j(v^l) > v_j^l$. Note that $v^l \leq z$. If $v^l \neq z$, then we now query f at z . If $f_j(z) \leq z_j$, which is only possible if $v^l \neq z$, then z and v^l are a (DV1) violation of monotonicity. If $f_j(z) > z_j$, then z and x are a (DV1) violation of monotonicity, since $z \leq x$ by definition, but $f(z) \not\leq f(x)$ since x is fixed in dimension j and $f_j(z) > z_j$.

Second, suppose that $y_j \leq x_j - 1$ for all $j \in \text{free}(s)$. In this case $y \leq x$, and the fact that $D_i(x) = \text{down}$ and $D_i(y) = \text{up}$, means that $f(y) \not\leq f(x)$, so x and y are themselves a (DV1) violation of monotonicity. This completes the proof of this final sub-case, and the proof overall. \square

By combining Theorem 33 with Lemmas 38 and 40, we have now proven Theorem 34, which in turn gives us the following.

Theorem 41. *The problem of finding the least fixed point in a DMAC instance is in UEOPL.*

6 1DUniqueDMAC and Surfaces

For the rest of the paper, which is dedicated towards deriving algorithms for DMAC, we restrict ourselves to *violation-free* DMAC instances, which are those instances that do not contain any violation solutions. We do this because it significantly simplifies our presentation and proofs, and also because we are interested in algorithms for problems like Shapley games that always produce violation-free DMAC instances.

In this section we formalize the idea of a *surface* in a DMAC instance. We do this in two steps. We first introduce the 1DUniqueDMAC problem, which is a restriction of DMAC in which it is promised that all one-dimensional slices have a unique one-dimensional fixed point. This then allows us to formally define the notion of a surface.

We show that the surfaces in a violation-free 1DUniqueDMAC instance are always monotone and have gradient at most one. Importantly, we show that the converse also holds: if the surfaces in a 1DUniqueDMAC are monotone and have gradient at most one, and if we have one other technical requirement that we will define later, then the instance is violation-free.

This gives us a useful theoretical tool that we will use throughout the rest of the paper: whenever we build a 1DUniqueDMAC instance, we do not need to laboriously prove that the instance contains no violations of monotonicity or strict contraction, because instead we can prove that the surfaces of the instance are monotone and have gradient one, which is typically much easier to verify.

6.1 Reducing DMAC to 1DUniqueDMAC

In this section we introduce a restriction of the DMAC problem in which it is promised that all one-dimensional slices have a unique one-dimensional fixed point.

Given a point x and a dimension i , we define the set $S_i(x) = \{y \in G : y = x + c \cdot e_i \text{ for some } c \in \mathbb{Z}\}$ to be the set of points in the one-dimensional slice in dimension i that contains x . We now define 1DUniqueDMAC, which is a DMAC instance in which all one dimensional slices have a unique one-dimensional fixed point.

Definition 42. We say that a DMAC instance $f : G \rightarrow G$ is a 1DUniqueDMAC instance if, $\|x - f(x)\|_\infty \leq 1$ for all $x \in G$, and if for every $x \in G$ and every i , there is exactly one point $y \in S_i(x)$ such that $f_i(y) = y_i$.

Note that we have also required that f has displacements that are at most unit length. We have already shown that we can make this assumption without loss of generality in Lemma 11.

In this section we will show the following lemma, which shows that we can reduce from a DMAC instance to a 1DUniqueDMAC instance in polynomial time. We also show that this reduction preserves the least fixed point of the instance, which will be important later when we apply our decomposition theorem.

Lemma 43. *There is a polynomial-time reduction from violation-free DMAC to violation-free 1DUniqueDMAC that preserves the least fixed point.*

We first prove the lemma for a single dimension i . We give a reduction that ensures that all one-dimensional slices in dimension i have unique fixed points. We can then simply apply this algorithm to each dimension i independently to prove Lemma 43.

Given a DMAC instance $f : G \rightarrow G$, we first apply Lemma 11 to ensure that all displacements of f have length at most 1 in the ℓ_∞ -norm, and then we define $f' : G \rightarrow G$ in the following way. For each $x \in G$ we define $f'_j(x) = f_j(x)$ for all $j \neq i$, and for dimension i we define

$$f'_i(x) = \begin{cases} x_i - 1 & \text{if } f_i(x) = x_i \text{ and } f_i(x - 1) = x - 1, \\ f_i(x) & \text{otherwise.} \end{cases}$$

This definition simply follows f unless we are at a point x that is a one-dimensional fixed point in dimension i , where x is also directly above another one-dimensional fixed point in dimension i . At any such point we alter f so that x moves one unit downwards in dimension i , which prevents x from being a one-dimensional fixed point in dimension i . It is clear that we can build f' in time that is polynomial in the representation of f .

It is also clear that f' has displacements that are at most unit length, because we applied Lemma 11 to f to ensure that it has this property, and then f' either copies the displacements of f , or introduces a unit displacement downward. The next lemma shows that the reduction correctly ensures that all one-dimensional slices in dimension i have a unique one-dimensional fixed point.

Lemma 44. *If f is violation-free, then every one-dimensional slice in dimension i in f' has a unique fixed point.*

Proof. First suppose that there is no point $y \in S_i(x)$ such that $f'_i(y) = y_i$. Since f' only removes one-dimensional fixed points, it must be the case that $f_i(y) \neq y_i$ for all $y \in S_i(x)$ as well. Let l be the least element of $S_i(x)$ and observe that we must have $f_i(l) \geq l_i$. Likewise, if g is the greatest element of $S_i(x)$ then we have $f_i(g) \leq g_i$. So we can apply binary search starting at l and g to find two adjacent points a , and $b = a + e_i$ such that $f_i(a) \geq a_i$ and $f_i(b) \leq b_i$. If either of those inequalities is weak, then we contradict the assumption that there is no point $y \in S_i(x)$ such that $f_i(y) = y_i$. If they are both strict, then x and y are a violation of monotonicity in f , which is also a contradiction.

Now suppose that there are two distinct points $x, y \in S_i(x)$ such that $f'_i(x) = x_i$ and $f'_i(y) = y_i$, and suppose without loss of generality that $x \leq y$. Note that we cannot have $y_i = x_i + e_i$, because then the definition of f' would have set $f'_i(y) = y_i - 1$. Hence, the point $y' = y - e_i$ is distinct from both x and y . The definition of f' tells us that $f_i(x) = x_i$ and $f_i(y) = y_i$, since f' never introduces a new one-dimensional fixed point, and it also tells us we do not have $f_i(y') = y'_i$ because if we did then $f'_i(y)$ would be set to $y_i - 1$. But now we can see that if $f_i(y') > y'_i$ then y' and x are a violation of contraction, while if $f_i(y') < y'_i$ then y' and y are a strict violation of contraction, both of which are contradictions. \square

The next lemma shows that the reduction is a correct reduction from violation-free DMAC to violation-free DMAC.

Lemma 45. *Every fixed point of f' is a fixed point of f . Furthermore, if f is violation-free, then f' is violation-free.*

Proof. It is clear that any fixed point of f' is a fixed point of f , since f' modifies f only by introducing strict displacements.

Next we consider violations of type (DV1). Suppose that we have two points $x, y \in G$ such that $x \leq y$ and $f'(x) \not\leq f'(y)$. If $f'(x) = f(x)$ and $f'(y) = f(y)$ then x and y witness a violation of monotonicity in f , and so we are done. If $f'_j(x) > f'_j(y)$ for some $j \neq i$, then since we have not changed dimension j , we have that x and y also witness a violation of monotonicity in f . So we can assume that the violation of monotonicity has $f'_i(x) > f'_i(y)$.

We now consider the following cases.

- If $f'_i(x) \neq f_i(x)$, then we have $f'_i(x) = x_i - 1$ from the definition of f' . But since all displacements are at most unit length, we also have $f'_i(y) \geq y_i - 1$, so we have $f'_i(x) = x_i - 1 \leq y_i - 1 \leq f'_i(y)$, which contradicts the assumption that x and y violated monotonicity.
- If $f'_i(x) = f_i(x)$ and $f'_i(y) \neq f_i(y)$ then note that we must have $x_i \geq y_i - 1$ otherwise it would be impossible for us to have $f'_i(x) > f'_i(y)$ in an instance where all displacements are at most unit length. If we define $y' = y - e_i$, then note that $f_i(y') = y'_i$ because we had $f'(y) \neq f(y)$. We now consider the following cases.
 - If $f'_i(x) = x_i - 1$ then we cannot have $f'_i(x) > f'_i(y)$ since $f'_i(y) \geq y_i - 1 \geq x_i - 1 = f'_i(x)$. So x and y are not a violation of monotonicity, which is a contradiction with our assumptions.
 - If $f'_i(x) = x_i + 1$ and $x_i = y_i - 1$ then we have $f_i(x) = f'_i(x) = x_i + 1 = y_i = y'_i + 1 = f_i(y') + 1$. Hence x and y' are a violation of monotonicity in f .
 - If $f'_i(x) = x_i + 1$ and $x_i \geq y_i$ then we have $f_i(x) = f'_i(x) = x_i + 1 \geq y_i + 1 > f_i(y) + 1$, where the final inequality holds because $f'(y) \neq f(y)$. Hence x and y are a violation of monotonicity in f .
 - If $f'_i(x) = x_i$ and $x_i = y_i - 1$ then we have $f'_i(x) = x_i = y_i - 1 \leq f'_i(y)$, which contradicts our assumption.
 - If $f'_i(x) = x_i$ and $x_i \geq y_i$ then we also consider the point $x' = x - e_i$. Note that we cannot have $f_i(x') = x'_i$ because $f'(x) = f(x)$, and we cannot have $f_i(x') < x'_i$ because this would be a violation of contraction between x and x' . Thus we have $f_i(x') > x'_i$. So we have $f_i(x') > x'_i = x_i - 1 \geq y_i - 1 = y'_i = f_i(y')$. So x' and y' are a violation of monotonicity for f .

Next we consider violations of type (DV2). Suppose that we have two points $x, y \in G$ such that $\|f'(x) - f'(y)\|_\infty > \|x - y\|_\infty$. If there exists a dimension $j \neq i$ such that $|f'_j(x) - f'_j(y)| > \|x - y\|_\infty$, then because we have not altered dimension j , the points x and y must also violate contraction in f . So we can assume that we have $|f'_i(x) - f'_i(y)| > \|x - y\|_\infty$.

If $f'(x) = f(x)$ and $f'(y) = f(y)$ then clearly x and y are a violation of contraction for f . If, on the other hand, we have $f'(x) \neq f(x)$ and $f'(y) \neq f(y)$, then note that

$$\begin{aligned} |f'_i(x) - f'_i(y)| &= |(f_i(x) - 1) - (f_i(y) - 1)| \\ &= |f_i(x) - f_i(y)|, \end{aligned}$$

because f' only ever modifies f in order to move a point that was fixed in dimension i downward. Hence x and y are again a violation of contraction in f .

So we can assume, without loss of generality, that $f'(x) = f(x)$ and $f'(y) \neq f(y)$. Since $f'(y) \neq y$ we must have $f'_i(y) = y_i - 1$ due to the definition of f' . Therefore we must have $x_i \geq y_i$, since otherwise it would be impossible for us to have $|f'_i(x) - f'_i(y)| > \|x - y\|_\infty$.

Since f' is an instance in which all displacements are at most unit length, we must have $x_i - y_i \geq \|x - y\|_\infty - 1$, because otherwise it would be impossible to have $|f'_i(x) - f'_i(y)| > \|x - y\|_\infty$. We consider the following cases.

- If $x_i - y_i = \|x - y\|_\infty - 1$ then note that we must have $f'(x_i) = x_i + 1$, because otherwise we could not have $|f'_i(x) - f'_i(y)| > \|x - y\|_\infty$. Let $y' = y - e_i$, and observe that since $f'(y) \neq f(y)$, we must have $f_i(y') = y'_i$. Also note that $x_i - y'_i = x_i - y_i + 1 = \|x - y\|_\infty$, and therefore we must have $\|x - y'\|_\infty = \|x - y\|_\infty$ because we only modified dimension i when we created y' from y . So we have

$$\begin{aligned} f_i(x) - f_i(y') &= x_i + 1 - y'_i \\ &= x_i - y_i + 2 \\ &= \|x - y\|_\infty + 1 \\ &= \|x - y'\|_\infty + 1, \end{aligned}$$

and therefore x and y' are a violation of contraction in f .

- If $x_i - y_i \geq \|x - y\|_\infty$ then note that we must have $f_i(y) = y_i$ because $f'(y) \neq f(y)$. If $f_i(x_i) = x_i + 1$, then we immediately have that x and y violate contraction in f . We cannot have $f_i(x_i) = x_i - 1$ because this would contradict the fact that $|f'_i(x) - f'_i(y)| > \|x - y\|_\infty$.

So the remaining case is where $f_i(x_i) = x_i$. Let $x' = x - e_i$ and $y' = y - e_i$. Observe that since $f'(x) = f(x)$ we cannot have $f_i(x') = x'_i$, and we also cannot have $f_i(x') = x'_i - 1$ because this would give us a violation of contraction between x and x' . So we have $f_i(x') = x'_i + 1$. On the other hand, since $f'(y) \neq f(y)$, we must have $f_i(y') = y'_i$. Note also that $\|x - y\|_\infty = \|x' - y'\|_\infty$, since x' and y' were both generated by shifting x and y by e_i . So we have

$$\begin{aligned} f_i(x') - f_i(y') &= x'_i - y'_i + 1 \\ &= x_i - y_i + 1 \\ &\geq \|x - y\|_\infty \\ &= \|x' - y'\|_\infty, \end{aligned}$$

so x' and y' witness a violation of contraction in f .

□

The reduction from f to f' can delete some of the fixed points of f , so it is not necessarily the case that every fixed point of f is also a fixed point of f' . However, in the next lemma we show that the least fixed point is preserved by the reduction.

Lemma 46. *If f is violation-free, then the least fixed point of f' is the same as the least fixed point of f .*

Proof. Let x be the least fixed point of f . We can apply the hereditariness property given in Theorem 26 to argue that x is the least one-dimensional fixed point in $S_i(x)$. Hence, if $x' = x - e_i$, then we must have $f_i(x') \neq x'_i$, and so the definition of f' implies that $f_i(x) = f'_i(x)$. Since f' only modifies dimension i this implies that $f'(x) = f(x)$, and so x is a fixed point of f' .

Lemma 44 implies that if there were a fixed point y of f' satisfying $y \leq x$, then y is also a fixed point of f satisfying $y \leq x$, which contradicts the fact that x is the least fixed point of f .

□

In summary, we have shown that the reduction correctly reduces a violation-free DMAC instance to another violation-free DMAC instance in which each one-dimensional slice in dimension i has a unique one-dimensional fixed point, and that the reduction preserves the least fixed point. We can then apply this reduction to each dimension iteratively to ensure that all one-dimensional slices have a unique one-dimensional fixed point. This is valid because the reduction never introduces a one-dimensional fixed point in any dimension, so each iteration will not destroy the properties from the previous iterations.

Thus we arrive at a violation-free DMAC instance in which all displacements are at most unit length, and in which every one-dimensional slice has a unique one-dimensional fixed point. Hence it is a 1DUniqueDMAC instance.

It is clear that this reduction can be carried out in time that is polynomial in the representation of f . In particular we note that the representation of f must be at least d , which is the number of dimensions, because the input to f is of size $d \cdot \log n$. This completes the proof of Lemma 43

6.2 Surfaces

We now formalize the concept of a surface, which we will use as a proof technique throughout the paper.

Suppose that we have a 1DUniqueDMAC instance $f : G \rightarrow G$, where $G = \{1, 2, \dots, n\}^d$, and let i be a dimension. For each $x \in G$ we define x_{-i} to be the point x with dimension i removed. We likewise define G_{-i} to be the grid G in which dimension i has been deleted. Finally, given a point $x \in G_{-i}$ and a value $a \in \{1, 2, \dots, n\}$ we define $x \circ_i a$ to be the point in G obtained by placing the value a in dimension i of x .

We use the following definition of a surface.

Definition 47 (Surface). Given a 1DUniqueDMAC instance $f : G \rightarrow G$, the surface in dimension i is the function $s_i : G_{-i} \rightarrow \{1, 2, \dots, n\}$ such that $s_i(x) = a$, where a is the unique value such that $f_i(x \circ_i a) = a$.

Intuitively, we view the unique one-dimensional fixed points in dimension i as heights that define the surface. It is of course necessary that we have a 1DUniqueDMAC instance here, because otherwise there would not necessarily be a unique value a such that $f_i(x \circ_i a) = a$, and the surface would not be well defined.

We remark that the surface function s_i is not necessarily easy to compute: in general a binary search must be carried out to find the value a that satisfies $f_i(x \circ_i a) = a$, which would take $\log n$ steps. This makes surfaces unsuitable for defining reductions, where spending $\log n$ steps to answer a single query to f would be too expensive. However, surfaces have several properties that will be useful in our proofs.

Monotonicity. We say that a surface s_i is *monotone* if, given two points $x, y \in G_{-i}$ with $x \leq y$ we have that $s_i(x) \leq s_i(y)$. We show that every surface arising from a violation-free 1DUniqueDMAC instance is monotone.

Lemma 48. *If s_i is a surface of a violation-free 1DUniqueDMAC instance, then s_i is monotone.*

Proof. Suppose for the sake of contradiction that we have two points $x, y \in G_{-i}$ such that $x \leq y$ but $s_i(x) > s_i(y)$. Let $x' = x \circ_i s_i(x)$ and $y' = y \circ_i s_i(y)$ be the points on the surface at x and y in G .

Define $z = y \circ_i s_i(x)$, and observe that $x' \leq z$. Since $f_i(x') = x'_i$ we cannot have $f_i(z) < z_i$, because then we would have $f_i(z) < z_i = x'_i = f_i(x')$, meaning that z and x' would witness a violation of monotonicity of f . We also cannot have $f_i(z) = z_i$ because y' is the unique one-dimensional fixed point of the one-dimensional slice that contains y' and z , and since $s_i(x) > s_i(y)$, we have that y' and z are distinct points. Finally if we have $f_i(z) > z_i$ then y' and z are a violation of contraction. So we have arrived at a contradiction. \square

Gradient at most one. We say that a surface s_i has *gradient at most one* if, for every pair of points $x, y \in G_{-i}$ we have that $|s_i(x) - s_i(y)| \leq \|x - y\|_\infty$. We show that every surface arising from a violation-free 1DUniqueDMAC instance has gradient at most one.

Lemma 49. *If s_i is a surface of a violation-free 1DUniqueDMAC instance, then s_i has gradient at most one.*

Proof. Suppose for the sake of contradiction that we have $x, y \in G_{-i}$ with $|s_i(x) - s_i(y)| > \|x - y\|_\infty$. Let $x' = x \circ_i s_i(x)$ and $y' = y \circ_i s_i(y)$ be the points on the surface at x and y in G . We will assume, without loss of generality, that $s_i(x) > s_i(y)$.

Define the point $z = x' - e_i$ to be the point directly beneath x in dimension i . Note that we cannot have $f_i(z) < z_i$ because then z and x' would be a violation of contraction, and we cannot have $f_i(z) = z_i$

because x' is the unique one-dimensional fixed point of the one-dimensional slice that contains x' and z . So we must have $f_i(z) > z_i$.

We now consider two cases.

- If $z_i - y'_i = \|z - y'\|_\infty$ then observe that we have $f_i(z) - f_i(y') > z_i - y'_i$ since y' lies on the surface s'_i . This means that z and y are a violation of contraction.
- On the other hand, if $z_i - y'_i < \|z - y'\|_\infty$ then observe that $\|z - y'\|_\infty = \|x - y\|_\infty$. Then we have

$$\begin{aligned} f_i(z) - f_i(y') &> z_i - y'_i \\ &= x'_i - 1 - y'_i \\ &\geq \|x - y\|_\infty \\ &= \|z - y'\|_\infty, \end{aligned}$$

where the second inequality holds because we have $x'_i - y'_i > \|x - y\|_\infty$. So z and y' are again a violation of contraction.

So in either case we have arrived at a contradiction. \square

1D rationality. We say that a 1DUniqueDMAC instance $f : G \rightarrow G$ is *1D rational* if, for every $x \in G$ and every dimension i , we have that $f_i(x) > x_i$ whenever $x_i < s_i(x_{-i})$, and we have that $f_i(x) < x_i$ whenever $x_i > s_i(x_{-i})$. Intuitively, this states that f always moves towards the surface in dimension i , and in practical terms it rules out the existence of violations within each one-dimensional slice.

The next lemma states that all violation-free 1DUniqueDMAC instances are 1D rational.

Lemma 50. *If f is a violation-free 1DUniqueDMAC instance, then f is 1D rational.*

Proof. Suppose for the sake of contradiction that we have a point x such that $x_i < s_i(x_{-i})$ and $f_i(x) \leq x_i$. Let $y = x_{-i} \circ_i s_i(x_{-i})$ be the point on the surface that lies above x in dimension i , and observe that by definition we have $f_i(y) = y_i$. We cannot have $f_i(x) = x_i$, because y is the unique fixed point of the one-dimensional slice that contains x and y . So we must have $f_i(x) < x_i$. This means that x and y are a violation of contraction, which is a contradiction.

The same argument can be applied symmetrically in the case where we have a point x such that $x_i > s_i(x_{-i})$ and $f_i(x) \geq x_i$. \square

1D rationality, monotonicity, and gradient at most one are sufficient. We have so far shown that if a 1DUniqueDMAC instance is violation-free, then the instance is 1D rational, and the corresponding surfaces are monotone with gradient at most one. We now show that the other direction also holds: if a 1DUniqueDMAC instance is 1D rational, and all surfaces are monotone with gradient at most one, then the instance is violation-free.

Lemma 51. *Let $f : G \rightarrow G$ be a 1DUniqueDMAC instance. If f is 1D rational, and if for each dimension i the surface s_i is monotone and has gradient at most one, then f is violation-free.*

Proof. We begin with (DV1) violations. Suppose for the sake of contradiction that we have $x, y \in G$ with $x \leq y$ but $f(x) \not\leq f(y)$. Let i be a dimension for which $f_i(x) > f_i(y)$.

Since f has displacements that are at most unit length, we cannot have $f_i(x) = x_i - 1$, because this would imply that $f_i(x) = x_i - 1 \leq y_i - 1 \leq f_i(y)$, which contradicts our assumption. Likewise, we cannot have $f_i(y) = y_i + 1$, because this would imply that $f_i(x) \leq x_i + 1 \leq y_i + 1 = f_i(y)$, which also contradicts our assumption. So we have $f_i(x) \geq x_i$ and $f_i(y) \leq y_i$.

Now we can apply 1D rationality to conclude that $s_i(x_{-i}) \geq x_i$ while $s_i(y_{-i}) \leq y_i$. If both of these inequalities are weak, then we have $f_i(x) = x_i \leq y_i = f_i(y)$, which contradicts our assumption. We then consider two cases.

- If $s_i(x_{-i}) > x_i$ then note that if $f_i(y) = y_i$ then we have $s_i(y_{-i}) = y_i = f_i(y)$, while if $f_i(y) < y_i$ then we have $s_i(y_{-i}) \leq y_i - 1 \leq f_i(y)$. So in either case we have $s_i(y_{-i}) \leq f_i(y)$. So we have $s_i(x_{-i}) \geq x_i + 1 \geq f_i(x) > f_i(y) \geq s_i(x_{-i})$. This implies that $s_i(x_{-i}) > s_i(y_{-i})$ despite the fact that $x_{-i} \leq y_{-i}$. So s_i is not monotone, which is a contradiction.
- On the other hand, if $s_i(y_{-i}) < y_i$ then we can apply the same argument as above with all inequalities flipped to again obtain a contradiction with the monotonicity of s_i .

We now turn our attention to violations of type (DV2). Assume for the sake of contradiction that we have a pair of points x and y points satisfying $\|f(x) - f(y)\|_\infty > \|x - y\|_\infty$. Let i be a dimension such that $|f_i(x) - f_i(y)| > \|x - y\|_\infty$. We assume, without loss of generality, that $x_i < y_i$.

Note that, since the instance has displacements that are at most unit length, we cannot have $f_i(x) = x_i + 1$, because we have $f_i(y) \leq y_i + 1$ and so we would have $|f_i(x) - f_i(y)| \leq |x_i - y_i| \leq \|x - y\|_\infty$, which contradicts our assumption. We likewise cannot have $f_i(y) = y_i - 1$ for the same reason.

So we have $f_i(x) \leq x_i$ and $f_i(y) \geq y_i$. Note that we must therefore have $s_i(x_{-i}) \leq f_i(x)$ and $s_i(y_{-i}) \geq f_i(y)$. We now consider two cases.

- If $|x_i - y_i| = \|x - y\|_\infty$ then we have $|s_i(x_{-i}) - s_i(y_{-i})| \geq |f_i(x) - f_i(y)| > |x_i - y_i| = \|x - y\|_\infty \geq \|x_{-i} - y_{-i}\|_\infty$. So x_{-i} and y_{-i} witness a violation of the fact that s_i has gradient at most one, which is a contradiction.
- If $|x_i - y_i| < \|x - y\|_\infty$ then note that we must have $|x_i - y_i| = \|x - y\|_\infty - 1$, because otherwise it would be impossible to have $|f_i(x) - f_i(y)| > \|x - y\|_\infty$ in an instance with at most unit displacements. For the same reason we must also have both $f_i(x) > x$ and $f_i(y) < y$. So we have $|s_i(x_{-i}) - s_i(y_{-i})| \geq |f_i(x) - f_i(y)| > |x_i - y_i| + 1 = \|x - y\|_\infty \geq \|x_{-i} - y_{-i}\|_\infty$, and we again contradict the fact that s_i has gradient at most one.

□

The following theorem summarizes what we have shown in this section.

Theorem 52. *Let f be a 1DUniqueDMAC instance. We have that f is violation-free if and only if f is 1D rational, and the surfaces defined by f are monotone with gradient at most one.*

Theorem 52 gives us a useful tool for showing that a 1DUniqueDMAC instance is violation-free. Instead of having to laboriously rule out each possible type of violation, it is sufficient to ensure only that the instance is 1D rational, and that the surfaces defined by the instance are monotone and have gradient at most one. We will use this theorem repeatedly as we implement reductions from 1DUniqueDMAC to 1DUniqueDMAC later on in the paper.

6.3 Forcing Boundary Points to Move Inward

We now apply the surface theorem to show that that 1DUniqueDMAC can be reduced, in polynomial time, to 1DUniqueDMAC in which all points on the boundary of the instance move strictly inward. This is a property that we will use both in our decomposition theorem and in our algorithm.

Lemma 53. *Let $G = \{1, 2, \dots, n\}^d$, and let $f : G \rightarrow G$ be a 1DUniqueDMAC instance for all x . There is a polynomial-time reduction that creates a 1DUniqueDMAC instance f' such that for all dimensions i we have $f_i(x) > x_i$ whenever $x_i = 1$ and $f_i(x) < x_i$ whenever $x_i = n$. Moreover, the least fixed point of f' can be mapped back to the least fixed point of f .*

We start by giving a reduction that ensures that $f_1(x) > x_1$ whenever $x_1 = 0$. We define the grid $G' = \{0, 1, \dots, n\} \times \{1, 2, \dots, n\}^{d-1}$, meaning that we have extended dimension 1 downward by one unit.

We define $f' : G' \rightarrow G'$ in the following way.

$$f'(x) = \begin{cases} f(x + e_1) & \text{if } x_1 = 0, \\ f(x) & \text{otherwise.} \end{cases}$$

This ensures by construction that $x_1 < f_1(x)$ for all x with $x_1 = 0$.

The following lemma justifies this operation. It shows that the transformation does not introduce any new fixed points, and if the original instance was violation-free, then the new instance will be violation-free as well.

Lemma 54. *A point is a fixed point of f' if and only if it is a fixed point of f . Moreover, if f is violation-free, then f' is also violation-free.*

Proof. Since f' does not alter f on the points in G , it is clear that any fixed point of f' in G is also a fixed point of f and vice versa. Moreover, for every point $x \notin G$, we have $f'_1(x) > x$ by definition, so x cannot be a fixed point of f' .

If f is violation-free, then we can apply Theorem 52 to argue that the instance is 1D rational, and that all surfaces are monotone with gradient at most one. Observe that f' does not change the surfaces of f , and that since all points x with $x_1 = 0$ move upward, we also have that f' is 1D rational. Hence f' must also be violation-free by Theorem 52. □

We can apply the same operation to each other dimension in sequence, to ensure that our assumption holds for all dimensions. For the requirements on the points x with $x_i = n$, we can flip all dimensions, and use the same reduction. It is clear that the reduction can be carried out in time that is polynomial in the representation of f . Finally, since the reduction does not change the set of fixed points, it is clear that the least fixed point of f' is also the least fixed point of f . This completes the proof of Lemma 53.

7 A Decomposition Theorem

In this section, we will prove a decomposition theorem for DMAC, which is inspired by a similar decomposition theorem that has recently been shown for the Tarski fixed point problem [15].

Unlike the decomposition theorem given in [15], our decomposition theorem only works for algorithms that find the least fixed point of the instance. Specifically, given a DMAC instance f , we say that an algorithm *LFP-solves* the instance if it returns a (D1) solution that is a least fixed point of f , or a (DV1) violation, or a (DV2) violation. Note that Tarski's theorem guarantees that the instance will either have a least fixed point or a (DV1) violation, so the problem remains total even if we insist that it must be LFP-solved. In Section 7 we show a decomposition theorem for algorithms that LFP-solve a DMAC instance.

Our algorithm for three-dimensional instances does not explicitly LFP-solve the instance. This is not a problem, because in Section 7.2 we give a polynomial-time that transforms a violation-free three-dimensional DMAC instance f into a violation-free three-dimensional DMAC instance f' , such that f' has a *unique* fixed point x^* , and x^* can be mapped back to the least fixed point of f . Thus applying our algorithm for violation-free DMAC to f' will allow us to LFP-solve f , and thus we can apply the decomposition theorem to our algorithm.

7.1 A Decomposition Theorem for LFP-solving DMAC

In this section we prove the following theorem.

Theorem 55. *If a d_1 -dimensional DMAC instance can be LFP-solved in q_1 time by algorithm \mathcal{A} and a d_2 -dimensional DMAC instance can be LFP-solved in q_2 time by algorithm \mathcal{B} , then there exists a $(q_1 \cdot q_2)$ -time algorithm to LFP-solve $(d_1 + d_2)$ -dimensional DMAC instances.*

Let the given DMAC instance be $f : G \rightarrow G$ where $G = \{1, 2, \dots, n\}^d$. Let $d = d_1 + d_2$ for $d_1, d_2 \geq 1$. We now define some operators that will help us to decompose this instance.

- For each $x = (x_1, x_2, \dots, x_{d_1}) \in \mathbb{R}^{d_1}$ and $y = (y_1, y_2, \dots, y_{d_2}) \in \mathbb{R}^{d_2}$ we define

$$x \oplus y = (x_1, x_2, \dots, x_{d_1}, y_1, y_2, \dots, y_{d_2})$$

to be the point obtained by concatenating y and x .

- For each $x = (x_1, x_2, \dots, x_{d_1+d_2}) \in \mathbb{R}^{d_1+d_2}$ we define $x \upharpoonright d_1 = (x_1, x_2, \dots, x_{d_1})$ to be the point obtained by deleting all but the first d_1 coordinates of x .
- For each $x = (x_1, x_2, \dots, x_{d_1+d_2}) \in \mathbb{R}^{d_1+d_2}$ we define $x \upharpoonright d_2 = (x_{d_1+1}, x_{d_1+2}, \dots, x_{d_1+d_2})$ to be the point obtained by deleting the last d_2 coordinates of x .

At a high level, the idea is to run Algorithm \mathcal{A} on an instance $f^{\mathcal{A}} : G_1 \rightarrow G_1$ over domain $G_1 = \{1, 2, \dots, n\}^{d_1}$. Whenever \mathcal{A} queries a point $x \in G_1$, we then run algorithm \mathcal{B} on the instance $f^x : G_2 \rightarrow G_2$ over domain $G_2 = \{1, 2, \dots, n\}^{d_2}$, which is defined so that

$$f^x(y) = f(x \oplus y) \upharpoonright d_2,$$

In other words, f^x is the *sub-instance* of f where the first d_1 coordinates are fixed to be x . If \mathcal{B} returns a fixed point ((D1) solution) y^* of f^x , where $f^x(y^*) = y^*$, then we return $f(x \oplus y^*) \upharpoonright d_1$ to \mathcal{A} and continue. Thus $f^{\mathcal{A}}$ can be thought of as a *super-instance*.

We first show that if \mathcal{A} and \mathcal{B} return the LFP of corresponding instances, then we get an LFP of the original instance.

Lemma 56. *If x^* is an LFP of instance $f^{\mathcal{A}}$ returned by \mathcal{A} , and y^* is an LFP of the instance f^{x^*} returned by \mathcal{B} , then $(x^* \oplus y^*)$ is an LFP of instance f .*

Proof. Towards a contradiction, suppose $(x^* \oplus y^*)$ is not the LFP of f . Then there exists another fixed point of f namely $(\tilde{x} \oplus \tilde{y}) \leq (x^* \oplus y^*)$. So, either $\tilde{x}_i < x_i^*$ for some $i \leq d_1$ contradicting x^* being the LFP of $f^{\mathcal{A}}$. Or $\tilde{x} = x^*$ and for some $j \leq d_2$, $\tilde{y}_j < y_j^*$ contradicting y^* being the LFP of f^{x^*} . \square

Of course, either \mathcal{A} or \mathcal{B} could instead return either type of the violation solutions, namely (DV1) and (DV2), at any point in this procedure. We will show that these violations can be efficiently translated into violations in f , meaning that we can stop the procedure immediately if this occurs.⁷ The following lemma discusses violations from algorithm \mathcal{B} .

Lemma 57. *For some $x \in G_1$, suppose on the input instance f^x , algorithm \mathcal{B} produces $y, z \in G_2$, which witness a violation of type (DV1) or (DV2). Then $(x \oplus y)$ and $(x \oplus z)$ form a (DV1) or (DV2) violation for the instance f respectively.*

Proof. For the first case, suppose $y, z \in G_2$ witness a (DV1) violation. That is, $y \leq z$ but $f^x(y) \not\leq f^x(z)$. Then we have that $(x \oplus y) \leq (x \oplus z)$, while

$$f^x(y) = f(x \oplus y) \upharpoonright d_2 \not\leq f^x(z) = f(x \oplus z) \upharpoonright d_2 \Rightarrow f(x \oplus y) \not\leq f(x \oplus z)$$

For the second case, suppose $y, z \in G_2$ witness a (DV2) violation, namely $\|f^x(y) - f^x(z)\|_\infty > \|y - z\|_\infty$. Then, we get:

$$\begin{aligned} \|f(x \oplus y) - f(x \oplus z)\|_\infty &\geq \|f(x \oplus y) \upharpoonright d_2 - f(x \oplus z) \upharpoonright d_2\|_\infty \\ &= \|f^x(y) - f^x(z)\|_\infty \\ &> \|y - z\|_\infty = \|(x \oplus y) - (x \oplus z)\|_\infty \end{aligned}$$

\square

Next, we will show how to convert violations returned by algorithm \mathcal{A} for instance $f^{\mathcal{A}}$ to violations for the original instance f . This proof is more involved, since even when f is a violation-free instance, in other words f has neither (DV1) nor (DV2) violations, $f^{\mathcal{A}}$ need not be violation-free. The main difficulty is that for a fixed $x \in G_1$, instance f^x may have multiple fixed points, and hence $f^{\mathcal{A}}(x)$ highly depends on which of these fixed points algorithm \mathcal{B} manages to find.

If f is violation-free, then f^x is violation-free for all $x \in G_1$ by Lemma 57. In that case, \mathcal{B} has to return a fixed point for any given instance f^x . Next, we show that if algorithm \mathcal{B} always returns the LFP of instance f^x for any given $x \in G_1$, then the corresponding $f^{\mathcal{A}}$ will be violation-free as well. In other words, violations of $f^{\mathcal{A}}$ can be mapped to violations of f . For this, we will have to prove certain properties of the LFPs across different x -slices (f^x instances).

Lemma 58. *Let $x, \tilde{x} \in G_1$, such that $x \leq \tilde{x}$ and $\|x - \tilde{x}\|_\infty = 1$. Suppose, sub-instances f^x and $f^{\tilde{x}}$ are violation-free. Then,*

- (a) *If y is a fixed point of f^x , then there exists a fixed point \tilde{y} of $f^{\tilde{x}}$, such that $y \leq \tilde{y}$ and $\|y - \tilde{y}\| \leq 1$.*
- (b) *If \tilde{y} is a fixed point of $f^{\tilde{x}}$, then there exists a fixed point y of f^x , such that $y \leq \tilde{y}$ and $\|y - \tilde{y}\| \leq 1$.*

Proof. We will prove statement (a), and the proof of statement (b) follows similarly. By monotonicity, we have $f(x \oplus y) \leq f(\tilde{x} \oplus y) \Rightarrow y = f^x(y) \leq f^{\tilde{x}}(y)$. By contraction, we have $\|f(x \oplus y) - f(\tilde{x} \oplus y + \mathbf{1})\|_\infty \leq \|(x \oplus y) - (\tilde{x} \oplus y + \mathbf{1})\|_\infty = 1 \Rightarrow \|f^x(y) - f^{\tilde{x}}(y + \mathbf{1})\|_\infty = \|y - f^{\tilde{x}}(y + \mathbf{1})\|_\infty \leq 1$. Therefore, $y \leq f^{\tilde{x}}(y) \leq f^{\tilde{x}}(y + \mathbf{1}) \leq (y + \mathbf{1})$. This together with monotonicity implies $f^{\tilde{x}}(f^{\tilde{x}}(y)) \leq f^{\tilde{x}}(y + \mathbf{1}) \leq y + \mathbf{1}$.

Applying this last argument repeatedly we get that $y \leq f^{\tilde{x}^k}(y) \leq f^{\tilde{x}}(y + \mathbf{1}) \leq y + \mathbf{1}$ for all $k \geq 1$. Thus for some $1 \leq k \leq d_2$ it must be that $\tilde{y} = f^{\tilde{x}^k}(y)$ is a fixed point of $f^{\tilde{x}}$ satisfying both the desired properties, namely $y \leq \tilde{y}$ and $\|y - \tilde{y}\| \leq 1$. \square

Lemma 59. *Let $x, \tilde{x} \in G_1$, and y^* and \tilde{y}^* be LFP of instances f^x and $f^{\tilde{x}}$ respectively. If $x \leq \tilde{x}$ then $y^* \leq \tilde{y}^*$ and $\|y^* - \tilde{y}^*\|_\infty \leq \|x - \tilde{x}\|_\infty$.*

Proof. First let us prove the claim when $\|x - \tilde{x}\|_\infty = 1$ and then apply induction. For this case, suppose to the contrary $y^* \not\leq \tilde{y}^*$ and $\tilde{y}_i^* < y_i^*$ for some $1 \leq i \leq d_2$. By Lemma 58 there exists a fixed point y of f^x such that $y \leq \tilde{y}^*$, in which case and there exists $y_i \leq \tilde{y}_i^* < y_i^*$, a contradiction to y^* being the LFP of f^x .

⁷If algorithms \mathcal{A} or \mathcal{B} are only for violation-free instances, and may return a non-solution or does not stop if the violations are present, then the same will hold for our final algorithm as well.

Furthermore, by Lemma 58 it also follows that there exists fixed point \tilde{y} of $f^{\tilde{x}}$ such that $\|y^* - \tilde{y}\| \leq 1$. We also have that $y^* \leq \tilde{y}^* \leq \tilde{y}$ because \tilde{y}^* is the LFP of $f^{\tilde{x}}$. These two together imply $\|y^* - \tilde{y}^*\| \leq 1$.

For the general case, let $s = \|x - \tilde{x}\|_\infty$ and $x = x^0 \leq x^1 \leq \dots \leq x^s = \tilde{x}$ be a sequence of points in G_2 such that consecutive points are at most distance 1 apart, i.e., $\|x^k - x^{k+1}\|_\infty = 1$ for all $0 \leq k < s$. Let y^{k*} be the LFP of f^{x^k} instance. Applying the above argument repeatedly to consecutive pairs we get that for all $0 \leq k < s$, $y^{k*} \leq y^{(k+1)*}$ and $\|y^{k*} - y^{(k+1)*}\|_\infty \leq 1$. Tying these together, we get, $y^* \leq \tilde{y}^*$ and $\|y^* - \tilde{y}^*\|_\infty = \|y^{0*} - y^{s*}\|_\infty \leq s = \|x - \tilde{x}\|_\infty$. \square

Lemma 60. *Let $x, \tilde{x} \in G_1$ and y^* and \tilde{y}^* be the LFPs of instances f^x and $f^{\tilde{x}}$ respectively. Then, $\|y^* - \tilde{y}^*\|_\infty \leq \|x - \tilde{x}\|_\infty$.*

Proof. Consider $\underline{x} = (\min x_i, \tilde{x}_i)_{i \in [d_2]}$ and $\bar{x} = (\max x_i, \tilde{x}_i)_{i \in [d_2]}$. We have that $\underline{x} \leq x, \tilde{x} \leq \bar{x}$ and $\|\underline{x} - \bar{x}\|_\infty = \|x - \tilde{x}\|_\infty$.

Let \underline{y}^* and \bar{y}^* be the LFP of $f^{\underline{x}}$ and $f^{\bar{x}}$ respectively. Then, Lemma 59 implies $\underline{y}^* \leq y^*, \tilde{y}^* \leq \bar{y}^*$ and $\|\underline{y}^* - \bar{y}^*\|_\infty \leq \|\underline{x} - \bar{x}\|_\infty$. Then it follows that, $\|y^* - \tilde{y}^*\|_\infty \leq \|\underline{y}^* - \bar{y}^*\|_\infty \leq \|\underline{x} - \bar{x}\|_\infty = \|x - \tilde{x}\|_\infty$. \square

The above two lemmas provide all the necessary tools to map violations of $f^{\mathcal{A}}$ to violations of f .

Lemma 61. *For $x, \tilde{x} \in G_1$, let y^* and \tilde{y}^* be the LFPs of instances f^x and $f^{\tilde{x}}$ respectively. If x, \tilde{x} witness a (DV1) or (DV2) violation for the corresponding instance $f^{\mathcal{A}}$, then $(x \oplus y^*), (\tilde{x} \oplus \tilde{y}^*)$ witness a (DV1) or (DV2) violation for the original instance f respectively.*

Proof. For the (DV1) violation, suppose $x \leq \tilde{x}$ but $f^{\mathcal{A}}(x) \not\leq f^{\mathcal{A}}(\tilde{x})$. By Lemma 59, we have that $y^* \leq \tilde{y}^*$, and hence $(x \oplus y^*) \leq (\tilde{x} \oplus \tilde{y}^*)$. While, since $f^{\mathcal{A}}(x) = f(x \oplus y^*) \upharpoonright d_1$, it follows that $g(x \oplus y^*) = (f^{\mathcal{A}}(x) \oplus y^*) \not\leq (f^{\mathcal{A}}(\tilde{x}) \oplus \tilde{y}^*) = f(\tilde{x} \oplus \tilde{y}^*)$. Thus, $(x \oplus y^*)$ and $(\tilde{x} \oplus \tilde{y}^*)$ lead to a (DV1) violation.

For the (DV2) violation suppose, $\|f^{\mathcal{A}}(x) - f^{\mathcal{A}}(\tilde{x})\|_\infty > \|x - \tilde{x}\|_\infty$. Then, by Lemma 60 it also follows that $\|f^{\mathcal{A}}(x) - f^{\mathcal{A}}(\tilde{x})\|_\infty > \|y^* - \tilde{y}^*\|_\infty$.

$$\begin{aligned} \|f(x \oplus y^*) - f(\tilde{x} \oplus \tilde{y}^*)\|_\infty &= \|(f^{\mathcal{A}}(x) \oplus y^*) - (f^{\mathcal{A}}(\tilde{x}) \oplus \tilde{y}^*)\|_\infty && \text{(by the definition of } f^{\mathcal{A}}) \\ &= \max\left(\|f^{\mathcal{A}}(x) - f^{\mathcal{A}}(\tilde{x})\|_\infty, \|y^* - \tilde{y}^*\|_\infty\right) \\ &= \|f^{\mathcal{A}}(x) - f^{\mathcal{A}}(\tilde{x})\|_\infty && \text{(by the hypothesis and Lemma 60)} \\ &> \|x - \tilde{x}\|_\infty && \text{(by the hypothesis)} \\ &= \|(x \oplus y^*) - (\tilde{x} \oplus \tilde{y}^*)\|_\infty && \text{(using Lemma 60)} \end{aligned}$$

This implies $(x \oplus y^*)$ and $(\tilde{x} \oplus \tilde{y}^*)$ lead to a (DV2) violation. \square

Next we show Theorem 55 by building on Lemmas 57 and 61.

Proof of Theorem 55. Lemma 56 shows that if \mathcal{A} and \mathcal{B} return (D1) solutions $x^* \in G_1$ and $y^* \in G_2$ respectively that are LFPs of instances $f^{\mathcal{A}}$ and f^{x^*} respectively, then our algorithm will return $(x^* \oplus y^*)$, an LFP of instance f . If at any point either of the algorithms reports a violation solution (DV1) or (DV2), then by Lemmas 57 and 61, we immediately find a violation for the instance f . Finally, note that \mathcal{A} makes at most q_1 queries, and for each of those, \mathcal{B} will make at most q_2 queries, giving $q_1 \cdot q_2$ queries in total. \square

7.2 All 3D DMAC Algorithms Can LFP-Solve

In this section we show the following lemma.

Lemma 62. *Let $G = \{1, 2, \dots, n\}^3$, and let $f : G \rightarrow G$ be a violation-free DMAC instance. There is a polynomial-time reduction that produces a violation-free 1DUniqueDMAC instance $f' : G' \rightarrow G'$ such that f' has a unique fixed point x^* , and x^* can be mapped back in polynomial time to the least fixed point of f .*

We assume that we have already applied Lemmas 43 and 53 to f , meaning that f is a 1DUniqueDMAC instance with $f_i(x) > x_i$ whenever $x_i = 1$, and $f_i(x) < x_i$ whenever $x_i = n$. Note also that those lemmas ensure that the least fixed point of f is the same as the least fixed point of the original instance.

Our reduction then proceeds in two steps.

Step 1: Increasing the resolution. Let

$$G^{\text{Int}} = \left\{ 1, 1 + \frac{1}{4}, 1 + \frac{1}{2}, 1 + \frac{3}{4}, 2, 2 + \frac{1}{4}, \dots, n \right\}^3$$

be the refinement of G in which we have added points at $i + 1/4$, $i + 1/2$ and $i + 3/4$ for each integer $i < n$ that was used to define G . We define a function f^{Int} that interpolates f over this new denser grid.

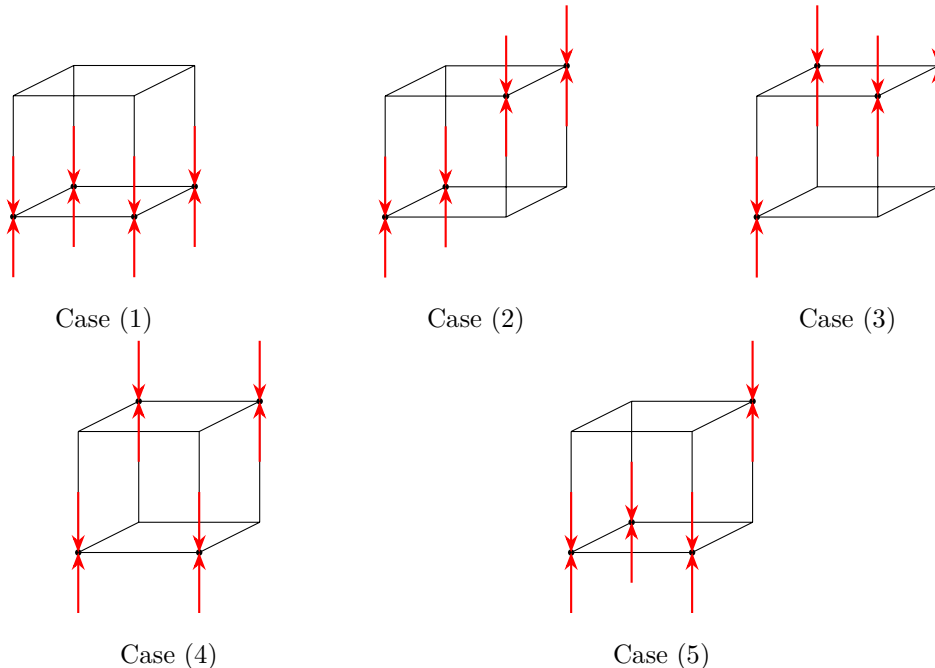

Figure 16: The possible configurations of a surface intersecting the cube C .

For each point $x \in G^{\text{Int}}$ we use the following procedure to compute $f_i^{\text{Int}}(x)$.

1. Compute the point $p = (\lfloor x_1 \rfloor, \lfloor x_2 \rfloor, \lfloor x_3 \rfloor)$, which is the least element of the integer cube that contains x .
2. Consider the set $C = \{q \in G : q = p + \sum_{j \in D} e_j \text{ where } D \subseteq \{1, 2, 3\}\}$, which are the corners of the integer cube that contains x .
3. If $f_i(y) = y_i + 1$ for all $y \in C$ with $y_i = p_i$, then set $f_i^{\text{Int}}(x) = x_i + 1$.
4. If $f_i(y) = y_i - 1$ for all $y \in C$, then set $f_i^{\text{Int}}(x) = x_i - 1$.
5. Otherwise, note that the surface in dimension i passes through the cube defined by C . Theorem 52 implies that this surface is monotone and has gradient one. Hence the orientation of C must be one of the five cases depicted in Figure 16, where in the figure the dimension i is represented by the up/down dimension.

We interpolate each of these cubes using the scheme depicted in Figure 17. Specifically, for each case, we present 5 slices that move left to right across the cube, and we depict the location of the surface s_i within the cube. This specifies s_i at all intermediate points within C .

The algorithm itself simply determines the configuration of the cube C , and then finds the location of the surface $s_i(x_{-i})$ using our specified interpolation. It then outputs $f_i(x) = x_i + 1$ if $s_i(x_{-i}) > x_i$, it outputs $f_i(x) = x_i - 1$ if $s_i(x_{-i}) < x_i$, and it outputs $f_i(x) = x_i$ if $s_i(x_{-i}) = x_i$.

It is clear that by construction that each one-dimensional slice in dimension i has a unique fixed point, and so f^{Int} is a 1DUniqueDMAC instance. It is also clear that $\|f^{\text{Int}}(x) - x\|_\infty \leq 1$ by construction. The surface s_i is monotone and has gradient at most one within each cube C . It is also not difficult to verify that the surfaces match on the boundary of each cube, and so each surface s_i in f^{Int} is monotone and has gradient one. It is also clear that we have maintained 1D rationality. Thus f^{Int} is a violation-free 1DUniqueDMAC instance by Theorem 52. Moreover, since f^{Int} can be computed by querying f at 8 points, we have that f^{Int} can be built in time that is polynomial in the representation of f .

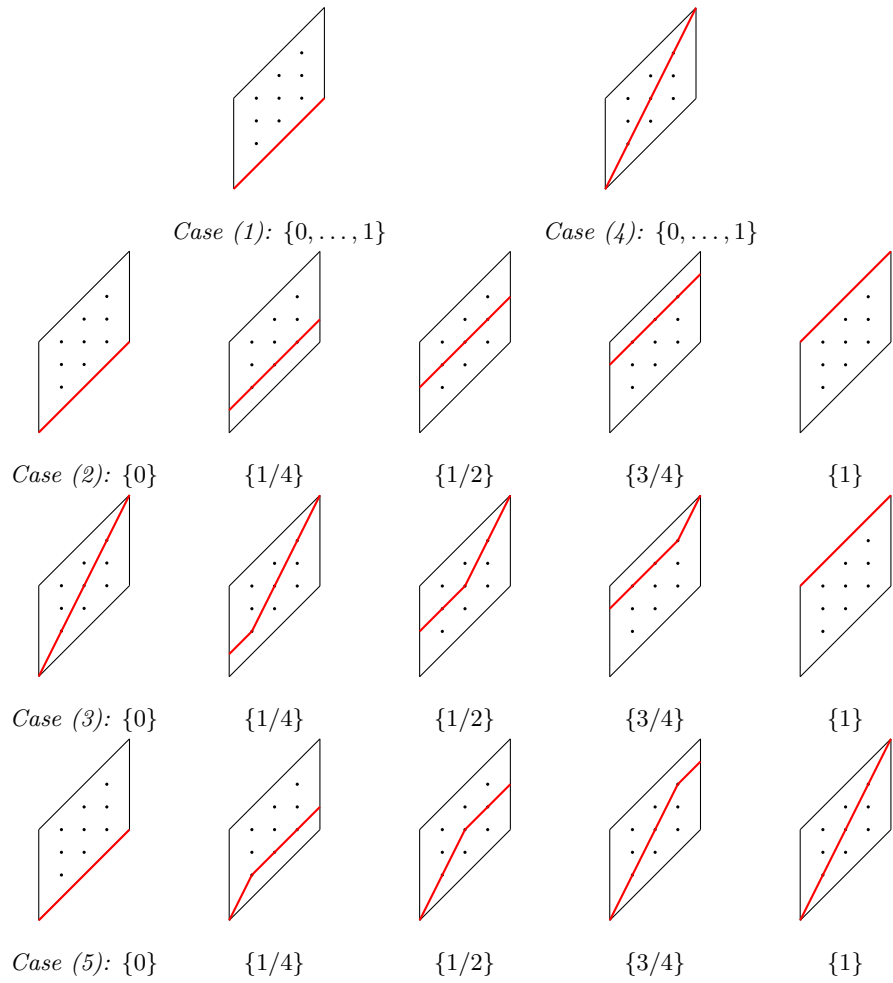

Figure 17: Interpolation scheme based on the configuration of the cube.

Step 2: Ensuring that there is a unique fixed point. Since f^{Int} is an interpolation of f , we have not yet reduced the number of fixed points, and indeed we have likely added new fixed points in the interpolated regions. We now build a new function $f^u : G^{\text{Int}} \rightarrow G^{\text{Int}}$ that will have a unique fixed point.

The idea is to shift the surfaces in f^{Int} down slightly. Specifically, we leave s_1 as it is, we shift s_2 down by $1/4$, and we shift s_3 down by $1/2$. This is achieved formally as follows. Let $h_i(x) = f_i^{\text{Int}}(x) - x_i$ be the displacement of f^{Int} in dimension i at the point x . For each $x \in G'$ we define

$$\begin{aligned} f_1^u(x) &= x_1 + h_1(x), \\ f_2^u(x) &= x_2 + h_2(x + 1/4 \cdot e_2), \\ f_3^u(x) &= x_3 + h_3(x + 1/2 \cdot e_3). \end{aligned}$$

If in any of the cases above we query a point that is not in G' , we instead fix $f_i^u(x) = x_i - 1$ to orient that point downward.

Note that since we have assumed that Lemma 53 has been applied to f , we have that f always moves strictly away from the boundary, so no point on any surface in f can lie on the boundary. Since in each case we have shifted by less than an integer, we still therefore have $0 < s_i(x_{-i}) < n$ after our shifts. Since all we have done is move the surfaces in f^{Int} by a constant amount, we have not changed the monotonicity of any surface, or the fact that it has gradient at most one. We have also not changed the fact that f^{Int} is 1D rational. Thus by Theorem 52 we have that f^u is a violation-free 1DUniqueDMAC instance. Moreover, f^u can be computed by making three queries to f^{Int} , and so f^u can be built in time that is polynomial in the size of f^{Int} .

Correctness. We must show that f^u has a unique fixed point x^* , and that given this fixed point, we can find the fixed point of f in polynomial time. We start by showing that f^u has a unique fixed point.

The following lemma states that if any 1DUniqueDMAC instance has at least two fixed points x and y , then there are at least two dimensions i for which $|x_i - y_i| = \|x - y\|_\infty$.

Lemma 63. *Let $f : G \rightarrow G$ be a violation-free 1DUniqueDMAC instance. If x and y are two distinct fixed points of f , then there are at least two distinct dimensions i and j such that $|x_i - y_i| = |x_j - y_j| = \|x - y\|_\infty$.*

Proof. Suppose for the sake of contradiction that this is not the case, meaning that there is a unique dimension i such that $|x_i - y_i| = \|x - y\|_\infty$, and observe that this implies that $|x_i - y_i| > \|x_{-i} - y_{-i}\|_\infty$. Since x and y are both fixed points, we have that x and y lie on the surface s_i , so $|s_i(x_{-i}) - s_i(y_{-i})| = |x_i - y_i|$. Therefore s_i does not have gradient at most one, which contradicts Theorem 52. \square

The next lemma shows that our interpolation has a special property: all diagonals of the surfaces used in the instance lie on principle diagonals of the instance, or principle diagonals of the two-dimensional slices of the instance. This allows us to prove special properties about the points that lie on these surfaces. For each $x \in G^{\text{Int}}$ let $r(x) = x - \lfloor x \rfloor$ be the function that gives the non-integer part of x .

Lemma 64. *Let s_k denote surface k in f^{Int} . If x and y are two distinct points that lie on s_i , and if there are two distinct dimensions i and j such that $|x_i - y_i| = |x_j - y_j| = \|x - y\|_\infty$, then we have $|r(x_i) - r(x_j)| = |r(y_i) - r(y_j)| = 0$.*

Proof. Observe that since $|r(x_i) - r(x_j)| = |r(y_i) - r(y_j)|$, we must be moving diagonally along the surface as we move from x to y . It can be verified by inspecting the construction in Figure 17 that the surface that we introduce moves diagonally only along principle diagonals of the instance, or principle diagonals of 2d slices of the instance. More precisely, by construction, we have $|r(p_i) - r(p_j)|$ for all points p that lie on a path that move at gradient one along dimensions i and j simultaneously. Thus we have $|r(x_i) - r(x_j)| = |r(y_i) - r(y_j)| = 0$. \square

Since f^u was constructed from f^{Int} by shifting s_2 down by $1/4$ and shifting s_3 down by $1/2$, we get the following immediate corollary of Lemma 64, which intuitively states that each of the surfaces use distinct diagonals in the grid.

Corollary 65. *Let s_i denote surface i in f^u , let x and y be two distinct points that lie on s_i , suppose that there are two distinct dimensions i and j such that $|x_i - y_i| = |x_j - y_j| = \|x - y\|_\infty$.*

- If $i = 1$ then $|r(x_i) - r(x_j)| = 0$.
- If $i = 2$ then $|r(x_i) - r(x_j)| = 1/4$.

- If $i = 3$ then $|r(x_i) - r(x_j)| = 1/2$.

Proof. The proof is the same as the proof of Lemma 64, noting that shifting the surfaces downwards alters the diagonals used by our construction. \square

We are now ready to prove that f^u has a unique fixed point. At a high level, this follows from the lemmas that we have shown so far because every fixed point lies on all three surfaces simultaneously by definition. So if we have two distinct fixed points, we can apply the corollary above to conclude that the point simultaneously lies on two distinct diagonals, which is a contradiction.

Lemma 66. f^u has a unique fixed point.

Proof. Since f^u is a violation-free 1DUniqueDMAC instance it must have at least one fixed point, because violation-free DMAC is a total problem due to Tarski's theorem.

Now suppose for the sake of contradiction that there are two distinct points $x, y \in G^{\text{Int}}$ that are both fixed points of f^u . Let i and j be the dimensions whose existence is asserted by Lemma 63. Let s_i and s_j be the surfaces for dimensions i and j in f^u , respectively. Since x and y are both fixed, they must lie on both s_i and s_j , but then applying Corollary 65 to s_i and s_j gives us two distinct values for $|r(x_i) - r(x_j)|$, which is a contradiction. \square

Finally, we show that the least fixed point of f^u can be mapped back to the least fixed point of f in polynomial time. We will do this using the following lemma from [15].

Lemma 67 (Lemma 3.2 of [15]). *Let $f : G \rightarrow G$ be a monotone function. If $x, y \in G$ satisfy $x \leq y$ and $x \leq f(x)$ and $y \geq f(y)$, then there exists a fixed point x^* of f satisfying $x \leq x^* \leq y$.*

We utilize the previous lemma to show the following lemma.

Lemma 68. *Let x^* be the least fixed point of f . There is a fixed point x of f^u such that $x \geq x^* - (1.5, 1.5, 1.5)$.*

Proof. First note that, since f^u was created by interpolating f and then shifting all surfaces weakly downward, we have $f^u(x^*) \leq x^*$.

Then consider the point $y = x^* - (1, 1, 1)$. Observe that we cannot have $f_i(y) < y_i$ in any dimension i , since this would be a violation of strict contraction between y and x^* and f^u is violation-free. So we have $y \leq f(y)$. Furthermore, since $y \leq x^*$ and x^* is the least fixed point of f , there must exist a dimension i such that $y_i < f_i(y)$.

Let $z = y - \sum_{j \neq i} e_j/2$. We argue that $z \leq f^u(z)$. This can be proved by inspecting the surfaces of f^u .

- For each dimension $j \neq i$, we have that y lies weakly below s_j in f , and so the distance between z and s_j is at least $1/2$ in f . Since we moved surface j downward by at most $1/2$ when we constructed f^u , this implies that z lies weakly below s_j in f^u .
- For dimension i , we have that the distance between y and s_i is at least 1 in f , because f moves y strictly upward in dimension i . Since the surface has gradient at most one, this implies that the distance between z and s_i is at least $1/2$ in f^{Int} . We then shifted s_i downward by at most $1/2$ when we created f^u , so we have that z lies weakly below s_i in f^u .

Since z lies weakly below s_j for all dimensions j , we have that $z \leq f^u(z)$.

So we have $z \leq x^*$, and $z \leq f^u(z)$, and $x^* \geq f^u(x^*)$, which allows us to invoke Lemma 67 to argue that there is a fixed point x of f^u satisfying $z \leq x \leq x^*$. Since $z \geq x^* - (1.5, 1.5, 1.5)$, we therefore have $x \geq x^* - (1.5, 1.5, 1.5)$, as required. \square

So if we find the unique fixed point x of f^u , then we can search all points y in G that satisfy $x \leq y \leq x + (1.5, 1.5, 1.5)$, and Lemma 68 guarantees that we will find the least fixed point of f . Since there are constantly many points to search, this mapping can be carried out in time that is polynomial in the representation of f . This completes the proof of Lemma 62.

We have shown the lemma for three dimensions here because our algorithm works for three-dimensional instances. We remark that this proof can easily be generalized to any constant dimension: we simply need to increase the resolution of the grid so that each surface can be moved by a distinct shift, and all shifts need to be less than or equal to $1/2$. We cannot generalize beyond constantly many dimensions due to the need to search a sub-grid when we map the unique fixed point of f^u to the least fixed point of f . This sub-grid has constantly many points when the dimension is constant, but in general it contains exponentially many points.

8 An Algorithm for 3-dimensional DMAC

We now present an algorithm that solves three-dimensional DMAC instances. Throughout this section we assume that we have a violation-free DMAC instance defined by a function f over the grid $G = \{1, 2, \dots, n\}^3$.

A fundamental definition for the algorithm is the *up* and *down* sets of f . The up-set contains every point $x \in G$ such that $x \leq f(x)$, while the down-set contains every point $x \in G$ such that $x \geq f(x)$.

Definition 69 (UP- AND DOWN- SETS). Let $f : G \rightarrow G$ be a DMAC instance. We define

$$\begin{aligned} \text{Up}(f) &= \{x \in G : f(x) \geq x\}, \\ \text{Down}(f) &= \{x \in G : f(x) \leq x\}. \end{aligned}$$

This section proceeds as follows. We first define a preprocessing step that is necessary for our algorithm to work. We then define the notion of a *critical box*, which is the crucial definition that our algorithm is based on, and we then show that an almost-square critical box always exists. Then we define the algorithm itself. Finally, we give a terminal phase algorithm that will be applied once we have found a two-dimensional slice that contains a fixed point.

8.1 Preprocessing

Our algorithm requires a number of assumptions on the DMAC instance. Firstly we assume that we have applied Lemma 43 to produce a 1DUniqueDMAC instance. Then we assume that we have applied Lemma 53 to ensure that all points on the boundary of the instance move strictly inward.

Finally, we need one more assumption that we have not yet considered. We require that the up set does not touch the lower boundary of the instance unless it is touching the boundary of dimension 3, and the symmetric property for the down set. This is encoded by the following statements.

- For each $x \in G$, if $x_3 = 1$ and either $x_1 > 1$ or $x_2 > 1$, then $x \not\leq f(x)$.
- For each $x \in G$, if $x_3 = n$ and either $x_1 < n$ or $x_2 < n$, then $x \not\geq f(x)$.

The first statement is analogous to the situation shown on the right in Figure 3, though in that picture we show the 2D-version in which we have $x \not\leq f(x)$ whenever $x_1 > 1$ and $x_2 = 1$. As mentioned in the technical overview, the transformation is necessary to ensure that our initial bounds on the up- and down-sets can be correctly translated to other slices. This assumption gives the three-dimensional analogue, and it is likewise used to ensure that the translation of bounds from a slice with $x_3 = i$ to a slice with $x_3 = j \neq i$ is correct.

In this section we show that this assumption can be made without loss of generality, by proving the following lemma.

Lemma 70. *Let $G = \{1, 2, \dots, n\}^3$, let $G' = \{1, 2, \dots, n\}^2 \times \{1, 2, \dots, n'\}$ and let $f : G \rightarrow G$ be a 1DUniqueDMAC instance. There is a polynomial-time reduction that creates a 1DUniqueDMAC instance $f' : G' \rightarrow G'$ such that the following statements hold.*

- For each $x \in G'$, if $x_3 = 1$ and $x_1 > 1$ or $x_2 > 1$, then $x \not\leq f'(x)$.
- For each $x \in G'$, if $x_3 = n'$ and $x_1 < n$ or $x_2 < n$, then $x \not\geq f'(x)$.

Moreover, the least fixed point of f' can be mapped back to the least fixed point of f .

We start by giving a reduction that produces a function $f' : G' \rightarrow G'$ where $G' = \{1, 2, \dots, n\}^2 \times \{1, 2, \dots, 2n\}$ that ensures that if $x_3 = 1$ and $x_1 > 1$ then $x \not\leq f'(x)$. We define f' as follows.

- If $x_3 > n$ then we define $f'(x) = f(x - n \cdot e_3)$.
- If $x_3 \leq n$ then we define $f'_2(x) = f_2(x - (x_3 + 1) \cdot e_3)$ and $f'_3(x) = x_3 + 1$. For dimension 1 we define $m(x) = x - (x_3 + 1) \cdot e_3$, $z = x + (n + 1 - x_3) \cdot (1, 0, 1)$ and $h_1(x) = f_1(x) - x_1$. We set

$$f'_1(x) = \begin{cases} \max(x_1 + h_1(m(z)), 0) & \text{if } z \in G' \\ x_1 - 1 & \text{otherwise.} \end{cases}$$

The idea here is that we are carrying out the analogous reduction to the one shown for two-dimensions in Figure 3. The top half of G' , meaning the points x with $x_3 > n$ exactly copies f on G . For the bottom-half, the definition ensures that all points move upward in dimension 3. For dimensions 1 and 2, we try to copy the direction of a point that lies on the bottom boundary of G in dimension 3 (which has now been transplanted to the slice where $x_3 = n + 1$). For dimension 2 we copy the point that is now directly above us, while for dimension 1, we project along the vector $(1, 0, 1)$, and this projection may leave G' before it hits a point with $x_3 = n + 1$. If the vector hits a point with $x_3 = n + 1$, then we copy the displacement of that point, and otherwise we move downwards.

To see that we have $x \not\leq f'(x)$ whenever $x_3 = 1$ and $x_1 > 1$ then, it suffices to note that for any such point we will have $z \notin G'$, and so $f'_1(x) < x_1$ by definition. The following lemma shows that the reduction is correct.

Lemma 71. *A point x is a fixed point of f' if and only if $x - n \cdot e_3$ is a fixed point of f . Moreover, if f is violation-free, then f' is also violation-free.*

Proof. For a point $x \in G'$ with $x_3 \geq n + 1$ it is clear from the definition that x is a fixed point of f' if and only if $x - n \cdot e_3$ is a fixed point of f . For a point $x \in G'$ with $x_3 < n + 1$, we have $f'_3(x) > x_3$ by definition, so x is not a fixed point of f' .

If f is violation-free, then we can apply Theorem 52 to argue that it is 1D rational, and that all surfaces are monotone with gradient at most one. Since we copy f to the points x in G' with $x_3 \geq n + 1$, we have that all surfaces continue to be monotone and have gradient one in this region.

We now consider the points x with $x_3 < n + 1$. For the surface s_3 , note that we have defined $f'_3(x) > x_3$, and so this ensures that each one-dimensional slice in dimension 3 has a unique fixed point and all points are 1D rational in dimension 3.

For dimension 2 observe that we are simply copying the dimension-2 surface from the slice in which $x_3 = n + 1$. Thus the surface continues to be monotone and have gradient at most one, and the instance continues to be 1D rational in dimension 2.

For dimension 1 we are copying the surface from the slice in which $x_3 = n + 1$, but we are moving the entire surface downward with a gradient of one as we move downward in dimension 3. This ensures that the surface is still monotone and still has gradient at most one. The max operation with 0 ensures that the surface does not leave the lower boundary of the instance, which also ensures that we continue to have a 1DUniqueDMAC instance. Finally, the downward movement that is introduced when $z \notin G$ ensures that the instance remains 1D rational for dimension 1.

Thus, the new instance is 1D rational, and has surfaces that are monotone and have gradient at most 1. So we can apply Theorem 52 to argue that f' is violation-free. \square

So we have shown that the reduction is correct for the case when $x_3 = 1$ and $x_1 > n$, and we have also shown that the least fixed point of f' can be mapped back to the least fixed point of f . Moreover, f' has displacements that are at most unit lengths because it either copies displacements from f' , which has that property by assumption, or it introduces a downward displacement of unit length. Finally, it is clear that the reduction can be carried out in time that is polynomial in the representation of f .

We can cover the other cases in the following way.

- We run the same reduction again after exchanging dimensions 1 and 2.
- We then flip all dimensions in the instance, and run the reduction for both dimensions 1 and 2, which ensures the symmetric property holds for the down set.

It is clear that running the reduction four times in this way can be carried out in time that is polynomial in the representation of f . This completes the proof of Lemma 70.

8.2 Critical Boxes

We now define the concept of a critical box.

Boxes and diagonal boxes. We start by defining a Box, which is simply a box of points in the instance.

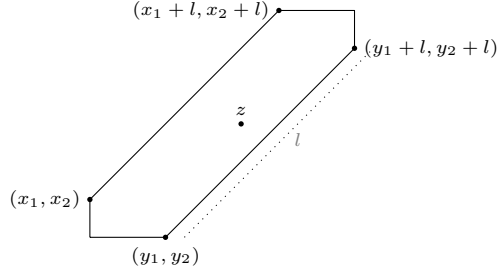

Figure 18: A $\text{DBox}(x, y, l)$.

Definition 72 (Box). Given a point $x \in G$, and two non-negative integers h, w , we denote the *box* $\text{Box}(x, h, w)$ that contains all points $y \in G$ that satisfy the inequalities

$$\begin{aligned} x_1 &\leq y_1 \leq x_1 + w \\ x_2 &\leq y_2 \leq x_2 + h \end{aligned}$$

We also define a DBox , which is diagonal region with flattened ends, as shown in Figure 18.

Definition 73 (DBox). Given two points $x, y \in G$ with $x_1 \leq y_1$ and $y_2 \leq x_2$, and a non-negative integer l , we denote the *diagonal-box* $\text{DBox}(x, y, l)$ that contains all points $z \in G$ that satisfy the inequalities

$$\begin{aligned} y_2 + (z_1 - y_1) &\leq z_1 \leq x_2 + (z_1 - x_1) \\ x_1 &\leq z_1 \leq y_1 + l \\ y_2 &\leq z_2 \leq x_2 + l \end{aligned}$$

The states that we consider in our algorithm will be built from these two shapes.

Critical boxes. We are now ready to define critical boxes. We will initially describe this concept for the up set. As we will later see, the same concept can be applied to the down set by simply flipping all inequalities.

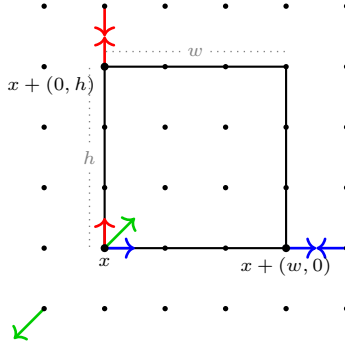

Figure 19: A critical box.

Throughout this section we consider a two-dimensional slice s of a three-dimensional instance. Without loss of generality we suppose that dimensions 1 and 2 are the dimensions used in the slice, and dimension 3 is the dimension that is not used in the instance.

Consider the set S of points in the slice that are in $\text{Up}(f)$, meaning that f points upward in all three dimensions (including the dimension that is not involved in the slice). Intuitively, a critical box is a (not necessarily square) box that only contains points in S , and cannot be made taller and wider without including some point not in S .

Figure 19 shows an example of our formal definition of a critical box. Specifically, the box is defined by a point x in $\text{Up}(f)$ such that

- the point $x + w \cdot e_1$ moves weakly upwards in the left-right direction, while the point $x + (w + 1) \cdot e_1$ moves strictly downwards, and

- the point $x + h \cdot e_2$ moves weakly upwards in the up-down direction, while the point $x + (h + 1) \cdot e_2$ moves strictly downwards,
- the point diagonally beneath x moves strictly downward in the third dimension, or x lies on the left or bottom boundaries of the instance (meaning that there are no points diagonally beneath it).

We note that there will always exist a w such that $x + w \cdot e_1$ moves strictly downwards, due to our assumption that all points on the boundary of the instance move strictly inward, and likewise there will always exist an h such that $x + h \cdot e_2$ moves strictly downward. We encode this formally in the following definition.

Definition 74 (CRITICAL BOX (UP SET)). Given a two-dimensional slice s , a point x , and two non-negative integers h and w , the tuple (x, h, w) is a critical box if all of the following are true.

1. $x \in \text{Up}(f)$.
2. The points $x + w \cdot e_1$ and $x + (w + 1) \cdot e_1$ obey the following.

$$\begin{aligned} f_1(x + w \cdot e_1) - (x_1 + w) &\geq 0 \\ f_1(x + (w + 1) \cdot e_1) - (x_1 + (w + 1)) &< 0 \end{aligned}$$

3. The points $x + h \cdot e_2$ and $x + (h + 1) \cdot e_2$ obey the following.

$$\begin{aligned} f_2(x + h \cdot e_2) - (x_2 + h) &\geq 0 \\ f_2(x + (h + 1) \cdot e_2) - (x_2 + (h + 1)) &< 0 \end{aligned}$$

4. Either $x_1 = 0$ or $x_2 = 0$, or the point $x - (1, 1)$ obeys the following.

$$f_3(x - (e_1 + e_2)) - x_3 < 0$$

It is clear from the definition that a critical box (x, h, w) cannot be made taller and wider without including some point that is not in $\text{Up}(f)$. In Figure 19 we can see that the critical box cannot be extended rightwards, since it would then include the point $x + (w + 1) \cdot e_1$, which is not in $\text{Up}(f)$ due to its direction in dimension 1, and it likewise cannot be extended upwards without including the point $x + (h + 1) \cdot e_2$, which is also not in $\text{Up}(f)$ due to its direction in dimension 2. It also cannot be extended both downward and leftward without including the point $x - e_1 - e_2$, which is not in $\text{Up}(f)$ due to its direction in dimension 3. Note that we may be able to extend the box either downward or leftward individually, but this will turn out to not be a problem, since the points directly leftward and downward are contained in the critical boxes lobes, which we will define shortly.

It is however not immediately obvious that all points in a critical box are actually contained in $\text{Up}(f)$. We show that in the following lemma.

Lemma 75. *If (x, h, w) is a critical box, then we have $\text{Box}(x, h, w) \subseteq \text{Up}(f)$.*

Proof. Since point x represents the bottom left point of the critical box (x, h, w) , any point inside the box can be described as $y = x + a \cdot e_1 + b \cdot e_2$, where $a \leq w$ and $b \leq h$.

From the definition of a critical box, $x \in \text{Up}(f)$ and we know that $f_1(x + w \cdot e_1) \geq x_1 + w$. Therefore, for any point $x + a \cdot e_1$, since $a \leq w$, we have that $f_1(x + a \cdot e_1) \geq x_1 + a$ holds due to the contraction property, because if we instead assume that $f_1(x + a \cdot e_1) < x_1 + a$ then we obtain the following violation of strict contraction: $\|f(x + w \cdot e_1) - f(x + a \cdot e_1)\|_\infty > w - a = \|(x + w \cdot e_1) - (x + a \cdot e_1)\|_\infty$.

By a similar argument, for the second dimension, $f_2(x + h \cdot e_2) \geq x_2 + h$. For any point $x + b \cdot e_2$ within the box, $f_2(x + b \cdot e_2) \geq x_2 + b$.

Finally, monotonicity implies that $x \in \text{Up}(f) \implies f_3(x + a \cdot e_1) \geq x_3 + a$ and $f_3(x + b \cdot e_2) \geq x_3 + b$.

Since $y = x + a \cdot e_1 + b \cdot e_2$ is composed of two displacements of x along dimensions 1 and 2, the inequalities for $f_1(x + a \cdot e_1)$, $f_2(x + b \cdot e_2)$ carry over to y .

Thus, $f_i(x + a \cdot e_1 + b \cdot e_2) \geq x + a \cdot e_1 + b \cdot e_2$, for all $i = \{1, 2, 3\}$, confirming that every point within the critical box belongs to $\text{Up}(f)$.

□

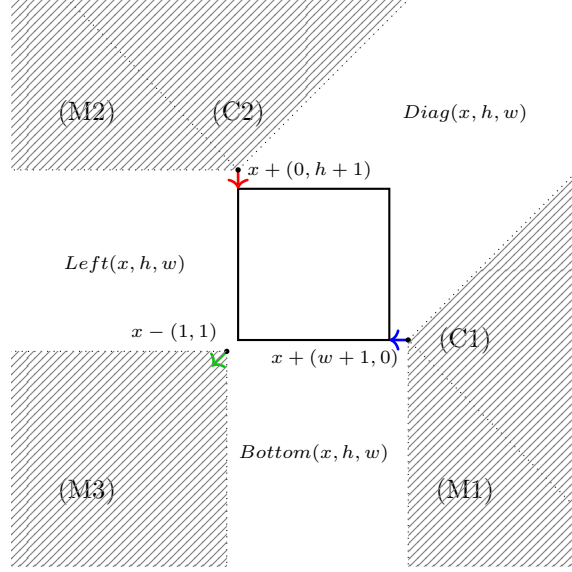

Figure 20: Regions of exclusion of points in $Up(f)$.

Lobes. The critical box will form the basis of a bound on the up set. Specifically, we will show that the up set in a two-dimensional slice is contained within a critical box and its three *lobes*, which are shown in Figure 20.

Specifically, for each critical box (x, h, w) , we define

- a *left lobe* $Left(x, h, w)$ containing all points to the left of the box,
- a *bottom lobe* $Bott(x, h, w)$ containing all points below the box, and
- a *diagonal lobe* $Diag(x, h, w)$ containing all points diagonally above the box.

To define these lobes formally, we first define the *upward* and *downward cones* that originate from a particular point.

Definition 76. Let $x \in G$ be a point, and let $i \in \{1, 2\}$ be a dimension. We define

$$\begin{aligned} UC_i(x) &= \{y \in G : y_i - x_i \geq |y_j - x_j| \forall j \neq i\}, \\ DC_i(x) &= \{y \in G : x_i - y_i \geq |y_j - x_j| \forall j \neq i\}. \end{aligned}$$

For example, in Figure 20 the region labelled C1 is $UC_1(x + (w + 1) \cdot e_1)$ while the region labelled C2 is $UC_2(x + (h + 1) \cdot e_2)$. We can now formally define the three lobes.

Definition 77. Given a critical box (x, h, w) , the three *lobes* originating from it are defined as follows.

$$\begin{aligned} Left(x, h, w) &= \{y \in G : y_1 \leq x_1, x_2 \leq y_2 \leq h\}, \\ Bott(x, h, w) &= \{y \in G : x_1 \leq y_1 \leq w, y_2 \leq x_2\}, \\ Diag(x, h, w) &= \{y \in G : y \in UC_2(x + w \cdot e_1) \setminus (UC_2(x + (h + 1) \cdot e_2) \cup \{(x, h, w)\})\}. \end{aligned}$$

We aim to prove the following lemma, which states that a critical box and its lobes provide a bound on the up set within a two-dimensional slice.

Lemma 78. *Let s be a two-dimensional slice, let (x, h, w) be a critical box within s , and let U be the subset of $Up(f)$ that is contained in s . The set U is contained in*

$$Box(x, h, w) \cup Left(x, h, w) \cup Bott(x, h, w) \cup Diag(x, h, w).$$

We will prove this by showing that any point not in these four sets cannot be in $Up(f)$. We first show that contraction implies that if x points downwards in dimension i , then any point in the dimension i upward cone of x must also point downwards. The above property holds for both weak and strict inequalities. We also show the symmetric property for the downwards cone, which we will use later.

Lemma 79. *Let $x \in G$ be a point.*

- (strict) If $f_i(x) < x_i$, then for all $y \in \text{UC}_i(x)$ we have $f_i(y) < y_i$.
- (weak) If $f_i(x) \leq x_i$, then for all $y \in \text{UC}_i(x)$ we have $f_i(y) \leq y_i$.
- (strict) If $f_i(x) > x_i$, then for all $y \in \text{DC}_i(x)$ we have $f_i(y) > y_i$.
- (weak) If $f_i(x) \geq x_i$, then for all $y \in \text{DC}_i(x)$ we have $f_i(y) \geq y_i$.

Proof. We begin with the proof of the claim regarding upward cones. Since $y \in \text{UC}_i(x)$ we have that $\|x - y\|_\infty = y_i - x_i$.

We use two different assumptions on $f_i(y)$, depending on the value of $f_i(x)$ relative to x_i . If $f_i(x) < x_i$, we set $f_i(y) \geq y_i$ and if $f_i(x) \leq x_i$, then $f_i(y) > y_i$. In both cases, we would have

$$\begin{aligned} \|f(y) - f(x)\|_\infty &\geq f_i(y) - f_i(x) \\ &> y_i - x_i \\ &= \|y - x\|_\infty, \end{aligned}$$

where the strict inequalities follow from the assumption on $f_i(x), f_i(y)$. Thus we have a violation of strict contraction, which is a contradiction.

We prove the downward cone case in a symmetric manner. Since $y \in \text{DC}_i(x)$ we have that $\|x - y\|_\infty = x_i - y_i$.

Similarly, the assumptions are as follows: if $f_i(x) > x_i$, then we assume $f_i(y) \leq y_i$, and if $f_i(x) \geq x_i$, we set $f_i(y) < x_i$. Then, in both cases,

$$\begin{aligned} \|f(x) - f(y)\|_\infty &\geq f_i(x) - f_i(y) \\ &> x_i - y_i \\ &= \|x - y\|_\infty, \end{aligned}$$

which is a violation of strict contraction. □

This immediately implies that $\text{Up}(f)$ cannot lie in the regions labelled C1 and C2 in Figure 20. Specifically, since $x + (w + 1) \cdot e_1$ is required to move strictly leftwards in dimension 1, Lemma 79 implies that every point in C1 must also move strictly leftwards, and thus no point in the set can lie in $\text{Up}(f)$. The same property holds symmetrically for C2.

Next we show that monotonicity implies that if x moves downwards in dimension i , either strictly or weakly, then any point directly beneath x in some dimension $j \neq i$ must also follow the same direction in dimension i . We also show the symmetric counterpart of this, since it will be useful later.

Lemma 80. *Let $x \in G$ be a point.*

- (strict) If $f_i(x) < x_i$, and y is a point such that $y \leq x$ and $y_i = x_i$, we have $f_i(y) < y_i$.
- (weak) If $f_i(x) \leq x_i$, and y is a point such that $y \leq x$ and $y_i = x_i$, we have $f_i(y) \leq y_i$.
- (strict) If $f_i(x) > x_i$, and y is a point such that $y \geq x$ and $y_i = x_i$, we have $f_i(y) > y_i$.
- (weak) If $f_i(x) \geq x_i$, and y is a point such that $y \geq x$ and $y_i = x_i$, we have $f_i(y) \geq y_i$.

Proof. We begin with the first case. We have $y \leq x$, so if we had $f_i(y) \geq y_i$ then we would have $f_i(y) \geq y_i = x_i > f_i(x)$, which is a violation of monotonicity.

Similarly, for the second case, if we had $f_i(y) > y_i$, we would get $f_i(y) > y_i = x_i \geq f_i(x)$, which violates monotonicity.

The third and fourth cases are proved symmetrically. We have $y \geq x$, so in the third case, if we had $f_i(y) \leq y_i$ then we would have $f_i(y) \leq y_i = x_i < f_i(x)$, which is a violation of monotonicity.

For the fourth case, assuming $f_i(y) < y_i$ we would get $f_i(y) < y_i = x_i \leq f_i(x)$, which violates monotonicity. □

This now rules out the remaining regions. Specifically, M1 cannot contain a point in $\text{Up}(f)$ because each point in M1 lies directly beneath a point in C1. We have already proved that each point in C1 must move strictly leftwards, and therefore by Lemma 80 each point in M1 must also move strictly leftwards. The same property holds symmetrically for the region M2. Finally, for the region M3, note that $x - e_1 - e_2$ moves strictly downward in the third dimension, and that every point in M3 lies strictly beneath $x - e_1 - e_2$. Therefore we can apply Lemma 80 to argue that all point in M3 move strictly downward in dimension 3. This completes the proof of Lemma 78.

8.3 Almost Square Critical Boxes

Recall that a critical box (x, h, w) is not required to be square, meaning that h and w can differ significantly. While any critical box provides a bound on the up set via Lemma 78, our algorithm will crucially use the fact that an *almost square*⁸ critical box always exists, which we will show by proving the following lemma.

Lemma 81. *If $\text{Up}(f) \cap s$ is non-empty then there exists a critical box (x, h, w) with $|h - w| \leq 1$.*

Note that the precondition of $\text{Up}(f) \cap s$ being non-empty is required, because if $\text{Up}(f) \cap s$ is empty, then no critical boxes exist. The rest of this section is dedicated to proving Lemma 81.

The boundary set \mathcal{B} . We begin by defining the set \mathcal{B} , which captures the boundary between the points that move upward in the third dimension and the rest of the slice.

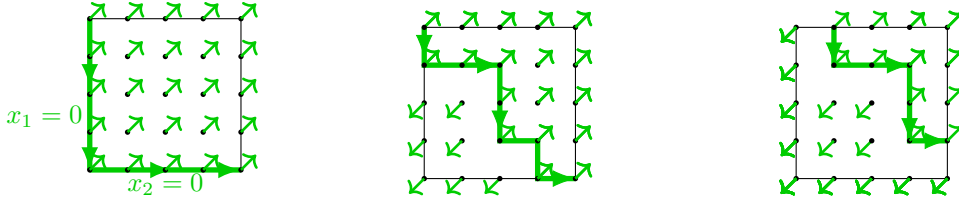

Figure 21: Possible configurations of set \mathcal{B} defined on a 2-dimensional slice.

Definition 82. We define \mathcal{B} to contain all points x in the slice s such that $f_3(x) \geq x_3$ and either

- $x_1 = 0$ or $x_2 = 0$, or
- $f_3(x - e_1 - e_2) - x_3 < 0$

Observe that \mathcal{B} contains exactly the set of points for which dimension 3 moves upward, as required by point 1 of Definition 74, and for which point 4 in Definition 74 is satisfied. Thus all critical boxes (x, h, w) must have $x \in \mathcal{B}$.

Furthermore, Lemma 80 tells us that if $f_3(x) > x_3$ and if $y \leq x$ then $f_3(y) > y_3$. So the set $\mathcal{D} = \{x \in s : f_3(x) > x_3\}$ is downward closed. Since \mathcal{B} contains points not in \mathcal{D} that are diagonally above a point in \mathcal{D} , along with the points on the boundary that are not in \mathcal{D} , it must therefore trace a path of points that moves from the top or left side of the slice to the bottom or right side, as shown in the three examples given in Figure 21.

Specifically, we can represent \mathcal{B} as a sequence of points x^1, x^2, \dots, x^k such that the following hold.

- $x_2^1 = n$,
- $x_1^k = n$, and
- For each i we have $x^{i+1} = x^i + e_1$ or $x^{i+1} = x^i - e_2$.

Heights. For each $x \in \mathcal{B}$ we define the following *height* functions.

$$\text{Height}_1(x) = \min_w \{f_1(x + w \cdot e_1) < x_1 + w\},$$

$$\text{Height}_2(x) = \min_h \{f_2(x + h \cdot e_2) < x_2 + h\}.$$

Note that the height functions are always well defined, due to our assumption that $f_i(x) < x_i$ whenever $x_i = n$, so the minimums are not taken over empty sets.

Observe that if $w = \text{Height}_1(x) > 0$ and $h = \text{Height}_2(x) > 0$ then (x, h, w) meets all of the requirements of a critical box. So to prove Lemma 81 it is sufficient to find a point x where both heights are positive, and where $|\text{Height}_1(x) - \text{Height}_2(x)| \leq 1$.

The next lemma analyses how the heights change as we walk along the path defined by \mathcal{B} . In particular, it proves that both height functions change by at most 1 as we take a step along the path defined by \mathcal{B} .

⁸In fact, if we were considering continuous monotone contraction maps, rather than DMAC, the techniques that we use here can be used to show that an exactly square critical box always exists. Our weakening to consider almost square critical boxes is required here only because we are working with the discrete problem.

Lemma 83. *Let x be a point such that $\text{Height}_1(x) > 0$ and $\text{Height}_2(x) > 0$.*

1. *If $y = x + e_1$, then both of the following hold.*

$$\begin{aligned}\text{Height}_1(y) &= \text{Height}_1(x) - 1 \\ \text{Height}_2(x) + 1 &\geq \text{Height}_2(y) \geq \text{Height}_2(x)\end{aligned}$$

2. *If $y = x - e_2$, then both of the following hold.*

$$\begin{aligned}\text{Height}_1(x) - 1 &\leq \text{Height}_1(y) \leq \text{Height}_1(x) \\ \text{Height}_2(y) &= \text{Height}_2(x) + 1\end{aligned}$$

Proof. We start with the first case, in which $y = x + e_1$.

- We have

$$\begin{aligned}\text{Height}_1(y) &= \min_w \{f_1(y + w \cdot e_1) < y_1 + w\}, \\ &= \min_w \{f_1(x + (w + 1) \cdot e_1) < x_1 + w + 1\}, \\ &= \text{Height}_1(x) - 1.\end{aligned}$$

- Let $x' = x + \text{Height}_2(x) \cdot e_2$, and observe that by definition we have $f_2(x') < x'_2$. Let $y' = y + (\text{Height}_2(x) + 1) \cdot e_2$, and note that $y' \in \text{UC}_2(x')$. Hence we can apply Lemma 79 to argue that $f_2(y') < y'_2$, which means that $\text{Height}_2(y) \leq \text{Height}_2(x) + 1$.
- Suppose for the sake of contradiction that $\text{Height}_2(y) < \text{Height}_2(x)$. Let $z = y + \text{Height}_2(y) \cdot e_2$, and observe that by definition $f_2(z) < z_2$. Consider the point $z' = x + \text{Height}_2(y) \cdot e_2$, and observe that since $x = y - e_1$ we have $z' = z - e_1$ and thus $z' < z$. Hence Lemma 80 implies $f_2(z') < z'_2$, which then implies $\text{Height}_2(x) \leq \text{Height}_2(y)$, giving a contradiction.

The second case, where $y = x - e_2$, is proved essentially symmetrically.

- We have

$$\begin{aligned}\text{Height}_2(y) &= \min_w \{f_2(y + w \cdot e_2) < y_2 + w\}, \\ &= \min_w \{f_2(x + (w - 1) \cdot e_2) < x_2 + w - 1\}, \\ &= \text{Height}_2(x) + 1.\end{aligned}$$

- Let $y' = y + \text{Height}_1(y) \cdot e_1$, and observe that by definition we have $f_1(y') < y'_1$. Let $x' = x + (\text{Height}_1(y) + 1) \cdot e_1$, and note that $x' \in \text{UC}_1(y')$. Hence we can apply Lemma 79 to argue that $f_1(x') < x'_1$, which means that $\text{Height}_1(x) \leq \text{Height}_1(y) + 1$, and therefore $\text{Height}_1(x) - 1 \leq \text{Height}_1(y)$.
- Suppose for the sake of contradiction that $\text{Height}_1(y) > \text{Height}_1(x)$. Let $z = x + \text{Height}_1(x) \cdot e_1$, and observe that by definition $f_1(z) < z_1$. Consider the point $z' = y + \text{Height}_1(x) \cdot e_1$, and observe that since $x = y + e_2$ we have $z' = z - e_2$ and thus $z' < z$. Hence Lemma 80 implies $f_1(z') < z'_1$, which then implies $\text{Height}_1(y) \leq \text{Height}_1(x)$, giving a contradiction. □

The structure of $\text{Up}(f) \cap \mathcal{B}$. As mentioned, we are seeking a point in \mathcal{B} that is in $\text{Up}(f)$ whose heights differ by at most 1. The first thing we prove is that our assumption that $\text{Up}(f) \cap s$ is non-empty implies that there is at least one point in $\text{Up}(f) \cap \mathcal{B}$.

Lemma 84. *If $\text{Up}(f) \cap s$ is non-empty, then $\text{Up}(f) \cap \mathcal{B}$ is non-empty.*

Proof. Let x be a point in $\text{Up}(f) \cap s$. We will construct a point in $\text{Up}(f) \cap \mathcal{B}$.

We first observe that $x \geq y$ for all points $y \in \mathcal{B}$. This is because, for each non-boundary point $y \in \mathcal{B}$, the point $y - e_1 - e_2$ satisfies $f_3(y - e_1 - e_2) < y_3$, and by Lemma 80 we can therefore conclude that all points $y' < y$ also satisfy $f_3(y') < y'_3$, meaning that $y' \notin \text{Up}(f)$.

Since $x \geq y$ for all points $y \in \mathcal{B}$, and since \mathcal{B} is a path that spans the instance, there exists a non-negative constant c such that $x' = x - c \cdot e_1 - c \cdot e_2$ lies in \mathcal{B} . Observe that $x' \in \text{DC}_1(x)$ and $x' \in \text{DC}_2(x)$ by construction. Thus, since $x \in \text{Up}(f)$, we can apply Lemma 79 to argue that $x' \in \text{Up}(f)$, which completes the proof. □

The next lemma shows that $\text{Up}(f) \cap \mathcal{B}$ forms a contiguous sub-path of the path defined by \mathcal{B} . In particular, this means that there is a least index l such that $x^l \in \text{Up}(f)$ while $x^{l-1} \notin \text{Up}(f)$, that there is a greatest index u such that $x^u \in \text{Up}(f)$ while $x^{u+1} \notin \text{Up}(f)$, and that all points x^i with $l \leq i \leq u$ satisfy $x^i \in \text{Up}(f)$.

Lemma 85. *Let x^1, x^2, \dots, x^k be the path defined by \mathcal{B} . If there exists a j such that $x^j \in \text{Up}(f)$, then there exist indices l and u such that*

- *If $l \leq i \leq u$ then $x^i \in \text{Up}(f)$.*
- *If $i < l$ or $i > u$ then $x^i \notin \text{Up}(f)$.*

Proof. We will show that if there are indices $a < b < c$ with $x^a \in \text{Up}(f)$ and $x^c \in \text{Up}(f)$, then we must have $x^b \in \text{Up}(f)$, which implies the claim. Note that all points $x \in \mathcal{B}$ satisfy $x_3 \leq f_3(x)$ by definition, so we can restrict our attention to dimensions 1 and 2.

Since for all i we have $x^i = x^{i-1} + e_1$ or $x^i = x^{i-1} - e_2$, we must have $x^b = x^a + c_1 \cdot e_1 - c_2 \cdot e_2$ for some non-negative constants c_1 and c_2 . Since $x^a \in \text{Up}(f)$ we have $x_2^a \leq f_2(x^a)$. Let $x' = x^a + c_1 \cdot e_1$. Since $x^a \leq x'$ we can apply Lemma 80 to argue that $x_2' \leq f_2(x')$. Since $x' = x^b + c_2 \cdot e_2$, this implies that $x_2^b \leq f_2(x^b)$, because otherwise we would have a violation of strict contraction.

Likewise we must have $x^b = x^c - d_1 \cdot e_1 + d_2 \cdot e_2$ for some non-negative constants d_1 and d_2 . Let $x' = x^c + d_2 \cdot e_2$. Since x^c is in $\text{Up}(f)$ we have $x_1^c \leq f_1(x^c)$, and we can apply Lemma 80 to conclude that $x_1' \leq f_1(x')$. This then implies that $x_1^b \leq f_1(x^b)$ because otherwise we would have a violation of contraction.

So we have shown that $x_i^b \leq f_i(x^b)$ for all dimensions i , meaning that $x^b \in \text{Up}(f)$, which completes the proof of the claim.

We can now apply the claim to prove the lemma. Since there exists at least one point $x^j \in \text{Up}(f)$, we have that the set of indices i for which $x^i \in \text{Up}(f)$ is a non-empty contiguous set of indices between some index l and some index u such that $x^i \in \text{Up}(f)$ if and only if $l \leq i \leq u$, where the contiguity of the sequence is implied by the claim that we have proved. This then proves both statements of the lemma. \square

Finding the almost square critical box. We can now proceed toward proving that an almost square critical box exists. The next lemma shows that we can find a point x in \mathcal{B} such that $\text{Height}_1(x) \geq \text{Height}_2(x)$, and another point y further along the line defined by \mathcal{B} such that $\text{Height}_1(y) \leq \text{Height}_2(y)$. In fact, the proof shows that x^l satisfies the first property, while x^u satisfies the second, where l and u are the indices whose existence is asserted by Lemma 85.

Lemma 86. *Let x^1, x^2, \dots, x^k be the path defined by \mathcal{B} . If $\text{Up}(f) \cap s$ is non-empty, then there exist indices l and u with $l \leq u$, where $x^l \in \text{Up}(f)$ and $x^u \in \text{Up}(f)$, and where the following inequalities are satisfied.*

$$\begin{aligned} \text{Height}_1(x^l) &\geq \text{Height}_2(x^l) > 0, \\ \text{Height}_2(x^u) &\geq \text{Height}_1(x^u) > 0. \end{aligned}$$

Proof. We begin with the first claim. Note that Lemma 84 implies that $\text{Up}(f) \cap \mathcal{B}$ is non-empty. So let i be the least index such that $x^i \in \text{Up}(f)$. Note that i cannot be 1, since that would imply $x_2^1 = n$, and we have ensured by our assumptions on the instance that we cannot have $x^i \in \text{Up}(f)$ in this case.

Since $x^i \in \text{Up}(f)$ we clearly have both $\text{Height}_1(x^i) > 0$ and $\text{Height}_2(x^i) > 0$. We will show that $\text{Height}_2(x^i) = 1$, which then implies $\text{Height}_2(x^i) \leq \text{Height}_1(x^i)$, because the Height function is integer valued.

Note that since $x^{i-1} \in \mathcal{B}$ we have $x_3^{i-1} \leq f_3(x^{i-1})$ by definition. There are two cases to consider.

- In the case where $x^{i-1} = x^i - e_1$ we use the following argument. Note that Lemma 83 implies that $\text{Height}_1(x^{i-1}) > \text{Height}_1(x^i) > 0$, which implies $x_1^{i-1} \leq f_1(x^{i-1})$. Since $x^{i-1} \notin \text{Up}(f)$ we must therefore have $x_2^{i-1} > f_2(x^{i-1})$. Consider the point $x' = x^i + e_2$, and note that $x' \in \text{UC}_2(x^{i-1})$. Hence Lemma 79 implies that $x_2' > f_2(x')$, which means that $\text{Height}_2(x^i) = 1$ by definition.
- In the case where $x^{i-1} = x^i + e_2$ we use the following argument. Note that since $x_1^i \leq f_1(x^i)$ we can use Lemma 80 to prove that $x_1^{i-1} \leq f_1(x^{i-1})$. Since $x^{i-1} \notin \text{Up}(f)$ we must therefore have $x_2^{i-1} > f_2(x^{i-1})$. This means that $\text{Height}_2(x^i) = 1$ by definition.

So we have shown that $\text{Height}_1(x^i) \geq \text{Height}_2(x^i) = 1 > 0$, so we can set $l = i$, which completes the proof of the first claim.

For the second claim, we proceed in a symmetric manner. Let i be the greatest index such that $x^i \in \text{Up}(f)$. Note that i cannot be k , since that would imply $x_1^i = n$, and we have ensured by preprocessing that we cannot have $x^i \in \text{Up}(f)$ in this case. Since $x^i \in \text{Up}(f)$ we clearly have both $\text{Height}_1(x^i) > 0$ and $\text{Height}_2(x^i) > 0$. We will show that $\text{Height}_1(x^i) = 1$, which then implies $\text{Height}_1(x^i) \leq \text{Height}_2(x^i)$, because the Height function is integer valued.

Note that since $x^{i+1} \in \mathcal{B}$ we have $x_3^{i+1} \leq f_3(x^{i+1})$ by definition. There are two cases to consider.

- In the case where $x^{i+1} = x^i - e_2$ we use the following argument. Note that Lemma 83 implies that $\text{Height}_2(x^{i+1}) > \text{Height}_2(x^i) > 0$, which implies $x_2^{i+1} \leq f_2(x^{i+1})$. Since $x^{i+1} \notin \text{Up}(f)$ we must therefore have $x_1^{i+1} > f_1(x^{i+1})$. Consider the point $x' = x^i + e_1$, and note that $x' \in \text{UC}_1(x^{i+1})$. Hence Lemma 79 implies that $x'_1 > f_1(x')$, which means that $\text{Height}_1(x^i) = 1$ by definition.
- In the case where $x^{i+1} = x^i + e_1$ we use the following argument. Note that since $x_2^i \leq f_2(x^i)$ we can use Lemma 80 to prove that $x_2^{i+1} \leq f_2(x^{i+1})$. Since $x^{i+1} \notin \text{Up}(f)$ we must therefore have $x_1^{i+1} > f_1(x^{i+1})$. This means that $\text{Height}_1(x^i) = 1$ by definition.

So we have shown that $\text{Height}_2(x^i) \geq \text{Height}_1(x^i) = 1 > 0$, so we can set $u = i$, which completes the proof of the second claim. \square

The previous lemma asserts the existence of points x and y with $\text{Height}_1(x) \geq \text{Height}_2(x)$ and $\text{Height}_1(y) \leq \text{Height}_2(y)$. The following lemma shows that we can find two *adjacent* points along the path defined by \mathcal{B} that satisfy this property. This is proved via applying the intermediate value theorem to the two points that we obtained from the previous lemma.

Note that the lemma also permits us to produce only one point, but this point x must satisfy $\text{Height}_1(x) = \text{Height}_2(x)$. This clause is necessary since $\text{Up}(f) \cap \mathcal{B}$ may only contain one point, in which case we cannot find two adjacent points.

Lemma 87. *Let x^1, x^2, \dots, x^k be the path defined by \mathcal{B} . If $\text{Up}(f) \cap s$ is non-empty, then there exists an index i such that either*

- $x^i \in \text{Up}(f)$ and $\text{Height}_1(x^i) = \text{Height}_2(x^i)$, or
- $x^i, x^{i+1} \in \text{Up}(f)$ and $\text{Height}_1(x^i) \geq \text{Height}_2(x^i)$ while $\text{Height}_1(x^{i+1}) \leq \text{Height}_2(x^{i+1})$.

Proof. Let l and u be the indices whose existence is shown in Lemma 86. If $l = u$, then we have that $\text{Height}_1(x^l) = \text{Height}_2(x^l)$, and so we are done.

Otherwise, we have $l < u$. Define the function $g(x) = \text{Height}_1(x) - \text{Height}_2(x)$ and observe that $g(x^l) \geq 0$ while $g(x^u) \leq 0$. So by the intermediate value theorem there must exist an index i in the range $l \leq i < u$ such that $g(x^i) \geq 0$ while $g(x^{i+1}) \leq 0$. Since $l \leq i < u$, and since $x^l, x^u \in \text{Up}(f)$, Lemma 85 implies that both $x^i \in \text{Up}(f)$ and $x^{i+1} \in \text{Up}(f)$, which completes the proof. \square

We can now finish the proof of Lemma 81. We do this by taking the points given to use by the previous lemma, and by showing that one of them is the bottom-left point of an almost square critical box. In particular, if Lemma 87 gives us a single point, then we will show that that point defines an exactly square critical box. On the other hand, if Lemma 87 gives us two points, then we will use the fact that the maximum of Height_1 and Height_2 changes between these two adjacent points, along with the properties from Lemma 83 that state that heights can differ by at most one between adjacent points, to show that one of the two points defines an almost square critical box.

Proof of Lemma 81. We consider the points whose existence is implied by Lemma 87. If we are in the first case of that lemma then we set $x = x^i$, we set $w = \text{Height}_1(x)$ and $h = \text{Height}_2(x)$. Observe that $x \in \text{Up}(f)$, so the first point of Definition 74 is satisfied, and that $x \in \mathcal{B}$, so the fourth point of Definition 74 is satisfied. Since we set $w = \text{Height}_1(x)$ and $h = \text{Height}_2(x)$ we have also satisfied the other requirements of Definition 74. Thus, (x, h, w) is a critical box, and moreover, since $\text{Height}_1(x) = \text{Height}_2(x)$, we have that $|h - w| = 0$.

If we are in the second case of Lemma 87, then we observe that if $\text{Height}_1(x^i) = \text{Height}_2(x^i)$ then $(x^i, \text{Height}_2(x^i), \text{Height}_1(x^i))$ is a square critical box, for the same reasons as above, while if $\text{Height}_1(x^{i+1}) = \text{Height}_2(x^{i+1})$ then $(x^{i+1}, \text{Height}_2(x^{i+1}), \text{Height}_1(x^{i+1}))$ is a square critical box, also for the same reasons.

This leaves the case in which $\text{Height}_1(x^i) > \text{Height}_2(x^i)$ and $\text{Height}_1(x^{i+1}) < \text{Height}_2(x^{i+1})$. We consider two cases.

- In the case where $x^{i+1} = x^i + e_1$, we have

$$\begin{aligned}
0 &< \text{Height}_1(x^i) - \text{Height}_2(x^i) \\
&= \text{Height}_1(x^{i+1}) + 1 - \text{Height}_2(x^i) \\
&\leq \text{Height}_1(x^{i+1}) + 1 - (\text{Height}_2(x^{i+1}) - 1) \\
&= 2 + \text{Height}_1(x^{i+1}) - \text{Height}_2(x^{i+1}) \\
&< 2,
\end{aligned}$$

where the first inequality is by assumption, the first equality and second inequality follow from Lemma 83, and where the final inequality holds due to the assumption that $\text{Height}_1(x^{i+1}) < \text{Height}_2(x^{i+1})$.

Hence we have $0 < \text{Height}_1(x^i) - \text{Height}_2(x^i) < 2$, and since the Height function is integer valued, we therefore have $\text{Height}_1(x^i) - \text{Height}_2(x^i) = 1$. Thus if we set $h = \text{Height}_2(x^i)$ and $w = \text{Height}_1(x^i)$, then (x^i, h, w) is a critical box with $|h - w| = 1$.

- The case where $x^{i+1} = x^i - e_2$ proceeds symmetrically.

$$\begin{aligned}
0 &< \text{Height}_2(x^{i+1}) - \text{Height}_1(x^{i+1}) \\
&= \text{Height}_2(x^i) + 1 - \text{Height}_1(x^{i+1}) \\
&\leq \text{Height}_2(x^i) + 1 - (\text{Height}_1(x^i) - 1) \\
&= 2 + \text{Height}_2(x^i) - \text{Height}_1(x^i) \\
&< 2,
\end{aligned}$$

where the first inequality is by assumption, the first equality and second inequality follow from Lemma 83, and where the final inequality holds due to the assumption that $\text{Height}_1(x^i) > \text{Height}_2(x^i)$.

Hence we have $0 < \text{Height}_1(x^{i+1}) - \text{Height}_2(x^{i+1}) < 2$, and since the Height function is integer valued, we therefore have $\text{Height}_1(x^{i+1}) - \text{Height}_2(x^{i+1}) = 1$. Thus if we set $h = \text{Height}_2(x^{i+1})$ and $w = \text{Height}_1(x^{i+1})$, then (x^{i+1}, h, w) is a critical box with $|h - w| = 1$.

□

8.4 The States of the Algorithm

We are now ready to define the algorithm itself. The following definition gives four types of states that will be considered by the algorithm. These states are shown in Figure 22.

Definition 88 (Algorithm State). Our algorithm will always be in one of the four following states, schematically represented in Figure 22.

1. A *left-lobe state* defined by two boxes: a main lobe (x, h, w) , and a sub-lobe (y, u, v) with the following restrictions.
 - $y_1 \leq x_1$ and $y_1 + v = x_1$.
 - $x_2 \leq y_2$ and $y_2 + u \leq x_2 + h$.
 - $h \leq \lfloor \frac{w}{4} \rfloor$.
2. A *bottom-lobe state* is defined by two boxes: a main lobe (x, h, w) , and a sub-lobe (y, u, v) with the following restrictions.
 - $x_1 \leq y_1$ and $y_1 + v \leq x_1 + w$.
 - $y_2 \leq x_2$ and $y_2 + u = x_2$.
 - $w \leq \lfloor \frac{h}{4} \rfloor$.
3. A *diagonal-lobe state* is defined by two diagonal boxes: a main lobe (x, y, l) , and a sub-lobe (a, b, m) with the following restriction.
 - $(y_1 - x_1) + (x_2 - y_2) \leq \lfloor \frac{l}{8} \rfloor$.
 - $a_1 = y_1 + l$ or $a_2 = x_2 + l$

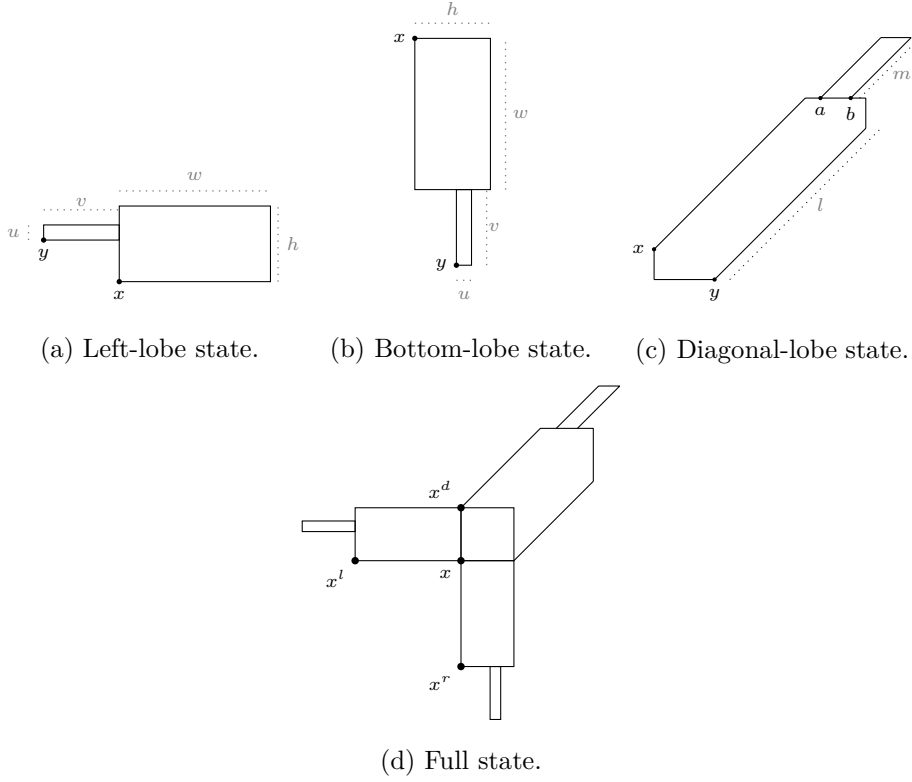

Figure 22: Grid states.

- $b_1 = y_1 + l$ or $b_2 = x_2 + l$.
4. A *full state* which consists of a central box (x, h, w) along with all three lobe states:
- A left lobe state (x^l, h^l, w^l) and (y^l, u^l, v^l) such that $x = x^l + w^l \cdot e_1$.
 - A bottom lobe state (x^r, h^r, w^r) and (y^r, u^r, v^r) such that $x = x^r + h^r \cdot e_2$.
 - A diagonal lobe state (x^d, y^d, l^d) and (a^d, b^d, m^d) such that $x^d = x + h \cdot e_2$ and $y^d = x + w \cdot e_1$.

State areas. Our algorithm will make progress by reducing the area of a state, which we now define. Given a box (x, h, w) , we define the area of the box as $\text{Area}(x, h, w) = h \cdot w$. Given a diagonal box (x, y, l) we define the area of the box as $\text{Area}(x, y, l) = (x_2 - y_2 + l)(y_1 - x_1 + l) - l^2$, which can be calculated by subtracting two right triangles of side length l from the larger rectangle including DBox. We say that a lobe is *empty* if its area is zero. In each of the states of the algorithm, it is possible for some of the boxes to be empty. For example, we may have a full state whose main left lobe is empty, but that state might still have a non-empty left sub-lobe.

The algorithm invariant. Our algorithm will ensure that all states that are visited satisfy an invariant, which we now define. For each algorithm state t we define $\text{Points}(t)$ to be the set of points that are contained in all of the boxes and diagonal boxes used to define that state. In particular, whenever t is a full state, $\text{Points}(t)$ contains all of the points of all of the sub-states used in the definition of t .

Definition 89 (Algorithm Invariant). An algorithm state t is said to satisfy the invariant for a slice s if $\text{Up}(f) \subseteq \text{Points}(t)$, and if $\text{Up}(f) \cap s \neq \emptyset$, then the following will be satisfied.

- If t is a left-lobe or bottom-lobe state, then all almost square critical boxes are entirely contained in the main lobe $\text{Box}(x, h, w)$.
- If t is a diagonal-lobe state, then there all almost square critical boxes are entirely contained in the main lobe $\text{DBox}(x, y, l)$.
- If t is a full-state, then all almost square critical boxes are entirely contained in the central box $\text{Box}(x, h, w)$.

Our goal is to produce an algorithm that, given a state t that satisfies the invariant, makes constantly many queries to f and either finds a point in $\text{Up}(f)$, or produces a new state t' that satisfies the invariant where $\text{Area}(t') \leq c \cdot \text{Area}(t)$ for some constant c . In Section 8.5 we give such an algorithm for left- and bottom-lobe states, in Section 8.6 we give such an algorithm for diagonal-lobe states, and in Section 8.7 we give such an algorithm for full states.

8.5 Algorithms for Left and Bottom Lobe States

In this section we will prove the following lemma.

Lemma 90. *There is an algorithm that, given a left-lobe state t that satisfies the invariant for a slice s , makes constantly many queries and either*

- *finds a point in $\text{Up}(f)$, or*
- *produces a new left-lobe state or full state t' that satisfies the invariant for s with $\text{Area}(t') \leq 15/16 \cdot \text{Area}(t)$.*

Moreover each step of the algorithm runs in time that is polynomial in the representation of f .

Throughout this section we consider a left-lobe state t that consists of a main lobe (x, h, w) and a sub-lobe (y, u, v) . The algorithm consists of several steps.

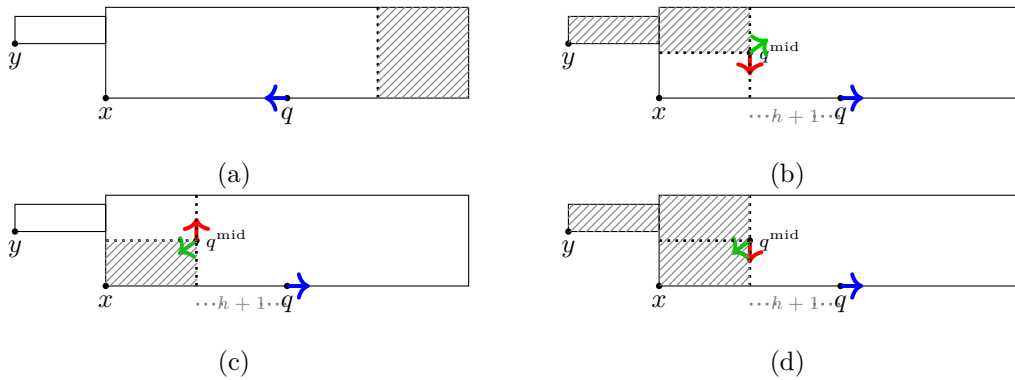

Figure 23: Step 1 - Cases 1 and 2.1-2.3

Step 1: Finding a new main lobe. The algorithm first queries the point $q = x + \lfloor \frac{w}{2} \rfloor \cdot e_1$, which is the point that lies half-way along the bottom side of the main lobe. It then proceeds with the following case analysis, where each case is shown in Figure 23.

- **Case 1:** $f_1(q) < q_1$. (Figure 23 (a)). Here we note that a point $p \in \text{Box}(x, h, w)$ with $p_1 \geq q_1 + h$ lies in $\text{UC}_1(q)$, and so by Lemma 79 we have $p \notin \text{Up}(f)$. This means that no critical box can lie in the shaded region in Figure 23 (a). So we can build a new main lobe $(x, h, \lfloor \frac{w}{2} \rfloor + h)$ that satisfies the algorithm invariant.
- **Case 2:** $f_1(q) \geq q_1$. In this case note that any almost square critical box can have height at most h , and width at most $h + 1$. Lemmas 79 and 80 imply that all points p with $p_1 \leq q_1$ and $p_2 \geq q_2$ satisfy $p_1 \leq f_1(p)$. On the other hand, if (z, a, b) is a critical box, then by definition we must have $f_1(z + (b + 1) \cdot e_1) < z_1 + b + 1$. Hence, we must have $z_1 \geq q_1 - h - 1$.

This means that we can define a new main lobe starting from point $x' = x + (\lfloor \frac{w}{2} \rfloor - h - 1) \cdot e_1$ as the box $(x', h, w - (\lfloor \frac{w}{2} \rfloor - h - 1))$, and any almost square critical box that lies in the main lobe of t must also be contained in the newly defined main lobe, which satisfies the algorithm invariant for the main lobe of a left-lobe state.

While we have reduced the size of the main lobe, we have not yet eliminated any points, so the area of the state has not been reduced. To address this, we make one further query at $q^{\text{mid}} = x + (\lfloor \frac{w}{2} \rfloor - h - 1) \cdot e_1 + \lfloor \frac{h}{2} \rfloor \cdot e_2$, and we consider the following cases.

1. $\mathbf{f}_2(\mathbf{q}^{\text{mid}}) < \mathbf{q}_2^{\text{mid}}$ (Figure 23 (b)). Here Lemmas 79 and 80 imply that any point p with $p_1 \leq q_1^{\text{mid}}$ and $p_2 \geq q_2^{\text{mid}}$ must satisfy $f_2(p) < p_2$, and so cannot lie in $\text{Up}(f)$. So we can rule out these points.
2. $\mathbf{f}_2(\mathbf{q}^{\text{mid}}) \geq \mathbf{q}_2^{\text{mid}}$ and $\mathbf{f}_3(\mathbf{q}^{\text{mid}}) < \mathbf{q}_3^{\text{mid}}$. (Figure 23 (c)). Here Lemma 80 implies that any point p with $p \leq q^{\text{mid}}$ must satisfy $f_3(p) < p_3$, which means that $p \notin \text{Up}(f)$, and so we can rule these points out.
3. $\mathbf{f}_2(\mathbf{q}^{\text{mid}}) < \mathbf{q}_2^{\text{mid}}$ and $\mathbf{f}_3(\mathbf{q}^{\text{mid}}) < \mathbf{q}_3^{\text{mid}}$. (Figure 23 (d)). Here the arguments from both of the previous cases can be combined to argue that any point p with $p_1 \leq q_1^{\text{mid}}$ cannot lie in $\text{Up}(f)$.

At the end of Step 1 of the algorithm we have defined a new smaller main lobe, and we have ruled out some of the remaining points from the original main lobe: in Case 1 all of these points are ruled out, while in Case 2 we made one extra query in order to rule out half of the remaining space.

Step 2: Building a sub-lobe. Following on from Step 1, we now need to build a new sub-lobe. In Case 1 of Step 1 we do not alter the original sub-lobe, so we can proceed with that sub-lobe and skip Step 2. On the other hand, in Case 2 of Step 1, we have the remaining area of the original main lobe, which is non-empty in Case 2.1 and Case 2.2, and we also have the original sub-lobe. We need to rationalize this remaining space into a single sub-lobe for the new state.

If the original sub-lobe has been entirely ruled out in Step 1, as it has in examples in Figures 23 (b) and 23 (d), then we simply use the remaining space from the original main lobe as the new sub-lobe. So for example, in Figure 23 (b) the new sub-lobe would be $(x, \lfloor \frac{h}{2} \rfloor, \lfloor \frac{w}{2} \rfloor - h - 1)$, while in Figure 23 (d) we can use an empty lobe as the new sub-lobe. In both cases Step 2 of the algorithm terminates. If the original sub-lobe has only partially been ruled out in Step 1, then we first reduce the sub-lobe by removing the eliminated points before continuing with the procedure below.

The situation that we must handle is depicted in Figure 23 (c): we have a non-empty remaining space on the left of the old main lobe, and a sub-lobe that lies to the left of this space. Our task is to rationalize these two spaces into a single sub-lobe for the new state.

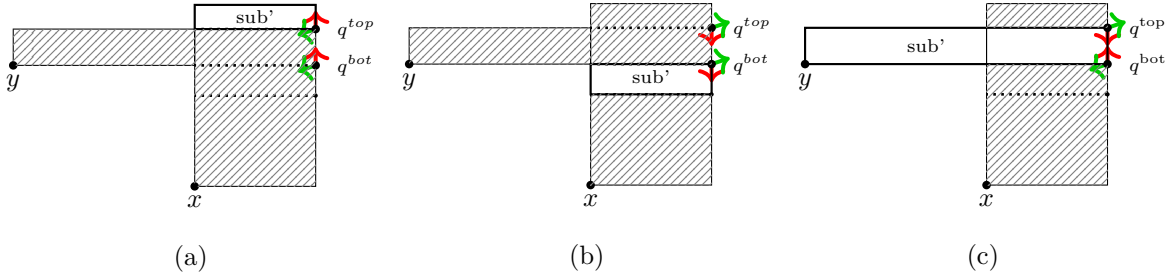

Figure 24: Step 2 - Cases 1, 2 and 5

Let $(\hat{y}, \hat{u}, \hat{v})$ be the remaining sub-lobe of state t after the original sub-lobe was reduced by removing the points that were ruled out in Step 1. We query the points

$$q^{\text{bot}} = x + \left(\left\lfloor \frac{w}{2} \right\rfloor - h - 1 \right) \cdot e_1 + (\hat{y}_2 - x_2) \cdot e_2,$$

$$q^{\text{top}} = x + \left(\left\lfloor \frac{w}{2} \right\rfloor - h - 1 \right) \cdot e_1 + (\hat{y}_2 + \hat{u} - x_2) \cdot e_2,$$

as shown in Figure 24. We then consider the following cases.

- **Case 1.** $\mathbf{f}_3(q^{\text{top}}) < \mathbf{q}_3^{\text{top}}$. (Figure 24 (a)). Here, as in Step 1, Case 2.2, all points below and to the left of q^{top} cannot lie in $\text{Up}(f)$, and this rules out the existing sub-lobe. So we can use the remaining space, which is labelled sub' in Figure 24, as the new sub-lobe.
- **Case 2.** $\mathbf{f}_2(q^{\text{bot}}) < \mathbf{q}_2^{\text{bot}}$. (Figure 24 (b)). Here, as in Step 1, Case 2.1, all points above and to the left of q^{bot} cannot lie in $\text{Up}(f)$, and this rules out the existing sub-lobe, so we can use the remaining space as a new sub-lobe.
- **Case 3.** $\mathbf{f}_3(q^{\text{top}}) \geq \mathbf{q}_3^{\text{top}}$ and $\mathbf{f}_2(q^{\text{top}}) \geq \mathbf{q}_2^{\text{top}}$. Here note that $q^{\text{top}} \in \text{DC}_1(q)$, where q is the point that we initially queried in Step 1, so we can use Lemma 79 to argue that $f_1(q^{\text{top}}) \geq q_1^{\text{top}}$, meaning that $q^{\text{top}} \in \text{Up}(f)$. So the algorithm can terminate and return q^{top} .

- **Case 4.** $\mathbf{f}_3(\mathbf{q}^{\text{bot}}) \geq \mathbf{q}_3^{\text{bot}}$ and $\mathbf{f}_2(\mathbf{q}^{\text{bot}}) \geq \mathbf{q}_2^{\text{bot}}$. Using the same reasoning as the previous case we can conclude that $q^{\text{bot}} \in \text{Up}(f)$. So the algorithm can terminate and return q^{bot} .
- **Case 5.** If none of the previous cases apply then we have $\mathbf{f}_2(\mathbf{q}^{\text{top}}) < \mathbf{q}_2^{\text{top}}$, $\mathbf{f}_3(\mathbf{q}^{\text{top}}) \geq \mathbf{q}_3^{\text{top}}$, $\mathbf{f}_2(\mathbf{q}^{\text{bot}}) \geq \mathbf{q}_2^{\text{bot}}$ and $\mathbf{f}_3(\mathbf{q}^{\text{bot}}) < \mathbf{q}_3^{\text{bot}}$, as shown in Figure 24 (c). Here we can simply extend the sub-lobe (y, u, v) to $(y, u, v + \lfloor \frac{w}{2} \rfloor - h - 1)$.

At the end of Step 2 we now have a single sub-lobe that can be taken forward into Step 3.

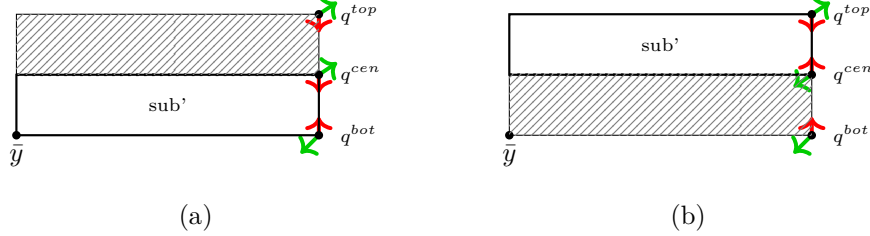

Figure 25: Sub-Algorithm - Cases 2.5.a and 2.5.b

Step 3: Halving the sub-lobe. The final step of the algorithm is to halve the area of the sub-lobe. We need to do this because a significant proportion of the area of t may lie in the sub-lobe, and this area may not have been reduced by the previous steps.

If there is no sub-lobe arising from the previous steps, then we skip Step 3. Otherwise, let $(\bar{y}, \bar{u}, \bar{v})$ be the sub-lobe that has been defined in Steps 1 and 2. We query the point

$$q^{\text{cen}} = \bar{y} + \bar{v} \cdot e_1 + \left\lfloor \frac{\bar{u}}{2} \right\rfloor \cdot e_2,$$

which is the point that is half-way along the right-hand side of the sub-lobe. We then consider the following cases.

1. **Case 1.** $\mathbf{f}_2(\mathbf{q}^{\text{cen}}) < \mathbf{q}_2^{\text{cen}}$. (Figure 25 (a)). As in previous steps, this rules out all points weakly above and to the left of q^{cen} , which approximately halves the size of the sub-lobe.
2. **Case 2.** $\mathbf{f}_3(\mathbf{q}^{\text{cen}}) < \mathbf{q}_3^{\text{cen}}$. (Figure 25 (b)). As in previous cases, this rules out all points weakly below and to the left of q^{cen} , which approximately halves the size of the sub-lobe.
3. **Case 3.** If neither of the previous two cases apply then we have $\mathbf{f}_2(\mathbf{q}^{\text{cen}}) \geq \mathbf{q}_2^{\text{cen}}$ and $\mathbf{f}_3(\mathbf{q}^{\text{cen}}) \geq \mathbf{q}_3^{\text{cen}}$. We can use the same reasoning as cases 3 and 4 of Step 2 to conclude that $q^{\text{cen}} \in \text{Up}(f)$, and so the algorithm can terminate.

Step 4: Building the new state. At this point we have a new main lobe $m = (x', h', w')$ that was found in Step 1, and a new sub-lobe $l = (y', u', v')$ that was found in Step 3. We now build a new state t' in the following way.

- If $h' \leq \left\lfloor \frac{w'}{4} \right\rfloor$, then we build a new left-lobe state using m and l .
- If $h' > \left\lfloor \frac{w'}{4} \right\rfloor$, then we build a new full state using m as the central box, using l as the main lobe of the left-lobe state, and setting all other main and sub-lobes to be empty.

The algorithm now returns t' and terminates.

Correctness. So far we have built a state t' , and we have shown that the algorithm invariant holds for t' . Specifically we have shown the following.

- In Step 1, we showed that if an almost square critical box lies in the main lobe of t , then it must lie in the main lobe of t' . This is because we specifically removed regions from the main lobe that could not contain an almost square critical box.

- We have shown that $\text{Up}(f)$ is contained within the main and sub lobes of t' . This is because $\text{Up}(f)$ was contained within t , and all steps of the algorithm only removed points that are provably not in $\text{Up}(f)$.

To finish the proof of Lemma 90 we need to show that the area of t' has been sufficiently reduced.

- Step 1 of the algorithm removes at least $1/16$ of the area of the original main lobe (x, h, w) . Specifically, Step 1 Case 1 removes a $(w - \lfloor \frac{w}{2} \rfloor - h)/w$ fraction of the area, and since $h \leq \lfloor \frac{w}{4} \rfloor$, this means that at least $\lfloor \frac{w}{4} \rfloor / 4 \geq 1/8$ fraction of the area has been removed. The three different cases of Step 2 Case 2, remove less area, since only half of the remaining area of the main lobe is eliminated, so these cases remove a $1/16$ fraction of the area.
- The original sub-lobe is either entirely removed in Step 1 or Step 2, or it is processed by Step 3, in which case we remove a $\lfloor \frac{u}{2} \rfloor / u$ fraction of the area of the original sub-lobe (y, u, v) .
 - If $u = 0$ then the area of the sub-lobe is zero, and we are done.
 - If $u = 1$ then note that Step 4 Cases 1 and 2 both rule out at least half of the points in the sub-lobe since weak inequalities are used when determining what to rule out.
 - If $u \geq 2$ then note that $\lfloor \frac{u}{2} \rfloor / u \geq 1/3$.

So we have shown that the original main lobe and the original sub lobe have both been reduced in area by a fraction of at least $1/16$, which implies $\text{Area}(t') \leq \frac{15}{16} \text{Area}(t)$.

Bottom-lobe states. We can use the same algorithm for bottom-lobe states by simply exchanging dimensions 1 and 2. So we have the following lemma.

Lemma 91. *There is an algorithm that, given a bottom-lobe state t that satisfies the invariant, makes constantly many queries and either*

- *finds a point in $\text{Up}(f)$, or*
- *produces a new bottom-lobe state or full state t' that satisfies the invariant with $\text{Area}(t') \leq 15/16 \cdot \text{Area}(t)$.*

Moreover each step of the algorithm runs in time that is polynomial in the representation of f .

8.6 The Algorithm for Diagonal States

This section proves the equivalent of Lemma 90 for diagonal states. It follows exactly the same approach as we used for Lemma 90, but each step has to be adapted to work with diagonal regions.

Lemma 92. *There is an algorithm that, given a diagonal-lobe state t , makes constantly many queries and either*

- *finds a point in $\text{Up}(f)$,*
- *declares that $\text{Up}(f)$ is empty in the current slice, or*
- *produces a new diagonal state t' that satisfies the invariant with $\text{Area}(t') \leq 15/16 \cdot \text{Area}(t)$, or*
- *produces a new full state t' that satisfies the invariant with $\text{Area}(t') \leq 5 \cdot \text{Area}(t)$.*

Moreover, each step of the algorithm runs in time that is polynomial in the representation of f .

Note that the last case here shows that the area may be *increased*. This is not a problem however, because as we shall see this case can occur at most once per slice, and this increase can be cancelled out by taking constantly many further steps. We will deal with this explicitly when we analyse the overall running time of the algorithm in Section 8.9.

The algorithm receives as input a diagonal lobe state t that consists of a main lobe (x, y, l) and a sub-lobe (a, b, m) . Similarly to the left lobe case, the algorithm either finds a point in $\text{Up}(f)$ or creates a new state t' that satisfies the invariant.

We define the horizontal width w of a diagonal lobe (x, y, l) to be:

$$w(x, y, l) = (x_2 - y_2) + (y_1 - x_1)$$

Step 1: Finding a new main lobe. As an initial query, the algorithm queries the point

$$q = \left(y_1 + \left\lfloor \frac{l}{2} \right\rfloor, x_2 + \left\lfloor \frac{l}{2} \right\rfloor \right),$$

which is located halfway along the main lobe. We consider the following cases.

- **Case 1:** $\mathbf{f}_3(\mathbf{q}) < \mathbf{q}_3$ (Figure 26 (a)). By Lemma 80, no point p in $\text{DBox}(x, y, \lfloor \frac{l}{2} \rfloor)$ can satisfy $p \in \text{Up}(f)$, which in turn excludes the existence of any critical box in this region. The new main lobe is defined as

$$\text{DBox} \left(x + \left\lfloor \frac{l}{2} \right\rfloor \cdot e_1 + \left\lfloor \frac{l}{2} \right\rfloor \cdot e_2, y + \left\lfloor \frac{l}{2} \right\rfloor \cdot e_1 + \left\lfloor \frac{l}{2} \right\rfloor \cdot e_2, \left\lfloor \frac{l}{2} \right\rfloor \right).$$

Since we have only eliminated points that cannot lie in $\text{Up}(f)$, any critical box contained in the old main must also be contained in the new main lobe.

- **Case 2:** $\mathbf{f}_3(\mathbf{q}) \geq \mathbf{q}_3$. In this case, any critical box can have width at most $w(x, y, l)$ since it is contained within the main lobe. Note that all points with $p_1 \geq q_1$ and $p_2 \geq q_2$ satisfy $f_3(p) \geq p_3$, due to Lemma 80. By definition, any critical box (z, h, w) must satisfy $f_3(z - (e_1 + e_2)) < z_3$, and since we cannot satisfy this for any point $p \geq q$, we must have that the bottom left corner of (z, h, w) must have $z_1 \leq q_1 \leq y_1 + \lfloor \frac{l}{2} \rfloor$ and $z_2 \leq q_2 \leq x_1 + \lfloor \frac{l}{2} \rfloor$.

So we can reduce the main lobe by eliminating any point that is not below $(y_1 + \lfloor \frac{l}{2} \rfloor + 2w, x_2 + \lfloor \frac{l}{2} \rfloor + 2w)$, and therefore define a new main lobe $\text{DBox}(x, y, \lfloor \frac{l}{2} \rfloor + 2w)$. This is valid because any box that is contained within the original main lobe can have height and width at most $(x_2 - y_2) + (y_1 - x_1) = w$.

So if the main lobe of state t contains an almost square critical box, then such a box is also contained within the new main lobe, satisfying the invariant.

This operation has reduced the size of the main lobe, but it has not yet eliminated any points. To do this, we make one further query at

$$q^{\text{mid}} = \left(x_1 + \left\lfloor \frac{l}{2} \right\rfloor + 2w + \left\lfloor \frac{\|x - y\|_\infty}{2} \right\rfloor, x_2 + \left\lfloor \frac{l}{2} \right\rfloor + 2w \right)$$

for which $f_3(q^{\text{mid}}) \geq q_3^{\text{mid}}$ holds. Given the assumption that $w \leq \lfloor \frac{l}{8} \rfloor$, q^{mid} is well defined within the lobe. The orientation of q^{mid} along dimensions 1 and 2 guarantees that the query point splits the remaining lobe in half, maintaining the invariant.

1. $\mathbf{f}_1(\mathbf{q}^{\text{mid}}) < \mathbf{q}_1^{\text{mid}}$ **and** $\mathbf{f}_2(\mathbf{q}^{\text{mid}}) \geq \mathbf{q}_2^{\text{mid}}$. (Figure 26 (b)). Here Lemmas 79 and 80 imply that any point p with $p_1 \geq q_1^{\text{mid}}$ and $p_2 \leq q_2^{\text{mid}}$ as well as all points in $\text{UC}_1(q^{\text{mid}})$ must satisfy $f_1(p) < p_1$. Therefore for all points $p \notin \text{Up}(f)$, and so can be excluded.
2. $\mathbf{f}_1(\mathbf{q}^{\text{mid}}) \geq \mathbf{q}_1^{\text{mid}}$ **and** $\mathbf{f}_2(\mathbf{q}^{\text{mid}}) < \mathbf{q}_2^{\text{mid}}$. (Figure 26 (c)). Lemmas 79 and 80 imply that any point p with $p_1 \leq q_1^{\text{mid}}$ and $p_2 \geq q_2^{\text{mid}}$ as well as all points in $\text{UC}_2(q^{\text{mid}})$ must satisfy $f_2(p) < p_2$, and is excluded from $\text{Up}(f)$. These points can be ruled out.
3. $\mathbf{f}_1(\mathbf{q}^{\text{mid}}) < \mathbf{q}_1^{\text{mid}}$ **and** $\mathbf{f}_2(\mathbf{q}^{\text{mid}}) < \mathbf{q}_2^{\text{mid}}$. (Figure 26 (d)). Here the arguments from both of the previous cases can be combined to argue that no point in the union of the above regions can lie in $\text{Up}(f)$, and the sub-lobe at case t' is empty.

Step 1 has reduced the main lobe for the next state, and ruled out regions of the original main and sub-lobe. Case 1 results in an empty sub-lobe, while case 2 introduces an additional query point that rules out half of the remaining space.

Step 2: Building a sub-lobe. This step deals with the construction of a new sub-lobe. Cases 1 and 2.3 of Step 1 result in an empty sub-lobe, so the algorithm directly jumps to Step 4. Cases 2.1 and 2.2 maintain the original sub-lobe in parts or entirely, and thus further action is required to merge the sub-lobe and the remaining space from the old main-lobe into a single diagonal box. In the case where the original sub-lobe is partially excluded by the constraints on q^{mid} at Step 1, the sub-lobe is first altered to remove those points before we proceed. Specifically, we denote the sub-lobe remaining after the processing of Step 1 as (\hat{a}, \hat{b}, m) . The algorithm then queries two additional points:

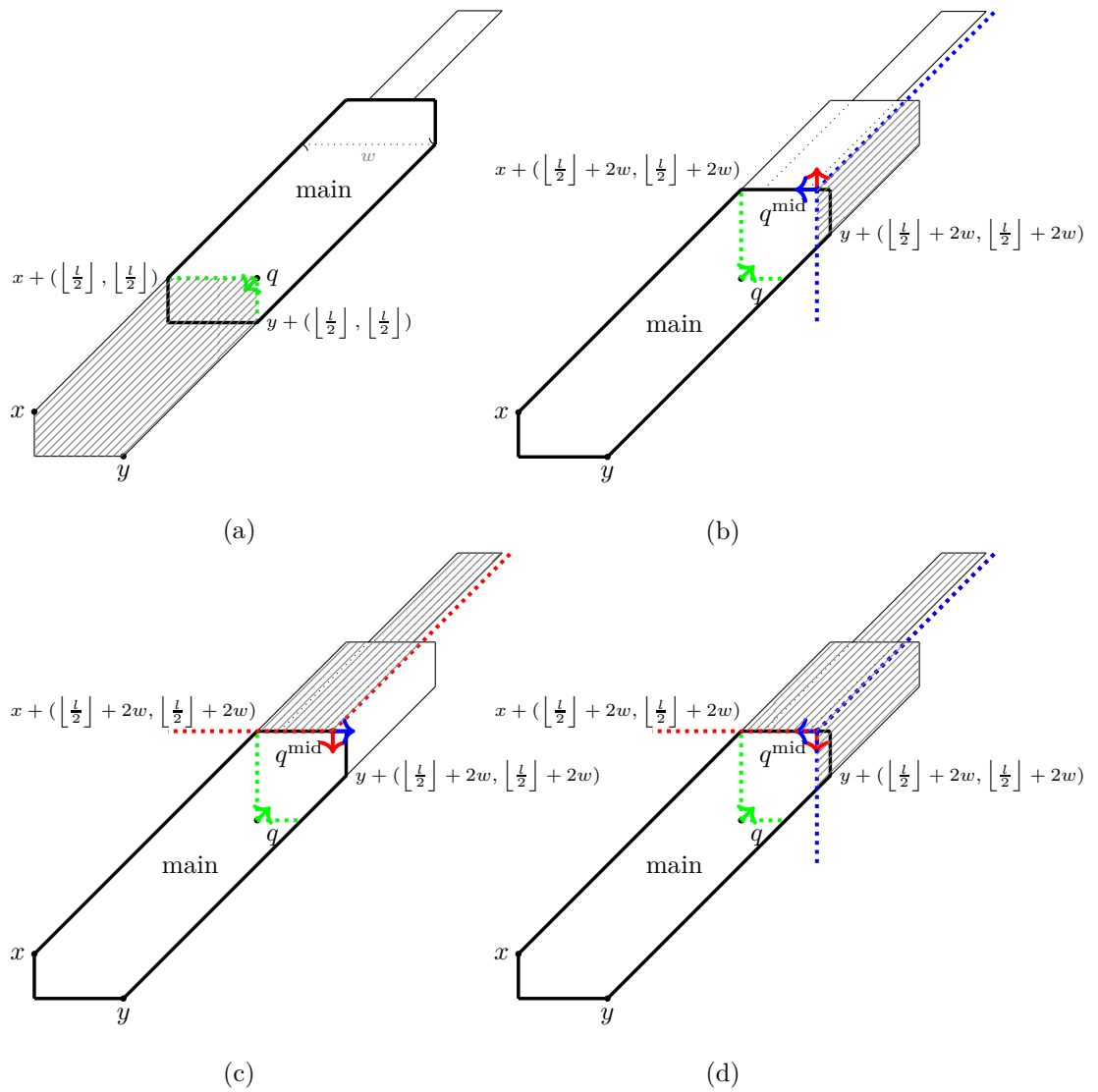

Figure 26: Diagonal Lobe State: Step 1 - Cases 1 and 2.1-2.3.

$$q^{\text{left}} = \hat{a} - \left(\left\lfloor \frac{l}{2} \right\rfloor + 2w \right) \cdot e_1 - \left(\left\lfloor \frac{l}{2} \right\rfloor + 2w \right) \cdot e_2,$$

$$q^{\text{right}} = \hat{b} - \left(\left\lfloor \frac{l}{2} \right\rfloor + 2w \right) \cdot e_1 - \left(\left\lfloor \frac{l}{2} \right\rfloor + 2w \right) \cdot e_2$$

as shown in Figure 27. We identify the following cases.

- **Case 1.** $\mathbf{f}_2(\mathbf{q}^{\text{left}}) < \mathbf{q}_2^{\text{left}}$. (Figure 27 (a)). All points in the region $UC_2(q^{\text{left}})$ located above and to the right of q^{left} are restricted from $\text{Up}(f)$ by Lemma 79, which rules out the existing sub-lobe. So we can use the remaining space as the new sub-lobe.
- **Case 2.** $\mathbf{f}_1(\mathbf{q}^{\text{right}}) < \mathbf{q}_1^{\text{right}}$. (Figure 27 (b)) All points in $UC_1(q^{\text{right}})$, located to the left of q^{right} cannot lie in $\text{Up}(f)$ by Lemma 79, and the existing sub-lobe is excluded. The new sub-lobe is bounded by q^{right} and q^{mid} .
- **Case 3.** $\mathbf{f}_1(\mathbf{q}^{\text{left}}) \geq \mathbf{q}_1^{\text{left}}$ and $\mathbf{f}_2(\mathbf{q}^{\text{left}}) \geq \mathbf{q}_2^{\text{left}}$. Since Step 2 is only reached when $f_3(q) \geq q_3$, Lemma 80 implies that $f_3(q^{\text{mid}}) \geq q_3^{\text{mid}}$, since $q_1^{\text{mid}} \geq q_1$ and $q_2^{\text{mid}} \geq q_2$. Then $q^{\text{left}} \in \text{Up}(f)$, and the algorithm terminates returning q^{left} .
- **Case 4.** $\mathbf{f}_1(\mathbf{q}^{\text{right}}) \geq \mathbf{q}_1^{\text{right}}$ and $\mathbf{f}_2(\mathbf{q}^{\text{right}}) \geq \mathbf{q}_2^{\text{right}}$. Applying the same monotonicity argument as above, the algorithm terminates, returning $q^{\text{right}} \in \text{Up}(f)$.
- **Case 5.** $\mathbf{f}_1(\mathbf{q}^{\text{left}}) \geq \mathbf{q}_1^{\text{left}}$, $\mathbf{f}_2(\mathbf{q}^{\text{left}}) < \mathbf{q}_2^{\text{left}}$, $\mathbf{f}_1(\mathbf{q}^{\text{right}}) < \mathbf{q}_1^{\text{right}}$ and $\mathbf{f}_2(\mathbf{q}^{\text{right}}) \geq \mathbf{q}_2^{\text{right}}$ (Figure 27 (c)). In this case, the original sub-lobe remains intact and is extended as $(q^{\text{left}}, q^{\text{right}}, \lfloor \frac{l}{2} \rfloor - w - 1 + m)$.

Upon merging the above cases to a single sub-lobe, the algorithm moves to Step 3 which performs a further area reduction.

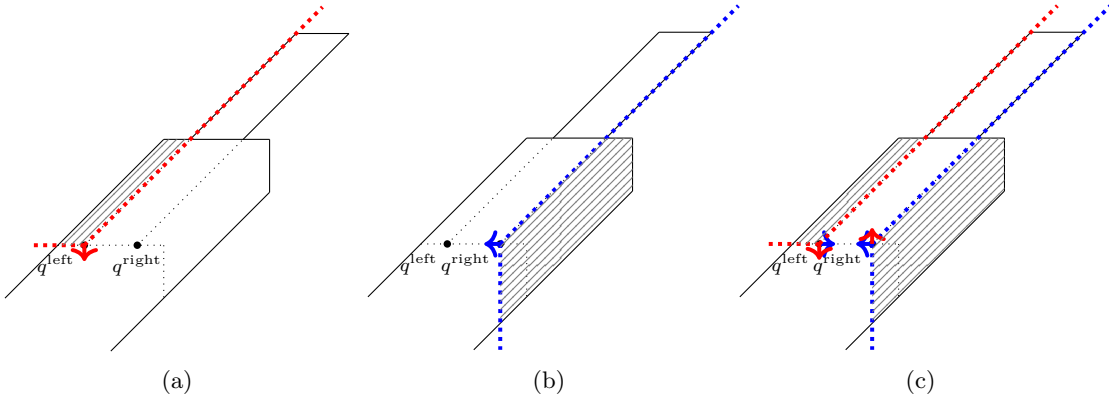

Figure 27: Diagonal Lobe State: Step 2 - Cases 1, 2 and 5.

Step 3: Halving the sub-lobe. In this step, the algorithm makes one final query that reduces the remaining sub-lobe's area by a half. This is necessary, because the sub-lobe area might constitute a significant fraction of $\text{Area}(t)$. This step is only executed when the algorithm so far has left a non empty sub-lobe. If the sub-lobe is empty, then we can jump directly to Step 4.

Let $(\bar{a}, \bar{b}, \bar{m})$ be the sub-lobe that remains after Steps 1 and 2. We query the point

$$q^{\text{cen}} = \left\lfloor \frac{\bar{a} + \bar{b}}{2} \right\rfloor - \left(\left\lfloor \frac{l}{2} \right\rfloor + 2w \right) \cdot e_1 - \left(\left\lfloor \frac{l}{2} \right\rfloor + 2w \right) \cdot e_2$$

which corresponds to the midpoint between \bar{a} and \bar{b} at a height of $(\lfloor \frac{l}{2} \rfloor + 2w)$. The following cases are considered.

1. **Case 1.** $\mathbf{f}_2(\mathbf{q}^{\text{cen}}) < \mathbf{q}_2^{\text{cen}}$. (Figure 28 (a)). Lemmas 80 and 79 rule out all points weakly above and to the right of q^{cen} , as well as points in $UC_2(q^{\text{cen}})$, which approximately halves the size of the sub-lobe.

2. **Case 2.** $\mathbf{f}_1(\mathbf{q}^{\text{cen}}) < \mathbf{q}_1^{\text{cen}}$. (Figure 28 (b)). Similarly to the previous case, Lemmas 80 and 79 imply that all points weakly above and to the left of q^{cen} , as well as points in $UC_1(q^{\text{cen}})$, can be excluded, and the resulting size of the sub-lobe is approximately halved.
3. **Case 3.** If none of the above cases apply, then we have $\mathbf{f}_1(\mathbf{q}^{\text{cen}}) \geq \mathbf{q}_1^{\text{cen}}$ and $\mathbf{f}_2(\mathbf{q}^{\text{cen}}) \geq \mathbf{q}_2^{\text{cen}}$. By the same argument as cases 3 and 4 of Step 2, we can conclude that $q^{\text{cen}} \in \text{Up}(f)$, and the algorithm terminates, returning q^{cen} .

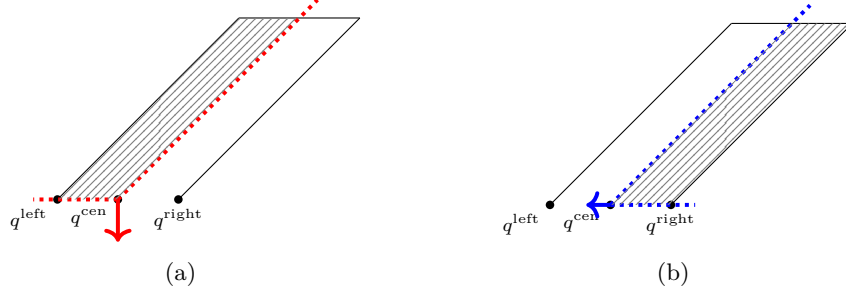

Figure 28: Diagonal Lobe State: Step 3 - Cases 1 and 2.

Step 4: Building the new state. The new main lobe, produced by Step 1, is defined as (x', y', l') , with width w' , and the new sub-lobe (a', b', m') is the result of Step 3. A new state t' is build as follows.

- If $w' \leq \lfloor \frac{l'}{8} \rfloor$, the next diagonal lobe state t' is built using the lobes defined above.
- If $w' > \lfloor \frac{l'}{8} \rfloor$, a new full state is built. The full state consists of a central box $(x, l + (y_1 - x_1), l + (y_2 - x_2))$, surrounding the main lobe (x', y', l') , and the new lobe of the diagonal lobe state becomes (a', b', m') . All other lobes are set to be empty.

The new state t' is returned and the algorithm terminates.

Correctness. Our analysis so far has shown that, if the algorithm invariant holds for state t , then it also holds for state t' . Specifically, we have shown the following.

- Step 1 constructs the new main lobe. We have argued that if an almost square critical box lies in the main lobe of t , it must also lie in the main lobe of t' , since we have only excluded regions that cannot contain a critical box.
- We have shown that $\text{Up}(f)$ is contained within the main and sub lobes of t' . This is because $\text{Up}(f)$ was contained within t , and all steps of the algorithm only removed points that are provably not in $\text{Up}(f)$.

As a last step of the proof of Lemma 92, we show the area reduction at state t' for the case where $w \leq \lfloor \frac{l}{8} \rfloor$.

- Case 1 of Step 1 removes at least 1/2 of the area of the original main lobe (x, y, l) , under the weaker assumption $w < l$, as the remaining area is $(y_1 - x_1)(x_2 - y_2) + \frac{l}{2}w$ compared to the original main lobe with area $(y_1 - x_1)(x_2 - y_2) + lw$. Case 2 results in a new main lobe $(x, y, \lfloor \frac{l}{2} \rfloor + 2w)$ which removes at least 1/8 of the original lobe, since $w \leq \lfloor \frac{l}{8} \rfloor$. The area of the main lobe in this case is defined as $(y_1 - x_1)(x_2 - y_2) + (\frac{l}{2} + 2w)w$.
- Cases 1, 2 and 5 of Step 2 maintain parts of the original main lobe as the new sub-lobe at t' . Since the remaining area of the original main lobe is at most 7/8, the query at q^{mid} and subsequent points results in at least 1/2 reduction of the area, due to Lemma 79 halving along the diagonal lobe. Combined, these cases result in an overall state area equal to 15/16 of the original main lobe.
- The sub-lobe of state t is either entirely removed in Step 1 or Step 2, or processed at Step 3. In this case, half of the lobe is removed by the constraints on q^{cent} .

- If $m = 0$, the entire sub-lobe is empty.
- If $m \geq 1$, then Cases 1 and 2 of Step 3 rule out half of the diagonal sub-lobe, due to Lemma 79.

So we have shown that the original main lobe and the original sub lobe have both been reduced in area by a fraction of at least $1/16$, which implies $\text{Area}(t') \leq \frac{15}{16} \text{Area}(t)$. So if we create a diagonal-lobe state then we are done.

If $w > \lfloor \frac{l}{8} \rfloor$, the area of the new full state is increased. The full state consists of a central box and diagonal lobe. The original sub-lobe at state t becomes the main lobe of the diagonal lobe state, thus resulting in no increase in area. However, as the diagonal lobe must be attached to the central box, this is needs to be extended to match the new lobe, thus leading to an area increase. The new central box $(x, l + (x_2 - y_2), l + (y_1 - x_1))$ corresponds to the original main lobe with two added triangles. The area of the box is then $l^2 + l \cdot w + (y_1 - x_1)(x_2 - y_2)$ as opposed to $l \cdot w + (y_1 - x_1)(x_2 - y_2)$ of the main lobe. Analysing the two quantities, we conclude that the area of the central box is at most 5 times the area of the original main lobe of the diagonal state.

8.7 The Algorithm for Full States

In this section we will prove the following lemma.

Lemma 93. *Let t be a full-state that satisfies the invariant for some slice s , and whose central box (x, h, w) satisfies $h \leq c \cdot w$ and $w \leq c \cdot h$ for some constant c . There is an algorithm that makes constantly many queries and either*

- *finds a point in $\text{Up}(f)$,*
- *declares that $\text{Up}(f)$ is empty in the current slice, or*
- *produces a new full-state t' that satisfies the invariant for s with $\text{Area}(t') \leq 2/3 \cdot \text{Area}(t)$.*

Moreover, each step of the algorithm runs in time that is polynomial in the representation of f .

Step 1. Grid search on the central box. Let (x, h, w) be the central box of t . Step 1 of the algorithm considers a square grid with constantly many points covering this box.

Without loss of generality we will assume that $w \leq h$, and we define $k = \lceil w/100 \rceil$. For technical convenience, we will consider the box (x, h', w') where h' and w' are the smallest integers satisfying $h' \geq h$ and $w' \geq w$ such that both h' and w' are divisible by k . Observe that since $\text{Box}(x, h, w) \subseteq \text{Box}(x, h', w')$, we have that the algorithm invariant is also satisfied by (x, h', w') , and moreover since $w \leq h$ we have

$$\begin{aligned} \text{Area}(x, h', w') &= h \cdot w + \left\lceil \frac{w}{100} \right\rceil \cdot h + \left\lceil \frac{w}{100} \right\rceil \cdot w + \left(\left\lceil \frac{w}{100} \right\rceil \right)^2 \\ &\leq \left(1 + \frac{3}{100} \right) h \cdot w = 1.03 \cdot \text{Area}(x, h, w). \end{aligned}$$

We use the grid

$$R = \{x_1 + 0, x_1 + k, x_1 + 2k, \dots, x_1 + w'\} \times \{x_2 + 0, x_2 + k, x_2 + 2k, \dots, x_2 + h'\},$$

meaning that R is a square grid that spans the box defined by (x, h', w') , where each grid square has side-length k . Since by assumption we have $w \leq c \cdot h$ for some constant c , we also have $w' \leq c' \cdot h'$ for some constant c' , and so R contains constantly many points.

Hence we can query every point in R using constantly many queries. If some point in R lies in $\text{Up}(f)$, then the algorithm can terminate. If we do not find a point in $\text{Up}(f)$, we will then look for a *CB-config* in R , which is a 2×2 box in R satisfies the following properties.

- We have that f_1 changes direction on either the bottom or top edge of the box, meaning that f_1 moves weakly upwards on the left-hand side, while f_1 moves strictly downwards on the right-hand side.
- Likewise, we have that f_2 changes direction on either left or right edges of the box.
- The bottom-left point of the box moves strictly downwards in the third dimension, while the top-right point of the box moves weakly upwards.

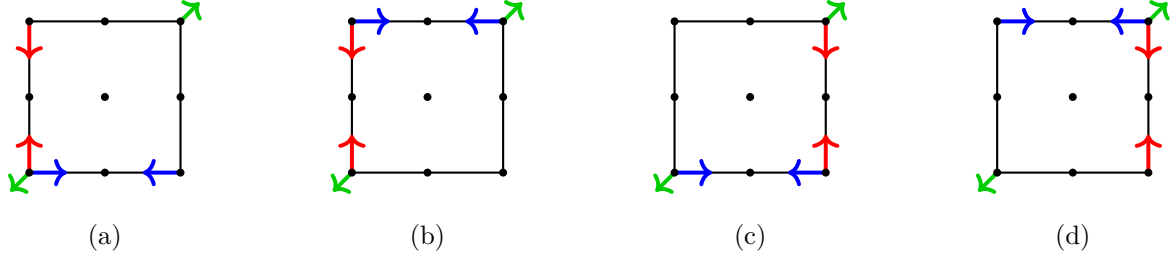

Figure 29: CB-Config square orientations.

The four possible CB-configs are shown in Figure 29, and we now provide a formal definition.

Definition 94 (CB-Config). A box $(x, 2k, 2k)$ with $x \in R$ is a *CB-config* if all of the following properties are satisfied.

1. For dimension 1 we have

$$\begin{array}{ccc}
 f_1(x) \geq x_1 & \text{or} & f_1(x + 2k \cdot e_2) \geq x_1 \\
 f_1(x + 2k \cdot e_1) < x_1 + 2k & & f_1(x + 2k \cdot e_1 + 2k \cdot e_2) < x + 2k.
 \end{array}$$

2. Likewise for dimension 2 we have

$$\begin{array}{ccc}
 f_2(x) \geq x_2 & \text{or} & f_2(x + 2k \cdot e_1) \geq x_2 \\
 f_2(x + 2k \cdot e_2) < x_2 + 2k & & f_2(x + 2k \cdot e_1 + 2k \cdot e_2) < x + 2k.
 \end{array}$$

3. For dimension 3 we have

$$\begin{array}{c}
 f_3(x) < x_3 \\
 f_3(x + 2\varepsilon \cdot e_1 + 2\varepsilon \cdot e_2) \geq x_3.
 \end{array}$$

We begin by showing that a CB-config will exist so long as $\text{Up}(f) \cap s$ is non-empty. Recall that algorithm invariant ensures that if $\text{Up}(f) \cap s$ is non-empty, then the central box of t contains an almost square critical box. Since our grid search using R failed to find a point in $\text{Up}(f)$, and since all points in a critical box are in $\text{Up}(f)$ by Lemma 75, this places an upper bound on the side-lengths of the almost square critical box. Specifically, if the box was larger than $k \times k$, then some point in R would lie in the box, and we would have found a point in $\text{Up}(f)$, so we know that the box is no larger than $k - 1 \times k$ or $k \times k - 1$.

This implies that the almost square critical box, if it exists, must lie in a $2k \times 2k$ square of R . The next lemma shows that if an almost square critical box lies inside a $2k \times 2k$ square of R , then that square will be a CB-config.

Lemma 95. *Let $S = (x, 2k, 2k)$ be a square with $x \in R$. If there exists an almost square critical box inside S , then S is a CB-config.*

Proof. Suppose that the almost square critical box that lies inside S is defined by $C = (y, h, w)$, and note that we therefore have $x \leq y$, and $h, w \leq k$.

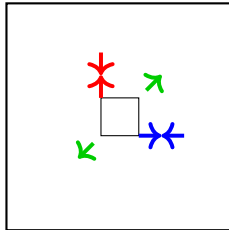

Figure 30: Direction functions evaluated at a critical box located within grid square.

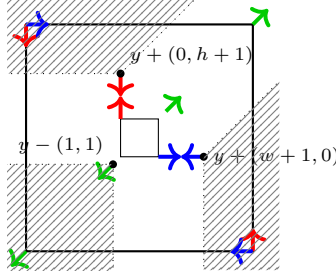

Figure 31: Initial configurations of grid square arising from containment of critical box.

The definition of a critical box gives us information about the displacements of f around C , as shown in Figure 30, and these then imply displacements at the corners of S , as shown in Figure 31. The properties for dimension 1, shown in blue in the figures, can be proved formally as follows.

$$\begin{aligned} f_1(y + w \cdot e_1) \geq y_1 + w &\Rightarrow f_1(x + (y_2 - x_2) \cdot e_2) \geq x_1 && \text{(By Lemma 79)} \\ &\Rightarrow f_1(x + 2k \cdot e_2) \geq x_1 && \text{(By Lemma 80)} \end{aligned}$$

$$\begin{aligned} f_1(y + (w + 1) \cdot e_1) < y_1 + (w + 1) &\Rightarrow f_1(x + (y_2 - x_2) \cdot e_2 + 2k \cdot e_1) < x_1 + 2k && \text{(By Lemma 79)} \\ &\Rightarrow f_1(x + 2k \cdot e_1) < x_1 + 2k && \text{(By Lemma 80)} \end{aligned}$$

Symmetrically, the properties for dimension 2, shown in red in the figures, can be proved formally as follows.

$$\begin{aligned} f_2(y + h \cdot e_2) \geq y_2 + h &\Rightarrow f_2(x + (y_1 - x_1) \cdot e_1) \geq x_2 && \text{(By Lemma 79)} \\ &\Rightarrow f_2(x + 2k \cdot e_1) \geq x_2 && \text{(By Lemma 80)} \end{aligned}$$

$$\begin{aligned} f_2(y + (h + 1) \cdot e_2) < y_2 + (h + 1) &\Rightarrow f_2(x + (y_1 - x_1) \cdot e_1 + 2k \cdot e_2) < x_2 + 2k && \text{(By Lemma 79)} \\ &\Rightarrow f_2(x + 2k \cdot e_2) < x_2 + 2k && \text{(By Lemma 80)} \end{aligned}$$

Finally, the properties for dimension 3 can be shown in the following way.

$$\begin{aligned} f_3(y - e_1 - e_2) < y_3 &\Rightarrow f_3(x) < x_3 && \text{(By Lemma 80)} \\ f_3(y + (w + 1) \cdot e_1 + (h + 1) \cdot e_2) \geq y_3 &\Rightarrow f_3(x + 2k \cdot e_1 + 2k \cdot e_2) \geq x_3 && \text{(By Lemma 80)} \end{aligned}$$

So, we have shown that the requirements imposed by a CB-config for the third dimensions are satisfied, but we must still prove that the requirements for dimensions 1 and 2 hold.

For dimension 1, note that we must either have $x \in \text{DC}_1(y + w \cdot e_1)$, which would imply $f_1(x) \geq x_1$ by Lemma 79, or we have $x + 2k \cdot e_1 + 2k \cdot e_2 \in \text{UC}_1(y + (w + 1) \cdot e_1)$, which would imply $f_1(x + 2k \cdot e_1 + 2k \cdot e_2) < x_1 + 2k$. So in either case the CB-config properties hold for dimension 1.

Symmetrically, for dimension 2 we either have $x \in \text{DC}_2(y + h \cdot e_2)$, which would imply $f_2(x) \geq x_2$ by Lemma 79, or we have $x + 2k \cdot e_1 + 2k \cdot e_2 \in \text{UC}_2(y + (h + 1) \cdot e_2)$, which would imply $f_2(x + 2k \cdot e_1 + 2k \cdot e_2) < x_2 + 2k$. So in either case the CB-config properties hold for dimension 2. \square

The following lemma states that if we find a CB-config, then all almost square critical boxes must fall inside a $7k \times 7k$ grid square that contains the CB-config.

Lemma 96. *Let $(x, 2k, 2k)$ with $x \in R$ be a CB-config, and let (y, h, w) be an almost square critical box with $h, w \leq k$. For each $i \in \{1, 2\}$ we have*

$$x_i - 3k \leq y_i \leq x_i + 4k.$$

Proof. Figure 32 shows the four possible CB-configs, and also shows the excluded regions for $\text{Up}(f)$ that arise from Lemmas 79 and 80. Since by Lemma 75 we have that critical boxes can only contain points from $\text{Up}(f)$, we know that no critical box can intersect the shaded regions. Note that in Case (a) of Figure 32, the non-shaded region is weakly larger than the non-shaded region in any other case, so we shall proceed assuming that we are in Case (a).

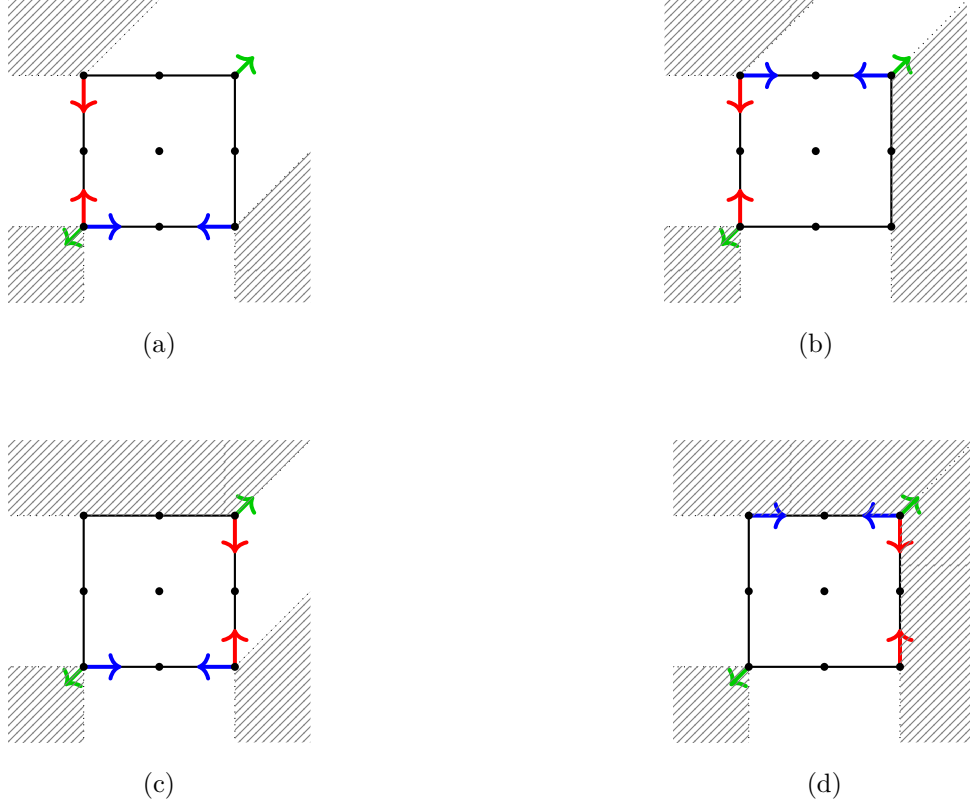

Figure 32: Excluded regions from up set search based on config square.

We start by proving that $y_1 \geq x_1 - 3k$ by assuming, for the sake of contradiction, that $y_1 < x_1 - 3k$. As shown in Figure 32, if $y_1 < x_1$, then to prevent (y, h, w) intersecting the shaded regions, we must have $y_2 \geq x_2$ and $h \leq 2k$. This then implies $w \leq 2k + 1$, since the critical box is almost square, and so

$$\begin{aligned} y_1 + w + 1 &< x_1 - 3k + w + 1 \\ &\leq x_1 + k + 2 \\ &\leq x_1 + 1, \end{aligned}$$

where we used the fact that $k \geq 1$. In particular, this means that $y_1 + w + 1 \leq x_1$. Since (y, h, w) is a critical box we have $f_1(y + (w + 1) \cdot e_1) < y_1 + w + 1$, and so Lemma 80 implies that $f_1(x) < x_1$, but this contradicts the fact that $(x, 2k, 2k)$ is a CB-config: in Cases (a) and (c) this is immediate, while in the other two we can apply Lemma 80 to the point $x + 2k \cdot e_2$ to argue that $f_1(x) \leq x_1$. The same proof can be applied symmetrically to argue that $y_2 \geq x_2 - 3k$.

Next we prove that $y_1 \leq x_1 + 4k$ by assuming, for the sake of contradiction, that $y_1 > x_1 + 4k$. Note that to avoid intersecting with $UC_1(x + 2k \cdot e_1)$ we must have $y_2 > 2k$. This means that $y - e_1 - e_2 \geq x + 2k \cdot e_1 + 2k \cdot e_2$. Since a CB-config insists that $f_3(x + 2k \cdot e_1 + 2k \cdot e_2) \leq x_3$, we can apply Lemma 80 to argue that $f_3(y - e_1 - e_2) \leq x_3$, which contradicts the fact that (y, h, w) is a critical box. The same proof can be applied symmetrically to argue that $y_2 \leq x_2 + 4k$. \square

With Lemmas 95 and 96 in hand, we can now specify Step 1 of the algorithm.

1. Query every point in R . This takes constantly many queries.
2. If there exists a point $x \in R \cap \text{Up}(f)$, then terminate.
3. Search for a CB-config in R . Since R contains constantly many points, this operation takes constant time.
4. If there is no CB-config in R , then the contrapositive of Lemma 95 implies that there are no almost square critical boxes in (x, h, w) , and so the algorithm invariant can be used to conclude that $\text{Up}(f) \cap s$ is empty. Hence the algorithm can correctly declare $\text{Up}(f) \cap s$ to be empty, and terminate.

5. Otherwise, let $(a, 2k, 2k)$ be the CB-config in R . Let $b = a - 3k \cdot e_1 - 3k \cdot e_2$ and observe that by Lemmas 96 and 81 we have that if $\text{Up}(f) \cap s$ is non-empty, then there exists an almost square critical box in the square $(b, 7k, 7k)$.

So Step 1 of the algorithm either terminates, or gives us the square $S = (b, 7k, 7k)$, which we will use to define a new, smaller, full state in Step 2.

Step 2. Defining the new full state. From Step 1, we are given the square S , and this square satisfies the algorithm invariant for the central box of a full state. The task now is to build a new full state t' that uses S as its central box.

If $\text{Up}(f)$ is non-empty, then there exists an almost square critical box b by Lemma 81, and as we have argued, this critical box must lie in S . Moreover, from Lemma 78 we know that $\text{Up}(f)$ is contained within b and its three lobes. Observe that since b is contained in S , we therefore have

$$\text{Up}(f) \subseteq S \cup \text{Left}(S) \cup \text{Bott}(S) \cup \text{Diag}(S).$$

So our intention is to define a new state using $\text{Left}(S)$ as the new left lobe, $\text{Bott}(S)$ as the new bottom lobe, and $\text{Diag}(S)$ as the new diagonal lobe.

However, we must deal with the existing lobes of t , which may not have been fully ruled out. Let (x^l, h^l, w^l) and (y^l, u^l, v^l) be the left lobe state associated with t . For $\text{Left}(S)$ we use the following procedure.

1. First compute the intersection I of $\text{Left}(S)$ with the central box of t .
2. If $(x^l, h^l, w^l) \cap \text{Left}(S) = \emptyset$, then all points in the left-lobe state are ruled out by Lemma 78, we can use I as the new left-lobe state, with an empty sub-lobe.
3. Otherwise, we remove all points in (x^l, h^l, w^l) that are not in $\text{Left}(S)$ giving a smaller box $(\bar{x}^l, \bar{h}^l, \bar{w}^l)$, and we then apply Steps 2 and 3 from the algorithm in Section 8.5 to I and $(\bar{x}^l, \bar{h}^l, \bar{w}^l)$. These steps spend constantly many queries, and return a single box I' while only removing points that are guaranteed to not lie in $\text{Up}(f)$.
4. We then remove all points in (y^l, u^l, v^l) that are not in $\text{Left}(S)$ giving a smaller box $(\bar{y}^l, \bar{u}^l, \bar{v}^l)$.
5. We then build the left-lobe state using I' as the main lobe, and $(\bar{y}^l, \bar{u}^l, \bar{v}^l)$ as the sub-lobe.

We can use the analogous approach to deal with $\text{Bott}(S)$. For $\text{Diag}(S)$ we also use the same approach, but here we use Steps 2 and 3 from Section 8.6.

So we can spend constantly many queries to build a new full state t' . The algorithm now terminates and returns t' .

Correctness. We have shown that t' satisfies the algorithm invariant whenever t satisfies that invariant. Specifically, we have shown the following.

- Step 1 has shown that the central box of t' contains an almost square critical box whenever the central box of t contains an almost square critical box.
- As argued in Step 2, if $\text{Up}(f)$ is non-empty, then $\text{Up}(f)$ is contained in S and its lobes. Step 2 may remove points from the lobes, but it only removes points that are provably not in $\text{Up}(f)$. So we have that $\text{Up}(f)$ is contained in t' .

To complete the proof, we must show that the area of t' has been sufficiently reduced.

We start by computing the amount of area that has been removed from the central box of t . Recall that we have divided this box into a 100×100 grid of squares of side-length k .

- Our new central box has side lengths of $7k$, so we have retained $49k^2$ area in the new central box.
- The new main lobe of the left-lobe state has height $7k$ and width at most $100k$, so its area is at most $700k^2$.
- Likewise, the new main lobe of the bottom-lobe state has width $7k$ and height at most $100k$, so its area is at most $700k^2$.

- The new main lobe of the diagonal-lobe state (x^d, y^d, l^d) has $x_2^d - y_2^d = 7k$, and $y_1^d - x_1^d = 7k$, and also $l \leq 100k$. So its area is at most $(107^2 - 100^2) \cdot k^2 = 1449k^2$.

So in total we have kept at most $2898k^2$ area from the central box, and its total area was $(100k)^2 = 10000k^2$. We must also remember that we increased the area of the central box by a factor of 1.03 at the start of the algorithm, so in total we have kept $(2898/10000) \cdot 1.03 < 0.5$ of the area of the central box, and so we have eliminated more than half of its area.

For the left, bottom, and diagonal states, observe that we have applied Step 3 to any area that was not already eliminated from these states, and so as we argued in Sections 8.5 and 8.6, we have removed at least $1/3$ of the area from these states.

Hence we have removed at least $1/3$ of the area from each component of t , so we have that $\text{Area}(t') \leq 2/3 \cdot \text{Area}(t)$. This completes the proof of Lemma 93.

8.8 Moving Between Slices

When we move to a new slice, we need to transpose the existing algorithm state into the new slice, and then reestablish the algorithm invariant. This section describes how this is achieved. All of the lemmas in this section show that we can produce a new invariant-satisfying state whose size *increases* by at most a constant. We will show in our running time analysis that this is not a problem, because we only increase the area in this way whenever we jump to a new slice, and we only jump to a new slice $\log n$ times in total.

Transposing a state to a new slice. When we move to a new slice, we translate the existing state along the principle diagonal vector $(1, 1, 1)$. The following lemma shows that if the original state contained the up-set in the old slice, then the translated state will contain the up-set in the new slice.

Lemma 97. *Let t' be a state in slice s' where j' is the fixed coordinate, and suppose that $\text{Up}(f) \cap s' \subseteq t'$. Let s be a slice where j is the fixed coordinate with $j > j'$. If we construct a new state t for s in which each box and diagonal box of t' is translated by the vector $(j - j') \cdot (1, 1, 1)$, then $\text{Up}(f) \cap s \subseteq t$.*

Proof. Let x be a point in $\text{Up}(f) \cap s$. Since $x \in \text{Up}(f)$ we have $x_i \leq f_i(x)$ for all indices i . Now we consider the point $y = x - (j - j') \cdot (1, 1, 1)$.

- If $y \in G$, then observe that $y \in \text{DC}_i(x)$ for all i , and therefore we can apply Lemma 79 to argue that y lies in $\text{Up}(f) \cap s'$. Therefore, if $\text{Up}(f) \cap s \not\subseteq t$, then we can use the property above to show that $\text{Up}(f) \cap s' \not\subseteq t'$, which would be a contradiction.
- If $y \notin G$ then let $z \in G$ be the point at which the vector between x and y leaves G . Note that we must have $z_3 > 1$, so Lemma 70 implies that $z \notin \text{Up}(f)$. But since $z \in \text{DC}_i(x)$ for all i , we can apply Lemma 79 to prove that x and z witness a violation of contraction, which contradicts the fact that f is violation-free.

□

For the rest of this section we will assume that we have moved to slice s , and we have produced the translated state t for this slice. Lemma 97 partially reestablishes the algorithm invariant for t , since it shows that if the state from the previous slice satisfied the invariant, then $\text{Up}(f) \cap s \subseteq t$. However, we still need to show that if $\text{Up}(f) \neq \emptyset$, then an almost square critical box exists in the correct boxes in t , and this requires further queries, which we will now describe.

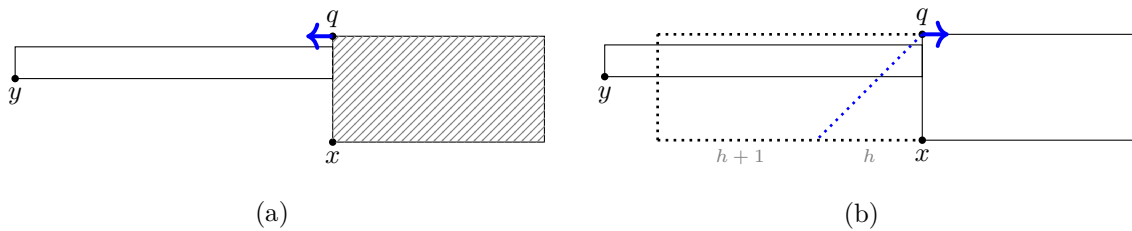

Figure 33: A depiction of the scheme for left lobe states.

Handling left-lobe states. Suppose that t is a left-lobe state, and let (x, h, w) be the main lobe of this state. We make a single query at point $q = x + h \cdot e_2$, as shown in Figure 33. There are then two cases to consider.

- **Case 1: $f_1(\mathbf{q}) < \mathbf{q}_1$.** (Figure 33 (a)). In this case we can apply Lemmas 79 and 80 to argue that every point p with $p_1 \geq q_1$ and $p_2 \leq q_2$ satisfies $f_1(p) < p_1$. So $p \notin \text{Up}(f)$, which means that we can use the sub-lobe of t as the main lobe of a new left lobe state that satisfies the invariant.
- **Case 2: $\mathbf{q}_1 \leq f_1(\mathbf{q})$.** (Figure 33 (b)). Here we can apply Lemma 79 to argue that every point $p = x - h \cdot e_1 + c \cdot e_2$ with $0 \leq c \leq h$ satisfies $p_1 \leq f_1(p)$. Note that any critical box can have height at most h , and so width at most $h + 1$. The definition of a critical box requires that there is a point that points downward in dimension 1 immediately to the right of the box, which means that no critical box (x', h', w') can exist with $x'_1 \leq x_1 - 2h - 1$. Therefore, we can define a new main lobe $l = (x - (2h + 1) \cdot e_1, h, w + 2h + 1)$, and the argument above implies that if an almost square critical box exists, then it must lie in l . If (y, u, v) denotes the sub-lobe of v , if y is not entirely contained within the new main lobe l , then we define a new sub-lobe $a = (y, u, v - 2h - 1)$, otherwise we set a to be an empty box. We then build a new left-lobe state t' using l and a .

Note that Case 1 does not increase the area of the state, but Case 2 does. Specifically, in case 2 the area is increased by a factor of $(w + h + 1 + h)/w$ and since $h \leq \lfloor \frac{w}{4} \rfloor$ we have $(w + h + 1 + h)/w < 2$. So we have proved the following lemma.

Lemma 98. *If t is a left-lobe state satisfying $\text{Up}(f) \subseteq t$, then we can make a single query and produce a new left-lobe state t' that satisfies the invariant such that $\text{Area}(t') \leq 2 \cdot \text{Area}(t)$.*

Handling bottom-lobe states. Bottom-lobe states can be handled in the same way as left-lobe states. Specifically, we can simply exchange dimensions 1 and 2, and then apply the algorithm given above. So we have the following lemma.

Lemma 99. *If t is a bottom-lobe state satisfying $\text{Up}(f) \subseteq t$, then we can make a single query and produce a new bottom-lobe state t' that satisfies the invariant such that $\text{Area}(t') \leq 2 \cdot \text{Area}(t)$.*

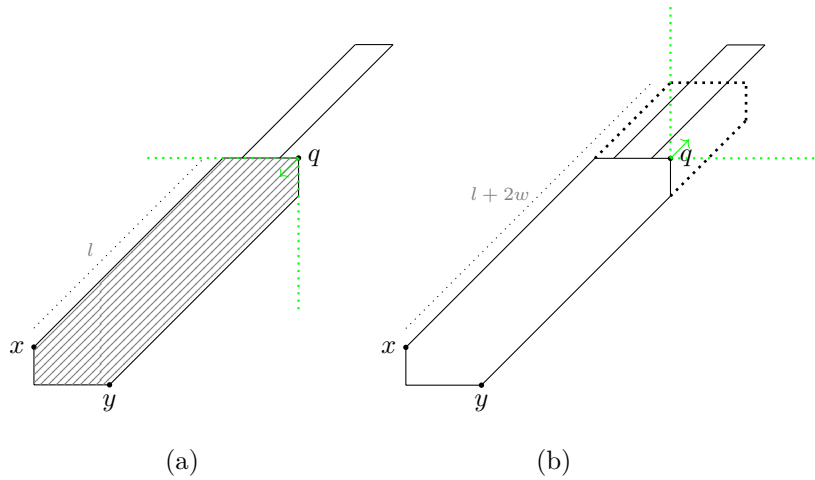

Figure 34: A depiction of the scheme for diagonal-lobe states.

Handling diagonal-lobe states. Suppose that t is a diagonal-lobe state, and let (x, y, l) be the main lobe of this state. We define the width of the main lobe as $w = (y_1 - x_1) + (x_2 - y_2)$, similar to the analysis used in Lemma 92. We make a single query at point $q = x + (l + (y_1 - x_1) \cdot e_1 + l \cdot e_2)$, as shown in Figure 34. We then consider the following two cases.

- **Case 1: $f_3(\mathbf{q}) < \mathbf{q}_3$.** (Figure 34 (a)). Applying Lemma 80, we observe that every point p with $p_1 \leq q_1$ and $p_2 \leq q_2$ satisfies $f_3(p) < p_3$. So $p \notin \text{Up}(f)$, which rules out the entire main lobe, and the sub-lobe of t is used as the main lobe of a new diagonal lobe state, satisfying the invariant.

- **Case 2: $f_3(\mathbf{q}) \geq \mathbf{q}_3$.** (Figure 34 (b)). By Lemma 80, we observe that every point p with $p_1 \geq q_1$ and $p_2 \geq q_2$ satisfies $f_3(p) \geq p_3$. Since any any critical box can have width at most w , an almost square critical box has height bounded by $w + 1$. By definition of a critical box, the diagonally adjacent point to the bottom left corner must be pointing downwards in dimension 3, which means that no critical box can have its bottom left corner below q . The above arguments imply that no critical box can lie further than $2w$ from point q .

The new main lobe is extended and defined as $(x, y, l + 2w)$, and, by the above reasoning, if an almost square critical box exists, it must lie in the new main lobe. If the sub-lobe denoted as (a, b, m) does not lie entirely within the new main lobe, we can define a new sub-lobe $(a + 2w \cdot e_1 + 2w \cdot e_2, a + 2w \cdot e_1 + 2w \cdot e_2, m - 2w)$, otherwise the new sub-lobe is an empty box. We then build a new left-lobe state t' using the new main and sub-lobes.

We observe that, in Case 1, the overall area is reduced, while Case 2 leads to an increase of the area of the main lobe.

Specifically, in case 2 the area is increased by a factor of $(l + 2w)/l$ and since $w \leq \lfloor \frac{l}{8} \rfloor$ we have $(l + 2w)/l < 2$. Our analysis proves the following lemma.

Lemma 100. *If t is a diagonal-lobe state satisfying $\text{Up}(f) \subseteq t$, then we can make a single query and produce a new diagonal-lobe state t' that satisfies the invariant such that $\text{Area}(t') \leq 2 \cdot \text{Area}(t)$.*

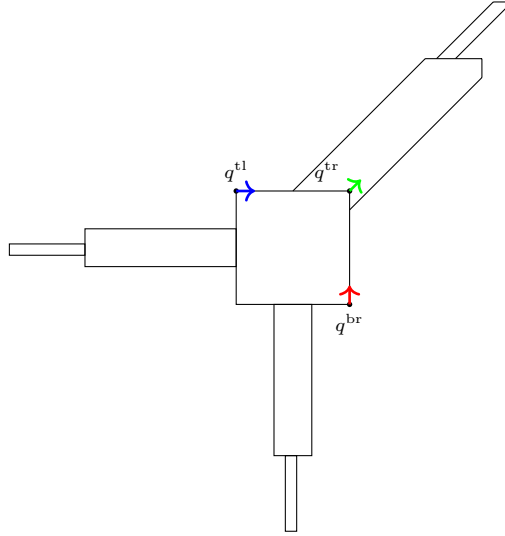

Figure 35: The shape of the regions that we consider.

Handling full states. Finally, we consider the case where t is a full state. Let (x, h, w) be the central box of t . We query the following three points.

$$\begin{aligned} q^{\text{br}} &= x + w \cdot e_1 \\ q^{\text{tl}} &= x + h \cdot e_2 \\ q^{\text{tr}} &= x + w \cdot e_1 + h \cdot e_2. \end{aligned}$$

These are the bottom-right, top-left, and top-right points of the central box, as depicted in Figure 35. We then perform the following case analysis.

- **Case 1: $f_1(\mathbf{q}^{\text{tl}}) < \mathbf{q}_1^{\text{tl}}$.** Using the same argument as we used for Case 1 of handling a left-lobe state, we can conclude that all points $x \in \text{Up}(f)$ satisfy $x_1 < q_1^{\text{tl}}$, which rules out everything except the left-lobe state of t . So we can proceed using Lemma 98 on the left-lobe of t to produce a new left-lobe state that satisfies the invariant.
- **Case 2: $f_2(\mathbf{q}^{\text{br}}) < \mathbf{q}_2^{\text{br}}$.** Likewise we can use the same argument as we used for Case 1 of handling a bottom-lobe state, so we can proceed using Lemma 99 on the bottom-lobe of t to produce a new bottom-lobe state that satisfies the invariant.

- **Case 3:** $\mathbf{f}_3(\mathbf{q}^{\text{tr}}) < \mathbf{q}_3^{\text{tr}}$. Here we use the argument for Case 1 of handling a diagonal-lobe state, which states that any point with $x_1 \leq q_1^{\text{tr}}$ and $x_2 \leq q_2^{\text{tr}}$ has $x \notin \text{Up}(f)$. Applying Lemma 100 on the diagonal-lobe of t , we can produce a new diagonal lobe state satisfying the invariant.
- **Case 4.** If none of the previous cases apply then we have $\mathbf{f}_1(\mathbf{q}^{\text{tl}}) \geq \mathbf{q}_1^{\text{tl}}$, and $\mathbf{f}_2(\mathbf{q}^{\text{br}}) \geq \mathbf{q}_2^{\text{br}}$, and $\mathbf{f}_3(\mathbf{q}^{\text{tr}}) \geq \mathbf{q}_3^{\text{tr}}$, which is the situation shown in Figure 35. Here we note the following properties.
 - Since $f_1(q^{\text{tl}}) \geq q_1^{\text{tl}}$, we can use the same argument as we used in Case 2 of handling a left-lobe state to argue that any almost square critical box (x', h', w') must satisfy $x'_1 \geq x_1 - 2h - 1$.
 - Since $f_2(q^{\text{br}}) \geq q_2^{\text{br}}$ we can use the same argument as we used in Case 2 of handling a bottom-lobe state to argue that any almost square critical box (x', h', w') must satisfy $x'_2 \geq x_2 - 2w - 1$.
 - Since $f_3(q^{\text{tr}}) \geq q_3^{\text{tr}}$ we can use the same argument as we used in Case 2 of handling a diagonal-lobe state to argue that any almost square critical box (x', h', w') must satisfy $x'_1 \leq x_1$ or $x'_2 \leq x_2$, and also $h' \leq 2w$ and $w' \leq 2h$.

So we can define an expanded central box $b = (x - (2h + 1), 2w + 1, 5h + 1, 5w + 1)$, and the arguments above imply that all almost square critical boxes must lie in b . We then consider the left, bottom, and diagonal states in t . If they have been entirely subsumed by b then we replace them with an empty state. Otherwise we shorten them so that they meet b , rather than the original central box.

We then build a new full state t' from b and the new left, bottom, and diagonal states. Since t' contains a superset of the points in t , the algorithm invariant holds for t' . Moreover, the area of the central box of t' is at most 36 times the area of the central box of t , while the other states contained in t' have not increased in area. So we have $\text{Area}(t') \leq 36 \cdot \text{Area}(t)$.

Hence we have shown the following lemma.

Lemma 101. *If t is a full state satisfying $\text{Up}(f) \subseteq t$, then we can make constantly many queries to f and produce a new state t' that satisfies the invariant such that $\text{Area}(t') \leq 36 \cdot \text{Area}(t)$. Moreover each step of the algorithm runs in time that is polynomial in the representation of f .*

8.9 The Main Algorithm

In this section we now piece together all of the properties that we have shown so far into a single algorithm.

The corresponding down-set definitions and algorithms. In Sections 8.2 through 8.8 we presented our definitions and algorithms for the up-set. Everything that we presented in those sections can also be applied to the down-set by simply flipping all dimensions. So for example, a down-set critical box (x, h, w) has $x \in \text{Down}(f)$, and x is the top-right corner of the box, while all other conditions are likewise flipped. A down-set critical box has a right lobe, a top lobe, and a down-left diagonal lobe.

The algorithms can likewise be adapted by flipping all dimensions. The algorithm invariant now insists that the state must contain $\text{Down}(f) \cap s$, and that every almost square down-set critical box is contained in the central box or main lobe of the state. The algorithms take a down-set state and make constantly many queries before either finding a point in $\text{Down}(f)$, declaring that $\text{Down}(f) \cap s$ is empty in the slice s , or finding a new states whose area has been reduced by a constant fraction.

The algorithm. The algorithm performs a binary search on the third dimension of the instance. Each step of the binary search considers a slice in which the third dimension is fixed. The goal of this binary search is to find a slice s that contains a point in $\text{Up}(f)$ and a point in $\text{Down}(f)$, which is guaranteed to exist since any fixed point lies in $\text{Up}(f) \cap \text{Down}(f)$. Once we have found such a slice, we then move to the terminal phase of the algorithm, which finds a fixed point in s .

Given an integer i , let s_i be the slice that contains all points x with $x_3 = i$. The algorithm maintains two integers l and u with the invariant that $\text{Up}(f) \cap s_l \neq \emptyset$ and $\text{Down}(f) \cap s_u \neq \emptyset$. Initially we set $l = 1$ and $u = n$, so this invariant is satisfied because $(1, 1, 1) \in \text{Up}(f)$ and $(n, n, n) \in \text{Down}(f)$ both hold trivially.

The algorithm also maintains a *current slice* defined by an index i , where initially we set $i = \lfloor \frac{u-l}{2} \rfloor$. For each slice s_i visited, the algorithm maintains an up-set state t_{up}^i and a down-set state t_{dn}^i , with the property that t_{up}^i satisfies the up-set invariant for s_i , and t_{dn}^i satisfies the down-set invariant for s_i . Initially we set t_{up}^i to be a full state with the central box $((1, 1), n, n)$ and all other states being empty. Observe that this trivially satisfies the up-set algorithm invariant for slice s_i . The state t_{dn}^i is likewise

initially set to a full state with central box $((n, n), n, n)$ with all other states being empty, which also trivially satisfies the down-set algorithm invariant for slice s_i .

The main algorithm then proceeds as follows.

1. The algorithm performs a single step on t_{up}^i by applying one of Lemmas 90, 91, 92, or 93, depending on the type of t_{up}^i . If t_{up}^i contains constantly many points, we instead just search these points to determine if there exists a point in $\text{Up}(f) \cap s_i$ or not.
2. The algorithm performs a single step on t_{dn}^i by applying one of the flipped analogues of Lemmas 90, 91, 92, or 93, depending on the type of t_{dn}^i . If t_{dn}^i contains constantly many points, we instead just search these points to determine if there exists a point in $\text{Down}(f) \cap s_i$ or not.
3. If both Step 1 and Step 2 produce a new state t'_{up} and t'_{dn} , respectively, then we set $t_{\text{up}}^i = t'_{\text{up}}$ and $t_{\text{dn}}^i = t'_{\text{dn}}$. We then go back to Step 1 and repeat.
4. If Step 1 finds a point $x \in \text{Up}(f) \cap s_i$ or if Step 2 declares $\text{Down}(f) \cap s_i = \emptyset$, then we set $l = i$. Likewise, if Step 2 finds a point $y \in \text{Down}(f) \cap s_i$ or if Step 1 declares $\text{Up}(f) \cap s_i = \emptyset$, then we set $u = i$. Note that this covers all possible return values from the two algorithms.
5. If $u - l = 1$ then the main algorithm terminates, and we move to the two-slice sub-algorithm, which will be described later.
6. Otherwise we set $i = \lfloor \frac{u-l}{2} \rfloor$, and carry out the following steps.
 - Let t_{up} be the result of taking the state t_{up}^i , translating every box and diagonal box by $(i - l) \cdot (1, 1, 1)$, and then applying the appropriate algorithm from Lemmas 98, 99, 100, and 101. Note that Lemma 97 implies that t_{up} satisfies the algorithm invariant for s_i , so we can set $t_{\text{up}}^i = t_{\text{up}}$.
 - Let t_{dn} be the result of taking the state t_{dn}^i , translating every box and diagonal box by $(i - u) \cdot (1, 1, 1)$, and then applying the appropriate algorithm from the flipped analogues of Lemmas 98, 99, 100, and 101. Note that the flipped analogue of Lemma 97 implies that t_{dn} satisfies the algorithm invariant for s_i , so we can set $t_{\text{dn}}^i = t_{\text{dn}}$.
 - We then move back to Step 1 and continue in the new slice i .

Correctness of the main algorithm. We have already argued that each state visited by the algorithm satisfies the appropriate algorithm invariant. We still need to show the invariant that $\text{Up}(f) \cap s_l \neq \emptyset$ and $\text{Down}(f) \cap s_u \neq \emptyset$, where we must inspect the decisions made in Step 4 of the algorithm, which is the only step that modifies l and u . Here if the up-set algorithm found a point $x \in \text{Up}(f) \cap s_i$, or if the down-set algorithm found point $y \in \text{Down}(f) \cap s_i$, then the invariant is trivially satisfied. For the other two cases, we rely on the following lemma.

Lemma 102. *For every slice s_i , we have either $\text{Up}(f) \cap s_i \neq \emptyset$ or $\text{Down}(f) \cap s_i \neq \emptyset$.*

Proof. Consider the function $f' : \{1, 2, \dots, n\}^2 \rightarrow \{1, 2, \dots, n\}^2$ defined so that $f'_j(x) = f(x \oplus i)$ for $j \in \{1, 2\}$, where $x \oplus i$ places i in the third dimension of x . The function f' is monotone, and so possesses a fixed point p' by Tarski's theorem. If we let $p = p' \oplus i$, then since p is fixed in dimensions 1 and 2, if $p_3 \leq f_3(p)$ then $p \in \text{Up}(f)$, while if $p_3 \geq f_3(p)$ then $p \in \text{Down}(f)$. \square

Hence, when Step 4 sets $l = i$ because the down-set algorithm declared that $\text{Down}(f) \cap s_i = \emptyset$ Lemma 102 tells us that $\text{Up}(f) \cap s_i \neq \emptyset$, so the invariant is maintained. The case where Step 4 sets $u = i$ can be shown to be correct using the same argument.

The running time of the main algorithm. Each step of the algorithm reduces the size of the state by a constant fraction except in the following two scenarios.

1. When a diagonal-lobe state is turned into a full state in the last case of Lemma 92, where the area of the state is increased by a factor of 5.
2. When we transition to a new slice, where the area is increased by a factor of at most 36.

However, note that the first case can occur at most once per slice, because once we have arrived at a full state Lemma 93 ensures that all further states that are considered in this slice are also full states. Meanwhile, the second case also occurs at most once per slice, since it only occurs when we transition to a new slice. So for each slice that we visit, we may blow-up the area of the state by a factor of 180.

On the other hand, each other step reduces the area of the state by a factor of at least $15/16$. It can be verified that $(15/16)^{81} \cdot 180 < 1$, so we can cancel out the increase from each slice by taking 81 further steps. Furthermore, we visit exactly $\log n$ different slices in our binary search, so we pay $81 \cdot \log n$ steps in order to cancel out these increases.

Then, after $O(\log n)$ further steps the number of points contained in the state must be a constant, after which the algorithm terminates after at most $O(\log n)$ further steps to complete the binary search. So in total we have that the main-algorithm terminates after making $O(\log n)$ queries to f . Moreover, every step of the algorithm runs in time that is polynomial in the representation of f .

8.10 The Two-Slice Sub-Algorithm

When we reach the two-slice sub-algorithm, we have that $u - l = 1$. The following lemma shows that the main algorithm invariant ensures that either s_u contains a fixed point, or s_l contains a fixed point.

Lemma 103. *Let u, l be slice indices satisfying $u = l$ or $u = l + 1$. If $\text{Up}(f) \cap s_l \neq \emptyset$ and $\text{Down}(f) \cap s_u \neq \emptyset$ then there exists a fixed point in s_u or s_l .*

Proof. Let $x \in \text{Up}(f) \cap s_l$ whose existence is assumed by the lemma. By Tarski's theorem we know that the greatest fixed point g satisfies $g \geq x$. If $g \in s_u$ or $g \in s_l$ then we are done, so we proceed assuming that $g_3 > u$.

Symmetrically, let $y \in \text{Down}(f) \cap s_u$ whose existence is assumed by the lemma. By Tarski's theorem we know that the least fixed point p satisfies $p \leq y$. If $p \in s_u$ or $p \in s_l$ then we are done, so we proceed assuming that $p_3 < l$.

By Corollary 18 there exists a path of fixed points from p to g where each step of the path moves by distance at most 1 in the ℓ_∞ -norm. Since p and g lie on either side of s_l and s_u , the path must pass through both slices, and so in this case there exists a fixed point in both s_l and s_u . \square

This means that there exists an index $i \in \{u, l\}$ such that $\text{Up}(f) \cap s_i \neq \emptyset$ and $\text{Down}(f) \cap s_i \neq \emptyset$. The goal of the sub-algorithm is to find this slice.

The main algorithm invariant ensures that $\text{Up}(f) \cap s_l \neq \emptyset$ and that $\text{Down}(f) \cap s_u \neq \emptyset$. The sub-algorithm simply keeps refining the down-set state in the slice s_l until it either finds a down-set point, which means that s_l is the slice that we are looking for, or declares that s_l does not contain any down-set points, which then allows us to invoke Lemma 103 to conclude that s_u is the slice that we are looking for.

Formally, the sub-algorithm proceeds as follows.

1. Compute t_{dn}^l by taking t_{dn}^u from the main algorithm, translating every box and diagonal box by $(-1, -1, -1)$, and then applying the appropriate algorithm from the flipped analogues of Lemmas 98, 99, 100, and 101. If at any point the state t contains a constant number of points, then we simply search those points to determine if there is a point in $\text{Up}(f) \cap s_l$.
2. Repeatedly apply the flipped analogues of Lemmas 90, 91, 92, or 93, to t_{dn}^l in slice s_l until an algorithm either finds a point $x \in \text{Down}(f) \cap s_l$ or declares $\text{Down}(f) \cap s_l = \emptyset$. If at any point the state t contains a constant number of points, then we simply search those points to determine if there is a point in $\text{Down}(f) \cap s_l$.
3. If the point x is found in Step 2, then we have that $\text{Up}(f) \cap s_l \neq \emptyset$ and $\text{Down}(f) \cap s_l \neq \emptyset$, so the sub-algorithm can terminate returning l .
4. Otherwise, Lemma 103 ensures that $\text{Up}(f) \cap s_u \neq \emptyset$ and $\text{Down}(f) \cap s_u \neq \emptyset$, so the sub-algorithm can terminate returning u .

Running time of the sub-algorithm. We can re-use the analysis of the main algorithm to show that the two-slice sub-algorithm terminates after $O(\log n)$ steps. In particular, since we only consider two different slices, we blow-up the area by a factor of 180 at most twice, and so we spend at most 162 steps cancelling out that increase. Then after $O(\log n)$ further steps both states must contain constantly many points, and so the algorithm will terminate. Moreover, every step of the algorithm runs in time that is polynomial in the representation of f .

8.11 The Terminal Phase

In the terminal phase of the algorithm we have a slice s_i such that $\text{Up}(f) \cap s_i \neq \emptyset$ and $\text{Down}(f) \cap s_i \neq \emptyset$. Lemma 103 tells us that there is a fixed point in s_i , and the goal of the terminal phase is to find this fixed point in $\log(n)$ steps.

Paths of two-dimensional fixed points. We start by considering the two-dimensional fixed points of the slice s_i , where a point x is a two-dimensional fixed point if $x_1 = f_1(x)$ and $x_2 = f_2(x)$. Recall that Corollary 18 implies that, if x is a two-dimensional fixed point that is not the least two-dimensional fixed point, then we can find a point $x' \leq x$ with $\|x - x'\|_\infty = 1$ such that x' is also a two-dimensional fixed point. We can use this fact to prove the following lemma, which states that we can build a path of two-dimensional fixed points from x to the least two-dimensional fixed point of the slice, and also a second path from x to the greatest two-dimensional fixed point of the slice.

Lemma 104. *Let x be a two-dimensional fixed point of a slice s , and let p and q be the least and greatest two-dimensional fixed points of s , respectively.*

- *There exists a path of two-dimensional fixed points $p = v^1, v^2, \dots, v^k = x$ with $v^i \leq v^{i+1}$ and $\|v^i - v^{i+1}\|_\infty = 1$ for all i .*
- *There exists a path of two-dimensional fixed points $x = u^1, u^2, \dots, u^k = q$ with $u^i \leq u^{i+1}$ and $\|u^i - u^{i+1}\|_\infty = 1$ for all i .*

Proof. The path from p to x can be obtained by repeatedly applying Corollary 18 starting at x . Each application of the corollary to a point v^{i+1} gives us a new two-dimensional fixed point v^i with $v^i \leq v^{i+1}$ and $\|v^i - v^{i+1}\|_\infty = 1$, and we can keep applying the corollary until we reach p .

The path from x to q can be likewise generated using Corollary 18, but here we must first flip dimensions 1 and 2 before proceeding. In the flipped instance we start at x , and then each application of the corollary to a point v^i gives us a new two-dimensional fixed point v^{i+1} with $v^i \geq v^{i+1}$ and $\|v^i - v^{i+1}\|_\infty = 1$ in the flipped instance, which means that $v^i \leq v^{i+1}$ and $\|v^i - v^{i+1}\|_\infty = 1$ in the original instance. We can keep applying the corollary until we reach q , which is the least two-dimensional fixed point in the flipped instance. \square

The next lemma states that if the slice contains a global fixed point (that is, a point that is fixed in all three dimensions), then the least and greatest fixed points must obey certain inequalities in the third dimension.

Lemma 105. *Let s be a two-dimensional slice, and let p and q be the least and greatest two-dimensional fixed points of s , respectively. If s contains a global fixed point, then we have $p_3 \geq f_3(p)$ and $q_3 \leq f_3(q)$.*

Proof. Note that every global fixed point in s is also a two-dimensional fixed point of s . So if we had $p_3 < f_3(p)$ then Lemma 80 would imply that every two-dimensional fixed point v of s satisfies $v_3 < f_3(v)$, contradicting the fact that s contains a global fixed point. Likewise, if we had $q_3 > f_3(q)$ then Lemma 80 would imply that every two-dimensional fixed point v of s satisfies $v_3 > f_3(v)$, again contradicting the fact that s contains a global fixed point. \square

Finally we prove the following lemma, which states that if we walk along any path of two-dimensional fixed points like those whose existence is asserted in Lemma 104, and if the end points of the path satisfy conditions like those proven in Lemma 105, then the path must visit a global fixed point.

Lemma 106. *Let v^1, v^2, \dots, v^k be a path of two-dimensional fixed points satisfying $\|v^i - v^{i+1}\|_\infty = 1$ for all i . If $v_3^1 \geq f_3(v^1)$ and $v_3^k \leq f_3(v^k)$, then there exists an i such that v^i is a global fixed point.*

Proof. First note that if $v_3^1 = f_3(v^1)$ or $v_3^k = f_3(v^k)$ then one of v^1 or v^k is a global fixed point and we are done. So we can assume that $v_3^1 > f_3(v^1)$ and $v_3^k < f_3(v^k)$.

Since $v_3^1 - f_3(v^1) > 0$ and $v_3^k - f_3(v^k) < 0$ there must be some edge in the path at which $v_3^i - f_3(v^i)$ changes sign. Note that there cannot be two points a and b with $\|a - b\|_\infty = 1$ with $a_3 > f_3(a)$ and $b_3 < f_3(b)$ since this would imply $\|f(a) - f(b)\|_\infty > \|a - b\|_\infty$, giving us an immediate violation of strict contraction. Hence there must exist some point v^i such that $v_3^i = f_3(v^i)$. Since v^i is a two-dimensional fixed point, we therefore have that v^i is a global fixed point. \square

Lemma 106 implies that for every global fixed point x , there exists a path from the least two-dimensional fixed point of the slice to the greatest two-dimensional fixed point of the slice that passes through x . We will use this fact crucially in our algorithm.

Spaces ruled out by a single query. Our algorithm will maintain a region R with the invariant that R contains a global fixed point. It will then make queries in order to reduce the size of R . The following lemma shows that each query we make will rule out a half-space of points.

Lemma 107. *Let $R \subseteq s_i$ be a region that contains a global fixed point, and suppose that we query point $q \in R$ that is not a global fixed point. There exists a half-space of one of the following forms such that, when we remove the half-space from R creating R' , we have that R' contains a global fixed point.*

- A vertical half-space ruling out all points p with either $p_1 \leq q_1$, $p_1 \geq q_1$, $p_1 \leq q_1 - 1$, or $p_1 \geq q_1 + 1$.
- A horizontal half-space ruling out all points p with either $p_2 \leq q_2$, $p_2 \geq q_2$, $p_2 \leq q_2 - 1$, $p_2 \geq q_2 + 1$.
- An upper-left diagonal half-space ruling out all points p with $p_2 - q_2 \geq p_1 - q_1$.
- A lower-right diagonal half-space ruling out all points p with $p_2 - q_2 \leq p_1 - q_1$.

Proof. To prove this lemma, we enumerate the possible responses to the query at q , and in each case we show that a half-space can be ruled out. We begin with the responses in which f moves strictly in dimensions 1 and 2. In each case we apply Lemmas 79 and 80 to find a region of points that must move strictly in either dimension 1 or 2, which allows us to conclude that no point in those regions is a global fixed point. Hence, since R contains a global fixed point, it must lie outside the half-space, so we can safely remove all points in the half-space.

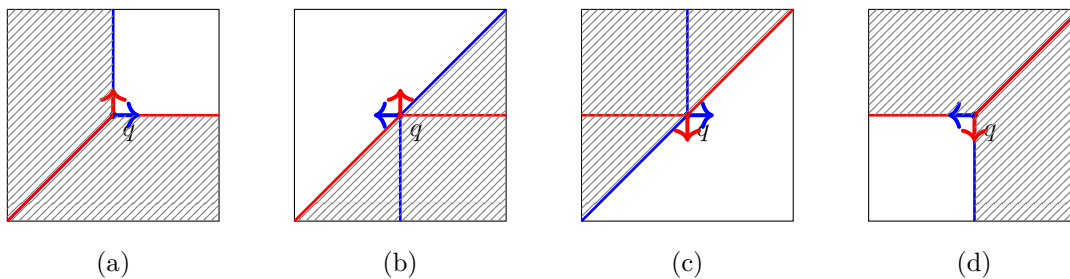

Figure 36: Cases 1 through 4 of the proof of Lemma 68.

- **Case 1: $q_1 < f_1(q)$ and $q_2 < f_2(q)$.** (Figure 36 (a)). The figure shows the two excluded regions implied by Lemmas 79 and 80. As we can see, in this case we can rule out the vertical half-space defined by p with $p_1 \leq q_1$ and also the horizontal half-space defined by p with $p_2 \leq q_2$.
- **Case 2: $q_1 > f_1(q)$ and $q_2 < f_2(q)$.** (Figure 36 (b)). The figure shows the two excluded regions implied by Lemmas 79 and 80. As we can see, in this case we can rule out the lower-right diagonal half-space defined by p with $p_2 - q_2 \leq p_1 - q_1$.
- **Case 3: $q_1 < f_1(q)$ and $q_2 > f_2(q)$.** (Figure 36 (c)). The figure shows the two excluded regions implied by Lemmas 79 and 80. As we can see, in this case we can rule out the upper-left diagonal half-space defined by p with $p_2 - q_2 \geq p_1 - q_1$.
- **Case 4: $q_1 < f_1(q)$ and $q_2 < f_2(q)$.** (Figure 36 (d)). The figure shows the two excluded regions implied by Lemmas 79 and 80. As we can see, in this case we can rule out the horizontal half-space defined by p with $p_2 \geq q_2$ and the vertical half-space defined by p with $p_1 \geq q_1$.

Now we consider the cases in which $f_1(q)$ moves strictly upward, while $f_2(q) = q_2$. Here we rely on the third dimension to give us our half-space. As before, in each case we apply Lemmas 79 and 80 to find a region of points that must move strictly in either dimension 1 or 3, which allows us to conclude that no point in those regions is a fixed point, so the regions can be safely removed from R .

- **Case 5: $q_1 < f_1(q)$ and $q_3 < f_3(q)$.** (Figure 37 (a)). The figure shows the two excluded regions implied by Lemmas 79 and 80. As we can see, in this case we can rule out the horizontal half-space defined by p with $p_2 \geq q_2$.
- **Case 6: $q_1 < f_1(q)$ and $q_3 > f_3(q)$.** (Figure 37 (b)). The figure shows the two excluded regions implied by Lemmas 79 and 80. As we can see, in this case we can rule out the vertical half-space defined by p with $p_1 \leq q_1$.

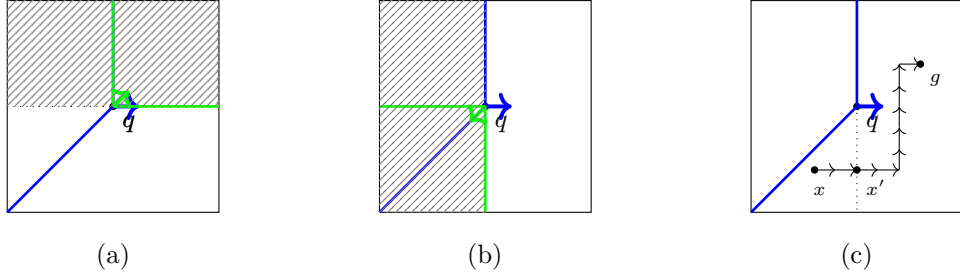

Figure 37: Cases 5 through 7 of the proof of Lemma 68.

- **Case 7: $q_1 < f_1(q)$ and $q_2 = f_2(q)$ and $q_3 = f_3(q)$.** (Figure 37 (c)). The figure shows the two excluded regions implied by Lemmas 79 and 80. Here a half-space is not immediately ruled out, so a more involved proof is required. We show that we can rule out the half-space defined by points p with $p_1 \leq q_1 - 1$. We do this by considering the location of the global fixed point $x \in R$, whose existence the lemma assumes. If $x_1 \geq q_1$ then we are done.

So let us suppose that $x_1 < q_1$. We will show that there exists another global fixed point x' satisfying $x'_1 \geq q_1$. First we apply Lemma 104 to obtain the path $x = p^1, p^2, \dots, p^k = g$ from x to the greatest two-dimensional fixed point g of the slice, and we observe that the path cannot pass through the blue region in Figure 37 (c), which was obtained by applying Lemmas 79 and 80, because all points in that region move strictly upward in dimension 1, and all points on the path are two-dimensional fixed points.

Moreover, we note that q is in the two-dimensional up-set of the slice, and so by Tarski's theorem we have $q \leq g$. As shown (Figure 37 (c)), the only way to move from x to g while monotonically increasing in every step and avoiding the already excluded region is to pass through some point x' with $x'_1 = q_1$ and $x'_2 \leq q_2$.

Note that we cannot have $x'_3 > f_3(x')$, since then Lemma 80 would imply that $x_3 > f_3(x)$ which would imply that x is not a global fixed point. We also cannot have $x'_3 < f_3(x')$, because then Lemma 80 would imply that $q_3 < f_3(q)$, which contradicts the assumptions made in this case. Hence we must have $x'_3 = f_3(x')$, and so x' is a global fixed point satisfying $x'_1 \geq q_1$, as required.

The case where $f_1(q)$ moves strictly downward can be dealt with symmetrically.

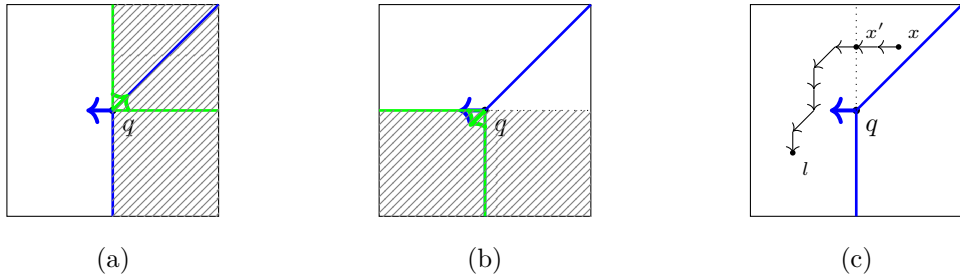

Figure 38: Cases 8 through 10 of the proof of Lemma 68.

- **Case 8: $q_1 > f_1(q)$ and $q_3 < f_3(q)$.** (Figure 38 (a)). The figure shows the two excluded regions implied by Lemmas 79 and 80. As we can see, in this case we can rule out the vertical half-space defined by p with $p_1 \geq q_1$.
- **Case 9: $q_1 > f_1(q)$ and $q_3 > f_3(q)$.** (Figure 38 (b)). The figure shows the two excluded regions implied by Lemmas 79 and 80. As we can see, in this case we can rule out the horizontal half-space defined by p with $p_2 \leq q_2$.
- **Case 10: $q_1 > f_1(q)$ and $q_2 = f_2(q)$ and $q_3 = f_3(q)$.** (Figure 38 (c)). The figure shows the two excluded regions implied by Lemmas 79 and 80. Here we can follow the flipped analogue of Case 7 to rule out the vertical half-space defined by p with $p_1 \geq q_1 + 1$.

Specifically, if the global fixed point x satisfies $x_1 \leq q_1$ then we are done. Otherwise, as in Case 7 we can build a path of two-dimensional fixed points from x to the least fixed point l . Since q is in

the two-dimensional down-set, this path must pass through a point x' with $x'_1 = q_1$ and $x'_2 \geq q_2$. Using Lemma 80, we have that if $x'_3 > f_3(x')$ then this contradicts the fact that x is a global fixed point, while if $x'_3 < f_3(x')$ then this contradicts the fact that $q_3 = f_3(q)$. So must have $x'_3 = f_3(x')$, meaning that x' is a global fixed point satisfying $x'_1 \leq q_1$.

The cases where $f_2(q)$ moves strictly upwards or strictly downwards, while $f_1(q)$ is fixed can be dealt with by exchanging dimensions 1 and 2, and then applying one of Cases 5 through 10.

This leaves us with the cases in which both $f_1(q)$ and $f_2(q)$ are fixed. Since q is not a global fixed point, we can use one of the following cases.

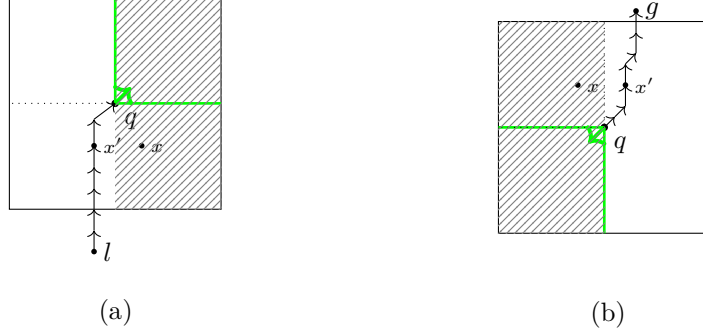

Figure 39: Cases 11 and 12 of the proof of Lemma 68.

- **Case 11: $q_1 = f_1(q)$ and $q_2 = f_2(q)$ and $q_3 < f_3(q)$.** (Figure 39 (a)). Here we argue that we can rule out the vertical⁹ half-space defined by p with $p_1 \geq q_1 + 1$.

Let x be the global fixed point that lies in R . If $x_1 \leq q_1$ then we are done. Note also that we cannot have $x \geq q$, since then Lemma 80 would imply that $x_3 < f_3(x)$, contradicting the fact that x is a global fixed point.

So the only remaining case is when $x_1 > q_1$ and $x_2 < q_2$, as depicted in (Figure 39 (a)). We apply Lemma 104 to obtain a path $l = p^1, p^2, \dots, p^k = q$ from the least two-dimensional fixed point of the slice l to q . Note that we must have $l \leq x$, because l is a least two-dimensional fixed point, so there must exist an index i such that $p_2^i = x_2$. Note also that $p_1^i \leq q_1 < x_1$. So we have $p^i \leq x$.

If $p_3^i = f_3(p^i)$ then p_3^i is a global fixed point satisfying $p_1^i \leq q_1$ and we are done. If $p_3^i < f_3(p^i)$ then Lemma 80 would imply that $x_3 < f_3(x)$, contradicting the fact that x is a global fixed point. So the only remaining case is when $p_3^i > f_3(p^i)$, where we can apply Lemma 106 to argue that there exists a global fixed point p^j with $p^i \leq p^j \leq q$, which in particular means $p_1^j \leq q_1$.

- **Case 12: $q_1 = f_1(q)$ and $q_2 = f_2(q)$ and $q_3 > f_3(q)$.** (Figure 39 (b)). This case is the symmetric analogue of Case 11, and so we can follow the same approach to rule out the half-space defined by p with $p_1 \leq q_1 - 1$. We only note the differences between Case 11 and Case 12 below.

In this case, if the global fixed point x satisfies $x_1 \leq q_1$, then we first note that we must have $x_2 > q_2$, since the case where $x_2 \leq q_2$ is ruled out by Lemma 80, and then we use Lemma 104 to obtain a path $g = p^1, p^2, \dots, p^k = g$ from q to the greatest two-dimensional fixed point of the slice g . Since $g \geq x$, there exists an index i such that $p_2^i = x_2$, and we have $x \leq p_2^i$.

If $p_3^i = f_3(p^i)$ then p_3^i is a global fixed point satisfying $p_1^i \geq q_1$. If $p_3^i > f_3(p^i)$ then Lemma 80 would imply that $x_3 > f_3(x)$, contradicting the fact that x is a global fixed point. Finally, if $p_3^i < f_3(p^i)$, then we can apply Lemma 106 to find a global fixed point p^j with $p^i \geq p^j \geq q$, which in particular means $p_1^j \geq q_1$.

□

The algorithm. As mentioned, the algorithm maintains a region R with the invariant that R contains a global fixed point. Initially we set R to be a square that contains the entire slice, which satisfies the

⁹We could also rule out the horizontal half-space defined by p with $p_2 \geq q_2 + 1$ by exchanging dimensions 1 and 2 and using the same argument, if we so desired.

invariant due to Lemma 103. Then, in each iteration of the algorithm we make a number of queries, and then for each query we eliminate the corresponding half-space from Lemma 107.

We start with a box shaped region that contains the entire slice. Each query eliminates a vertical, horizontal, upper-left diagonal, or lower-right diagonal half-space, which may again give us a box, or a box with a diagonal half-space removed.

We say that a region R is *valid* if it is defined by a box with at most one upper-left half-space removed, and at most one lower-right half-space removed. Note that if we query a valid region R , and then remove the half-space given to us from Lemma 107 to get a reduced region R' , then R' is also valid.

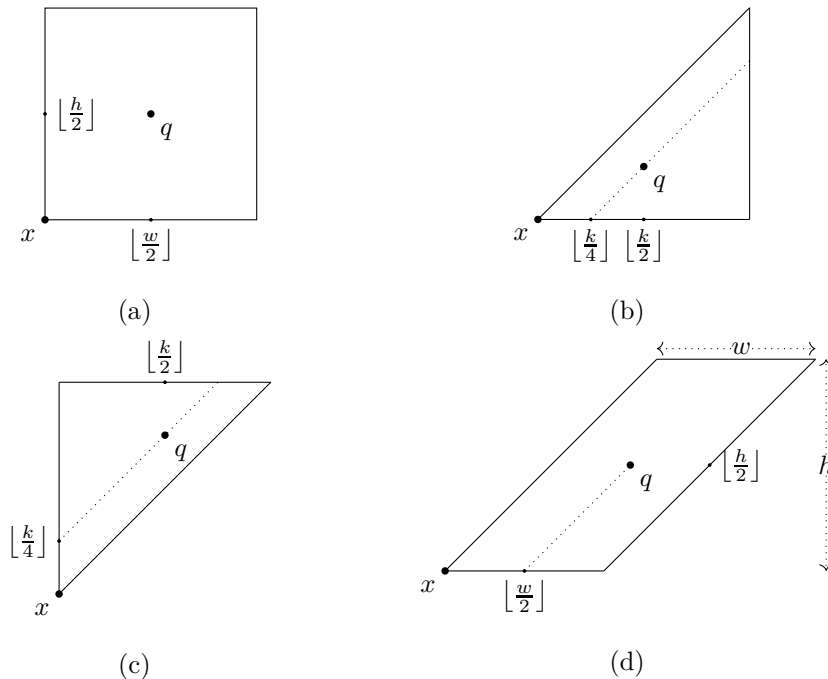

Figure 40: The four basic shapes considered.

To aid our analysis, we further decompose each valid region into four categories of *basic shapes*. Specifically we consider spaces that are either box shaped, a *lower right-angle triangle* with width and height k as shown in Figure 40 (b), a *upper right-angle triangle* with width and height k as shown in Figure 40 (c), a parallelogram whose top and bottom sides are aligned with $(1,0)$, and whose left and right sides are aligned with $(1,1)$ as shown in Figure 40 (d).

The following lemma shows that each valid region can be decomposed into at most 5 basic shapes.

Lemma 108. *Every valid region R can be decomposed into the union of at most 5 basic shapes.*

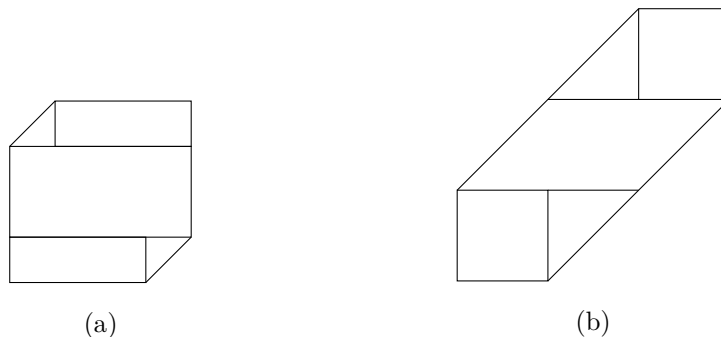

Figure 41: Decomposition of valid regions into at most 5 basic shapes.

Proof. First suppose that both an upper-left half-space and a lower-right half-space have been removed to create R . If there is a value x such that no point $p \in R$ with $p_2 = x$ is eliminated by either half-space, then we can decompose R into two triangles and three boxes, as shown in Figure 41 (a). If there is no

such value, then we can decompose R into two triangles, two boxes, and one parallelogram, as shown in Figure 41 (b).

The cases where one or both of the diagonal half-spaces are missing can clearly be done with even fewer basic shapes. \square

The next lemma states that, if we have a region defined by a basic shape, then we can make a single query and rule out at least a quarter of the area of that shape.

Lemma 109. *Given a region R that is either a box of width and height at least 6, a lower or upper right-angle triangle of width and height at least 4, or a parallelogram of height and width at most 6, we can make a single query and either find a global fixed point, or eliminate at least a 1/4 fraction of the area in R .*

Proof. We consider the different types of shape separately. In each case we make a single query and then consider the possible half-spaces that Lemma 107 rules out.

- To query a box (x, h, w) , we query the point

$$q = x + \left\lfloor \frac{w}{2} \right\rfloor \cdot e_1 + \left\lfloor \frac{h}{2} \right\rfloor \cdot e_2,$$

which is the centre of the box as shown in Figure 40 (a).

1. If we eliminate a vertical half-space defined by points p with $p_1 \leq q_1 - 1$ or $p_1 \leq q_1$, then the fraction of area that we rule out is at least

$$\begin{aligned} \frac{(\lfloor \frac{w}{2} \rfloor - 1) \cdot h}{w \cdot h} &= \frac{\lfloor \frac{w}{2} \rfloor - 1}{w} \\ &\geq \frac{\frac{w}{4}}{w} \\ &= 1/4, \end{aligned}$$

where we have used the fact that $w \geq 6$ implies that $\lfloor \frac{w}{2} \rfloor - 1 \geq \frac{w}{4}$.

2. If we eliminate a vertical half-space defined by points p with $p_1 \geq q_1$ or $p_1 \geq q_1 + 1$, then the fraction of area that we rule out is at least

$$\begin{aligned} \frac{(w - (\lfloor \frac{w}{2} \rfloor + 1)) \cdot h}{w \cdot h} &= 1 - \frac{\lfloor \frac{w}{2} \rfloor + 1}{w} \\ &\geq 1 - \frac{3w/4}{w} \\ &= 1/4, \end{aligned}$$

where we have used the fact that $w \geq 4$ implies that $\lfloor \frac{w}{2} \rfloor + 1 \leq \frac{3w}{4}$.

3. If we eliminate a horizontal half-space, then we can use the same argument as the first and second cases to argue that we rule out at least 1/4 of the area of R .
4. If we eliminate a diagonal half-space, then note that if q was at the centre of the box, then we clearly would have ruled out half the points. However, due to the rounding we used when computing q , we may not have ruled out exactly half of the points. But the set of discrete points that should have been ruled out but were not lie in a diagonal line along the vector $(1, 1)$ that spans the box directly next to the half-space defined by q . If we assume, without loss of generality, that $w \geq h$, this line contains h points, and so the fraction of the space that we actually rule out is at least

$$\begin{aligned} 1/2 - \frac{h}{w \cdot h} &\leq 1/2 - \frac{h}{h \cdot h} \\ &= 1/2 - \frac{1}{h}, \end{aligned}$$

Since $h \geq 6$ we therefore rule out at least $1/2 - \frac{1}{6} = 1/3$ of the space.

- To query a lower right-angle triangle of width and height k with lower-left corner x , we query the point

$$q = x + \left\lfloor \frac{k}{4} \right\rfloor \cdot e_1 + \left\lfloor \frac{k}{4} \right\rfloor \cdot (1, 1),$$

as shown in Figure 40 (b).

1. If we eliminate a vertical half-space defined by points p with $p_1 \geq q_1 + 1$, then we eliminate a right-angle triangle of width and height $k - \left\lfloor \frac{k}{4} \right\rfloor - 1$, which has area $0.5 \cdot (k - \left\lfloor \frac{k}{4} \right\rfloor - 1)^2$. The overall area of the original triangle is $0.5k^2$, so the fraction of area ruled out is at least

$$\begin{aligned} \frac{0.5 \cdot (k - \left\lfloor \frac{k}{4} \right\rfloor - 1)^2}{0.5k^2} &\geq \frac{(k - k/2)^2}{k^2} \\ &= 1/4, \end{aligned}$$

where we used the fact that $k \geq 4$ to ensure that $\left\lfloor \frac{k}{4} \right\rfloor + 1 \leq k/2$.

If we eliminate a vertical half-space defined by points p with $p_1 \geq q_1$ then we rule out even more space, so we again rule out at least $1/4$ of the area.

2. If we eliminate a horizontal half-space defined by points p with $p_2 \leq q_2 - 1$, then we keep a right-angle triangle of width and height $k - \left\lfloor \frac{k}{4} \right\rfloor + 1$, which has area $0.5 \cdot (k^2 - \left\lfloor \frac{k}{4} \right\rfloor + 1)^2$. The overall area of the original triangle is $0.5k^2$, so the area we rule out has size $0.5k^2 - 0.5 \cdot (k^2 - \left\lfloor \frac{k}{4} \right\rfloor + 1)^2$, so the proportion of the area that is ruled out is at least

$$\begin{aligned} \frac{0.5k^2 - 0.5 \cdot (k - \left\lfloor \frac{k}{4} \right\rfloor + 1)^2}{0.5k^2} &= 1 - \frac{(k - \left\lfloor \frac{k}{4} \right\rfloor + 1)^2}{k^2} \\ &\geq 1 - \frac{(k - k/4)^2}{k^2} \\ &= 1 - \frac{3^2}{4^2} \\ &= 7/16. \end{aligned}$$

where we used the fact that $\left\lfloor \frac{k}{4} \right\rfloor + 1 \geq \frac{k}{4}$ for all positive k .

If we eliminate a horizontal half-space defined by points p with $p_2 \leq q_2$, then we rule out even more space, so we again rule out at least a $7/16$ fraction of the area.

3. The cases where we rule out a vertical half-space are entirely symmetric to the cases for horizontal half-spaces.
 4. If we rule out a lower-right diagonal half-space, then we rule out a triangle with height and width $k - \frac{k}{4}$, which is strictly more than the amount of area we considered in the first case, so we rule out at least $1/4$ of the area.
 5. If we rule out an upper-left diagonal half-space, then we keep a triangle with height and width $k - \frac{k}{4}$, which is strictly less than the amount of area we considered in the second case, so we rule out at least $7/16$ of the area.
- To query an upper right-angle triangle of width and height k , we can flip both dimensions and follow the procedure for a lower right-angle triangle.
 - To query a parallelogram whose lower-left corner is x , and whose height is h and width is w , we query the point

$$x + \left\lfloor \frac{w}{2} \right\rfloor \cdot e_1 + \left\lfloor \frac{h}{2} \right\rfloor \cdot (1, 1),$$

as shown in Figure 40 (d).

1. If we rule out a horizontal half-space, then note that each row of points in the parallelogram has exactly w points. So the number of points that we rule out is exactly the same as the number of points we would rule out for a box of height h and width w . So we can reuse our proof for boxes to show that at least $1/4$ of the area is ruled out.

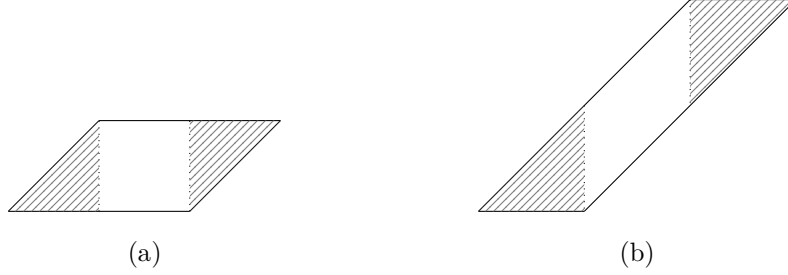

Figure 42: Removing two triangles from a parallelogram.

2. If we rule out a vertical half-space, then as shown in Figure 42, note that if we remove the triangles on either end of the parallelogram (which both have the same area), then we are either left with a box-shaped region, or a parallelogram whose left and right sides are aligned with $(0, 1)$, and whose top and bottom sides are aligned with $(1, 1)$. In the first case we can use the analysis for box regions, while in the second case we can exchange dimensions 1 and 2 and use Case 1 of the parallelogram analysis. In both cases, at least $1/4$ of the area is ruled out.
3. If we rule out a diagonal half-space, then note that each diagonal contains h points. So the number of points ruled out is exactly the same as the number that would be ruled out by a vertical half-space for a box of height h and width w . So we have that at least $1/4$ of the area is ruled out.

□

Each iteration of the algorithm has a valid region R , and proceeds as follows.

- Decompose R into at most 5 basic shapes using Lemma 108.
- Find the basic shape S that has the largest area, and then make a single query on S using Lemma 109, and rule out the resulting half-space in R .
- If query finds a global fixed point then we are done.
- Otherwise, we have ruled out at least $1/4$ of the area of S , and S made up at least $1/5$ of the area of R . So the total fraction of area ruled out from R is at least $1/20$.

This process continues until we either find a global fixed point, or until we no longer satisfy the preconditions of Lemma 109. This can only occur when the largest basic shape in the decomposition of R has either constant height or constant width. This either means that R is contained in a box of constant width or constant height (eg. in the example in Figure 41 (a)), or that R is contained in a $\text{DBox}(x, y, l)$ where $\|x - y\|_\infty$ is a constant (eg. this could occur in the example in Figure 41 (b)). We will deal with these two cases separately.

Handling diagonal regions. We are given a region $R = \text{DBox}(x, y, l)$ where $\|x - y\|_\infty$ is constant with the invariant that R contains a global fixed point, and we must find the global fixed point in $O(\log n)$ steps.

Consider a diagonal line defined by points p^1, p^2, \dots, p^k such that $p^{i+1} = p^i + (1, 1)$. If we query a point p^i then we have the following properties.

- If $p_1^i < f_1(p^i)$ then all points p^j with $j < i$ satisfy $p_1^j < f_1(p^j)$ by Lemma 79. On the other hand $p_1^i > f_1(p^i)$ then all points p^j with $j > i$ satisfy $p_1^j > f_1(p^j)$, for the same reason.
- For the same reason, if $p_2^i < f_2(p^i)$ then we can rule out all points p^j with $j < i$, and if $p_2^i > f_2(p^i)$ then we can rule out all points p^j with $j > i$.
- If $p_3^i < f_3(p^i)$ then we have $p_3^j < f_3(p^j)$ for all $j > i$ by Lemma 80, while if $p_3^i > f_3(p^i)$ then we have $p_3^j > f_3(p^j)$ for all $j < i$, for the same reason.

So we can carry out a binary search on the line p^1, p^2, \dots, p^k to determine if the line contains a global fixed point: for each query that we make, if the queried point is not a global fixed point, then one of the arguments above will rule out at least half of the points in the line. This process takes $O(\log n)$ steps.

Note that since $\|x - y\|_\infty$ is constant, the space $\text{DBox}(x, y, l)$ can be decomposed into constantly many diagonal lines. So we can apply the procedure above to each of those lines to find the global fixed point that lies in R using $O(\log n)$ steps.

Handling box shaped regions. In this case we are given a box (x, h, w) that contains a global fixed point where one of h or w is constant. We assume that w is constant. This is without loss of generality, because if h is constant we can exchange dimensions 1 and 2 and apply the same procedure.

Our approach is essentially the same as the diagonal case, with a slightly different justification. Consider the vertical line of points p^1, p^2, \dots, p^k $p^{i+1} = p^i + e_2$. If we query a point p^i then we have the following properties.

- If $p_1^i < f_1(p^i)$ then all points p^j with $j > i$ satisfy $p_1^j < f_1(p^j)$ by Lemma 80. On the other hand $p_1^i > f_1(p^i)$ then all points p^j with $j < i$ satisfy $p_1^j > f_1(p^j)$, for the same reason.
- If $p_2^i < f_2(p^i)$ then all points p^j with $j < i$ satisfy $p_2^j < f_2(p^j)$ by Lemma 79. On the other hand $p_2^i > f_2(p^i)$ then all points p^j with $j > i$ satisfy $p_2^j > f_2(p^j)$, for the same reason.
- If $p_3^i < f_3(p^i)$ then we have $p_3^j < f_3(p^j)$ for all $j > i$ by Lemma 80, while if $p_3^i > f_3(p^i)$ then we have $p_3^j > f_3(p^j)$ for all $j < i$, for the same reason.

So as in the diagonal case, if the line contains a global fixed point, we can find it using binary search in $O(\log n)$ steps. Since the box (x, h, w) contains constantly many vertical lines, we can perform a binary search on each of them independently to find the global fixed point. Overall this process makes $O(\log n)$ queries to f , and each step runs in time that is polynomial in the representation of f .

8.12 The Result

Finally, we can tie up everything in this section into our main algorithmic result. We have shown that the algorithm ends after making $O(\log n)$ queries to f , and note that all steps of our algorithm can be carried out in polynomial time relative to the representation of f . So we have shown the following theorem.

Theorem 110. *There is an algorithm that finds a fixed point in a violation-free three-dimensional DMAC instance f using $O(\log n)$ queries, where each step takes time that is polynomial in the representation of f .*

Applying the decomposition theorem given in Theorem 55 gives us the following theorem for d -dimensional DMAC, where we note that we must apply the reduction given in Lemma 62 to each three-dimensional instance that we consider while applying the decomposition theorem to ensure that we always find the least fixed point of the instance.

Theorem 111. *There is an algorithm that finds a fixed point in a violation-free d -dimensional DMAC instance f using $O((c \cdot \log n)^{\lceil d/3 \rceil})$ queries, where each step takes time that is polynomial in the representation of f .*

Finally, we can state our results for monotone contractions, which are obtained by applying Theorem 10 to reduce `MonotoneContraction` to DMAC, and then applying the previous theorem.

Theorem 112. *There is an algorithm that finds an ε -approximate fixed point of a d -dimensional `MonotoneContraction` instance g using $O((c \cdot \log(1/\varepsilon))^{\lceil d/3 \rceil})$ queries, where each step takes time that is polynomial in the representation of g .*

References

- [1] Stefan Banach. Sur les opérations dans les ensembles abstraits et leur application aux équations intégrales. *Fundamenta mathematicae*, 3(1):133–181, 1922.
- [2] Ch. Boonyasiriwat, Kris Sikorski, and Ch. Xiong. A note on two fixed point problems. *J. Complexity*, 23(4-6):952–961, 2007.
- [3] Xi Chen and Yuhao Li. Improved upper bounds for finding Tarski fixed points. In *Proc. of EC*, pages 1108–1118, 2022.
- [4] Xi Chen, Yuhao Li, and Mihalis Yannakakis. Reducing Tarski to unique Tarski (in the black-box model). In *Proc. of CCC*, volume 264 of *LIPICs*, pages 21:1–21:23, 2023.
- [5] Xi Chen, Yuhao Li, and Mihalis Yannakakis. Computing a fixed point of contraction maps in polynomial queries. In *Proc. of STOC*, pages 1364–1373, 2024.
- [6] Chuangyin Dang, Qi Qi, and Yinyu Ye. Computations and complexities of Tarski’s fixed points and supermodular games. *CoRR*, abs/2005.09836, 2020. Stanford tech report version appeared in 2012.
- [7] Constantinos Daskalakis and Christos H. Papadimitriou. Continuous local search. In *Proc. of SODA*, pages 790–804, 2011.
- [8] Constantinos Daskalakis, Christos Tzamos, and Manolis Zampetakis. A Converse to Banach’s Fixed Point Theorem and its CLS Completeness. In *Proc. of STOC*, pages 44–50, 2018.
- [9] Kousha Etessami, Christos H. Papadimitriou, Aviad Rubinfeld, and Mihalis Yannakakis. Tarski’s theorem, supermodular games, and the complexity of equilibria. In *Proc. of ITCS*, volume 151 of *LIPICs*, pages 18:1–18:19, 2020.
- [10] Kousha Etessami and Mihalis Yannakakis. On the complexity of nash equilibria and other fixed points. *SIAM J. Comput.*, 39(6):2531–2597, 2010.
- [11] John Fearnley, Paul Goldberg, Alexandros Hollender, and Rahul Savani. The complexity of gradient descent: $CLS = PPAD \cap PLS$. *J. ACM*, 70(1):7:1–7:74, 2023.
- [12] John Fearnley, Spencer Gordon, Ruta Mehta, and Rahul Savani. CLS: New problems and completeness. *CoRR*, abs/1702.06017, 2017.
- [13] John Fearnley, Spencer Gordon, Ruta Mehta, and Rahul Savani. Unique end of potential line. In *Proc. of ICALP*, volume 132, pages 56:1–56:15, 2019. <https://arxiv.org/abs/1811.03841>.
- [14] John Fearnley, Spencer Gordon, Ruta Mehta, and Rahul Savani. Unique end of potential line. *J. Comput. Syst. Sci.*, 114:1–35, 2020.
- [15] John Fearnley, Dömötör Pálvölgyi, and Rahul Savani. A faster algorithm for finding Tarski fixed points. *ACM Trans. Algorithms*, 18(3):23:1–23:23, 2022.
- [16] Kristoffer Arnsfelt Hansen, Michal Koucký, Niels Lauritzen, Peter Bro Miltersen, and Elias P. Tsigaridas. Exact algorithms for solving stochastic games: extended abstract. In *Proc. of STOC*, pages 205–214, 2011.
- [17] Kristoffer Arnsfelt Hansen, Michal Koucký, Niels Lauritzen, Peter Bro Miltersen, and Elias P. Tsigaridas. Exact algorithms for solving stochastic games. *CoRR*, abs/1202.3898, 2012.
- [18] Z. Huang, Leonid G. Khachiyan, and Christopher (Krzysztof) Sikorski. Approximating fixed points of weakly contracting mappings. *J. Complexity*, 15(2):200–213, 1999.
- [19] Marta Kwiatkowska, Gethin Norman, David Parker, and Gabriel Santos. Prism-games 3.0: Stochastic game verification with concurrency, equilibria and time. In *Proc. of CAV*, volume 12225, pages 475–487, 2020.
- [20] Miquel Oliu-Barton. New algorithms for solving zero-sum stochastic games. *Math. Oper. Res.*, 46(1):255–267, 2021.

- [21] Lloyd S. Shapley. Stochastic games*. *Proceedings of the National Academy of Sciences*, 39(10):1095–1100, 1953.
- [22] Spencer D. Shellman and Kris Sikorski. A two-dimensional bisection envelope algorithm for fixed points. *J. Complexity*, 18(2):641–659, 2002.
- [23] Spencer D. Shellman and Kris Sikorski. Algorithm 825: A deep-cut bisection envelope algorithm for fixed points. *ACM Trans. Math. Softw.*, 29(3):309–325, 2003.
- [24] Krzysztof Sikorski. Computational complexity of fixed points. *Journal of Fixed Point Theory and Applications*, 6(2):249–283, 2009.
- [25] Eilon Solan and Nicolas Vieille. Stochastic games. *Proceedings of the National Academy of Sciences*, 112(45):13743–13746, 2015.
- [26] Alfred Tarski. A lattice-theoretical fixpoint theorem and its applications. *Pacific Journal of Mathematics*, 5(2):285–309, 1955.