

# Improved Hardness Results for the Clearing Problem in Financial Networks with Credit Default Swaps

Simon Dohn, Kristoffer Arnsfelt Hansen, and Asger Klinkby

Aarhus University, Denmark

## Abstract

We study computational problems in financial networks of banks connected by debt contracts and credit default swaps (CDSs). A main problem is to determine *clearing* payments, for instance right after some banks have been exposed to a financial shock. Previous works have shown the  $\varepsilon$ -approximate version of the problem to be PPAD-complete and the exact problem FIXP-complete. We show that PPAD-hardness hold when  $\varepsilon \approx 0.101$ , improving the previously best bound significantly. Due to the fact that the clearing problem typically does not have a unique solution, or that it may not have a solution at all in the presence of default costs, several natural decision problems are also of great interest. We show two such problems to be  $\exists\mathbb{R}$ -complete, complementing previous NP-hardness results for the approximate setting.

## 1 Introduction

The worlds financial systems form large networks in which financial entities such as banks are closely interconnected by contracts. This results in nontrivial dependencies between banks, where a default of a single bank may affect large parts of the financial system. The prevalent use of financial *derivative* contracts, where a debt obligation depends on other contracts introduces additional complicated dependencies in the system.

A way to assess the complexity arising in such *financial networks* is to study computational problems that arise in these networks from the viewpoint of algorithms and computational complexity. In this paper we consider the model of financial networks defined by Schuldenzucker, Seuken and Battiston [16]. This models a static situation involving a number of financial entities (e.g. banks) that have already entered (simple) debt contracts and credit default swaps (CDSs) among each other. This is an extension of the basic model of Eisenberg and Noe [4] with CDSs as well as the addition of default costs introduced to the model by Rogers and Veraart [11].

After an event where a number of banks have experienced a financial shock on their assets, some of these may become unable to meet their obligations, leading them into default. This may in turn trigger additional events in the financial network eventually causing a ripple effect. This leads to the computational problem of evaluating all contracts of the network simultaneously to find clearing payments between the banks. More precisely we consider the problem of computing a *clearing recovery rate vector*, that describes for each bank the fraction of its liabilities it is able to pay, and as a consequence also which banks are in default. This problem has been considered in several prior works. Schuldenzucker et al. [16] showed that, under mild assumptions, a clearing recovery rate vector always exists for the setting where no costs are incurred due to the process of bankruptcy, thereby turning the computational problem into a total search problem. In a different work, Schuldenzucker et al. [15] proved that an  $\varepsilon$ -approximate version of the clearing problem is PPAD-complete and Ioannidis, Keijzer and Ventre [8] subsequently proved that computing an (exact) clearing recovery rate vector is FIXP-complete. From an algorithmic

viewpoint essentially nothing is known. Indeed, one may observe that a trivial solution gives a  $\frac{1}{2}$ -approximate solution and it is an open problem to find a polynomial time approximation algorithm with a better guarantee. The result of Schuldenzucker et al. proved PPAD-hardness for a small (unspecified) constant  $\varepsilon > 0$ . From a practical perspective, PPAD-hardness for a miniscule constant  $\varepsilon > 0$  may be less concerning, and it is therefore of interest to determine for how large values of  $\varepsilon$  the problem remains PPAD-hard. Recently, Ioannidis et al. [9] considerably strengthened the result of Schuldenzucker et al. and proved PPAD-hardness for  $\varepsilon \leq \frac{3-\sqrt{5}}{16} \approx 0.048$ . We improve this further and show PPAD-hardness for  $\varepsilon \leq 5 - 2\sqrt{6} \approx 0.101$ . Like Ioannidis et al. we obtain our result by reduction from the problem PURE-CIRCUIT, recently introduced Deligkas, Fearnley, Hollender and Melissourgos [3], which is a “generalized circuit” problem operating on the domain  $\{0, 1, \perp\}$ . Different from existing reductions (also to problems unrelated to financial networks) from PURE-CIRCUIT we decode values of the interval  $[0, 1]$  to elements of  $\{0, 1, \perp\}$  in an *asymmetric* way, more suited to exploit the characteristics of CDSs in financial networks. This in turn allows for a simpler reduction that additionally yields a stronger result.

A clearing recovery rate vector of a financial network will typically not be unique leading to the problem of *selecting* one of these. Simple questions a regulator might be interested in knowing the answer to, could be whether a particular bank or set of banks are bound to default, whether a default may be prevented, or whether they are guaranteed to avoid default. When default costs are present, a clearing recovery rate vector may not exist at all. This means that computing a clearing recovery rate vector (in case it exists) may be even harder in the presence of default costs.

These considerations lead to several natural decision problems and Schuldenzucker et al. [15] proved that these are NP-hard, in fact even for *gap* versions of the problems relevant for the setting of  $\varepsilon$ -approximate clearing. We complement these results by showing  $\exists\mathbb{R}$ -completeness for the problem of deciding if a given bank may avoid default and, in the setting of default costs (but on external assets only), for the problem of whether a clearing recovery rate exists. Having default costs only on external assets could model a setting where external assets are illiquid in comparison to obligations within the financial system, and having to liquidate these in response to a financial shock may incur a considerable loss.

These  $\exists\mathbb{R}$ -hardness results have direct consequences from an algorithmic perspective. Namely, solving these problems in the setting of exact clearing solutions must involve algorithmic techniques capable of solving general systems of polynomial equations. For the complexity class  $\exists\mathbb{R}$  we have the relation  $\text{NP} \subseteq \exists\mathbb{R}$ , and this inclusion is generally conjectured to be strict. This suggests that the decision problems for exact clearing are considerably harder than their approximate counterparts.

## 2 Preliminaries

### 2.1 Complexity Classes

Our results are concerned with the complexity classes PPAD and  $\exists\mathbb{R}$ , but it will also be relevant to introduce the complexity class FIXP. The classes PPAD and FIXP are classes of total search problems, whereas the class  $\exists\mathbb{R}$  is a class of decision problems. We introduce the classes briefly below and refer to the references for further details.

The class PPAD was defined by Papadimitriou [10] as the subclass of TFNP consisting of all problems reducible to the problem END-OF-LINE. We shall however not use this definition directly, and hence we do not define this problem formally. Instead, to prove PPAD-hardness we make use of the PURE-CIRCUIT problem, recently introduced by Deligkas, Fearnley, Hollender and Melissourgos [3] and for PPAD-membership we make use of general results about computing  $\varepsilon$ -almost fixed points of polynomially continuous and polynomially computable functions. We

introduce the PURE-CIRCUIT problem in detail in Section 3.

The class FIXP is a class of total real valued search problems defined by Etessami and Yannakakis [5]. It consists of all problems reducible, by a so-called SL-reduction, to the problem of finding a fixed point of a continuous function  $F: D \rightarrow D$ , where  $D \subseteq \mathbb{R}^n$  convex set. The class FIXP allows several different equivalent definitions in how  $F$  and  $D$  should be described. A simple such definition is to let  $D = [0, 1]^n$  and the function  $F$  be given by an algebraic circuit with  $n$  inputs and  $n$  outputs over the basis  $\{+, *, \max\}$  and allowing use of arbitrary rational constants.

If we restrict the basis to be  $\{+, *c, \max\}$ , where  $*c$  refers to multiplication by a constant, we obtain the class Linear-FIXP. The class can be viewed as a class of discrete total search problems and with this interpretation Etessami and Yannakakis proved that  $\text{PPAD} = \text{Linear-FIXP}$ .

The class  $\exists\mathbb{R}$  was defined formally by Schaefer and Štefankovič [12, 14] and Bürgisser and Cucker [1]. One may think of the class  $\exists\mathbb{R}$  as having a relationship to NP similarly to the relationship of FIXP to PPAD. Schaefer and Štefankovič defined the class  $\exists\mathbb{R}$  to have the decision problem for the existential theory of the reals, ETR, as its complete problem, whereas Bürgisser and Cucker defined the class as the constant free Boolean part of the analogue class  $\text{NP}_{\mathbb{R}}$  to NP in the Blum-Shub-Smale model of computation. For proving  $\exists\mathbb{R}$ -membership the latter definition is most convenient.

The standard  $\exists\mathbb{R}$ -complete problem is the problem QUAD of determining whether a system of quadratic polynomials in  $n$  variables has a solution. Schaefer [13, Lemma 3.9] proved QUAD remains  $\exists\mathbb{R}$ -hard even with a promise that the system has a solution in the unit  $n$ -ball whenever the system has any solution. We need the analogous statement for the unit  $n$ -cube, which we denote by  $\text{QUAD}([0, 1]^n)$ .

**Proposition 1.**  $\text{QUAD}([0, 1]^n)$  is  $\exists\mathbb{R}$ -hard.

This result can either easily be derived from the result of Schaefer or follows as a direct corollary of [7, Proposition 2]. Next we consider the problem 4FEAS. Here we are given a single degree 4 polynomial  $p$  in  $n$  variables and the task is to decide if  $p$  has a root. We let  $4\text{FEAS}([0, 1]^n)$  refer to the promise version of the problem where a root in  $[0, 1]^n$  is guaranteed to exist in case  $p$  has any root.

**Corollary 1.**  $4\text{FEAS}([0, 1]^n)$  is  $\exists\mathbb{R}$ -hard.

*Proof.* We simply observe that the standard reduction QUAD to 4FEAS preserves the promise. Namely, given quadratic polynomials  $p_1, \dots, p_k$  in  $n$  variables we define the degree 4 polynomial  $p(x) = \sum_{i=1}^k (p_i(x))^2$ . It then follows that  $x$  is a solution to the system of equations  $p_1(x) = \dots = p_k(x) = 0$  if and only if  $p(x) = 0$ .  $\square$

## 2.2 Financial Networks

We consider the model of financial networks defined by Schuldenzucker, Seuken and Battiston [16]. This models a static situation of banks that have already entered debt contracts and CDSs among each other that must now all be evaluated simultaneously.

**Banks and Contracts** A *financial network* is a given by a finite set  $N$  of  $n = |N|$  banks. Each bank  $i \in N$  holds an amount of *external assets*  $e_i \geq 0$ . Debt contracts are given by  $c_{i,j} \geq 0$  for distinct banks  $i, j \in N$  and CDSs are given by  $c_{i,j}^k \geq 0$  for distinct banks  $i, j, k \in N$ . The numbers  $c_{i,j}$  and  $c_{i,j}^k$  are commonly referred to as the *notionals* of the contracts. For notational convenience we let  $c_{i,i} = 0$  and  $c_{i,i}^j = c_{i,j}^i = c_{i,j}^j = 0$  for all  $i, j \in N$ .

The contracts specify obligations for the *writer* (debtor) to pay an amount of money, the *liability*, to the *holder* of the contract. A bank unable to fulfill all its obligations is *in default*.

The *recovery rate*  $r_i \in [0, 1]$  of bank  $i \in N$  is the fraction of liabilities it is able to pay. A bank is thus in default if and only if  $r_i < 1$ . A bank which is not in default is also said to be *solvent*.

When  $c_{i,j} > 0$ , bank  $i$  is obligated to pay the (unconditional) liability  $c_{i,j}$  to bank  $j$ . When  $c_{i,j}^k > 0$ , bank  $i$  is obligated to pay the (conditional) liability  $(1 - r_k)c_{i,j}^k$  to bank  $k$ , based on the recovery rate of the *reference* bank  $k$ . As specified above, a bank can only take one of the two roles of a debt contract or one of the three roles of a CDS.

A CDS allows an insurance on debt contracts: If bank  $j$  holds both a simple debt contract written by bank  $k$  as well as a CDS with the same notional written by bank  $i$  with reference  $k$ , then bank  $j$  is guaranteed to receive the amount of the debt contract in the event that bank  $k$  defaults (as long as bank  $i$  does not default as well).

**Liabilities, Payments, and Assets** Let  $r \in [0, 1]^n$  be a given vector of recovery rates. The *liability* of bank  $i$  to bank  $j$  is given by  $l_{i,j}(r) = c_{i,j} + \sum_{k \in N} (1 - r_k)c_{i,j}^k$  and the *total liability* of bank  $i$  is  $l_i(r) = \sum_{j \in N} l_{i,j}(r)$ .

The total liability is converted into a total payment according to the principles of *absolute priority* and *limited liability*, meaning that banks must pay their liabilities in full if possible and never pay more than the entirety of their assets (subtracted possible default costs). Liabilities to individual banks are converted into payments according to the principle of *proportionality*, meaning that the total payment is divided according to each individual liability's share of the total liability. The *payment* from bank  $i$  to bank  $j$  is thus given by  $p_{j,i}(r) = r_i \cdot l_{i,j}(r)$ .

The assets of bank  $i \in N$  before *default costs* is given by

$$a_i(r) = e_i + \sum_{j \in N} p_{j,i}(r) . \quad (1)$$

Default costs are modeled by two parameters  $\alpha, \beta \in [0, 1]$ . When in default, a bank  $i$  is only able to recover an  $\alpha$ -fraction of its external assets and a  $\beta$ -fraction of incoming payments. The assets of bank  $i$  after default costs is then given by

$$a'_i(r) = \alpha e_i + \beta \sum_{j \in N} p_{j,i}(r) . \quad (2)$$

**Clearing Recovery Rates** Since the liabilities and assets of the banks are given in terms of presumed recovery rates and in turn also define recovery rates we are left with a fixed point problem.

**Definition 1** (Clearing recovery rate vector). *A recovery rate vector  $r \in [0, 1]^n$  is clearing if it is a fixed point of the function  $F: [0, 1]^n \rightarrow [0, 1]^n$  given by*

$$F(r)_i = \begin{cases} 1 & \text{if } a_i(r) \geq l_i(r) \\ \frac{a'_i(r)}{l_i(r)} & \text{if } a_i(r) < l_i(r) \end{cases} \quad (3)$$

The function  $F$  is introduced by Schuldenzucker, Seuken, and Battiston as the *update function*. This name is well-justified for financial networks where every CDS is *covered*, in which case iterating the function  $F$ , starting from the all ones vector, converges to a clearing recovery rate vector that maximizes the recovery rate of all banks simultaneously [16, Corollary 1]. In general, iterating the function  $F$  need not converge even when clearing recovery rate vectors exist.

When the financial network has default costs, i.e. when either  $\alpha < 1$  or  $\beta < 1$ , simple and natural examples show that a clearing recovery rate vector is not guaranteed to exist [16, Theorem 1]. But even in the case when  $\alpha = \beta = 1$  there exist (somewhat artificial) examples

(see Appendix A) of financial networks without a clearing recovery rate arising due to the discontinuity in the definition of the function  $F$ . To avoid this we shall as in previous works impose a *non-degeneracy* assumption.

**Definition 2** (Non-degeneracy). *A financial network is called non-degenerate if for all  $i \in N$ , either  $e_i > 0$  or there exists  $j \in N$  such that  $c_{i,j} > 0$ .*

In constructions it is useful to have banks that have written no contracts but hold one or more contracts. In this case it is without loss of generality to supply the bank with external assets, since the bank is solvent by definition.

Note that for a non-degenerate financial network we are guaranteed that  $\max(a_i(r), l_i(r))$  is bounded from below by a fixed positive constant. As noted by Ioannidis, Keijzer and Ventre [8], in case  $\alpha = \beta = 1$ , a clearing recovery rate vector may thus be found as a fixed point of the continuous function  $f: [0, 1]^n \rightarrow [0, 1]^n$  given by

$$f(r)_i = \frac{a_i(r)}{\max(a_i(r), l_i(r))} , \quad (4)$$

guaranteed to exist by Brouwer's fixed point theorem. Note that when  $l_i(r) \neq 0$  we have that  $F(r)_i = \min\left(1, \frac{a_i(r)}{l_i(r)}\right) = f(r)_i$ .

**Notation** For  $x \in \mathbb{R}$ , we denote by  $\llbracket x \rrbracket$  the *truncation* of  $x$  to the interval  $[0, 1]$ , i.e.  $\llbracket x \rrbracket = \min(1, \max(0, x))$ . For  $\varepsilon > 0$  we write  $x = y \pm \varepsilon$  to mean that  $x \in [y - \varepsilon, y + \varepsilon]$ . Both notations extends naturally to vectors, i.e.  $(\llbracket x \rrbracket)_i = \llbracket x_i \rrbracket$  for all  $i$ , and  $x = y \pm \varepsilon$  if  $x_i = y_i \pm \varepsilon$  for all  $i$ .

**Diagrams of Financial Networks** We may conveniently represent a financial network as a labeled directed graph. The nodes are given by the set of banks  $N$ . The node  $i \in N$  is labeled by the external assets  $e_i$ . When  $c_{i,j} > 0$ , the graph has an arc from  $i$  to  $j$  labeled by the notional  $c_{i,j}$ . When  $c_{i,j}^k > 0$ , the graph has an arc from  $i$  to  $j$  labeled by the notional  $c_{i,j}^k$  as well as the reference bank  $k$ . When illustrating these graphs as diagrams we label external assets  $e_i$  in a box drawn on top of the node of the bank  $i$ . This label may be omitted when  $e_i = 0$ . A debt contract is drawn as a blue arc and a CDS as an orange arc, both labeled by the notional. Instead of labeling the arc corresponding to a CDS also by the reference bank, we connect the reference bank and the arc by a dashed line. An example is given in Figure 1.

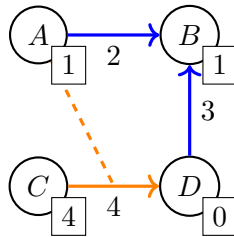

Figure 1: Example diagram of financial network.

When there are no default cost, i.e. when  $\alpha = \beta = 1$ , the unique clearing recovering vector in this example is  $(r_A, r_B, r_C, r_D) = (1/2, 1, 1, 2/3)$ . Suppose now that  $\alpha = 1/2$  and  $\beta = 2/3$ . In this case the unique clearing recovering vector is instead  $(r_A, r_B, r_C, r_D) = (1/4, 1, 1, 1)$ . Thus introducing default costs made bank  $D$  solvent. Note also that the value of  $\beta$  is not relevant in the example.

**Source and Sink Banks** When constructing financial networks it is convenient to have banks that are sources and sinks of the associated directed graph and that these banks are *far* from

default in any circumstance [15]. The role of these banks are therefore exclusively to act as writers and holders, respectively, of contracts, and we refer to these as *source banks* and *sink banks*. More precisely, we shall assume that the assets of source and sink banks are always at least double the amount of their liabilities. This trivially holds for sink banks and for a source bank  $s$  we can simply assume that  $e_s \geq 2 \left( \sum_{j \in N} c_{s,j} + \sum_{k \in N} c_{s,j}^k \right)$ . To ensure the banks satisfy the non-degeneracy assumption of Definition 2, we shall in addition assume that a source bank  $s$  holds a debt contract with a sink bank  $t$  of notional of 1 and we assume that a sink bank  $t$  has external assets  $e_t = 1$ .

In diagrams of financial networks we reserve the labels  $s$  and  $t$  for source and sink banks, respectively, possibly with subscripts. For the purpose of clarity in the diagrams we do not label source and sink banks with their external assets and we do not draw the contracts directly from source banks to sink banks used to ensure that the non-degeneracy condition holds.

### 2.3 Computation by Financial Networks

The complexity of computational problems about financial networks arises from the ability of the networks to perform computation. Consider the financial network given in Figure 2 where bank  $v$  holds a CDS with reference  $u$  of notional  $c_{s,v}^u$  and is also the writer of a contract of notional 1. We assume that the recovery rate of bank  $u$  is determined by assets and liabilities not illustrated. We now have the relationship

$$r_v = \min \left( 1, c_{s,v}^u (1 - r_u) \right) , \quad (5)$$

which one can see resembles the voltage transfer characteristics of an inverter, indicating its usefulness as a basic building block.

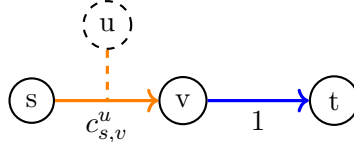

Figure 2: Financial network gadget with input bank  $u$  and output bank  $v$ .

Another source of computational power of the model of financial networks comes from the fact that payments are obtained from liabilities by *multiplication* of the recovery rate. When considering exact clearing recovery rate vectors this enables financial networks to evaluate polynomials (see Section 4.1) and general algebraic circuits [8].

**Financial Network Gadgets** Generalizing on the example of Figure 2 we consider small financial networks, which we refer to as financial network *gadgets*, with designated *input* and *output* banks. An input bank will be the output bank of another gadget (and hence illustrated with a dashed circle). Non-input banks will typically have no external assets and have their recovery rates depend functionally on the recovery rates of the input banks.

## 3 PPA hardness of Approximate Clearing

It is not a priori obvious what would constitute a reasonable notion of approximation of clearing recovery rate vectors. Ideally such an approximation should enable a reasonable resolution of contracts. In particular, when computing payments from approximations to recovery rates, it is crucial that money is not missing in the system to be able to do so. On the other hand, from the perspective of proving computational hardness results this becomes a lesser concern, and

such results are meaningful as long as the conditions imposed by the notion of approximation can be viewed as necessary conditions.

For approximation we focus on the case of financial networks without default costs. A candidate notion of approximation is that of an  $\varepsilon$ -almost fixed point of the function  $f$ , i.e.  $r \in [0, 1]^n$  such that  $\|f(r) - r\|_\infty \leq \varepsilon$ , and this is equivalent to the notion of approximation considered by Schuldenzucker et al. [15]. For non-degenerate financial networks we have that the problem of computing  $\varepsilon$ -almost fixed point of the function  $f$  is contained in PPAD by a general result of Etessami and Yannakakis [5, Proposition 2.2].

A weakness<sup>1</sup> of this definition is that it allows for a bank that is very far from being in default to have a recovery rate of  $1 - \varepsilon$ , which in turn would trigger CDSs that could have significant impact unless  $\varepsilon$  is negligible. Ioannidis et al. [9] imposed the additional condition that a bank  $i$  for which  $e_i > \sum_{j \in N} c_{s,j} + \sum_{k \in N} c_{s,j}^k$  must have recovery rate  $r_i = 1$ . This condition may be handled during a preprocessing step, which then gives PPAD-membership also for this modified definition. While it is clearly justified to declare such a bank solvent, it seems a somewhat artificial to restrict the solvency condition to banks that are *guaranteed* to be solvent due to sufficient external assets. It arguably appears more natural to extend the condition to say that a bank with more assets than liabilities in a given situation must have recovery rate 1, i.e. to enforce the condition  $a_i(r) > l_i(r) \implies r_i = 1$ . It is however not clear whether PPAD-membership holds with this condition, due to the sharp transition between solvency and default. Since we aim for a reasonable notion of approximation we shall relax the condition to only require a recovery rate of 1 when a bank clearly has more assets than liabilities. We therefore propose the following notion of approximate clearing recovery rate vectors.

**Definition 3** ( $\varepsilon$ -approximate clearing recovery rate vector). *For a financial network without default costs, a recovery rate vector  $r \in [0, 1]^n$  is an  $\varepsilon$ -approximate clearing recovery rate vector if  $\|f(r) - r\|_\infty \leq \varepsilon$  and  $a_i(r) \geq (1 + \varepsilon)l_i(r) \implies r_i = 1$  for all  $i \in N$ .*

We shall refer to the problem of computing an  $\varepsilon$ -approximate clearing recovery rate vector in non-degenerate financial networks without default costs as the  $\varepsilon$ -CDS-CLEARING problem. We give the simple proof of PPAD-membership for  $\varepsilon$ -CDS-CLEARING with respect to Definition 3 in Appendix B. Let us also note that the PPAD-hardness result of Ioannidis et al. [9] still holds under the weaker assumption above. Our result is the following.

**Theorem 1.** *The problem  $\varepsilon$ -CDS-CLEARING is PPAD-hard for  $\varepsilon \leq 5 - 2\sqrt{6} \approx 0.101$ .*

While still being very far from the (trivial) upper bound of  $\varepsilon = \frac{1}{2}$ , the result is a significant quantitative improvement upon the previous work of Ioannidis et al. [9] that obtained the same result for  $\varepsilon \leq \frac{3-\sqrt{5}}{16} \approx 0.048$ . Both of these bounds on  $\varepsilon$  are clearly in the range of practical relevance.

### 3.1 Pure-Circuit

To show PPAD-hardness of the approximate clearing problem, we will be reducing from the problem PURE-CIRCUIT, like the previous work of Ioannidis et al. [9]. The PURE-CIRCUIT problem was recently introduced and proved to be complete for PPAD by Deligkas et al. [3], and with this the same authors could greatly simplify and improve previous PPAD-hardness results for a range of problems.

The PURE-CIRCUIT problem is a type of “generalized circuit” problem [2], which means that the instance is given as a directed graph, the *circuit*, with nodes being *gates* computing

<sup>1</sup>In addition, using this definition would have implications for proving hardness of approximation, since it would not be possible to guarantee that a source bank is solvent no matter how many external assets it has. Our result, as well as the result of Ioannidis et al. [9], could be adapted to this weaker definition, but would result in PPAD-hardness for smaller values of  $\varepsilon$ .

a specific function from its inputs to its outputs, but where the circuit itself does not have designated inputs or outputs. The circuit instead has cycles, which in turn means that the problem is essentially a constraint satisfaction problem. The problem is however defined such that a solution is guaranteed to exist.

The gates of a PURE-CIRCUIT instance operate on the domain  $\{0, 1, \perp\}$ . We may view this as an abstraction of a value in the interval  $[0, 1]$  where  $\perp$ , the “garbage” value, refer to any value in the open interval  $(0, 1)$ . The usual Boolean gates are readily extended to the domain  $\{0, 1, \perp\}$ . We give the definition for the (complete) function NAND.

**Definition 4.** *The NAND gate with inputs  $u, v \in \{0, 1, \perp\}$  and output  $w \in \{0, 1, \perp\}$  is satisfied if and only if  $(u = 1 \wedge v = 1 \implies w = 0)$  and  $(u = 0 \vee v = 0 \implies w = 1)$ .*

The novel PURIFY gate has two outputs and guarantees a “pure bit” on one of these.

**Definition 5.** *The PURIFY gate with input  $u \in \{0, 1, \perp\}$  and outputs  $v, w \in \{0, 1, \perp\}$  is satisfied if and only if  $(u \neq \perp \implies v = u \wedge w = u)$  and  $(v \neq \perp \vee w \neq \perp)$ .*

The PURE-CIRCUIT problem is PPAD-complete for circuits with PURIFY gates together with a set of functionally complete Boolean gates. In particular we have the following.

**Theorem 2** (Deligkas et al. [3]). *PURE-CIRCUIT is PPAD-complete for circuits with NAND and PURIFY gates.*

### 3.2 Proof of Theorem 1

We make a reduction from PURE-CIRCUIT with NAND and PURIFY gates to  $\varepsilon$ -CDS-CLEARING by constructing financial network gadgets for both types of gates, where the inputs and outputs of the gates correspond to input and output banks. Keeping the network topology of these gadgets fixed, each gadget will involve a few parameters in the form of notionals of CDSs. It turns out that the NAND gate is the most restrictive towards maximizing  $\varepsilon$ , and we thus give a full analysis of our choice of parameters, showing it is optimal.

Besides the gadget we require a way to map a clearing recovery rate vector to a solution of the PURE-CIRCUIT instance by means of a *decoding function*  $\text{dec}: [0, 1] \rightarrow \{0, 1, \perp\}$ . The function  $\text{dec}$  depends on two additional parameters  $\gamma, \delta \geq 0$  satisfying  $\gamma + \delta < 1$  and is defined as follows.

$$\text{dec}(r) = \begin{cases} 0 & \text{if } r \in [0, \gamma] \\ \perp & \text{if } r \in (\gamma, 1 - \delta) \\ 1 & \text{if } r \in [1 - \delta, 1] \end{cases} . \quad (6)$$

The characteristics of a CDS, as illustrated by Figure 2 has the consequence that it is advantageous to have the intervals in  $[0, 1]$  (of length  $\gamma$  and  $\delta$ , respectively) that are mapped to the endpoints by  $\text{dec}$  be *asymmetric*. In particular, for our setting of parameters, we will have  $\gamma = 3 - \sqrt{6} \approx 0.551$  and  $\delta = 5 - 2\sqrt{6} \approx 0.101$ , but for now we leave them unfixed.

**NAND gadget** Our financial network gadget for the NAND gate is given in Figure 3, with parameters  $c_1$  and  $c_2$  still to be determined. This gadget was already defined by Schuldenszucker et al. [15], but in a different setting and with different parameters and analysis.

For the gadget to operate correctly we require that for any  $\varepsilon$ -approximate clearing recovery rate vector, the values  $\text{dec}(r_u)$ ,  $\text{dec}(r_v)$ , and  $\text{dec}(r_w)$  must satisfy the NAND gate. Having an  $\varepsilon$ -approximate solution means that  $r_w = \llbracket (1 - r_u)c_1 + (1 - r_v)c_2 \rrbracket \pm \varepsilon$ . In particular,

$$\begin{aligned} r_w &\geq \min(1, (1 - r_u)c_1) - \varepsilon \\ r_w &\geq \min(1, (1 - r_v)c_2) - \varepsilon \\ r_w &\leq (1 - r_u)c_1 + (1 - r_v)c_2 + \varepsilon \end{aligned} \quad (7)$$



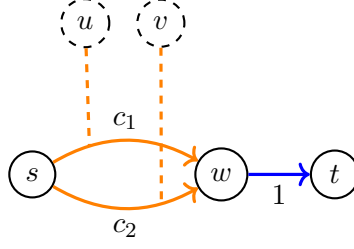

Figure 3: NAND gadget

To satisfy Definition 4 we must ensure that that  $r_w \geq 1 - \delta$  when either  $r_u \leq \gamma$  or  $r_v \leq \gamma$ , and that  $r_w \leq \gamma$  when both  $r_u \geq 1 - \delta$  and  $r_v \geq 1 - \delta$ . This leads to the requirements

$$1 - \varepsilon \geq 1 - \delta \quad (8)$$

$$(1 - \gamma)c_1 - \varepsilon \geq 1 - \delta \quad (9)$$

$$(1 - \gamma)c_2 - \varepsilon \geq 1 - \delta \quad (10)$$

$$\delta c_1 + \delta c_2 + \varepsilon \leq \gamma \quad (11)$$

To maximize  $\varepsilon$  we see that we should minimize  $\delta$ , and (8) dictates that  $\delta = \varepsilon$ . Inequality (11) shows that we should minimize both  $c_1$  and  $c_2$ , and (9) and (10) dictates that  $c_1 = c_2 = \frac{1}{1-\gamma}$ . Letting (11) hold with equality and solving for  $\varepsilon$  yields  $\varepsilon = \frac{\gamma(1-\gamma)}{3-\gamma}$ . The maximum for  $\gamma \in [0, 1]$  is  $\varepsilon = 5 - 2\sqrt{6} \approx 0.101$  obtained for  $\gamma = 3 - \sqrt{6} \approx 0.551$ , and this is a valid choice for  $\gamma$  since  $\gamma + \delta = 8 - \sqrt{6} \approx 0.652 < 1$ .

**PURIFY gadget** Our financial network gadget for the PURIFY gate is given in Figure 4, with  $\gamma$  and  $\varepsilon$  specified as above. The parameter  $\phi$  is still to be specified, while we let  $\eta = \frac{1-\phi}{1-\gamma} + \varepsilon$ . The gadget was introduced by Ioannidis et al. [9] with different parameters and analysis.

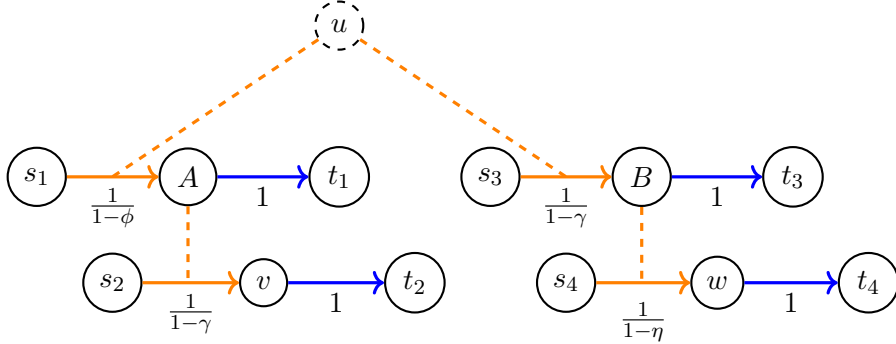

Figure 4: PURIFY gadget

For the gadget to operate correctly we require that for any  $\varepsilon$ -approximate clearing recovery rate vector, the values  $\text{dec}(r_u)$ ,  $\text{dec}(r_v)$ , and  $\text{dec}(r_w)$  must satisfy the PURIFY gate. By Definition 5 this means that we must satisfy the following conditions.

$$\text{dec}(r_u) = 0 \implies \text{dec}(r_v) = 0 \wedge \text{dec}(r_w) = 0 \quad (12)$$

$$\text{dec}(r_u) = 1 \implies \text{dec}(r_v) = 1 \wedge \text{dec}(r_w) = 1 \quad (13)$$

$$\text{dec}(r_v) \neq \perp \vee \text{dec}(r_w) \neq \perp \quad (14)$$

It turns out that there is a small range of values for  $\phi$  where these holds true. Rather than making a complete analysis, we make the arbitrarily choice of  $\phi = \frac{7}{10}$  from this range, and

simply prove that this works. Having an  $\varepsilon$ -approximate solution means that

$$r_A = \left\lfloor \frac{1 - r_u}{1 - \phi} \right\rfloor \pm \varepsilon, \quad r_v = \left\lfloor \frac{1 - r_A}{1 - \gamma} \right\rfloor \pm \varepsilon \quad (15)$$

$$r_B = \left\lfloor \frac{1 - r_u}{1 - \gamma} \right\rfloor \pm \varepsilon, \quad r_w = \left\lfloor \frac{1 - r_B}{1 - \eta} \right\rfloor \pm \varepsilon \quad (16)$$

We start by showing that (14) holds. Let us first assume  $r_u \leq \phi$ . From (15) we have that  $r_A \geq 1 - \varepsilon$  and then further that

$$r_v \leq \frac{\varepsilon}{1 - \gamma} + \varepsilon = \gamma \frac{2 - \gamma}{3 - \gamma} \leq \gamma,$$

where the equality follows from our choice of  $\gamma$  and  $\varepsilon$ . This means that  $\text{dec}(r_v) = 0$ . Suppose now that  $r_u \geq \phi$ . From (16) we have that  $r_B \leq \frac{1 - \phi}{1 - \gamma} + \varepsilon = \eta$  and then further that  $r_w \geq 1 - \varepsilon = 1 - \delta$ . This means that  $\text{dec}(r_w) = 1$ .

We proceed to show that (12) and (13) hold. Note that since  $\gamma \leq \phi \leq 1 - \delta$ , we have already shown that  $r_u \leq \gamma$  implies  $r_v \leq \gamma$  and that  $r_u \geq 1 - \delta$  implies  $r_w \geq 1 - \delta$ , which means that  $\text{dec}(r_u) = 0$  implies  $\text{dec}(r_v) = 0$  and that  $\text{dec}(r_u) = 1$  implies  $\text{dec}(r_w) = 1$ . We are therefore left with two cases to consider.

Assume first that  $r_u \geq 1 - \delta = 1 - \varepsilon$ . Then

$$r_A \leq \frac{\varepsilon}{1 - \phi} + \varepsilon = \frac{13}{3}\varepsilon \leq \gamma, \quad (17)$$

by the choice of  $\gamma$ ,  $\varepsilon$ , and  $\phi$ . It follows that  $r_v \geq 1 - \varepsilon = 1 - \delta$ , thereby proving the remaining part of (13). Assume next that  $r_u \leq \gamma$ . Then  $r_B \geq 1 - \varepsilon$  and thus

$$r_w \leq \frac{\varepsilon}{1 - \eta} + \varepsilon \leq \gamma, \quad (18)$$

again by the choice of  $\gamma$ ,  $\varepsilon$ , and  $\phi$ , thereby proving the remaining part of (18) as well, and thereby completing the proof.

For clarity we evaluate the quantities in (17) and (18) numerically, and find that  $\frac{13}{3}\varepsilon \approx 0.438$  and that  $\frac{\varepsilon}{1 - \eta} + \varepsilon \approx 0.537$ , while recalling that  $\gamma \approx 0.551$ .

**Completing the Reduction** Given the definition and analysis of the gadgets for NAND and PURIFY gadget above, a reduction from PURE-CIRCUIT to  $\varepsilon$ -CDS-CLEARING having  $\varepsilon = 5 - 2\sqrt{6}$  is now immediate. Each gate of the given PURE-CIRCUIT instance is replaced by the corresponding financial network gadget, and joining these together gives the resulting financial network of the reduction. An  $\varepsilon$ -approximate clearing recovery rate vector  $r$  for this financial network now results in a solution to the PURE-CIRCUIT instance given directly by  $\text{dec}(r)$ .

## 4 $\exists\mathbb{R}$ Completeness Results

In this section we consider two natural decision problems for financial networks with CDSs, and show them to be  $\exists\mathbb{R}$  complete. In the presence of default costs, a clearing recovery rate vector is not guaranteed to exist. Define CDS-HASCLEARING( $\alpha, \beta$ ) to be the problem of deciding if a given non-degenerate financial network with default costs  $\alpha$  and  $\beta$  has a clearing recovery rate vector. The problem is clearly contained in  $\exists\mathbb{R}$  by the characterization of  $\exists\mathbb{R}$  by BSS machines [1], and we prove a matching hardness result.

**Theorem 3.** *The problem CDS-HASCLEARING( $\alpha, 1$ ) is  $\exists\mathbb{R}$ -complete for all  $\alpha < 1$ .*

Schuldenzucker et al. [15, Theorem 1] proved NP-hardness when either  $\alpha < 1$  or  $\beta < 1$  that holds a *gap* version of the problem, which is the appropriate hardness notion in relation to  $\varepsilon$ -approximate clearing. Our result addresses the setting of exact clearing, and here strengthens the result of NP-hardness to  $\exists\mathbb{R}$ -hardness in the case of  $\alpha < 1$ , thereby completely settling the complexity of the problem. We leave the problem of determining the precise computational complexity for the case of  $\beta < 1$  as an interesting open problem. We note that when  $\beta < 1$  the input gadget and the arithmetic gadgets break.

In the case of no default costs, although a clearing recovery rate vector is guaranteed to exist, it will typically not be unique. In such cases a regulator might have interest in the default or solvency of a particular bank or set of banks. Define CDS-CANDEFAULT to be the problem of deciding if there exist a clearing recovery rate vector for which a given bank defaults, and similarly define CDS-CANSURVIVE to be the problem of deciding if there exist a clearing recovery rate vector for which a given bank remains solvent. Both problems are again clearly in  $\exists\mathbb{R}$ , and we complement this with a matching hardness result for the latter problem.

**Theorem 4.** *The problem CDS-CANSURVIVE is  $\exists\mathbb{R}$ -complete.*

Schuldenzucker et al. [15, Theorem 1] proved that gap versions of both problems are NP-hard. For exact clearing we settle the complexity of the problem CDS-CANSURVIVE and leaving the the precise computational complexity of the problem CDS-CANDEFAULT as another interesting open problem.

#### 4.1 Evaluating Polynomials in Financial Networks

In order to prove  $\exists\mathbb{R}$ -hardness by reduction from 4FEAS( $[0, 1]^n$ ) we shall build financial networks for evaluating a given polynomial. Let  $p$  be a degree 4 polynomial in  $n$  variables with  $s \geq 1$  monomials. By scaling we may, without loss of generality, assume that all coefficients are bounded in magnitude by  $1/s$ . Let us split  $p$  into two polynomials  $p^+$  and  $p^-$ , letting  $p^+$  be the sum of the monomials of  $p$  with positive coefficients and  $p^-$  be the sum of the monomials of  $p$  with negative coefficients, but having the sign of its coefficients flipped. Thus  $p^+$  and  $p^-$  are polynomials with no negative coefficients such that  $p(x) = p^+(x) - p^-(x)$ . Also, by assumption  $p^+(x), p^-(x) \in [0, 1]$  for all  $x \in [0, 1]^n$ .

Inputs ranging over  $[0, 1]$  are modeled by the *input gadget* illustrated in Figure 5, having no inputs and having single bank  $u$ . A clearing recovery rate vector is  $r_u = r_x$  for any  $r_x \in [0, 1]$ , thereby modeling the *free variable*  $x \in [0, 1]$ . This simple financial network was given already by Eisenberg and Noe [4, Appendix 2] as an example with multiple clearing recovery rate vectors. One could argue that for this particular financial network, the only reasonable clearing recovery rate vector would be  $r_u = r_x = 1$ . But on the other hand it seems quite difficult to exclude more complicated financial networks exhibiting a similar behavior in a natural way, or even just in an algorithmically efficient way, and we therefore find it acceptable as a gadget. The previous

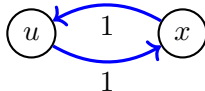

Figure 5: Input gadget.

works of Schuldenzucker et al. [15] and Ioannidis et al. [8] constructed financial network gadgets for arithmetic operations. In particular we require a *constant gadget* with the fixed output  $\zeta$ , for any  $\zeta \in [0, 1]$ , a *sum gadget* computing  $\llbracket u + v \rrbracket$ , a *difference gadget* computing  $\llbracket u - v \rrbracket$ , and a *multiplication gadget* computing  $u \cdot v$ . We furthermore require that these operate correctly in the setting of  $\alpha < 1$ . A multiplication gadget is given by Ioannidis et al. [8] and all other gadgets are given by Schuldenzucker et al. [15]. For completeness we describe the gadgets we use in Appendix C. Combining all these we have the following.

**Proposition 2.** *There is a polynomial time algorithm that given a degree 4 polynomial  $p$  in  $n$  variables with  $s \geq 1$  monomials and having coefficients of magnitude at most  $1/s$ , computes a financial network with an output gate  $o$  such there is a one to one correspondence between clearing recovery rate vectors and the set  $[0, 1]^n$ . Furthermore the clearing recovery rate vector corresponding to  $x \in [0, 1]^n$  has  $r_o = |p(x)|$ .*

*Proof.* We use  $n$  copies of the input gadget, one for each variable  $x_i$ ,  $i = 1, \dots, n$ . Next we compute the polynomials  $p^+$  and  $p^-$  on input  $x$  as follows. Each coefficient of these is computed by a constant gadget. All monomials can then be computed using multiplication gadgets, and using addition gadgets we compute  $p^+(x)$  and  $p^-(x)$ . Using difference gadgets we compute  $\llbracket p^+(x) - p^-(x) \rrbracket$  and  $\llbracket p^-(x) - p^+(x) \rrbracket$  and by a final addition gate we compute  $|p(x)| = \llbracket p^+(x) - p^-(x) \rrbracket + \llbracket p^-(x) - p^+(x) \rrbracket$ .  $\square$

## 4.2 Proof of Theorem 3

For our reduction we need a special case of an *infeasibility gadget* by Schuldenzucker et al. [15]. We state its properties here and for completeness describe the gadget in Appendix D.

**Lemma 1** (Infeasibility gadget [15, Lemma 5]). *There exists a financial network gadget with input bank  $u$ , such that*

- *If  $r_u \geq \frac{3}{4}$ , a clearing recovery rate vector exists.*
- *If  $r_u \leq \frac{1}{4}$ , no clearing recovery rate vector exists.*

To show  $\exists\mathbb{R}$  hardness of CDS-HASCLEARING we give a reduction from 4FEAS( $[0, 1]^n$ ). Following Proposition 2 we build a financial network with input gadgets selecting  $x \in [0, 1]^n$  followed by computation of  $|p(x)|$ . We wish to distinguish between the two cases,  $|p(x)| = 0$  and  $|p(x)| > 0$ , by existence of a clearing recovery rate vector. We create a “gap” between these cases using a discontinuity gadget.

**Lemma 2** (Discontinuity gadget). *There exists a financial network gadget with input bank  $u$  and output bank  $v$ , such that  $r_v = 1$  if  $r_u = 0$  and  $r_v = (\alpha + 1 - r_u)/2$  if  $r_u > 0$ .*

*Proof.* We wish to argue that the financial network gadget in Figure 6 has this property. First, assume  $r_u = 0$ . Then  $p_{s,v} = c_{s,v}^u(1 - r_u) = 1$  and  $v$  can pay all its liabilities, thus  $r_v = 1$ . Now assume  $r_u > 0$ . Then  $v$  is in default, and thus  $r_v = (\alpha e_v + (1 - r_u))/l_v = (\alpha + 1 - r_u)/2$ .  $\square$

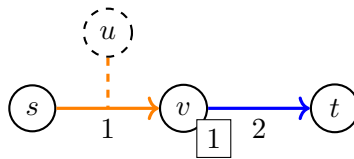

Figure 6: Discontinuity gadget.

Using a discontinuity gadget with input  $|p(x)|$  and output bank  $v$  means that we must now distinguish between the cases  $r_v = 1$  and  $r_v(\alpha + 1 - |p(x)|)/2 \leq (1 + \alpha)/2$ . In order to distinguish between these using the infeasibility gadget of Lemma 1 we perform a sequence of  $k$  repeated squaring operations using the multiplication gadget. Since

$$\left(\frac{1 + \alpha}{2}\right)^{2^k} = \left(1 - \frac{1 - \alpha}{2}\right)^{2^k} < \exp\left(-(1 - \alpha)2^{k-1}\right)$$

we can pick  $k = O(\log(1/(1 - \alpha)))$  such that  $(r_v)^{2^k} \leq 1/4$  whenever  $r_v \leq (1 + \alpha)/2$ . For the final step of the construction we use  $(r_v)^{2^k}$  as input to the infeasibility gadget. An abstract overview

of the complete financial network created by reduction is shown in Figure 7. By construction we have that there exists  $x \in [0, 1]^n$  such that  $p(x) = 0$  if and only if this financial network has a clearing recovery rate vector, thereby completing the proof.



Figure 7: An overview of the reduction to CDS-HASCLEARING( $\alpha, 1$ ).

### 4.3 Proof of Theorem 4

The proof of Theorem 4 starts in the same way as the proof of Theorem 3. We construct a reduction from 4FEAS( $[0, 1]^n$ ) and from a given polynomial  $p$ , following Proposition 2, we build an financial network with input gadgets for selecting  $x \in [0, 1]^n$  followed by computation of  $|p(x)|$ . For the remainder of the construction we use a simple financial network as shown in Figure 8. We now wish to argue that there exists a clearing recovery rate vector such that bank  $b$  is solvent if and only if there exists  $x \in [0, 1]^n$  such that  $p(x) = 0$ .

We have that  $r_b = 1$  if and only bank  $b$  receives a payment of 1, which happens if and only if  $r_A = 0$ , which in turn holds if and only if  $|p(x)| = 0$ , thereby completing the proof.

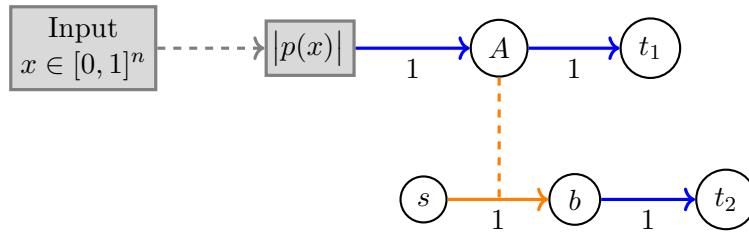

Figure 8: An overview the reduction to CDS-CANSURVIVE.

## References

- [1] P. Bürgisser and F. Cucker. Exotic quantifiers, complexity classes, and complete problems. *Found. Comput. Math.*, 9(2):135–170, 2009. doi:10.1007/s10208-007-9006-9.
- [2] X. Chen, X. Deng, and S. Teng. Settling the complexity of computing two-player Nash equilibria. *J. ACM*, 56(3):14:1–14:57, 2009. doi:10.1145/1516512.1516516.
- [3] A. Deligkas, J. Fearnley, A. Hollender, and T. Melissourgos. Pure-circuit: Strong inapproximability for PPAD. In *FOCS*, pages 159–170. IEEE, 2022. doi:10.1109/FOCS54457.2022.00022.
- [4] L. Eisenberg and T. H. Noe. Systemic risk in financial systems. *Manag. Sci.*, 47(2):236–249, 2001. doi:10.1287/mnsc.47.2.236.9835.
- [5] K. Etessami and M. Yannakakis. On the complexity of Nash equilibria and other fixed points. *SIAM J. Comput.*, 39(6):2531–2597, 2010. doi:10.1137/080720826.
- [6] A. Filos-Ratsikas, K. A. Hansen, K. Høgh, and A. Hollender. FIXP-membership via convex optimization: Games, cakes, and markets. *SIAM Journal on Computing*, pages FOCS21–30–FOCS21–84, to appear. doi:10.1137/22M1472656.

- [7] K. A. Hansen. The real computational complexity of minmax value and equilibrium refinements in multi-player games. *Theory Comput. Syst.*, 63(7):1554–1571, 2019. doi:10.1007/S00224-018-9887-9.
- [8] S. D. Ioannidis, B. de Keijzer, and C. Ventre. Strong approximations and irrationality in financial networks with derivatives. In M. Bojanczyk, E. Merelli, and D. P. Woodruff, editors, *ICALP 2022*, volume 229 of *LIPICs*, pages 76:1–76:18. Schloss Dagstuhl - Leibniz-Zentrum für Informatik, 2022. doi:10.4230/LIPICs.ICALP.2022.76.
- [9] S. D. Ioannidis, B. de Keijzer, and C. Ventre. Clearing financial networks with derivatives: From intractability to algorithms. *CoRR*, abs/2312.05139, 2023. doi:10.48550/arXiv.2312.05139.
- [10] C. H. Papadimitriou. On the complexity of the parity argument and other inefficient proofs of existence. *J. Comput. Syst. Sci.*, 48(3):498–532, 1994. doi:10.1016/S0022-0000(05)80063-7.
- [11] L. C. G. Rogers and L. A. M. Veraart. Failure and rescue in an interbank network. *Manag. Sci.*, 59(4):882–898, 2013. doi:10.1287/mnsc.1120.1569.
- [12] M. Schaefer. Complexity of some geometric and topological problems. In *GD*, volume 5849 of *Lecture Notes in Computer Science*, pages 334–344. Springer, 2009. doi:10.1007/978-3-642-11805-0\_32.
- [13] M. Schaefer. Realizability of graphs and linkages. In J. Pach, editor, *Thirty Essays on Geometric Graph Theory*, pages 461–482. Springer New York, 2013. doi:10.1007/978-1-4614-0110-0\_24.
- [14] M. Schaefer and D. Štefankovič. Fixed points, Nash equilibria, and the existential theory of the reals. *Theory Comput. Syst.*, 60(2):172–193, 2017. doi:10.1007/s00224-015-9662-0.
- [15] S. Schuldenzucker, S. Seuken, and S. Battiston. The computational complexity of financial networks with credit default swaps. *CoRR*, abs/1710.01578, 2019. Working Paper. doi:10.48550/arXiv.1710.01578.
- [16] S. Schuldenzucker, S. Seuken, and S. Battiston. Default ambiguity: Credit default swaps create new systemic risks in financial networks. *Manag. Sci.*, 66(5):1981–1998, 2020. doi:10.1287/mnsc.2019.3304.

## A Non-existence of a clearing recovery rate vector in a degenerate financial networks

In Figure 9 we give a relatively simple example of a financial network, violating the non-degeneracy assumption, without a clearing recovery vector. By construction of the network and Definition 1, if  $r$  is a clearing recovery rate vector the following three equations must hold.

$$r_A = \min(1, 2(1 - r_B)) \ , \quad r_B = \begin{cases} 1 & \text{if } r_C = 1 \\ \frac{1}{2} & \text{if } r_C < 1 \end{cases} \ , \quad r_C = \begin{cases} 1 & \text{if } r_A = 1 \\ 0 & \text{if } r_A < 1 \end{cases} \ . \quad (19)$$

With these we can rule out a clearing recovery vector. Suppose first that  $r_C = 1$ . The second and first equation then give that  $r_B = 1$  and  $r_A = 0$ . But then the third equation gives the contradiction that  $r_C = 0$ . Suppose next that  $r_C = 0$ . The second and first equation then give that  $r_B = \frac{1}{2}$  and  $r_A = 1$ . But then the third equation gives the contradiction that  $r_C = 1$ .

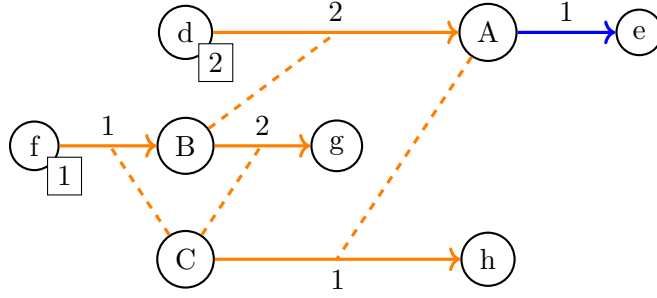

Figure 9: Degenerate Financial Network.

As an alternative to making an assumption of non-degeneracy, one could alternatively leave the recovery rate of a bank without liabilities be unconstrained. Doing so would ensure that a clearing recovery rate vector would always exist. In the example above one such clearing recovery rate vector would be given by  $(r_A, r_B, r_C) = \left(1, \frac{1}{2}, 1\right)$ , where bank  $B$  is given recovery rate  $\frac{1}{2}$  despite having no liabilities. Besides ensuring existence with a less restrictive definition, it is easy to show that the task of computing such a clearing recovery rate vector is in FIXP using the recent framework of Filos-Ratsikas et al. [6]. On the other hand it is not known whether computing an  $\varepsilon$ -approximate clearing recovery rate vector is in PPAD without the non-degeneracy assumption [15].

## B PPAD-membership of $\varepsilon$ -CDS-Clearing

Here we prove PPAD-membership for the version of the  $\varepsilon$ -CDS-CLEARING problem given by the notion of approximation defined in Definition 3.

**Proposition 3.** *The problem  $\varepsilon$ -CDS-CLEARING is in PPAD.*

*Proof.* Define the auxiliary functions  $G: [0, 1 + \varepsilon]^N \rightarrow [0, 1 + \varepsilon]^N$  and  $g: [0, 1 + \varepsilon]^N \rightarrow [0, 1 + \varepsilon]^N$  by

$$G(r)_i = \begin{cases} 1 + \varepsilon & \text{if } a_i(\llbracket r \rrbracket) \geq (1 + \varepsilon)l_i(\llbracket r \rrbracket) \\ \frac{a_i(\llbracket r \rrbracket)}{l_i(\llbracket r \rrbracket)} & \text{if } a_i(\llbracket r \rrbracket) < (1 + \varepsilon)l_i(\llbracket r \rrbracket) \end{cases} \quad (20)$$

and

$$g(r)_i = \frac{a_i(\llbracket r \rrbracket)}{\max\left(\frac{a_i(\llbracket r \rrbracket)}{1 + \varepsilon}, l_i(\llbracket r \rrbracket)\right)}. \quad (21)$$

The function  $g$  is well-defined on the entire domain by the assumption of non-degeneracy. Note also that by definition of  $G$  and  $g$  we have that  $G(r) = G(\llbracket r \rrbracket)$  and  $g(r) = g(\llbracket r \rrbracket)$  for all  $r \in [0, 1 + \varepsilon]^N$ .

By the assumption of non-degeneracy we also have that the function  $g$  is polynomially continuous and polynomially computable, and computing an  $\varepsilon$ -almost fixed point of the function  $g$  (i.e. a point  $r$  such that  $g(r) = r \pm \varepsilon$ ) is in PPAD by [5, Proposition 2.2]. Computing a solution to  $\varepsilon$ -CDS-CLEARING now simply consists of computing an  $\varepsilon$ -almost fixed point  $r$  of  $g$  and letting  $r' = \llbracket r \rrbracket$  be the resulting recovery rate vector. Next we shall prove that  $r'$  is an  $\varepsilon$ -almost fixed point of  $f$  and furthermore satisfies that  $a_i(r') \geq (1 + \varepsilon)l_i(r') \implies r'_i = 1$  for all  $i \in N$ .

Observe first that if  $l_i(r') = 0$ , then  $G(r')_i = g(r')_i = 1 + \varepsilon$  and thus  $r'_i = 1$ . Since also  $F(r')_i = f(r')_i = 1$  we have that both conditions are trivially satisfied.

Assume now that  $l_i(r') \neq 0$ . We then have that  $G(r')_i = \min\left(1 + \varepsilon, \frac{a_i(r')}{l_i(r')}\right) = g(r')_i$ . First note that if  $a_i(r') \geq (1 + \varepsilon)l_i(r')$  then  $g(r')_i = 1 + \varepsilon$  which implies that  $r'_i = 1$ . Since also

$F(r')_i = f(r')_i = 1$  both conditions are again satisfied. Consider now the remaining case of  $a_i(r') < (1 + \varepsilon)l_i(r')$ . Then we have  $g_i(r') = \frac{a_i(r')}{l_i(r')}$  and thus  $r_i = \frac{a_i(r')}{l_i(r')} \pm \varepsilon$ , from which it follows that  $r'_i = \left\lceil \frac{a_i(r')}{l_i(r')} \right\rceil \pm \varepsilon$ . Since  $f(r') = \min\left(1, \frac{a_i(r')}{l_i(r')}\right)$  we again have that the conditions are satisfied. □

## C Financial Network Gadgets for Arithmetic

In this section we describe and analyze financial network gadgets for arithmetic operations. We note that no banks (except implicitly, source and sink banks) have external assets, meaning that they operate correctly in the setting of  $\alpha < 1$ .

**Lemma 3** (Constant gadget [15, Lemma 6]). *For any constant  $\zeta \in [0, 1]$  there exists a financial network gadget with no input bank and output bank  $v$ , such that  $r_v = \zeta$ .*

*Proof.* We argue that the financial network gadget in Figure 10 satisfies the statement. We have  $r_v = \lceil a_v(r) \rceil = a_v(r) = \zeta$ . □

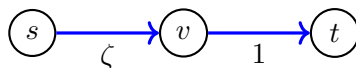

Figure 10: Constant gadget.

**Lemma 4** (Sum gadget [15, Lemma 8]). *There exists a financial network gadget with input banks  $u$  and  $v$  and output bank  $w$ , such that  $r_w = \lceil r_u + r_v \rceil$ .*

*Proof.* We argue that the financial network gadget in Figure 11 satisfies the statement. We have

$$\begin{aligned}
 r_w &= \lceil a_w(r) \rceil \\
 &= \lceil 1 - r_A + 1 - r_B \rceil \\
 &= \lceil 1 - (1 - r_u) + 1 - (1 - r_v) \rceil \\
 &= \lceil r_u + r_v \rceil.
 \end{aligned}$$

□

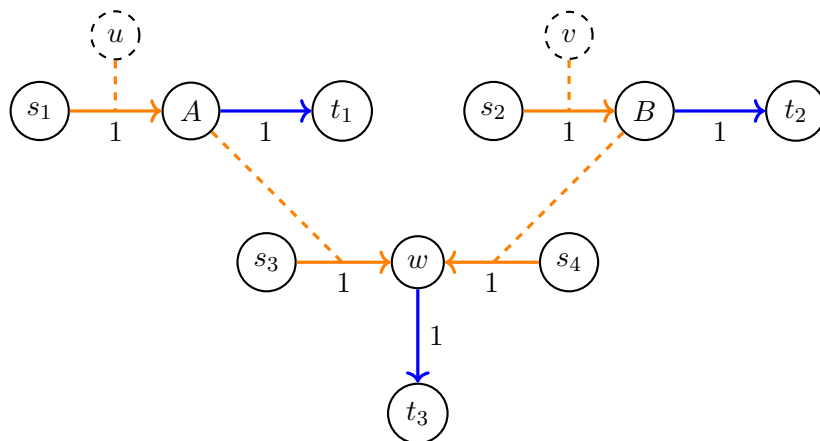

Figure 11: Sum gadget.



**Lemma 5** (Difference gadget [15, Lemma 9]). *There exists a financial network gadget with input bank  $u, v$  and output bank  $w$  such that  $r_w = \llbracket r_v - r_u \rrbracket$ .*

*Proof.* We argue that the financial network gadget in Figure 12 satisfies the statement. We have

$$\begin{aligned}
r_w &= 1 - r_B \\
&= 1 - \llbracket (1 - r_A) + (1 - r_v) \rrbracket \\
&= 1 - \llbracket 1 - (1 - r_u) + (1 - r_v) \rrbracket \\
&= 1 - \llbracket 1 - (r_v - r_u) \rrbracket \\
&= \llbracket r_v - r_u \rrbracket
\end{aligned}$$

□

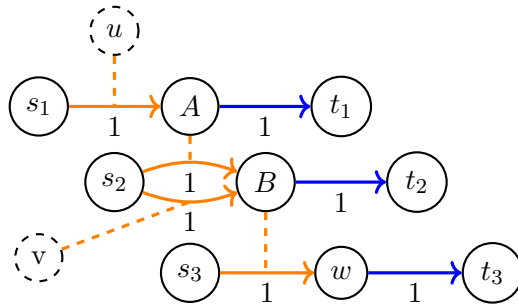

Figure 12: Difference gadget.

For multiplication, Ioannides [8] give a simple, but *degenerate*, financial network gadget, and afterwards modify it to a non-degenerate gadget computing the expression  $(r_u(1 + r_v))/4$ . We give a slightly different and arguably simpler gadget below, that also avoids having banks (other than source or sink banks) with external assets.

**Lemma 6** (Multiplication gadget). *There exists a financial network gadget with input banks  $u$  and  $v$  and output bank  $w$ , such that  $r_w = r_u r_v / 2$ .*

*Proof.* We argue that the financial network gadget in Figure 13 satisfies the statement. First we have that  $r_A = 1 - r_u$  and  $r_B = 1 - r_v$ . It follows that

$$r_C = \frac{1 - r_A}{1 + (1 - r_v) + (1 - r_B)} = \frac{r_u}{1 + (1 - r_v) + r_v} = \frac{r_u}{2},$$

and finally we have

$$r_w = r_C(1 - r_B) = r_u r_v / 2.$$

□

We may use the addition gadget of Lemma 4 together with the multiplication gadget of Lemma 6 to get a “proper” multiplication gadget computing the expression  $r_u r_v$ .

## D Infeasibility gadget

In this section we describe a special case of the infeasibility gadget constructed by by Schuld-zucker et al. [15]. The gadget is based on a *cut-off gadget* and an *OR gadget*.

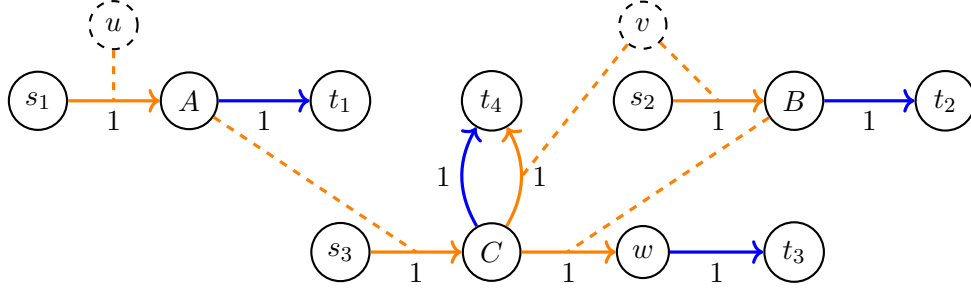

Figure 13: Multiplication gadget.

**Lemma 7** (Cut-off Gadget [15, Lemma 3]). *There exists a financial network gadget with input bank  $u$  and output bank  $v$ , such that*

$$\begin{aligned} r_u \leq K &\implies r_v = 0 \\ r_u \geq L &\implies r_v = 1. \end{aligned}$$

*Proof.* We argue that the financial network in Figure 14 satisfies the statement. Assume  $r_u \leq K$ . Then  $p_{s,A} \geq \frac{1}{1-K}(1-K) = 1$ , so  $A$  does not default, causing  $r_v = 0$ . Now assume  $r_u \geq L$ . This means  $r_A \leq \frac{1-L}{1-K}$ , so  $r_v \geq \frac{1-K}{L-K} \left(1 - \frac{1-L}{1-K}\right) = 1$ .  $\square$

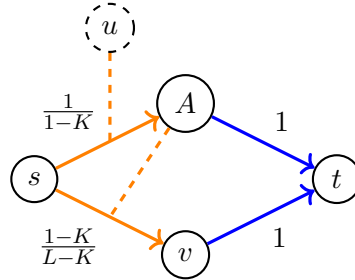

Figure 14: Cut-off gadget.

**Lemma 8** (OR Gadget [15]). *There exists a financial network gadget with input banks  $u, v$  and output bank  $w$ , such that*

$$\begin{aligned} r_u \leq \frac{1}{4} \wedge r_v \leq \frac{1}{4} &\implies r_w = 0, \\ r_u \geq \frac{3}{4} \vee r_v \geq \frac{3}{4} &\implies r_w = 1. \end{aligned}$$

*Proof.* First, we use two cut-off gadgets from Lemma 7 with input banks  $u, v$  and output banks  $u', v'$ , respectively, and with  $K = \frac{1}{4}$ ,  $L = \frac{3}{4}$ . Now,  $r_{u'} = 0$  if  $r_u \leq \frac{1}{4}$  and  $r_{u'} = 1$  if  $r_u \geq \frac{3}{4}$ . The same holds for  $v, v'$ . Next, we use  $u', v'$  as input banks to a sum gadget from Lemma 4. From this lemma, we get that

$$r_w = \begin{cases} 0 & \text{if } r_{v'} = r_{u'} = 0 \\ 1 & \text{if } r_{v'} = 1 \vee r_{u'} = 1 \end{cases}$$

$\square$

With these gadgets in place we can now describe and analyze the infeasibility gadget.

*Proof of Lemma 1.* We argue that the financial network in Figure 15 satisfies the statement when the cut-off gadget has  $K = \frac{3\alpha+1}{4}$  and  $L = \frac{\alpha+3}{4}$ .

First let us assume  $r_u \geq \frac{3}{4}$ . Then the OR gadget with output bank  $A$  has  $r_A = 1$ , so  $r_B = \frac{4\alpha}{5}$ , and  $r_C = 0$  giving us a clearing recovery rate vector. Now, let us assume  $r_u \leq \frac{1}{4}$ . We wish to argue by contradiction that no clearing recovery rate vector exists. If  $r_B = 1$ , then  $r_A = 1$  per the cut-off and OR gadgets, and thus  $p_{s,B} = 0$ , so  $B$  is in default. This is a contradiction. If  $r_B < 1$ , then

$$\begin{aligned}
r_B &= a'_B(r) \\
&= \alpha e_B + p_{s,B} \\
&= (1 - 1 + \alpha)e_B + p_{s,B} \\
&= e_B + p_{s,B} - e_B(1 - \alpha) \\
&= a_B(r) - e_B(1 - \alpha) && \text{(since } a_B(r) = e_B + p_{s,B}\text{)} \\
&< 1 - e_B(1 - \alpha) && \text{(since } r_B < 1 \text{ we have } a_B < l_B = 1\text{)} \\
&= 1 - \frac{4}{5}(1 - \alpha) \\
&= \frac{4\alpha + 1}{5} \\
&\leq \frac{3\alpha + 1}{4} \\
&= K.
\end{aligned}$$

Thus by the cut-off gadget  $r_C = 0$ , and thus  $r_A = 0$  (since  $r_u \leq \frac{1}{4}$ ). This means  $p_{s,B} = \frac{4}{5}$ , but this means  $B$  is not in default. We again get a contradiction. Thus we conclude no clearing recovery rate vector exists.  $\square$

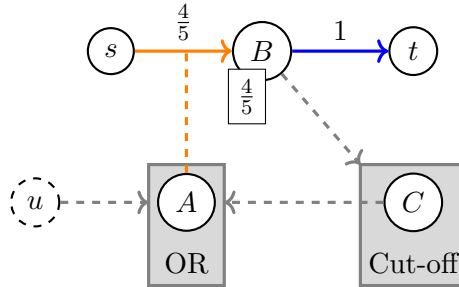

Figure 15: Infeasibility gadget. The cut-off gadget has input bank  $B$  and output bank  $C$ . The OR gadget has input banks  $u, C$  and output bank  $A$ .