

Cancellable Memory Requests: A transparent, lightweight Spectre mitigation

Hossam ElAtali
University of Waterloo
hossam.elatali@uwaterloo.ca

N. Asokan
University of Waterloo
asokan@acm.org

Abstract—Speculation is fundamental to achieving high CPU performance, yet it enables vulnerabilities such as Spectre attacks, which remain a significant challenge to mitigate without incurring substantial performance overheads. These attacks typically unfold in three steps: they speculatively access sensitive data (access), alter the cache state (transmit), and then utilize a cache timing attack (e.g., Flush+Reload) to extract the secret (receive). Most Spectre attacks exploit a cache timing side channel during the transmit and receive steps. Our key observation is that Spectre attacks do not require the transmit instruction to complete before mis-prediction is detected and mis-speculated instructions are squashed. Instead, it suffices for the instruction to execute and dispatch a request to the memory hierarchy. Responses from memory that arrive after squashing occurs still alter the cache state, including those related to mis-speculated memory accesses. We therefore propose a novel mitigation technique, Cancellable Memory Requests (CMR), that *cancels* mis-speculated memory requests. Immediately upon squashing, a cancellation is sent to the cache hierarchy, propagating downstream and preventing any changes to caches that have not yet received a response. This reduces the likelihood of cache state changes, thereby reducing the likelihood of Spectre attacks succeeding. We implement CMR on gem5 and show that it thwarts practical Spectre attacks, and has *near-zero performance overheads*. We show that CMR can completely thwart Spectre attacks in four real-world processors with realistic system configurations.

1. Introduction

Speculation is a fundamental technique employed in modern processors to optimize performance by predicting and executing instructions ahead of their actual need. But it has also led to the emergence of critical security vulnerabilities, exemplified by Spectre attacks [1]. Despite efforts to mitigate it, Spectre remains a relevant threat, challenging the balance between security and performance.

Spectre attacks exploit speculative execution to leak sensitive information, such as cryptographic keys. They train the central processing unit (CPU)’s branch prediction mechanism and then use it to transiently access architecturally-inaccessible secrets in memory. The transient part of the attack consists of three steps: accessing the secret, transmitting

it through a side channel (e.g., changing cache state), and receiving/extracting it from the side channel (e.g., probing cache state). Notably, the transmit step, which involves sending a request to the memory hierarchy, does *not need to complete within the speculation window* for the attack to succeed. Even after speculation ends and mis-speculated instructions are *squashed*, responses received from memory can alter the cache state, facilitating information extraction.

We present a novel mitigation approach for Spectre attacks based on the key observation that *canceling the request to the memory hierarchy immediately upon squashing the transmit instruction can significantly reduce the likelihood of any changes to the cache state*, thereby thwarting the attack. Our approach only requires changes to the load-store unit and caches. It is applicable to any instruction set architecture (ISA) and is *transparent to software and external hardware interfaces*, requiring no changes to either. We implement it in gem5 and evaluate its efficacy against various Spectre proofs-of-concept (PoCs), showing that it has negligible performance overheads. Furthermore, we provide a systematic security analysis to show how system parameters can be configured to provide strong security guarantees.

Our contributions are:

- 1) Cancellable Memory Requests (CMR), an **ISA-agnostic** mechanism for cancelling outstanding requests to memory upon squashing, requiring **no changes to software or external hardware interfaces** (Section 4),
- 2) an implementation of CMR in gem5 (Section 5)¹,
- 3) case studies showing that CMR is **effective** against several Spectre PoCs (Section 6),
- 4) a security analysis of CMR, identifying the factors that determine its effectiveness and showing that with realistic system configurations in four real-world processors, CMR can **completely thwart Spectre attacks** (Section 7), and
- 5) a performance evaluation showing **negligible performance overheads** (Section 8).

1. We will open-source the implementation.

2. Background

2.1. CPU caches

Caches are small, high-speed memory structures situated closer to the CPU cores compared to main memory. They are designed to store frequently-accessed data and instructions, thus reducing the time the CPU needs to fetch this information from the slower main memory. This mechanism is critical for improving the performance of a computer system.

Data is stored in caches in chunks called “lines” or “blocks”, usually 64 bytes in size. Each cache line stores the data itself as well as a tag that identifies which address the data belongs to. When a cache receives a memory request, it searches its tags for one matching the request. If a match is found, this is called a “cache hit”, and the cache can respond with the data. Otherwise, a “cache miss” has occurred and must be handled by a miss status holding register (MSHR). MSHRs are in charge of keeping track of outstanding misses, issuing requests downstream, and servicing the misses once a response is received. Each MSHR is in charge of a single tag (i.e., 64-byte aligned address). Multiple misses with the same tag are added as “targets” to the same MSHR. Concretely, if there is already an outstanding MSHR with the same tag, the miss is added to it as an additional target. Once a response is received for this MSHR, all its targets are serviced. If there is no matching outstanding MSHR, an empty MSHR is allocated to the miss. Caches have a fixed number of MSHRs; if there are no empty MSHRs to handle the miss, the cache must reject the request until one is freed.

2.2. Cache timing attacks

Cache timing attacks exploit variations in the time it takes for a CPU to access cached vs. uncached data. A cache hit takes less time to complete than a cache miss. An attacker can compare the time it takes to access a certain address against a threshold to determine whether the data at this address was cached or not. If a victim process uses secret-dependent memory addresses, this can leak information about the secret to the attacker. Flush+Reload [2] and Prime+Probe [3] are prominent cache timing attacks.

2.3. Speculation

Modern processors employ speculative execution to improve performance by predicting and executing instructions ahead of time. This allows the processor to continue processing instructions even when there is a branch instruction whose outcome is uncertain. The *speculation window* refers to the period during which instructions are executed speculatively. The larger the speculation window, the more instructions that can be executed before a squash occurs.

2.4. Spectre

Spectre [1] attacks are a class of side-channel attacks that exploit speculative execution. They use speculative loads to

leak sensitive information across security boundaries. By manipulating the CPU’s branch prediction mechanism, an attacker can force the execution of speculatively loaded instructions that access sensitive data. Even though these instructions are eventually discarded, they can leave traces in the cache that can be exploited to infer the sensitive data. In other words, speculatively executed memory accesses can cause *persistent changes to cache state*.

3. Problem description

3.1. Goals & Objectives

Ideally a mitigation against Spectre attacks must satisfy:

R1—Performance: *incur minimal performance overhead.*

R2—Software Compatibility: *require no changes to software and be fully compatible with existing program binaries.*

R3—Hardware Compatibility: *require no changes to external interfaces (e.g., DRAM) or hardware components, other than the CPU.*

R4—ISA Compatibility: *not require ISA-specific functionality, making it applicable to any ISA.*

R5—Effectiveness: *significantly reduce leakage of secret data through cache state changes.*

For R5, we define a *cache change* metric CC , in Equation (1), to measure the effectiveness against Spectre:

$$CC = \frac{\sum_i^K N_i \times (K - i + 1)}{N_{total} \times \sum_i^K i} \quad (1)$$

K is the number of cache levels in the system. N_{total} is the total number of squashed access and transmit instructions in a Spectre program. N_i is the number of squashed access and transmit instructions that cause a change in the i^{th} cache. We assign more weight to changes to caches closer to the CPU because they are easier to exploit in a cache timing attack [4]. CC can be in the $[0,1]$ range. Any non-zero value implies that Spectre attacks may succeed.

3.2. Threat model

We consider the strongest Spectre threat model, where the attacker and the victim execute within the same process, sharing the same address space and having the same process context. In this scenario, the attacker is unable to directly access the victim’s secret (e.g., due to in-process isolation mechanisms such as sandboxing), but is able to train the branch predictor to access the secret speculatively. This corresponds to “same-address in-place” (SA-IP) as defined by Canella et al [5]. A defense that works under this strong

threat model, is also secure under weaker threat models such as where the attacker and victim are in different processes.

4. CMR: Design

As the name suggests, the idea behind CMR is to issue cancellations to outstanding speculative memory requests as soon as they are squashed. Whenever a cache receives a cancellation for an outstanding request, it drops the request from its MSHRs (and ignores any responses it receives for it in the future), and, if appropriate, forwards the cancellation to caches downstream. The goal is to reduce the number of changes to the cache hierarchy by cancelling the request and forwarding the cancellation to caches as soon as possible.

The final effect of the cancellation depends on the state of the memory request/response within the cache hierarchy at the time the cancellation is sent. We present all possible cases in Figures 1a to 1c. In the best case, Figure 1a, the cancellation reaches the last-level cache (LLC), L2, before it receives a response from memory. This prevents any changes to the cache hierarchy as any response received by the LLC from memory is ignored, and subsequently, the LLC does not provide any further responses to caches upstream (which have already cancelled the request and the corresponding evictions themselves).

In the worst case, Figure 1c, the cancellation is either never made (because the response is received by the CPU core before the speculation window ends), or is made but reaches the L1 cache after it has received a response. If the CPU has more than one cache level, other intermediate cases between Figure 1a and Figure 1c can occur. This is depicted in Figure 1b, where the cancellation reaches the L1 cache but not L2, before the response. In this case, only L2 is modified by the request. If this request is from a Spectre transmit instruction, cache timing attacks that target the L1 caches will not succeed; only those targeting the LLC will be able to extract the secret.

4.1. Cache flow chart

Figure 2 shows the flow chart for caches supporting CMR. CMR works with any cache coherence protocol. Beside the addition of handling cancellations, which is only relevant when a cache has an outstanding request to the level below it, the rest of the coherence protocol remains unchanged. Outstanding requests can either be reads (if the block is currently in the invalid state) or upgrades (if the block is valid, but does not have the required permissions, e.g., writable). Therefore, as soon as we receive a cancellation, we only need to check whether there is a corresponding MSHR (MatchMSHR, Section 4.1.1), and if so, remove the cancelled request from it. If the MSHR then becomes empty (i.e., there are no other requests waiting for this cache block), we can send a cancellation to the lower cache level. For responses, if a matching MSHR is not found, the response is discarded (Section 4.1.2).

4.1.1. MatchMSHR. MatchMSHR searches the MSHR queue for a matching MSHR, i.e., one that has the same cache block address. The circuitry to perform this search already exists in modern caches. It is required to check if incoming misses match an outstanding MSHR, and coalesce requests to the same block. It is possible for cancellations to find no matching MSHR. This can happen due to simultaneous transfers of responses and cancellations.

Simultaneous response and cancellation. Cache buses can have several channels, allowing simultaneous bidirectional communication, e.g., TileLink [6] or Arm AMBA CHI [7]. This means that a cancellation can be received while a response is being sent. This can occur in two cases: 1) if the original request hits in this cache, or 2) the original request misses, but, before the cancellation arrives, the cache receives a response and the MSHR is serviced and freed. The cancellation in both cases will have no corresponding MSHR and therefore must be discarded. An MSHR search is required to detect this.

4.1.2. CheckMSHR. Without CMR, MSHRs are locked to a single downstream request until a response is received. The downstream request contains an MSHR index which is copied into the response by the downstream cache. This makes it easy to determine the exact MSHR corresponding to a response. With CMR, this assumption no longer holds. The cache must double-check the designated MSHR when receiving a response to ensure that it has not been freed and possibly reassigned to another block. This can happen either due to simultaneous response and cancellation transfer (Section 4.1.1), or due to responses from memory.

Responses from memory. CMR does not require any modifications to DRAM or the memory controller (satisfying R3). Cancellations are not supported on the memory bus; LLCs must therefore not forward cancellations to memory. Thus, a request from the LLC to memory will eventually receive a response, even if it is cancelled in all caches. The LLC must be able to detect whether the MSHR designated in the response still corresponds to the original request.

4.2. Forwarding cancellations upstream

Consider the case in Figure 3a. Cache A requires the data at address x and sends a request downstream to fetch it. However, this data has been modified in cache B and has not been written back yet. Cache coherence protocols are charged with ensuring that cache A obtains the up-to-date value from cache B. Different protocols use different mechanisms to do this, but are mainly split into two groups: snooping-based and directory-based.

4.2.1. Snooping. In snooping protocols, caches can “snoop” the bus to detect requests that require their intervention. For example, in Figure 3a, cache B would snoop the bus and detect that the request sent from cache A to cache C requires it to send its up-to-date value before cache C responds. Snooping is usually done using additional circuitry and can even span multiple cache levels. For CMR, this circuitry can

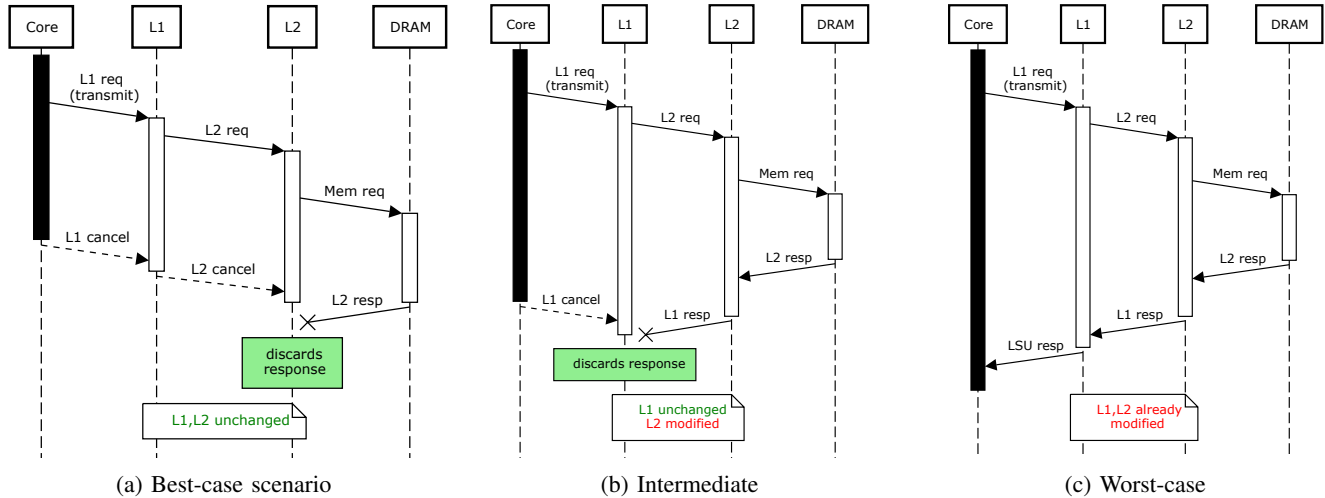

Figure 1: The solid black activation bar under the core represents the speculation window. The hollow activation bars under the caches represent the lifetime of the request’s MSHR. The hollow activation bar under the DRAM represents the memory-only access latency.

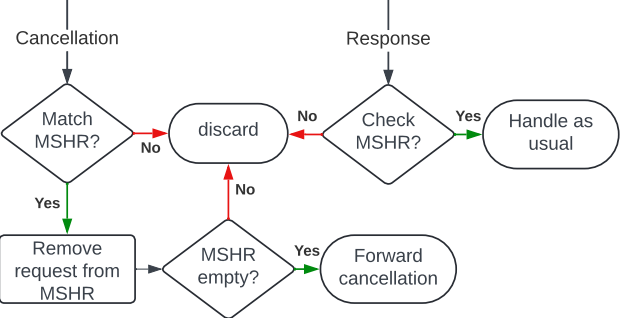

Figure 2: Handling cancellations and responses with CMR.

also be used to snoop on cancellations. Snooping cancellations is required because of the scenario in Figure 3b. When cache B receives a write request for x ①, it allocates an MSHR ② and sends an exclusive read request to cache C ③. If cache A then sends a read request for x to cache C ④, cache B must snoop this request, add cache A’s request as a target to the MSHR, and inform cache C not to respond to cache A. Once cache B receives a response for the exclusive read, it performs the write and sends the *new value* to cache A. Therefore, adding cache A’s request to cache B’s MSHR is crucial to ensure proper memory ordering². With CMR, if cache A’s request is cancelled before cache B gets its response, cache B must snoop the cancellation sent to cache C and remove the target snoop corresponding to cache A’s request from the MSHR.

4.2.2. Directory. In directory-based protocols, a directory tracks the caches holding each block. For the example in

2. Some memory consistency models might not require this ordering to hold. This would reduce the complexity of handling cancellations, but we do not consider them here.

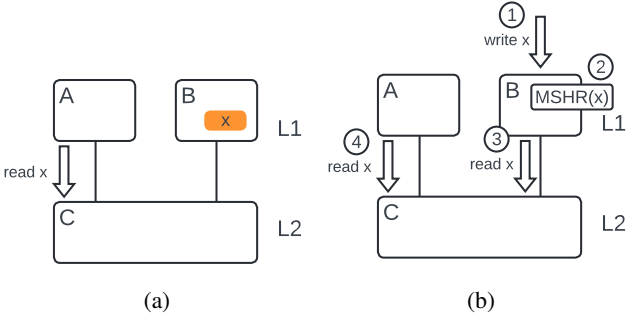

Figure 3: Examples showing why cancellations must also be forwarded upstream. Figure 3a shows a case where B has the most up-to-date value and must provide it to A to maintain cache coherence. Figure 3b shows how a request from A can be added to an MSHR in B, and therefore why a cancellation must go to B if A’s request is cancelled.

Figure 3a, cache C can consult its directory and know that cache B has an entry for x . Depending on the exact coherence protocol, it either already knows that cache B has modified x or must send a message upstream to cache B to check for modifications. For Figure 3b, once cache C receives a cancellation for cache A’s request, it must consult its directory and forward this cancellation to all caches with an outstanding MSHR that has a corresponding target.

4.3. Invalidations

Loads and stores are treated identically when the requested block is not present. When the block is present but not writable (e.g., it is shared among several sibling caches) and a store instruction is executed, the cache must upgrade the block to a writable state. This is done by sending an

invalidation request, which invalidates all other copies in sibling caches.

Cancellations can also be applied to invalidation requests when the corresponding instruction is squashed. However, to the best of our knowledge, all existing cache timing attacks rely on the timing difference between a block being in the invalid state vs. the present state (regardless of permissions). Therefore, cancelling load requests alone can be sufficient to prevent existing Spectre attacks, which we demonstrate in Section 6. Nevertheless, CPU architects can future-proof their design by opting to cancel invalidations, in exchange for increased design complexity. The mechanism for doing this depends on whether the cache uses a snooping or a directory-based coherence protocol, and uses the same mechanisms highlighted in Sections 4.2.1 and 4.2.2.

4.4. Evictions

While it might seem that evictions pose a problem, this is not true. Evictions are completed when the replacement (i.e., response) arrives, rather than when the MSHR is first assigned: cancellations also cancel the corresponding evictions, preventing *any* changes to cache state.

5. CMR: Implementation

We implement CMR on gem5 [8], a cycle-accurate computer system simulator. gem5 includes a speculative out-of-order (OoO) CPU model, O3, and supports arbitrary cache configurations. It provides two separate cache hierarchy implementations: classic and ruby. Ruby caches are newer and allow configurable cache coherence protocols. However, they currently do not support cache maintenance operations, such as flushing, and therefore cannot be used with the Flush+Reload cache timing attack. As this is the attack used by all of the publicly available Spectre PoCs, we choose to implement CMR on the classic caches instead.

5.1. Classic caches

The downside of classic caches is that they have a fixed snooping-based cache coherence protocol. Since CMR is orthogonal to the coherence protocol, as we explained in Section 4, this is not a concern. We implement snooping of cancellations as described in Section 4.2.1.

5.1.1. MatchMSHR & CheckMSHR. The functionality for MatchMSHR already exists for handling cache misses. We use the same latency of searching the MSHR queue for cancellations. CheckMSHR adds new functionality. However, since no search is required, only a simple check, we assume it is combinational logic and can be performed in the same cycle. CheckMSHR thus incurs no additional latency.

5.2. O3 CPU

In addition to modifying the caches, we add CMR support to gem5’s O3 model. Whenever an instruction is

squashed, the load-store unit checks if there are any outstanding memory requests for the instruction, and if so, sends a cancellation to the cache hierarchy. Note that we do not make any changes to ISA-specific CPU models; CMR is ISA-agnostic, satisfying R4.

5.3. Limitations

We do not implement invalidation cancellation (Section 4.3). We only implement cancellation of squashed loads, not stores. As we show in Section 6, this is sufficient to stop all Spectre PoCs.

6. Security evaluation – Case studies

We present two Spectre variants as case studies to empirically show the effectiveness of CMR. We perform a deep-dive into the first case study (Section 6.1) to show the CPU events that occur throughout a Spectre attack and how CMR affects them. For the second case study, we only report our findings for brevity; the attacks use the same access-transmit-receive mechanism. Note that since cancellations can be used for any squashed memory request, regardless of the speculation condition, CMR is equally applicable to all Spectre variants.

All PoCs define a secret string that is the target of the attack. For each character of the string, all PoCs continue attempting to leak the character until the extracted value matches certain criteria. This means that when attacks are successful, the program terminates quickly. On the other hand, if attacks are never successful, the program runs until it times out. The default timeout periods for the PoCs are infeasibly long when run on gem5. We therefore shorten all timeouts to allow the simulation to complete in a reasonable amount of time. To ensure a fair comparison, we verify that, without CMR, both PoCs are still able to leak the secret using the shortened timeouts.

6.1. Google SafeSide – Spectre PHT

SafeSide [9] is a code repository by Google that contains several Spectre and Meltdown [10] PoCs. For this case study, we use the `spectre_v1_pht_sa` PoC, which mistrains the pattern history table (PHT) and then exploits it to achieve a bounds check bypass (BCB). The PHT is a component of the CPU’s branch predictor that is in charge of guessing whether a branch will be taken.

6.1.1. PoC overview. A snippet of the PoC is shown in Listing 1. It works as follows.

- 1) Flush the cache (line 6).
- 2) Execute an array bounds check with an in-bound index (line 12), and perform an array access using this index (lines 13-14). This represents a taken branch.
- 3) Execute steps 1-2 many times (line 5). This trains the PHT to guess “taken” on following speculations.

```

1 for (int run = 0;; ++run) {
2   timing_array.FlushFromCache();
3   int safe_offset = run % strlen(data);
4
5   for (size_t i = 0; i < 2048; ++i) {
6     FlushDataCacheLine(size_in_heap.get());
7
8     size_t local_offset =
9       offset + (safe_offset - offset) *
10      static_cast<bool>((i + 1) % 2048);
11
12    if (local_offset < *size_in_heap) {
13      ForceRead(
14        &timing_array[data[local_offset]]);
15    }
16  }
17
18  int ret = timing_array.
19    FindFirstCachedElementIndexAfter(
20      data[safe_offset]);
21  if (ret >= 0 && ret != data[safe_offset]) {
22    return ret;
23  }
24
25  if (run > 100) {
26    std::cerr << "Does not converge"
27      << std::endl;
28    exit(EXIT_FAILURE);
29  }
30 }

```

Listing 1: C code extract for spectre_v1_pht_sa PoC.

```

1 # bounds check
2 404bec: jae    404bbf <main+0xca>
3 404bee: movsbq 0x0(%r13,%rax,1),%rax
4 404bf4: imul  $0x71,%rax,%rax
5 404bf8: add   $0x64,%rax
6 # access secret: data[local_offset]
7 404bfc: movzbl %al,%eax
8 404bff: add   $0x1,%rax
9 404c03: mov   %rax,%rsi
10 404c06: shl  $0x6,%rsi
11 404c0a: add  %rsi,%rax
12 404c0d: shl  $0x6,%rax
13 404c11: add  0x28(%rsp),%rax
14 # transmit: timing_array[secret]
15 404c16: movzbl (%rax),%eax
16 404c19: jmp  404bbf <main+0xca>

```

Listing 2: x86 assembly extract for spectre_v1_pht_sa PoC.

- 4) Flush the cache.
- 5) Execute step 2 with an out-of-bounds index (lines 12-14, $i=2047$). Since the PHT has been mis-trained, the access to the secret will be executed speculatively. Once the check is actually complete, the CPU realizes that the speculation was incorrect

and squashes the speculative instructions.

- 6) Probe the cache using Flush+Reload to extract the secret (line 18).
- 7) Move onto next character in secret string if our criteria are met; otherwise, repeat all steps until timeout occurs. Here, our criteria are that 1) Flush+Reload detects a timing below a predetermined threshold (indicating a hit caused by a prior speculative access), and 2) the extracted value is not from an in-bound access.

The x86 disassembly of the speculatively executed instructions is shown in Listing 2. Instructions on lines 2-12 are executed speculatively until the failed bounds check on line 1 is detected and the instructions are squashed. Before the squash occurs, the secret is accessed (line 7) and then transmitted across a side channel by modifying the cache state (line 15). Extracting the secret from the cache state is done non-speculatively afterwards.

We now describe four experiments to evaluate the PoC with and without CMR.

Parameter	C1	C2
Core count	2	2
Core frequency (GHz)	3	0.1
L1D/I size (kB)	32	32
L1D/I associativity	8	8
L1D/I latency (cycles)	4	80
L2 size (kB)	512	512
L2 associativity	16	16
L2 latency (cycles)	14	80

TABLE 1: Configurations used in case study experiments. For C1, realistic values are used for L1 and L2 based on Intel IceLake [11]. C2 is modified from C1 to intentionally make CMR ineffective. In both configurations, each core has private L1D and L1I caches and shares the L2 cache. For main memory, we use the dual channel DDR4-2400 model provided by gem5 with a size of 3GB.

6.1.2. Experiment 1 – C1, Baseline. We first run the PoC in gem5 using the O3 model without CMR enabled. We use the C1 gem5 configuration shown in Table 1. We find that the entire secret string (“It’s a s3kr3t!!!”) is extracted and printed to console. We dump all load-store unit and cache events from gem5, and identify and extract events related to pairs of the access and transmit instructions in Listing 2. Each pair represents a single Spectre attack. Figure 4 contains a plot of relevant events for the transmit instruction of each attack. The plot shows that for all attacks where the transmit instruction is executed, the squash occurs before any response is returned to the LLC. Furthermore, in almost all of those cases, there is a significant delay between the squash occurring, and the LLC receiving a response. This provides an opportunity for cancellations, and hints that CMR might prevent this attack. We test this in our next experiment. Exceptions to this are the cases highlighted with a black box. These can pose a problem because cancellations might not reach the L2 cache in time

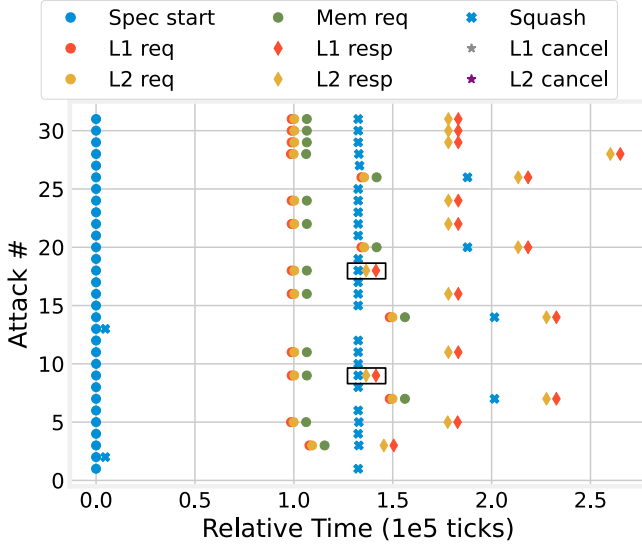

Figure 4: CPU events for **transmit** instructions of all Spectre attack instances from **Experiment 1**. Each row represents a single attack, the y-axis showing the attack number. All event times are relative to speculation start: for each attack, events are shifted to make speculation start at $t=0$.

before the response from memory. We do not find this in our following experiments with C1, but we force this situation to occur in Experiment 4 (Section 6.1.5).

Note that for attack 1 ($y = 1$ in Figure 4), the transmit instruction is never executed. This occurs because the secret is not yet cached and the access instruction does not complete in time to allow the transmit instruction to execute. Subsequent attacks (e.g., attack 3), however, can access the secret more quickly since it has been cached and therefore have enough time to execute the transmit instruction. In the case of attack 3, the access instruction misses in the L1 cache but hits in the L2 cache.

6.1.3. Experiment 2 – C1, CMR enabled. We run the PoC with C1 and CMR enabled, and indeed find that the program times out without extracting any secret characters. We again extract all relevant events, including those related to cancellations. Upon analysis, we make an interesting discovery: *no transmit instructions are executed*. Upon further investigation, we find that this occurs because CMR cancels the *access instructions*, preventing even the first step of the attack. Throughout the entire execution, the PoC only manages to find the secret in the L1D cache twice, and in both cases, speculation ends before the transmit instruction is executed. In all other cases, the attack has the same result as attack 1 in Experiment 1 (Figure 4). We show this effect in Figure 5, where we plot the events for the access instructions instead. The plot shows that the access instruction hits in the L1D cache only twice. Note that because the PoC times out in this experiment, the total number of attacks (102) is much larger than that for Experiment 1 (31). However, for clarity, we only plot attacks #1–31 in Figure 5.

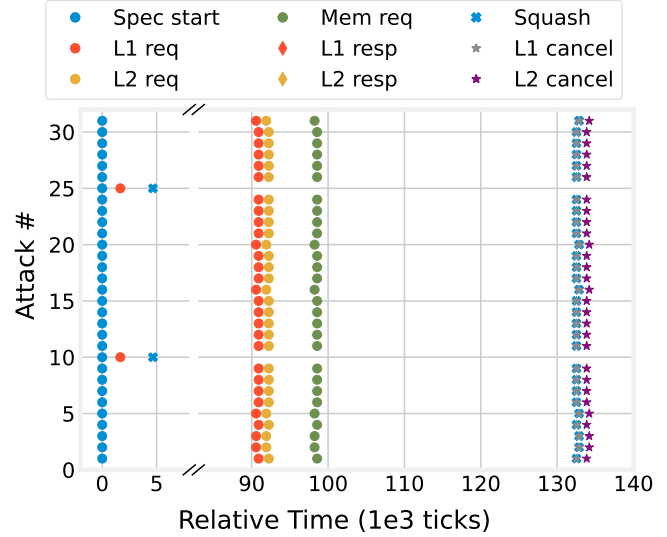

Figure 5: CPU events for **access** instructions of Spectre attacks #1–31 from **Experiment 2**. Attacks #32–102 are not shown. Note the **break** in the x-axis. The cancellations have the same latency as regular requests. Typically, cancellations reach both L1 and L2 caches before a response is received. The secret is thus almost never cached in a Spectre attack.

6.1.4. Experiment 3 – C1, CMR enabled, secret cached.

In this experiment, we want to test the effectiveness of CMR even when the secret is cached and the access instruction completes. We modify the PoC to access the secret non-speculatively on every iteration. Running the PoC again results in a timeout with no secrets leaked. Upon analysis of the extracted events, we confirm that the access instructions now hit in the L1 cache, and the transmit instructions execute. We show all relevant events for the transmit instructions in Figure 6.

Despite the execution of the transmit instructions, no Spectre attack succeeds. This is because, as shown in Figure 6, the cancellations always reach the caches before the response. This is true for even the last-level L2 cache, hence preventing any changes to the cache state.

6.1.5. Experiment 4 – C2, CMR enabled, secret cached.

In this experiment, we intentionally change the system configuration to C2 to reduce the effectiveness of CMR. We drastically increase the L1 and L2 latencies, and reduce the CPU clock frequency to 100MHz. Reducing the clock frequency effectively increases the speculation window size in wallclock time. This is because the speculation window size in instructions, and therefore cycles, remains the same but the period of each clock cycle becomes longer. Since main memory uses a separate clock, the latency of responses from memory to L2 does not increase as much, making them more likely to arrive within the speculation window.

Running the modified Spectre PoC (with secret caching as in Experiment 3), we find that the entire secret is indeed extracted. Figure 7 shows the events obtained from the

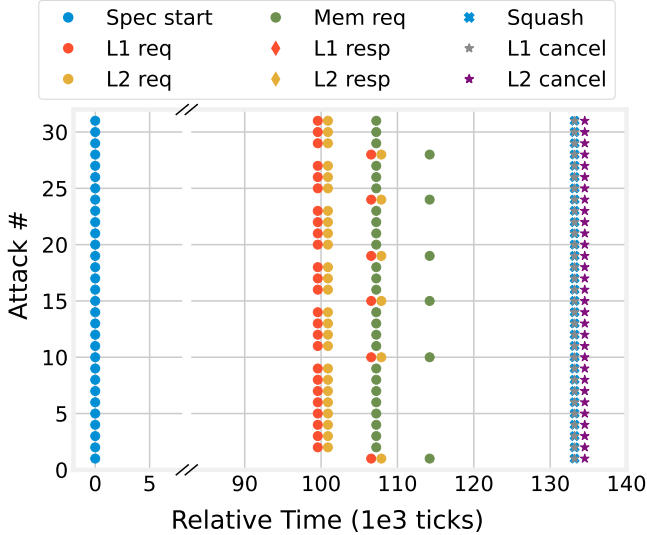

Figure 6: CPU events for **transmit** instructions of attacks #1–31 from **Experiment 3**. Note the break in the x-axis. The cancellations have the same latency as regular requests. In all cases, cancellations reach both L1 and L2 caches before a response is received. The transmit instruction thus never succeeds in changing the state of the caches.

experiment. The key change, highlighted with a black box, compared to Figure 6 is that the response reaches L2 before the cancellation. This is not the case for L1; however, the cache state change in L2 alone is sufficient for the extract step of the Spectre attack to succeed. This is due to the large difference in hit access latencies for L1 and L2 (80 vs. 160, respectively) caused by the large latencies used for C2.

Note that in this experiment, the PoC requires fewer attacks to extract the secret compared to Experiment 1. This is because we use the modified PoC where we intentionally cache the secret before each Spectre attack.

6.1.6. Effectiveness. In this section, we calculate the cache change metric, CC , from Equation (1) for all experiments. We show the results in Table 2. For experiment 1, we get a value of 1. This is because CMR is not enabled and any transmit instruction executed results in changes to all caches. For experiments 2 and 3, we get a value of 0 because no cache changes occurred. Experiment 4 shows that when transmit instructions manage to cause a partial change to cache state, the value of CC is between 0 and 1.

Experiment	N_1	N_2	N_{total}	CC
1	29	29	29	1
2	0	0	104	0
3	0	0	204	0
4	0	15	32	0.234

TABLE 2: The values of CC for all experiments.

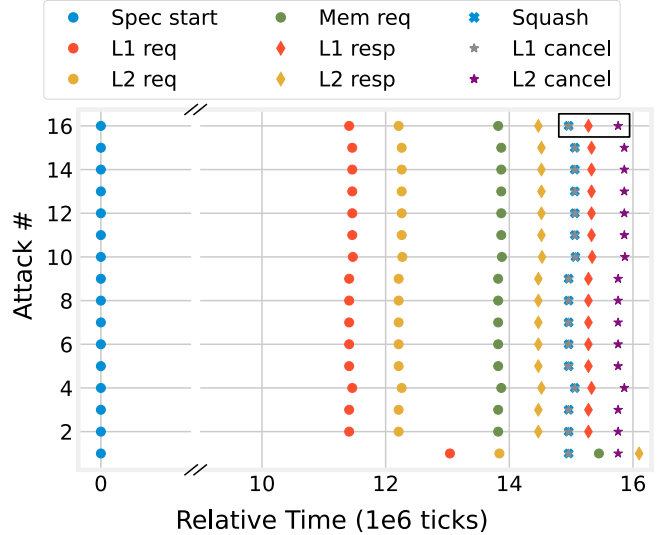

Figure 7: CPU events for **transmit** instructions of all attacks from **Experiment 4**. Note the break in the x-axis. In all but the first attack, the cancellation reaches L2 only after the response from memory has been received.

6.2. Google SafeSide – ret2spec

As in the previous section, we evaluate CMR on the `ret2spec_sa` PoC and verify that it thwarts the attack, i.e., no part of the secret is leaked. Ret2spec, also called Spectre-RSB [5], [12], targets the return stack buffer (RSB), which predicts the addresses of return instructions. Ret2spec exploits the fact that the RSB has a limited number of entries, and must remove addresses once it is filled due to deeply nested functions, causing mispredictions of the return addresses. These mispredictions lead to speculatively executed instructions that are abused by ret2spec to leak the secret.

7. Security evaluation – Analysis

In this section, we present a systematic analysis of CMR’s security to help us understand how to architect a system that increases its effectiveness. Consider Figure 8, where s_0-s_N are speculatively executed instructions and s_n is the Spectre transmit instruction. We define all relevant symbols in this section in Table 3 for convenience. A Spectre transmit step fails to modify the state of caches up to L_i if, and only if, Inequality 2 is satisfied. The squash latency, T_S , is the time it takes to squash the transmit instruction after it has executed. The cancellation latency, T_{CLi} , is the time it takes a cancellation to propagate from the core to the i -th cache. The response latency, T_{Li} , is the time it takes for a response to reach the i -th cache after the transmit instruction is executed. We assume that the required block is not cached at any level and must be fetched from memory. We discuss this assumption in Section 9.8.

Symbol	Name	Meaning
T_S	Squash latency	Time it takes to squash the transmit instruction after it has executed
T_{CLi}	Cancellation latency	Time it takes a cancellation to propagate from the core to the i -th cache
T_{Li}	Response latency	Time it takes for a transmit instruction's response to reach the i -th cache after it has executed
$T_{MemRead}$	Memory-only read latency	Time between the last-level cache sending a request and receiving a response
T_T	Transmit instruction delay	Time between start of speculation and execution of transmit instruction
$FwdLat_{Li}$	Forwarding latency	Time it takes to forward a miss from level i to level $i + 1$
$RespFwdLat_{Li}$	Reponse forwarding latency	Time it takes to forward a response from level i to level $i - 1$
$CnFwdLat_{Li}$	Cancellation forwarding latency	Time it takes to forward a cancellation from level i to level $i + 1$
$SpecWindSz$	Speculation window size	Size of the speculation window in wallclock time
A_i	Round-trip hit latency	Total round-trip access latency for a hit in level i
A_{mem}	Uncached memory latency	Total round-trip latency for an access that misses in all caches

TABLE 3: Symbols used throughout Section 7.

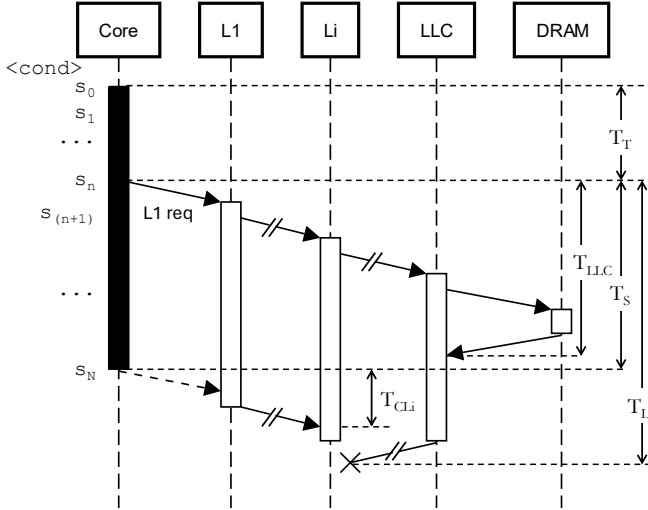

Figure 8: Annotated sequence diagram of a single Spectre transmit step. Instructions are shown on the left. $\langle \text{cond} \rangle$ is the instruction causing the speculation condition. $s_0 - s_N$ are the instructions executed within the speculation window.

$$T_S + T_{CLi} < T_{Li} \quad (2)$$

A transmit step fails completely if $Li == LLC$. By ensuring that even the LLC is not modified, we guarantee that the extract step (and therefore the entire Spectre attack) will fail. On the other hand, if Inequality 2 is false for all i , this means that CMR was not effective in preventing any changes to the caches. If Inequality 2 is true but for $Li \neq LLC$, the transmit step will succeed in changing the state of caches $> i$. While this does not prevent the attack completely, it increases the difficulty of extracting the secret in the final step [4]. This is because the attacker must now differentiate between latencies that are closer to each other. For example, in a system with three cache levels without CMR, the attacker need only differentiate between the L1 hit latency (very small) and the latency for a full trip to main memory (very large). With CMR and $i == 2$, the only change caused by the transmit step is to the LLC. This means the attacker must now differentiate between the

latencies for a LLC hit (large) and a full trip to main memory (very large).

7.1. Response latency – T_{Li}

Next, we break down each term to identify how system parameters affect the result. First is T_{Li} , which is the delay between executing the access instruction and receiving the response at the Li cache. Caches closer to the core, i.e. with low i , generally result in a higher T_{Li} . However, this delay is not constant. High traffic within the cache hierarchy can increase the delay due to contention over resources such as busses and MSHRs. To make a conservative analysis, we use $\min(T_{Li})$, the smallest possible value of T_{Li} . $\min(T_{Li})$ occurs when there is no contention stalling the memory fetch at any point in the hierarchy, including main memory. Its value is constant and determined solely by system parameters:

$$\begin{aligned} \min(T_{Li}) = & \sum_{j=1}^K \min(FwdLat_{Lj}) + \min(T_{MemRead}) \\ & + \sum_{j=i+1}^K \min(RespFwdLat_{Lj}) \end{aligned} \quad (3)$$

where K is the number of cache levels³, $FwdLat_{Lj}$ is the forwarding latency for a miss at level j , $\min(T_{MemRead})$ is the minimum memory-only read latency, and $RespFwdLat_{Lj}$ is the response forwarding latency (i.e., the time it takes to forward a response from Lj to $Lj - 1$). We can refactor Equation (3) to Equation (4) to represent it in terms of access latencies.

3. In systems with non-uniform cache topologies, different cores can have different numbers of cache levels between them and main memory. In this equation, only the number of levels for the core executing the Spectre transmit instruction is relevant.

$$\begin{aligned}
\min(T_{Li}) &= \sum_{j=1}^i \min(FwdLat_{Lj}) + (A_{i+1} - A_i) + \\
&\quad (A_{i+2} - A_{i+1}) + \dots + (A_{mem} - A_K) \quad (4) \\
&= \sum_{j=1}^i \min(FwdLat_{Lj}) + (A_{mem} - A_i)
\end{aligned}$$

where A_i is the total round-trip access latency for a hit in cache L_i , and A_{mem} is the total round-trip latency for an access that misses in all caches.

7.2. Cancellation latency – T_{CLi}

The next value we look at from Inequality 2 is T_{CLi} , which is defined as follows.

$$T_{CLi} = \sum_{j=0}^{i-1} CnFwdLat_{Lj} \quad (5)$$

where $CnFwdLat_{Lj}$ is the forwarding latency for a cancellation at level j , which includes the time taken to search MSHRs (Section 4.1.1), and $CnFwdLat_{L0} = 1$. Note that we only need to account for the time taken for a cancellation to reach a cache. In other words, for $CnFwdLat_{Lj}$, we do not include the time taken to forward the cancellation from L_j to $L(j+1)$. For $L1$, we assume a cancellation only needs a single cycle to reach it. The reason is that once a cancellation is in the cache, incoming responses can be compared to it (and discarded if they match) before causing a change to cache state, even if the cancellation has not finished searching the MSHR queue.

For a conservative analysis, we need to determine the maximum value of T_{CLi} and therefore of $CnFwdLat_{Lj}$. For a normal request packet, this latency is non-deterministic as it can increase due to resource contention and depends on the current traffic within the hierarchy. However, we can implement special handling for cancellation packets that gives it priority over all other packets in the system. We can also send it over a dedicated high-priority bus channel to eliminate bus contention⁴. This removes any dependence on contention and makes $CnFwdLat_{Lj}$ constant. Since cancellations need to search the MSHR queue as is done for cache misses, we can assume Equation (6).

$$CnFwdLat_{Lj} = \min(FwdLat_{Lj}) \quad (6)$$

7.3. Squash latency – T_S

The final, and most complicated, value from Inequality 2 is T_S , which depends on the size of the speculation window,

4. We can even add or use existing dedicated circuitry (similar to that used for snooping) that broadcasts cancellations to all caches. However, to reduce cancellation-handling complexity and make the security analysis conservative, we assume cancellations need to propagate one level at a time. We discuss this alternative in Section 9.3.

$SpecWindSz$, (in wallclock time, not instructions) and the position, T_T , of the transmit instruction, s_i , from the start of the window. This is shown in Equation (7).

$$\begin{aligned}
T_S &= (T_T + T_S) - T_T \\
&= SpecWindSz - T_T \quad (7)
\end{aligned}$$

7.3.1. Speculation window size. Theoretically, the core can wait indefinitely (stalling if required, i.e. the reorder buffer (ROB) becomes full) until the speculation condition is resolved, making the speculation window infinitely large. However, this does not happen in practice and speculation is always resolved. Gigerl [13], Mambretti et al. [14] and Xiao et al. [15] identify empirical limits to the speculation window sizes on different platforms using different instructions for the condition `<cond>`.

Note that the window size does not depend on the number of instructions executed within it. The speculation window exists until speculation is resolved irrespective of whether instructions are executed speculatively; it is up to the CPU to take advantage of this window as best as possible.

7.3.2. Transmit instruction. As explained above, T_C does not depend on the total number of instructions executed speculatively. However, it does depend on the instructions executed before s_n because that determines T_T . The following factors affect T_T :

- 1) *The number of instructions preceding s_n in the speculation window.* More instructions results in higher T_T .
- 2) *The types of instructions preceding s_n in the speculation window.* Instructions that take longer to complete will generally result in higher T_T . However, since modern CPUs are superscalar (i.e., can execute multiple instructions in parallel), T_T will only increase once the CPU can no longer execute more instructions in the same cycle and must wait for resources to be freed. Instructions that use the same resources and take several cycles to complete (e.g., floating-point instructions) will therefore result in a higher T_T .
- 3) *Any dependencies between s_n and instructions preceding it in the speculation window.* Modern CPUs can execute instructions that have no data interdependencies out of order. Data dependencies between instructions force the CPU to postpone dependent instructions, possibly executing later instructions that have no dependencies.
- 4) *Contention between speculative instructions preceding s_n and non-speculative instructions.* Similar to contention between speculative instructions in the speculation window, non-speculative instructions can also cause contention and lead to a higher T_T .

Calculating a constant T_T for a Spectre attack is not possible due to random contention from prior non-speculative

instructions (Item 4). We can, however, calculate minimum values which occur when there is no contention. This gives us a conservative analysis because a higher T_T results in a lower T_S , which increases the effectiveness of CMR, as per Inequality 2.

Theoretically, T_T can be zero. This can happen if the secret is already present in a register and the only instruction that needs to be executed speculatively is the transmit instruction. For example, in Listing 2, if `rax` already contains the secret when speculation starts, skipping lines 3-13 and directly executing line 15 would transmit the secret with $T_T = 0$. In practice, however, this is unrealistic. Adversaries typically do not have enough control to place the secret in a register before speculation and, in a similar vein to return-oriented programming (ROP) [16], must rely on Spectre *gadgets* (i.e., sequences of instructions that can be executed speculatively) in the victim’s code to perform their attack [17], [18], [19], [20]. These gadgets are used to access *and* transmit secrets. This requires at least two load instructions to be executed speculatively: one for access and another for transmit. If the access load hits in the cache, this will result in a lower T_T than if the access load must fetch the secret all the way from main memory.

Generally, as gadgets become longer, their T_T increases, making them more amenable to mitigation by CMR. For a conservative analysis, it is sufficient to show that our approach is effective even when $T_T = 0$.

7.4. Putting it all together

Now that we have described the relevant terms, we can revisit Inequality 2. We use maximums and minimums in to obtain a conservative analysis as discussed earlier.

$$\max(T_S + T_{CLi}) < \min(T_{Li})$$

$$\max(T_S) + T_{CLi} < \min(T_{Li})$$

We then substitute $\min(T_{Li})$ and T_{CLi} using Equation (4) and Equation (7), and use Equation (6) to remove $FwdLat_{Li}$.

$$\begin{aligned} \max(T_S) + \sum_{j=0}^{i-1} C_n FwdLat_{Lj} < \\ & \sum_{j=1}^i \min(FwdLat_{Lj}) + (A_{mem} - A_i) \\ \max(T_S) + \sum_{j=0}^{i-1} \min(FwdLat_{Lj}) < \\ & \sum_{j=1}^i \min(FwdLat_{Lj}) + (A_{mem} - A_i) \\ \max(T_S) + 1 < \min(FwdLat_{Li}) + (A_{mem} - A_i) \end{aligned}$$

$$CMR_i = (\max(T_S) + 1 < \min(FwdLat_{Li}) + (A_{mem} - A_i)) \quad (8)$$

The result intuitively shows that as we get closer to the core (A_i decreases), CMR becomes more effective as it is more likely that Equation (8) is true. We present different realistic configurations (with measurements from prior literature) and whether they satisfy Equation (8) in Table 4. We assume that for all caches in all systems, $\min(FwdLat_{Li}) > 1$ and we can safely (and conservatively) remove $\min(FwdLat_{Li})$ from Equation (8). The numbers demonstrate that CMR is effective on realistic systems. Note that while the terms in Equation (8) are in seconds, the values available in the literature are in CPU cycles. We present the values in CPU cycles in Table 4. We ignore the memory clock frequencies since the measurements for `MOVNTI` from [21] are in CPU cycles. We find that the cycle latencies reported for the `MOVNTI` instruction for Intel CPUs match generally reported latencies for uncached memory accesses after conversion to wallclock time, which are around $100ns$ [22], [23].

8. Performance Evaluation

We evaluate CMR’s performance by measuring the number of ticks to complete regions-of-interest (ROIs) in benchmarks on `gem5`. This is the default performance measurement mechanism provided in `gem5`. We use the PARSEC benchmark suite. We obtain results for a 2-core and a 4-core system using the configurations shown in Table 5.

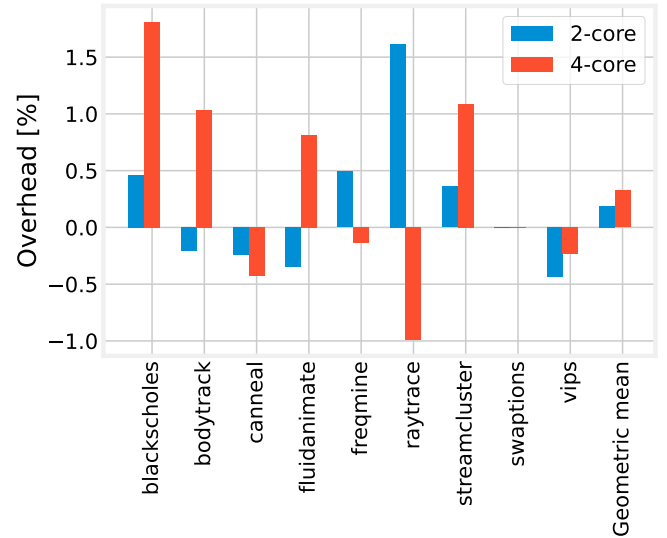

Figure 9: Overheads of CMR-enabled configurations relative to their CMR-disabled baselines. The last item shows a geometric mean of 0.19% and 0.32% for the 2-core and 4-core configurations, respectively.

We run the PARSEC benchmarks on both 2-core and 4-core configurations, with and without CMR, using the “simlarge” input size. The `x264` benchmark terminated with an error in all configurations, even without CMR, and was therefore discarded. We also discarded benchmarks that did

#	System	SpecWindSz	A_{mem}	A_1	A_2	A_3	CMR ₁	CMR ₂	CMR ₃
1	Intel IceLake	154 ¹	400	4	14	50	✓	✓	✓
2	Intel SkyLake	154	400	4	14	34	✓	✓	✓
3	AMD Zen4	132 ¹	900	4	14	47	✓	✓	✓
4	AMD Zen	132	900 ²	4	17	40	✓	✓	✓

TABLE 4: For several real systems, we show latencies based on [11], [21] and whether Equation (8) is satisfied at different cache levels. Speculation window sizes are taken from [13]. Numbers in CPU clock cycles. CMR_{*i*} refers to Equation (8) being satisfied for cache *L_i*. For A_{mem} , we use the latencies in [21] for the MOVNTI instructions, which are stores that bypass the cache hierarchy (called non-temporal stores). ¹Speculation window sizes are not available for new processor generations. We therefore assume they are similar to older generations. ²Similarly, the latency for MOVNTI is not available for the older AMD Zen microarchitecture, and we therefore assume it is the same as for AMD Zen4.

Parameter	2-core	4-core
Core count	2	4
Core frequency (GHz)	3	3
L1D/I size (kB)	32	32
L1D/I associativity	8	8
L1D/I latency (cycles)	4	4
L2 size (kB)	512	512
L2 associativity	16	16
L2 latency (cycles)	14	14

TABLE 5: Configurations used in performance evaluation. In both configurations, each core has private L1D and L1I caches and shares the L2 cache. The 2-core configuration is identical to C1 in Table 1.

not complete within 72 hours, such as dedup, facesim and ferret. We plot the overheads in Figure 9, showing negligible geometric means of 0.19% and 0.32% for CMR on 2-core and 4-core configurations, respectively, therefore satisfying R1. The maximum overhead is < 2%, for blackscholes in the 4-core configuration. In some benchmarks, CMR shows a performance improvement, which can be explained by the fact that CMR *reduces cache pollution caused by mis-speculation*. For programs where mis-speculation is common, CMR can therefore *improve performance*.

The variability in the overheads can be attributed to the randomness inherent in execution. Furthermore, with CMR enabled, the cache state at any point in the program is different compared to an identical execution trace with CMR disabled, since mis-speculated memory requests are cancelled. This difference in cache state can result in a difference in overall execution time (positive or negative, depending on program state), leading to variable overheads.

In our implementation, cancellations and requests share the cache input buffers. This can cause contention between cancellations and requests if the buffers are too small or if many cancellations are sent at once, leading to performance overheads. However, this is not a requirement for CMR’s design and a more performant implementation would avoid contention between cancellations and requests. In gem5, adding support for such parallel buffers is not well-supported and requires large code-base changes. We therefore opt to share the buffers, albeit with a disadvantage to our evalua-

tion results.

9. Discussion & future work

9.1. Meltdown

One notable advantage of CMR is that it provides support for memory request cancellations *regardless of the reason for cancellation*. While we tackle speculative execution in this paper, it is important to note that CMR is also applicable to fault-based transient attacks such as Meltdown [10]. Any transmit instruction executed transiently during the Meltdown attack can be cancelled once the fault is detected, thereby reducing cache state changes and potentially thwarting the attack.

9.2. TLBs

An important cache-like structure in CPUs is the translation lookaside buffer (TLB), which caches virtual-to-physical address translations. Prior work has shown that TLBs can indeed be used to leak information in a way similar to cache timing attacks [24]. In our implementation, we only cover squashed loads sent to the data caches; however, CMR can equally be applied to TLBs. Address translations requested transiently and later squashed can be cancelled to reduce changes to TLB state.

9.3. Cancellation broadcasts

Dedicated circuitry, similar to that used for snooping, can be added to the CPU die to broadcast cancellations to all caches, even if a snooping protocol is not used. This can drastically improve the security provided by CMR, by eliminating the dependency on cache forwarding latency (Section 7.2). However, this adds complexity to cancellation handling because lower-level caches would now get cancellations even if the corresponding upstream MSHR is not empty. A mechanism must therefore be added to allow lower-level caches to track upstream MSHRs and only act on cancellations once the upstream MSHR becomes empty.

9.4. Cancellation of memory bus transactions

In our design requirements, we explicitly avoid changes to external modules and interfaces such as main memory (R3) to increase the compatibility of CMR. However, introducing cancellations to memory bus transactions can be an opportunity to improve performance. By aborting transactions that are no longer needed, we can free up the memory bus for other transactions. Furthermore, for memories with integrated on-chip caches, this can improve security by preventing transmit instructions from affecting the on-chip cache. We leave such research for future work.

9.5. Overlapping cancelled and uncanceled requests

If there are n requests waiting for the same cache block, canceling up to $(n - 1)$ of them will have no effect on the cache. As long as there is at least one target, the MSHR must be serviced. Information leakage can occur if the *first* request to allocate the MSHR is cancelled, but the MSHR cannot be deallocated due to the existence of other targets (that arrived later and were not cancelled). There is a timing difference between when the response arrives in this case, and when the response would have arrived had there not been the first request (i.e., the MSHR was instead allocated by the non-speculative second request). While this timing difference can theoretically be used to leak information, this is very difficult because the threat model assumes that this second request is not under the attacker’s control, and they cannot determine the time at which it occurs (and therefore cannot accurately measure the timing difference). Note that if the attack can control this non-speculative request, they have no need for a Spectre attack and can simply use a non-transient cache timing attack (Section 2.2).

9.6. Speculative-interference attacks

A crucial requirement for CMR is that the transmit instruction is speculative, and is therefore squashed when the speculation window ends. In speculative interference attacks [25], however, this is not the case. Instead, speculative execution is used to affect the order of *non-speculative* loads/stores, resulting in a cache state difference that can later be measured to leak the secret. As non-speculative memory requests cannot be cancelled, CMR cannot thwart such attacks. We consider them out-of-scope and rely on orthogonal defenses.

9.7. Non-cache-based side channels

CMR works by reducing *persistent* secret-dependent changes to *cache state*. As a result, CMR only covers cache-based side channels. Other side channels, e.g. contention-based channels [26], [27], [28], are not covered. This is similar to many invisible speculation schemes (Section 10).

9.8. Cache hits for transmit instructions

In Section 7, we assumed that the data requested by the transmit instruction is not cached at any level. While this is true in many cache timing attacks, especially those that use flushing, an attacker can instead use evictions [3] to remove the data from one level but keep it in lower levels. For example, an attacker can evict the data from L1 but not L2 before launching the Spectre attack, and later use the timing difference between an L1 access and an L2 access to leak the secret. While CMR is less effective against such attacks, it is important to note that these attacks are also more difficult to launch due to the smaller timing difference. In general, we can say that the more likely an attack is to succeed without CMR (due to a large timing difference), the more effective CMR is at thwarting it.

10. Related work

Invisible speculation mechanisms [29], [30], [31], [32], [33] attempt to hide speculative side effects until they are determined to be non-speculative. While hidden, speculative changes are stored in shadow structures which are invisible to the rest of the non-speculative system. However, many of these schemes can suffer from significant overheads, e.g., InvisiSpec has 21 – 72% overhead. Some only consider changes to the L1 cache and ignore changes to lower level caches. Furthermore, they all require the addition of expensive on-chip cache-like storage for the shadow structure. In comparison, CMR does not require any such shadow structures and has negligible (and in some cases negative) overheads.

Speculative Taint Tracking (STT) [34] is another Spectre mitigation technique that taints data loaded by Spectre access instructions and delays any instructions that use it and leak information (such as transmit load instructions) until the access instruction becomes non-speculative. While STT is not limited to protecting only cache-based side channels, the introduced delays can result in significant overheads (8.5–14.5%) compared to CMR. Furthermore, STT does not cover the case where only the transmit, but not the access, instruction is speculative.

11. Conclusion

We present CMR, a novel transparent Spectre mitigation with near-zero overheads. We show that in some cases, CMR can even enhance performance by reducing cache pollution caused by mispredictions. Our case studies and security analysis demonstrate the effectiveness of CMR and show that with proper (realistic) system configuration, CMR can provide strong security guarantees. We also discuss the applicability of CMR to other transient attacks such as Meltdown. While in some configurations, CMR can provide probabilistic, rather than deterministic, security, its minimalist design changes and near-zero overhead make it an obvious choice for reducing exposure to transient execution attacks.

Acknowledgments

This work is supported in part by Natural Sciences and Engineering Research Council of Canada (grant number RGPIN-2020-04744). Views expressed in the paper are those of the authors and do not necessarily reflect the position of the funders.

References

- [1] P. Kocher, J. Horn, A. Fogh, D. Genkin, D. Gruss, W. Haas, M. Hamburg, M. Lipp, S. Mangard, T. Prescher, M. Schwarz, and Y. Yarom, "Spectre attacks: Exploiting speculative execution," in *2019 IEEE Symposium on Security and Privacy, SP 2019, San Francisco, CA, USA, May 19-23, 2019*. IEEE, 2019, pp. 1–19. [Online]. Available: <https://doi.org/10.1109/SP.2019.00002>
- [2] Y. Yarom and K. Falkner, "FLUSH+RELOAD: A high resolution, low noise, L3 cache side-channel attack," in *Proceedings of the 23rd USENIX Security Symposium, San Diego, CA, USA, August 20-22, 2014*, K. Fu and J. Jung, Eds. USENIX Association, 2014, pp. 719–732. [Online]. Available: <https://www.usenix.org/conference/usenixsecurity14/technical-sessions/presentation/yarom>
- [3] D. A. Osvik, A. Shamir, and E. Tromer, "Cache attacks and countermeasures: The case of AES," in *Topics in Cryptology - CT-RSA 2006, The Cryptographers' Track at the RSA Conference 2006, San Jose, CA, USA, February 13-17, 2006, Proceedings*, ser. Lecture Notes in Computer Science, D. Pointcheval, Ed., vol. 3860. Springer, 2006, pp. 1–20. [Online]. Available: https://doi.org/10.1007/11605805_1
- [4] F. Liu, Y. Yarom, Q. Ge, G. Heiser, and R. B. Lee, "Last-level cache side-channel attacks are practical," in *2015 IEEE Symposium on Security and Privacy, SP 2015, San Jose, CA, USA, May 17-21, 2015*. IEEE Computer Society, 2015, pp. 605–622. [Online]. Available: <https://doi.org/10.1109/SP.2015.43>
- [5] C. Canella, J. V. Bulck, M. Schwarz, M. Lipp, B. von Berg, P. Ortner, F. Piessens, D. Evtushkin, and D. Gruss, "A systematic evaluation of transient execution attacks and defenses," in *28th USENIX Security Symposium, USENIX Security 2019, Santa Clara, CA, USA, August 14-16, 2019*, N. Heninger and P. Traynor, Eds. USENIX Association, 2019, pp. 249–266. [Online]. Available: <https://www.usenix.org/conference/usenixsecurity19/presentation/canella>
- [6] SiFive, "SiFive TileLink specification," 2017. [Online]. Available: <https://static.dev.sifive.com/docs/tilelink/tilelink-spec-1.7-draft.pdf>
- [7] Arm, "Amba chi architecture specification," 2024. [Online]. Available: <https://developer.arm.com/documentation/hi0050/latest/>
- [8] N. L. Binkert, B. M. Beckmann, G. Black, S. K. Reinhardt, A. G. Saida, A. Basu, J. Hestness, D. Hower, T. Krishna, S. Sardashti, R. Sen, K. Sewell, M. S. B. Altaf, N. Vaish, M. D. Hill, and D. A. Wood, "The gem5 simulator," *SIGARCH Comput. Archit. News*, vol. 39, no. 2, pp. 1–7, 2011. [Online]. Available: <https://doi.org/10.1145/2024716.2024718>
- [9] Google, "Safeside," 2020. [Online]. Available: <https://github.com/google/safeside/tree/main>
- [10] M. Lipp, M. Schwarz, D. Gruss, T. Prescher, W. Haas, A. Fogh, J. Horn, S. Mangard, P. Kocher, D. Genkin, Y. Yarom, and M. Hamburg, "Meltdown: Reading kernel memory from user space," in *27th USENIX Security Symposium, USENIX Security 2018, Baltimore, MD, USA, August 15-17, 2018*, W. Enck and A. P. Felt, Eds. USENIX Association, 2018, pp. 973–990. [Online]. Available: <https://www.usenix.org/conference/usenixsecurity18/presentation/lipp>
- [11] A. Fog, "The microarchitecture of intel, amd and via cpus: An optimization guide for assembly programmers and compiler makers," 2024. [Online]. Available: <https://www.agner.org/optimize/microarchitecture.pdf>
- [12] E. M. Koruyeh, K. N. Khasawneh, C. Song, and N. B. Abu-Ghazaleh, "Spectre returns! speculation attacks using the return stack buffer," in *12th USENIX Workshop on Offensive Technologies, WOOT 2018, Baltimore, MD, USA, August 13-14, 2018*, C. Rossow and Y. Younan, Eds. USENIX Association, 2018. [Online]. Available: <https://www.usenix.org/conference/woot18/presentation/koruyeh>
- [13] B. Gigerl, "Automated Analysis of Speculation Windows in Spectre Attacks," Master's thesis, Graz University of Technology, 2019, available at <https://doi.org/10.3217/1jdvf-2h481>.
- [14] A. Mambretti, M. Neugschwandtner, A. Sorniotti, E. Kirda, W. K. Robertson, and A. Krumus, "Speculator: a tool to analyze speculative execution attacks and mitigations," in *Proceedings of the 35th Annual Computer Security Applications Conference, ACSAC 2019, San Juan, PR, USA, December 09-13, 2019*, D. M. Balenson, Ed. ACM, 2019, pp. 747–761. [Online]. Available: <https://doi.org/10.1145/3359789.3359837>
- [15] Y. Xiao, Y. Zhang, and R. Teodorescu, "SPEECHMINER: A framework for investigating and measuring speculative execution vulnerabilities," in *27th Annual Network and Distributed System Security Symposium, NDSS 2020, San Diego, California, USA, February 23-26, 2020*. The Internet Society, 2020. [Online]. Available: <https://www.ndss-symposium.org/ndss-paper/speechminer-a-framework-for-investigating-and-measuring-speculative-execution-vulnerabilities/>
- [16] H. Shacham, "The geometry of innocent flesh on the bone: return-into-libc without function calls (on the x86)," in *Proceedings of the 2007 ACM Conference on Computer and Communications Security, CCS 2007, Alexandria, Virginia, USA, October 28-31, 2007*, P. Ning, S. D. C. di Vimercati, and P. F. Syverson, Eds. ACM, 2007, pp. 552–561. [Online]. Available: <https://doi.org/10.1145/1315245.1315313>
- [17] A. Bhattacharyya, A. Sánchez, E. M. Koruyeh, N. B. Abu-Ghazaleh, C. Song, and M. Payer, "Specrop: Speculative exploitation of ROP chains," in *23rd International Symposium on Research in Attacks, Intrusions and Defenses, RAID 2020, San Sebastian, Spain, October 14-15, 2020*, M. Egele and L. Bilge, Eds. USENIX Association, 2020, pp. 1–16. [Online]. Available: <https://www.usenix.org/conference/raid2020/presentation/bhattacharyya>
- [18] Z. Qi, Q. Feng, Y. Cheng, M. Yan, P. Li, H. Yin, and T. Wei, "Spectaint: Speculative taint analysis for discovering spectre gadgets," in *28th Annual Network and Distributed System Security Symposium, NDSS 2021, virtually, February 21-25, 2021*. The Internet Society, 2021. [Online]. Available: <https://www.ndss-symposium.org/ndss-paper/spectaint-speculative-taint-analysis-for-discovering-spectre-gadgets/>
- [19] B. Johannesmeyer, J. Koschel, K. Razavi, H. Bos, and C. Giuffrida, "Kasper: Scanning for generalized transient execution gadgets in the linux kernel," in *29th Annual Network and Distributed System Security Symposium, NDSS 2022, San Diego, California, USA, April 24-28, 2022*. The Internet Society, 2022. [Online]. Available: <https://www.ndss-symposium.org/ndss-paper/auto-draft-247/>
- [20] S. Wiebing, A. de Faveri Tron, H. Bos, and C. Giuffrida, "InSpectre Gadget: Inspecting the Residual Attack Surface of Cross-privilege Spectre v2," in *33rd USENIX Security Symposium, USENIX Security 2024, Philadelphia, PA, USA, August 14-16, 2024*. USENIX Association, 2024. [Online]. Available: https://download.vusec.net/papers/inspectre_sec24.pdf
- [21] A. Fog, "Instruction tables: Lists of instruction latencies, throughputs and micro-operation breakdowns for intel, amd and via cpus," 2022. [Online]. Available: https://www.agner.org/optimize/instruction_table_s.pdf
- [22] U. Drepper, "What Every Programmer Should Know About Memory," 2007. [Online]. Available: <https://www.akkadia.org/drepper/cpumemory.pdf>
- [23] R. S. Verdejo, K. Asifuzzaman, M. Radulovic, P. Radojkovic, E. Ayguadé, and B. L. Jacob, "Main memory latency simulation: the missing link," in *Proceedings of the International Symposium on Memory Systems, MEMSYS 2018, Old Town Alexandria, VA, USA, October 01-04, 2018*, B. L. Jacob, Ed. ACM, 2018, pp. 107–116. [Online]. Available: <https://doi.org/10.1145/3240302.3240317>

- [24] B. Gras, K. Razavi, H. Bos, and C. Giuffrida, "Translation leak-aside buffer: Defeating cache side-channel protections with TLB attacks," in *27th USENIX Security Symposium, USENIX Security 2018, Baltimore, MD, USA, August 15-17, 2018*, W. Enck and A. P. Felt, Eds. USENIX Association, 2018, pp. 955–972. [Online]. Available: <https://www.usenix.org/conference/usenixsecurity18/presentation/gras>
- [25] M. Behnia, P. Sahu, R. Paccagnella, J. Yu, Z. N. Zhao, X. Zou, T. Unterluggauer, J. Torrellas, C. V. Rozas, A. Morrison, F. McKeen, F. Liu, R. Gabor, C. W. Fletcher, A. Basak, and A. R. Alameldeen, "Speculative interference attacks: breaking invisible speculation schemes," in *ASPLOS '21: 26th ACM International Conference on Architectural Support for Programming Languages and Operating Systems, Virtual Event, USA, April 19-23, 2021*, T. Sherwood, E. D. Berger, and C. Kozyrakis, Eds. ACM, 2021, pp. 1046–1060. [Online]. Available: <https://doi.org/10.1145/3445814.3446708>
- [26] M. Taram, X. Ren, A. Venkat, and D. M. Tullsen, "Secsmt: Securing SMT processors against contention-based covert channels," in *31st USENIX Security Symposium, USENIX Security 2022, Boston, MA, USA, August 10-12, 2022*, K. R. B. Butler and K. Thomas, Eds. USENIX Association, 2022, pp. 3165–3182. [Online]. Available: <https://www.usenix.org/conference/usenixsecurity22/presentation/taram>
- [27] Z. N. Zhao, A. Morrison, C. W. Fletcher, and J. Torrellas, "Binoculars: Contention-based side-channel attacks exploiting the page walker," in *31st USENIX Security Symposium, USENIX Security 2022, Boston, MA, USA, August 10-12, 2022*, K. R. B. Butler and K. Thomas, Eds. USENIX Association, 2022, pp. 699–716. [Online]. Available: <https://www.usenix.org/conference/usenixsecurity22/presentation/zhao-zirui>
- [28] R. Paccagnella, L. Luo, and C. W. Fletcher, "Lord of the ring(s): Side channel attacks on the CPU on-chip ring interconnect are practical," in *30th USENIX Security Symposium, USENIX Security 2021, August 11-13, 2021*, M. D. Bailey and R. Greenstadt, Eds. USENIX Association, 2021, pp. 645–662. [Online]. Available: <https://www.usenix.org/conference/usenixsecurity21/presentation/paccagnella>
- [29] M. Yan, J. Choi, D. Skarlatos, A. Morrison, C. W. Fletcher, and J. Torrellas, "Invisispec: Making speculative execution invisible in the cache hierarchy," in *51st Annual IEEE/ACM International Symposium on Microarchitecture, MICRO 2018, Fukuoka, Japan, October 20-24, 2018*. IEEE Computer Society, 2018, pp. 428–441. [Online]. Available: <https://doi.org/10.1109/MICRO.2018.00042>
- [30] K. N. Khasawneh, E. M. Koruyeh, C. Song, D. Evtvushkin, D. Ponomarev, and N. B. Abu-Ghazaleh, "Safespec: Banishing the spectre of a meltdown with leakage-free speculation," in *Proceedings of the 56th Annual Design Automation Conference 2019, DAC 2019, Las Vegas, NV, USA, June 02-06, 2019*. ACM, 2019, p. 60. [Online]. Available: <https://doi.org/10.1145/3316781.3317903>
- [31] C. Sakalis, S. Kaxiras, A. Ros, A. Jimborean, and M. Sjalander, "Efficient invisible speculative execution through selective delay and value prediction," in *Proceedings of the 46th International Symposium on Computer Architecture, ISCA 2019, Phoenix, AZ, USA, June 22-26, 2019*, S. B. Manne, H. C. Hunter, and E. R. Altman, Eds. ACM, 2019, pp. 723–735. [Online]. Available: <https://doi.org/10.1145/3307650.3322216>
- [32] P. Li, L. Zhao, R. Hou, L. Zhang, and D. Meng, "Conditional speculation: An effective approach to safeguard out-of-order execution against spectre attacks," in *25th IEEE International Symposium on High Performance Computer Architecture, HPCA 2019, Washington, DC, USA, February 16-20, 2019*. IEEE, 2019, pp. 264–276. [Online]. Available: <https://doi.org/10.1109/HPCA.2019.000043>
- [33] S. Ainsworth and T. M. Jones, "Muontrap: Preventing cross-domain spectre-like attacks by capturing speculative state," in *47th ACM/IEEE Annual International Symposium on Computer Architecture, ISCA 2020, Virtual Event / Valencia, Spain, May 30 - June 3, 2020*. IEEE, 2020, pp. 132–144. [Online]. Available: <https://doi.org/10.1109/ISCA45697.2020.00022>
- [34] J. Yu, M. Yan, A. Khyzha, A. Morrison, J. Torrellas, and C. W. Fletcher, "Speculative taint tracking (STT): A comprehensive protection for speculatively accessed data," in *Proceedings of the 52nd Annual IEEE/ACM International Symposium on Microarchitecture, MICRO 2019, Columbus, OH, USA, October 12-16, 2019*. ACM, 2019, pp. 954–968. [Online]. Available: <https://doi.org/10.1145/3352460.3358274>