

# Solving the Inverse Problem of Electrocardiography for Cardiac Digital Twins: A Survey

Lei Li, Julia Camps, Blanca Rodriguez, and Vicente Grau

**Abstract**—Cardiac digital twins are personalized virtual representations used to understand complex heart mechanisms. Solving the ECG inverse problem is crucial for accurate virtual heart modelling, enabling the derivation of internal electrical activity information from recorded surface potentials. Despite challenges from cardiac complexity, noisy ECG data, and computational efficiency, recent advancements hold significant promise for enhancing virtual heart modelling, ultimately advancing precision medicine in cardiology. This paper aims to provide a comprehensive review of the methods of solving ECG inverse problem, the validation strategies, the clinical applications, and future perspectives. For the computing methodologies, we broadly classify state-of-the-art approaches into two categories: deterministic and probabilistic methods, including conventional and deep learning-based techniques. Integrating physics laws with deep learning models holds promise, but challenges such as capturing dynamic electrophysiology accurately, accessing accurate domain knowledge, and quantifying prediction uncertainty persist. Integrating models into clinical workflows while ensuring interpretability and usability for healthcare professionals is essential. Overcoming these challenges will drive further research in cardiac digital twins.

**Index Terms**—Cardiac electrophysiology, inverse problem, computational model, cardiac digital twin, survey.

## I. INTRODUCTION

Electrocardiogram (ECG) is a non-invasive technique used to measure the electrical activity of the heart and identify potential abnormalities [1]. It consists of a number of electrodes placed on the skin of the patient, typically on the chest, arms, and legs. These electrodes record the changes in electrical potential on the body surface, which are generated by the underlying electrical activity of the heart. Virtual modelling of cardiac electrophysiology (EP) for digital twins has shown great promise in numerous clinical applications, such as the stratification of arrhythmia risk [2] and the ablation guidance of persistent atrial fibrillation (AF) [3]. However, obtaining numerical solutions to the governing partial differential equations (PDEs) in cardiac EP (ECG forward problem) is quite challenging. Several forward physical modelling approaches have been employed, such as the bidomain model, the monodomain model, and the Eikonal equation. The bidomain model provides information about the ionic currents [4], the monodomain model describes the

Corresponding author: Lei Li (lei.sky.li@soton.ac.uk). This work was supported by the CompBioMed 2 Centre of Excellence in Computational Biomedicine (European Commission Horizon 2020 research and innovation programme, grant agreement No. 823712) and CompBiomedX EPSRC-funded grant (EP/X019446/1 to B. Rodriguez). L. Li was partially supported by the Shanghai Jiao Tong University (SJTU) 2021 Outstanding Doctoral Graduate Development Scholarship. J. Camps was funded by an Engineering and Physical Sciences Research Council doctoral award. J. Camps and B. Rodriguez were funded by a Wellcome Trust Fellowship in Basic Biomedical Sciences to Blanca Rodriguez (214290/Z/18/Z). V. Grau was partially supported by the British Heart Foundation Project under Grant PG/20/21/35082.

Lei Li is with School of Electronics & Computer Science, University of Southampton, SO17 1BJ Southampton, UK and Department of Engineering Science, University of Oxford, OX3 7DQ Oxford, UK.

Vicente Grau is with the Department of Engineering Science, University of Oxford, OX3 7DQ Oxford, UK.

Julia Camps and Blanca Rodriguez are with the Department of Computer Science, University of Oxford, OX1 3QD Oxford, UK.

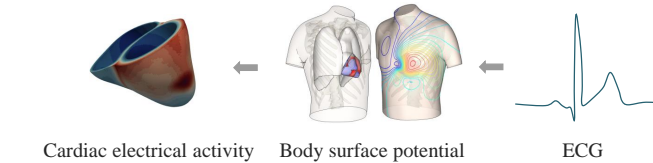

Fig. 1. Illustration of the electrocardiogram (ECG) inverse problem.

electrical propagation [5], and the Eikonal equation models wavefront propagation [6]. To obtain a complete understanding of the electrical activity of the heart, we need to estimate the activity inside the heart from the measured ECG signals, namely ECG inverse problem [7]. Fig. 1 presents the inverse inference procedure for reconstructing the cardiac activity from ECG data. By solving the inverse problem, one can obtain valuable information about the function of the heart, which can aid in the diagnosis and monitoring of various cardiac conditions, as well as the development of personalized treatments for cardiac disorders.

However, directly predicting cardiac activity from standard ECG signals (often recorded using a limited number of electrodes, such as the 12-lead ECG with ten electrodes) is a challenging task. This is mainly because the limited number of electrodes in standard ECGs makes it difficult to capture the fine-grained details of cardiac electrodynamics across the entire heart. Therefore, body surface potential (BSP) mapping has been developed by deploying a larger number of ECG electrodes, such as Dalhousie Standard Torson 120 electrodes, to provide high-resolution spatiotemporal information about cardiac electrodynamics projected onto the body surface [8]. It allows for detailed mapping and localization of cardiac activity and thus has been widely used in the last decades for solving the ECG inverse problem. Nevertheless, the ECG inverse problem, like many other inverse problems, faces two primary challenges. Firstly, the problem is ill-posed, meaning that it may not have a unique solution and small errors in the input data can lead to significant errors in the output. Secondly, solving the ECG inverse problem can be computationally intensive, particularly when dealing with high-resolution BSP mapping data. The complex geometrical, mechanical, and electrical properties of the heart, as well as the need for real-time or near-real-time solutions in clinical applications, pose computational challenges.

### A. History: From Electrocardiography to Cardiac Digital Twins

Investigations of cardiac electrophysiology can be traced back to 1842 when Carlo Matteucci identified signs of cardiac electrical activity in frog hearts [9]. Dr. Augustus Waller furthered this research by recording the first human electrocardiogram in 1887, using a capillary electrometer and electrodes placed on the chest and back of a human subject [10]. His study demonstrated that electrical activity preceded ventricular contraction. Subsequently, in 1893, Einthoven coined the term “electrocardiogram” to describe the cardiac waveforms [11]. The American Heart Association (AHA) standardized the 12-lead ECG in 1954 [12], paving the way for advancements in cardiac electrophysiology. In 1960, Denis Noble developed one of the first mathematical models of a cardiac electric cell based on Hodgkin-

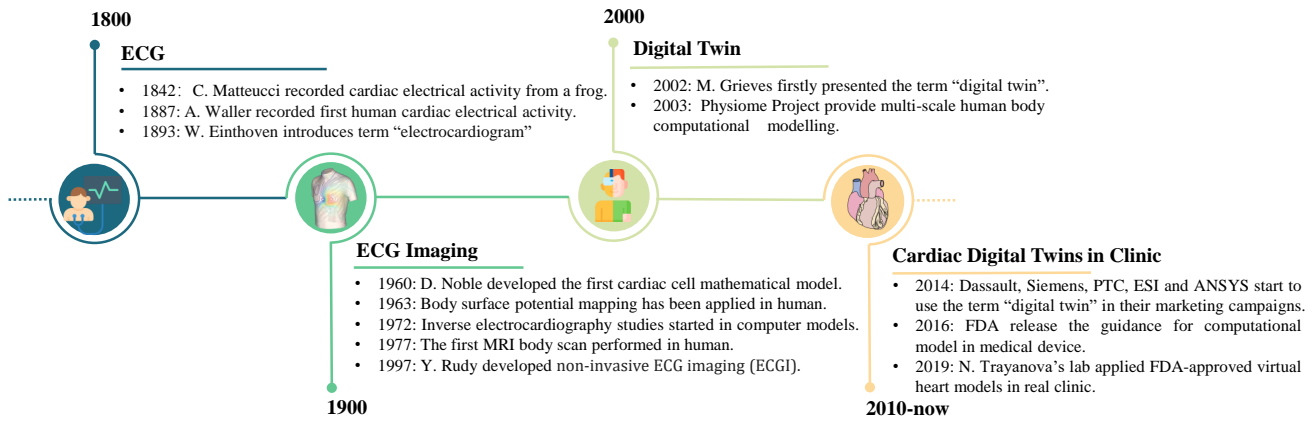

Fig. 2. Timeline of the development of ECG, imaging, and cardiac digital twins.

TABLE I

SEARCH ENGINES AND EXPRESSIONS USED TO IDENTIFY POTENTIAL PAPERS FOR REVIEW.

Engine	Google Scholar, PubMed, IEEE-Xplore, and Citeseer
Term	<p>"Electrocardiogram" or "ECG" or "EKG" or "electrocardiographic" or "electrophysiological" or "electrophysiology" or "EP" or "electrocardiography" or "body surface potential mapping" or "BSPM" <b>and</b></p> <p>"Inverse problem/ issue" or "inverse solution/ estimation/ inference/ reconstruction" or "cardiac model personalization" or "electrocardiographic imaging/ mapping" or "ECG-imaging" or "ECGI" or "activation imaging" or "noninvasive imaging" <b>and</b></p> <p>"Electrical activity/ excitation" or "surface potential" or "epicardial/ endocardial potential" or "action potential" or "transmembrane potential" or "activation sequence" or "activation wavefront" or "activation time map" or "pacing site" or "atrial potential" or "local parameter"</p>

Huxley equations, further refining it to characterize the long-lasting action and pacemaker potentials observed in the Purkinje fibres of the heart [13]–[15]. This laid the groundwork for cardiac simulations using computer models. Meanwhile, body surface potential mapping (BSPM) emerged as an alternative method for non-invasive and high-resolution measurement of human cardiac electrical activity in 1963 [16]. In 1970, Durrer *et al.* [17] conducted a seminal investigation into the electrical behavior of the human heart at the organ level. Since 1972, numerous studies have tackled the electrocardiography inverse problem using analytical and computational models [18]–[21], experimental animals [22], [23], and human subjects [24], [25]. Advancements in medical imaging have also enabled non-invasive visualization of cardiac anatomy since the inception of techniques like the first human MRI scan in 1977 [26]. The formalization of inverse procedures reconstructing bioelectric sources from BSPM and medical imaging led to the development of electrocardiographic imaging (ECGi) techniques, notably pioneered by Yoram Rudy's lab [27]–[31].

The concept of the digital twin was formally introduced in 2002 by Michael Grieves, though it can be traced back to NASA's use for the Apollo 13 rescue mission in 1970 [32]. The Physiome Project was initiated in 2003 with the aim of establishing a framework for modelling the human body, utilizing computational methods to integrate biochemical, biophysical, and anatomical information across cells, tissues, and organs [33]. Starting from 2014, many companies like Dassault, Siemens, and ANSYS embraced the term "digital twins" in their marketing initiatives. For example, Dassault

Systèmes initiated the Living Heart Project in 2014, which is the first comprehensive computer model of the human heart, integrating all functional aspects, i.e., blood flow dynamics, mechanical properties, and electrical conduction [34]. In recent years, digital twin tools have become popular in healthcare, such as cardiac digital twins [35], brain digital twins [36], etc. In 2016, the US Food & Drug Administration (FDA) Center for Devices and Radiological Health released the first guidance to enable the use of modelling and simulation to develop in silico trials [37]. In 2019, Trayanova's lab received FDA approval for a randomized clinical trial involving 160 patients, termed OPTIMA (OPTimal Target Identification via Modeling of Arrhythmogenesis), to demonstrate the effectiveness of cardiac digital twins in guiding atrial ablation procedures [3]. The brief timeline has been presented in Fig. 2.

## B. Study Inclusion and Literature Search

In this work, we aim to provide readers with a survey of the state-of-the-art solutions to electrocardiographic inverse problems. There exist several modalities for cardiac electrical activity assessment, such as ECG, BSP mapping, electrograms (EGM), electro-anatomic mapping (EAM), vectorcardiography (VCG), etc. However, in the context of solving the ECG inverse problem, we usually only involve ECG and BSP as the observed data. Note that compared to standard 12-lead ECG, BSP mapping is, however, not yet widely available as a diagnostic modality [38]. For cardiac activity representation, two major source models are employed, i.e., heart surface potential (HSP) and transmembrane potential defined on the volumetric mesh of the heart. Specifically, it can be further categorized into epicardial and/ or endocardial potential, activation time map/ activation wavefront, transmembrane potential, action potential duration map, voltage potential maps, isochrones/ isochrone maps, etc.

To ensure comprehensive coverage, we have screened publications mainly from the last 24 years (2000–2024) related to this topic. Our main sources of reference were Internet searches using engines, including Google Scholar, PubMed, IEEE-Xplore, Connected Papers, and Citeseer. To cover as many related studies as possible, flexible search terms have been employed when using these search engines, as summarized in Table I. There are several research teams and industry companies at the forefront of computational cardiology and electrocardiography, working to advance our understanding of cardiac function, arrhythmias, and heart-related disorders through computational methods and simulations<sup>1</sup>. We followed their recent works to obtain state-of-the-art methodologies and clinical applications. Both

<sup>1</sup>Continuously updating compilation of cardiac digital twin resources: [github.com/lileitech/Awesome-Cardiac-Digital-Twins](https://github.com/lileitech/Awesome-Cardiac-Digital-Twins)

TABLE II

SUMMARY OF THE RELATED REPRESENTATIVE EXISTING SURVEYS. DL: DEEP LEARNING; MCG: MAGNETOCARDIOGRAPHY; ATM: ACTIVATION TIME MAPS; AF: ATRIAL FIBRILLATION.

Source & Publish Year	Scope	Inclusion
Macleod <i>et al.</i> (1998) [7]	ECG inverse problem	conventional solutions
Dossel <i>et al.</i> (2000) [39]	ECG and MCG inverse problem	conventional solutions
Yaman <i>et al.</i> (2013) [40]	inverse problem for applied sciences	not for ECG; conventional solutions
Uhlmann <i>et al.</i> (2014) [41]	inverse problem	not for ECG; conventional solutions
Calvetti <i>et al.</i> (2018) [42]	inverse problem	not for ECG; conventional solutions
Genzel <i>et al.</i> (2022) [43]	inverse problem	not for ECG; mainly DL-based solutions
Arridge <i>et al.</i> (2019) [44]	inverse problem	not for ECG; mainly DL-based solutions
Sameni <i>et al.</i> (2010) [45]	fetal ECG analysis	fetal ECG; partially includes inverse problem
Bear <i>et al.</i> (2015) [46]	ECG forward problem	not for inverse problem
Hong <i>et al.</i> (2020) [47]	DL-based ECG analysis	not for inverse problem
Liu <i>et al.</i> (2021) [48]	DL-based ECG analysis	not for inverse problem
Somani <i>et al.</i> (2021) [1]	DL-based ECG analysis	not for inverse problem
Bifulco <i>et al.</i> (2021) [49]	translational applications of computational modelling	translational applications
Cantwell <i>et al.</i> (2015) [50]	ECG inverse problem	mainly focusing on the inference of ATM and CV
Cluitmans <i>et al.</i> (2015) [51]	ECG inverse problem	mainly focusing on conventional methods
Cluitmans <i>et al.</i> (2018) [52]	ECG inverse problem	mainly focusing on the validation and clinical application
Yadan <i>et al.</i> (2023) [53]	ECG inverse problem	mainly focusing on the identification of AF drivers
Hernandez <i>et al.</i> (2023) [54]	ECG inverse problem	mainly focusing on the atria

peer-reviewed journal papers and conference papers were included here. In the way described above, we have collected a comprehensive library of more than 200 papers. Note that we picked the most detailed and representative ones for this review when we encountered several papers from the same authors about the same subject.

### C. Existing Survey from Literature

Table II lists current review papers related to the topic, i.e., ECG inverse problem. One can see that the scopes of current review works are different from ours, though with partial overlaps. For example, there are several existing reviews focusing on summarizing solutions of inverse problems but not for ECG data [40]–[44]. Alternatively, there exist few surveys on the ECG analysis, but not focusing on the inverse problem [1], [46], [48]. Bifulco *et al.* [49] provided the potential clinical applications of the ECG inverse inference strategies, but it is not a methodological survey. Although Macleod *et al.* [7] and Dossel *et al.* [39] performed a methodology survey on the ECG inverse problem, we focus on the developments proceeding their reviews. Cantwell *et al.* [50] mainly summarized the techniques for local activation time annotation and conduction velocity estimation in cardiac mapping. We provide a comprehensive and up to date review of ECG inverse inference, encompassing both its recent methodological aspects and potential clinical applications.

## II. METHODOLOGY

### A. Definition of the Problem

The ECG inverse problem refers to the mathematical task of determining the electrical activity within the heart based on measurements of the ECG signals recorded on the body surface. It involves applying a quasi-static approximation of Maxwell's equations on the electromagnetic field between the heart and the torso to establish a relationship between the ECG data and the cardiac electrical excitation. Solving these equations numerically on subject-specific heart-torso models yields a linear measurement model,

$$\mathbf{y}(\mathbf{s}, t) = \mathbf{H}\mathbf{u}(\mathbf{s}, t) + \epsilon, \quad (1)$$

where  $\mathbf{y}(\mathbf{s}, t)$  and  $\mathbf{u}(\mathbf{s}, t)$  refer to the vector of ECG signals and cardiac electrical parameters at position  $\mathbf{s}$  and time instant  $t$ ,  $\mathbf{H}$  denotes the forward matrix, and  $\epsilon$  represents the noise term that accounts for measurement and modelling errors. Based on this physical system modelled by PDEs and/or ordinary differential equations (ODEs),

the typical solution of the problem is to inversely estimate  $\mathbf{u}(\mathbf{s}, t)$  that minimizes the fitting of the observational data  $\mathbf{y}(\mathbf{s}, t)$ ,

$$\min_{\mathbf{u}(\mathbf{s}, t)} \|\mathbf{y}(\mathbf{s}, t) - \mathbf{H}\mathbf{u}(\mathbf{s}, t)\|_2^2, \quad (2)$$

which however is ill-posed. The inverse problem can exhibit one of three characteristics: it may have multiple solutions (non-unique), no solution (non-existence), or solutions that are highly sensitive to small perturbations in the measured data (unstable) [55]. Moreover, it is typically influenced by measured input data that is frequently corrupted by random or stochastic noise.

To solve the ECG inverse problem, the state-of-the-art approaches can be coarsely separated into two kinds: deterministic and probabilistic methods [56], as presented in Fig. 3. Deterministic approaches in cardiac electrophysiology involve minimizing a cost function that quantifies the discrepancy between the observed data and the model predictions. Rather than aiming solely to minimize a cost function, probabilistic models embrace uncertainty and provide a probabilistic distribution over possible outcomes.

### B. Deterministic Estimation Approaches

1) *Spatial Regularization*: To stabilize and improve the solution of the ECG inverse problem, spatial regularization methods are employed [57]. These methods introduce spatial constraints to promote smoothness in the estimated electrical activities across the heart surface at different orders of derivatives [58]. The commonly used spatial regularization methods include Tikhonov regularization [24], truncated singular value decomposition (TSVD) [59], truncated total least squares (TTLS) [60], L1-norm regularization [61], and total variation (TV) regularization [62]. These approaches aim to minimize the impact of noise and improve the accuracy of the inverse solution. For example, the Tikhonov regularization, including both zero-order and first-order variants, is the most widely used regularization technique [24], [63]–[67]. It minimizes the mean squared error from the body-heart transformation while simultaneously penalizing the L2 norm of the inverse HSP solution. The objective function can be formulated as,

$$\min_{\mathbf{u}(\mathbf{s}, t)} \left\{ \|\mathbf{y}(\mathbf{s}, t) - \mathbf{H}\mathbf{u}(\mathbf{s}, t)\|_2^2 + \lambda_{Tikh}^2 \|\Gamma\mathbf{u}(\mathbf{s}, t)\|_2^2 \right\}, \quad (3)$$

where the notation  $\|\cdot\|_2^2$  represents the L2 norm,  $\lambda_{Tikh}$  denotes the regularization coefficient, and  $\Gamma$  is the operator constraining the

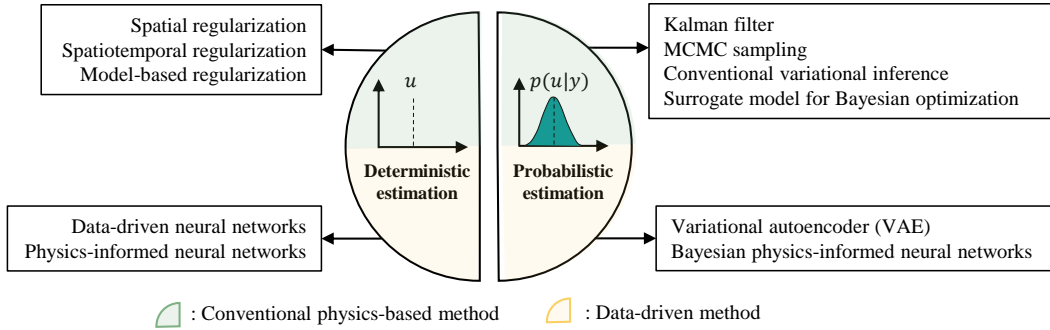

Fig. 3. Summary of the ECG inverse inference methodologies. MCMC: Markov Chain Monte Carlo.

HSP solution  $u(s, t)$ , which is an identity matrix for zero-order regularization and a spatial gradient operator for first-order regularization to increase the spatial smoothness of the inverse solution. This dual process effectively suppresses the unreliable components in the solution and enhances overall smoothness for improved accuracy. TSVD regularization method directly filters small singular values of the transfer matrix  $\mathbf{H}$  and thus be robust to noises. TTLS regularization is effective in processing geometric errors that exist in the ECG inverse problem [60]. L1-norm and TV regularization techniques are useful for addressing specific challenges in the inverse problem, such as noise suppression, sparsity, and edge preservation.

**2) Spatiotemporal Regularization:** While spatial regularization methods are effective and widely used in ECG inverse problems, they often treat the problem as a static spatial problem and ignore the temporal dynamics of cardiac electrical activity. In some cases, this assumption may be reasonable, especially for certain types of cardiac abnormalities or when the temporal variations in the electrical activity are relatively slow compared to the sampling rate. However, in situations where the temporal dynamics are critical or when the electrical activity changes rapidly, temporal regularization methods that explicitly consider the time-varying nature of the problem may be more appropriate. These methods can help capture dynamic changes in electrical activity over time and provide more accurate and physiologically relevant solutions.

To fuse the space-time correlations into the inverse ECG problem, spatiotemporal regularizations are employed for robust estimation of HSP. For instance, besides employing Tikhonov regularization in the spatial domain, Messnarz *et al.* [68] introduced additional temporal constraints by assuming that cardiac electric potentials are non-decreasing during the depolarization phase. Yao *et al.* [69] proposed a spatiotemporal regularization method by regularizing both the spatial and temporal smoothness in the inverse ECG modelling, with the following objective function,

$$\min_{\mathbf{u}(s,t)} \sum_t \left\{ \|\mathbf{y}(s, t) - \mathbf{H}\mathbf{u}(s, t)\|_2^2 + \lambda_s^2 \|\Gamma\mathbf{u}(s, t)\|_2^2 + \lambda_t^2 \sum_{\tau=t-\omega/2}^{\tau=t+\omega/2} \|\mathbf{u}(s, t) - \mathbf{u}(s, \tau)\|_2^2 \right\}, \quad (4)$$

where  $\lambda_s$  and  $\lambda_t$  are the spatial and temporal regularization terms, respectively, and  $\omega$  denotes the selected time window to incorporate the temporal correlation. Splines-based methods can use spline functions to represent the electrical activity on the heart surface over time. They take advantage of the smoothness properties of splines to regularize the inverse solution, effectively capturing both spatial and temporal variations in the electrical potentials [70]. A Kalman filter reformulation can incorporate temporal information to regularize the inverse problem [71], [72]. Recently, to achieve regularization

over space and time simultaneously, Cluitmans *et al.* [73] firstly applied regularization in the sparse wavelet domain for solving the ECG inverse problem, namely wavelet-promoted spatiotemporal regularization. Their experimental results indicate that the sparse representation of the cardiac source is beneficial for improving reconstruction accuracy in electrocardiographic imaging.

**3) Model-based Regularization:** Most existing regularization methods primarily rely on the optimization of the given observations, which are normally corrupted by noise in practice. In contrast, model-based regularization can integrate *prior* physiological knowledge about the electrical propagation inside the heart to constrain the solution space [74]. For instance, step jump functions and logistic functions have been employed to model the activation of action potential [75], [76]. Parameterized curves have been utilized to represent the wavefront velocity as trigonometric functions, while the potential has been modelled using the step response of a second-order linear system [72]. The ECG inverse problems can also be formulated via level-sets by evolving a boundary from an initial region to minimize a filtered residual error, allowing for iterative refinement of the solution. The major advantage of level-set-based methods is that no isotropy assumptions are required, allowing for more flexible modelling and accurate representation of complex geometries and phenomena within the heart [77]. To estimate transmural potentials throughout the myocardium, 3D biophysical EP simulation models have been employed to offer spatiotemporal constraints of the inverse issue [78]–[80].

While model-based regularization is effective in regularizing the ill-posed problem, their employed physiological models are developed for the general population [74], [79]. Specifically, the parameters of these models, which are typically linked to tissue characteristics (excitability and contractility of the heart muscle), are often assigned values commonly used in the literature. The general physiological models could overly constrain subject-specific information, leading to potential model errors and model-data mismatch [81]. For instance, the parameters controlling the configuration of the transmembrane potential (TMP) will differ throughout the heart, depending on whether the underlying tissue is in a healthy or diseased state. Therefore, Erem *et al.* [82] investigated how the solution changes when the assumption of uniform TMP amplitudes throughout the heart fails in the presence of infarction. Similarly, Xu *et al.* [81] and Dhamala *et al.* [83] emphasized the importance of uncertainty estimation in providing interpretable reconstructions of cardiac electrical activity.

**4) Data-Driven Neural Networks:** The notable rise in computational resources and the vast increase in available data have facilitated the development of data-driven models. Conventional deterministic models for ECG inverse problems typically rely on physics-based mathematical models, such as the bidomain, the monodomain, or the Eikonal model, to describe the propagation of electrical activity

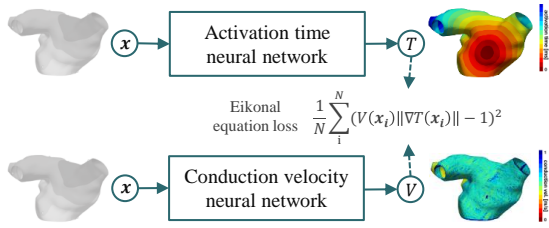

Fig. 4. Example of the physics-informed neural networks for the reconstruction of activation time map. Here, the Eikonal equation has been employed as an additional physical constraint [91]. Image modified from Sahli [91] with permission.

through the heart. In contrast, data-driven deterministic models can employ neural networks to directly learn the mapping from ECG data to the underlying electrical sources without relying on explicit physics-based equations. These models are highly flexible and can capture complex, non-linear relationships in the data. They do not rely on strong assumptions about the underlying physiology, making them suitable for cases where the true underlying model is not well-known, varies across patients, or displays unexpectedly abnormal behavior. Therefore, they have been employed to solve the ECG inverse problem. For example, Meister *et al.* [84] designed a deep learning method based on graph convolutional neural networks (CNNs) to estimate the depolarization patterns in the myocardium with scars. By leveraging the inherent graph structure of the cardiac anatomy, graph CNNs enable the extraction of spatial dependencies and patterns, facilitating a more nuanced representation of electrocardiographic data. Tenderini *et al.* [85] utilized a PDE-aware deep learning model for epicardial potential (EpiP) reconstruction from ECG data. Camara *et al.* [86] converted the BSP into an image represented by a 3D matrix and then employed CNNs to predict the locations of AF drivers from BSP. Neumann *et al.* [87] employed a reinforcement learning model to achieve multi-physics computational model personalization. Similarly, the time delay neural network can employ both current and previous timestep values of BSP to predict the HSP [88]–[90]. However, these purely data-driven models generally lack interpretability and may underperform in scenarios with limited data due to their data-intensive training requirements.

5) **Physics-Informed Neural Networks:** Physics-informed neural networks (PINNs) are data-efficient as they leverage both available data and the known physics equations [94]. They have recently been used to solve inverse problems with hidden physics, including the ill-posed ECG inverse problems [95]. This can be achieved either via introducing underlying physical constraints as an additional loss [95], [96], or designing specialized network architectures that satisfy the physics laws [92], [97]. For instance, Xie *et al.* [95] combined the data-driven loss and physics-based loss to inversely predict the heart-surface potentials from BSP and evaluated their framework in a 3D torso-heart geometry. Ye *et al.* [96] proposed a spatial-temporally adaptive PINN framework for solving both ECG forward and inverse problems over 3D bi-ventricular models. Sahli *et al.* [98] used PINNs in forward mode to estimate activation time maps (ATMs) and conduction velocity (CV) maps, as shown in Fig. 4. They incorporated a physics-informed regularization loss prescribed by the Eikonal equation, which describes the relationship between ATMs and the spatial gradient of CV. Similarly, Herrero *et al.* [97] developed a PINN model for action potential reconstruction and EP parameter estimation from sparse amounts of EP data. Although they did not inversely infer ATMs from BSP or ECG, a similar idea can be employed to solve the ECG inverse inference problem. Instead of introducing additional loss, Jiang *et al.* [92] proposed a spatial-temporal graph CNN-based non-Euclidean encoding-decoding

model, where the geometry-dependent physics between BSP and HSP can be explicitly modelled via a bipartite graph over their graphical embeddings, as presented in Fig. 5. In general, the use of PINN in cardiac EP is mainly limited to 1D/ 2D *in silico* data, as it could be computationally expensive in realistic 2D/ 3D settings [96], [97].

### C. Probabilistic Estimation Approaches

Unlike deterministic regularization techniques, probabilistic or stochastic estimation methods provide solutions in the form of probability distributions. Consequently, multiple potential solutions can be derived from the distributions, effectively addressing the inherent uncertainties within the data and the models relevant to the ECG inverse inference [19]. Specifically, the inverse problem can be formulated as the estimation of a Bayesian posterior probability distribution function (pdf), which can be defined as,

$$p(\mathbf{u}|\mathbf{y}) \propto p(\mathbf{y}|\mathbf{u}, \epsilon)p(\mathbf{u}), \quad (5)$$

where  $p(\mathbf{u})$  is the prior, and the likelihood  $p(\mathbf{y}|\mathbf{u}, \epsilon)$  can be modeled as a normal distribution  $\mathcal{N}(\mathbf{H}\mathbf{u}, \epsilon\mathbf{I})$  [99]. One can predict the mode of the posterior distribution via maximum a posteriori (MAP) estimator, which is a point estimator that finds the parameter value that maximizes the posterior pdf given the observed data. When dealing with the complex dynamics of cardiac electrical activity, the Kalman filter serves as a specialized instance of the MAP estimator, enabling the integration of spatio-temporal information for the ECG inverse inference [100]. Alternatively, to estimate the entire posterior distribution, one can employ Markov Chain Monte Carlo sampling or variational inference for approximating analytically intractable posterior distributions. These approaches allow for a more comprehensive understanding of the cardiac electrical activity, taking into account the inherent variability and errors in the data and models, ultimately leading to more reliable and interpretable results.

1) **Kalman Filter:** The Kalman filter (KF) is a well-established tool for state estimation in dynamic systems. In the context of cardiac modelling, it implicitly estimates the posterior distribution of the underlying electrical activity given the observed ECG measurements. This is achieved by modelling the cardiac system as a high-dimensional stochastic state-space model, where the KF or its extensions can be effectively applied [79]. The key concept involves estimating the state  $\mathbf{u}(s, t)$  by sequentially updating its estimate in the presence of noisy observations. The state transition is described as follows,

$$\mathbf{u}(s, t) = \mathbf{F}\mathbf{u}(s, t-1) + \mathbf{w}_t, \quad (6)$$

where  $\mathbf{F}$  refers to the state transition matrix (STM) and  $\mathbf{w}_t$  is the process noise vector which models uncertainties and errors arising from the STM [101]. Then, the KF calculates the Kalman gain and uses it to update the state estimate based on observed data, considering spatio-temporal variations within cardiac source distributions. It provides not only a point estimate of the state but also a covariance matrix that represents the uncertainty associated with the estimate. By modelling both the dynamics of the system and the measurement noise probabilistically, KF inherently accounts for uncertainty in the estimation process.

To reduce computational complexity, researchers often focus on temporal relationships among spatially well-correlated regions, such as neighbouring regions or leads belonging to the same activation wavefront. They may also employ methods like expectation-maximization (EM) and residual-based techniques to estimate noise variances [101]. Other formulations, like the Duncan and Horn formulation of the KF used by Berrier *et al.* [71], focus on reconstructing specific electrograms. Wang *et al.* [79], in an attempt to integrate general prior knowledge with subject-specific data, used

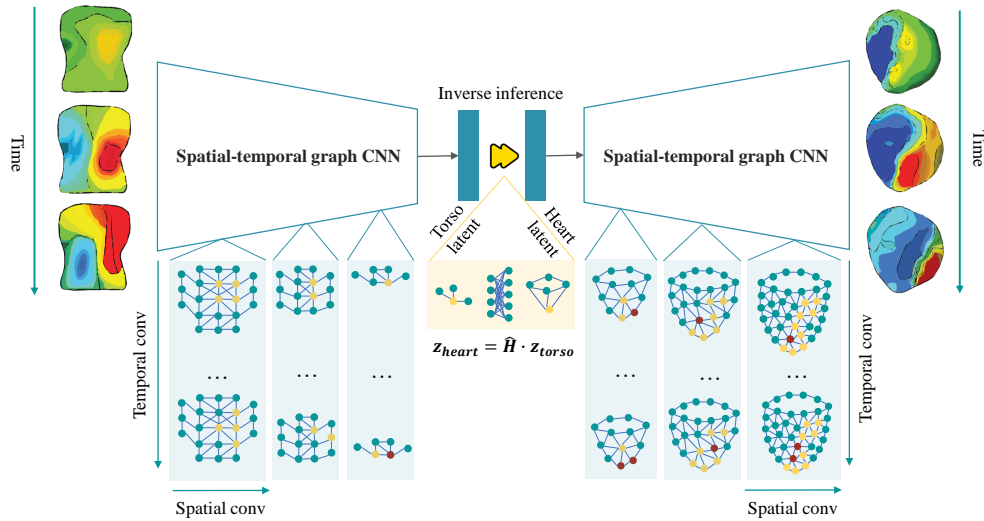

Fig. 5. Example of the physics-based model based on graph convolutional neural networks (CNNs) for the inverse inference of epicardial potential from body surface potential (BSP) [92]. Illustrations designed referring to Jiang *et al.* [92] and Bear *et al.* [93].

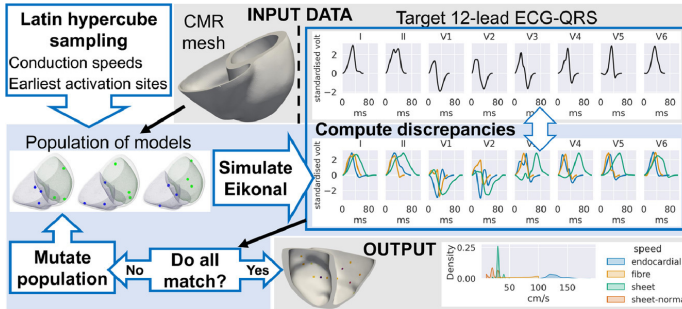

Fig. 6. Example of the MCMC application on the inverse inference of cardiac activation properties from ECG. Here, MCMC has been used for the sampling of parameter sets of the population [103]. Image adapted from Camps *et al.* [103] with permission.

a statistical perspective to explicitly account for both model and data errors. They represented the cardiac electrophysiological system in a state-space form and conducted inverse inference of 3D TMP distributions via the unscented KF. A similar strategy was employed to define both the electrical and mechanical measurements as the state variables, which can be estimated via the unscented KF [102]. While the KF is a powerful tool for state estimation in cardiac modelling, it involves large matrices operation and may suffer from the initialization problem.

**2) Markov Chain Monte Carlo Sampling:** Current probabilistic inference approaches are generally based on Markov Chain Monte Carlo (MCMC) sampling methods to handle complex probabilistic models and uncertainty associated with ECG data [104]. For instance, Camps *et al.* [103] presented a sequential Monte Carlo approximate Bayesian computation-based model for the inference of ventricular activation properties. Rahimi *et al.* [105] applied a hierarchical Bayesian inference to estimate the statistical parameters in the posterior pdf, which can be calculated via MCMC sampling methods. However, direct MCMC sampling of the pdf of the parameters can be impractical, as it involves repeated evaluations of the posterior pdf which consists of computationally expensive simulation model. To accelerate sampling, various hybrid sampling techniques have been developed using information about the target pdf such as gradient and Hessian matrix [106], which however are challenging to extract when dealing with complex simulation models. Alternatively, one could develop computationally efficient surrogate models of the

expensive simulation process, making it significantly faster to sample the associated pdfs [107], [108]. Despite improved efficiency, direct sampling of surrogate-based posterior pdf may yield limited accuracy, given the challenge of creating accurate approximations for complex nonlinear simulation models. Instead of completely replacing the sampling of the exact posterior pdf, Dhamala *et al.* [83] proposed a two-stage model to integrate Gaussian process surrogate modelling of the posterior pdf in accelerating sampling. Also, one could directly develop a surrogate model for the posterior pdf of simulation model parameters, eliminating the necessity for additional MCMC sampling of the computationally intensive original pdf [104].

**3) Variational Inference:** Variational inference (VI) approximates the posterior distribution with a simpler variational distribution by solving an optimization problem. This optimization process is often computationally more efficient than MCMC sampling as it does not require repeated sampling from the posterior distribution. Therefore, the application of VI has been widely adopted in solving the ECG inverse problem [74]. For instance, Xu *et al.* [99] introduced a Bayesian inference framework for robust transmural electrophysiological imaging. Ghimire *et al.* [74] proposed a Bayesian model for the estimation of the prior model error while reconstructing TMP under the constraint of a 3D EP simulation model. These conventional VI methods are generally optimized using techniques such as gradient descent and expectation-maximization (EM) algorithms.

Recently, deep learning-based probabilistic methods have served as an emerging alternative to conventional methods for modelling complex dynamics of cardiac electrical activity [109]–[111]. They can leverage deep neural networks to approximate the posterior distribution of the model parameters or latent variables, providing faster and more accurate approximations. For example, Ghimire *et al.* [109] proposed a deep generative model to reconstruct cardiac transmembrane potential from ECG data. Bacoyannis *et al.* [112] employed a variational auto-encoder (VAE) model to reconstruct the activation pattern of the myocardium with various local wall thicknesses as thin walls indicated infarct areas. Bacoyannis *et al.* [113] employed conditional VAE to generate activation maps from combined BSP and conductivity maps. Li *et al.* [114] designed a VAE-based deep computational model for the inverse inference of ventricular activation properties, i.e., root node (RN) position and CVs. Dhamala *et al.* [115] employed a graph convolutional VAE to allow generative modelling of non-Euclidean data for cardiac model personalization. Dhamala *et al.* [110] proposed a generative VAE for

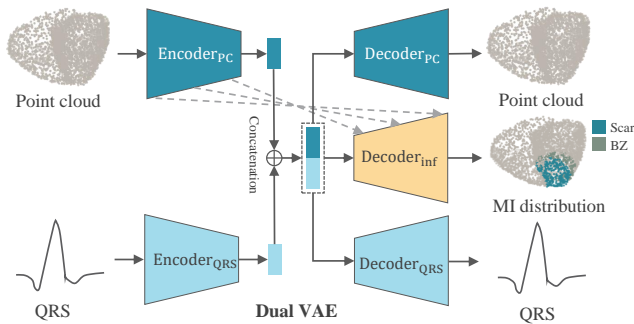

Fig. 7. Example of the conditional-VAE model for the inverse inference of myocardial infarction (MI) [116]. Image adapted from Li *et al.* [116] with permission.

parameter estimation of a personalized cardiac model. Yang *et al.* [111] proposed Bayesian PINN to solve linear or nonlinear PDEs with noisy data for both forward and inverse problems. They employed the Hamiltonian Monte Carlo or the variational inference for the estimation of the posterior distributions.

4) *Surrogate Model for Bayesian Optimization*: To accelerate the inverse inference of parameters, surrogate models, especially statistical emulation with Gaussian processes (GP), have been employed in cardiovascular fluid dynamics [117], the pulmonary circulatory system [118], ventricular mechanics [119], and LV cardiac dynamics [117]. It involves approximating the computationally intensive mathematical model (the simulator) with a computationally efficient statistical surrogate model (the emulator) [117]. This is achieved through a combination of extensive parallelization and GP regression, allowing for optimal utilization of computational resources prior to the patient arrival at the clinic. Here, GP regression is a non-parametric Bayesian approach used for regression tasks where the model learns from the observed data to make predictions. It does not assume a specific parametric form for the underlying function but instead models the function as a distribution over functions, which is determined by the observed data points. Therefore, when new data are accessible, the proxy objective function can be minimized at a low computational cost. This eliminates the need for additional computationally intensive simulations from the original mathematical model and thus accelerates the inference. Recently, the GP surrogate model started to be used in the ECG inverse inference by Pezzuto *et al.* [120], where the GP surrogate model with Bayesian optimization has been used for the inverse inference of RNs. These strategies offer a mid-way solution between pure sampling methods using mechanistic models and machine learning-based solutions as the variational inference. They retain the flexibility and interpretability of pure sampling methods while replacing the mechanistic model with a faster emulator, which can be machine learning-based.

### III. UNCERTAINTY QUANTIFICATION FOR THE ECG INVERSE PROBLEM

Solving the ECG inverse problem relies on many subject-specific measurements and modelling assumptions, which introduce various sources of uncertainty in the predictions. Uncertainty quantification aims to analyze how models respond to inherent variability in input parameters. ECG inverse problems are often ill-posed and lack uniqueness in their solutions. However, clinicians typically require a single prediction for practical decision-making purposes in patient care scenarios. Therefore, it is essential to quantify and mitigate the effects of different types of uncertainties to ensure the robustness and clinical applicability of ECG inverse solutions.

#### A. Measurement Acquisition Uncertainty

ECG inverse inference requires subject-specific EP measurements, which can be easily distorted by noise artifacts, such as motion artifacts. EP data typically exhibit sparsity, with measured values associated with a higher degree of uncertainty [121]. For example, noise, a ubiquitous challenge in real-world measurements, can significantly distort the recorded ECG signals, introducing uncertainty into the source localization. To reduce the effects of measurement noise on the inverse problem, Aydin *et al.* [101] used a Kalman filter-based approach. Dogrusoz *et al.* [122] employed Bayesian estimation for solving the inverse ECG problem by applying various prefiltering methods to reduce the effects of noise. Similarly, Neumann *et al.* [123] utilized stochastic parameter estimation, aggregating probabilities estimated under various noise levels to derive a robust parameter estimate without explicitly determining the level of noise in the measurement. Moreover, there is ambiguity in matching the measurement points in the BSPM recording with the computational mesh derived from imaging data due to the non-synchronized BSPM-imaging acquisition [107]. The heart position is also susceptible to various sources of movement artifacts, including respiration and cardiac contraction, introducing geometric errors into the inverse problem of ECG solutions [124]. Therefore, the geometric error in the anatomical modelling (forward model) should also be considered, as it will in turn cause estimation errors in the ECG inverse inference.

#### B. Anatomical Modeling Uncertainty

The anatomical modelling is normally started with image segmentation, and then numerical solution techniques will be used to solve the forward ECG problem [58]. Therefore, the precision of the anatomical model employed, hinging on segmentation accuracy [125], [126], inter-subject anatomical variations [127], structural remodelling of the myocardium [116], and mesh resolution [128], profoundly influences the reliability of inverse solutions. Incorporating a prior model can mitigate uncertainties, and a combination of prior models may be preferred for estimating complex source structures [105]. Also, one can disentangle the inter-subject anatomical variation to mitigate its effect on the ECG inverse problem [127]. Furthermore, biventricular pacing and scar size, often encountered in clinical scenarios, demand meticulous modelling for a faithful representation [129]. Besides the heart, the torso geometry accuracy can also subtly influence the inverse solution, as the EP measurement is generally performed on the body surface [130]. In most studies, each torso surface node often corresponds to an electrode, and thus insufficient electrodes may lead to non-representative mesh nodes, requiring interpolation techniques for solving the inverse problem [131]. Dogrusoz *et al.* [131] investigated the effects of interpolation on the inverse problem of ECG. There also exist many studies exploring the effects of cardiac position inside the torso on the inverse inference [132], [133]. To address uncertainties, advanced regularization techniques that encompass prior knowledge, noise reduction strategies, and advanced data assimilation methods show promise [58], [134]. As the field advances, careful consideration of these effects becomes paramount for robust and clinically meaningful results in solving the ECG inverse problem.

#### C. Computational Modeling Assumption Uncertainties

Model assumptions are necessary simplifications or idealizations of reality that are made to facilitate mathematical or computational modelling. These assumptions may include assumptions about tissue properties, boundary conditions, geometry, and physiological processes. In ECG inverse inference, assumptions are often made about the homogeneity of tissue properties, the behavior of electrical

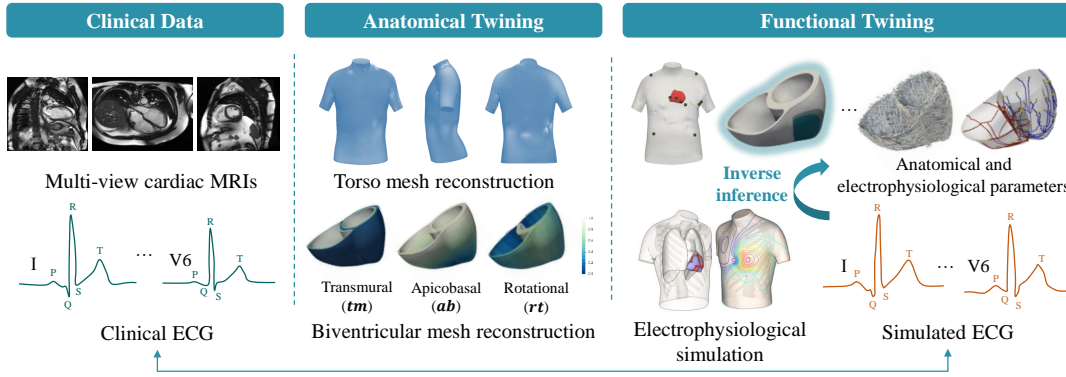

Fig. 8. The cardiac digital twin generation workflow combining cardiac imaging and ECG data, with ECG inverse inference for personalization. Image modified from Li *et al.* [116] with permission.

signals within the heart, and the relationship between measured ECG signals and underlying electrical activity [126], [135], [136]. While model assumptions are essential for simplifying complex systems, they can also introduce uncertainties and errors into the modelling process. For example, assuming uniform tissue properties throughout the heart and torso may lead to inaccuracies in the predicted electrical activity, especially in regions with significant heterogeneity [53], [130]. Similarly, assuming specific boundary conditions or physiological behaviors may not fully capture the complexity of real-world scenarios, leading to discrepancies between model predictions and observed data. ECG inverse inference also depends heavily on the assumptions on the initial distribution of heart electrical potential [135]. Determining the initial potential distribution at the onset of the cardiac cycle is particularly challenging due to the difficulty in accurately pinpointing the anatomical site of the earliest excitation in the heart, often associated with the intricate Purkinje networks [95]. Therefore, sophisticated modelling strategies are required to adequately account for the influence of these networks on ECG inverse inference [137], [138]. Once uncertainties are quantified, strategies can be employed to mitigate their impact on model predictions. The process of balancing model assumptions and uncertainty is often iterative, requiring continuous refinement and validation of models against experimental or clinical data. This iterative refinement process helps researchers to build more robust and reliable models over time.

#### IV. DATASET AND EVALUATION

##### A. Dataset

The solution to the ECG inverse inference problem is typically implemented within a cardiac digital twin platform, as shown in Fig. 8. Therefore, for evaluation purposes, access to both anatomical data from cardiac imaging and electrical activity recording data from ECG or BSP mapping is necessary. While there are many public cardiac imaging data [139]–[144] and ECG recordings [145]–[148], the evaluation of ECG inverse inference methods requires paired imaging and ECG/ BSP mapping data from the same patient, which is less publicly available. UK Biobank (UKB) [149] and China Kadoorie Biobank (CKB) [150], [151] provide paired imaging and ECG dataset. MyoFit46 includes 500 participants of approximately 75 years+ to undertake high-density surface ECGI and cardiac MRI [152]. Strocchi *et al.* [153] provided a publicly available virtual cohort of twenty-four four-chamber hearts built from heart failure patients. Experimental Data and Geometric Analysis Repository (EDGAR) is another public dataset for the application and validation of ECGI techniques [154]. It includes paired BSPM and endocardial/ epicardial recordings from both animals (dog, pig, etc) and human and torso tank datasets. Additionally, information regarding the cardiac

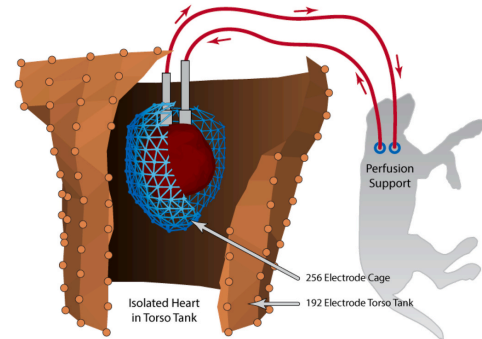

Fig. 9. Illustration of Utah Torso Tank, with an isolated canine heart. Image adapted from Bergquist *et al.* [157] with permission.

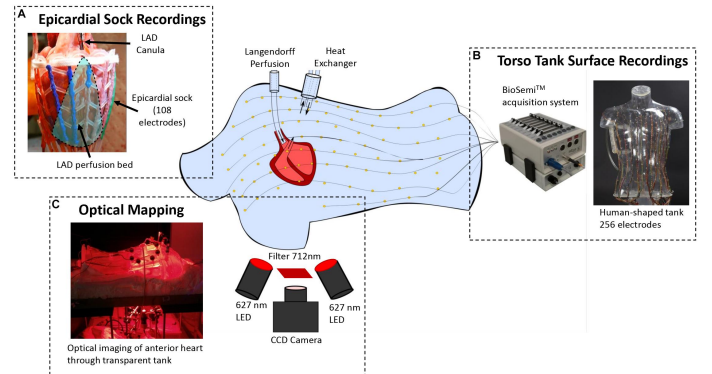

Fig. 10. Illustration of Bordeaux Torso Tank, with a pig heart perfused in Langendorff mode with a 108-electrode sock placed over the ventricles. Image adapted from Bear *et al.* [158] with permission.

position within the torso is essential, often requiring torso image data. Several studies have attempted to reconstruct the torso directly from standard cardiac imaging for the localization of electrodes, which was challenging due to partial torso shape information [155], [156]. There are also many validation studies conducted in ex vivo torso tanks [157]–[159], in vivo large animal models [93], [160], [161], or in patients [25], [162]. Fig. 9 and Fig. 10 provide the two most commonly used ex vivo torso tanks.

##### B. Evaluation

The validation of the inverse problem involves a diverse set of cardiac source models, forward EP model formulations, and inverse methods, as presented in Table III. For simplicity, we organized the validation according to the estimated cardiac source models, including surface potential models, activation/ recovery models, and



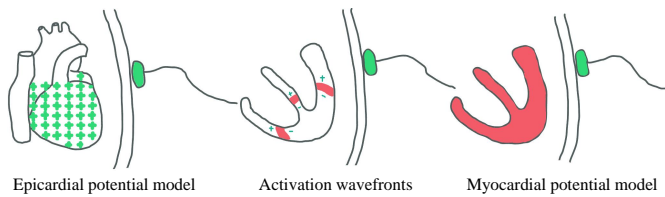

Fig. 11. Illustration of different cardiac source models in ECG.

transmembrane voltage models [52]. Fig. 11 provides three representative examples corresponding to the three source models. Except for a few studies, all the others employed BSP as the input representation/measurement for cardiac electrical activity assessment. One can see that most studies employed computer models for *in silico* evaluation [66], [163] and/or performed evaluation on the basis of torso-tank experiments with isolated animal hearts, such as rabbit [164], canine [73], [77], [92], and swine [165]–[167]. There are also few studies evaluated using *in-vivo* human subjects, which however usually employed non-simultaneous invasive recordings, such as EGMs [168], [169] or bipolar voltages maps [74], [81]. The comparison with the published invasive measurements in animals or humans has also been utilized as an alternative evaluation [24].

1) *Surface Potential Model*: The prevalence of potential map estimation on the cardiac surface can be attributed to its practicality and clinical significance. It provides a powerful and accessible means of understanding cardiac electrical behavior. Electrophysiological information reconstructed on the cardiac surfaces, such as the epicardium or endocardium, is relatively easier to obtain and is invaluable for clinical insights. Most surface potential inference work primary focused on the reconstruction of epicardial (outer) potential rather than endocardial (inner) potential. This is reasonable, as epicardial potential is more accessible for measurement compared to endocardial potential. As for the forward EP model, boundary element, finite element, and Aliev-Panfilov (AP) model have been widely used.

2) *Activation/ Recovery Model*: Activation and recovery time maps offer valuable static isochrone images depicting the sequence of cardiac electrical depolarization and repolarization. These isochrones can be applied in the clinic in various aspects: (a) identifying sites where activation initiates, as seen in focal arrhythmias, e.g., premature ventricular contractions (PVC) origin; (b) mapping reentry circuits, e.g., in macroreentrant atrial flutter; (c) detecting abnormalities in propagation, including areas with delayed activation [190] or those exhibiting slow or abnormal conduction, e.g., scar-related ventricular tachycardia (VT) substrate; and (d) pinpointing areas with recovery abnormalities, e.g., large recovery gradients [191], [192]. To date, the majority of validation studies have concentrated on the accuracy of activation mapping, with only a few studies assessing recovery [76], [193].

Besides, one could estimate activation parameters for personalization. The estimation of EP parameters from ECG or BSP is relatively rare, as these parameters are typically more detailed and are best captured through invasive electrophysiological studies or high-resolution mapping techniques. For example, Grandits *et al.* [194] employed Huber regularization to estimate simultaneously distributed fibre architecture and CVs from sparse contact recordings.

3) *Transmembrane Potential Model*: Using the transmembrane potential (TMP) as a cardiac source model offers a highly accurate approximation of the cardiac actual electrical source [52]. Estimating volumetric myocardial TMP dynamics is clinically significant as it unveils intricate arrhythmic details and intramural arrhythmogenic substrates. However, this necessitates complex modelling and interpretation of electrical activity within the 3D cardiac structure.

Reconstructions of TMP support the identification of depolarized and repolarized regions in the heart and their temporal evolution. They also delineate areas of reduced amplitude or completely absent TMP, such as ischemic, fibrotic, or border-zone areas. Nevertheless, TMPs cannot be directly measured in the clinic, necessitating indirect validation via extracellular signals generated by TMP distributions. Surface potentials on the endocardial and epicardial surfaces, as well as activation and recovery times, can be calculated from TMP distributions and then measured in experiments.

## V. CLINICAL APPLICATION

Inverse modelling of electrocardiographic signals can help to create a personalized virtual heart, which can be potentially applied for: (a) preoperative planning for cardiac surgery, (b) risk stratification and long-term monitoring, and (c) personalized disease insight and diagnosis.

### A. Preoperative Planning for Cardiac Surgery

Virtual heart models enable surgeons to simulate different surgical interventions and assess their feasibility and potential outcomes in a risk-free environment. For instance, utilizing personalized virtual-heart technology enables the identification of optimal infarct-related ablation targets for VT [193], [195], [196]. This can be accomplished by performing virtual multi-site delivery of electrical stimuli (pacing) from various bi-ventricular locations. Each location attempts to induce VT from a site positioned differently relative to the infarct area. The optimal ablation lesions can then be determined in each personalized virtual heart, rendering it non-inducible for VT from any pacing location. Therefore, it can terminate not only clinically manifested or induced VTs during the procedure but also all potential VTs arising from the post-infarction substrate. This includes VTs that may emerge after the initial ablation, potentially eliminating the need for repeated procedures and providing long-term freedom from VT for patients. Similarly, this technology allows for the preoperative identification of optimal ablation targets for AF, as shown in Fig. 12. It has proved invaluable in guiding ablation strategies, enabling clinicians to target specific areas responsible for atrial arrhythmias more effectively [3]. For MI management, ECG inverse inference aids in delineating the extent and location of ischemic regions within the myocardium [74], [116]. It can also be utilized to detect pulmonary vein (PV) drivers and thus assist in identifying patients with high acute success rates to PV isolation [197]. Furthermore, surgeons can virtually implant cardiac devices such as pacemakers, defibrillators, or transcatheter valves to evaluate their placement and function. Additionally, complex surgical procedures such as coronary artery bypass grafting and valve repair or replacement can be simulated to optimize surgical strategies, minimize operative risks, and improve patient outcomes.

### B. Risk Stratification and Long-Term Monitoring

In risk stratification, ECG inverse inference techniques contribute by unravelling intricate electrophysiological patterns that signify an increased risk of adverse cardiac events. For instance, Arevalo *et al.* [2] created a virtual-heart arrhythmia risk predictor (VARP) for sudden cardiac death (SCD) based on a virtual heart model, as shown in Fig. 13. The heart model integrates the ventricular geometry of the patient, structural remodelling resulting from post-MI and electrical functions from sub-cellular to organ levels. Within each heart model, a virtual multi-site delivery of electrical stimuli originating from ventricular locations at varying distances to the remodelled tissue can be performed. This comprehensive evaluation

TABLE III

SUMMARY OF THE ECG INFERENCE WORKS. EP: ELECTROPHYSIOLOGY; AS: ACTIVATION SEQUENCE; EGM: ELECTROGRAMS; HF: HEART FAILURE; HS: HEALTHY SUBJECT; EpiP/ ENDOP: EPICARDIAL/ ENDOCARDIAL POTENTIAL; RN: ROOT NODE; VCG: VECTORCARDIOGRAPHIC; AP: ALIEV-PANFILOV; LSTM: LONG SHORT-TERM MEMORY; FCN: FULLY CONNECTED NEURAL NETWORK; TV: TOTAL-VARIATION.

Source & Publish year	Data	Input	Target	EP model	Inverse inference method
Ramanathan <i>et al.</i> (2004) [24]	1 HS; 3 patients	BSP	EpiP, EGM, isochrones	boundary element	Tikhonov regularization + generalized minimal residual algorithm
Shou <i>et al.</i> (2008) [60]	in silico	BSP	EpiP	finite element	truncated total least squares
Wang <i>et al.</i> (2009) [63]	in silico	BSP	EpiP	finite element	Tikhonov regularization
Jiang <i>et al.</i> (2009) [170]	in silico	BSP	EpiP	boundary element	subspace preconditioned LSQR
Sarikaya <i>et al.</i> (2010) [59]	1 canine	BSP	EpiP	N/A	genetic algorithm with conventional regularization
Wang <i>et al.</i> (2010) [171]	1 canine	BSP	EpiP	finite element	variational-form-based regularizers
Wang <i>et al.</i> (2011) [172]	1 canine	BSP	EpiP	finite element	variational regularizers
Cluitmans <i>et al.</i> (2013) [168]	1 patient	BSP	EpiP	N/A	realistic data and VCG based optimization
Zemzemi <i>et al.</i> (2013) [173]	in silico	BSP	EpiP	bidomain	Steklov-Poincare formulation + gradient descent method
Zemzemi <i>et al.</i> (2014) [174]	in silico	BSP	EpiP	bidomain	iterative Kozlov-Maz'ya-Fomin
Erem <i>et al.</i> (2014) [82]	in silico; 1 HS	BSP	EpiP, EndoP	N/A	temporal spline model
Yao <i>et al.</i> (2017) [175]	4 MI patients	BSP	EGM, MI	N/A	spatiotemporal regularization
Cluitmans <i>et al.</i> (2017) [176]	3 canine	BSP	EpiP	AP	physiology-based regularization
Cluitmans <i>et al.</i> (2018) [73]	3 canine	BSP	EpiP, ATM, beat origin	N/A	multitask elastic-net-based method
Kalinin <i>et al.</i> (2019) [163]	in silico	BSP	EpiP, EndoP	bidomain	single layer approach
Karoui <i>et al.</i> (2019) [88]	in silico	BSP	EpiP	monodomain	spatial adaptation of time delay neural network
Bear <i>et al.</i> (2020) [65]	4 canine/swine	BSP	EpiP, ATM	boundary element	Tikhonov regularization
Rababah <i>et al.</i> (2021) [67]	6 canine/swine	BSP	EpiP, ATM	boundary element	Tikhonov regularization
Ozkoc <i>et al.</i> (2021) [177]	1 canine	BSP	EpiP	boundary element	Bayesian MAP
Chen <i>et al.</i> (2022) [167]	5 swines	ECG	EpiP, ATM, RN	N/A	FCN, CNN, LSTM model
Tenderini <i>et al.</i> (2022) [85]	in silico	ECG	EpiP	AP	PDE-aware deep learning model
Jiang <i>et al.</i> (2022) [92]	1 canine	BSP	EpiP	AP	physics embedded graph CNN
Xie <i>et al.</i> (2023) [178]	in silico	BSP	EpiP	AP	physics-constrained network
Jiang <i>et al.</i> (2024) [179]	in silico; 3 patients	BSP	EpiP, EndoP	reaction-Eikonal model	neural state-space modeling
Messnarz <i>et al.</i> (2004) [68]	in silico	BSP	TMP	bidomain	spatiotemporal regularization
Wang <i>et al.</i> (2009) [79]	in silico	BSP	TMP	bidomain	physiological-model-constrained statistical approach
Wang <i>et al.</i> (2011) [180]	in silico	BSP	TMP, MI	bidomain	physiologically-based constraints
Potyagaylo <i>et al.</i> (2012) [181]	in silico	BSP	TMP	N/A	iterative Gauss-Newton optimization
Jiang <i>et al.</i> (2013) [182]	in silico	BSP	TMP	bidomain	Support vector regression
Lopez <i>et al.</i> (2014) [183]	in silico	BSP	TMP	monodomain	genetic algorithm with Tikhonov regularization
Xu <i>et al.</i> (2014) [81]	in silico; 6 patients	BSP	MI	N/A	variational Bayesian with TV prior
Zettinig <i>et al.</i> (2014) [38]	in silico	ECG	Myo electrical diffusivity	LB	polynomial regression
Ghimire <i>et al.</i> (2019) [74]	in silico; 2 patients	ECG	TMP	finite element	Bayesian model
Kara <i>et al.</i> (2019) [64]	in silico	BSP	TMP, MI	bidomain	Tikhonov regularization
Cheng <i>et al.</i> (2021) [184]	in silico	BSP	TMP, MI	bidomain	shrinkage-thresholding network
Mu <i>et al.</i> (2021) [185]	in silico	BSP	TMP	N/A	shrinkage-thresholding + graph CNN
Zhao <i>et al.</i> (2022) [186]	in silico	BSP	TMP	bidomain	data-driven Kalman filtering network
Li <i>et al.</i> (2024) [116]	in silico	ECG	MI	Eikonal	multi-modal VAE
Lian <i>et al.</i> (2024) [187]	in silico; 4 patients	ECG	MI	bidomain	frequency-enhanced model
Zhang <i>et al.</i> (2005) [164]	4 rabbits	BSP	ATM	N/A	N/A
Calderero <i>et al.</i> (2005) [77]	1 canine	BSP	activation wave-front	potential-based	level sets
Alawad <i>et al.</i> (2019) [188]	in silico; 3 patients	ECG	pacing sites	N/A	L1-norm regularization
Schuler <i>et al.</i> (2021) [66]	in silico	BSP	ATM	bidomain	Tikhonov regularization
Pezzuto <i>et al.</i> (2021) [169]	11 HF patients	ECG	ATM, RN	Eikonal	propagation model
Meister <i>et al.</i> (2021) [165]	16 swine	ECG	ATM	N/A	graph convolutional regression
Camps <i>et al.</i> (2021) [103]	in silico	ECG	CV, RN	N/A	Monte Carlo Bayesian inf
Li <i>et al.</i> (2022) [189]	in silico	ECG	CV, RN	Eikonal	conditional VAE
Camps <i>et al.</i> (2024) [138]	in silico	ECG	CV, Purkinje network	Eikonal	Monte Carlo Bayesian inf

allows for a thorough assessment of the patient's heart propensity to develop ventricular arrhythmias related to MI. The VARP has been demonstrated to significantly outperform clinical metrics in predicting future arrhythmic events. The resilient and non-intrusive

VARP approach holds promise in potentially averting SCD and steering clear of unnecessary implantable cardioverter-defibrillator (ICD) placements in patients with post-MI. This is particularly valuable in monitoring patients with known cardiovascular conditions,

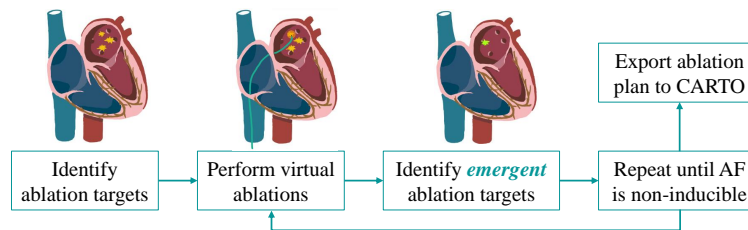

Fig. 12. Virtual heart model guided preoperative planning for the personalized catheter ablation of atrial fibrillation (AF) patients. Here, CARTO is the clinical electroanatomic navigation system. Illustrations designed referring to Boyle *et al.* [3].

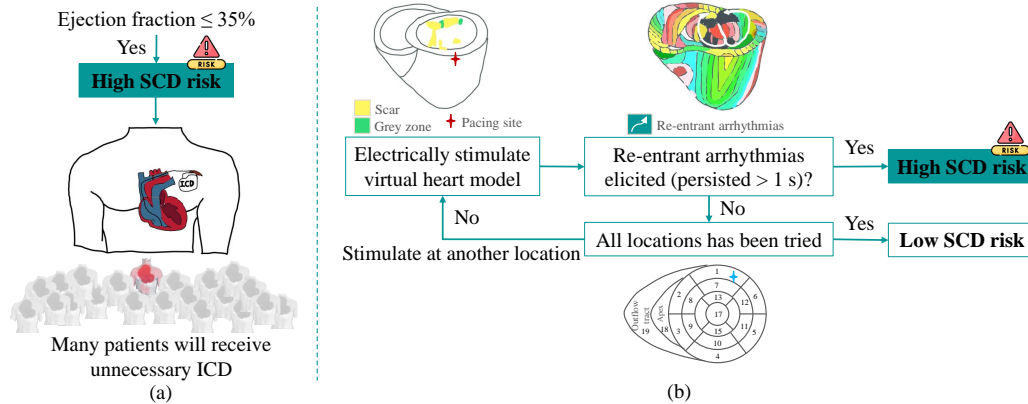

Fig. 13. Comparison of conventional clinical metric and virtual heart model based identification of patients at high sudden cardiac death (SCD) risk. (a) a universal metric in clinical cardiology practice, (b) a personalized virtual-heart arrhythmia risk predictor. ICD: implantable cardioverter defibrillator. Illustrations designed referring to Arevalo *et al.* [2].

where early signs of deterioration can be identified, enabling timely intervention and personalized adjustments to the treatment plan [198], [199]. This can be achieved by combining multiple sources (fitness trackers, wearables, and ‘companion’ apps for drugs, etc.) to maintain and update cardiac digital twins and their underlying models. The integration of ECG inverse inference thus emerges as a powerful tool in risk assessment and continuous monitoring, contributing to more proactive and personalized cardiovascular care.

### C. Personalized Disease Insight and Diagnosis

Numerous studies within the pathological validation section have delved into disease mechanisms using ECG inverse inference, proposing clinically relevant parameters [200]–[202]. One of the earliest extensively clinically explored applications of ECG inverse inference is in identifying the specific mechanisms underlying arrhythmia onset and/ or perpetuation for ablation therapy [52]. For instance, it was utilized to delineate the distinct activation patterns during arrhythmia (e.g., focal vs. re-entrant) [203], [204]. Additionally, it has also been employed to pinpoint the drivers of this activation [205], which have demonstrated correlation with successfully ablated regions in patients with positive outcomes and are now the focus of direct targeting in clinical validation studies [206]. Besides atria, ECG inverse inference has also been applied to identify and understand arrhythmogenic substrates for the onset and maintenance of VT [201], [207] and ventricular arrhythmias [208]. It has showcased larger ventricular electrical dyssynchrony in CRT responders, improving patient selection over standard 12-lead ECG [209], [210]. ECG inverse inference techniques are especially valuable in scenarios where invasive recordings are ethically constrained, such as with infants and pregnant women, offering insights into cardiac evolution. They can also be used for *in silico* clinical trials (see Section VI-C), which can particularly facilitate safe methods to explore treatment effects in patients with rare diseases and thus may allow for insights not possible in the current clinical trial practice [35]. Certain diagnostic

medical devices, like CardioInsight (Medtronic, USA), based on personalized models, have transitioned into industrial application and clinical usage [35]. Within the CardioInsight mapping system, the cardiac electrical activity on its surface can be reconstructed from body surface potentials employing a customized model of the heart and torso of the target patient [211]. While these retrospective studies contribute to understanding disease mechanisms and defining potential therapeutic markers, further exploration through extensive prospective studies is crucial to establish the clinical value of these insights for individual patients and their potential role in guiding diagnosis or patient selection.

## VI. DISCUSSION AND FUTURE PERSPECTIVES

### A. Surrogate Model for Efficient ECG Simulation

Traditional methods for simulating ECG signals involve complex biophysical models that account for intricate cardiac electrical and anatomical properties. While these models offer high fidelity, they often require substantial computational resources and time [5]. Fast implementations of these models exist. For example, Sachetto *et al.* [212] presents a GPU-based implementation of the monodomain model, which is capable of speeding up simulations by a factor up to 498 when compared to a serial implementation of the model. They reported simulation times of 32 minutes per heartbeat. Other studies have proposed alternative models that can yield similar simulation outputs at a fraction of the state-of-the-art monodomain models. For example, Wallman *et al.* [121] proposed a graph-based Eikonal model that can simulate the activation sequence in the heart in less than 1.6 seconds [103]. Similarly, Neic *et al.* [213] presented a pseudo-monodomain model that can produce nearly identical simulations to a monodomain model (under sinus rhythm) but with a computational cost of 213 seconds per heartbeat [214]. Nevertheless, in the context of generating digital twins, the number of simulations required per patient can easily be in the range of hundreds of thousands [103],

[138]. Thus, even the fastest mechanistic models available present a significant computational burden when designing studies involving the generation of digital twins at scale [138], [214].

The emergence of neural surrogate models addresses these challenges by offering computationally efficient alternatives that balance accuracy with practicality [215]–[217]. These surrogate models leverage machine learning techniques to learn the intricate mapping between the physiological parameters (e.g., earliest activation sites) and expected behavior (e.g., cardiac activation sequences) [217]. For example, Bertrand *et al.* [217] was able to produce simulations of the activation sequence in 0.04 seconds, which was a 500-factor speed-up compared to a serial implementation of the graph-based Eikonal [121] (20 seconds per simulation). By circumventing the need for exhaustive simulations, surrogate models provide an avenue for rapid and on-demand generation of cardiac functional data (e.g., ECG signals). This is particularly valuable in scenarios where real-time simulations or large-scale analyses are necessary. However, challenges such as model interpretability, generalization across diverse populations, and the need for accurate training data warrant careful consideration. Furthermore, a thorough understanding of the trade-off between computational efficiency and simulation accuracy is vital when integrating surrogate models into clinical applications. As surrogate models continue to evolve, they hold the potential to revolutionize ECG inverse inference by enabling researchers and practitioners to efficiently explore the parameter space and improve our understanding of complex cardiac phenomena.

### B. Multimodal Representation Learning Towards Solving the ECG Inverse Problem

The ECG inverse inference involves the fusion of information from multiple modalities, such as ECG signals, anatomical images (e.g., CT/ MRI scans), and clinical metadata. Multimodal representation learning offers a promising solution by allowing the integration of diverse data sources, leading to improved insights into the complex dynamics of cardiac electrical behavior. This can help address the issue of limited electrode coverage by inferring missing data points through learned relationships from other modalities. Furthermore, the inclusion of anatomical images can enhance the anatomical accuracy of the models, leading to improved source localization and more accurate inverse solutions. Indeed, deep neural networks have proven to be a highly effective strategy for ECG interpretation and analysis via spatiotemporal representation learning [47]. However, most works only considered ECG data for analysis and only a few works employed joint analysis with other data sources [116], [189], [218], [219]. Among these works, VAE has been widely employed to learn a latent representation of ECG and geometry [220], along with incorporating uncertainty modelling for inverse inference [116]. However, these studies merely concatenated the acquired features or utilized a shared representation, lacking a thorough explanation of how these features align and contribute to holistic data comprehension. In contrast, physics-informed models can integrate domain-specific knowledge and principles derived from the underlying physics of the cardiac system [179]. By explicitly encoding the physical interactions and dependencies between ECG and geometry, these models could offer a more transparent and interpretable way to capture the intricate interplay between these data modalities. Moreover, they could potentially enhance the generalization capabilities of the learned representations, making them more robust in scenarios with limited or noisy data. Nevertheless, the integration of physics-based constraints into machine learning models introduces additional challenges, such as learning geometrical invariance, as well as processing model complexity and the need for

accurate domain knowledge. Balancing the complexity of the physical model with the capacity of the machine learning algorithm while also ensuring the interpretability of the resulting features will require careful consideration and innovative methodologies.

### C. The Role of Cardiac Digital Twins in Advancing *In Silico* Clinical Trials

Cardiac digital twins are revolutionizing the landscape of *in silico* clinical trials, offering unprecedented opportunities to accelerate drug development [138]. By creating virtual replicas of the individual patient's heart, cardiac digital twins enable highly personalized simulations that capture the intricate dynamics of cardiac function and response to interventions [221]. Traditional clinical trials often face limitations in recruiting participants from specific demographic or clinical groups, leading to challenges in generalizing findings to broader populations [222]. With cardiac digital twins, researchers can create virtual patient cohorts that span a wide range of demographic, clinical, and pathological characteristics. This diversity allows for a more comprehensive exploration of drug effects and treatment outcomes across different patient subgroups, enhancing the reliability and generalizability of trial results. At the same time, *in silico* trials significantly reduce the time and cost associated with recruiting participants, conducting experiments, and analyzing results. This accelerated pace facilitates the rapid iteration and refinement of drug candidates, ultimately expediting the journey from discovery to market availability. Moreover, *in silico* trials enable researchers to explore a broader range of hypotheses and scenarios than would be feasible in traditional clinical settings. This flexibility allows for a more comprehensive exploration of potential drug effects, interactions, and mechanisms of action, leading to deeper insights and more informed decision-making. In the future, *in silico* clinical trials hold immense potential for revolutionizing drug development and healthcare delivery. The integration of patient-specific data and virtual patient models will enable personalized drug development approaches tailored to individual characteristics and needs. To fully realize the potential of *in silico* clinical trials, challenges such as model validity, regulatory compliance, and data access barriers must be addressed.

## VII. CONCLUSION

Cardiac digital twins are pivotal in advancing precision medicine and improving patient outcomes in cardiovascular care by simulating and predicting personalized responses to interventions. However, current models encounter a computational bottleneck in calibrating to an individual's physiology through ECG inverse inference, particularly in 3D heart models. This review comprehensively outlines recent progress in ECG inverse inference, encompassing algorithms, public datasets, evaluation metrics, clinical applications, and future perspectives. While machine learning, especially deep learning, holds promise in tackling this complex and ill-posed problem, significant challenges persist, alongside promising opportunities for further advancement and innovation. In the future, as these techniques gain increasing popularity and generate massive cohorts of digital twins, they are poised to revolutionize cardiovascular care through *in-silico* trials and personalized interventions. With the proliferation of big data, envision a future where everyone possesses a digital twin, significantly reducing the reliance on animal models and enabling real-time monitoring in hospitals.

## REFERENCES

- [1] S. Somani, A. J. Russak, F. Richter, S. Zhao, A. Vaid, F. Chaudhry, J. K. De Freitas, N. Naik, R. Miotto, G. N. Nadkarni, *et al.*, "Deep learning

- and the electrocardiogram: review of the current state-of-the-art," *EP Europace*, vol. 23, no. 8, pp. 1179–1191, 2021.
- [2] H. J. Arevalo, F. Vadakkumpadan, E. Guallar, A. Jebb, P. Malamas, K. C. Wu, and N. A. Trayanova, "Arrhythmia risk stratification of patients after myocardial infarction using personalized heart models," *Nature communications*, vol. 7, no. 1, p. 11437, 2016.
  - [3] P. M. Boyle, T. Zghaib, S. Zahid, *et al.*, "Computationally guided personalized targeted ablation of persistent atrial fibrillation," *Nature biomedical engineering*, vol. 3, no. 11, pp. 870–879, 2019.
  - [4] C. S. Henriquez, "Simulating the electrical behavior of cardiac tissue using the bidomain model," *Critical reviews in biomedical engineering*, vol. 21, no. 1, pp. 1–77, 1993.
  - [5] M. Potse, B. Dubé, J. Richer, A. Vinet, and R. M. Gulrajani, "A comparison of monodomain and bidomain reaction-diffusion models for action potential propagation in the human heart," *IEEE Transactions on Biomedical Engineering*, vol. 53, no. 12, pp. 2425–2435, 2006.
  - [6] P. Colli Franzone, L. Guerri, and S. Rovida, "Wavefront propagation in an activation model of the anisotropic cardiac tissue: asymptotic analysis and numerical simulations," *Journal of mathematical biology*, vol. 28, pp. 121–176, 1990.
  - [7] R. S. MacLeod and D. H. Brooks, "Recent progress in inverse problems in electrocardiology," *IEEE Engineering in Medicine and Biology Magazine*, vol. 17, no. 1, pp. 73–83, 1998.
  - [8] B. M. Horacek, J. W. Warren, C. J. Penney, R. S. MacLeod, L. Title, M. Gardner, and C. Feldman, "Optimal electrocardiographic leads for detecting acute myocardial ischemia," *Journal of Electrocardiology*, vol. 34, pp. 97–112, 2001.
  - [9] C. Matteucci, "Sur un phenomene physiologique produit par les muscles en contraction," *Ann Chim Phys.*, vol. 6, pp. 339–341, 1842.
  - [10] A. D. Waller, "A demonstration on man of electromotive changes accompanying the heart's beat," *The Journal of physiology*, vol. 8, no. 5, p. 229, 1887.
  - [11] W. Einthoven, "Ueber die form des menschlichen electrocardiogramms," *Pflügers Archiv European Journal of Physiology*, vol. 60, no. 3, pp. 101–123, 1895.
  - [12] F. N. Wilson, C. E. KOSSMANN, G. E. BURCH, E. GOLDBERGER, A. GRAYBIEL, H. H. HECHT, F. D. JOHNSTON, E. LEPESCHKIN, and G. B. MYERS, "Recommendations for standardization of electrocardiographic and vectorcardiographic leads," *Circulation*, vol. 10, no. 4, pp. 564–573, 1954.
  - [13] D. Noble, "Cardiac action and pacemaker potentials based on the hodgkin-huxley equations," *Nature*, vol. 188, no. 4749, pp. 495–497, 1960.
  - [14] A. L. Hodgkin and A. F. Huxley, "A quantitative description of membrane current and its application to conduction and excitation in nerve," *The Journal of physiology*, vol. 117, no. 4, p. 500, 1952.
  - [15] D. Noble, "A modification of the hodgkin—huxley equations applicable to purkinje fibre action and pacemaker potentials," *The Journal of physiology*, vol. 160, no. 2, p. 317, 1962.
  - [16] B. Taccardi, "Distribution of heart potentials on the thoracic surface of normal human subjects," *Circulation Research*, vol. 12, no. 4, pp. 341–352, 1963.
  - [17] D. Durrer, R. T. Van Dam, G. Freud, M. J. Janse, F. L. Meijler, and R. C. Arzbaecher, "Total excitation of the isolated human heart," *Circulation*, vol. 41, no. 6, pp. 899–912, 1970.
  - [18] R. O. Martin and T. C. Pilkington, "Unconstrained inverse electrocardiography: epicardial potentials," *IEEE Transactions on Biomedical Engineering*, no. 4, pp. 276–285, 1972.
  - [19] R. O. Martin, T. Pilkington, and M. N. Morrow, "Statistically constrained inverse electrocardiography," *IEEE Transactions on Biomedical Engineering*, no. 6, pp. 487–492, 1975.
  - [20] P. C. Franzone, B. Taccardi, and C. Viganotti, "An approach to inverse calculation of epicardial potentials from body surface maps," *Advances in cardiology*, vol. 21, pp. 50–54, 1978.
  - [21] Y. Yamashita and T. Takahashi, "Use of the finite element method to determine epicardial from body surface potentials under a realistic torso model," *IEEE transactions on biomedical engineering*, no. 9, pp. 611–621, 1984.
  - [22] R. C. Barr and M. Spach, "Inverse calculation of QRS-T epicardial potentials from body surface potential distributions for normal and ectopic beats in the intact dog," *Circulation research*, vol. 42, no. 5, pp. 661–675, 1978.
  - [23] B. Messinger-Rapport and Y. Rudy, "Noninvasive recovery of epicardial potentials in a realistic heart-torso geometry. normal sinus rhythm," *Circulation research*, vol. 66, no. 4, pp. 1023–1039, 1990.
  - [24] C. Ramanathan, R. N. Ghanem, P. Jia, K. Ryu, and Y. Rudy, "Noninvasive electrocardiographic imaging for cardiac electrophysiology and arrhythmia," *Nature medicine*, vol. 10, no. 4, pp. 422–428, 2004.
  - [25] J. L. Sapp, F. Dawoud, J. C. Clements, and B. M. Horáček, "Inverse solution mapping of epicardial potentials: quantitative comparison with epicardial contact mapping," *Circulation: Arrhythmia and Electrophysiology*, vol. 5, no. 5, pp. 1001–1009, 2012.
  - [26] P. Mansfield and A. A. Maudsley, "Medical imaging by nmr," *The British journal of radiology*, vol. 50, no. 591, pp. 188–194, 1977.
  - [27] B. J. Messinger-Rapport and Y. Rudy, "The inverse problem in electrocardiography: A model study of the effects of geometry and conductivity parameters on the reconstruction of epicardial potentials," *IEEE transactions on biomedical engineering*, no. 7, pp. 667–676, 1986.
  - [28] B. J. Messinger-Rapport and Y. Rudy, "Regularization of the inverse problem in electrocardiography: A model study," *Mathematical Biosciences*, vol. 89, no. 1, pp. 79–118, 1988.
  - [29] Y. Rudy and H. Oster, "The electrocardiographic inverse problem," *Critical reviews in biomedical engineering*, vol. 20, no. 1–2, pp. 25–45, 1992.
  - [30] H. S. Oster and Y. Rudy, "The use of temporal information in the regularization of the inverse problem of electrocardiography," *IEEE transactions on biomedical engineering*, vol. 39, no. 1, pp. 65–75, 1992.
  - [31] H. S. Oster, B. Taccardi, R. L. Lux, P. R. Ershler, and Y. Rudy, "Electrocardiographic imaging: noninvasive characterization of intramural myocardial activation from inverse-reconstructed epicardial potentials and electrograms," *Circulation*, vol. 97, no. 15, pp. 1496–1507, 1998.
  - [32] J. Guo and Z. Lv, "Application of digital twins in multiple fields," *Multimedia tools and applications*, vol. 81, no. 19, pp. 26941–26967, 2022.
  - [33] P. J. Hunter and T. K. Borg, "Integration from proteins to organs: the physiome project," *Nature reviews Molecular cell biology*, vol. 4, no. 3, pp. 237–243, 2003.
  - [34] P. Armeni, I. Polat, L. M. De Rossi, L. Diaferia, S. Merigalli, and A. Gatti, "Digital twins in healthcare: is it the beginning of a new era of evidence-based medicine? a critical review," *Journal of Personalized Medicine*, vol. 12, no. 8, p. 1255, 2022.
  - [35] J. Corral-Acero, F. Margara, M. Marciniak, C. Rodero, F. Loncaric, Y. Feng, A. Gilbert, J. F. Fernandes, H. A. Bukhari, A. Wajdan, *et al.*, "The 'digital twin' to enable the vision of precision cardiology," *European Heart Journal*, vol. 41, no. 48, pp. 4556–4564, 2020.
  - [36] Y. Li, X. Li, S. Shen, L. Zeng, R. Liu, Q. Zheng, J. Feng, and S. Chen, "Dtbvis: An interactive visual comparison system for digital twin brain and human brain," *Visual Informatics*, vol. 7, no. 2, pp. 41–53, 2023.
  - [37] M. Viceconti, F. Pappalardo, B. Rodriguez, M. Horner, J. Bischoff, and F. M. Tshinanu, "In silico trials: Verification, validation and uncertainty quantification of predictive models used in the regulatory evaluation of biomedical products," *Methods*, vol. 185, pp. 120–127, 2021.
  - [38] O. Zettinig, T. Mansi, D. Neumann, *et al.*, "Data-driven estimation of cardiac electrical diffusivity from 12-lead ecg signals," *Medical image analysis*, vol. 18, no. 8, pp. 1361–1376, 2014.
  - [39] O. Dössel, "Inverse problem of electro-and magnetocardiography: Review and recent progress," *International Journal of Bioelectromagnetism*, vol. 2, no. 2, p. 22, 2000.
  - [40] F. Yaman, V. G. Yakhno, and R. Potthast, "A survey on inverse problems for applied sciences," *Mathematical problems in engineering*, vol. 2013, 2013.
  - [41] G. Uhlmann, "Inverse problems: seeing the unseen," *Bulletin of Mathematical Sciences*, vol. 4, pp. 209–279, 2014.
  - [42] D. Calvetti and E. Somersalo, "Inverse problems: From regularization to Bayesian inference," *Wiley Interdisciplinary Reviews: Computational Statistics*, vol. 10, no. 3, p. e1427, 2018.
  - [43] M. Genzel, J. Macdonald, and M. März, "Solving inverse problems with deep neural networks—robustness included?," *IEEE Transactions on Pattern Analysis and Machine Intelligence*, vol. 45, no. 1, pp. 1119–1134, 2022.
  - [44] S. Arridge, P. Maass, O. Öktem, and C.-B. Schönlieb, "Solving inverse problems using data-driven models," *Acta Numerica*, vol. 28, pp. 1–174, 2019.
  - [45] R. Sameni and G. D. Clifford, "A review of fetal ECG signal processing: issues and promising directions," *The Open Pacing, Electrophysiology & Therapy Journal*, vol. 3, p. 4, 2010.
  - [46] L. R. Bear, L. K. Cheng, I. J. LeGrice, G. B. Sands, N. A. Lever, D. J. Paterson, and B. H. Smaill, "Forward problem of electrocardiography: is it solved?," *Circulation: Arrhythmia and Electrophysiology*, vol. 8, no. 3, pp. 677–684, 2015.

- [47] S. Hong, Y. Zhou, J. Shang, C. Xiao, and J. Sun, "Opportunities and challenges of deep learning methods for electrocardiogram data: A systematic review," *Computers in biology and medicine*, vol. 122, p. 103801, 2020.
- [48] X. Liu, H. Wang, Z. Li, and L. Qin, "Deep learning in ECG diagnosis: A review," *Knowledge-Based Systems*, vol. 227, p. 107187, 2021.
- [49] S. F. Bifulco, N. Akoum, and P. M. Boyle, "Translational applications of computational modelling for patients with cardiac arrhythmias," *Heart*, vol. 107, no. 6, pp. 456–461, 2021.
- [50] C. D. Cantwell, C. H. Roney, F. S. Ng, J. H. Siggers, S. J. Sherwin, and N. S. Peters, "Techniques for automated local activation time annotation and conduction velocity estimation in cardiac mapping," *Computers in biology and medicine*, vol. 65, pp. 229–242, 2015.
- [51] M. J. M. Cluitmans, R. Peeters, R. Westra, and P. Volders, "Noninvasive reconstruction of cardiac electrical activity: update on current methods, applications and challenges," *Netherlands Heart Journal*, vol. 23, pp. 301–311, 2015.
- [52] M. Cluitmans, D. H. Brooks, R. MacLeod, *et al.*, "Validation and opportunities of electrocardiographic imaging: from technical achievements to clinical applications," *Frontiers in physiology*, vol. 9, p. 1305, 2018.
- [53] Z. Yadan, L. Jian, W. Jian, L. Yifu, L. Haiying, *et al.*, "An expert review of the inverse problem in electrocardiographic imaging for the non-invasive identification of atrial fibrillation drivers," *Computer Methods and Programs in Biomedicine*, p. 107676, 2023.
- [54] I. Hernandez-Romero, R. Molero, C. Fambuena-Santos, C. Herrero-Martin, A. M. Climent, and M. S. Guillem, "Electrocardiographic imaging in the atria," *Medical & biological engineering & computing*, vol. 61, no. 4, pp. 879–896, 2023.
- [55] D. V. Patel, D. Ray, and A. A. Oberai, "Solution of physics-based Bayesian inverse problems with deep generative priors," *Computer Methods in Applied Mechanics and Engineering*, vol. 400, p. 115428, 2022.
- [56] J. Kaipio and E. Somersalo, *Statistical and computational inverse problems*, vol. 160. Springer Science & Business Media, 2006.
- [57] C. Figuera, V. Suárez-Gutiérrez, I. Hernández-Romero, M. Rodrigo, A. Liberós, F. Atienza, M. S. Guillem, Ó. Barquero-Pérez, A. M. Climent, and F. Alonso-Atienza, "Regularization techniques for ECG imaging during atrial fibrillation: a computational study," *Frontiers in physiology*, vol. 7, p. 466, 2016.
- [58] M. Rodrigo, A. M. Climent, A. Liberós, I. Hernández-Romero, A. Arrenal, J. Bermejo, F. Fernández-Avilés, F. Atienza, and M. S. Guillem, "Solving inaccuracies in anatomical models for electrocardiographic inverse problem resolution by maximizing reconstruction quality," *IEEE transactions on medical imaging*, vol. 37, no. 3, pp. 733–740, 2017.
- [59] S. Sarikaya, G.-W. Weber, and Y. S. Doğrusöz, "Combination of conventional regularization methods and genetic algorithm for solving the inverse problem of electrocardiography," in *2010 5th International Symposium on Health Informatics and Bioinformatics*, pp. 13–20, IEEE, 2010.
- [60] G. Shou, L. Xia, M. Jiang, Q. Wei, F. Liu, and S. Crozier, "Truncated total least squares: a new regularization method for the solution of ECG inverse problems," *IEEE Transactions on Biomedical Engineering*, vol. 55, no. 4, pp. 1327–1335, 2008.
- [61] S. Ghosh and Y. Rudy, "Application of L1-norm regularization to epicardial potential solution of the inverse electrocardiography problem," *Annals of biomedical engineering*, vol. 37, pp. 902–912, 2009.
- [62] J. Xu, A. R. Dehaghani, F. Gao, and L. Wang, "Noninvasive transmural electrophysiological imaging based on minimization of total-variation functional," *IEEE transactions on medical imaging*, vol. 33, no. 9, pp. 1860–1874, 2014.
- [63] D. Wang, R. M. Kirby, and C. R. Johnson, "Resolution strategies for the finite-element-based solution of the ECG inverse problem," *IEEE Transactions on biomedical engineering*, vol. 57, no. 2, pp. 220–237, 2009.
- [64] V. Kara, H. Ni, E. A. Perez Alday, and H. Zhang, "Ecg imaging to detect the site of ventricular ischemia using torso electrodes: a computational study," *Frontiers in physiology*, vol. 10, p. 50, 2019.
- [65] L. R. Bear, Y. S. Dogrusoz, W. Good, J. Svehlikova, J. Coll-Font, E. Van Dam, and R. MacLeod, "The impact of torso signal processing on noninvasive electrocardiographic imaging reconstructions," *IEEE Transactions on Biomedical Engineering*, vol. 68, no. 2, pp. 436–447, 2020.
- [66] S. Schuler, M. Schaufelberger, L. R. Bear, *et al.*, "Reducing line-of-block artifacts in cardiac activation maps estimated using ECG imaging: A comparison of source models and estimation methods," *IEEE Transactions on Biomedical Engineering*, vol. 69, no. 6, pp. 2041–2052, 2021.
- [67] A. S. Rababah, L. R. Bear, Y. S. Dogrusoz, *et al.*, "The effect of interpolating low amplitude leads on the inverse reconstruction of cardiac electrical activity," *Computers in biology and medicine*, vol. 136, p. 104666, 2021.
- [68] B. Messnarz, B. Tilg, R. Modre, G. Fischer, and F. Hanser, "A new spatiotemporal regularization approach for reconstruction of cardiac transmembrane potential patterns," *IEEE transactions on Biomedical Engineering*, vol. 51, no. 2, pp. 273–281, 2004.
- [69] B. Yao and H. Yang, "Physics-driven spatiotemporal regularization for high-dimensional predictive modeling: A novel approach to solve the inverse ECG problem," *Scientific reports*, vol. 6, no. 1, p. 39012, 2016.
- [70] Ö. N. Onak, Y. S. Dogrusoz, and G. W. Weber, "Evaluation of multivariate adaptive non-parametric reduced-order model for solving the inverse electrocardiography problem: A simulation study," *Medical & Biological Engineering & Computing*, vol. 57, pp. 967–993, 2019.
- [71] K. L. Berrier, D. C. Sorensen, and D. S. Khoury, "Solving the inverse problem of electrocardiography using a Duncan and Horn formulation of the Kalman filter," *IEEE Transactions on biomedical engineering*, vol. 51, no. 3, pp. 507–515, 2004.
- [72] A. Ghodrati, D. H. Brooks, G. Tadmor, and R. S. MacLeod, "Wavefront-based models for inverse electrocardiography," *IEEE transactions on biomedical engineering*, vol. 53, no. 9, pp. 1821–1831, 2006.
- [73] M. Cluitmans, J. Karel, P. Bonizzi, P. Volders, R. Westra, and R. Peeters, "Wavelet-promoted sparsity for non-invasive reconstruction of electrical activity of the heart," *Medical & biological engineering & computing*, vol. 56, pp. 2039–2050, 2018.
- [74] S. Ghimire, J. L. Sapp, B. M. Horáček, and L. Wang, "Noninvasive reconstruction of transmural transmembrane potential with simultaneous estimation of prior model error," *IEEE Transactions on Medical Imaging*, vol. 38, no. 11, pp. 2582–2595, 2019.
- [75] A. Pullan, L. Cheng, M. Nash, C. Bradley, and D. Paterson, "Noninvasive electrical imaging of the heart: theory and model development," *Annals of biomedical engineering*, vol. 29, pp. 817–836, 2001.
- [76] P. M. Van Dam, T. F. Oostendorp, A. C. Linnenbank, and A. Van Oosterom, "Non-invasive imaging of cardiac activation and recovery," *Annals of biomedical engineering*, vol. 37, pp. 1739–1756, 2009.
- [77] F. Calderero, A. Ghodrati, D. H. Brooks, G. Tadmor, and R. MacLeod, "A method to reconstruct activation wavefronts without isotropy assumptions using a level sets approach," in *Functional Imaging and Modeling of the Heart: Third International Workshop, FIMH 2005, Barcelona, Spain, June 2-4, 2005. Proceedings 3*, pp. 195–204, Springer, 2005.
- [78] B. F. Nielsen, M. Lysaker, and P. Grøttum, "Computing ischemic regions in the heart with the bidomain model—first steps towards validation," *IEEE Transactions on Medical Imaging*, vol. 32, no. 6, pp. 1085–1096, 2013.
- [79] L. Wang, H. Zhang, K. C. Wong, H. Liu, and P. Shi, "Physiological-model-constrained noninvasive reconstruction of volumetric myocardial transmembrane potentials," *IEEE Transactions on Biomedical Engineering*, vol. 57, no. 2, pp. 296–315, 2009.
- [80] B. He, G. Li, and X. Zhang, "Noninvasive imaging of cardiac transmembrane potentials within three-dimensional myocardium by means of a realistic geometry anisotropic heart model," *IEEE Transactions on Biomedical Engineering*, vol. 50, no. 10, pp. 1190–1202, 2003.
- [81] J. Xu, J. L. Sapp, A. Rahimi Dehaghani, F. Gao, and L. Wang, "Variational bayesian electrophysiological imaging of myocardial infarction," in *Medical Image Computing and Computer-Assisted Intervention—MICCAI 2014: 17th International Conference, Boston, MA, USA, September 14-18, 2014, Proceedings, Part II 17*, pp. 529–537, Springer, 2014.
- [82] B. Erem, P. M. Van Dam, and D. H. Brooks, "Identifying model inaccuracies and solution uncertainties in noninvasive activation-based imaging of cardiac excitation using convex relaxation," *IEEE transactions on medical imaging*, vol. 33, no. 4, pp. 902–912, 2014.
- [83] J. Dhamala, H. J. Arevalo, J. Sapp, B. M. Horáček, K. C. Wu, N. A. Trayanova, and L. Wang, "Quantifying the uncertainty in model parameters using Gaussian process-based Markov chain Monte Carlo in cardiac electrophysiology," *Medical image analysis*, vol. 48, pp. 43–57, 2018.
- [84] F. Meister, T. Passerini, C. Audigier, È. Lluch, V. Mihalef, H. Ashikaga, A. Maier, H. Halperin, and T. Mansi, "Graph convolutional regression of cardiac depolarization from sparse endocardial maps," in *International Workshop on Statistical Atlases and Computational Models of the Heart*, pp. 23–34, Springer, 2020.

- [85] R. Tenderini, S. Pagani, A. Quarteroni, and S. Deparis, “PDE-aware deep learning for inverse problems in cardiac electrophysiology,” *SIAM Journal on Scientific Computing*, vol. 44, no. 3, pp. B605–B639, 2022.
- [86] M. Á. Cámara-Vázquez, I. Hernández-Romero, E. Morgado-Reyes, M. S. Guillem, A. M. Climent, and O. Barquero-Pérez, “Non-invasive estimation of atrial fibrillation driver position with convolutional neural networks and body surface potentials,” *Frontiers in Physiology*, vol. 12, p. 733449, 2021.
- [87] D. Neumann, T. Mansi, *et al.*, “A self-taught artificial agent for multi-physics computational model personalization,” *Medical image analysis*, vol. 34, pp. 52–64, 2016.
- [88] A. Karoui, M. Bendahmane, and N. Zemzemi, “A spatial adaptation of the time delay neural network for solving ECGI inverse problem,” in *Functional Imaging and Modeling of the Heart: 10th International Conference, FIMH 2019, Bordeaux, France, June 6–8, 2019, Proceedings 10*, pp. 94–102, Springer, 2019.
- [89] A. Karoui, M. Bendahmane, and N. Zemzemi, “Cardiac activation maps reconstruction: a comparative study between data-driven and physics-based methods,” *Frontiers in Physiology*, vol. 12, p. 686136, 2021.
- [90] A. Malik, T. Peng, and M. L. Trew, “A machine learning approach to reconstruction of heart surface potentials from body surface potentials,” in *2018 40th Annual International Conference of the IEEE Engineering in Medicine and Biology Society (EMBC)*, pp. 4828–4831, IEEE, 2018.
- [91] F. Sahli Costabal, Y. Yang, P. Perdikaris, D. E. Hurtado, and E. Kuhl, “Physics-informed neural networks for cardiac activation mapping,” *Frontiers in Physics*, vol. 8, p. 42, 2020.
- [92] X. Jiang, M. Toloubidokhti, J. Bergquist, B. Zenger, W. W. Good, R. S. MacLeod, and L. Wang, “Improving generalization by learning geometry-dependent and physics-based reconstruction of image sequences,” *IEEE Transactions on Medical Imaging*, vol. 42, no. 2, pp. 403–415, 2022.
- [93] L. R. Bear, I. J. LeGrice, G. B. Sands, N. A. Lever, D. S. Loiselle, D. J. Paterson, L. K. Cheng, and B. H. Smaill, “How accurate is inverse electrocardiographic mapping? a systematic in vivo evaluation,” *Circulation: Arrhythmia and Electrophysiology*, vol. 11, no. 5, p. e006108, 2018.
- [94] G. E. Karniadakis, I. G. Kevrekidis, L. Lu, P. Perdikaris, S. Wang, and L. Yang, “Physics-informed machine learning,” *Nature Reviews Physics*, vol. 3, no. 6, pp. 422–440, 2021.
- [95] J. Xie and B. Yao, “Physics-constrained deep learning for robust inverse ECG modeling,” *IEEE Transactions on Automation Science and Engineering*, 2022.
- [96] Y. Ye, H. Liu, X. Jiang, M. Toloubidokhti, and L. Wang, “A spatial-temporally adaptive PINN framework for 3D bi-ventricular electrophysiological simulations and parameter inference,” in *International Conference on Medical Image Computing and Computer-Assisted Intervention*, pp. 163–172, Springer, 2023.
- [97] C. Herrero Martin, A. Oved, R. A. Chowdhury, E. Ullmann, N. S. Peters, A. A. Bharath, and M. Varela, “EP-PINNs: Cardiac electrophysiology characterisation using physics-informed neural networks,” *Frontiers in Cardiovascular Medicine*, vol. 8, p. 768419, 2022.
- [98] F. Sahli Costabal, Y. Yang, P. Perdikaris, D. E. Hurtado, and E. Kuhl, “Physics-informed neural networks for cardiac activation mapping,” *Frontiers in Physics*, vol. 8, p. 42, 2020.
- [99] J. Xu, J. L. Sapp, A. R. Dehaghani, F. Gao, M. Horacek, and L. Wang, “Robust transmural electrophysiological imaging: Integrating sparse and dynamic physiological models into ECG-based inference,” in *Medical Image Computing and Computer-Assisted Intervention—MICCAI 2015: 18th International Conference, Munich, Germany, October 5–9, 2015, Proceedings, Part II 18*, pp. 519–527, Springer, 2015.
- [100] T. Erenler and Y. Serinagaoglu Dogrusoz, “ML and MAP estimation of parameters for the Kalman filter and smoother applied to electrocardiographic imaging,” *Medical & Biological Engineering & Computing*, vol. 57, pp. 2093–2113, 2019.
- [101] U. Aydin and Y. S. Dogrusoz, “A Kalman filter-based approach to reduce the effects of geometric errors and the measurement noise in the inverse ecg problem,” *Medical & Biological Engineering & Computing*, vol. 49, pp. 1003–1013, 2011.
- [102] C. Corrado, J.-F. Gerbeau, and P. Moireau, “Identification of weakly coupled multiphysics problems. application to the inverse problem of electrocardiography,” *Journal of Computational Physics*, vol. 283, pp. 271–298, 2015.
- [103] J. Camps, B. Lawson, C. Drovandi, A. Mincholé, Z. J. Wang, V. Grau, K. Burrage, and B. Rodriguez, “Inference of ventricular activation properties from non-invasive electrocardiography,” *Medical Image Analysis*, vol. 73, p. 102143, 2021.
- [104] M. S. Zaman, J. Dhamala, P. Bajracharya, J. L. Sapp, B. M. Horáček, K. C. Wu, N. A. Trayanova, and L. Wang, “Fast posterior estimation of cardiac electrophysiological model parameters via bayesian active learning,” *Frontiers in Physiology*, vol. 12, p. 740306, 2021.
- [105] A. Rahimi, J. Sapp, J. Xu, P. Bajorski, M. Horacek, and L. Wang, “Examining the impact of prior models in transmural electrophysiological imaging: A hierarchical multiple-model bayesian approach,” *IEEE transactions on medical imaging*, vol. 35, no. 1, pp. 229–243, 2015.
- [106] J. Martin, L. C. Wilcox, C. Burstedde, and O. Ghattas, “A stochastic newton MCMC method for large-scale statistical inverse problems with application to seismic inversion,” *SIAM Journal on Scientific Computing*, vol. 34, no. 3, pp. A1460–A1487, 2012.
- [107] E. Konukoglu, J. Relan, U. Cilingir, B. H. Menze, P. Chinchapatnam, A. Jadidi, H. Cochet, M. Hocini, H. Delingette, P. Jaïs, *et al.*, “Efficient probabilistic model personalization integrating uncertainty on data and parameters: Application to eikonal-diffusion models in cardiac electrophysiology,” *Progress in biophysics and molecular biology*, vol. 107, no. 1, pp. 134–146, 2011.
- [108] D. E. Schiavazzi, G. Arbia, C. Baker, A. M. Hlavacek, T.-Y. Hsia, A. L. Marsden, I. E. Vignon-Clementel, and T. M. of Congenital Hearts Alliance (MOCHA) Investigators, “Uncertainty quantification in virtual surgery hemodynamics predictions for single ventricle palliation,” *International journal for numerical methods in biomedical engineering*, vol. 32, no. 3, p. e02737, 2016.
- [109] S. Ghimire, J. Dhamala, P. K. Gyawali, J. L. Sapp, M. Horacek, and L. Wang, “Generative modeling and inverse imaging of cardiac transmembrane potential,” in *Medical Image Computing and Computer Assisted Intervention—MICCAI 2018: 21st International Conference, Granada, Spain, September 16–20, 2018, Proceedings, Part II 11*, pp. 508–516, Springer, 2018.
- [110] J. Dhamala, P. Bajracharya, H. J. Arevalo, J. L. Sapp, B. M. Horáček, K. C. Wu, N. A. Trayanova, and L. Wang, “Embedding high-dimensional bayesian optimization via generative modeling: parameter personalization of cardiac electrophysiological models,” *Medical Image Analysis*, vol. 62, p. 101670, 2020.
- [111] L. Yang, X. Meng, and G. E. Karniadakis, “B-PINNs: Bayesian physics-informed neural networks for forward and inverse PDE problems with noisy data,” *Journal of Computational Physics*, vol. 425, p. 109913, 2021.
- [112] T. Bacoyannis, B. Ly, N. Cedilnik, H. Cochet, and M. Sermesant, “Deep learning formulation of electrocardiographic imaging integrating image and signal information with data-driven regularization,” *EP Europace*, vol. 23, no. Supplement\_1, pp. i55–i62, 2021.
- [113] T. Bacoyannis, B. Ly, H. Cochet, and M. Sermesant, “Deep learning formulation of ecgi evaluated on clinical data,” *Europace*, vol. 24, no. Supplement\_1, pp. euac053–566, 2022.
- [114] L. Li, J. Camps, A. Banerjee, M. Beetz, B. Rodriguez, and V. Grau, “Deep computational model for the inference of ventricular activation properties,” in *Statistical Atlases and Computational Models of the Heart. Regular and CMRxMotion Challenge Papers: 13th International Workshop, STACOM 2022, Held in Conjunction with MICCAI 2022, Singapore, September 18, 2022, Revised Selected Papers*, pp. 369–380, Springer, 2023.
- [115] J. Dhamala, S. Ghimire, J. L. Sapp, B. M. Horáček, and L. Wang, “Bayesian optimization on large graphs via a graph convolutional generative model: Application in cardiac model personalization,” in *Medical Image Computing and Computer Assisted Intervention—MICCAI 2019: 22nd International Conference, Shenzhen, China, October 13–17, 2019, Proceedings, Part II 22*, pp. 458–467, Springer, 2019.
- [116] L. Li, J. Camps, Z. Wang, A. Banerjee, B. Rodriguez, and V. Grau, “Towards enabling cardiac digital twins of myocardial infarction using deep computational models for inverse inference,” *IEEE Transactions on Medical Imaging*, 2024.
- [117] A. Melis, R. H. Clayton, and A. Marzo, “Bayesian sensitivity analysis of a 1D vascular model with gaussian process emulators,” *International Journal for Numerical Methods in Biomedical Engineering*, vol. 33, no. 12, p. e2882, 2017.
- [118] U. Noè, W. Chen, M. Filippone, N. Hill, and D. Husmeier, “Inference in a partial differential equations model of pulmonary arterial and venous blood circulation using statistical emulation,” in *Computational Intelligence Methods for Bioinformatics and Biostatistics: 13th International Meeting, CIBB 2016, Stirling, UK, September 1–3, 2016, Revised Selected Papers 13*, pp. 184–198, Springer, 2017.
- [119] P. Di Achille, A. Harouni, S. Khamzin, O. Solovyova, J. J. Rice, and V. Gurev, “Gaussian process regressions for inverse problems and parameter searches in models of ventricular mechanics,” *Frontiers in physiology*, vol. 9, p. 1002, 2018.

- [120] S. Pezzuto, P. Perdikaris, and F. S. Costabal, "Learning cardiac activation maps from 12-lead ECG with multi-fidelity bayesian optimization on manifolds," *IFAC-PapersOnLine*, vol. 55, no. 20, pp. 175–180, 2022.
- [121] M. Wallman, N. P. Smith, and B. Rodriguez, "Computational methods to reduce uncertainty in the estimation of cardiac conduction properties from electroanatomical recordings," *Medical image analysis*, vol. 18, no. 1, pp. 228–240, 2014.
- [122] Y. S. Dogrusoz, L. Bear, J. Svehlíková, J. Coll-Font, W. Good, R. Dubois, E. van Dam, and R. S. MacLeod, "Reduction of effects of noise on the inverse problem of electrocardiography with bayesian estimation," in *2018 Computing in Cardiology Conference (CinC)*, vol. 45, pp. 1–4, IEEE, 2018.
- [123] D. Neumann, T. Mansi, B. Georgescu, A. Kamen, E. Kayvanpour, A. Amr, F. Sedaghat-Hamedani, J. Haas, H. Katus, B. Meder, *et al.*, "Robust image-based estimation of cardiac tissue parameters and their uncertainty from noisy data," in *Medical Image Computing and Computer-Assisted Intervention—MICCAI 2014: 17th International Conference, Boston, MA, USA, September 14–18, 2014, Proceedings, Part II 17*, pp. 9–16, Springer, 2014.
- [124] M. Jiang, L. Xia, G. Shou, Q. Wei, F. Liu, and S. Crozier, "Effect of cardiac motion on solution of the electrocardiography inverse problem," *IEEE Transactions on Biomedical Engineering*, vol. 56, no. 4, pp. 923–931, 2008.
- [125] N. Gassa, M. Boonstra, B. Ondrusoval, J. Svehlikova, D. Brooks, A. Narayan, A. S. Rababah, P. van Dam, R. MacLeod, J. Tate, *et al.*, "Effect of segmentation uncertainty on the ECGI inverse problem solution and source localization," in *2022 Computing in Cardiology (CinC)*, vol. 498, pp. 1–4, IEEE, 2022.
- [126] J. D. Tate, W. W. Good, N. Zemzemi, M. Boonstra, P. van Dam, D. H. Brooks, A. Narayan, and R. S. MacLeod, "Uncertainty quantification of the effects of segmentation variability in ECGI," in *International Conference on Functional Imaging and Modeling of the Heart*, pp. 515–522, Springer, 2021.
- [127] P. K. Gyawali, J. V. Murkute, M. Toloubidokhti, X. Jiang, B. M. Horacek, J. L. Sapp, and L. Wang, "Learning to disentangle inter-subject anatomical variations in electrocardiographic data," *IEEE Transactions on Biomedical Engineering*, vol. 69, no. 2, pp. 860–870, 2021.
- [128] B. Yao, S. Pei, and H. Yang, "Mesh resolution impacts the accuracy of inverse and forward ECG problems," in *2016 38th Annual International Conference of the IEEE Engineering in Medicine and Biology Society (EMBC)*, pp. 4047–4050, IEEE, 2016.
- [129] R. C. Kerckhoffs, A. D. McCulloch, J. H. Omens, and L. J. Mulligan, "Effects of biventricular pacing and scar size in a computational model of the failing heart with left bundle branch block," *Medical image analysis*, vol. 13, no. 2, pp. 362–369, 2009.
- [130] N. Zemzemi, C. Dobrzynski, L. Bear, M. Potse, C. Dallet, Y. Coudière, R. Dubois, and J. Duchateau, "Effect of the torso conductivity heterogeneities on the ECGI inverse problem solution," in *2015 Computing in Cardiology Conference (CinC)*, pp. 233–236, IEEE, 2015.
- [131] Y. S. Dogrusoz, L. R. Bear, J. Bergquist, R. Dubois, W. Good, R. S. MacLeod, A. Rababah, and J. Stoks, "Effects of interpolation on the inverse problem of electrocardiography," in *2019 Computing in Cardiology (CinC)*, pp. Page–1, IEEE, 2019.
- [132] R. Molero, A. González-Ascaso, A. M. Climent, and M. S. Guillem, "Robustness of imageless electrocardiographic imaging against uncertainty in atrial morphology and location," *Journal of electrocardiology*, vol. 77, pp. 58–61, 2023.
- [133] J. A. Bergquist, B. Zenger, L. C. Rupp, A. Busatto, J. Tate, D. H. Brooks, A. Narayan, and R. S. MacLeod, "Uncertainty quantification of the effect of cardiac position variability in the inverse problem of electrocardiographic imaging," *Physiological Measurement*, vol. 44, no. 10, p. 105003, 2023.
- [134] L. Gander, R. Krause, M. Multerer, and S. Pezzuto, "Space–time shape uncertainties in the forward and inverse problem of electrocardiography," *International journal for numerical methods in biomedical engineering*, vol. 37, no. 10, p. e3522, 2021.
- [135] S. Zhao and B. Huang, "Trial-and-error or avoiding a guess? initialization of the kalman filter," *Automatica*, vol. 121, p. 109184, 2020.
- [136] N. Van Osta, F. P. Kirkels, T. Van Loon, T. Koopsen, A. Lyon, R. Meiburg, W. Huberts, M. J. Cramer, T. Delhaas, K. H. Haugaa, *et al.*, "Uncertainty quantification of regional cardiac tissue properties in arrhythmogenic cardiomyopathy using adaptive multiple importance sampling," *Frontiers in physiology*, vol. 12, p. 738926, 2021.
- [137] S. Palamara, C. Vergara, E. Faggiano, and F. Nobile, "An effective algorithm for the generation of patient-specific purkinje networks in computational electrocardiology," *Journal of Computational Physics*, vol. 283, pp. 495–517, 2015.
- [138] J. Camps, L. A. Berg, Z. J. Wang, R. Sebastian, L. L. Riebel, R. Doste, X. Zhou, R. Sachetto, J. Coleman, B. Lawson, *et al.*, "Digital twinning of the human ventricular activation sequence to clinical 12-lead ECGs and magnetic resonance imaging using realistic purkinje networks for in silico clinical trials," *Medical Image Analysis*, p. 103108, 2024.
- [139] Z. Xiong, Q. Xia, Z. Hu, *et al.*, "A global benchmark of algorithms for segmenting the left atrium from late gadolinium-enhanced cardiac magnetic resonance imaging," *Medical Image Analysis*, vol. 67, p. 101832, 2020.
- [140] L. Li, W. Ding, L. Huang, X. Zhuang, and V. Grau, "Multi-modality cardiac image computing: A survey," *Medical Image Analysis*, p. 102869, 2023.
- [141] C. Tobon-Gomez, A. J. Geers, J. Peters, *et al.*, "Benchmark for algorithms segmenting the left atrium from 3D CT and MRI datasets," *IEEE Transactions on Medical Imaging*, vol. 34, no. 7, pp. 1460–1473, 2015.
- [142] X. Zhuang, J. Xu, X. Luo, *et al.*, "Cardiac segmentation on late gadolinium enhancement mri: a benchmark study from multi-sequence cardiac mr segmentation challenge," *Medical Image Analysis*, vol. 81, p. 102528, 2022.
- [143] X. Zhuang, L. Li, C. Payer, D. Štern, *et al.*, "Evaluation of algorithms for multi-modality whole heart segmentation: an open-access grand challenge," *Medical image analysis*, vol. 58, p. 101537, 2019.
- [144] R. Karim, L.-E. Blake, J. Inoue, Q. Tao, S. Jia, R. J. Housden, P. Bhagirath, J.-L. Duval, M. Varela, J. M. Behar, *et al.*, "Algorithms for left atrial wall segmentation and thickness–evaluation on an open-source CT and MRI image database," *Medical Image Analysis*, vol. 50, pp. 36–53, 2018.
- [145] K. Gillette, M. A. Gsell, C. Nagel, J. Bender, B. Winkler, S. E. Williams, M. Bär, T. Schäffter, O. Dössel, G. Plank, *et al.*, "Medalcare-xl: 16,900 healthy and pathological synthetic 12 lead ecgs from electrophysiological simulations," *Scientific Data*, vol. 10, no. 1, p. 531, 2023.
- [146] P. Wagner, N. Strodthoff, R.-D. Boussejot, D. Kreiseler, F. I. Lunze, W. Samek, and T. Schaeffter, "PTB-XL, a large publicly available electrocardiography dataset," *Scientific data*, vol. 7, no. 1, p. 154, 2020.
- [147] J. Zheng, J. Zhang, S. Danioko, H. Yao, H. Guo, and C. Rakovski, "A 12-lead electrocardiogram database for arrhythmia research covering more than 10,000 patients," *Scientific data*, vol. 7, no. 1, p. 48, 2020.
- [148] A. L. Goldberger, L. A. Amaral, L. Glass, J. M. Hausdorff, P. C. Ivanov, R. G. Mark, J. E. Mietus, G. B. Moody, C.-K. Peng, and H. E. Stanley, "Physiobank, physiotoolkit, and physionet: components of a new research resource for complex physiologic signals," *circulation*, vol. 101, no. 23, pp. e215–e220, 2000.
- [149] T. J. Littlejohns, C. Sudlow, N. E. Allen, and R. Collins, "UK Biobank: opportunities for cardiovascular research," *European heart journal*, vol. 40, no. 14, pp. 1158–1166, 2019.
- [150] Y. Shen, Y. Yang, S. Parish, Z. Chen, R. Clarke, and D. A. Clifton, "Risk prediction for cardiovascular disease using ECG data in the China Kadoorie Biobank," in *2016 38th annual international conference of the IEEE engineering in medicine and biology society (EMBC)*, pp. 2419–2422, IEEE, 2016.
- [151] Z. Chen, J. Chen, R. Collins, Y. Guo, R. Peto, F. Wu, and L. Li, "China Kadoorie Biobank of 0.5 million people: survey methods, baseline characteristics and long-term follow-up," *International journal of epidemiology*, vol. 40, no. 6, pp. 1652–1666, 2011.
- [152] M. Webber, D. Falconer, M. AlFarihi, G. Joy, F. Chan, C. Davie, L. Hamill Howes, A. Wong, A. Rapala, A. Bhuvra, *et al.*, "Study protocol: MyoFit46—the cardiac sub-study of the MRC national survey of health and development," *BMC cardiovascular disorders*, vol. 22, no. 1, p. 140, 2022.
- [153] M. Strocchi, C. M. Augustin, M. A. Gsell, E. Karabelas, A. Neic, K. Gillette, O. Razeghi, A. J. Prassl, E. J. Vigmond, J. M. Behar, *et al.*, "A publicly available virtual cohort of four-chamber heart meshes for cardiac electro-mechanics simulations," *PloS one*, vol. 15, no. 6, p. e0235145, 2020.
- [154] K. Aras, W. Good, J. Tate, B. Burton, D. Brooks, J. Coll-Font, O. Doesel, W. Schulze, D. Potyagaylo, L. Wang, *et al.*, "Experimental data and geometric analysis repository—EDGAR," *Journal of electrocardiology*, vol. 48, no. 6, pp. 975–981, 2015.
- [155] H. J. Smith, A. Banerjee, R. P. Choudhury, and V. Grau, "Automated torso contour extraction from clinical cardiac MR slices for 3D torso reconstruction," in *2022 44th Annual International Conference of the IEEE Engineering in Medicine & Biology Society (EMBC)*, pp. 3809–3813, IEEE, 2022.
- [156] E. Zacur, A. Mincholé, B. Villard, V. Carapella, R. Ariga, B. Rodriguez, and V. Grau, "MRI-based heart and torso personalization for computer



- modeling and simulation of cardiac electrophysiology,” in *Imaging for Patient-Customized Simulations and Systems for Point-of-Care Ultrasound: International Workshops, BIVPCS 2017 and POCUS 2017, Held in Conjunction with MICCAI 2017, Québec City, QC, Canada, September 14, 2017, Proceedings*, pp. 61–70, Springer, 2017.
- [157] J. A. Bergquist, W. W. Good, B. Zenger, J. D. Tate, L. C. Rupp, and R. S. MacLeod, “The electrocardiographic forward problem: A benchmark study,” *Computers in biology and medicine*, vol. 134, p. 104476, 2021.
- [158] L. R. Bear, R. D. Walton, E. Abell, Y. Coudière, M. Haissaguerre, O. Bernus, and R. Dubois, “Optical imaging of ventricular action potentials in a torso tank: A new platform for non-invasive electrocardiographic imaging validation,” *Frontiers in Physiology*, vol. 10, p. 146, 2019.
- [159] L. R. Bear, P. R. Huntjens, R. D. Walton, O. Bernus, R. Coronel, and R. Dubois, “Cardiac electrical dyssynchrony is accurately detected by noninvasive electrocardiographic imaging,” *Heart rhythm*, vol. 15, no. 7, pp. 1058–1069, 2018.
- [160] P. Oosterhoff, V. M. Meijborg, P. M. van Dam, P. F. van Dessel, C. N. Belterman, G. J. Streekstra, J. M. de Bakker, R. Coronel, and T. F. Oostendorp, “Experimental validation of noninvasive epicardial and endocardial activation imaging,” *Circulation: Arrhythmia and Electrophysiology*, vol. 9, no. 8, p. e004104, 2016.
- [161] M. J. Cluitmans, P. Bonizzi, J. M. Karel, M. Das, B. L. Kietselaer, M. M. de Jong, F. W. Prinzen, R. L. Peeters, R. L. Westra, and P. G. Volders, “In vivo validation of electrocardiographic imaging,” *JACC: Clinical Electrophysiology*, vol. 3, no. 3, pp. 232–242, 2017.
- [162] R. N. Ghanem, P. Jia, C. Ramanathan, K. Ryu, A. Markowitz, and Y. Rudy, “Noninvasive electrocardiographic imaging (ECGI): comparison to intraoperative mapping in patients,” *Heart Rhythm*, vol. 2, no. 4, pp. 339–354, 2005.
- [163] A. Kalinin, D. Potyagaylo, and V. Kalinin, “Solving the inverse problem of electrocardiography on the endocardium using a single layer source,” *Frontiers in physiology*, p. 58, 2019.
- [164] X. Zhang, I. Ramachandra, Z. Liu, B. Muneer, S. M. Pogwizd, and B. He, “Noninvasive three-dimensional electrocardiographic imaging of ventricular activation sequence,” *American Journal of Physiology-Heart and Circulatory Physiology*, vol. 289, no. 6, pp. H2724–H2732, 2005.
- [165] F. Meister, T. Passerini, C. Audigier, È. Lluch, V. Mihalef, H. Ashikaga, A. Maier, H. Halperin, and T. Mansi, “Graph convolutional regression of cardiac depolarization from sparse endocardial maps,” in *Statistical Atlases and Computational Models of the Heart. M&Ms and EMIDEC Challenges: 11th International Workshop, STACOM 2020, Held in Conjunction with MICCAI 2020, Lima, Peru, October 4, 2020, Revised Selected Papers 11*, pp. 23–34, Springer, 2021.
- [166] R. D. Throne, L. G. Olson, and J. R. Windle, “A new method for incorporating weighted temporal and spatial smoothing in the inverse problem of electrocardiography,” *IEEE Transactions on biomedical engineering*, vol. 49, no. 9, pp. 1054–1059, 2002.
- [167] K.-W. Chen, L. Bear, and C.-W. Lin, “Solving inverse electrocardiographic mapping using machine learning and deep learning frameworks,” *Sensors*, vol. 22, no. 6, p. 2331, 2022.
- [168] M. J. Cluitmans, P. Bonizzi, J. M. Karel, P. G. Volders, R. L. Peeters, and R. L. Westra, “Inverse reconstruction of epicardial potentials improved by vectorcardiography and realistic potentials,” in *Computing in Cardiology 2013*, pp. 369–372, IEEE, 2013.
- [169] S. Pezzuto, F. W. Prinzen, M. Potse, F. Maffessanti, F. Regoli, M. L. Caputo, G. Conte, R. Krause, and A. Auricchio, “Reconstruction of three-dimensional biventricular activation based on the 12-lead electrocardiogram via patient-specific modelling,” *EP Europace*, vol. 23, no. 4, pp. 640–647, 2021.
- [170] M. Jiang, L. Xia, W. Huang, G. Shou, F. Liu, and S. Crozier, “The application of subspace preconditioned LSQR algorithm for solving the electrocardiography inverse problem,” *Medical engineering & physics*, vol. 31, no. 8, pp. 979–985, 2009.
- [171] D. Wang, R. Kirby, R. S. MacLeod, and C. Johnson, “A new family of variational-form-based regularizers for reconstructing epicardial potentials from body-surface mapping,” in *2010 Computing in Cardiology*, pp. 93–96, IEEE, 2010.
- [172] D. Wang, R. M. Kirby, and C. R. Johnson, “Finite-element-based discretization and regularization strategies for 3-D inverse electrocardiography,” *IEEE Transactions on Biomedical Engineering*, vol. 58, no. 6, pp. 1827–1838, 2011.
- [173] N. Zemzemi, “A steklov-poincaré approach to solve the inverse problem in electrocardiography,” in *Computing in Cardiology 2013*, pp. 703–706, IEEE, 2013.
- [174] N. Zemzemi, H. Bourenane, and H. Cochet, “An iterative method for solving the inverse problem in electrocardiography imaging: from body surface to heart potential,” in *Computing in Cardiology 2014*, pp. 717–720, IEEE, 2014.
- [175] B. Yao, R. Zhu, and H. Yang, “Characterizing the location and extent of myocardial infarctions with inverse ECG modeling and spatiotemporal regularization,” *IEEE journal of biomedical and health informatics*, vol. 22, no. 5, pp. 1445–1455, 2017.
- [176] M. J. Cluitmans, M. Clerx, N. Vandersickel, R. L. Peeters, P. G. Volders, and R. L. Westra, “Physiology-based regularization of the electrocardiographic inverse problem,” *Medical & biological engineering & computing*, vol. 55, pp. 1353–1365, 2017.
- [177] E. Ozkoc, E. Sunger, K. Ugurlu, and Y. S. Dogrusoz, “Prior model selection in bayesian MAP estimation-based ecg reconstruction,” in *2021 13th International Conference on Measurement*, pp. 142–145, IEEE, 2021.
- [178] J. Xie and B. Yao, “Physics-constrained deep learning for robust inverse ECG modeling,” *IEEE Transactions on Automation Science and Engineering*, vol. 20, no. 1, pp. 151–166, 2023.
- [179] X. Jiang, R. Missel, M. Toloubidokhti, K. Gillette, A. J. Prassl, G. Plank, B. M. Horáček, J. L. Sapp, and L. Wang, “Hybrid neural state-space modeling for supervised and unsupervised electrocardiographic imaging,” *IEEE Transactions on Medical Imaging*, 2024.
- [180] D. Wang, R. M. Kirby, R. S. MacLeod, and C. R. Johnson, “An optimization framework for inversely estimating myocardial transmembrane potentials and localizing ischemia,” in *2011 Annual International Conference of the IEEE Engineering in Medicine and Biology Society*, pp. 1680–1683, IEEE, 2011.
- [181] D. Potyagaylo, W. H. Schulze, and O. Doessel, “A new method for choosing the regularization parameter in the transmembrane potential based inverse problem of ECG,” in *2012 Computing in Cardiology*, pp. 29–32, IEEE, 2012.
- [182] M. Jiang, S. Jiang, *et al.*, “Study on parameter optimization for support vector regression in solving the inverse ECG problem,” *Computational and mathematical methods in medicine*, vol. 2013, 2013.
- [183] A. Lopez Rincon, M. Bendahmane, and B. Aïnseba, “Two-step genetic algorithm to solve the inverse problem in electrocardiography for cardiac sources,” *Computer Methods in Biomechanics and Biomedical Engineering: Imaging & Visualization*, vol. 2, no. 3, pp. 129–137, 2014.
- [184] L. Cheng and H. Liu, “Noninvasive cardiac transmembrane potential imaging via global features based FISTA network,” in *2021 43rd Annual International Conference of the IEEE Engineering in Medicine & Biology Society (EMBC)*, pp. 3149–3152, IEEE, 2021.
- [185] L. Mu and H. Liu, “Cardiac transmembrane potential imaging with GCN based iterative soft threshold network,” in *Medical Image Computing and Computer Assisted Intervention—MICCAI 2021: 24th International Conference, Strasbourg, France, September 27–October 1, 2021, Proceedings, Part VI 24*, pp. 547–556, Springer, 2021.
- [186] Y. Zhao, Z. Lin, K. Sun, Y. Zhang, J. Huang, L. Wang, and J. Yao, “SETMIL: spatial encoding transformer-based multiple instance learning for pathological image analysis,” in *International Conference on Medical Image Computing and Computer-Assisted Intervention*, pp. 66–76, Springer, 2022.
- [187] S. Lian, Z. Gao, H. Wang, X. Liu, L. Xu, H. Liu, and H. Zhang, “Frequency-enhanced geometric-constrained reconstruction for localizing myocardial infarction in 12-lead electrocardiograms,” *IEEE Transactions on Biomedical Engineering*, 2024.
- [188] M. Alawad and L. Wang, “Learning domain shift in simulated and clinical data: localizing the origin of ventricular activation from 12-lead electrocardiograms,” *IEEE transactions on medical imaging*, vol. 38, no. 5, pp. 1172–1184, 2019.
- [189] L. Li, J. Camps, A. Banerjee, M. Beetz, B. Rodriguez, and V. Grau, “Deep computational model for the inference of ventricular activation properties,” in *International Workshop on Statistical Atlases and Computational Models of the Heart*, pp. 369–380, Springer, 2022.
- [190] T. Irie, R. Yu, J. S. Bradfield, M. Vaseghi, E. F. Buch, O. Ajjijola, C. Macias, O. Fujimura, R. Mandapati, N. G. Boyle, *et al.*, “Relationship between sinus rhythm late activation zones and critical sites for scar-related ventricular tachycardia: systematic analysis of isochronal late activation mapping,” *Circulation: Arrhythmia and Electrophysiology*, vol. 8, no. 2, pp. 390–399, 2015.
- [191] R. Vijayakumar, J. N. Silva, K. A. Desouza, R. L. Abraham, M. Strom, F. Sacher, G. F. Van Hare, M. Haïssaguerre, D. M. Roden, and Y. Rudy, “Electrophysiologic substrate in congenital long qt syndrome: noninvasive mapping with electrocardiographic imaging (ECGI),” *Circulation*, vol. 130, no. 22, pp. 1936–1943, 2014.

- [192] K. M. Leong, F. S. Ng, C. Yao, C. Roney, P. Taraborrelli, N. W. Linton, Z. I. Whinnett, D. C. Lefroy, D. W. Davies, P. Boon Lim, *et al.*, "ST-elevation magnitude correlates with right ventricular outflow tract conduction delay in type I Brugada ECG," *Circulation: Arrhythmia and Electrophysiology*, vol. 10, no. 10, p. e005107, 2017.
- [193] P. S. Cuculich, M. R. Schill, R. Kashani, S. Mutic, A. Lang, D. Cooper, M. Faddis, M. Gleva, A. Noheria, T. W. Smith, *et al.*, "Noninvasive cardiac radiation for ablation of ventricular tachycardia," *New England Journal of Medicine*, vol. 377, no. 24, pp. 2325–2336, 2017.
- [194] T. Grandits, S. Pezzuto, J. M. Lubrecht, T. Pock, G. Plank, and R. Krause, "PIEMAP: personalized inverse eikonal model from cardiac electro-anatomical maps," in *International Workshop on Statistical Atlases and Computational Models of the Heart*, pp. 76–86, Springer, 2020.
- [195] A. Prakosa, H. J. Arevalo, *et al.*, "Personalized virtual-heart technology for guiding the ablation of infarct-related ventricular tachycardia," *Nature biomedical engineering*, vol. 2, no. 10, pp. 732–740, 2018.
- [196] P. Bhagirath, F. O. Campos, P. G. Postema, M. J. Kemme, A. A. Wilde, A. J. Prassl, A. Neic, C. A. Rinaldi, M. J. Götte, G. Plank, *et al.*, "Arrhythmogenic vulnerability of re-entrant pathways in post-infarct ventricular tachycardia assessed by advanced computational modelling," *Europace*, vol. 25, no. 9, p. eua4198, 2023.
- [197] G. Luongo, L. Azzolin, S. Schuler, M. W. Rivolta, *et al.*, "Machine learning enables noninvasive prediction of atrial fibrillation driver location and acute pulmonary vein ablation success using the 12-lead ECG," *Cardiovascular Digital Health Journal*, vol. 2, no. 2, pp. 126–136, 2021.
- [198] L. F. Rivera, M. Jiménez, P. Angara, N. M. Villegas, G. Tamura, and H. A. Müller, "Towards continuous monitoring in personalized healthcare through digital twins," in *Proceedings of the 29th annual international conference on computer science and software engineering*, pp. 329–335, 2019.
- [199] R. Martínez-Velázquez, R. Gamez, and A. El Saddik, "Cardio twin: A digital twin of the human heart running on the edge," in *2019 IEEE international symposium on medical measurements and applications (MeMeA)*, pp. 1–6, IEEE, 2019.
- [200] A. Intini, R. N. Goldstein, P. Jia, C. Ramanathan, K. Ryu, B. Giannattasio, R. Gilkeson, B. S. Stambler, P. Brugada, W. G. Stevenson, *et al.*, "Electrocardiographic imaging (ecgi): a novel diagnostic modality used for mapping of focal left ventricular tachycardia in a young athlete," *Heart Rhythm*, vol. 2, no. 11, pp. 1250–1252, 2005.
- [201] Y. Rudy, "Noninvasive ECG imaging (ECGI): Mapping the arrhythmic substrate of the human heart," *International journal of cardiology*, vol. 237, pp. 13–14, 2017.
- [202] R. A. Gray and P. Pathmanathan, "Patient-specific cardiovascular computational modeling: diversity of personalization and challenges," *Journal of cardiovascular translational research*, vol. 11, pp. 80–88, 2018.
- [203] P. S. Cuculich, Y. Wang, B. D. Lindsay, M. N. Faddis, R. B. Schuessler, R. J. Damiano Jr, L. Li, and Y. Rudy, "Noninvasive characterization of epicardial activation in humans with diverse atrial fibrillation patterns," *Circulation*, vol. 122, no. 14, pp. 1364–1372, 2010.
- [204] L. Roten, M. Pedersen, P. Pascale, A. Shah, S. Eliautou, D. Scherr, F. Sacher, and M. Haïssaguerre, "Noninvasive electrocardiographic mapping for prediction of tachycardia mechanism and origin of atrial tachycardia following bilateral pulmonary transplantation," *Journal of cardiovascular electrophysiology*, vol. 23, no. 5, pp. 553–555, 2012.
- [205] J. PEDRÓN-TORRECILLA, M. Rodrigo, A. M. Climent, A. Liberos, E. PÉREZ-DAVID, J. Bermejo, A. Arenal, J. Millet, F. FERNÁNDEZ-AVILÉS, O. Berenfeld, *et al.*, "Noninvasive estimation of epicardial dominant high-frequency regions during atrial fibrillation," *Journal of cardiovascular electrophysiology*, vol. 27, no. 4, pp. 435–442, 2016.
- [206] Z. Zhou, Q. Jin, L. Y. Chen, L. Yu, L. Wu, and B. He, "Noninvasive imaging of high-frequency drivers and reconstruction of global dominant frequency maps in patients with paroxysmal and persistent atrial fibrillation," *IEEE Transactions on Biomedical Engineering*, vol. 63, no. 6, pp. 1333–1340, 2016.
- [207] J. Zhang, D. H. Cooper, K. A. Desouza, P. S. Cuculich, P. K. Woodard, T. W. Smith, and Y. Rudy, "Electrophysiologic scar substrate in relation to vt: noninvasive high-resolution mapping and risk assessment with ecgi," *Pacing and Clinical Electrophysiology*, vol. 39, no. 8, pp. 781–791, 2016.
- [208] Y. Wang, P. S. Cuculich, J. Zhang, K. A. Desouza, R. Vijayakumar, J. Chen, M. N. Faddis, B. D. Lindsay, T. W. Smith, and Y. Rudy, "Non-invasive electroanatomic mapping of human ventricular arrhythmias with electrocardiographic imaging," *Science translational medicine*, vol. 3, no. 98, pp. 98ra84–98ra84, 2011.
- [209] N. Varma, P. Jia, and Y. Rudy, "Electrocardiographic imaging of patients with heart failure with left bundle branch block and response to cardiac resynchronization therapy," *Journal of electrocardiology*, vol. 40, no. 6, pp. S174–S178, 2007.
- [210] S. Ploux, J. Lumens, Z. Whinnett, M. Montaudon, M. Strom, C. Ramanathan, N. Derval, A. Zemmoura, A. Denis, M. De Guillebon, *et al.*, "Noninvasive electrocardiographic mapping to improve patient selection for cardiac resynchronization therapy: beyond qrs duration and left bundle branch block morphology," *Journal of the American College of Cardiology*, vol. 61, no. 24, pp. 2435–2443, 2013.
- [211] M. Haïssaguerre, M. Hocini, A. J. Shah, N. Derval, F. Sacher, P. Jais, and R. Dubois, "Noninvasive panoramic mapping of human atrial fibrillation mechanisms: a feasibility report," *Journal of cardiovascular electrophysiology*, vol. 24, no. 6, pp. 711–717, 2013.
- [212] R. Sachetto Oliveira, B. Martins Rocha, D. Burgarelli, W. Meira Jr, C. Constantinides, and R. Weber dos Santos, "Performance evaluation of GPU parallelization, space-time adaptive algorithms, and their combination for simulating cardiac electrophysiology," *International journal for numerical methods in biomedical engineering*, vol. 34, no. 2, p. e2913, 2018.
- [213] A. Neic, F. O. Campos, A. J. Prassl, S. A. Niederer, M. J. Bishop, E. J. Vigmond, and G. Plank, "Efficient computation of electrograms and ECGs in human whole heart simulations using a reaction-eikonal model," *Journal of Computational Physics*, vol. 346, pp. 191–211, 2017.
- [214] K. Gillette, M. A. Gsell, A. J. Prassl, E. Karabelas, U. Reiter, G. Reiter, T. Grandits, C. Payer, D. Štern, M. Urschler, *et al.*, "A framework for the generation of digital twins of cardiac electrophysiology from clinical 12-lead ECGs," *Medical Image Analysis*, vol. 71, p. 102080, 2021.
- [215] C. Herrero Martin, A. Oved, R. A. Chowdhury, E. Ullmann, N. S. Peters, A. A. Bharath, and M. Varela, "EP-PINNs: Cardiac electrophysiology characterisation using physics-informed neural networks," *Frontiers in Cardiovascular Medicine*, vol. 8, p. 768419, 2022.
- [216] X. Jiang, Z. Li, R. Missel, M. S. Zaman, B. Zenger, W. W. Good, R. S. MacLeod, J. L. Sapp, and L. Wang, "Few-shot generation of personalized neural surrogates for cardiac simulation via bayesian meta-learning," in *International Conference on Medical Image Computing and Computer-Assisted Intervention*, pp. 46–56, Springer, 2022.
- [217] A. Bertrand, J. Camps, V. Grau, and B. Rodriguez, "Deep learning-based emulation of human cardiac activation sequences," in *International Conference on Functional Imaging and Modeling of the Heart*, pp. 213–222, Springer, 2023.
- [218] T. Bacoyannis, B. Ly, N. Cedilnik, H. Cochet, and M. Sermesant, "Deep learning formulation of electrocardiographic imaging integrating image and signal information with data-driven regularization," *EP Europace*, vol. 23, no. Supplement\_1, pp. i55–i62, 2021.
- [219] M. Beetz, A. Banerjee, and V. Grau, "Multi-domain variational autoencoders for combined modeling of MRI-based biventricular anatomy and ecg-based cardiac electrophysiology," *Frontiers in physiology*, vol. 13, p. 886723, 2022.
- [220] M. Beetz, A. Banerjee, Y. Sang, and V. Grau, "Combined generation of electrocardiogram and cardiac anatomy models using multi-modal variational autoencoders," in *2022 IEEE 19th International Symposium on Biomedical Imaging (ISBI)*, pp. 1–4, IEEE, 2022.
- [221] P. Moingeon, M. Chenel, C. Rousseau, E. Voisin, and M. Guedj, "Virtual patients, digital twins and causal disease models: Paving the ground for in silico clinical trials," *Drug discovery today*, p. 103605, 2023.
- [222] C. Rodero, T. M. Baptiste, R. K. Barrows, H. Keramati, C. P. Sillett, M. Strocchi, P. Lamata, and S. A. Niederer, "A systematic review of cardiac in-silico clinical trials," *Progress in Biomedical Engineering*, 2023.