

**Invariant Subspaces of Nilpotent Operators.
Level, Mean, and Colevel: The Triangle $\mathbb{T}(n)$**

Claus Michael Ringel and Markus Schmidmeier

Abstract. We consider the category $\mathcal{S}(n)$ of pairs $X = (U, V)$, where V is a finite-dimensional vector space with a nilpotent operator T with $T^n = 0$, and U is a subspace of V such that $T(U) \subseteq U$. For any vector space V , let $|V|$ denote its dimension (or length). Note that $\mathcal{S}(n)$ is just the category of Gorenstein-projective $T_2(\Lambda)$ -modules, where $\Lambda = k[T]/\langle T^n \rangle$ and $T_2(\Lambda)$ is the ring of upper triangular (2×2) -matrices with coefficients in Λ . We consider three related invariants for the objects X in $\mathcal{S}(n)$, the *mean* qX , the *level* pX and the *colevel* rX . By definition, $qX = |V|/bV$, $pX = |U|/bV$, and $rX = |V/U|/bV$. Here, bV denotes the dimension of the kernel of the operator T , thus the number of its Jordan blocks, we call bV the *width* of V . The objects X with $bX = 1$ are called *pickets*.

For any X in $\mathcal{S}(n)$, both numbers pX , rX are non-negative and $pX + rX = qX \leq n$. It is the pr-triangle $\mathbb{T}(n)$ of vectors (p, r) with $p \geq 0$, $r \geq 0$, $p + r \leq n$, which we want to study in order to overview the category $\mathcal{S}(n)$. If X is an indecomposable object in $\mathcal{S}(n)$, we call $(pX, rX) \in \mathbb{T}(n)$ its *support*.

We use $\mathbb{T}(n)$ to visualize part of the categorical structure of $\mathcal{S}(n)$: The action of the duality D and the square τ_n^2 of the Auslander-Reiten translation are represented on $\mathbb{T}(n)$ by a reflection and a rotation by 120° degrees, respectively. Moreover for $n \geq 6$, each component of the Auslander-Reiten quiver of $\mathcal{S}(n)$ has support either contained in the center of $\mathbb{T}(n)$ or with the center as its only accumulation point.

We show that the only indecomposable objects X in $\mathcal{S}(n)$ with support having boundary distance smaller than 1 are the pickets which lie on the boundary, whereas any rational vector in $\mathbb{T}(n)$ with boundary distance at least 2 supports infinitely many indecomposable objects. At present, it is not clear at all what happens for vectors with boundary distance between 1 and 2; several partial results are included in the paper.

The use of $\mathbb{T}(n)$ provides even in the (quite well-understood) case $n = 6$ some surprises: we will show that any indecomposable object in $\mathcal{S}(6)$ lies on one of 12 central lines in $\mathbb{T}(6)$ and that the center of $\mathbb{T}(6)$ is the only vector which supports infinitely many indecomposables of $\mathcal{S}(6)$.

A further target of our investigations is to single out settings which are purely combinatorial: this concerns not only the behaviour near the boundary of the triangle $\mathbb{T}(n)$, but also sets of indecomposable objects: for example, the pickets, the bipickets, as well as the objects $X = (U, V)$ with U being cyclic.

The paper is essentially self-contained, all prerequisites which are needed are outlined in detail.

Question of some undergraduate students: *Ist in der Mathematik eigentlich nicht schon alles erforscht?*

Answer: *In der Linearen Algebra von endlichdimensionalen Vektorräumen ist in der Tat alles erforscht.*

From an interview with Günther M. Ziegler (2007), see [Z].

1.1. Let k be an arbitrary field. All vector spaces which we consider will be finite-dimensional k -spaces, the dimension (or length) of a vector space V will be denoted by $|V|$. We denote by $\mathcal{N}(n)$ the category of nilpotent operators with nilpotence index at most n (its objects are pairs $V = (V, T)$, where V is a vector space and $T: V \rightarrow V$ a linear transformation with $T^n = 0$), or, what is the same, the category of Λ -modules, where $\Lambda = k[T]/\langle T^n \rangle$. Let $\mathcal{N} = \bigcup_n \mathcal{N}(n)$. For $m \geq 1$, we denote by $[m]$ the m -dimensional vector space with a nilpotent operator with kernel of length 1; sometimes, it will be convenient to write $[0]$ for the zero object in \mathcal{N} . If V is an object of $\mathcal{N}(n)$, we denote by $[V]$ its isomorphism class. Note that the isomorphism classes of objects in $\mathcal{N}(n)$ correspond bijectively to the partitions bounded by n : If $\lambda = (\lambda_1, \dots, \lambda_b)$ is a partition, the corresponding module is $[\lambda] = [\lambda_1, \dots, \lambda_b] = \bigoplus_{i=1}^b [\lambda_i]$. The *height* of V (or λ) is defined to be λ_1 in case $V \neq 0$, and 0 otherwise. We denote by bV the length of the kernel of the operator T and call it the *width* of V (thus, bV is the number of Jordan blocks of the operator T , or, what is the same, the cardinality of a minimal generating set of V ; note that bV is the Krull-Remak-Schmidt multiplicity of V in \mathcal{N} ; and also the number of parts of the partition corresponding to $[V]$).

If V belongs to $\mathcal{N}(n)$ with operator T , a subspace $U \subseteq V$ is said to be an *invariant* subspace provided $T(U) \subseteq U$. The objects of the category $\mathcal{S}(n)$ are the pairs $X = (U, V)$, where V is in $\mathcal{N}(n)$, and $U \subseteq V$ is an invariant subspace of V ; if $X = (U, V)$, we write $VX = V$ and call it the *global space* of X and $UX = U$, and call it the *subspace* in X , and we put $vX = \dim VX$, $uX = \dim UX$, and $wX = \dim V/U$. If $X = (U, V)$ is an object of $\mathcal{S}(n)$, we consider (as in [RS1]) the pair $\mathbf{dim} X = (uX, vX)$; it is called the *dimension vector* of X . But in addition, we also will look at $bX = bV$. The maps $(U, V) \rightarrow (U', V')$ in $\mathcal{S}(n)$ are the Λ -homomorphisms $f: V \rightarrow V'$ such that $f(U) \subseteq U'$. Note that $\mathcal{S}(n)$ is an additive, but not an abelian, category. The *direct sum* of objects (U, V) and (U', V') is defined to be $(U, V) \oplus (U', V') = (U \oplus U', V \oplus V')$. An object (U, V) is *indecomposable* provided it is non-zero and not isomorphic to the direct sum of two non-zero objects. Let $\mathcal{S} = \bigcup_n \mathcal{S}(n)$. If $X = (U, V)$ is an object in \mathcal{S} , the *height* of X is by definition the height of V , thus the smallest number n such that X belongs to $\mathcal{S}(n)$.

Some special objects have to be mentioned already here: A *picket* is an object X in \mathcal{S} with $bX = 1$, thus it is of the form $([t], [m])$ with $m \geq 1$ and $0 \leq t \leq m$. An indecomposable object X in $\mathcal{S}(n)$ with $bX = 2$ will be called a *bipicket*.

Our aim is to provide information about the indecomposable objects in $\mathcal{S}(n)$. In Sections 1.2 to 1.8, we are going to formulate and explain the main results of the paper, namely Theorems 1 to 8. In order to overview the indecomposables in $\mathcal{S}(n)$, we will introduce in 1.4 the reference space $\mathbb{T}(n)$, it is a subset of \mathbb{R}^2 , namely a triangle and its interior. By definition, $\mathbb{T}(n)$ is the set of pairs (p, r) of real numbers with p, r , as well as

$p + r$ belonging to the interval $[0, n]$. Given a non-zero object X in $\mathcal{S}(n)$, we attach to it its pr-vector $\mathbf{pr} X = (uX/bX, wX/bX)$; as we will see easily, $\mathbf{pr} X$ belongs to $\mathbb{T}(n)$.

The first two results, Theorem 1 and 2, are formulated in Section 1.2 and deal with indecomposable objects X in $\mathcal{S}(n)$ such that X (that means $\mathbf{pr} X$) lies on or near to the boundary of $\mathbb{T}(n)$. On the other hand, Theorem 4 formulated in Section 1.5 concerns the indecomposable objects of $\mathcal{S}(n)$ with boundary distance at least 2.

Our investigation of the triangle $\mathbb{T}(n)$ and the symmetries of the category $\mathcal{S}(n)$ reveals that $\mathbb{T}(n)$ should be considered as an equilateral triangle. The symmetries of $\mathcal{S}(n)$ are the theme of Section 1.3: the decisive Theorem 3 draws the attention to the Auslander-Reiten translation $\tau = \tau_n$ in the category $\mathcal{S}(n)$, as considered in our previous paper [RS2]. As we will see, the square τ^2 of τ categorifies the rotation of $\mathbb{T}(n)$ by 120° . This surprising fact is a main ingredient for nearly all the results of the present paper.

Sections 1.6 to 1.8 are devoted to the half-line support as well as the triangle support of suitable classes of objects. In this way, we obtain some insight into the structure of the categories $\mathcal{S}(n)$, in particular about the relevance of the central lines in $\mathbb{T}(n)$ (the lines which pass through the center $z(n) = (n/3, n/3)$ of $\mathbb{T}(n)$). The results mentioned until now concern all the categories $\mathcal{S}(n)$, or at least those of infinite type; these are the categories $\mathcal{S}(n)$ with $n \geq 6$. The final theorem which will be presented in the introduction, namely Theorem 8, draws the attention to the case $n = 6$. This case seems to be of special interest and was considered already in [RS1] and [S2] quite in detail. Whereas the previous investigations put the emphasis on its large wealth of indecomposables, the present study establishes (on the contrary) severe finiteness conditions which are valid for $\mathcal{S}(6)$. In particular, we will see in Theorem 8 that all indecomposable objects of $\mathcal{S}(6)$ lie on just 12 central lines in $\mathbb{T}(6)$.

1.2. First results.

Theorem 1. *Let X be an indecomposable object of \mathcal{S} . Then either $uX = 0$ and $bX = 1$ (thus X is a picket), or else $uX \geq bX$.*

Theorem 2. *Let X be an indecomposable object of \mathcal{S} . If $vX \leq 2bX$, then X belongs to $\mathcal{S}(3)$ (and is a picket or a bipicket).*

These results may be considered as basic statements in linear algebra:

Theorem 1 (Reformulation). *Let $V = (V, T)$ be a linear operator and U a T -invariant subspace of V such that the pair (U, V) is indecomposable. Then either $U = 0$ (and V has only one Jordan block) or the dimension of U is at least the number of Jordan blocks of V .*

Theorem 1 can also be phrased as follows: *Let $X = (U, V)$ be an object in \mathcal{S} . If $uX < bX$, then V has a direct decomposition $V = V_1 \oplus V_2$ with $TV_i \subseteq V_i$ for $i = 1, 2$, such that $U \subseteq V_1$ and $V_2 \neq 0$.*

Theorem 2 (Reformulation). *Let (U, V) be a non-zero pair in \mathcal{S} such that the average size of the Jordan blocks of V is at most two. Then (U, V) has a direct summand which is either a picket $([t], [m])$ with $m \leq 2$ or the bipicket E_2^2 (with global space $[3, 1]$, subspace $[2]$ and factor space $[2]$).*

We picture the indecomposable objects in \mathcal{S} with $vX \leq 2 \cdot bX$: There are precisely 6 isomorphism classes, namely five pickets and the object E_2^2 .

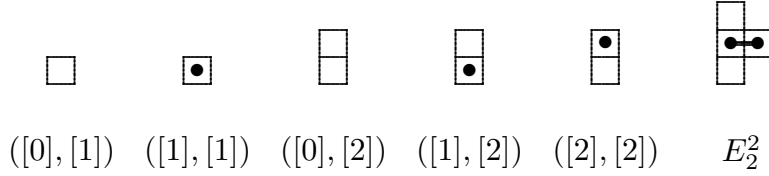

As in the previous paper [RS1], we try to visualize objects in \mathcal{S} by using boxes and bullets connected by lines; for an outline, see 2.2 below.

The essential assertion of Theorem 2 can be reformulated as follows: *There are only 2 isomorphism classes of indecomposable objects X in \mathcal{S} with $uX = bX = wX$, namely the picket $([1], [2])$ and the bipicket E_2^2 .*

1.3. Symmetries: duality and rotation.

We next draw the attention to two important internal symmetries of the category $\mathcal{S}(n)$. First of all, there is the duality functor D on $\mathcal{S}(n)$, defined by $D(U, V) = ((V/U)^*, V^*)$, where $V^* = \text{Hom}(V, k)$. Obviously, this contravariant functor has the property that

$$u(DX) = wX, \quad v(DX) = vX, \quad w(DX) = uX, \quad \text{and} \quad b(DX) = bX,$$

for all objects $X \in \mathcal{S}(n)$. Using D , we obtain:

Theorem 1'. *Let X be an indecomposable object of \mathcal{S} . Then either $wX = 0$ (and X is a picket), or else $wX \geq bX$.*

Of course, it is not surprising that Theorem 1 has this consequence, since dealing with finite-dimensional vector spaces, there always are such duality features.

There is a second symmetry, and this symmetry is really unexpected and exciting. It is based on the (relative) Auslander-Reiten functor of $\mathcal{S}(n)$, as considered in [RS2]. Let us recall the setting. The category $\mathcal{S}(n)$ may be identified with the category of the torsionless $T_2(\Lambda)$ -modules, where $\Lambda = k[T]/\langle T^n \rangle$ and $T_2(\Lambda)$ is the ring of upper triangular (2×2) -matrices with coefficients in Λ . Since $\mathcal{S}(n)$ is just the category of torsionless $T_2(\Lambda)$ -modules, $\mathcal{S}(n)$ has (relative) Auslander-Reiten sequences (by Auslander-Smalø), and we denote by $\tau = \tau_n$ the relative Auslander-Reiten translation of $\mathcal{S}(n)$.

The pickets $(0, [n])$ and $([n], [n])$ will be said to be the *projective* pickets, since they are the indecomposable projective $T_2(\Lambda)$ -modules. We say that X in $\mathcal{S}(n)$ is *reduced* provided X has no direct summand which is a projective picket. If X is a projective picket, then $\tau_n X = 0$. *If X in $\mathcal{S}(n)$ is reduced, then $\tau_n X$ is also reduced and $\tau_n^6 X = X$, see [RS2, Corollary 6.5].*

Theorem 3. *If X is a reduced object of $\mathcal{S}(n)$, then we have (for $\tau = \tau_n$):*

$$u(\tau^2 X) = wX, \quad v(\tau^2 X) = n \cdot bX - uX, \quad w(\tau^2 X) = n \cdot bX - vX, \quad \text{and} \quad b(\tau^2 X) = bX.$$

In particular, we see that the dimension vector (as well as the width) of $\tau^2 X$ only depend on the dimension vector and the width of X (this leads us in 1.4 to focus the

attention to these invariants). Let us stress that the corresponding assertions for τ itself do not hold: starting with indecomposable objects X, X' with equal dimension vector and equal width, the dimension vectors of τX and $\tau X'$ (also the width) usually are different. Already in $\mathcal{S}(5)$, we may look at the two indecomposable objects $X = (U, V)$, $X' = (U', V')$, both with dimension vector $(2, 6)$ and width 2, namely with $V = [4, 2]$ and $V' = [5, 1]$; the total space of $\tau_5 X$ is $[5, 3, 1]$, its subspace $[4, 2]$, thus $\mathbf{dim} \tau_5 X = (6, 9)$, whereas $\tau_5 X' = ([1], [4])$ is the picket with dimension vector $\mathbf{dim} \tau_5 X' = (1, 4)$.

Using τ^2 , we can reformulate Theorem 1 as follows:

Theorem 1''. *Let X be an indecomposable object of \mathcal{S} . Then either $vX = n \cdot bX$ (and X is a picket), or else $vX \leq (n - 1)bX$.*

In order to obtain Theorem 1'' from Theorem 1', we start with X indecomposable. Either X is a projective picket, then $vX = n$, and $bX = 1$, thus $vX = n \cdot bX$. Thus, we can assume that X is not a projective picket, thus $\tau^2 X$ is indecomposable and Theorem 1' asserts that $w(\tau^2 X) = 0$ and $\tau^2 X$ is a picket, or else that $w(\tau^2 X) \geq b(\tau^2 X) = bX$. Now $w(\tau^2 X) = n \cdot bX - vX$. If $w(\tau^2 X) = 0$, then $n \cdot bX = vX$ (and $bX = b(\tau^2 X) = 1$ shows that X is a picket). If $w(\tau^2 X) \geq bX$, then $n \cdot bX - vX = w(\tau^2 X) \geq bX$, and therefore $vX \leq (n - 1)bX$. \square

Looking back at Theorem 2, the indecomposable objects with $uX < bX$ are known by Theorem 1, those with $wX < bX$ are known by Theorem 1'; therefore, as we have mentioned already in 1.2, the essential assertion of Theorem 2 is: *There are only 2 isomorphism classes of indecomposable objects X in \mathcal{S} with $uX = bX = wX$, namely the picket $([1], [2])$ and the bipicket E_2^2 .* Using Theorem 3, we see:

Theorem 2'. *There are only 2 isomorphism classes of indecomposable objects X in $\mathcal{S}(n)$ with $uX = bX$ and $vX = (n - 1)bX$, namely the picket $([1], [n - 1])$ and the bipicket $\tau^2 E_2^2$.*

Theorem 2''. *There are only 2 isomorphism classes of indecomposable objects X in $\mathcal{S}(n)$ with $wX = bX$ and $vX = (n - 1)bX$, the picket $([n - 2], [n - 1])$ and the bipicket $\tau^4 E_2^2$.*

The four objects mentioned in Theorem 2' and Theorem 2'' can easily be visualized; for $n = 6$, they look as follows:

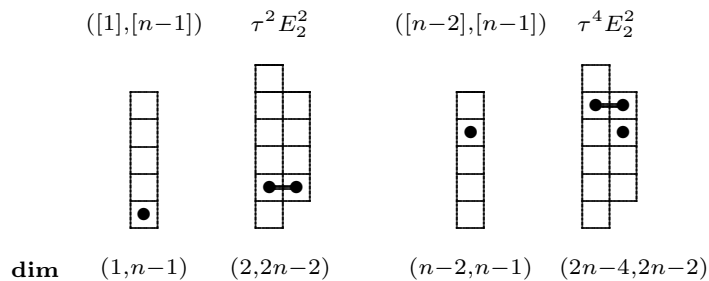

1.4. Uwb-vectors and the pr-triangle $\mathbb{T}(n)$. Looking at indecomposable objects X in $\mathcal{S}(n)$, the paper [RS1] has drawn the attention to the dimension vector $\mathbf{dim} X = (uX, vX)$, thus to the invariants u and v , or equivalently, to the invariants u and w (since

$v = u + w$). According to the results mentioned already, one also should take into account the invariant b (after all, the objects in \mathcal{S} are vector spaces with an operator and a subspace: the invariants u and w refer to the space and its subspace, and it is the invariant b which points to the operator). To repeat: It seems important to focus the attention not only to the invariants u and w , but also to b . It is *the relationship between the invariants u , w and b* , which has to be studied. Starting with these three invariants u , w , b , one may build further invariants: linear combinations, quotients, and so on. Our main interest will lie in the quotients u/b and w/b . (Later, the treatment of central lines will rely on the ratio $(3u - nb)/(3w - nb)$.)

Given an object X in \mathcal{S} , we call the triple $\mathbf{uwb} X = (uX, wX, bX)$ the *uwb-vector* of X . Actually, instead of looking at the reference space \mathbb{R}^3 with the triples (uX, wX, bX) , we will focus the attention to the corresponding projective space which contains for a non-zero object X the pair $\mathbf{pr} X = (uX/bX, wX/bX)$; we call $\mathbf{pr} X$ the *support* of X .

Thus, here are the main definitions for the present paper: Let X be a non-zero object in \mathcal{S} . The *level* pX , the *mean* qX , and the *colevel* rX of X are defined as follows:

$$pX = uX/bX, \quad qX = vX/bX, \quad rX = wX/bX$$

(Since for $X = 0$, the numbers uX , vX , wX , and bX are all zero, the quotients used in the definition of pX , qX and rX are not defined, thus mean, level, and colevel can only be considered for non-zero objects.) For any non-zero object X in \mathcal{S} , we have $qX = pX + rX$, thus any two of the invariants pX , qX , rX determine the third one. [A short hint to explain the terminology. Recall that the isomorphism class of a module in \mathcal{N} may be considered as a partition. The “mean” of an object $X = (U, V)$ in \mathcal{S} is just the mean (or average) of the partition $[V]$, thus the mean (or average) of the sizes of the Jordan blocks of the given operator. The intuition behind the chosen word “level” stems from the vision of considering U as a kind of filling of V , thus we measure how much of the global space is filled by the subspace (by dividing the length $|U|$ of the subspace through bV , the length of the socle of V .)]

The aim of the present paper is to consider the support $\mathbf{pr} X = (pX, rX)$ of the indecomposable objects X in $\mathcal{S}(n)$. Of course, for any non-zero X , both numbers pX , rX are non-negative. It is obvious that for X in $\mathcal{S}(n)$, we have $vX \leq n \cdot bX$, thus $qX \leq n$. It is the **pr-triangle** $\mathbb{T}(n)$ of vectors (p, r) with $p \geq 0$, $r \geq 0$, $p + r \leq n$, which we want to study. If \mathbb{X} is a subset of $\mathbb{T}(n)$, and X is an indecomposable object in $\mathcal{S}(n)$, we will say that X *lives* on \mathbb{X} (or also that \mathbb{X} *supports* X) provided $\mathbf{pr} X$ belongs to \mathbb{X} . The support of the pickets in $\mathcal{S}(n)$ together with the zero vector $(0, 0)$ provides the grid of the vectors in $\mathbb{T}(n)$ with integral coefficients.

We denote by $z(n) = (\frac{n}{3}, \frac{n}{3})$ the center of $\mathbb{T}(n)$ (this may be thought of as the center of gravity of the triangle). An indecomposable object X with $\mathbf{pr} X = z(n)$ is said to be *central*.

Let us present a picture of the triangle $\mathbb{T}(n)$. We show $\mathbb{T}(8)$ with its triangular grid given by the lines with p , q , or r being an integer. The center $z(8)$ is marked by a black

square ■.

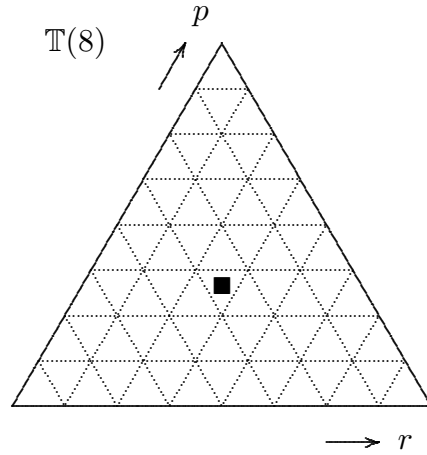

We stress that the triangle $\mathbb{T}(n)$ should be considered as an equilateral one, since the dihedral group Σ_3 of order 6, as the symmetry group of $\mathbb{T}(n)$, plays a decisive role in our investigation. Let D be the reflection of $\mathbb{T}(n)$ defined by $D(p, r) = (r, p)$, and ρ the rotation of $\mathbb{T}(n)$ by 120° (with center $z(n)$), so that $\rho(p, r) = (r, n - p - r)$. Thus, the symmetry group Σ_3 of the triangle $\mathbb{T}(n)$ is generated by ρ and D . According to Section 1.3, we have: *If X is a non-zero object in $\mathcal{S}(n)$, then $b(DX) = bX$ and $\mathbf{pr}(DX) = D\mathbf{pr}X$.* And second, Theorem 3 can be reformulated as follows:

Theorem 3 (Reformulation). *If X is a reduced non-zero object in $\mathcal{S}(n)$, then*

$$\mathbf{pr}\tau^2X = \rho\mathbf{pr}X, \quad \text{and} \quad b(\tau^2X) = bX.$$

We have shown in [RS2] that $\tau^6X = X$ for any reduced object in $\mathcal{S}(n)$ and that, as a consequence, all Auslander-Reiten components of $\mathcal{S}(n)$ are tubes of rank 1,2,3, or 6.

Corollary. *Let $n \geq 6$. If X is an indecomposable object in $\mathcal{S}(n)$ which occurs in a tube of rank 1 or 2, then X is central.*

Namely, if $X = \tau^2X$ then $\mathbf{pr}X = \rho\mathbf{pr}X$ so X is central. □

Boundary distance. The boundary of $\mathbb{T}(n)$ consists of the vectors (p, r) with $p = 0$, or $r = 0$, or $p + r = n$. Given a vector (p, r) in $\mathbb{T}(n)$, its *boundary distance* is $d(p, r) = \min\{p, r, n - p - r\}$. Thus, (p, r) belongs to the boundary if and only if its boundary distance is equal to 0, whereas $z(n) = (n/3, n/3)$ is the only vector with boundary distance $n/3$ (and there are no vectors with boundary distance greater than $n/3$). For $0 \leq d < n/3$, we write Δ_d for the set of pr-vectors with boundary distance d , and call Δ_d a *standard triangle*. The standard triangles and the one-element set $\{z(n)\}$ provide a partition of $\mathbb{T}(n)$.

If X is indecomposable in $\mathcal{S}(n)$, the number $dX = d(\mathbf{pr}X)$ is called the *boundary distance* of X . Of course, X is central if and only if $dX = d(z(n)) = n/3$; also, X lies on the standard triangle Δ_d if and only if $dX = d$. The invariant d (and the corresponding standard triangles) play an important role in our investigation. One of the reasons is of course the equality $d(\tau^2X) = dX$ for X reduced.

A picket whose pr-vector lies on the boundary will be called a *boundary picket*. There are $3n - 1$ boundary pickets in $\mathcal{S}(n)$, namely n pickets of the form $([0], [m])$ with $1 \leq m \leq n$

(the *void* pickets), also n pickets of the form $([m], [m])$ with $1 \leq m \leq n$ (the *full* pickets), and finally $n - 1$ pickets of the form $([t], [n])$ with $1 \leq t < n$ (the non-projective pickets of height n).

Let us provide an illustration for Theorem 1 and Theorem 2, say for $n = 8$. The boundary triangle Δ_0 is dotted, the triangle Δ_1 is dashed. The small bullets \bullet mark the position of the boundary pickets, as well as the corners of Δ_1 . These corners are, in addition, encircled, in order to indicate that they support also one of the bipickets E_2^2 , $\tau^2 E_2^2$ and $\tau^4 E_2^2$. According to 1.3, the support of the remaining indecomposable objects has boundary distance at least 1 and is not a corner of Δ_1 , thus it lies in the shaded region.

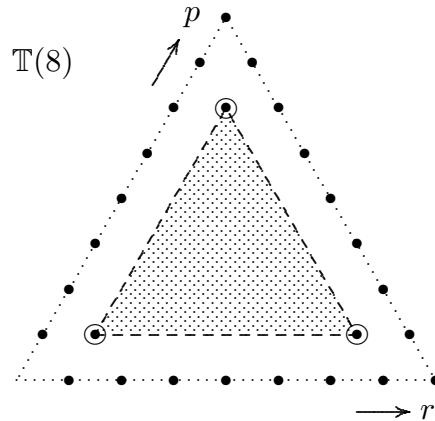

Note that for $n = 3$, Theorems 1 and 2 recover the full classification of the indecomposable objects in $\mathcal{S}(n)$: there are 9 pickets and the bipicket E_2^2 . Below, we provide two versions of the triangle $\mathbb{T}(3)$. In the left version, the pickets are marked by bullets, whereas the circle at the center $z(3)$ indicates that $z(3)$ is also the pr-vector of the only additional indecomposable object, the bipicket E_2^2 . On the right, all the individual objects are visualized.

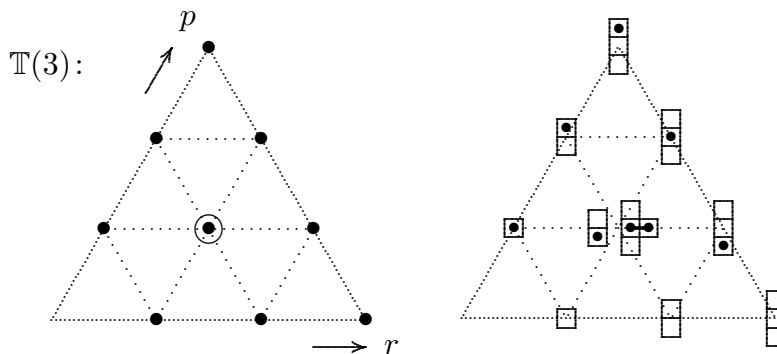

As we have seen in 1.3, the vectors in $\mathbb{T}(n)$ which support indecomposable objects and which have boundary distance smaller than one have integral coordinates. The coordinates of the pr-vectors (p, r) of a bipicket have denominator at most 2, thus (p, r) belongs to a grid line. But already for $n = 5$, there are indecomposable objects which are neither pickets, nor bipickets (still all vectors in $\mathbb{T}(5)$ which support indecomposable objects lie on grid lines, see 15.1 and 10.9). Indecomposable objects X whose pr-vectors do not lie on

a grid line occur for $n = 6$; here are two examples X and Y with $\mathbf{pr} X = (5/3, 5/3)$ and $\mathbf{pr} Y = (7/3, 7/3)$.

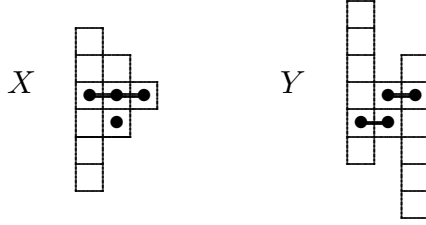

There are many more, as we will see.

1.5. Pr-vectors with boundary distance at least 2. As we have seen in 1.3, there are only finitely many indecomposable objects which have boundary distance smaller than 1, namely $3n - 1$ pickets. And there are precisely two indecomposable objects which lie on a given corner of Δ_1 : a picket and a bipicket.

A \mathbb{P}^1 -family $M = \{M_c \mid c \in \mathbb{P}^1(k)\}$ of objects is a set of pairwise non-isomorphic indecomposable objects with fixed uwb-vector, indexed by the elements of the projective line $\mathbb{P}^1 = \mathbb{P}^1(k)$ over k (the elements $c = (c_0 : c_1)$ of \mathbb{P}^1 are the one-dimensional subspaces of k^2 , we write $c = (c_0 : c_1)$ for the subspace generated by the non-zero element $(c_0, c_1) \in k^2$).

We say that the vector (p, r) in $\mathbb{T}(n)$ is a *BTh-vector* provided there is a positive natural number a such that for any $t \in \mathbb{N}_1$, there is a \mathbb{P}^1 -family of indecomposable objects in $\mathcal{S}(n)$ with uwb-vector (atp, atr, at) (the corresponding *BTh-family*). (Here, the letters BTh refer to Brauer-Thrall, since the property which defines BTh-vectors reminds of the second Brauer-Thrall conjecture in the form which seems now to be the accepted one: to have \mathbb{P}^1 -families of indecomposable objects for all dimensions which are a multiple of a fixed one.) Of course: *If (p, r) is a BTh-vector, then there are infinitely many isomorphism classes of indecomposable objects in $\mathcal{S}(n)$ with pr-vector (p, r) , even if k is finite.*

It is well-known that $\mathcal{S}(5)$ has only finitely many (namely 50) isomorphism classes of indecomposable objects, see for example [RS1], thus there are no BTh-vectors in $\mathbb{T}(5)$. On the other hand, $(2, 2) \in \mathbb{T}(6)$ is a BTh-vector, Namely, there is a one-parameter family of indecomposable objects $X = (U, V)$, where $V = [6, 4, 2]$ and the subspaces U are suitable 6-dimensional subspaces of V (see [RS1], or already [Bh]; details concerning this family will be recalled in Example 2.7). There are indecomposable objects $X[t]$ in $\mathcal{S}(6)$ which have a filtration with t factors, all being isomorphic to X , where $t \geq 1$. Since $\mathbf{uwb} X = (6, 6, 3)$, we have $\mathbf{uwb} X[t] = (6t, 6t, 3t)$ (and therefore $\mathbf{pr} X[t] = (2, 2)$) for all $t \geq 1$.

Actually, $(2, 2)$ is the only BTh-vector in $\mathbb{T}(6)$, see Theorem 8 below. In general, for $n \geq 6$, let us look at the set of pr-vectors with boundary distance at least 2 (in the case $n = 6$, this set consists just of the single vector $(2, 2)$).

Theorem 4. *Any rational pr-vector with boundary distance at least 2 is a BTh-vector.*

Let us present again the case $\mathbb{T}(8)$. The pr-vectors with boundary distance at least 2 lie in the dark region bounded by the triangle Δ_2 .

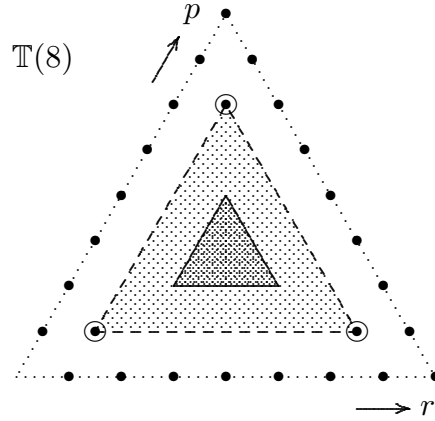

The proof of Theorem 4 will provide further information on the objects which we are able to construct, namely, we will show that required indecomposable objects can be constructed by starting with objects which are rather similar to those in the one-parameter family of indecomposable objects $X = (U, V)$ in $\mathcal{S}(6)$ with $V = [6, 4, 2]$ mentioned above.

In addition to the BTh-vectors provided by Theorem 4, already for $n = 7$, there are further BTh-vectors see Section 8; they have boundary distance smaller than 2. For $n \geq 9$, there are even BTh-vectors with boundary distance equal to 1, see Section 7. For any n , we present a possible guess how the region of BTh-vectors may look like, see Section 16.5.

Remark. In the present paper only vectors in $\mathbb{T}(n)$ with rational coordinates play a role, since we restrict the attention to finite-dimensional vector spaces. If one considers (as one should!) also infinite-dimensional vector spaces, then it will be useful to remember that any vector in $\mathbb{T}(n)$ with boundary distance at least 2 (and with arbitrary real, not necessarily rational coordinates) is an accumulation point of BTh-vectors.

1.6. Central half-lines. Let us assume now that $n \geq 6$, and let us draw the attention to the central half-lines in $\mathbb{T}(n)$, these are the half-lines starting in $z(n)$. Note that a central line (i.e. a line which passes through $z(n)$) is the union of two central half-lines; they are said to be *complementary*. The relevance of central half-lines when studying $\mathcal{S}(n)$ is based on the following Theorem.

Theorem 5. *Let $n \geq 6$. Let X be indecomposable. Then there is a (uniquely determined) indecomposable object X^+ and a positive integer β_X (also uniquely determined) such that*

$$\frac{u|w}{b}X^+ = \frac{u|w}{b}X + \beta_X \cdot \frac{n|n}{3},$$

and such that there is a sectional path from X to X^+ of length 6.

In particular, X is central if and only if X^+ is central. If X is not central, then X^+ belongs to the central half-line H through X . Starting with X , Theorem 5 provides countable many indecomposable objects which lie on H .

If \mathcal{X} is a class of indecomposable objects in $\mathcal{S}(n)$, the *half-line support* of \mathcal{X} is defined to be the set of central half-lines H in $\mathbb{T}(n)$ which have the property that there is at least one non-central object in \mathcal{X} which lies on H .

Corollary. *Let $n \geq 6$. Assume that H belongs to the half-line support of an Auslander-Reiten component \mathcal{C} . Then there are infinitely many vertices in H which support indecomposable objects in \mathcal{C} and which converge to $z(n)$.*

Namely, assume that the central half-line H supports the non-central object X in \mathcal{C} . Starting with X , Theorem 5 provides inductively an infinite sequence X^{+t} indexed by $t \in \mathbb{N}_0$ and defined by $X^{+0} = X$ and $X^{+(t+1)} = (X^{+t})^+$. The objects X^{+t} have pairwise different pr-vectors, all lie on the central half-line H and the corresponding pr-vectors converge to $z(n)$.

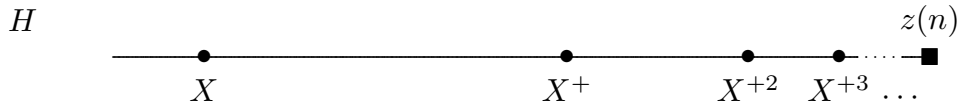

Addition to Theorem 5. As we have mentioned, the object X^+ as well as the number βX provided for X in Theorem 5 are uniquely determined by X . In addition, as we will see, βX only depends on the Auslander-Reiten component \mathcal{C} to which X belongs and will be called the *weight* of \mathcal{C} . Since with X also X^+ belongs to the component \mathcal{C} , we have $\beta X^+ = \beta X$. As a consequence, the infinite sequence X^{+t} given by the Corollary is very well behaved and will be called an *arithmetical sequence*.

1.7. The half-line support and the triangle support of a component.

For any class \mathcal{X} of indecomposable objects in $\mathcal{S}(n)$, we have defined in 1.6 its half-line support. Let us also define its triangle support. Both together seem to shed a lot of light on such a class \mathcal{X} . The *triangle support* of \mathcal{X} is the union of the standard triangles Δ_d in $\mathbb{T}(n)$ which support at least one non-central object in \mathcal{X} . We write

$$\Psi(\mathcal{X}) = \{0 \leq d < n/3 \mid \Delta_d \text{ is contained in the triangle support of } \mathcal{X}\}$$

for the index set and use the abbreviation $\Psi = \Psi(\mathcal{S}(6))$. (By definition, both the half-line support as well as the triangle support of a set of central indecomposables is empty.)

We will consider now the half-line support and the triangle support for an Auslander-Reiten component in $\mathcal{S}(n)$, with $n \geq 6$. In 1.8, we will consider the half-line support and the triangle support for the whole category $\mathcal{S}(6)$.

Let us recall the following facts, see [RS1,RS2]. Since the category $\mathcal{S}(n)$ has an Auslander-Reiten translation, we may look at the Auslander-Reiten quiver of $\mathcal{S}(n)$. The Auslander-Reiten quiver is connected in case $\mathcal{S}(n)$ has finite type, thus if $n \leq 5$. If $n \geq 6$, the Auslander-Reiten components are tubes of rank 1, 2, 3 or 6. For any $n \geq 1$, there is a unique component $\mathcal{P}(n)$ which is not stable, it is the component which contains the simple object $S = (0, [1])$; we call $\mathcal{P}(n)$ the *principal component*. The isomorphism classes of the projective pickets $(0, [n])$ and $([n], [n])$ are the projective as well as the injective vertices of $\mathcal{P}(n)$. If we delete the projective vertices from $\mathcal{P}(n)$, we obtain a stable component; for $n \geq 6$, this stable component is a tube of rank 6. We assume in 1.7 from now on that $n \geq 6$.

Theorem 6. *Let \mathcal{C} be an Auslander-Reiten component in $\mathcal{S}(n)$ where $n \geq 6$.*

(a) *In case \mathcal{C} is stable, the half-line support of \mathcal{C} is the union of at most 15 pairs of complementary central half-lines. The half-line support of $\mathcal{P}(n)$ is the union of 18 or 24 half-lines, for $n = 6$, or $n \geq 7$, respectively, and always precisely 12 of these half-lines form complementary pairs.*

(b) *The triangle support of \mathcal{C} is the union of triangles Δ_d with $d \in \Psi(\mathcal{C})$. If \mathcal{C} has at least one non-central object (so that $\Psi(\mathcal{C})$ is not empty), then $n/3$ is an accumulation point of $\Psi(\mathcal{C})$, and the only one.*

(c) *Any non-central vector in $\mathbb{T}(n)$ is the support of at most 11 objects in \mathcal{C} . The center $z(n)$ is the support of countably many objects in \mathcal{C} .*

Some comments.

The half-line support of a component. The bound 15 in the first assertion is optimal for $n = 7$, see 10.2; but, as we will see in Theorem 8, it is not optimal for $n = 6$: According to Theorem 8, the category $\mathcal{S}(6)$ is supported by just 12 central lines, thus any component of $\mathcal{S}(6)$ is supported by at most 12 lines.

The precise description of the half-line support of $\mathcal{P}(n)$ is as follows: First of all, there are the central half-lines $\mathbb{P}(n)$ which are parallel to the boundary lines. Then there are the central half-lines $\mathbb{D}(n)$ contained in the diagonal lines. These are the 6 pairs of complementary half-lines in the half-line support of $\mathcal{P}(n)$. Then, for all $n \geq 6$, there is the central half-line which supports S ; using reflections and rotations this yields 6 half-lines $\mathbb{H}_\ell(n)$. If $n \geq 7$, the additional 6 half-lines $\mathbb{K}_s(n)$ are obtained from the central half-line which supports E_2^{n-2} using reflections and rotations (the global space of E_2^{n-2} is $[n-1, 1]$, the subspace is $[2]$, the factor space $[n-2]$); for $n = 6$, the object E_2^{n-2} is contained in $\mathbb{P}(6)$. The half-line support of $\mathcal{P}(6)$ is $\mathbb{P}(6) \cup \mathbb{D}(6) \cup \mathbb{H}_\ell(6)$, and the half-line support of $\mathcal{P}(n)$ for $n \geq 7$ is $\mathbb{P}(n) \cup \mathbb{D}(n) \cup \mathbb{H}_\ell(n) \cup \mathbb{K}_s(n)$.

Let us stress the following difference between $\mathcal{P}(n)$ and the stable components: The half-line support of a stable component is the union of lines, whereas there are half-lines in the half-line support of $\mathcal{P}(n)$ such that the complementary ones are not contained in the half-line support.

Note that the non-central pickets in $\mathcal{S}(6)$ are supported by $\mathbb{P}(6) \cup \mathbb{D}(6) \cup \mathbb{H}_\ell(6)$ and this is the half-line support of $\mathcal{P}(6)$. The half-line support of the complete category $\mathcal{S}(6)$ will be discussed in Section 11.

The triangle support of a component \mathcal{C} . For a stable component \mathcal{C} , the set $\Psi(\mathcal{C})$ is given by the numbers of the form $d = (u + 6\beta t)/(b + 3\beta t)$, where β is the weight of \mathcal{C} , with (u, b) belonging to a set of at most 10 pairs.

Now we consider $\mathcal{C} = \mathcal{P}(n)$. The increasing sequence $\Psi(\mathcal{P}(n))$ is a subset of the interval $[0, n/3[$. The elements of $\Psi(\mathcal{P}(n))$ can be distributed into 5 subsets of the form $(u + 6t)/(b + 3t)$ with $t \in \mathbb{N}_0$ and (u, b) being one of the following 5 pairs, see Section 10.6:

$$(0, 1), (1, 1), (2, 2), (n-2, 3), (n-1, 3).$$

Number of indecomposables with same pr-vector. We show in Proposition 9.13 that any standard triangle is the support of at most 33 objects in \mathcal{C} (and the number 33

is optimal). This implies that any non-central vertex in $\mathbb{T}(n)$ is the support of at most 11 objects in \mathcal{C} (but the number 11 does not seem to be optimal).

1.8. The case $n = 6$.

As we have mentioned, the categories $\mathcal{S}(n)$ with $n \leq 5$ have finite type, whereas those with $n \geq 6$ have infinite type. The border case $n = 6$ is clearly of special interest. We have devoted a lot of energy in [RS1, S2] in order to describe the category $\mathcal{S}(6)$ explicitly. It is worthwhile to have a further look at $\mathcal{S}(6)$, now taking into account the invariant b . First, we will deal with bounds which concern b (similar to the known one for u and w), then we will use the bounds for u, w, b in order to establish several finiteness results which are similar to the finiteness results shown in Theorem 6 for single components.

Bounds. A basic result of our previous paper [RS1] asserts that for X indecomposable in $\mathcal{S}(6)$, one has $|vX - 2uX| \leq 6$, or, equivalently, that $|wX - uX| \leq 6$. We have stressed several times that the aim of the present paper is to invoke besides the invariants uX and wX also the width bX . There are the following three inequalities which relate the width b to u , v and w .

Theorem 7. *If X is indecomposable in $\mathcal{S}(6)$, then there are the following inequalities*

$$|uX - 2 \cdot bX| \leq 4, \quad |vX - 4 \cdot bX| \leq 4, \quad |wX - 2 \cdot bX| \leq 4.$$

for all indecomposable objects X in $\mathcal{S}(6)$.

These inequalities are optimal: For example, let us look at the first inequality: the objects $X = P[6t]$ with $t \geq 0$ have $uX = 6(t + 1)$ and $bX = 3t + 1$, thus $uX - 2 \cdot bX = (6t + 6) - 2(3t + 1) = 4$. The object $X = ([3, 1], [6, 4, 3, 1])$ has $uX = 4 = bX$, thus $uX - 2 \cdot bX = -4$. (If we consider only the objects in the principal component $\mathcal{P}(6)$, we get better inequalities. Let us add that we have $-2 \leq uX - 2 \cdot bX \leq 4$ and $-3 \leq vX - 4 \cdot bX \leq 2$ for X in $\mathcal{P}(6)$, see 11.4.)

There are indecomposable objects with $u = 2 \cdot bX - 4$, and also indecomposable objects with $w = 2 \cdot bX - 4$, but the middle inequality in Theorem 7 asserts that we cannot have both conditions at the same time!

The known symmetries assert that the three inequalities are equivalent (thus only one of them has to be shown, this will be done in Section 11.4). Namely, the duality D shows that the first and the last inequality are obviously equivalent. In order to show that the first inequality implies the second, let us assume that $|uY - 2 \cdot bY| \leq 4$ for all indecomposable objects Y in $\mathcal{S}(6)$. Let X be indecomposable in $\mathcal{S}(6)$. If X is projective, then $vX = 6$ and $bX = 1$, thus $vX - 4 \cdot bX = 2$. Thus, we may assume that X is not projective. Then $X = \tau^2 Y$ for some indecomposable object Y in $\mathcal{S}(6)$ and by assumption, we have $|uY - 2 \cdot bY| \leq 4$. According to Theorem 3, $vX = v(\tau^2 Y) = 6 \cdot bY - uY$ and $bX = b(\tau^2 Y) = bY$. Therefore $|vX - 4 \cdot bX| = |6 \cdot bY - uY - 4 \cdot bY| = |uY - 2 \cdot bY| \leq 4$. A similar argument shows that the second inequality implies the first one. \square

We may divide the inequalities by bX in order to get the following estimates for $pX - 2$, for $qX - 4$, and for $rX - 2$.

Corollary. *If X is indecomposable in $\mathcal{S}(6)$, then there are the following inequalities*

$$|pX - 2| \leq \frac{4}{bX}, \quad |qX - 4| \leq \frac{4}{bX}, \quad |rX - 2| \leq \frac{4}{bX}$$

for all indecomposable objects X in $\mathcal{S}(6)$. □

Finiteness results. Our previous paper [RS1] has provided a complete classification of the indecomposable objects in $\mathcal{S}(6)$, using three kinds of invariants: rational numbers (called the index, or, better, the rationality index), the elements of the projective line \mathbb{P}^1 (as parameter inside a tubular family), as well as combinatorial ones (in order to describe the position in a tube). Our present approach to look at the distribution of the pr-vectors is less ambitious, but it shows its power even in the case $n = 6$, see the following Theorem 8.

Since we consider here just the possible pr-vectors, we cannot expect any new information concerning central objects. Whereas the classification given in [RS1] may give the impression that $\mathcal{S}(6)$ has an abundance of indecomposable objects, Theorem 8 focuses the attention to several strong finiteness properties of $\mathcal{S}(6)$. We denote by $\mathbb{L}(6)$ the union of $\mathbb{P}(6)$, $\mathbb{D}(6)$, $\mathbb{H}(6)$, where $\mathbb{H}(6)$ is obtained from $\mathbb{H}_\ell(6)$ by adding the complementary half-lines. Thus $\mathbb{L}(6)$ is the union of 12 pairs of complementary half-lines.

Theorem 8.

(a) *The half-line support of $\mathcal{S}(6)$ is $\mathbb{L}(6)$, thus the union of 12 pairs of complementary central half-lines.*

(b) *Write the triangle support of $\mathcal{S}(6)$ as the disjoint union of the triangles Δ_d with $d \in \Psi$. Then this index set Ψ is an increasing sequence of rational numbers $0 \leq d < 2$ which converge to 2.*

(c) *Any non-central vector in $\mathbb{T}(6)$ is the support of a finite number of indecomposable objects in $\mathcal{S}(6)$; these numbers are **not** bounded. The center $z(6)$ is the support of infinitely many indecomposable objects of $\mathcal{S}(6)$, the number is $\max(\aleph_0, |k|)$.*

The last assertion in (c) follows directly from Theorem 5. The remaining assertions are established in Section 11. Here are some comments on Theorem 8.

The half-line support of $\mathcal{S}(6)$. According to Theorems 6 and 8, we obtain the half-line support of $\mathcal{S}(6)$ from the half-line support $\mathbb{P}(6) \cup \mathbb{D}(6) \cup \mathbb{H}_\ell(6)$ of $\mathcal{P}(n)$ by adding the half-lines complementary to the half-lines in $\mathbb{H}_\ell(6)$. As we have mentioned, all pickets of $\mathcal{S}(6)$ live on $\mathbb{P}(6) \cup \mathbb{D}(6) \cup \mathbb{H}_\ell(6)$, this holds also true for the bipickets. The smallest non-central objects in $\mathcal{S}(6)$ which live on $\mathbb{H}(6) \setminus \mathbb{H}_\ell(6)$ have width 3, they are exhibited in 11.7, see also 15.2 (c).

A central line L in $\mathbb{T}(6)$ can be described by specifying its slope $\phi \in \mathbb{R} \cup \{\infty\}$, namely $L = L_\phi$, where $L_\phi = \{(p, r) \in \mathbb{T}(6) \mid (u - 2b)/(w - 2b) = \phi\}$. The set $\mathbb{L}(6)$ is the set of the lines L_ϕ with $\phi \in \Phi$:

$$\Phi = \{0, \frac{1}{2}, 1, 2, \infty, -3, -2, -\frac{3}{2}, -1, -\frac{2}{3}, -\frac{1}{2}, -\frac{1}{3}\},$$

(The 12 lines in $\mathbb{L}(6)$ can be written in a unified way if we refer also to the syzygy module ΩV of V in $\mathcal{N}(n)$. Namely, let $\omega = |\Omega V|$. Using the functions u, w, ω , all the 12 lines are

given by equations of the form $u = 2b$ (one of the functions is constant, namely equal to $2b$), $u = w$ (two of the functions coincide), and finally $u = 2(w - b)$, see 11.7.)

The triangle support. The increasing sequence Ψ is a subset of the interval $[0, 2[$. Here are the first numbers in Ψ :

$$0, 1, \frac{5}{4}, \frac{4}{3}, \frac{7}{5}, \frac{10}{7}, \frac{3}{2}, \frac{11}{7}, \frac{8}{5}, \frac{13}{8}, \frac{5}{3}, \dots$$

All elements of Ψ are of the form $2 - c/m$ with $c = 3$ or $c = 4$ and $m \in \mathbb{N}_1$. They can be distributed into 10 subsets of the form $(u + 6t)/(b + 3t)$ with $t \in \mathbb{N}_0$ and (u, b) being one of the following pairs

$$(0, 1), (1, 1), (2, 2), (3, 2), (3, 3), (4, 3), (4, 4), (5, 3), (5, 4), (7, 5).$$

Theorem 8 provides for $n = 6$ a generalization of an essential part of Theorem 1. Namely, Theorems 1, 1', 1'' assert that there is no indecomposable object with support in Δ_d , where d belongs to the open interval $]0, 1[$. Using Theorem 8, we obtain countably many open intervals with this property. We do not know whether a corresponding assertion may exist for $7 \leq n \leq 9$. For $n \geq 10$, Corollary in 8.5 shows that for any rational number d with $1 \leq d \leq \frac{n}{3}$, there is an indecomposable object X in $\mathcal{S}(n)$ with boundary distance d .

The intersections of central half-lines and standard triangles. According to Theorem 8, any non-central indecomposable object of $\mathcal{S}(6)$ lives on the intersection of a half-line in $\mathbb{L}(6)$ and a triangle Δ_d with $d \in \Psi$. However, not all intersection vertices arise in this way: For all values $d \in \Psi$, the set $\mathbb{L}(6) \cap \Delta_d$ has cardinality 24, however, according to Theorem 1, there are only 17 indecomposable objects with pr-vector in Δ_0 . For $d = 1$, all vertices of $\mathbb{L}(6) \cap \Delta_1$ support indecomposable objects, see 15.2. On the other hand, for $d = \frac{5}{4}$, the set Δ_d is the support of only few indecomposables, see 15.2.

The essence of Theorem 8. Altogether, Theorem 8 combines **three** different finiteness assertions for the set of non-central indecomposable objects in $\mathcal{S}(6)$, similar to Theorem 6. First of all, there are only 12 central lines which support non-central indecomposable objects. Second, given $a < 2$, there are only finitely many numbers $d \leq a$ such that Δ_d supports an indecomposable object. And third, for any vector $(p, r) \neq (2, 2)$ in $\mathbb{T}(6)$, there are only finitely many indecomposable objects with pr-vector (p, r) . But note that all these finiteness conditions concern the non-central indecomposable objects of $\mathcal{S}(6)$: the central ones are collected in the black square, and this black square may be considered as a sort of black hole of the category.

Let us present the pr-triangle $\mathbb{T}(6)$ in two ways: once together with the 12 lines L_ϕ (left), once with some of the triangles Δ_d (right). As before, the center $z(6) = (2, 2)$ of $\mathbb{T}(6)$ will be marked by a black square \blacksquare , it is the support of the unique central picket $([2], [4])$; the support of the remaining pickets will be shown as small bullets \bullet .

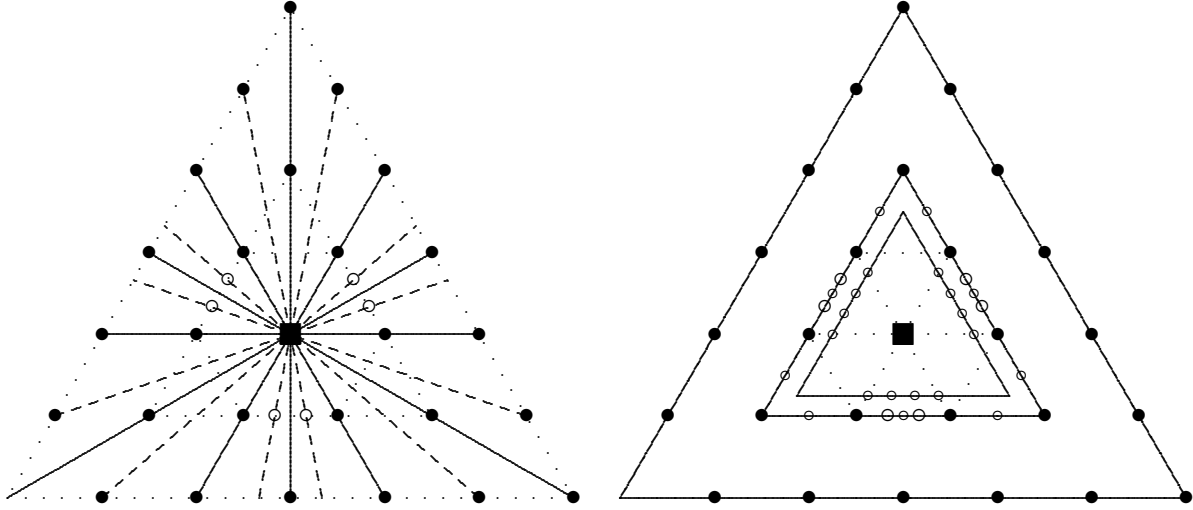

To repeat: In the picture on the left, we have shown the 12 central lines L_ϕ in $\mathbb{L}(6)$ which contain a boundary picket (for the values ϕ , see 11.7). These 12 central lines are drawn in two different ways: The diagonal lines $\mathbb{D}(6)$ and the lines $\mathbb{P}(6)$ parallel to the boundary are drawn as solid lines, the remaining half lines in $\mathbb{H}(6)$ are dashed (for the half-lines in $\mathbb{H}(6) \setminus \mathbb{H}_\ell(6)$, we have indicated by a small circle \circ the position of the smallest non-central object which lives on this half-line; for the shape of these objects, see 11.7).

In the picture on the right, we have drawn the sets Δ_d for the first three values $d = 0, 1, \frac{5}{4}$ and the position of the indecomposable objects living on these triangles Δ_d (see 15.2 and Appendix B). Of course, if we insert further sets Δ_d , we obtain a nested sequence of triangles with size converging to zero.

The relevant hexagon in $\mathbb{T}(6)$. Let us draw the attention to the convex hull of the Σ_3 -orbit of the pr-vector $(1, 2)$; this is the hexagon and its interior, and is shaded in the picture below. Outside of the hexagon live only pickets and bipickets (the 17 boundary pickets, as well as 3 pickets and 9 bipickets with boundary distance 1, their position is marked by two kinds of circles).

The hexagon is the support of 18 indecomposable objects with width 3, as well as of six indecomposable objects with width 4. The six objects with width 4 are supported by the midpoints of the sides of the hexagon, thus also by $\mathbb{D}(6)$ (they will be discussed for example in 11.11). Three of them belong to the principal component $\mathcal{P}(6)$, thus they have rationality index 0; the remaining three have rationality index 1. The position of these 24 indecomposable objects with width 3 and 4 is marked by small bullets (actually, some of these positions support in addition also pickets and bipickets).

Looking at the hexagon, we see nicely the direction of the 12 lines in $\mathbb{L}(6) = \mathbb{P}(6) \cup \mathbb{D}(6) \cup \mathbb{H}(6)$. Namely, as we have mentioned already, the midpoints of the sides of the hexagon support objects in $\mathbb{D}(6)$. The six corners of the hexagon support objects in $\mathbb{P}(6)$, The remaining 12 marks on the hexagon support objects in $\mathbb{H}(6)$.

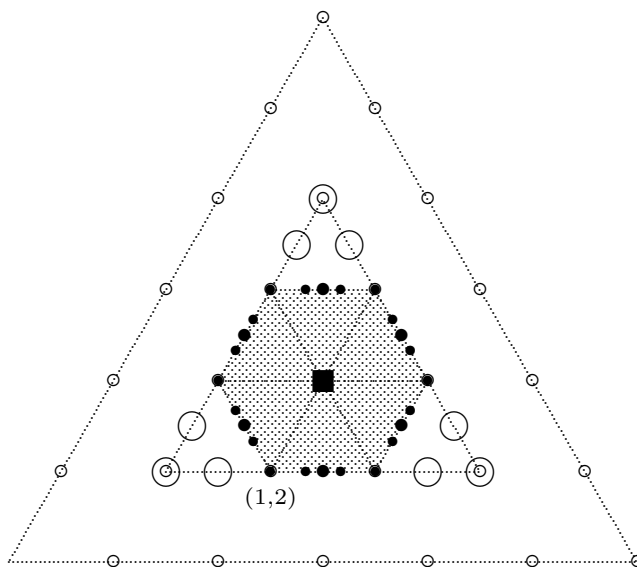

As we have seen, there are just 83 indecomposables which live on or outside of the hexagon. Thus, all the interesting features of $\mathcal{S}(6)$ happen inside the hexagon.

1.9. Optimal results? In no way! Our paper is rather long, together with [RS1] and [RS2] there are well over 200 pages. But the results presented by us are far away from being optimal. For example, when we deal with BTh-vectors, we focus the attention to a typical tame behaviour, in spite of being nearly always in a wild realm.

The reader will notice the great number of open questions which we have selected in Section 16. And many of these questions are really what one may call “Ziegler questions”: questions, which are completely elementary to formulate, which are easy to grasp even by a first year undergraduate student, but which seem to be quite difficult to solve. In our opinion, it is important to mention such problems to students in order to make them aware of the complexity of mathematics, but also to advertise possible research topics.

1.10. The general context. Let us add some remarks regarding the context of the present paper.

The Birkhoff problem. The Birkhoff problem concerns subgroups of finite abelian groups: to describe the possible embeddings, up to automorphisms of the global group. It is easy to see that one may restrict to deal with subgroups of finite abelian p -groups, thus with submodules of \mathbb{Z}/p^n -modules for some n . Clearly, there is no problem to describe the isomorphism classes of the subgroups of a given finite abelian group G , but it turns out to be difficult to describe the possible embeddings, or better the equivalence classes of embeddings, where two embeddings are considered as *equivalent* if they are obtained from each other by an automorphism of G .

Slightly more generally, one may pose the same problem for Λ -modules, where Λ is an arbitrary (commutative local) uniserial ring. It is an open problem whether the Birkhoff problem for uniserial rings in general has different answers for different uniserial rings of

the same length $n \geq 4$ (the cases $n \leq 3$ have been settled in the new preprint [GKKP]; for a general survey, see [S3]). For an old discussion of the relationship between \mathbb{Z}/p^n and $k[T]/\langle T^n \rangle$ we may refer to Kaplansky [Kap] who was eager to stress the similarity between abelian group theory and the theory of linear transformations.

The case of $\Lambda = k[T]/\langle T^n \rangle$ is easier to attack, since one may use covering theory. Thus our previous papers, as well as the present one, are devoted to submodules of Λ -modules, where $\Lambda = k[T]/\langle T^n \rangle$, and we hope that any result concerning the Birkhoff problem for $\Lambda = k[T]/\langle T^n \rangle$ may help to understand the Birkhoff problem for a general uniserial ring Λ , and thus for $\Lambda = \mathbb{Z}/p^n$.

We also should mention two recent preprints which are devoted to the Birkhoff problem and its generalizations. First of all, there is the report [Kva] by Kvamme which presents a comprehensive survey on general monomorphism categories. In particular, it also outlines the relationship between submodule categories and p -valued abelian groups. Second, the paper [KSS] by Kosakowska, Schmidmeier, and Schreiner shows that a pair (U, V) of a finite abelian p -group V and a subgroup U of V such that p annihilates V/U is a direct sum of pickets.

Gorenstein-projective modules. If Λ is a uniserial ring, the ring $T_2(\Lambda)$ is a Gorenstein ring of dimension 1, thus a $T_2(\Lambda)$ -module M is Gorenstein-projective if and only if M is torsionless (i.e. isomorphic to a submodule of a projective $T_2(\Lambda)$ -module). In particular, the category $\mathcal{S}(n)$ is the category of Gorenstein-projective $T_2(\Lambda)$ -modules, where $\Lambda = k[T]/\langle T^n \rangle$. Note that the category of $T_2(\Lambda)$ -modules is just the category of homomorphisms of Λ -modules (thus of homomorphisms between linear operators), and the Gorenstein-projective $T_2(\Lambda)$ -modules are just the embeddings of Λ -modules: we may say the embeddings of linear operators.

Operator theory. The emphasis that $\mathcal{S}(n)$ is a nice subcategory of $\text{mod } T_2(\Lambda(n))$, namely the category of Gorenstein-projective modules, could hide the fact that all the results presented here concern properties of the category $\mathcal{N}(n) = \text{mod } \Lambda(n)$ itself, thus properties of the category of nilpotent operators with a bound on the nilpotence index. To deal with the category $\mathcal{N}(n)$ seems, on a first look, quite easy, since certainly all the objects, the indecomposables, but also the decomposable ones, are easy to describe. However, as soon as one asks for a description of the maps, one encounters severe difficulties. This is the message of Birkhoff, when he posed the problem of describing possible embeddings, and our aim is to follow his challenge. Since all the maps are concatenations of monomorphisms and epimorphisms, any information about the possible embeddings helps to understand the category $\mathcal{N}(n)$.

The relevance of a description of $\mathcal{S}(n)$ for an understanding of the category $\mathcal{N}(n)$ can be seen also in a different way, by stressing the relationship between $\mathcal{S}(n)$ and the stable module category $\underline{\text{mod}}\Lambda(n)$ (which should be seen as a triangulated category). Namely, any morphism \bar{g} in $\underline{\text{mod}}\Lambda(n)$ can be represented by a monomorphism in $\text{mod } \Lambda(n)$, thus by an object in $\mathcal{S}(n)$, namely by $\text{Mimo } g$, see [RS2].

The study of invariant subspaces is, of course, part of operator theory. Here: dealing with a nilpotent operator. If one deals with a single operator, it is usually not helpful to invoke the assumption that the operator is indecomposable: the decomposable ones are those of interest. Given such an operator, say (V, T) , one of the first question concerns

the non-zero elements of $x \in V$: how are they embedded into V , taking into account the action of T . But this means that one studies the pair $(U, V) \in \mathcal{S}$, where U is the cyclic $k[T]$ -subspace generated by x . The corresponding results of Prüfer [P] and Kaplansky [Kap] will be recovered in our Section 13.2.

A basic problem in linear algebra. To deal with invariant subspaces of nilpotent operators should be seen as a basic problem in linear algebra. Any introductory course in linear algebra introduces both subspaces and linear transformations, and to look at a combined system (just one subspace, just one transformation T , even with the additional condition on T to be nilpotent) should be seen as a very natural object to study. Lecturers in linear algebra often pretend that elementary linear algebra is a subject which is sealed — but actually, it should be stressed that it is and will be open-ended. A typical result which usually is presented is the dimension formula for pairs of subspaces of a vector space. However the corresponding description of a vector space with three given subspaces (presented by Dedekind in 1900) is rarely discussed, the situation of four subspaces (considered in 1967 by Nazarova and in 1970 by Gelfand and Ponomarev) presumably never.

The present paper. Let us compare the present investigation with our previous paper [RS1]. In [RS1] we focussed the attention to the invariants u and w (actually, to u and $v = u + w$), now, as we have mentioned, we stress the additional relevance of b . The paper [RS1] was based on the fact that for X indecomposable in $\mathcal{S}(6)$, the numbers uX and wX are roughly the same (the difference is bounded by 6). The present paper started with the observation that for $\mathcal{S}(6)$ the numbers uX and $2 \cdot bX$ are roughly the same (the difference is bounded by 4), thus uX is roughly equal to $\frac{2}{3} \cdot bX$. This is a general feature, for all n : the numbers uX and wX are roughly equal to one third of $n \cdot bX$. Note that $n \cdot bX$ is the length of the projective cover PV of the global space of V . Whereas in [RS1] we looked at the global space V of an object X as being an extension of the **two** vector spaces UX and WX , we now fix the attention to the projective cover PV of the global space V of X as a Λ -module, and its filtration with the **three** factors ΩV , UX , WX . The position of **pr** X in $\mathbb{T}(n)$ using triangular coordinates is given by the dimension of these three vector spaces and τ^2 provides a cyclic rotation of these numbers. In this way, we see clearly the relevance of the pr-triangle with center of gravity $z(n) = (\frac{n}{3}, \frac{n}{3})$: the rotation ρ of the triangle $\mathbb{T}(n)$ is realized (for all reduced objects) by the functor τ^2 .

1.11. Outline of the paper.

Some further definitions and basic concepts will be mentioned in Section 2. Our investigation starts in Section 3, where we look at the Auslander-Reiten translation τ . In particular, we show Theorem 3 which asserts that τ^2 induces the rotation of $\mathbb{T}(n)$ by 120° . This result will be used frequently.

Section 4 is devoted to the proof of Theorem 1, Section 5 to the proof of Theorem 2. Both Sections 4 and 5 deal with suitable filtrations of objects in \mathcal{S} . Such filtrations may be of further interest. Let us draw the attention to the additional **Theorem 9** at the end of Section 5.

Sections 6, 7 and 8 are devoted to provide BTh-vectors. Section 6 deals with pr-vectors with boundary distance at least 2 and presents a proof of Theorem 4. Note that in 16.5, we formulate a guess about the shape of the region of all BTh-vectors. It is a guess, not a

conjecture: After all, whereas we know some methods for showing that a given pr-vector is a BTh-vector, at present no effective way seems to be available to decide that a given pr-vector is not a BTh-vector. Sections 7 and 8 deal with pr-vectors with boundary distance smaller than 2. In particular, in Section 7 we draw the attention to pr-vectors with $p = 1$, thus to the indecomposable objects X in \mathcal{S} with $uX = bX$. We have to admit that we were surprised when we realized that already this subcategory is wild! In view of our interest in BTh-vectors, we are going to show that for $n \geq 9$, the pr-vector $(1, 4)$ is a BTh-vector: there is an infinite family of indecomposable objects X with $uX = bX = 6$ and $wX = 24$. In Section 8.5 one finds the additional **Theorem 10** which provides for $n \geq 10$ many BTh-vectors with boundary distance between 1 and 2.

Sections 9 to 11 are devoted to the half-line and the triangle support. We show Theorems 5, 6, 7 and 8. Section 9 and 10 deal with properties of $\mathcal{S}(n)$, where $n \geq 6$ is not further specified. Section 9 provides the proof of Theorem 5. The discussion of Auslander-Reiten components will be found in Section 10. Special assertions which are valid only in the case $n = 6$ are discussed in Section 11. These considerations have to be seen as an expansion of those presented in [RS1], where we have discussed relations between uX and wX , now it is the triple uX, wX, bX which we study. In particular, Theorem 7 shows that for an indecomposable object X in $\mathcal{S}(6)$, we have $|uX - 2bX| \leq 4$, and $|vX - 4bX| \leq 4$. This is the basis for the proof of Theorem 8. In particular, in this way, we show that for $n = 6$, the pr-vector $(2, 2)$ is the only BTh-vector.

The remaining sections are devoted, on the one hand, to special objects, or, on the other hand, to the weird (but actually prevalent) non-gradable objects. Some non-gradable objects are discussed in Section 14.

Section 12 deals with pickets and bipickets. Section 13 devotes a lot of attention to the objects $X = (U, V)$ in \mathcal{S} with $bU = 1$; here we can follow and extend previous investigations by Prüfer and Kaplansky.

Section 15 will be a sort of gallery: here, a lot of further examples are exhibited in order to draw the attention to special features of the categories $\mathcal{S}(n)$. In Section 16 we draw the attention to open questions. Indeed, dealing with invariant subspaces, there are presently more questions than results! We add some general comments in Section 17.

Appendix A by Schmidmeier lists the positive roots of the Dynkin diagram \mathbf{E}_8 with some additional combinatorial data used in the paper. In Appendix B, Schmidmeier presents the remaining tripickets in $\mathcal{S}(6)$ as well as some tetrapickets and some pentapickets. In Appendix C, Schmidmeier describes briefly some applications of invariant subspaces. Appendix D by Ringel is a slightly revised reprint from the Izmir lectures containing a report (with full proof) on the covering theorem.

Most parts of the paper are self-contained. We will use two standard techniques from representation theory: coverings and simplification. Both methods are explained in Section 2. We will use frequently the one-parameter family of indecomposable objects $X = (U, V)$ in $\mathcal{S}(6)$ where $V = [6, 4, 2]$. In addition, another one-parameter family of indecomposable objects $X = (U, V)$ will play a role: it belongs to $\mathcal{S}(7)$ and U has height 3; it was exhibited by Schmidmeier in [S1], see Section 8.2 below.

According to [AS], the category $\mathcal{S}(n)$ has Auslander-Reiten sequences. The Auslander-Reiten translation $\tau = \tau_n$ was explicitly described in [RS2], see Section 3 below. In particular, it has been shown in [RS2] that τ_n has period 6, thus stable (Auslander-Reiten)

components are tubes of rank 1, 2, 3 or 6.

The case $n = 6$ is of special interest. We will use the classification of the indecomposable objects of $\mathcal{S}(6)$ as obtained in [RS1] with the help of a tubular algebra, see the beginning of Section 11.

We include various remarks throughout the paper. These remarks may be skipped at a first reading, but we hope that they are helpful for a better understanding of the setting.

2. Preliminaries.

We are going to provide some further definitions which we will need. In 2.2, we recall from [RS1] in which way we try to visualize at least some of the objects of \mathcal{S} . Then, we report about methods which have been developed quite a long time ago and which will be used throughout the paper.

2.1. Some further definitions which are needed.

Given an object V in $\mathcal{N}(n)$, let PV a projective cover of V and ΩV the (first) syzygy module of V (the kernel of an epimorphism $PV \rightarrow V$). For $1 \leq m \leq n - 1$, we have $\Omega[m] = [n - m]$ (and, of course, $\Omega[n] = 0$). For any V in \mathcal{N} , we have $|\Omega V| = n \cdot bV - |V|$.

In dealing with objects $X = (U, V)$ in $\mathcal{S}(n)$, it seems appropriate to introduce the partition triple **par** X as

$$\mathbf{par} X = ([U], [V], [V/U])$$

(recall that for $V \in \mathcal{N}(n)$, we denote by $[V]$ its isomorphism class, or, equivalently, the corresponding partition). Thus, **par** X is a triple of partitions. By abuse of notation, we may write $X = (U, V, V/U)$ in case **par** $X = ([U], [V], [V/U])$. Thus, if an object X of $\mathcal{S}(n)$ is presented by a triple, then actually only its partition vector is given (and there may be several different isomorphism classes of objects X with these data).

As we have mentioned, if X is an object in $\mathcal{S}(n)$, the triple (uX, wX, bX) is called the *uwb*-vector of X . Actually, since we usually are interested in the corresponding *pr*-vector $(uX/bX, wX/bX)$ (provided X is non-zero), we sometimes will write the triple (uX, wX, bX) in the form $\frac{u|w}{b}X = \frac{uX|wX}{bX}$. Note that this stresses our intention to consider $\mathbb{T}(n)$ as the projective space for the vector space \mathbb{R}^3 (with coordinates in the form $\frac{u|w}{b}$).

2.2. Visualization of objects in \mathcal{S} . Let $X = (U, V)$ in \mathcal{S} . The isomorphism class $[V]$ of V can be identified with a partition $\lambda = (\lambda_1, \dots, \lambda_b)$ say with b parts. We visualize such a partition by using boxes. Considering the part with index i , there are λ_i boxes, and we arrange these boxes vertically (and not, as it is quite common, horizontally): this corresponds to the concept of a composition series: the top factor should appear at the top, the socle factor at the bottom. In this way, we obtain for any part a vertical strip of boxes. These strips are arranged from left to right, but not necessarily in the decreasing sequence stressed by the partition. Let us repeat: the vertical collection of boxes show the parts of the partition λ , (thus they show $[V]$), but the parts are arranged in a suitable order. The various parts are usually vertically adjusted in order to accommodate generators of a subspace, as described below.

We may consider the boxes as providing a basis of V . Namely, there is a generating set v_1, \dots, v_b of V with $T^{\lambda_i} v_i = 0$, for $1 \leq i \leq b$. A vertical collection of boxes corresponds to such a generator v_i , and the boxes, going from the top down, to the elements $v_i, T v_i, T^2 v_i, \dots, T^{\lambda_i-1} v_i$. An element u of V is a linear combination of the elements $T^j v_i$. Of particular interest will be the elements of V which are sums of elements of the box basis, that is sums of some of the elements $T^j v_i$. We will mark the elements $T^j v_i$ by inserting a bullet into the box and connecting the bullets by a black curve $c(u)$. (Actually, we will mostly deal with gradable objects where we are able to obtain horizontal lines; here the vertical adjustments come into play. For examples of non-gradable objects see Section 14.)

Now, we look at the the subspace U . If there exists a generating set of U where all the elements u of this set are sums of elements of the box basis, then we obtain a clear visualization using the boxes which describe V and the bullet-lines which describe the generating set of U .

Here is an example (U, V) . We start with $[V] = [6, 6, 3]$; there is a corresponding generating set v_1, v_2, v_3 with $T^6 v_1 = T^3 v_2 = T^6 v_3 = 0$; and we consider the submodule U of V generated by $T^4 v_1 + T^2 v_2$ and $T v_2 + T^2 v_3$.

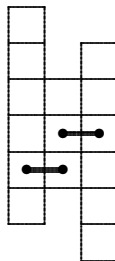

The general situation (where U is not generated by sums of elements of the box basis) cannot be handled so easily. In some situations, we may be able to use parameters which we inscribe into the boxes in order to provide a description of U , see the examples in Sections 6, 7, 8. The reader should be aware that in general, there does not seem to exist a satisfying strategy.

2.3. Covering theory (A report).

We have introduced objects in the category $\mathcal{S}(n)$ as pairs (U, V) where V is a nilpotent linear operator of nilpotency index at most n and where U is an invariant subspace, hence they can be characterized as representations of the following quiver Q subject to the commutativity relation $\beta\alpha' = \alpha\beta$, the nilpotency relations $\alpha^n = 0 = (\alpha')^n$ and the condition that β is a monomorphism.

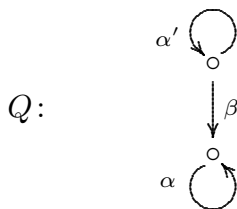

The category $\tilde{\mathcal{S}}(n)$ consists of representations of the universal covering of the quiver Q which is the following locally finite quiver \tilde{Q} subject to commutativity relations $\beta_{i-1}\alpha'_i = \alpha_i\beta_i$, nilpotency relations $\alpha_i \cdots \alpha_{i+n-1} = 0 = \alpha'_i \cdots \alpha'_{i+n-1}$ and the condition that the vertical maps β_i are monomorphisms.

$$\tilde{Q} : \begin{array}{ccccccc} \cdots & \longleftarrow & \overset{1'}{\circ} & \xleftarrow{\alpha'_2} & \overset{2'}{\circ} & \xleftarrow{\alpha'_3} & \overset{3'}{\circ} & \longleftarrow & \cdots \\ & & \downarrow \beta_1 & & \downarrow \beta_2 & & \downarrow \beta_3 & & \\ \cdots & \longleftarrow & \underset{1}{\circ} & \xleftarrow{\alpha_2} & \underset{2}{\circ} & \xleftarrow{\alpha_3} & \underset{3}{\circ} & \longleftarrow & \cdots \end{array}$$

The categories $\tilde{\mathcal{S}}(n)$ and $\mathcal{S}(n)$ are related via the *covering functor* or *push-down functor* π_λ , it maps a representation $M = ((M_x)_{x \in \tilde{Q}_0}, (M_\gamma)_{\gamma \in \tilde{Q}_1})$ to the pair $\pi_\lambda M = (U, V)$ with $U = \bigoplus_{i \in \mathbb{Z}} M_{i'}$, $V = \bigoplus_{i \in \mathbb{Z}} M_i$ where the embedding is given by the diagonal map $\bigoplus_{i \in \mathbb{Z}} \beta_i$ and the action of T on V is given by the maps α_i . The group $G = \mathbb{Z}$ acts on the quiver \tilde{Q} and on representations of \tilde{Q} as index shift (so $Q = \tilde{Q}/G$). Note that the quiver \tilde{Q} is locally finite and the group $G = \mathbb{Z}$ is torsionfree and acts freely on \tilde{Q}_0 .

The union of the categories $\tilde{\mathcal{S}}(n)$ with $n \in \mathbb{N}$ will be denoted by $\tilde{\mathcal{S}}$. If M belongs to $\tilde{\mathcal{S}}(n)$, we call $\frac{u|w}{b}M = \frac{u|w}{b}\pi_\lambda M$ the *uw**b**-vector*, and $\mathbf{pr} M = \mathbf{pr} \pi_\lambda M$ the *pr-vector* of M .

Covering Theorem (Gabriel, Dowbor–Skowroński). *Let \tilde{Q} be a locally finite quiver and G a torsionfree group of automorphisms of \tilde{Q} which acts freely on \tilde{Q}_0 . Let $Q = \tilde{Q}/G$. The covering functor π_λ provides an injective map from the set of G -orbits of isomorphism classes of indecomposable $k\tilde{Q}$ -modules to the set of isomorphism classes of indecomposable kQ -modules. \square*

In general, the injective map induced by π_λ on the set of indecomposable modules is not surjective. But we do get a bijection if the category of $k\tilde{Q}$ -modules is locally support finite, see [DLS]). Regarding invariant subspaces for $n \leq 6$, we deal with the subcategory $\tilde{\mathcal{S}}(n)$ of $\text{mod } k\tilde{Q}$ which is locally support finite, and it similarly follows that the restriction of π_λ to $\tilde{\mathcal{S}}(n)$ induces a bijection between the G -orbits of isomorphism classes of indecomposable objects in $\tilde{\mathcal{S}}(n)$ and the isomorphism classes of indecomposables in $\mathcal{S}(n)$ [RS1, (2.1) and (2.2)].

An object in $\mathcal{S}(n)$ is said to be *gradable* provided it is in the image of the push-down functor π_λ . All pickets are, of course, gradable, as are all bipickets, see 12.2. As we have mentioned, all objects in $\mathcal{S}(n)$ for $n \leq 6$ are gradable. This is no longer true for $n = 7$, for a typical example of a non-gradable object in $\mathcal{S}(7)$ as well as further remarks on non-gradable objects in $\mathcal{S}(n)$, we refer to Section 14. Note that all the objects of $\mathcal{S}(n)$ considered in the remaining parts of the paper are gradable.

Remark. Covering theory has been developed by Gabriel, Bongartz and Riedtmann, and in parallel by Gordan and Green, dealing with group-graded algebras and the corresponding graded modules. The formulation of the covering theorem is quoted from [R3, reprinted here, slightly revised, as Appendix D] where a short proof is given. Note that there is no assumption on the base field.

For the purpose of exhibiting special objects, we usually restrict the domain of π_λ : For $\ell \leq m \in \mathbb{Z}$, we denote by $Q[\ell, m]$ the following fully commutative quiver with $2(m - \ell + 1)$ vertices,

$$Q[\ell, m] : \begin{array}{ccccccc} \ell' & (\ell+1)' & (\ell+2)' & \dots & (m-1)' & m' & \\ \circ & \leftarrow \circ & \leftarrow \circ & \leftarrow \dots & \leftarrow \circ & \leftarrow \circ & \\ \downarrow & \downarrow & \downarrow & & \downarrow & \downarrow & \\ \circ & \leftarrow \circ & \leftarrow \circ & \leftarrow \dots & \leftarrow \circ & \leftarrow \circ & \\ \ell & \ell+1 & \ell+2 & & m-1 & m & \end{array}$$

and denote by $A = A(\ell, m)$ the factor of its path algebra modulo all the commutativity relations.

Similarly, we write $\mathcal{S}[\ell, m]$ for the category of all representations of \tilde{Q} with all maps β_i (with $\ell \leq i \leq m$) being monomorphisms.

- For $\ell < m$, the algebra A has global dimension 2.
- For tuples $x = (x_i)_{i \in Q_0}$, $y = (y_i)_{i \in Q_0}$ the homological bilinear form for A is given by

$$\langle x, y \rangle = \sum_{i \in Q_0} x_i y_i - \sum_{(\alpha: i \rightarrow j) \in Q_1} x_i y_j + \sum_{i=\ell+1}^m x_i y_{i-1}.$$

- The objects in $\mathcal{S}[\ell, m]$ have projective dimension at most one in mod A . Namely, the simple A -modules $S(i)$ as well as the non-split extensions of $S(i')$ by $S(i)$ (where $\ell \leq i \leq m$), have this property, and any object in $\mathcal{S}[\ell, m]$ has a filtration with such factors.
- For objects $X, Y \in \mathcal{S}[\ell, m]$, the bilinear form satisfies [R2, 2.4 Lemma]

$$\langle \mathbf{dim} X, \mathbf{dim} Y \rangle = \dim \mathrm{Hom}_A(X, Y) - \dim \mathrm{Ext}_A^1(X, Y).$$

Let X be an indecomposable gradable object. The *standard grading* is the grading such that there do exist non-zero elements of degree 1 and such that all non-zero elements have positive degree.

2.4. The d -Kronecker algebras $K(d)$ (A report)

We denote by $K(d)$ the d -Kronecker algebra with coefficients in k and d arrows (it is the path algebra of the quiver with 2 vertices, say labeled 1 and 2, and d arrows $1 \leftarrow 2$). The *Kronecker algebra* is the 2-Kronecker algebra.

There are two simple $K(d)$ -modules, $S(1)$ and $S(2)$, corresponding to the vertices of $K(d)$. The module $S(1)$ is projective, the module $S(2)$ is injective. For $d = 0$, the algebra $K(0)$ is semisimple, the modules $S(1)$ and $S(2)$ are the only indecomposable modules. For $d = 1$, there is a unique indecomposable module which is not simple, say I , with a non-split exact sequence $0 \rightarrow S(1) \rightarrow I \rightarrow S(2) \rightarrow 0$.

For $d \geq 2$, the algebra $K(d)$ is representation infinite, with a preprojective component (containing $S(1)$), a preinjective component (containing $S(2)$), as well as with infinitely many stable Auslander-Reiten components. The $K(d)$ -modules without a non-zero direct summand which is preprojective or preinjective are said to be *regular*.

The case $d = 2$ is of special interest. In this case, the full subcategory \mathcal{R} of regular modules is an exact abelian subcategory. The simple objects in \mathcal{R} are said to be *quasi-simple* in $\text{mod } K(2)$. Any indecomposable object in \mathcal{R} has a unique composition series in \mathcal{R} , say of length ℓ , called its *quasi-length* and its composition factors in \mathcal{R} are isomorphic, say isomorphic to R : in this case we will denote the object by $R[\ell]$. In this way we obtain a bijection between the (isomorphism classes of the) indecomposable objects in \mathcal{R} and the set of pairs (R, ℓ) , where R is (the isomorphism class of) a simple object in \mathcal{R} and $\ell \in \mathbb{N}_1$. For any simple object R in \mathcal{R} , the objects of the form $R[\ell]$ with $\ell \in \mathbb{N}_1$ form an Auslander-Reiten component in $\text{mod } K(2)$ and this component is a stable tube of rank 1.

Recall that we denote by \mathbb{P}^1 the projective line over k ; its elements are written in the form $c = (c_0 : c_1) = k(c_0, c_1)$, where (c_0, c_1) is a non-zero element of k^2 . Any element c of \mathbb{P}^1 gives rise to an indecomposable representation $R_c = (k \xleftarrow{c_0} c_1 k)$ of length 2 in $\text{mod } K(2)$ (and any indecomposable representation of $K(2)$ of length 2 is obtained in this way). The representation R_c is a simple object in \mathcal{R} . The further simple objects of \mathcal{R} are related to finite field extensions of k ; in particular, *all simple objects of \mathcal{R} have length 2 in $\text{mod } K(2)$ if and only if k is algebraically closed*. In order to avoid field extensions, we usually will restrict to look at the representations R_c , instead of taking all simple objects in \mathcal{R} into account. In this way, we focus the attention to the \mathbb{P}^1 -family R_c , and, more generally, to the corresponding \mathbb{P}^1 -families $R_c[\ell]$, with fixed $\ell \in \mathbb{N}_1$.

2.5. Simplification (A report).

For the construction of modules in $\tilde{\mathcal{S}}$, we often will use simplification. The following result is a special case of [R1, (1.5) Lemma]. Given a finite dimensional k -algebra A , we say that the A -modules X, Y are an *orthogonal pair* provided $\text{End } X = \text{End } Y = k$, $\text{Hom}(X, Y) = \text{Hom}(Y, X) = 0$. Let d be a natural number. A *d -Kronecker pair* X, Y is an (ordered) orthogonal pair such that $\dim_k \text{Ext}^1(X, Y) = d$.

Simplification Lemma. *Let A be a k -algebra. Let X, Y be a d -Kronecker pair in $\text{mod } A$. The full subcategory of all objects Z with a subobject Z' isomorphic to a direct sum of copies of Y such that Z/Z' is isomorphic to a direct sum of copies of X , is equivalent to the category of $K(d)$ -modules.*

We may reformulate the Lemma as follows: Let A be a k -algebra and assume that X, Y is a d -Kronecker pair. Then there is a full exact embedding

$$F_{X,Y} : \text{mod } K(d) \rightarrow \text{mod } A$$

such that $F_{X,Y}(S(2)) = X$ and $F_{X,Y}(S(1)) = Y$.

The image of the functor $F_{X,Y}$ is the full subcategory of $\text{mod } A$ consisting of all modules which have a submodule which is the direct sum of copies of Y such that the corresponding factor module is the direct sum of copies of X .

2.6. Kronecker subcategories. Kronecker families. BTh-vectors.

An exact subcategory \mathcal{K} of $\text{mod } \tilde{Q}$ will be called a *Kronecker subcategory* provided \mathcal{K} is equivalent (as an exact subcategory) to $\text{mod } K(2)$. Of course, this means that there are

given two orthogonal objects X, Y in \mathcal{K} (namely the simple objects of \mathcal{K}) with $\text{End}(X) = \text{End}(Y) = k$, and an indecomposable object Z with a short exact sequence $0 \rightarrow Y^2 \rightarrow Z \rightarrow X \rightarrow 0$ (the projective cover of X inside \mathcal{K}).

If \mathcal{K} is a Kronecker subcategory of $\tilde{\mathcal{S}}$, the set of indecomposable objects in \mathcal{K} which have length 2 in \mathcal{K} , will be called a *Kronecker family* in $\tilde{\mathcal{S}}$. Note that a Kronecker family is a \mathbb{P}^1 -family of indecomposable and pairwise non-isomorphic objects M_c in $\tilde{\mathcal{S}}$, with $c = (c_0 : c_1) \in \mathbb{P}^1$. For any $\ell \in \mathbb{N}_1$, there exists the object $M_c[\ell]$ in \mathcal{K} (it has a filtration with ℓ factors M_c), and the set of objects $M_c[\ell]$ with $c = (c_0 : c_1) \in \mathbb{P}^1$ is a \mathbb{P}^1 -family of indecomposable and pairwise non-isomorphic objects in $\tilde{\mathcal{S}}$.

Warning: The notation may be misleading. The construction of the object $M_c[\ell]$ uses not only M_c , but actually the choice of X and Y , thus the subcategory \mathcal{K} . As we will see, an object of a Kronecker family in $\tilde{\mathcal{S}}$ may belong to several different Kronecker subcategories (see Remark 2 below). But we hope the reader is not irritated in this way.

2.7. Example: The standard family in $\mathcal{S}(6)$.

We present here in detail a construction for a BTh-vector which will be used repeatedly in this manuscript. This BTh-family in $\mathcal{S}(6)$ was presented in [RS1, (2.3)], but actually has already been observed by Birkhoff [Bh].

Given the picket $X = ([4], [6])$ and the bipicket $Y = ([2], [4, 2], [3, 1])$, consider the indecomposable representations for $Q[1, 6]$ of dimension type $\mathbf{dim} \tilde{X} = \begin{smallmatrix} 111100 \\ 111111 \end{smallmatrix}$ and $\mathbf{dim} \tilde{Y} = \begin{smallmatrix} 011000 \\ 012210 \end{smallmatrix}$. Clearly, \tilde{X} and \tilde{Y} is an orthogonal pair in $\text{mod } A(1, 6)$ and $X = \pi_\lambda \tilde{X}$, $Y = \pi_\lambda \tilde{Y}$.

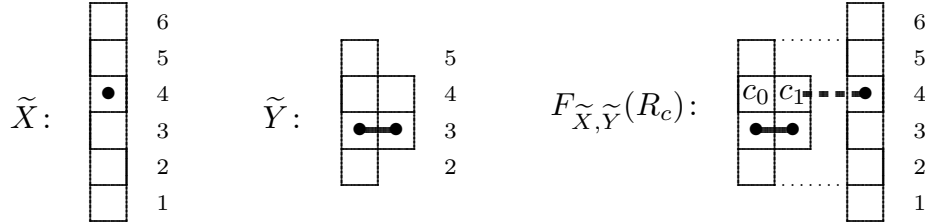

Using the formulas from (2.3), we verify that $\langle \mathbf{dim} \tilde{X}, \mathbf{dim} \tilde{Y} \rangle = -2$, hence $\dim \text{Ext}^1(\tilde{X}, \tilde{Y}) = 2$ and the embedding $F_{\tilde{X}, \tilde{Y}}: \text{mod } K(2) \rightarrow \text{mod } A(1, 6)$ yields a BTh-family in $\tilde{\mathcal{S}}(6)$ with uwb -vector $\frac{6|6}{3}$ and, via the covering functor, in $\mathcal{S}(6)$. For $c = (c_0 : c_1) \in \mathbb{P}^1(k)$, the objects $F_{\tilde{X}, \tilde{Y}}(R_c)$ are sketched above. Note that $\mathbf{uwb} X = \frac{4|2}{1}$ and $\mathbf{uwb} Y = \frac{2|4}{2}$:

We describe the functor $F_{\tilde{X}, \tilde{Y}}$ in detail. Let $J = (J_1 \xleftarrow[\eta]{\zeta} J_2)$ be a representation for the Kronecker algebra $K(2)$. The corresponding representation of the quiver $Q[1, 6]$ is as follows.

$$\begin{array}{ccccccc}
 J_2 & \xleftarrow{\pi} & J_1 \oplus J_2 & \xlongequal{\quad} & J_1 \oplus J_2 & \xleftarrow{\iota} & J_2 & \xleftarrow{\quad} & 0 & \xleftarrow{\quad} & 0 \\
 \parallel & & \parallel & & \downarrow \begin{bmatrix} 1 & \zeta \\ 1 & \eta \\ 0 & 1 \end{bmatrix} & & \downarrow \begin{bmatrix} \zeta \\ \eta \\ 1 \end{bmatrix} & & \downarrow & & \downarrow \\
 J_2 & \xleftarrow{\pi} & J_1 \oplus J_2 & \xleftarrow{\pi} & J_1^2 \oplus J_2 & \xlongequal{\quad} & J_1^2 \oplus J_2 & \xleftarrow{\iota} & J_1 \oplus J_2 & \xleftarrow{\iota} & J_2
 \end{array}$$

By ι and π we denote the canonical inclusion into the last component(s) and the canonical projection modulo the first component.

Lemma.

- (a) The functor $F_{\tilde{X}, \tilde{Y}}$ is a full and exact embedding.
- (b) For $J \in \text{mod } K(2)$ of dimension vector (j_1, j_2) , the corresponding object $F_{\tilde{X}, \tilde{Y}} J$ in $\tilde{\mathcal{S}}(6)$ has *uwb-vector* $\frac{2j_1+4j_2 \mid 4j_1+2j_2}{2j_1+j_2}$.
- (c) The images of the modules in homogeneous tubes in $\text{mod } K(2)$ under $F_{\tilde{X}, \tilde{Y}}$ provide a *BTh-family* in $\tilde{\mathcal{S}}(6)$ with *pr-vector* $(2, 2)$.

□

Under $F_{\tilde{X}, \tilde{Y}}$, the maps in $\text{mod } K(2)$ give rise to maps between the corresponding objects in $\tilde{\mathcal{S}}(6)$.

Remark 1 (A correction to [RS1]). Let \mathcal{K} be the image of the functor $F_{\tilde{X}, \tilde{Y}}$. This is a Kronecker category of $\tilde{\mathcal{S}}(6)$, thus equivalent to $\text{mod } K(2)$. In particular, \mathcal{K} has relative Auslander-Reiten sequences. Let $c = (c_0 : c_1) \in \mathbb{P}^1(k)$. The Auslander-Reiten component of $F_{\tilde{X}, \tilde{Y}}(R_c)$ in \mathcal{K} is a stable tube of rank 1.

We are going to present explicitly the first three objects in this tube, with the (relative) irreducible maps between them (of course, these maps are not necessarily irreducible morphisms in $\tilde{\mathcal{S}}(6)$).

First, let us consider the case that $c_0 \neq 0$, thus, we can assume that $c_0 = 1$ (and c_1 is an arbitrary element of k).

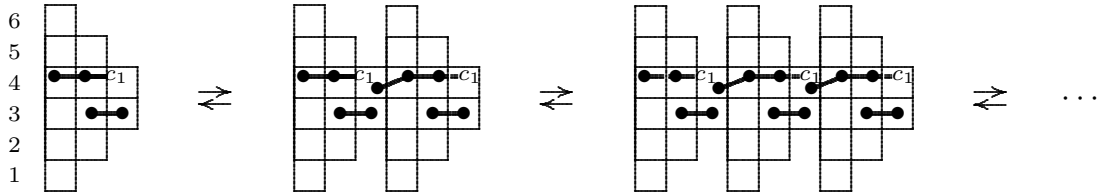

If $c_0 = 0$, then the corresponding first three objects look as follows:

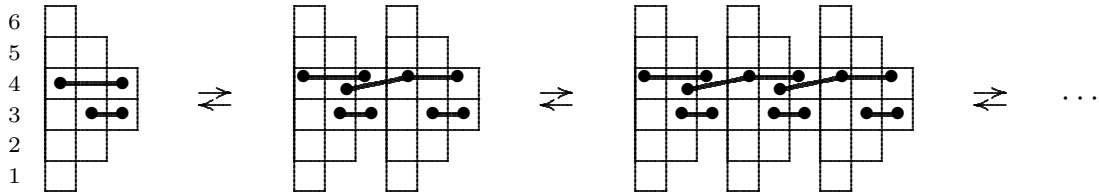

(Note that this corrects the presentation in [RS1] given at the end of Section 2.3.)

We should mention that we deal with indecomposable objects which belong to the tubular family of $\tilde{\mathcal{S}}(6)$ which contains the principal component (the family with rationality index 0). If $c_1 = 0$, the objects occur in the principal component; if $c_0 = 0$, they occur in the 2-tube; for $c_0 = c_1$, they lie in the 3-tube.

Remark 2. A second \mathbb{P}^1 -family in $\mathcal{S}(6)$ with width 3. Let us now start with the Kronecker pair \tilde{X}', \tilde{Y}' with $\pi_\lambda \tilde{X}' = ([2], [2], [0])$ and $\pi_\lambda \tilde{Y}' = ([3, 1], [6, 4], [4, 2])$, and look at the corresponding Kronecker family

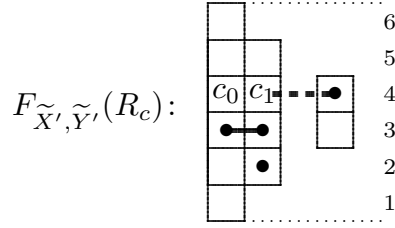

The modules which we obtain and which belong to homogeneous tubes are those of the standard family $F_{\tilde{X}, \tilde{Y}}(R_c)$.

However, let us look at the 3-tube $\tilde{\mathcal{C}}$ with rationality index 0. The module $M = F_{\tilde{X}, \tilde{Y}}(R_{(1,1)})$ does not occur in the image of the functor $F_{\tilde{X}', \tilde{Y}'}$, and, conversely, the module $M' = F_{\tilde{X}', \tilde{Y}'}(R_{(0,1)})$ is not in the image of the functor $F_{\tilde{X}, \tilde{Y}}$.

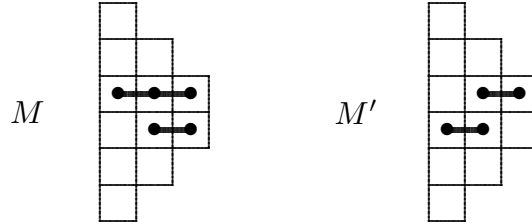

Note that both M and M' belong to $\tilde{\mathcal{C}}$.

Namely, the Auslander-Reiten component of $\tilde{\mathcal{S}}(6)$ which contains M is a stable 3-tube $\tilde{\mathcal{C}}$, the quasi-socle of M in $\tilde{\mathcal{C}}$ maps under the covering functor π to $([3], [6], [3])$. Also M' belongs to this component $\tilde{\mathcal{C}}$, but its quasi-socle in $\tilde{\mathcal{C}}$ maps under π to $([3], [3], [0])$, thus M and M' are not isomorphic (of course, one may also check directly that the modules M and M' are not isomorphic, but belong to the same Auslander-Reiten component $\tilde{\mathcal{C}}$ of $\tilde{\mathcal{S}}(6)$). Let us stress that given a Kronecker subcategory \mathcal{K} of $\tilde{\mathcal{S}}(6)$, the simple regular objects of \mathcal{K} always belong to pairwise different Auslander-Reiten components of $\tilde{\mathcal{S}}(6)$.

2.8. Some \mathbb{P}^1 -families in $\mathcal{S}(6)$ with width 6. Let us end this section with a slightly more complex situation: simplification of a subcategory \mathcal{L} of $\tilde{\mathcal{S}}(6)$ which contains four pairwise orthogonal modules with endomorphism ring k .

We consider the following four pairwise orthogonal modules $\tilde{A}, \tilde{B}, \tilde{B}', \tilde{C}$ in $\tilde{\mathcal{S}}(6)$ with endomorphism ring k :

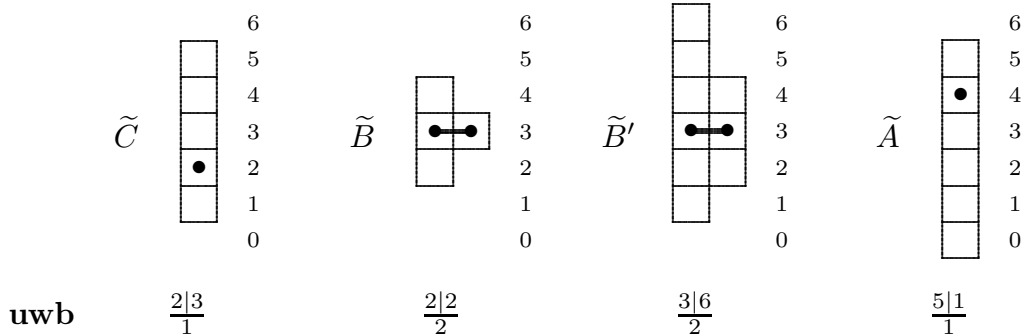

The Ext-quiver looks a follows:

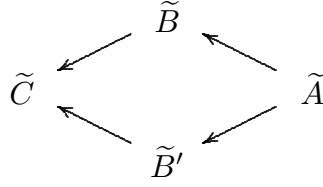

and all extensions are g-split. (All these assertions are easy to verify.) Here are the corresponding non-trivial extensions:

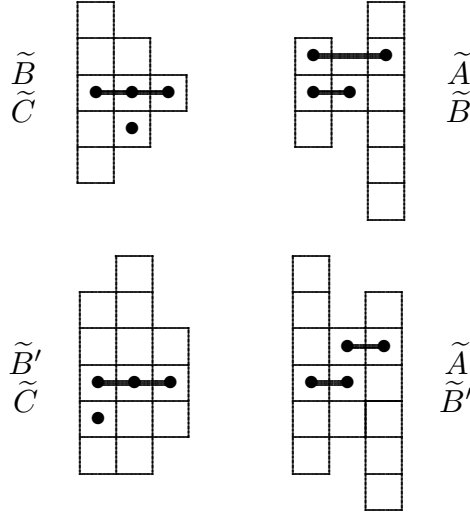

(If X, Y are objects and there there is a unique indecomposable M with a subobject Y such that $M/Y = X$, then we may write $M = \begin{smallmatrix} X \\ Y \end{smallmatrix}$.)

Let \mathcal{L} be the full subcategory of all objects which have a filtration with factors of the form $\tilde{A}, \tilde{B}, \tilde{B}', \tilde{C}$; the Ext-quiver shows that \mathcal{L} is equivalent to an abelian full subcategory of the category of representations of the quiver $\tilde{\mathbf{A}}_{2,2}$. Actually, as we will see, \mathcal{L} is hereditary, thus \mathcal{L} is equivalent to the category of representations of the quiver $\tilde{\mathbf{A}}_{2,2}$.

The object \tilde{B} belongs to the 6-tube \tilde{C} with rationality index 1, as does the indecomposable object \tilde{M} with a filtration with factors (going downwards) $\tilde{A}, \tilde{B}', \tilde{C}$. It is easy to see that \tilde{C} contains infinitely many objects which have a filtration with factors of the form \tilde{B} and \tilde{M} . As a consequence, the category \mathcal{L} has infinitely many isomorphism classes of indecomposable objects. It follows that \mathcal{L} has to be hereditary.

The object \tilde{B}' belongs to the 3-tube with rationality index 1, as does the indecomposable object with a filtration with factors (going downwards) $\tilde{A}, \tilde{B}, \tilde{C}$.

The Ext-quiver shows that there are the following Kronecker pairs (below we note the uwv-vectors):

$$\begin{array}{ccccccc}
 \tilde{B} \oplus \tilde{B}' & \Leftarrow & \tilde{A} & \tilde{B} & \Leftarrow & \tilde{A} & \tilde{B}' & \Leftarrow & \tilde{A} & \tilde{C} & \Leftarrow & \tilde{B} \oplus \tilde{B}' \\
 \tilde{C} & & & \tilde{C} & & \tilde{B}' & \tilde{C} & & \tilde{B} & & & \\
 \text{uwv} & \frac{7|11}{5} & \frac{5|1}{1} & \frac{4|5}{3} & \frac{8|7}{3} & \frac{5|9}{3} & \frac{7|3}{3} & \frac{2|3}{1} & \frac{10|9}{5} & & &
 \end{array}$$

They give rise to four Kronecker subcategories of \mathcal{L} . In this way, we have constructed four \mathbb{P}^1 -families of indecomposable objects with rationality index 1; the objects which we obtain and which belong to homogeneous tubes coincide.

For example, for the second pair $\tilde{X} = \frac{\tilde{A}}{\tilde{B}'}$ and $\tilde{Y} = \frac{\tilde{B}}{\tilde{C}}$, we deal with the following \mathbb{P}^1 -family:

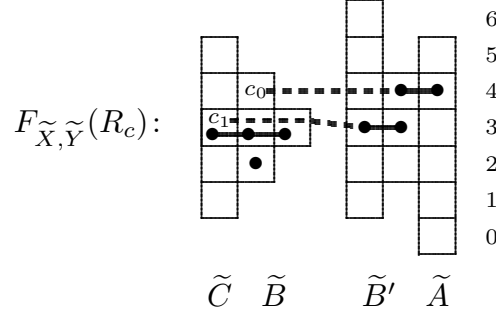

3. The functor τ^2 (and proof of Theorem 3).

In Section 3, we work in $\mathcal{S}(n)$ with n fixed, thus we write $\tau = \tau_n$.

The aim of this section is to show Theorem 3, but also some consequences, and related observations. Theorem 3 will be derived from Theorem 3' which sheds more light on the rotation ρ . Instead of looking at the triangle $\mathbb{T}(n)$ with its rotation ρ , we will consider the following set $\mathbb{E}(n)$.

3.1. The set $\mathbb{E}(n)$. We consider triples $E = ([E_0], [E_1], [E_2])$ of isomorphism classes of modules E_0, E_1, E_2 in $\mathcal{N}(n)$, and write $|E| = |E_0| + |E_1| + |E_2|$.

The set $\mathbb{E}(n)$ consists of the triples $E = ([E_0], [E_1], [E_2])$ of isomorphism classes of modules E_0, E_1, E_2 in $\mathcal{N}(n)$ which satisfy the condition that n divides $|E|$. Instead of $([E_0], [E_1], [E_2])$, we usually will write $E = (E_0 \setminus E_1 \setminus E_2)$; the number $bE = |E|/n$ will be called the *width* of E (by assumption, this is a natural number). Note that *for any n and b , the set of elements E in $\mathbb{E}(n)$ with fixed width b is finite*. Namely, if $E = (E_0 \setminus E_1 \setminus E_2)$ belongs to $\mathbb{E}(n)$ and has width b , then $[E_i]$ is a partition of $|E_i|$, and we have $|E_i| \leq bn$, for $0 \leq i \leq 2$; of course, there are only finitely many partitions of numbers bounded by bn .

Let

$$\rho(E_0 \setminus E_1 \setminus E_2) = (E_1 \setminus E_2 \setminus E_0),$$

also, let

$$\Omega(E_0 \setminus E_1 \setminus E_2) = (\Omega E_0 \setminus \Omega E_1 \setminus \Omega E_2);$$

If $E = (E_0 \setminus E_1 \setminus E_2) \in \mathbb{E}(n)$, then, of course, ρE belongs to $\mathbb{E}(n)$, but also ΩE belongs to $\mathbb{E}(n)$ (namely, for every V in $\mathcal{N}(n)$, the number $|\Omega V| + |V| = |PV|$ is divisible by n , since PV is projective in $\mathcal{N}(n)$).

Always, we have

$$(1) \quad b(\rho E) = bE,$$

(but $b(\Omega E)$ usually is different from bE).

To every object $X = (U, V) = (U, V, W)$ in $\mathcal{S}(n)$, we attach the triple

$$EX = (\Omega V \setminus U \setminus W) \in \mathbb{E}(n);$$

these three modules $\Omega V, U, W$ are just the factors of the filtration

$$0 \subseteq \Omega V \subseteq \tilde{U} \subseteq PV$$

of PV , where \tilde{U} is defined by $\tilde{U}/\Omega V = U \subseteq V = PV/\Omega V$ (the triple EX may be called the *hidden filtration factors* of X).

$$\begin{array}{ccccccc}
& & 0 & & 0 & & \\
& & \downarrow & & \downarrow & & \\
& & \Omega V & \xlongequal{\quad} & \Omega V & & \\
& & \downarrow & & \downarrow & & \\
0 & \longrightarrow & \tilde{U} & \longrightarrow & PV & \longrightarrow & W \longrightarrow 0 \\
& & \downarrow & & \downarrow & & \parallel \\
0 & \longrightarrow & U & \longrightarrow & V & \longrightarrow & W \longrightarrow 0 \\
& & \downarrow & & \downarrow & & \\
& & 0 & & 0 & &
\end{array}$$

This filtration of PV shows that $|EX| = |\Omega V| + |U| + |W| = |PV|$ is divisible by n , therefore $EX \in \mathbb{E}(n)$, and that

$$(2) \quad b(EX) = bV = bX.$$

Theorem 3' describes the hidden filtration factors of τX and $\tau^2 X$ in terms of the hidden filtration factors of X .

Theorem 3'. *Let X be a reduced object of $\mathcal{S}(n)$. Then*

$$E(\tau^2 X) = \rho EX \quad \text{and} \quad E(\tau X) = \Omega \rho^2 EX.$$

It is the first assertion $E(\tau^2 X) = \rho EX$ which is crucial for all our investigations and which immediately implies Theorem 3, see 3.2. This is what the reader should keep in mind: If we apply τ^2 to any reduced object in $\mathcal{S}(n)$, the three hidden filtration factors of X are just rotated. A first look at the objects $X = (U, V)$ in $\mathcal{S}(n)$ (and their traces in $\mathbb{T}(n)$) concentrates the attention to the two visible factors U and V/U , but for a proper understanding one should take into account also the additional factor ΩV of PV .

Proof of Theorem 3'. Given V in $\mathcal{N}(n)$, let V' be obtained from V by deleting all direct summands of the form $[n]$. Thus $V = V' \oplus P$, where $P = [n]^{bP}$ and V' has Loewy length at most $n - 1$.

We assume that X is a reduced object in $\mathcal{S}(n)$. Let $X = (U, V, W)$. Since we assume that X is reduced, both U and W belong to $\mathcal{N}(n-1)$. We decompose $V = V' \oplus P$ with $V' \in \mathcal{N}(n-1)$ and P a free Λ -module. We recall from [RS2, Theorem 5.1] the description of the Auslander-Reiten translation τ in $\mathcal{S}(n)$:

$$\tau X = (V', W \oplus Q, \Omega U),$$

where Q is a suitable free Λ -module. Since $\Omega P = 0$, we have $\Omega V = \Omega(V' \oplus P) = \Omega(V')$. Applying τ twice, we obtain a corresponding description of $\tau^2 X$.

Altogether, we look at the following objects in $\mathcal{S}(n)$:

$$\begin{aligned} X &= (U, V, W) = (U, V' \oplus P, W), \\ \tau X &= (V', W \oplus Q, \Omega U), \\ \tau^2 X &= (W, \Omega U \oplus R, \Omega(V')) = (W, \Omega U \oplus R, \Omega V). \end{aligned}$$

with $U, V', W \in \mathcal{N}(n-1)$, and free Λ -modules P, Q, R . Since U, V', W are in $\mathcal{N}(n-1)$, we have $\Omega^2 U = U$, $\Omega^2(V') = V' = \Omega^2 V$, $\Omega^2 W = W$.

This provides the first assertion $E(\tau^2 X) = (E_1 \cdot E_2, E_0) = \rho EX$. Namely, the subspace in $\tau^2 X$ is W , the corresponding factor space is ΩV ; the syzygy module $\Omega V(\tau^2 X)$ of $V(\tau^2 X)$ is $\Omega(\Omega U \oplus R) = \Omega^2 U \oplus 0 \simeq U$.

It follows that $\rho^2 EX = (E_2 \setminus E_0 \setminus E_1) = (W \setminus \Omega V \setminus U)$. On the other hand, since $V' = \Omega^2 V$, we have $E(\tau X) = (\Omega W \setminus V' \setminus \Omega U) = (\Omega W \setminus \Omega^2 V \setminus \Omega U)$. Thus $E(\tau X) = \Omega \rho^2 EX$. This is the second assertion of Theorem 3'. \square

3.2. Proof of Theorem 3. Given a non-zero element $E = (E_0 \setminus E_1 \setminus E_2)$ in $\mathbb{E}(n)$, let

$$pE = |E_1|/bE, \quad rE = |E_2|/bE, \quad \text{and also} \quad qE = pE + rE$$

(note that bE is non-zero, since we assume that E is non-zero). Of course, $\mathbf{pr} E = (pE, rE)$ will be called the *pr-vector* of E . We have

$$(3) \quad \mathbf{pr} \rho E = \rho \mathbf{pr} E,$$

for all $E \in \mathbb{E}(n)$. Proof. Let $E = (E_0 \setminus E_1 \setminus E_2)$. Since $|E_0| + |E_1| + |E_2| = n \cdot bE$, we have $|E_0|/bE = n - |E_1|/bE - |E_2|/bE = n - pE - rE$. Therefore $\mathbf{pr} \rho E = \mathbf{pr}(E_1 \setminus E_2 \setminus E_0) = (|E_2|/bE, |E_0|/bE) = (rE, n - pE - rE) = \rho \mathbf{pr} E$. \square

Of course, for any non-zero object X in $\mathcal{S}(n)$, we have $pEX = pX$, $rEX = rX$ (and therefore also $qEX = pEX + rEX = pX + rX = qX$), thus

$$(4) \quad \mathbf{pr} EX = \mathbf{pr} X.$$

Now, let X be reduced in $\mathcal{S}(n)$ and non-zero. Then Theorem 3' shows that

$$\mathbf{pr} \tau^2 X \stackrel{(4)}{=} \mathbf{pr} E(\tau^2 X) = \mathbf{pr} \rho EX \stackrel{(3)}{=} \rho \mathbf{pr} EX \stackrel{(4)}{=} \rho \mathbf{pr} X.$$

Similarly, we have

$$b(\tau^2 X) \underset{(2)}{=} bE(\tau^2 X) = b\rho EX \underset{(1)}{=} bEX \underset{(2)}{=} bX.$$

This completes the proof of Theorem 3. □

3.3. Remark.

Two special cases for the assertion $b(\tau^2 X) = bX$ for X reduced should be kept in mind: *If X is a reduced picket, then $\tau^2 X$ is a reduced picket.* Namely, X is a picket if and only if $bX = 1$. Similarly, *if X is a bipicket, then $\tau^2 X$ is a bipicket.* Section 12 will provide further information on pickets and bipickets; in particular, it describes the τ -orbits of pickets.

3.4. Corollary. *If X is a reduced object of $\mathcal{S}(n)$, then*

$$pX + p(\tau_n^2 X) + p(\tau_n^4 X) = n, \quad \text{and} \quad rX + r(\tau_n^2 X) + r(\tau_n^4 X) = n.$$

Note that the Corollary asserts that the average of both of the values of p and r on the τ^2 -orbit of any reduced object of $\mathcal{S}(n)$ is $\frac{n}{3}$. As a consequence, the average of $q = p + r$ on the τ^2 -orbit of any reduced object is $\frac{2n}{3}$. Thus, these numbers are also the average of the values of p , q , r for the corresponding τ -orbits.

Proof of Corollary. We have $p(\tau^2 X) = rX$ and $r(\tau^2 X) = n - pX - rX$. Therefore $p(\tau^4 X) = r(\tau^2 X) = n - pX - rX$ and $r(\tau^4 X) = n - p(\tau^2 X) - r(\tau^2 X) = n - rX - n + pX + rX = pX$. It follows that

$$\begin{aligned} pX + p(\tau^2 X) + p(\tau^4 X) &= pX + rX + n - pX - rX = n, \\ rX + r(\tau^2 X) + r(\tau^4 X) &= rX + n - pX - rX + pX = n. \end{aligned}$$

□

3.5. The uwb-vectors and the triples $(|E_0|, |E_1|, |E_2|)$.

Let us stress that our use of uwb-vectors as introduced in Section 1.4 refers to the triples $E = (E_0, E_1, E_2)$. Namely, being interested in such triples, it is natural to consider the corresponding dimension vectors $(|E_0|, |E_1|, |E_2|)$ in \mathbb{R}^3 and the uwb-vectors are just obtained by the following base change:

$$u = |E_1|, \quad w = |E_2|, \quad b = \frac{1}{n}(|E_0| + |E_1| + |E_2|).$$

Why do we prefer to work with uwb-vectors instead of the triples $(|E_0|, |E_1|, |E_2|)$? Starting with an object X in $\mathcal{S}(n)$, we may (and often will) consider X also as an object in $\mathcal{S}(m)$ with $m \geq n$ and its uwb-vector will remain the same!

The boundary distance. Given $E = (E_0, E_1, E_2)$ in $\mathbb{E}(n)$, let

$$mE = \min(|E_0|, |E_1|, |E_2|).$$

Given $X \in \mathcal{S}(n)$, let $mX = m(EX)$; then $dX = mX/bX$ is just the boundary distance of $\mathbf{pr} X$ in $\mathbb{T}(n)$, as defined in 1.4.

We may say that $E = (E_0, E_1, E_2) \in \mathbb{E}(n)$ is *central* provided $|E_0| = |E_1| = |E_2|$, or, equivalently, provided $mE = n/3$. We recall that an indecomposable object X in $\mathcal{S}(n)$ is said to be central provided its \mathbf{pr} -vector is $z(n) = (n/3, n/3)$, thus X is central if and only if EX is central.

***u*-minimal objects.** If $E = (E_0, E_1, E_2)$ belongs to $\mathbb{E}(n)$, we say that E is *u-minimal* provided $|E_1| \leq |E_2|$ and $|E_1| < |E_0|$. Thus E is *u-minimal* if and only if the \mathbf{pr} -vector $\mathbf{pr} E$ of E satisfies the inequalities $pE \leq rE$ and $2pE < n - rE$ (so that $\mathbf{pr} E$ lies in the following shaded part of $\mathbb{T}(n)$; the black square marks the center $z(n)$):

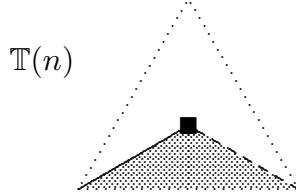

If X in $\mathcal{S}(n)$ is indecomposable, we say that X is *u-minimal* provided EX is *u-minimal*. Of course, if X is *u-minimal*, then X is not central; also, X is not projective.

Lemma 1. *If X in $\mathcal{S}(n)$ is indecomposable, and neither central nor projective, then precisely one of the objects $X, \tau^2 X, \tau^4 X$ is *u-minimal*.*

This follows immediately from Theorem 3'. □

The next result states that the indecomposable objects X with $mX = 0$ are exactly the boundary pickets.

Lemma 2. *Let X be indecomposable and $EX = (E_0 \setminus E_1 \setminus E_2)$. One of the E_i is zero, if and only if X is a boundary picket.*

Proof. If X is a boundary picket, then either $uX = 0$, thus $E_1 = 0$; or $w = 0$, thus $E_2 = 0$, or $u + w = n$, and then $E_0 = 0$. Conversely, assume that $E_i = 0$ for some i . If $E_1 = 0$, then $uX = 0$ and then clearly X has to be a picket. Dually, if $E_2 = 0$, then $wX = 0$ and X is a picket. Finally, assume that $E_0 = 0$. Then V is a projective Λ -module. But it is well-known that the only indecomposable objects (U, V) with V being projective are the pickets. □

3.6. Barycentric coordinates.

This seems to be the right place to insert an important, however obvious, remark. The functions p and r , the level and the colevel, are (of course) part of the barycentric coordinate

system for the triangle $\mathbb{T}(n)$, the additional coordinate is the function $n - q = n - (p + r)$ (thus corresponds to the mean).

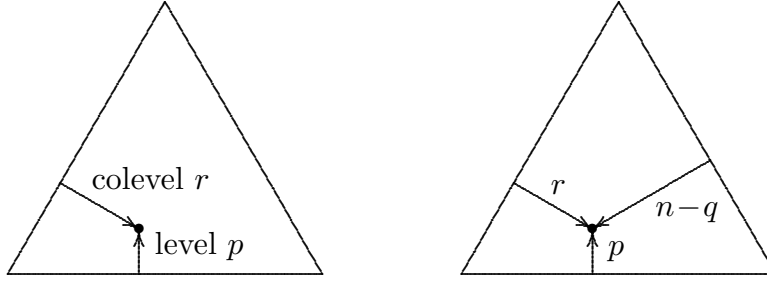

In terms of \mathbb{E} , the three functions p , r , $n - q$ are just the functions $|E_1|/b$, $|E_2|/b$ and $|E_0|/b$. Given an object $X = (U, V) = (U, V, W)$ in $\mathcal{S}(n)$, we have attached the triple

$$EX = (\Omega V \setminus U \setminus W) \in \mathbb{E}(n);$$

Of course, the last two coordinates p and r are given by $p(EX) = pX$, and $r(EX) = rX$. The first coordinate $n - q = n - p - r$ is just ω/b , where $\omega X = |\Omega V|$. The relevant formula to have in mind is:

$$\omega + u + w = nb,$$

which is valid for all objects X in $\mathcal{S}(n)$.

Using ω as additional coordinate, Theorem 1 can be rewritten as follows.

Theorem 1, again reformulated. *Let X be an indecomposable object in $\mathcal{S}(n)$. Then either X is a boundary picket, or else $u \geq b$, $w \geq b$, and $\omega \geq b$.* \square

3.7. Central objects.

Proposition. *Let $X = (U, V)$ be indecomposable. Then the following conditions are equivalent:*

- (i) X is central.
- (ii) $uX = wX = |\Omega V|$.
- (iii) $uX = u(\tau^2 X)$, $wX = w(\tau^2 X)$.

Proof. First, assume that X is projective. Then X cannot be central. Also, $\Omega V = 0$, thus condition (ii) is not valid ($uX = wX = 0$ implies that $X = 0$); similarly, (iii) is not valid.

Thus, we can assume that X is not projective and therefore $\tau^2 X = (W, V(\tau^2 X), \Omega V)$. Therefore $u(\tau^2 X) = wX$ and $w(\tau^2 X) = |\Omega V|$.

Now X is central if and only if $EX = (\Omega V, U, W)$ is central, thus if and only if condition (ii) is satisfied. It remains to show the equivalence of (ii) and (iii). Since $u(\tau^2 X) = wX$, the equality $uX = wX$ is the same as $uX = u(\tau^2 X)$. Since $w(\tau^2 X) = |\Omega V|$, the equality $wX = |\Omega V|$ is the same as $wX = w(\tau^2 X)$. \square

We add here some remarks concerning the Auslander-Reiten components of $\mathcal{S}(n)$.

As a consequence of the Proposition, we see that any tube \mathcal{C} contains infinitely many central objects. Namely, for \mathcal{C} being stable, there is the following assertion:

Corollary. *Let X be indecomposable. If $\tau^2 X = X$, then X is central (thus, if X belongs to a tube of rank 1 or 2, then X is central). If X belongs to a stable tube of rank $r = 3$ or $r = 6$, and has quasi-length divisible by r , then X is central.*

Proof. We use the implication (iii) \implies (i). The first assertion is a direct consequence. For the second assertion, assume that \mathcal{C} has rank $r = 3$ or 6 . Let X be in \mathcal{C} with quasi-length rt . Let Z be quasi-simple in \mathcal{C} . Then X has a filtration with factors $\tau^i Z$, where $0 \leq i < rt$ and Z is quasi-simple. But $\tau^2 X$ has a similar filtration, with factors being just rotated. Thus $uX = u(\tau^2 X)$ and $wX = w(\tau^2 X)$. \square

The discussion of $\mathcal{P}(n)$ in 9.5 shows that for $\mathcal{P}(n)$ with $n \geq 6$, and $t \in \mathbb{N}_1$, precisely one of the two τ^2 -orbits of objects of quasi-length $6t$ consists of central objects, and these are the only ones in $\mathcal{P}(n)$.

Remark. *There are additional central objects.* The bipicket X

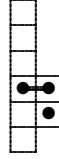

has uwb-vector $\frac{4|4}{2}$, thus X is central in $\mathcal{S}(6)$. We have $X = \tau_6 E_2^2$ (and E_2^2 is not central in $\mathcal{S}(6)$). Here, we deal with objects of quasi-length 2 in the 6-tube of $\mathcal{S}(6)$ with rationality index 1: three of these objects are central, the other three not.

* * *

The main assertions of Section 3 concern τ^2 . Let us end this section by looking at the action of τ itself. First, let us point out that there are some peculiarities.

3.8. Warnings.

(1) *If X, X' are indecomposable objects in $\mathcal{S}(n)$ with $\mathbf{pr} X = \mathbf{pr} X'$, we usually have $\mathbf{pr} \tau_n X \neq \mathbf{pr} \tau_n X'$.*

An example for $n = 4$. There are two indecomposable objects in $\mathcal{S}(4)$ with pr-vector $(1, 1)$, namely $X = ([1], [2])$ and $X' = E_2^2$. We have $\tau_4 X = E_2^3$ with $\mathbf{pr} \tau_4 X = (1, 3/2)$, whereas the global space of $\tau_4 X'$ is $[4, 2]$, its subspace is $[3, 1]$, its factor space is $[2]$, thus $\mathbf{pr} \tau_4 X' = (2, 1)$.

(2) *If X, X' are indecomposable objects in $\mathcal{S}(n)$ with $\mathbf{dim} X = \mathbf{dim} X'$, and $bX = bX'$, we may have $\mathbf{dim} \tau_n X \neq \mathbf{dim} \tau_n X'$, $b\tau_n X \neq b\tau_n X'$ as well as $\mathbf{pr} \tau_n X \neq \mathbf{pr} \tau_n X'$.*

Examples for $n = 6$. We consider three indecomposable objects with the same global space $V = [6, 4, 2]$, using subspaces U, U', U'' of dimension 6.

$$X = (U, V, W) \quad X' = (U', V, W') \quad X'' = (U'', V, W'')$$

Here, $U \simeq U' \simeq [4, 2] \simeq W \simeq W''$, and $U'' \simeq W' \simeq [4, 1, 1]$. Obviously, we have $\mathbf{dim} X = \mathbf{dim} X' = \mathbf{dim} X'' = (6, 12)$, and $bX = bX' = bX'' = 3$.

We get $\mathbf{par} \tau_6 X = ([4, 2], [6, 4, 2], [4, 2])$, $\mathbf{par} \tau_6 X' = ([4, 2], [6, 4, 1, 1], [4, 2])$, and finally $\mathbf{par} \tau_6 X'' = ([4, 2], [6, 6, 4, 2], [5, 5, 2])$. It follows that $\mathbf{dim} \tau_6 X = \mathbf{dim} \tau_6 X'_n = (6, 12)$, whereas $\mathbf{dim} \tau_6 X''_n = (6, 18)$. Also, $bX = 3$, but $bX' = bX'' = 4$. Thus $\mathbf{pr} \tau_6 X = (2, 2)$, $\mathbf{pr} \tau_6 X' = (3/2, 3/2)$ and $\mathbf{pr} \tau_6 X'' = (3/2, 3)$.

Remark 1. *The partition vector $\mathbf{par}(\tau_n X)$ is determined by $\mathbf{par} X$.* Proof. Let X be an object in $\mathcal{S}(n)$ with $X = (U, V' \oplus P, W)$, where V' has height at most $n - 1$ and P is a free Λ -module. Thus $\mathbf{par} X = ([U], [V' \oplus P], [W])$, with $[V']$ and $[P]$ both being determined by $[V]$ (and n). As we know, $\mathbf{par}(\tau_n X) = ([V'], [W] \oplus [Q], [\Omega U])$, thus it remains to see that $[Q]$ is determined by $\mathbf{par} X$. But we have $|Q| = |V'| + |\Omega U| - |W| = |V'| + |\Omega U| - |V| + |U| = n \cdot bU - |P|$. \square

Remark 2. *If the indecomposable object X occurs in a stable tube and has even quasi-length, then $b\tau_n X = bX$.* Proof. Write $X = Z[\ell]$ where Z is on the mouth of the tube and the quasi-length ℓ of X is even. Using the additivity of b on Auslander-Reiten sequences in stable tubes (see 9.4), we have $bX = \sum_{i=0}^{\ell-1} b\tau_n^{-i} Z = \sum_{i=0}^{\ell-1} b\tau_n^{1-i} Z = b\tau_n X$ since $b\tau_n^{-\ell+1} Z = b\tau_n Z$ by Theorem 3, using that ℓ is even. \square

There is the following general observation concerning $\tau_n X$.

3.9. Proposition. *Let $X = (U, V, W)$ be any object of $\mathcal{S}(n)$. Then*

$$b(\tau_n X) \leq bU + bW,$$

with equality if and only if X has height at most $n - 1$.

The difference between $bU + bW$ and $b(\tau_n X)$ is of interest (it is the Krull-Remak-Schmidt multiplicity of Λ in the Λ -module V); this will be further discussed in 3.12.

Proof. We can assume that X is indecomposable. If X is projective, then $\tau_n P = 0$, thus nothing has to be shown.

Therefore, we can assume that X is reduced. As in the proof of Theorem 3', we have $V = V' \oplus P$, and $\tau_n X = (V', W \oplus Q, \Omega U)$, where V' has height at most $n - 1$ and where P and Q are free Λ -modules.

The exact sequence $0 \rightarrow U \rightarrow V' \oplus P \rightarrow W \rightarrow 0$ yields $|U| = |V'| + |P| - |W|$. The exact sequence $0 \rightarrow V' \rightarrow W \oplus Q \rightarrow \Omega U \rightarrow 0$ yields $|\Omega U| = |W| + |Q| - |V'|$. Thus we obtain

$$n \cdot bU = |U| + |\Omega U| = |P| + |Q| = n \cdot bP + n \cdot bQ.$$

Therefore

$$(*) \quad bU = bP + bQ.$$

Since $bP \geq 0$, we have $bQ \leq bU$. Since the global space of $\tau_n X$ is $W \oplus Q$, we see that $b(\tau_n X) = bW + bQ \leq bW + bU$.

We have

$$(**) \quad bU + bW - b(\tau_n X) = bU + bW - bW - bQ = bU - bQ = bP.$$

Of course, $bP = 0$ if and only if X belongs to $\mathcal{S}(n-1)$. □

3.10. Proposition. *If X in $\mathcal{S}(n)$ is indecomposable and not projective, then*

$$\frac{1}{2}bX \leq b(\tau_n X) \leq 2bX.$$

Proof. Let $X = (U, V, W)$. According to 3.9, we have $b(\tau X) \leq bU + bW$. Since both U and W are subquotients of V , we have $bU \leq bV$ and $bW \leq bV$. Therefore

$$b(\tau X) \leq bU + bW \leq 2bX.$$

If we consider τX instead of X , we see that $b(\tau^2 X) \leq 2b(\tau X)$. But since X is indecomposable and not projective, we have $bX = b(\tau^2 X)$, thus $bX = b(\tau^2 X) \leq 2b(\tau X)$, and therefore $\frac{1}{2}bX \leq b(\tau X)$. □

Example. *The inequality is optimal.* For $n \geq 3$ it is easy to construct indecomposable objects $X = (U, V, W)$ in $\mathcal{S}(n-1)$ with $bU = bW = bX$ and then $b(\tau_n X) = bU + bW = 2bX$.

For example, there is the following object X in $\mathcal{S}(8)$ with $bX = 3$

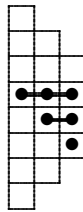

with the partition vector

$$[531] \quad [864] \quad [531],$$

and $\tau_9 X$ has the partition vector

$$[864] \quad [999531] \quad [864].$$

A further remark. If X is a bipicket in $\mathcal{S}(n)$ with $n \geq 6$, then all cases $b(\tau_n X) = 1, 2, 3, 4$ are possible.

3.11. The following formula for $bX + b(\tau_n X)$ is valid for all objects X in $\mathcal{S}(n)$.

Proposition. Let $X = (U, V, W)$ be an object in $\mathcal{S}(n)$. Then

$$bX + b(\tau_n X) = b\Omega V + bU + bW.$$

Proof. Here we use for X in $\mathcal{S}(n)$ the definition of EX and the formula $E(\tau_n X) = \Omega\rho^2 EX$ given in Theorem 3'.

$$\begin{aligned} n(b\Omega V + bU + bW) &= |P\Omega V| + |PU| + |PW| \\ &= (|\Omega V| + |U| + |W|) + (|\Omega^2 V| + |\Omega U| + |\Omega W|) \\ &= |EX| + |E(\tau_n X)| \\ &= n \cdot bX + n \cdot b(\tau_n X). \end{aligned}$$

□

* * *

It seems to be a good place to introduce here a further invariant for the objects in $\mathcal{S}(n)$. We denote it by c_n . In contrast to the invariants u, v, w, b , this new one depends not only on the object $X \in \mathcal{S}$, but also on the height n of X . As u, v, w, b , the values of c_n are non-negative integers. Whereas u, v, w, b vanish only on the zero object, we have $c_n X = 0$ if and only if X has height at most $n - 1$.

3.12. The invariant c_n . The new invariant c_n will be defined first for the objects V in $\mathcal{N}(n)$ (as we did when we defined the invariant b). Let V be a module in $\mathcal{N}(n)$. Then $c_n V$ is defined to be the dimension of $T^{n-1}V$, thus $c_n V$ is the number of Jordan blocks of size n of the operator T , or, equivalently, the Krull-Remak-Schmidt multiplicity of Λ in V . Thus, if we write $V = V' \oplus P$, where V' has height at most $n - 1$ and P is a free Λ -module, then c_n is the rank of P . If $X = (U, V)$ is an object in $\mathcal{S}(n)$, we set $c_n X = c_n V$.

The following formula rewrites some previous observation.

Proposition 1. Let X be any object in $\mathcal{S}(n)$. Then

$$b(\tau_n X) = bU + bW - c_n X$$

Proof. The formula holds for projective objects and has been shown for reduced objects in the proof of 3.9, see (**). □

Corollary. Let $X = (U, V, W)$ be a reduced object in $\mathcal{S}(n)$ of height n . Then for all $t \geq 1$, we have

$$b(\tau_n X) < bU + bW = b(\tau_{n+t} X).$$

Proof. Since X has height n , we have $c_n X > 0$, thus Proposition 1 asserts that $b(\tau_n X) < bU + bW$. For every $t \geq 1$, the object X is reduced in $\mathcal{S}(n+t)$. Since its height is smaller than $n+t$, Proposition 1 asserts that $b(\tau_{n+t} X) = bU + bW$. \square

There is also the following assertion.

Proposition 2. *If $X = (U, V)$ is a reduced object in $\mathcal{S}(n)$, then*

$$bU = c_n X + c_n(\tau_n X).$$

Proof. See the proof of Proposition 3.9 (*). \square

Corollary. *If $X = (U, V)$ is a reduced object in $\mathcal{S}(n)$, then*

$$c_n X \leq bU, \quad \text{and} \quad c_n X \leq bW.$$

Proof. The first assertion is a direct consequence of Proposition 2, since $c_n(\tau_n X) \geq 0$. The second assertion follows by duality. \square

Proposition 3. *If $X = (U, V)$ is a reduced object in $\mathcal{S}(n)$, then*

$$c_n(\tau_n^2 X) = bX - bU.$$

Proof. We have mentioned in the proof of Theorem 3' in 3.1 that for $X = (U, V, W)$ reduced, we have $\tau_n^2 X = (W, \Omega U \oplus R, \Omega V)$ with R a free Λ -module. Since ΩU has height at most $n-1$, we see that $c_n(\tau_n^2 X)$ is the rank of R , therefore $bX = b(\tau_n^2 X) = b\Omega U + bR = bU + c_n(\tau_n^2 X)$ (where we also use that $bU = b\Omega U$). \square

Corollary. *If X is any object in $\mathcal{S}(n)$, then*

$$bX = c_n X + c_n(\tau_n X) + c_n(\tau_n^2 X).$$

Proof. We can assume that X is indecomposable. If X is projective, $bX = 1 = c_n X$ yield the assertion.

Thus, we can assume that X is reduced. Proposition 2 asserts that $bU = c_n X + c_n(\tau_n X)$. Proposition 3 asserts that $bX - bU = c_n(\tau_n^2 X)$. The sum of the two equalities is the required one. \square

First part: Sparsity.

4. Telescope filtrations and proof of Theorem 1.

We always will interpret $\mathcal{S}(n)$ as a full subcategory of $\text{mod } T_2(\Lambda)$. In particular, when we need homological invariants such as Ext-groups, the reference category is $\text{mod } T_2(\Lambda)$. Thus, if X, Z are objects in $\mathcal{S}(n)$, the group $\text{Ext}^1(Z, X)$ may be considered as the set of equivalence classes of short exact sequences $0 \rightarrow X \rightarrow Y \rightarrow Z \rightarrow 0$ in $\text{mod } T_2(\Lambda)$.

The subcategory $\mathcal{S}(n)$ of $\text{mod } T_2(\Lambda)$ is closed under submodules. If (U, V) is an object of $\mathcal{S}(n)$ and (U', V') is a $T_2(\Lambda)$ -submodule of (U, V) , the factor module $(U, V)/(U', V')$ usually will not belong to $\mathcal{S}(n)$ (since the induced map $U/U' \rightarrow V/V'$ does not have to be a monomorphism). We say that (U', V') is an *admissible* submodule of (U, V) , provided $U' = U \cap V'$, thus provided $(U, V)/(U', V')$ belongs to $\mathcal{S}(n)$.

If (U, V) is an object of $\mathcal{S}(n)$ and (U', V') is an admissible submodule of (U, V) , we will say that (U', V') is a *g-split* subobject of (U, V) , provided the embedding $V' \rightarrow V$ is a split monomorphism (g-split means: “globally split”). The equivalence classes of g-split exact sequences form a subgroup of $\text{Ext}^1(Z, X)$ which we denote by $\text{Ext}_g^1(Z, X)$.

Let $0 \rightarrow X_1 \rightarrow X \rightarrow X_2 \rightarrow 0$ be an exact sequence in $\mathcal{S}(n)$, with $X_i = (U_i, V_i)$ for $i = 1, 2$ and $X = (U, V)$. Then, obviously,

$$|U| = |U_1| + |U_2|, \quad \text{and} \quad |V/U| = |V_1/U_1| + |V_2/U_2|,$$

If the sequence is, in addition, g-split, then also

$$bV = bV_1 + bV_2,$$

so that

$$pX = \frac{|U_1| + |U_2|}{bV_1 + bV_2}, \quad \text{and} \quad rX = \frac{|V_1/U_1| + |V_2/U_2|}{bV_1 + bV_2}.$$

If X has a g-split filtration with factors F_i , $1 \leq i \leq t$, then

$$\begin{aligned} \min\{pF_i \mid 1 \leq i \leq t\} &\leq pX \leq \max\{pF_i \mid 1 \leq i \leq t\}, \\ \min\{rF_i \mid 1 \leq i \leq t\} &\leq rX \leq \max\{rF_i \mid 1 \leq i \leq t\}, \end{aligned}$$

with proper inequalities in case $\min < \max$.

Definition: A *telescope* filtration of $X \in \mathcal{S}(n)$ is a filtration

$$0 = X_0 \subset X_1 \subset \cdots \subset X_{b-1} \subset X_b = X$$

consisting of g-split admissible subobjects, such that each factor X_i/X_{i-1} is a picket, say equal to $([t_i], [m_i])$, and such that, in addition, we have $m_1 \geq m_2 \geq \cdots \geq m_b$. (Since we deal with g-split subobjects, we see that the global space of X is equal to the direct sum

$\bigoplus_{i=1}^b [m_i]$, as a consequence, $bX = b$, and the subspace has a filtration with factors $[t_i]$, thus its length is equal to $\sum_{i=1}^b t_i$.)

For the proof of Theorem 1, we need some preparations.

Lemma 1. *Any object X in $\mathcal{S}(n)$ has a telescope filtration.*

Proof. Let $X = (U, V)$. Let $b = bV$. Let $V = \bigoplus_{i=1}^b [\lambda_i]$, where $(\lambda_1, \dots, \lambda_b)$ is a partition. For $0 \leq t \leq b$, let $V_t = \bigoplus_{i=1}^t [\lambda_i]$, and $X_t = (V_t \cap U, V_t)$. Then $(X_t)_t$ is a telescope filtration of X . \square

A picket of the form $(0, [m])$ will be called a 0-picket.

Lemma 2. *Let $0 \rightarrow X \rightarrow Y \rightarrow Z \rightarrow 0$ be an exact sequence in \mathcal{S} . Let F be a 0-picket.*

- (a) *If $X = F$ and the height of X is greater or equal to the height of Y , then the sequence splits (in particular, Y has a direct summand isomorphic to F).*
- (b) *If $Z = F$ and the sequence is g-split, then the sequence splits (in particular, Y has a direct summand isomorphic to F).*

Proof. (a) Let h denote the height of X . By assumption, the exact sequence lies in $\mathcal{S}(h)$, and $\mathcal{S}(h)$ is the category of Gorenstein-projective $T_2(\Lambda)$ -modules, where $\Lambda = k[T]/T^h$. Since $(0, [h])$ is a projective $T_2(\Lambda)$ -module, we have $\text{Ext}^1(Z, (0, [h])) = 0$ for all objects in $\mathcal{S}(h)$.

(b) Really, nothing has to be shown: Let $0 \rightarrow X \rightarrow Y \rightarrow Z \rightarrow 0$ be a g-split exact sequence with $X = (U, V)$ and $Z = (0, [h])$. Then the global space of Y is $V \oplus [h]$, its subspace is $U \oplus 0 = U$ with its given embedding into V , thus $Y = X \oplus (0, [h])$. \square

Warning. In order to understand the setting of Lemma 2, let us exhibit several examples.

In (a), we need the height condition. In order to see this, let $X = (0, [2])$ be the 0-picket of height $h = 2$. We provide two non-split exact sequences $0 \rightarrow X \rightarrow Y \rightarrow Z \rightarrow 0$. First of all, let $Y = (0, [3])$ and $Z = Y/X = (0, [1])$. Here, Z has height at most h (but note that Y is again a 0-picket). Second, let $Y = ([1], [2]) \oplus (0, [3])$ with global space generated by x, y such that $T^2x = T^3y = 0$ and with subspace generated by Tx . Let X be the admissible subobject generated by $x + Ty$. Then X is isomorphic to $([0], [2])$ and $Z = Y/X$ is isomorphic to $([1], [3])$. Note that Z has height 3 and that the sequence is g-split.

In (b), we need the g-splitting, as the case $X = ([1], [1])$, $Y = ([1], [2])$, $Z = (0, [1])$ shows. In this example, $bY < bX + bZ$. An example with $bY = bX + bZ$ is given by $Y = E_2^2$, where the global space of E_2^2 is generated by x, y with $T^3x = 0 = Ty$ and the subspace in E_2^2 is generated by $Tx + y$. Let X be the admissible subobject of E_2^2 generated by $Tx + y$. Then X is isomorphic to $([2], [2])$ and $Z = Y/X$ is isomorphic to $(0, [2])$.

Conversely, there are exact sequences $0 \rightarrow X \rightarrow Y \rightarrow Z \rightarrow 0$ such that Y has a 0-picket F as a direct summand, whereas neither X , nor Z , have F as a direct summand. For example, let $Y = ([0], [2]) \oplus ([2], [2])$, say with global space generated by x and y , and subspace generated by y . Let X be the admissible subobject of Y generated by $Tx + y$. Then both X and Y/X are isomorphic to $([1], [2])$.

Proposition. *Let F be a 0-picket. If X has a telescope filtration where at least one of the factors is isomorphic to F , then X has a direct summand isomorphic to F .*

Proof. Let $(X_i)_i$ be a telescope filtration of X and assume that $F = X_t/X_{t-1}$ is a 0-picket of height h . Then $X_{t-1} \subset X_t$ is a g-split embedding, and X/X_{t-1} has height at most h .

We apply part (a) of Lemma 2 to the embedding of X_t/X_{t-1} into X/X_{t-1} , so there exists a submodule Z of X containing X_{t-1} such that $X/X_{t-1} = X_t/X_{t-1} \oplus Z/X_{t-1}$ (thus $X_t + Z = X$, and $X_t \cap Z = X_{t-1}$). We apply part (b) of Lemma 2 to the embedding of X_{t-1} into X_t and see that $X_t = C \oplus X_{t-1}$ (thus $C + X_{t-1} = X_t$ and $C \cap X_{t-1} = 0$).

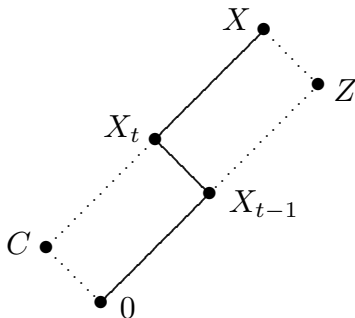

We have $C + Z = C + X_{t-1} + Z = X_t + Z = X$ and $C \cap Z = C \cap X_t \cap Z = C \cap X_{t-1} = 0$. Therefore $X = C \oplus Z$. Of course, C is isomorphic to $X_t/X_{t-1} = F$. \square

Lemma 3. *Let X be a non-zero object in $\mathcal{S}(n)$. If X has a telescope filtration, such that no factor is a 0-picket, then $pX \geq 1$.*

Proof. Let X be a non-zero object in $\mathcal{S}(n)$ and let

$$0 = X_0 \subset X_1 \subset \cdots \subset X_{b-1} \subset X_b$$

be a telescope filtration of X with factors $F_i = X_i/X_{i-1}$. Assume that none of the factors F_i , $1 \leq i \leq b$ is a 0-picket. Let $F_i = [h_i, m_i]$, where $1 \leq h_i \leq m_i$. The subspace U in X has length $|U| = \sum_{i=1}^b h_i \geq b$, and we have $bX = b$. Thus $|U| \geq bX$, therefore $pX = |U|/bX \geq 1$. \square

Warning, continued. *Note that an object X with a telescope filtration such that no factor is a 0-picket, may have a direct summand which is a 0-picket.*

Example: The object $X = ([2], [2]) \oplus (0, [1])$ has an admissible g-split subobject of the form X' isomorphic to $([1], [2])$ and the corresponding factor object is isomorphic to $([1], [1])$. Namely, let x, y be generators of the global space of X , say with $T^2x = 0 = Ty$ and such that the subspace in X is generated by x . Let X' be the admissible subobject of X whose total space is generated by $x + y$. Then X' is isomorphic to $([1], [2])$ and X/X' is isomorphic to $([1], [1])$. \square

In particular, we see: *The class of objects without direct summands which are 0-pickets is not closed under extensions.*

Proof of Theorem 1. We assume that X is a non-zero object in $\mathcal{S}(n)$.

(a) If X has no direct summand which is a 0-picket, then $pX \geq 1$.

Proof. Let X be a non-zero object and assume that X has no direct summand which is a 0-picket. Take any telescope filtration of X , say with factors F_i . According to Proposition, no F_i is a 0-picket. Lemma 3 yields that $pX \geq 1$. \square

(b) Let X be a non-zero object in $\mathcal{S}(n)$. If X has no direct summand which is a picket of height n , then $pX + rX \leq n - 1$.

Proof. We assume that X is non-zero and has no direct summand which is a picket of height n . In particular, X is reduced. Let $Y = \tau^4 X$. Then Y is reduced and $\tau^2 Y = \tau^6 X = X$. If Y would have a direct summand which is a 0-picket, then $X = \tau^2 Y$ has a direct summand which is a picket of height n a contradiction (here we use that $\tau^2(0, [m]) = ([m], [n])$). Thus, according to (a), we have $pY \geq 1$. According to Theorem 3, we have $pX + rX = p(\tau^2 Y) + r(\tau^2 Y) = rY + n - pY - rY = n - pY$. Since $pY \geq 1$, it follows that $pX + rX = n - pY \leq n - 1$. \square

(c) If X has no direct summand which is a picket of the form $([m], [m])$, then $rX \geq 1$.

Proof. We could use τ^2 and (b), or τ^4 and (a). But actually, it is easier to use duality. We assume that X has no direct summand which is a picket of the form $([m], [m])$. Then $D X$ has no direct summand which is a picket of the form $(0, [m])$, thus a 0-picket. According to (a) we have $p(D X) \geq 1$. Since $rX = p(D X)$, we see that $rX \geq 1$. \square

5. Special filtrations, nice filtrations, and proof of Theorem 2.

We want to proof Theorem 2. This concerns the corners of the triangle Δ_1 . Let us first look at the corner $(1, 1)$. We claim:

Theorem 2'. *Let X be an indecomposable object in $\mathcal{S}(n)$ with pr -vector $(1, 1)$. Then X is the picket $([1], [2])$ or the unique bipicket in $\mathcal{S}(3)$.*

Note that there is just one bipicket in $\mathcal{S}(3)$, namely $E_2^2 = (U, V)$ with $V = [3, 1]$ and U and V/U both isomorphic to $[2]$. The essential information of Theorem 2' is the following: *Let X be indecomposable in $\mathcal{S}(n)$. If $qX \leq 2$, then X belongs to $\mathcal{S}(3)$.* Namely, the indecomposable objects X of height at most 3 are well-known and qX is easy to calculate for these objects: There are just six indecomposable objects in $\mathcal{S}(3)$ with $qX \leq 2$, namely the five pickets $(0, [1])$, $([1], [1])$, $(0, [2])$, $([1], [2])$, $([2], [2])$, and in addition E_2^2 .

A bipicket $X = (U, V)$ is said to be an *extended picket* provided V has a part equal to $[1]$. The extended pickets are the objects of the form $E_u^w = ([u], [u + w - 1, 1], [w])$ with $u, w \geq 2$. Note that if $\mathbf{par} X = ([u], [u + w - 1, 1], [w])$, then X has to be indecomposable and we have for $n = u + w - 1$ that $\tau_n X = (\text{soc}[w], [w])$, thus X is uniquely determined by $\mathbf{par} X$. Here are the extended pickets E_u^w with $u + w \leq 6$:

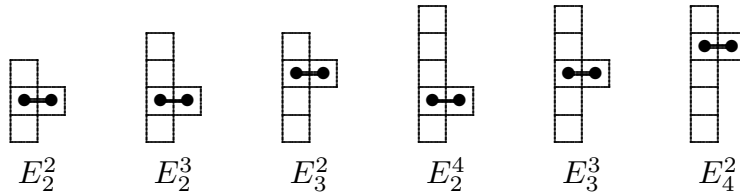

Of course, E_2^2 is just the unique indecomposable object of $\mathcal{S}(3)$ which is not a picket.

Proposition. *Any object X is a direct sum $X = X' \oplus X''$, where X' has a g-split filtration whose factors are pickets of height at least 2 and extended pickets, and where X'' has height at most 1.*

In particular, if X is indecomposable and not of height 1, then X has a g-split filtration whose factors are pickets of height at least 2 and extended pickets.

Corollary. *If X is indecomposable with $qX \leq 2$, then X belongs to $\mathcal{S}(3)$.*

Proof. For pickets, the mean is just the height. For the extended picket $Y = ([u], [u + w - 1, 1], [w])$, we have $qY = (u + w)/2 \geq 2$. Thus, if Y is a picket or an extended picket with $qY \leq 2$, then Y is a picket of height at most 2 or else $Y = E_2^2$; always, Y belongs to $\mathcal{S}(3)$.

Assume now that X is indecomposable with $qX \leq 2$. According to the Proposition, X has either height 1 or has a g-split filtration with factors in $\mathcal{S}(3)$. Therefore X belongs to $\mathcal{S}(3)$. \square

The proposition will follow directly from a Lemma which provides a slightly stronger statement, namely further details on the direct decomposition $X = X' \oplus X''$. We need some definitions.

A subobject X' of X is said to be a *special subobject* provided the following two conditions are satisfied: first, X' is a picket of height equal to the height of X (as a consequence, X' will be a g-split subobject), and second, the dimension vector of X' is maximal (that means: let h be the height of X , so that $\mathbf{dim} X' = (t, h)$ for some $0 \leq t \leq h$; if now (i, h) is the dimension vector of any picket which is a subobject of X , then $i \leq t$). Note that a special subobject X' is always an admissible subobject.

A *special filtration* of X is defined to be a sequence $0 = X_0 \subseteq X_1 \subseteq \dots \subseteq X_b = X$ of (admissible g-split) subobjects such that X_i/X_{i-1} is a special subobject of X/X_{i-1} , for $1 \leq i \leq b$.

Of course, any object has a special filtration. Any special filtration is a telescope filtration, but the converse is not true: Take $X = ([2], [2]) \oplus (0, [1])$. Thus, the global space of X is $V = [2, 1]$, say with generators x, y , with $T^2x = 0$ and $Ty = 0$. Let V_1 be the submodule of V generated by $x + y$, then $U_1 = U \cap V_1$ is generated by Tx . Thus we have the telescope filtration $0 = X_0 \subset X_1 \subset X_2 = X$ with $X_1 = (U_1, V_1)$ isomorphic to $([1], [2])$ and X/X_1 isomorphic to $([1], [1])$. This filtration is not special, since X_1 is not a special subobject of X .

Finally, a *nice filtration* is by definition a g-split filtration whose factors are pickets of height at least 2 and extended pickets.

We are going to show:

Lemma. *Let $(X_i)_i$ with $0 \leq i \leq b$ be a special filtration of X with factors F_i . Choose $0 \leq t \leq b$ minimal such that all factors F_i with $i > t$ have height 1. Then there is a direct decomposition $X = X' \oplus X''$, with $X_t \subseteq X'$ such that X' has a nice filtration (and X'' has height at most 1).*

Note that X'' has height at most 1, since $X'' = X/X'$ is a factor object of X/X_t .

Proof of Lemma.

(1) First, we consider **the case** $t = 1$, thus $X = (U, V)$ with $[V] = [h, 1, \dots, 1]$. We claim that $X = Y \oplus Z$, where Y is a picket or an extended picket and Z has height at most 1; we call such a direct decomposition a *good* decomposition. To produce such a decomposition is slightly tedious, but not difficult, and is left to the reader; (note that in the cases $2 \leq h \leq 5$, this decomposition is well-known and there is no further complication in the general case).

It remains to determine the special subobjects X_1 of X and to show that for any X_1 , there is a good decomposition $X = Y' \oplus Z$ with $X_1 \subseteq Y'$. We distinguish three cases.

First, let Y be a picket isomorphic to $([h], [h])$. Let y be a generator of the global space of Y . Then the global space of an arbitrary special subobject of X is generated by $y + z$ for some $z \in U \cap Z$, thus $X_1 = (\Lambda(y + z), \Lambda(y + z))$ and $X = X_1 \oplus Z$ is a good decomposition.

Second, let Y be a picket of type $([s], [h])$ with $s < h$. Again, we assume that the global space of Y is generated by y . Then the global space of any special subobject X_1 of X is generated by $y + z$, now with an arbitrary element $z \in Z$. Then $X_1 = (U \cap \Lambda(y + z), \Lambda(y + z))$ and again, $X = X_1 \oplus Z$ is a good decomposition.

Third, let Y be an extended picket, say generated by y and w , where $|\Lambda w| = 1$. Then the global space of an arbitrary special subobject X_1 of X is generated by $y + w' + z$ for some $w' \in \Lambda w$ and $z \in Z$. Then $X = Y' \oplus Z$, where the global space of Y' is generated by $y + w' + z$ and w , thus by $y + z$ and w . Again, this is a good decomposition and $X_1 \subseteq Y'$.

(2) **The induction.** We start with an arbitrary object X with a special filtration $(X_i)_i$ with factors F_i such that the factors F_1, \dots, F_t have height at least 2, whereas the remaining factors F_i have height 1.

If $t = 0$, then X has height at most 1; thus, take $X' = 0$ and $X'' = X$. The case $t = 1$ has been considered already. Thus, we assume now that $t \geq 2$.

We look at $Y = X/X_{t-1}$. By assumption, there is given a special filtration of Y , namely by the subobjects $Y_i = X_{t+i-1}/X_{t-1}$, and just one factor has height at least 2, namely $Y_1/Y_0 = X_t/X_{t-1}$. According to (1), we obtain a direct decomposition $Y = Y' \oplus Y''$, where Y' is a picket of height at least 2 or an extended picket, and where Y'' has height at most 1. Let $Y' = W/X_{t-1}$ and $Y'' = Z/X_{t-1}$, where $X_{t-1} \subseteq W, Z \subseteq X$. Then $X_{t-1} = W \cap Z$ and $W + Z = X$.

Now we consider Z . Since $X_{t-1} \subseteq Z \subseteq X$, we can construct a special filtration $(Z_i)_i$ of Z starting with the subobjects $Z_i = X_i$ with $0 \leq i \leq t-1$ (note that for $1 \leq i \leq t-1$, Z_i/Z_{i-1} is a special subobject of Z/Z_{i-1} , since Z/Z_{i-1} is a subobject of X/X_{i-1}). We complete the sequence $0 = Z_0 \subseteq \dots \subseteq Z_{t-1}$ to a special filtration of Z by taking suitable subobjects Z_i with $i \geq t$. Note that the factors Z_i/Z_{i-1} with $i \geq t$ have height 1, whereas $Z_{t-1}/Z_{t-2} = X_{t-1}/X_{t-2}$ has height at least 2.

Now we apply induction: Z has the special filtration $(Z_i)_i$ with precisely $t-1$ factors of height at least 2, therefore we have a direct decomposition $Z = Z' \oplus Z''$, with $Z_{t-1} (= X_{t-1}) \subseteq Z'$, such that Z' has a nice filtration, whereas Z'' has height at most 1.

Let $X' = Z' + W$.

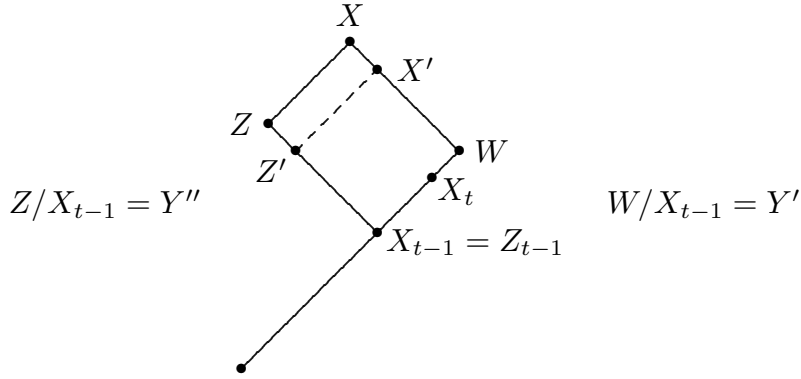

Then X' is a g-split extension of Z' by $X'/Z' \simeq W/X_{t-1} = Y'$. Now Z' has a nice filtration, and Y' is a picket of height at least 2 or an extended picket. Thus X' has a nice filtration.

On the other hand, $Z = Z' \oplus Z''$ implies that $X = X' \oplus Z''$. The decomposition $X = X' \oplus Z''$ is a decomposition as required: X' has a nice filtration, and Z'' has height at most 1. \square

The proof of Lemma yields also the following assertion:

Theorem 9. *Let X be an object without any direct summand of height 1 and without any direct summand which is a 0-picket. Then X has a g-split filtration with factors F_i , $1 \leq i \leq t$, which are pickets or extended pickets of height h_i , but not 0-pickets, such that $h_1 \geq h_2 \geq \dots \geq h_t \geq 2$.*

Proof. The proof of Lemma produces a nice filtration $(X'_i)_i$ such that $F'_i = X'_i/X'_{i-1}$ contains a special subobject of X/X'_{i-1} . The height h_i of F'_i is just the height of X/X'_{i-1} , and we have $h_i \geq h_{i+1}$ for all i .

Assume that F'_i is a 0-picket. Then the height of X/X'_{i-1} is equal to h_i . Since X/X'_i is Gorenstein-projective in $\mathcal{S}(h_i)$, we see that F'_i is a direct summand of X/X'_{i-1} . Since X'_{i-1} is a g-split subobject of X'_i , the inclusion $X'_{i-1} \rightarrow X'_i$ splits (see Lemma 2 in Section 4), thus F'_i is a direct summand of X . Since F'_i is a 0-picket, we obtain a contradiction. \square

Remark. *The factors of nice filtrations are not uniquely determined.*

The principal component $\mathcal{P}(6)$ contains a (unique) indecomposable object X with $\text{par } X = ([4, 2], [6, 4, 1, 1], [4, 2])$ (note that there is a sectional path from $S = (0, [1])$ to X of length 5).

There are two different nice filtrations of X , given by g-split exact sequences:

$$0 \rightarrow E_3^4 \rightarrow X \rightarrow E_3^2 \rightarrow 0, \quad \text{and} \quad 0 \rightarrow E_2^3 \rightarrow X \rightarrow E_4^3 \rightarrow 0.$$

Here are pictures:



This shows: *The factors of a nice filtration are not uniquely determined.*

Second part: Density.

6. BTh-vectors in $\mathbb{T}(n)$.

We are going to show Theorem 4. Note that in this section, we always will consider graded objects, thus objects in $\tilde{\mathcal{S}}(n)$. Recall that a vector $(p, r) \in \mathbb{T}(n)$ is called a BTh-vector provided there is a positive natural number a such that for any $t \in \mathbb{N}_1$, there is a \mathbb{P}^1 -family of indecomposable objects with uwb-vector (tap, tar, ta) .

Theorem 4. *Any rational pr-vector (p, r) in $\mathbb{T}(n)$ with boundary distance at least 2 is a BTh-vector.*

Our constructions of BTh-families will rely on the standard \mathbb{P}^1 -family M_c in $\tilde{\mathcal{S}}(6)$ with $VM_c = [6, 4, 2]$ and $UM_c = [4, 2]$. Namely, we will construct some larger objects which can functorially be reduced to members of the standard family. In this way, we will obtain objects which are indecomposable and pairwise non-isomorphic.

6.1. Some endofunctors of $\tilde{\mathcal{S}}(n)$. First, the endofunctor G_z of $\tilde{\mathcal{S}}(n)$ for $z \in \mathbb{Z}$. For any $z \in \mathbb{Z}$, the endofunctor G_z of $\text{mod } \tilde{Q}$ is defined for $M = (M_x, M_{x'})_{x, x'}$ in $\text{mod } \tilde{Q}$ by deleting the vector spaces with index z and z' , relabeling the remaining vector spaces as follows: for $x < z$, we define $(G_z M)_x = M_x$ and $(G_z M)_{x'} = M_{x'}$, whereas for $z \leq x$, we define $(G_z M)_x = M_{x+1}$ and $(G_z M)_{x'} = M_{(x+1)'}$; finally, we use as map $(G_z M)_{z-1} \leftarrow (G_z M)_z$ the composition $M_{z-1} \leftarrow M_z \leftarrow M_{z+1}$, and similarly as map $(G_z M)_{(z-1)'} \leftarrow (G_z M)_{z'}$ the composition $M_{(z-1)'} \leftarrow M_{z'} \leftarrow M_{(z+1)'}$.

We stress the following obvious fact: *If $G_z(M) = 0$, then $M_x = 0$ for all $x \neq z$.* In particular, if $G_z(M)$ is indecomposable, then $M = M' \oplus M''$, where M' is indecomposable and $(M'')_x = 0$ for all $x \neq z$.

Second, the endofunctor H_z of $\tilde{\mathcal{S}}(n)$ for $z \in \mathbb{Z}$. If M is a representation of \tilde{Q} , and $z \in \mathbb{Z}$, let $H_z M = M/M'$, where $M' = M_z \cap \text{soc } M$. If all the maps $M_{x'} \rightarrow M_x$ are inclusion maps (so that M is Gorenstein-projective), then $H_z M$ is Gorenstein-projective if and only if $M_{z'} \cap \text{soc } M = 0$.

6.2. Solid objects and strongly solid objects. We say that an object $X = (U, V)$ in $\tilde{\mathcal{S}}$ is *st-solid* where $s \leq t$ are integers, provided first, V is a direct sum of indecomposables of the form $[i, j]$ with $i \leq s \leq t \leq j$, second $U_i = V_i$ for $i < s$, and third, $U_j = 0$ for $t < j$. Typical examples of 34-solid objects are the objects in the standard \mathbb{P}^1 -family of $\tilde{\mathcal{S}}(6)$.

An *st-solid* object $X = (U, V)$ is said to be *strongly st-solid*, provided X is *st-solid* and the indecomposable direct summands of V are even of the form $[i, j]$ with $i < s \leq t < j$.

If $X = (U, V)$ is strongly *st-solid*, then $\text{soc } V \subseteq U \subseteq TV$, and we may form $X_- = (U/\text{soc } V, TV/\text{soc } V)$; the object X_- is *st-solid*, and we have $bX_- = bX$.

Lemma. *The construction $X \mapsto X_-$ provides an equivalence between the full subcategory of strongly st-solid objects and the full subcategory of st-solid objects; the inverse functor will be denoted by $Z \mapsto Z_+$.*

Proof. If $X = (U, V)$ and $X' = (U', V')$ are *st-solid*, and $f: X \rightarrow X'$ is a homomorphism, then by definition f can be considered as a homomorphism $V \rightarrow V'$ which maps

U into U' . Since the indecomposable direct summands of V and V' are of the form $[i, j]$ with $i \leq s \leq j$, we have $f = 0$ if and only if $f_s = 0$.

Now, let $X = (U, V)$ and $X' = (U', V')$ be strongly st -solid, and $f: X \rightarrow X'$ a homomorphism. Then f maps $\text{soc } V$ into $\text{soc } V'$ and TV into TV' , thus it yields a map $f^-: X^- \rightarrow (X')^-$. Assume that $f^- = 0$. Then $f_s = (f^-)_s = 0$, thus $f = 0$.

For any st -solid object $X = (U, V)$ we have to construct an st -solid object X_+^+ with $(X_+^+)^- = X$. We write the global space V of X as the direct sum of indecomposable objects: they are of the form $[i, j]$ with $i \leq s \leq t \leq j$. Note that $[i, j]$ is in a unique way a subquotient of $[i-1, j+1]$. The direct sum V_+^+ of the corresponding objects $[i-1, j+1]$ will be the global space of X_+^+ . In this way, we have $(V_+^+)_a = V_a$ for $s \leq a \leq t$, thus we may consider for $s \leq a \leq t$ the subspace U_a as a subspace of $(V_+^+)_a$. We take as $U(X_+^+)$ the space $\bigoplus_{s \leq a \leq t} U_a \oplus \bigoplus_{a' < s} (V_+^+)_{a'}$. Clearly, if $X = (U, V)$ and $X' = (U', V')$ are st -solid, any homomorphism $f: X \rightarrow X'$ can be extended in a unique way to a homomorphism $f_+^+: X_+^+ \rightarrow (X')_+^+$. \square

6.3. Expansions and coexpansions of solid Kronecker families.

Proposition. *Let $M = M_c$ be a solid Kronecker family in $\tilde{\mathcal{S}}(n)$, and let $0 \leq e, f \leq \ell \cdot bM$ be integers. Then there is a \mathbb{P}^1 -family of indecomposable and pairwise non-isomorphic solid objects $M_c[\ell; e, f]$ in $\tilde{\mathcal{S}}(n+2)$ with wub -vector $(\ell \cdot uM + e, \ell \cdot wM + f, \ell \cdot bM)$. The objects $M_c[\ell; 0, f]$ and $M_c[\ell; e, 0]$ belong to $\tilde{\mathcal{S}}(n+1)$.*

Note that $\mathbf{pr} M_c[\ell; e, f] = (pM + \frac{e}{\ell \cdot bM}, rM + \frac{f}{\ell \cdot bM})$.

Corollary. *Let $M = M_c$ be a solid Kronecker family in $\tilde{\mathcal{S}}(n)$. Let $0 \leq e, f \leq \ell \cdot bM$. Then $(pM + \frac{e}{\ell \cdot bM}, rM + \frac{f}{\ell \cdot bM})$ is a BTh -vector in $\mathbb{T}(n+2)$ and $(pM + \frac{e}{\ell \cdot bM}, rM)$ and $(pM, rM + \frac{f}{\ell \cdot bM})$ are BTh -vectors in $\mathbb{T}(n+1)$.*

The \mathbf{pr} -vectors which we obtain in this way are the vectors in the convex hull of $(p, r) = \mathbf{pr} M$, $(p, r+1)$, $(p+1, r+1)$, and $(p+1, r)$.

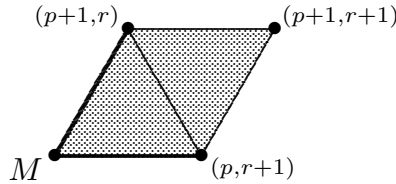

We will show in Section 6.6 that the corollary implies Theorem 4 for $n \geq 8$, using the symmetries of $\mathbb{T}(n)$. As we will see in Section 8.5, the corollary also yields Theorem 10 which concerns \mathbf{pr} -vectors with boundary distance between 1 and 2.

Remark. If (U, V) is an object and $(U \subseteq V' \subseteq V)$ with $bV' = bV$, then we say that (U, V) is an *expansion* of (U, V') . Note that we have $p(U, V') = p(U, V)$ and $r(U, V') \leq r(U, V)$ (looking at an expansion, we keep the subspace and its level, but increase the factor space $W = V/U$ and the colevel).

The dual concept is that of a coexpansion: here we increase the subspace and its level, but keep the factor space W and its colevel: Here, let (U, V) be an object and $U' \subseteq U$ a subspace. If $b(V/U') = bV$, then (U, V) will be called a *coexpansion of $(U/U', V/U')$* .

The objects constructed in the proof of the proposition will be expansions and coexpansions of the given Kronecker family.

For the proof of Proposition, we start with an *st*-solid Kronecker family $M = M_c$, say given by a Kronecker pair X, Y . Then $N = M_+^+$ is a strongly solid Kronecker family, given by the Kronecker pair X_+^+, Y_+^+ . The construction of N shows that M can be recovered from N in the following way: Let $U = U(N), V = V(N)$. We define $\text{soc } N$ to be the object $(\text{soc } V, \text{soc } V)$. Then there is a canonical embedding $M \rightarrow N/\text{soc } N$ with image $(U, TV)/\text{soc } N$ (thus, $M = (U/\text{soc } V, TV/\text{soc } V)$).

Now we are going to consider subquotients of the form N'/N'' , where $N'' \subseteq \text{soc } N$ and where N' is a subobject of N which contains (U, TV) .

For $i > t$ we call a subobject $N' = (U, V')$ of $N = (U, V)$ *i-admissible* provided

$$TV \subseteq V' \subseteq V, \quad V_j \subseteq V' \quad \text{for } j > i, \quad \text{and} \quad V_j' \subseteq TV \quad \text{for } j < i.$$

In this case we also call the subspace V' of V *i-admissible*.

Lemma. *A subspace V' of V is admissible for some $i > t$ provided V' is comparable with the following filtration of V .* \square

$$TV \subseteq TV + V_{n+1} \subseteq TV + V_{n+1} + V_n \subseteq \cdots \subseteq TV + V_{n+1} + \cdots + V_t = V.$$

Since the index of TV in V is equal to bV , we see: *For any natural number f with $0 \leq f \leq bV$, there is an admissible subspace V' of V with dimension $\dim V - bV + f$.*

Lemma. *If N' is i-admissible, then the inclusion $M \rightarrow N/\text{soc } N$ induces an isomorphism $M \rightarrow G_i(N')/\text{soc } N$.* \square

Dually, for $i < s$ we define a subobject $N'' = (V'', V'')$ of N to be *i-coadmissible* if

$$V'' \subset \text{soc } V, \quad (\text{soc } V)_j \subset V'' \quad \text{for } j > i, \quad \text{and} \quad V_j'' = 0 \quad \text{for } j < i.$$

In this case, the subspace V'' of V is also called *i-coadmissible*.

Lemma. *A subspace V'' of V is i-coadmissible for some $i < s$ provided V'' is comparable with the following filtration of $\text{soc } V$.* \square

$$0 \subset \text{soc } V \cap V_{s-1} \subset \text{soc } V \cap (V_{s-1} + V_{s-2}) \subset \cdots \subset \text{soc } V \cap (V_{s-1} + V_{s-2} + \cdots + V_0) = \text{soc } V$$

Since $\dim \text{soc } V = bV$, for any natural number e with $0 \leq e \leq bV$ there is a coadmissible subspace V'' of V of dimension $bV - e$.

Lemma. *If N'' is i-coadmissible, then the canonical map $TN \rightarrow M$ induces an isomorphism $G_i(TN/N'')[1] \rightarrow M$.* \square

Proof of Proposition. We start with $M = M_c$, we form M_+^+ . In this way, we obtain a Kronecker family and we consider the corresponding extensions $N = M_+^+[\ell]$ with ℓ factors isomorphic to M_+^+ . We have $bN = \ell \cdot bM$. Recall that we denoted the subobject $(\text{soc } V, \text{soc } V)$ by $\text{soc } N$. Correspondingly, let $TN = (U, TV)$.

In addition, there are given integers $0 \leq e, f \leq \ell \cdot bM$. The previous considerations show that there are submodules N', N'' of N with

$$0 \subseteq N'' \subseteq \text{soc } N \subset TN \subseteq N' \subseteq N$$

such that N' is i -admissible for some $i > t$, and N'' is j -coadmissible for some $j < s$, and such that $\text{soc } N/N''$ has dimension e , whereas N'/TN has dimension f .

Using the functors first G_i , then G_j , we see that the objects N'/N'' are indecomposable and (in reference to the parameter c) pairwise non-isomorphic. This completes the proof. \square

6.4. A triangle, for $n = 7$.

Here, $n = 7$. We want to construct a BTh-family for any rational vertex in the triangle with corners $(7/3, 8/3)$, $(2, 2)$, $(8/3, 7/3)$ (see the illustration at the end of Section 6.5).

We start with the $Q[1, 7]$ -modules $D = D_c$ with dimension vector $\begin{smallmatrix} 1 & 2 & 2 & 2 & 1 \\ 1 & 2 & 3 & 4 & 3 & 2 & 1 \end{smallmatrix}$; say with global space generated by x_1, x_2, x_3, x_4 in degrees 7, 6, 5, 4, and with Λx_i of length 7, 5, 3, 1, respectively; with subspace generated by $T^2x_1 + c_0Tx_2 + c_1x_3$ and $T^2x_2 + Tx_3 + x_4$; here $c = (c_0 : c_1) \in \mathbb{P}^1(k)$. It is the Kronecker family for the Kronecker subcategory of $\tilde{\mathcal{S}}$ given by the following Kronecker pair X, Y :

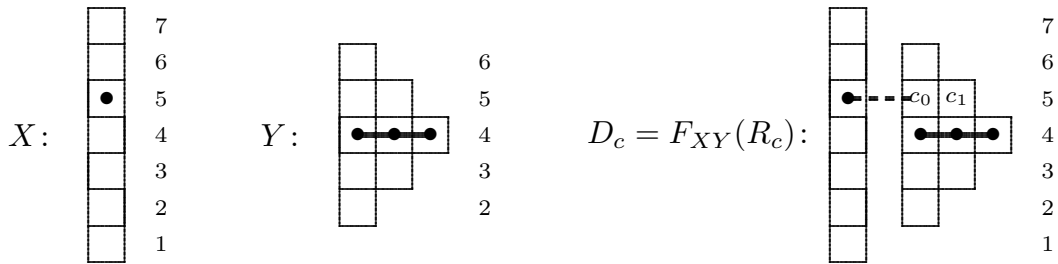

Thus we deal with the following modules D shown in the middle:

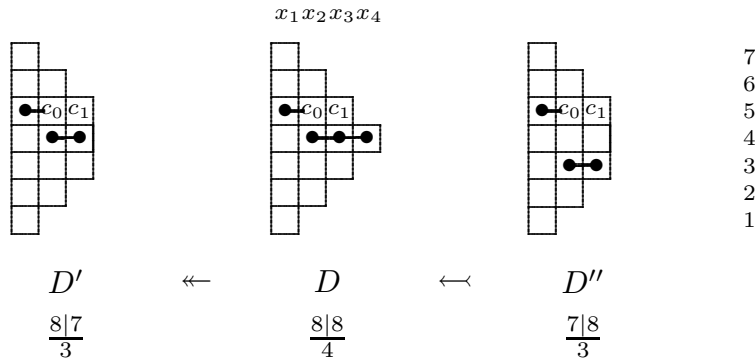

There is the factor module D' of D , it is shown on the left (the kernel of $D \rightarrow D'$ is generated by $x_4 \in VD$ and is of the form S_4). And there is the submodule D'' of D , with $V(D'')$ generated by the elements x_1, x_2, x_3 of VD ; it is shown on the right (note that D/D'' is of the form \overline{S}_4 , with global space generated by the residue class of x_4). We have added the uwb-vectors of D', D, D'' .

Since D_c is a Kronecker family, there are given the \mathbb{P}^1 -families $D[\ell]$ for all $\ell \in \mathbb{N}_1$. Let d', d, d'' be natural numbers (not all zero). We start with the self-extension $B = D[d' + d + d'']$ using $d' + d + d''$ copies of D . Let B' be the submodule of B generated by the first d' copies of x_4 . Let B'' be the submodule of B generated by all copies of x_1, x_2, x_3 and the first $d' + d$ copies of x_4 , thus $B' \subseteq B'' \subseteq B$. The module we are interested in is B''/B' . By construction, it has a filtration, going upwards, with first d' copies of D' , then d copies of D , and finally, d'' copies of D'' , thus its uwb-vector is

$$\mathbf{uwb} B''/B' = d'(8, 7, 3) + d(8, 8, 4) + d''(7, 8, 3).$$

We use the functor G_4 introduced in 6.1. The functor G_4 sends all three objects D', D and D'' to M_c ; it sends $D[d' + d + d'']$ and also B''/B' to $M_c[d' + d + d'']$. The functor G_4 shows that all the modules B''/B' are indecomposable, and also, for pairwise different elements $c \in \mathbb{P}^1(k)$, pairwise non-isomorphic. This shows that we obtain a BTh-family B''/B' .

6.5. The trapezoid T in $\mathbb{T}(7)$.

We start with the $Q[1, 7]$ -modules $E = E_c$ with dimension vector $\begin{matrix} 1 & 2 & 3 & 2 & 1 \\ 1 & 2 & 3 & 4 & 3 & 2 & 1 \end{matrix}$; say with global space generated by x_1, x_2, x_3, x_4 in degrees 7, 6, 5, 4, and with Λx_i of length 7, 5, 3, 1, respectively; with subspace generated by $T^2x_1 + c_0Tx_2 + c_1x_3, T^2x_2 + Tx_3 + x_4$; and T^2x_3 here $c = (c_0 : c_1) \in \mathbb{P}^1(k)$. It is the Kronecker family for the Kronecker subcategory of \mathcal{S} given by the following Kronecker pair X, Y' :

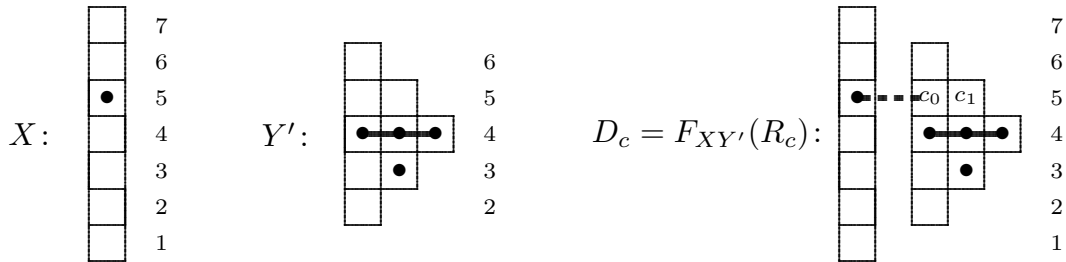

We consider also the submodule D of E :

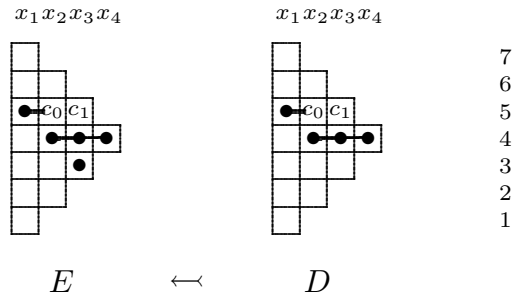

Note that we have $D_{4'} \cap \text{soc } D = 0$ and $E_{4'} \cap \text{soc } E = 0$, thus the modules $D' = H_4 D$ and $E' = H_4 E$ are again Gorenstein-projective.

We look at the trapezoid T with corners D, D', E', E .

Using the canonical embedding $\mu: D \rightarrow E$, we can interpolate between D and E by looking at extensions induced by the extension $E[d+e]$, where d, e are non-negative integers, namely

$$\begin{array}{ccccccc} 0 & \longrightarrow & E[e] & \longrightarrow & E[e] \setminus D[d] & \longrightarrow & D[d] \longrightarrow 0, \\ & & \parallel & & \downarrow & & \downarrow \mu[d] \\ 0 & \longrightarrow & E[e] & \longrightarrow & E[d+e] & \longrightarrow & E[d] \longrightarrow 0. \end{array}$$

Then we can factor out from $E[e] \setminus D[d]$ copies of x_4 , say f copies, where $0 \leq f \leq d+e$. In this way, we obtain an object B with pr-vector inside the trapezoid T (it lies on the line which connects $(0, 1)$ with the pr-vector of $E[e] \setminus D[d]$; but for $f > 0$, the pr-vector obtained will lie outside of this interval).

Note that *any pr-vector inside the trapezoid T is obtained in this way!* Let us outline how we find numbers d, e, f , when we start with a pr-vector (p, r) in the trapezoid T . Recall that our aim is to find modules M with pr-vector (p, r) thus the uwb-vector of M has to be of the form

$$d \frac{u|w}{b} D' + e \frac{u|w}{b} E' + f' \frac{u|w}{b} S_4$$

for some non-negative integers d, e, f' , therefore equal to

$$\begin{aligned} d \frac{8|7}{3} + e \frac{9|6}{3} + f' \frac{0|1}{1} &= \frac{8d + 9e | 7d + 6e + f'}{3d + 3e + f'} \\ &= d \frac{8|8}{4} + e \frac{9|7}{4} - (d + e - f') \frac{0|1}{1} \\ &= d \frac{u|w}{b} D + e \frac{u|w}{b} E - (d + e - f') \frac{u|w}{b} S_4. \end{aligned}$$

If (p, r) belongs to the triangle with corners S_4, D, E , then it lies on the segment D, E . As a consequence, we see that $f = d + e - f'$ cannot be negative. Also, $d + e - f = f' \geq 0$ shows that $f \leq d + e$, thus, altogether we have $0 \leq f \leq d + e$. This provides the required non-negative numbers d, e, f (and not all can be zero).

It remains to be shown that all the modules $B = B_c$ obtained from $E[e] \setminus D[d] = E_c[e] \setminus D_c[d]$ by factoring out copies of x_4 are indecomposable and for different c non-isomorphic. We use the functor G_z and H_z defined in 6.1.

The functor $G_3 H_4$ sends both objects D, E to M_c ; it sends $D[d+e], E[e] \setminus D[d], E[d+e]$, but also any B (obtained from $E[e] \setminus D[d]$ by factoring out copies of x_4) to $M_c[d+e]$. In this way, the functor $G_3 H_4$ shows that all the modules B are indecomposable, and also, for pairwise different elements $c \in \mathbb{P}^1(k)$, pairwise non-isomorphic, This shows that we obtain a BTh-family.

Altogether, we obtain BTh-families inside the trapezoid T with corners $D, D' = H_4D, E' = H_4E, E$.

Let us present in $\mathbb{T}(7)$ the triangle with corners $D, D' = H_4D, D''$ as well as the trapezoid T with corners $D, D' = H_4D, E' = H_4E, E$.

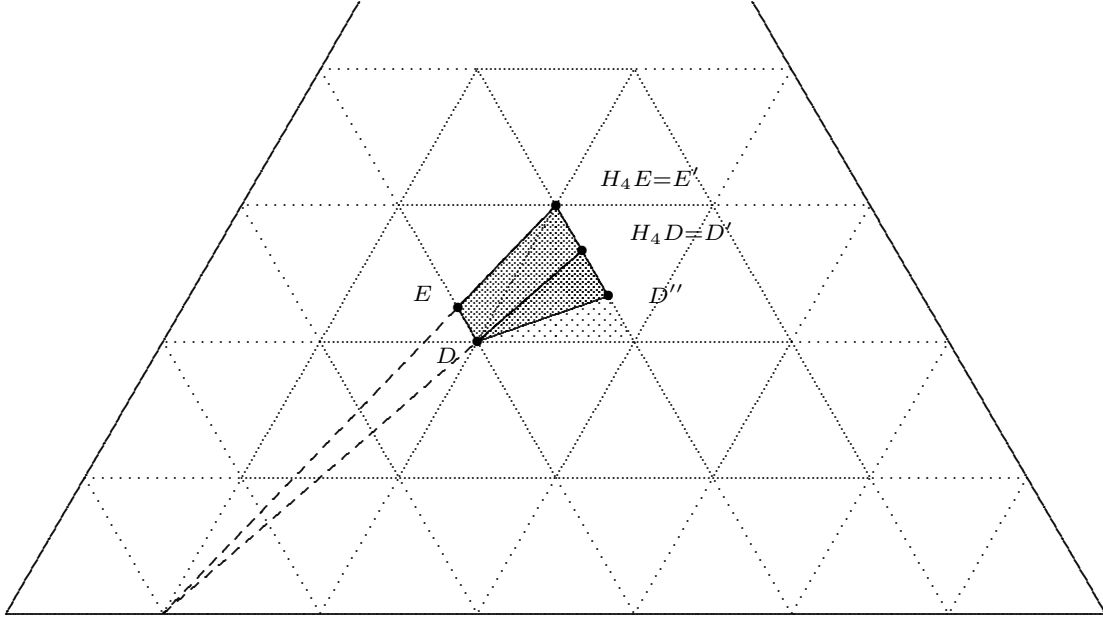

6.6. Proof of Theorem 4.

We are going to use the previous results in order to prove Theorem 4. As we will see, we only have to invoke the symmetries for $\mathbb{T}(m)$, with $m \leq n$.

First, let $n = 7$. In 6.5, we have found a trapezoid of BTh-vectors. Using duality, we see that also the reflected trapezoid consists of BTh-vectors. These two trapezoids, together with the triangle exhibited in 6.4, provide BTh-vectors with boundary distance at least 2.

Next, $n = 8$. According to Corollary 6.3, we have BTh-vectors inside the parallelogram given by $(2, 2), (3, 2), (3, 3), (2, 3)$. The rotation ρ shows that all vectors with boundary distance at least 2 are BTh-vectors.

Finally, for $n \geq 9$, we use induction on n . As we have shown already, if $n = 8$, any pr-vector in $\mathbb{T}(n)$ with boundary distance at least 2, is a BTh-vector. Thus, let $n \geq 9$. By induction, any pr-vector in $\mathbb{T}(n - 1)$ with boundary distance at least 2, is a BTh-vector. If we deal with a vector \mathbf{x} in $\mathbb{T}(n)$, then its image under ρ or ρ^2 will belong to $\mathbb{T}(n - 1)$. Since $\rho(\mathbf{x})$ or $\rho^2(\mathbf{x})$ is a BTh-vector, also \mathbf{x} itself is a BTh-vector. \square

6.7. Remark.

Let us look again at $\mathbb{T}(7)$. Starting with 6.2 and 6.3 and using duality and rotation, we cover the following shaded region which includes properly the triangle of all pr-vectors of boundary distance at least 2).

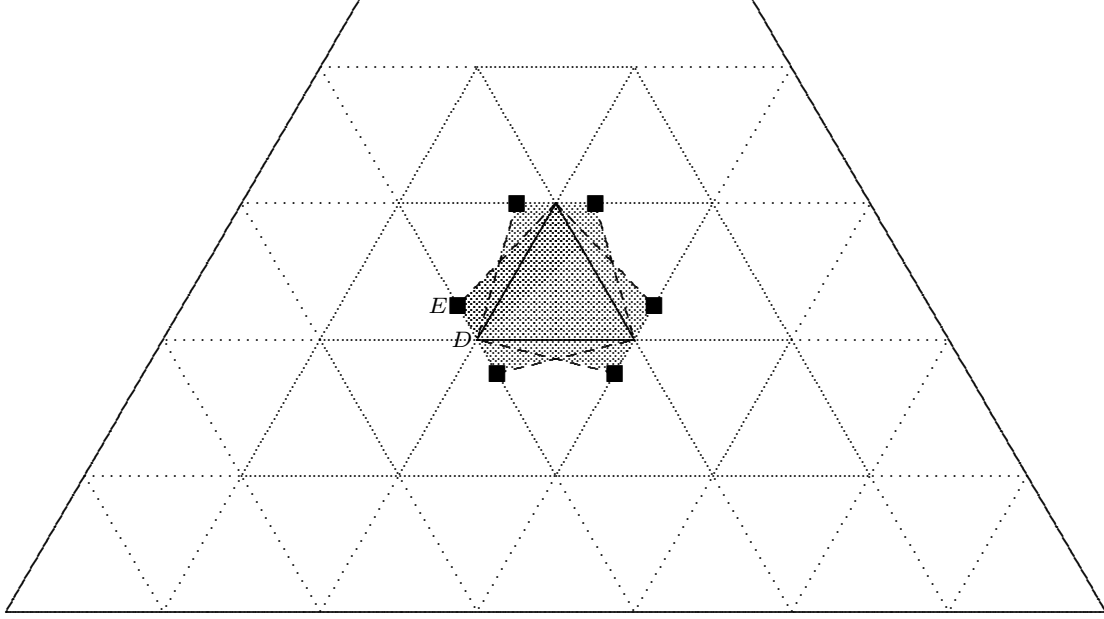

7. Objects with level 1.

Here we want to consider some examples of objects in $\mathcal{S}(n)$ with level 1.

7.1. Objects without direct summand which are 0-pickets.

We return to the assertion of Proposition in Section 4.

Proposition. *Let X be a non-zero object in \mathcal{S} which has no direct summand which is a 0-picket. Then the following assertions hold:*

- (a) $pX \geq 1$.
- (a') $uX \geq bX$.
- (b) All factors F_i of any telescope filtration satisfy $pF_i \geq 1$.
- (b') All factors F_i of any telescope filtration satisfy $uF_i \geq 1$.
- (b'') No factor of a telescope filtration of X is a 0-picket.

Proof. If X is non-zero, the assertions (a) and (a') are obviously equivalent, as are the assertions (b), (b') and (b''). Thus, assume now that X is non-zero and has no direct summand which is a 0-picket. According to Proposition in Section 4, the assertion (b') holds true. Finally, we show that (b') implies (a'): the telescope filtration $(F_i)_i$ has bX factors, thus, if (b') is satisfied, then $uX = \sum_{i=1}^{bX} uF_i \geq bX$. \square

(Actually, our interest in the level of the indecomposable objects in \mathcal{S} started with this observation!)

There is the following consequence:

Corollary. *Let X be a non-zero object in \mathcal{S} which has no direct summand which is a 0-picket. Then the following assertions are equivalent:*

- (i) $pX = 1$.

- (ii) All factors F_i of any telescope filtration satisfy $pF_i = 1$.
- (iii) There exists a telescope filtration whose factors F_i satisfy $pF_i = 1$.

Remark. Two examples. Let us look at objects X in \mathcal{S} which have a filtration whose factors are level 1 pickets. Here are two examples which one should have in mind. First, there is the exact sequence

$$0 \rightarrow ([1], [1]) \rightarrow ([2], [3]) \rightarrow ([1], [2]) \rightarrow 0$$

which shows that we may have $pX > 1$. Of course, the sequence is not g-split.

Second there is an exact sequence

$$0 \rightarrow ([1], [2]) \rightarrow ([2], [2]) \oplus (0, [1]) \rightarrow ([1], [1]) \rightarrow 0$$

(mentioned already in Section 4). This sequence is g-split. The middle term X has a direct summand which is a 0-picket.

7.2. The indecomposable objects $X = (U, V)$ with $bU = 1 = pX$. We say that a partition $(\lambda_1, \dots, \lambda_b)$ is *strongly decreasing*, provided $\lambda_i - \lambda_{i+1} \geq 2$ for $1 \leq i < b$.

Proposition. *There is a bijection between, on the one hand, the isomorphism classes of the indecomposable objects $X = (U, V)$ in $\mathcal{S}(n)$ with $pX = 1$ and $bU = 1$, and, on the other hand, the strongly decreasing partitions bounded by n , by sending $X = (U, V)$ to $[V]$.*

If X corresponds under this bijection to the partition λ , we write $X = C_\lambda$.

Proof. Let $X = (U, V)$ be indecomposable in $\mathcal{S}(n)$ with $bU = 1$. We decompose $V = \bigoplus_{i=1}^b V_i$ with all V_i indecomposable in $\mathcal{N}(n)$. Let $|V_i| = \lambda_i$, and we can assume that $\lambda_1 \geq \lambda_2 \geq \dots \geq \lambda_b$. Using the projection maps $V \rightarrow V_i$, the embedding $u: U \rightarrow V$ yields (non-zero) maps $u_i: U \rightarrow V_i$. Since $bU = 1$, the Λ -module U is generated by an element x . For any i , we can choose a generator $y_i \in V_i$ such that $u_i(x) = T^{m_i}y_i$, with $0 \leq m_i < \lambda_i$.

Looking at the map $U \rightarrow V_i \oplus V_{i+1}$, we see that we must have $m_i > m_{i+1}$ and $\lambda_i - m_i > \lambda_{i+1} - m_{i+1}$, otherwise X will be decomposable. In particular, it follows that the sequence $(\lambda_1, \lambda_2, \dots, \lambda_b)$ has to be strongly decreasing.

Since u is injective, u_1 has to be injective, thus U has length $\lambda_1 - m_1$ and there is the sequence

$$(*) \quad |U| = \lambda_1 - m_1 > \lambda_2 - m_2 > \dots > \lambda_b - m_b \geq 1.$$

Now, let us assume, in addition, that $pX = 1$, thus $b = bV = |U|$. The sequence $(*)$ is strictly decreasing, starts with b , and has b terms, thus it has to be the sequence $b, b-1, b-2, \dots, 2, 1$. Thus $\lambda_i - m_i = b - i + 1$. But this means that $m_i = \lambda_i - b + i - 1$, thus m_i is determined by the partition λ .

Conversely, starting with a strongly decreasing partition λ , let $m_i = \lambda_i - b + i - 1$. Let V_i be the indecomposable Λ -module of length λ_i generated by an element x_i . Let V be the direct sum of the Λ -modules V_i . Let U be the submodule of V generated

by $(T^{m_1}x_1, \dots, T^{m_b}x_b)$. Then, clearly, $X = (U, V)$ is indecomposable. By construction, $bU = 1$ and $|U| = b = bV$, thus also $pX = 1$. \square

As an example, consider the partition $(7, 4, 2)$. The object $C_{(7,4,2)}$ may be visualized as follows:

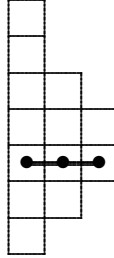

(Of course, the object E_2^2 mentioned already in the introduction, the only indecomposable object of $\mathcal{S}(3)$ which is not a picket, has to be mentioned here: we have $E_2^2 = C_{(3,1)}$).

In general, if X is indecomposable in \mathcal{S} and $U(X)$ belongs to $\mathcal{N}(2)$, then X is a picket or a bipicket, see [S1, Proposition 3.4]. This shows that *an indecomposable object $X = (U, V)$ with $bX \leq 3$ and $pX = 1$ satisfies $bU = 1$.*

For $n \leq 5$, all indecomposable objects X in $\mathcal{S}(n)$ with $pX = 1$ are of the form C_λ . In $\mathcal{S}(6)$, there is an indecomposable object Y with $pY = 1$ and $bY = 4$, which we will present now.

7.3. Here is an example of an indecomposable object $Y = (U, V)$ with $pY = 1$ and $bU > 1$. It belongs to $\mathcal{S}(6)$ and has $pY = 1$ and $bY = 4$. Note that an indecomposable object $Y \in \mathcal{S}$ with $pY = 1 = bU$ and $bY = 4$ has height at least 7.

Example. *The indecomposable object $Y \in \mathcal{S}(6)$ with $pY = 1$, and $bY = 4$.*

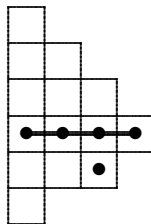

We may consider Y as a g-split extension of $C_{(3)}$ by $C_{(6,4,1)}$. In general, for any $c \in k$, there is the following g-split extension of $C_{(3)}$ by $C_{(6,4,1)}$:

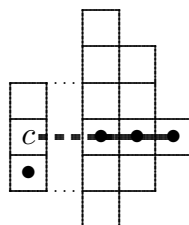

To be precise, we consider $X_c = (U, V)$, with V being the direct sum of Λ -modules Λx_i , where $0 \leq i \leq 3$; with $|\Lambda x_i|$ equal to 3, 6, 4, 1 for $i = 0, \dots, 3$, and with U being generated by the elements

$$u_1 = T^2 x_0, \quad u_2 = cT x_0 + T^3 x_1 + T^2 x_2 + x_3,$$

with $c \in k$. Note that $X_1 = Y$. We have $X_0 = C_{(3)} \oplus C_{(6,4,1)}$, whereas, all objects X_c with $c \neq 0$ are isomorphic (thus isomorphic to Y).

7.4. Examples. A \mathbb{P}^1 -family of indecomposable objects X in $\mathcal{S}(9)$ with $pX = 1$.

Similar to the previous object, let us now look at the following g-split extensions of $C_{(6,3)}$ by $C_{(9,7,4,1)}$

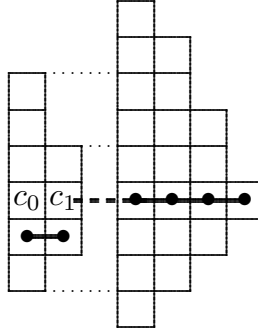

To be precise, we consider $X = (U, V)$, with V being the direct sum of Λ -modules Λx_i , where $0 \leq i \leq 5$; with $|\Lambda x_i|$ equal to 6, 3, 9, 7, 4, 1 for $i = 0, \dots, 5$, and with U being generated by the elements

$$u_1 = T^4 x_0 + T^2 x_1, \quad u_2 = c_0 T^3 x_0 + c_1 T x_1 + T^5 x_2 + T^4 x_3 + T^2 x_4 + x_5,$$

with $c = (c_0, c_1) \in k^2$. The object $X = X_c$ turns out to be indecomposable if and only if $c \neq 0$. And indecomposable objects $X_c, X_{c'}$ are isomorphic if and only if c and c' are multiples of each other (thus we obtain a \mathbb{P}^1 -family of indecomposable objects indexed by the projective line $\mathbb{P}^1(k)$).

For any $c \in k^2$, we have $|U| = 6$ and $bV = 6$, thus $pX = 1$.

For dealing with this example, we use the quiver $Q[1, 9]$ as introduced in Section 2.3. There are indecomposable representations \tilde{Y}, \tilde{Z} of $Q[1, 9]$ with dimension vector

$$\dim \tilde{Y} = \begin{pmatrix} 0 & 1 & 1 & 0 & 0 & 0 & 0 & 0 & 0 \\ 0 & 1 & 2 & 2 & 2 & 1 & 1 & 0 & 0 \end{pmatrix}, \quad \dim \tilde{Z} = \begin{pmatrix} 1 & 1 & 1 & 1 & 0 & 0 & 0 & 0 & 0 \\ 1 & 2 & 3 & 4 & 3 & 3 & 2 & 2 & 1 \end{pmatrix},$$

and \tilde{Y} is sent under π to $C_{(6,3)}$, whereas \tilde{Z} is sent to $C_{(9,7,4,1)}$. One has to verify that \tilde{Y} and \tilde{Z} is an orthogonal pair with $\dim_k \text{Ext}^1(\tilde{Z}, \tilde{Y}) = 2$.

Let \mathcal{C} be the full subcategory of all representations of $Q[1, 9]$ which have a submodule which is isomorphic to a direct sum of copies of \tilde{Y} , such that the factor module is isomorphic to a direct sum of copies of \tilde{Z} . The category \mathcal{C} is a length category which is equivalent to the category of Kronecker modules. Thus, in \mathcal{C} we find a \mathbb{P}^1 -family of indecomposable objects \tilde{X}_c , indexed by $c \in \mathbb{P}^1(k)$, such that \tilde{X}_c has a submodule of the form \tilde{Y} , with factor module of the form \tilde{Z} .

Since \tilde{Y} is sent under π to $C_{(6,3)}$ and \tilde{Z} to $C_{(9,7,4,1)}$, the modules \tilde{X}_c are sent under π to objects in $\mathcal{S}(9)$ which are g-split extensions of $C_{(6,3)}$ by $C_{(9,7,4,1)}$: these are the required objects X_c . \square

7.5. Wildness. An example. *There is a \mathbb{P}^2 -family of indecomposable objects $X = (U, V)$ in $\mathcal{S}(12)$ with $|U| = [5, 3]$, $|V| = [12, 10, 9, 7, 6, 4, 3, 1]$, therefore $|U| = 8$, $bV = 8$ and $pX = 1$.*

Here is the picture: We deal with g-split extensions of $C_{(9,6,3)}$ by $C_{(12,10,7,4,1)}$:

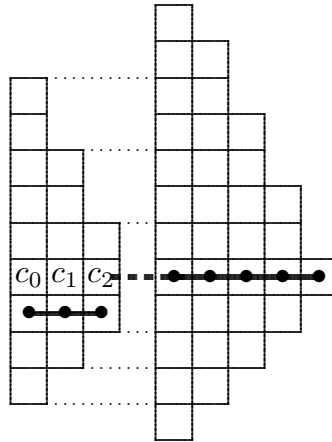

The proof is similar to the proof for the Examples 3. This time, we start with the fully commutative quiver $Q[1, 12]$, and with representations \tilde{Y} , \tilde{Z} of $Q[1, 12]$ such that the pushdown functor sends \tilde{Y} to $C_{(9,6,3)}$ and \tilde{Z} to $C_{(12,10,7,4,1)}$. Again, we have to show that \tilde{Y} and \tilde{Z} is an orthogonal pair, but now we need that $\dim_k \text{Ext}^1(\tilde{Z}, \tilde{Y}) = 3$. \square

8. Further examples of BTh-vectors (with boundary distance $1 < d < 2$).

We have seen in Section 6, that all vectors in $\mathbb{T}(n)$ with boundary distance at least 2 are BTh-vectors. In Section 7, we have found a BTh-vector in $\mathbb{T}(9)$ with boundary distance 1. Here we look at the cases $n = 7$ and $n = 8$ and exhibit some BTh-vectors with boundary distance greater than 1 and smaller than 2.

8.1. For $n = 7$, the uwb-vector $\frac{6|10}{4}$. It is given by the Kronecker pair shown on the left.

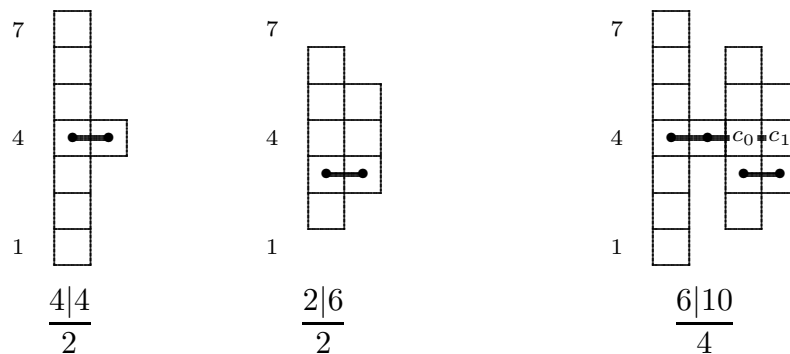

and the $\tilde{\mathcal{S}}_3(7)$ -family M_c is given by the modules M_c with proper inclusions

$$Y \subset M_c \subset Z.$$

Remark. As we have mentioned, X does not lie in $\tilde{\mathcal{S}}(7)$, thus \mathcal{C}' does not lie inside $\tilde{\mathcal{S}}(7)$; but all objects in \mathcal{C}' without a direct summand of the form X lie inside $\tilde{\mathcal{S}}(7)$; this is the shaded part in the picture.

8.3. A BTh-family in $\tilde{\mathcal{S}}(8)$ with uwb-vector $\frac{6|17}{5}$, again given by a Kronecker pair.

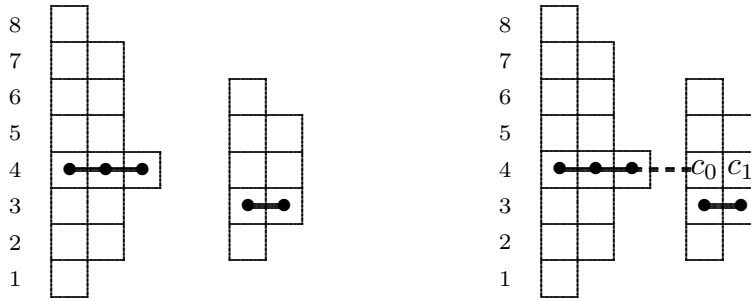

The uwb-vector is $\frac{6|17}{5}$.

8.4. Interpolation between $\frac{6|17}{5}$ and $\frac{6|16}{4}$,

We start with the family D given in 8.3 (with uwb-vector $\frac{6|17}{5}$) and form $D' = H_4 D$ (with uwb-vector $\frac{6|16}{4}$).

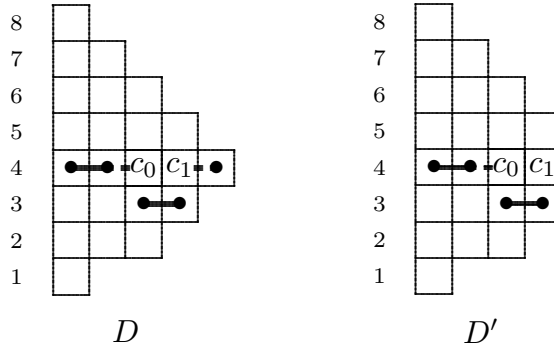

We should mention that we may obtain D' also from the BTh-family constructed in 8.1 by applying duality and the rotation $\rho = \tau_8^2$ in $\mathbb{T}(8)$.

In order to obtain a BTh-family with uwb-vector $d\frac{6|17}{5} + e\frac{6|16}{4}$, we form the Jordan extension $D[d + e]$ and factor out e copies of S_4 (similar to our procedure in Sections 6.3 and 6.4).

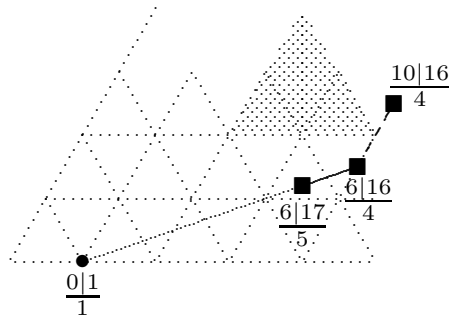

8.5. The following Theorem 10 provides BTh-vectors with arbitrary boundary distance between 1 and 2.

Theorem 10. *Let $n = 10$. Any rational pr -vector (p, r) in $\mathbb{T}(n)$ which belongs to one of the intervals between $(1, 4)$ and $(1, 5)$, or between $(1, 4)$ and $(2, 4)$, or between $(1, 5)$ and $(2, 4)$ is a BTh-vector.*

Let $n \geq 11$. Any rational pr -vector (p, r) in $\mathbb{T}(n)$ which belongs to the convex hull of $(1, 4)$, $(1, n - 5)$, $(2, n - 6)$, $(2, 4)$, is a BTh-vector.

Here is the case $n = 10$.

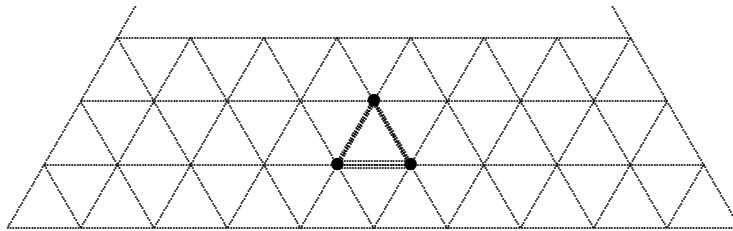

And the case $n = 12$.

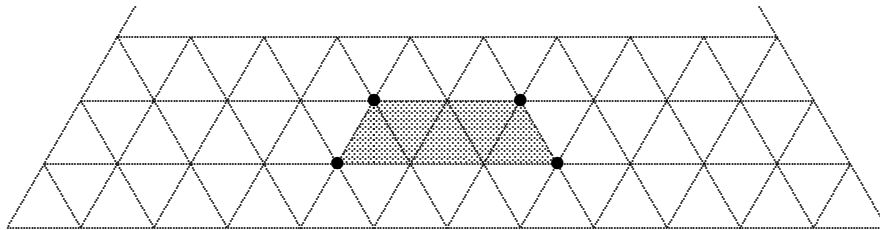

Proof of Theorem 10. We use expansion and coexpansion as in 6.3 but now based on the Kronecker families in 7.4 and in 8.1. Our goal is to construct the convex regions of BTh-vectors in $\mathbb{T}(n)$ for $n \geq 10$ claimed to exist in Theorem 10. However, the families mentioned are not st-solid, so the regions obtained will be somewhat smaller, compared to Corollary 6.3.

More precisely, both families $M = M_c$ with $M = (U, V) \in \tilde{\mathcal{S}}$ are *almost* 44-solid in the sense that V is a direct sum of indecomposables of the form $[i, j]$ with $i \leq 4 \leq j$ and $U_i = 0$ holds for $i > 4$. But the condition $U_i = V_i$ is only satisfied for $i \leq 1$ and $i \leq 2$ for the families in 7.4 and 8.1, respectively.

As a consequence, expansions as in 6.3 are possible, but for coexpansions the range of the parameter e is limited.

Lemma.

(a) Let $M = M_c$ be the Kronecker family in $\tilde{\mathcal{S}}(7)$ presented in 8.1, it satisfies $pM = \frac{3}{2}$, $rM = \frac{5}{2}$ and $bM = 4$. Let $0 \leq e \leq \frac{1}{2}\ell \cdot bM$ and $0 \leq f \leq \ell \cdot bM$. Then $(pM + \frac{e}{\ell \cdot bM}, rM + \frac{f}{\ell \cdot bM})$ is a BTh-vector in $\mathbb{T}(9)$ and $(pM + \frac{e}{\ell \cdot bM}, rM)$ and $(pM, rM + \frac{f}{\ell \cdot bM})$ are BTh-vectors in $\mathbb{T}(8)$.

(b) Let $M = M_c$ be the Kronecker family in $\tilde{\mathcal{S}}(9)$ presented in 7.4 with $pM = 1$, $rM = 4$ and $bM = 6$. Let $0 \leq e \leq \frac{1}{2}\ell \cdot bM$ and $0 \leq f \leq \ell \cdot bM$. Then $(pM + \frac{e}{\ell \cdot bM}, rM + \frac{f}{\ell \cdot bM})$ is a BTh-vector in $\mathbb{T}(11)$ and $(pM + \frac{e}{\ell \cdot bM}, rM)$ and $(pM, rM + \frac{f}{\ell \cdot bM})$ are BTh-vectors in $\mathbb{T}(10)$.

The pr-vectors which we obtain in this way are the vectors in the following region which we picture in the case $n = 12$. It is the union of the convex region bounded by $(\frac{3}{2}, \frac{5}{2}), (2, \frac{5}{2}), (2, \frac{7}{2}), (\frac{3}{2}, \frac{7}{2})$, given by Part (a), and the convex region bounded by $(1, 4), (\frac{3}{2}, 4), (\frac{3}{2}, 5), (1, 5)$, given by Part (b).

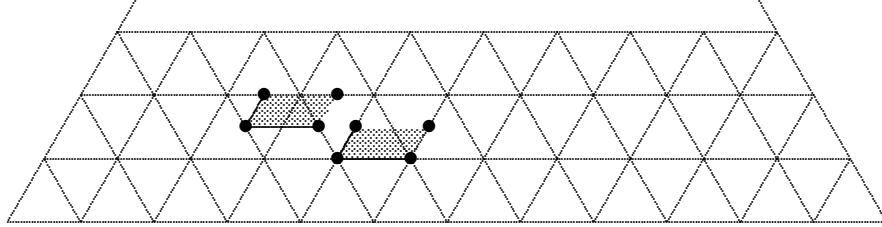

We sketch here the objects for the interpolation, each position is one of the marked vertices, the order is from left to right. First, the family based on 8.1.

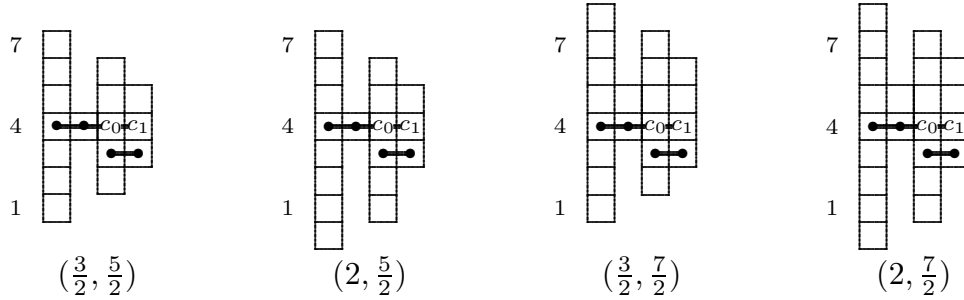

Next, the objects obtained from the family in 7.5.

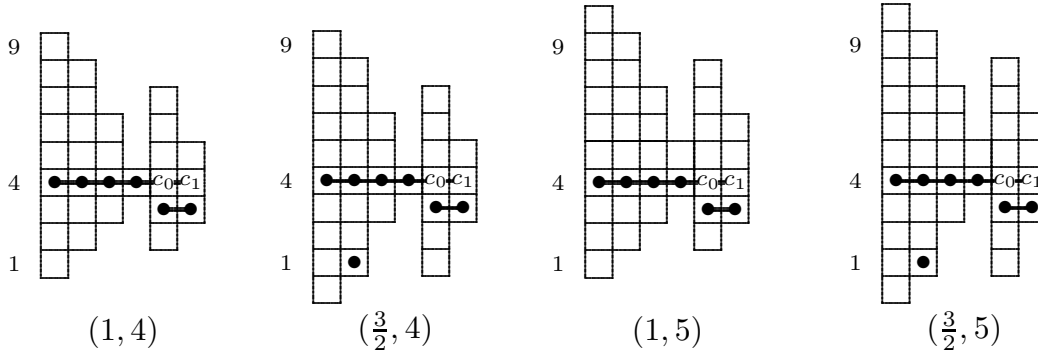

In order to complete the proof of Theorem 10, it suffices to observe that the region of BTh-vectors claimed to exist can be covered by the regions in the Lemma, and their images under reflections on vertical lines through vertices $(0, \frac{\ell}{2}) \in \mathbb{T}(n)$ for suitable values

$\ell \leq n$. Each such reflection can be realized by applying the functor $\tau_\ell^2 D$ to objects in $\mathcal{S}(\ell)$.
 \square

Corollary. *Let $n \geq 10$ and let d be a rational number with $1 \leq d \leq \frac{n}{3}$. There exists an indecomposable object in $\mathcal{S}(n)$ with boundary distance d .* \square

Third part: Half-line support. Triangle support.

9. Rays and central half-lines: the plus-construction.

We consider now Auslander-Reiten components of $\mathcal{S}(n)$. The main result of this Section is Theorem 5.

9.1. Rays, corays, and the quasi-length of indecomposable objects. We assume that $n \geq 6$. We say that a vertex z of a tube is *ray-simple* provided only one arrow ends in z . Dually, a vertex z of a tube is *coray-simple* provided only one arrow starts in z . Since $n \geq 6$, there is a (unique) infinite sectional path which starts in a given ray-simple vertex, we will call it a (*categorical*) *ray*. Dually, there is a (unique) infinite sectional path which ends in a given coray-simple vertex, we will call it a (*categorical*) *coray*.

In the stable components, the ray-simple vertices are just the vertices at the mouth. In the principal component $\mathcal{P}(n)$, the projective vertices are ray-simple, and there are four ray-simple vertices which are not projective: the immediate predecessors of the projective vertices, as well as the isomorphism classes of $S = (0, [1])$ and of $([1], [1])$. Dually, in $\mathcal{P}(n)$, the projective vertices are coray-simple, and there are four coray-simple vertices which are not projective: the immediate successors of the projective vertices, as well as again $S = (0, [1])$ and $([1], [1])$. Here are two sketches of the mouth of the principle component $\mathcal{P}(n)$ of $\mathcal{S}(n)$. On the left, the ray-simple vertices are marked by bullets, on the right, the coray-simple objects are marked by bullets:

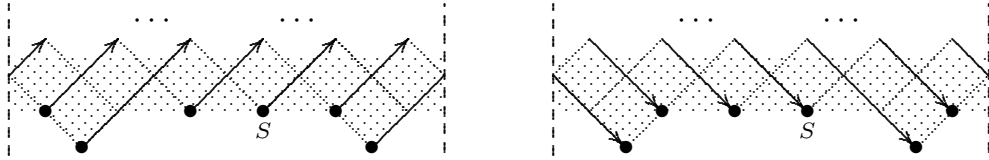

(on the left, for every ray-simple object z , we have drawn a solid arrow which indicates the beginning of the ray starting at z ; similarly, on the right we indicate the corays by arrows).

As we have mentioned, the two projective vertices z in $\mathcal{P}(n)$ are ray-simple, and the ray starting in the projective vertex z may be written in the form

$$z = z[0] \rightarrow z[1] \rightarrow \cdots ,$$

with vertices $z[\ell]$, where $\ell \in \mathbb{N}_0$. If z is a ray-simple and non-projective vertex in the Auslander-Reiten quiver of $\mathcal{S}(n)$, the ray starting with z may be written in the form

$$z = z[1] \rightarrow z[2] \rightarrow \cdots ,$$

with vertices $z[\ell]$, where $\ell \in \mathbb{N}_1$. Always, ℓ will be called the *quasi-length* of $z[\ell]$. (Note that this corresponds to the established use of the word dealing with stable tubes, or more generally, with stable components of tree type \mathbf{A}_∞ : if the indecomposable object X is not projective, then its quasi-length is just the quasi-length of the object $[X]$ in the stable

Auslander-Reiten quiver; if X is projective, then $[X]$ vanishes in the stable Auslander-Reiten quiver and its quasi-length is set to be zero.)

The plus-construction. For any vertex $x = z[\ell]$, let $x^+ = z[\ell + 6]$. If X is an indecomposable object, let X^+ be a representative in the isomorphism class $[X]^+$.

If \mathcal{C} is a stable component, then any plus-orbit of non-central objects in \mathcal{C} has a representative which has quasi-length at most 5, thus the number of plus-orbits is at most 30. Any plus-orbit of non-central objects in $\mathcal{P}(n)$ has a representative which has quasi-length $0 \leq \ell \leq 5$ or is equal to $S[6]$, thus the number of plus-orbits is at most 33, see the diagram in Section 9.5.

9.2. The weight of a component. Let $n \geq 6$. For any Auslander-Reiten component \mathcal{C} , we are going to define the *weight* $\beta\mathcal{C}$ of \mathcal{C} as follows. If X belongs to a stable tube \mathcal{C} , let $\beta\mathcal{C}$ be the minimum of the values $bX + b(\tau X)$ where X is an object in \mathcal{C} ; obviously, $\beta\mathcal{C} = bZ + b(\tau Z)$, where Z is a ray-simple object in \mathcal{C} (according to Theorem 3 in Section 3, all the number $bZ + b(\tau Z)$ with Z ray-simple in \mathcal{C} are equal). For the principal component $\mathcal{P}(n)$, we set $\beta\mathcal{P}(n) = 1$. A characterization of $\beta\mathcal{C}$ using central objects of quasi-length 6 will be given in 9.6.

Here is the main theorem of the section.

9.3. Theorem 5. *Let X be indecomposable and \mathcal{C} the component it belongs to. Then*

$$\frac{u|w}{b}X^+ = \frac{u|w}{b}X + \beta\mathcal{C} \cdot \frac{n|n}{3}.$$

The proof will be given in 9.8 and 9.10, first for \mathcal{C} being stable, then for $\mathcal{C} = \mathcal{P}(n)$.

We will use additive functions on translation quivers. The functions u and w are additive on the Auslander-Reiten quiver. Also, b is nearly always additive on Auslander-Reiten sequences, the only exception is the Auslander-Reiten sequence ending in S , thus an Auslander-Reiten sequence in the principal component $\mathcal{P}(n)$, see the following lemma.

9.4. The additivity of the function b .

Lemma. *The function b is additive on all Auslander-Reiten sequences but one, the only exception is the Auslander-Reiten sequence ending in $(0, [1])$.*

Proof. The function b is nothing else but $\dim_k \text{Hom}((0, [1]), -)$. For any A -module M , where A is an artin algebra, the functor $\text{Hom}(M, -)$ is exact on an Auslander-Reiten sequence $0 \rightarrow X \rightarrow Y \rightarrow Z \rightarrow 0$ provided Z is not a direct summand of M . Thus, $b = \dim_k \text{Hom}((0, [1]), -)$ is exact on all Auslander-Reiten sequences which do not end in $(0, [1])$. \square

Thus, b (as well as u, v) are additive functions on the translation quiver which is obtained from the Auslander-Reiten quiver of $\mathcal{S}(n)$ by deleting the isomorphism class $[S] = [(0, [1])]$ from the domain of the translation τ . The translation quiver obtained in this way will be said to be the *adjusted* translation quiver.

Thus, the uwb -vectors are additive on the adjusted Auslander-Reiten quiver of $\mathcal{S}(n)$. In particular, the uwb -vectors for the objects in a tube are known as soon as those on the boundary of the adjusted component are known.

9.5. The principal component. In our paper, we will need a lot of information about the principal component $\mathcal{P}(n)$. It will be necessary to know the uwb -triples $\frac{uX|wX}{bX}$ for all X in $\mathcal{P}(n)$ with quasi-length at most 7. The following picture shows these uwb -vectors, and even those of the objects with quasi-length 8.

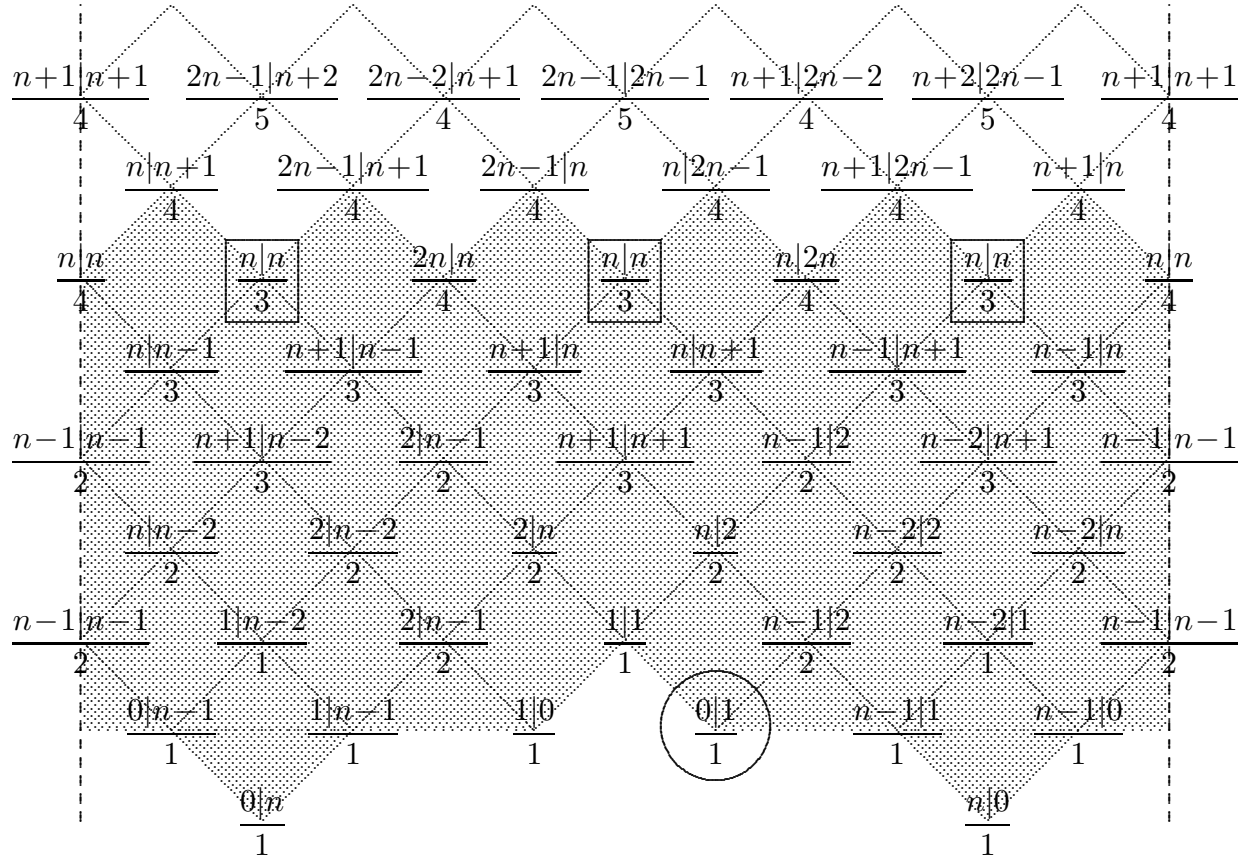

We have mentioned that the functions u, w, b are additive on the adjusted Auslander-Reiten quiver. In our picture, the shaded part consists of meshes of the adjusted Auslander-Reiten quiver; these are the meshes which are needed in order to show the formula in Theorem 5 for the ray-simple and the coray-simple objects of $\mathcal{P}(n)$, see 9.10. The objects enclosed in square boxes are the central ones. The encircled object is S .

In order to verify all the exhibited values, we only have to look at the boundary of the adjusted principal component and to check the additivity, going upwards. (Of course, all the objects in the principal component are known, see [RS1], and one easily may calculate their uwb -vectors; but we want to stress that for the present discussion, only the knowledge of the uwb -vectors at the boundary is relevant, and these objects all are pickets.)

9.6. Central objects of quasi-length 6.

Proposition. *Let Y be a central indecomposable object with quasi-length 6 in the Auslander-Reiten component \mathcal{C} . Then*

$$uY = wY = \beta\mathcal{C} \cdot n, \quad bY = \beta\mathcal{C} \cdot 3,$$

$$\text{thus } \frac{u|w}{b}Y = \beta\mathcal{C} \cdot \frac{n|n}{3}.$$

Proof. It is sufficient to show that $bY = 3 \cdot \beta Y$. Namely, we assume that Y is central, thus the pr-vector of Y is $(n/3, n/3)$, and consequently $uY = wY = n/3 \cdot bY = n \cdot \beta\mathcal{C}$.

First, let us assume that Y belongs to a stable component \mathcal{C} . Let Z be quasi-simple in \mathcal{C} so that $Y = Z[6]$. Then X has a filtration with factors $Z, \tau^-Z, \dots, \tau^{-5}Z$. As we know, b is additive on \mathcal{C} (see 9.4), thus

$$bY = \sum_{i=0}^5 b(\tau^{-i}Z) = 3(bZ + b(\tau^-Z)) = 3 \cdot \beta\mathcal{C},$$

where we use that $b(\tau^2X) = bX$ for any reduced object X .

Second, let $\mathcal{C} = \mathcal{P}(n)$. According to 9.5, there are three possibilities for Y (they are enclosed in a square box), and the uwb-vector of Y is always $\frac{n|n}{3}$, in particular $bY = 3$. On the other hand, $\beta\mathcal{P}(n) = 1$. Thus $bY = 3 = 3 \cdot \beta\mathcal{C}$. □

9.7. Proof of Theorem 5 for stable tubes. There is an exact sequence

$$0 \rightarrow X \rightarrow X^+ \rightarrow X^+/X \rightarrow 0.$$

We apply Proposition 9.6 to $Y = X^+/X$ which has quasi-length 6 (and is central as all objects in stable tubes of quasi-length 6) and use the additivity of the functions u, w, b . □

It remains to look at the principal component. We start with the following lemma which is valid for all tubes (we need it for the principal component $\mathcal{P}(n)$, see 9,9, but also in 9.11.).

9.8. Induction step.

Lemma. *Let \mathcal{C} be an Auslander-Reiten component of $\mathcal{S}(n)$ with $n \geq 6$. If*

$$\frac{u|w}{b}X^+ = \frac{u|w}{b}X + \beta\mathcal{C} \cdot \frac{n|n}{3}.$$

holds for X coray-simple in \mathcal{C} , then it holds for all X in \mathcal{C} .

Proof. If we have an additive function f on a translation quiver, then for any translation subquiver of the form

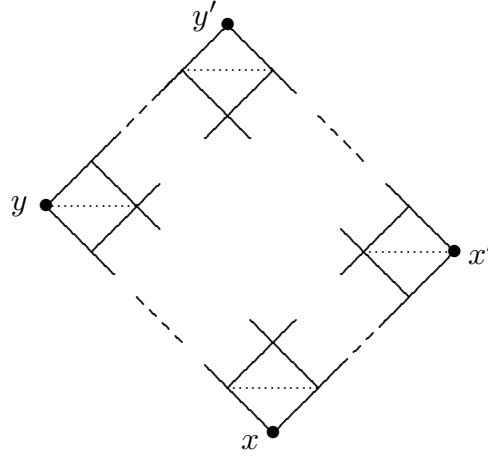

(with arrows going from left to right) the additivity of f implies that

$$(*) \quad f(y') - f(y) = f(x') - f(x)$$

Assume that the assertion of Theorem 5 holds for all coray-simple objects X in \mathcal{C} . Let Y be in \mathcal{C} and $Y' = Y^+$. Then we find a coray-simple object X and a rectangle as exhibited above with $y = [Y]$, $y' = [Y^+]$ and $x = [X]$, $x' = [X^+]$. According to (*), we see that the assertion of Theorem 5 holds for Y . \square

9.9. Proof of Theorem 5 for the principal component $\mathcal{P}(n)$. In 9.5, we have shaded the meshes which are needed in order to calculate the ubw-vectors of the objects X^+ with X being coray-simple. For X coray-simple, we have to compare its ubw-vector with the ubw-vector of X^+ . We see

$$\frac{u|w}{b}X^+ - \frac{u|w}{b}X = \frac{n|n}{3}.$$

for all coray-simple objects X in $\mathcal{P}(n)$. Since $\beta X = 1$, the formula in Theorem 5 is satisfied for the coray-simple objects in $\mathcal{P}(n)$, thus, according to 9.8, the formula is valid in general for the principal component. This concludes the proof of Theorem 5 for the principal component, thus for all components. \square

9.10. The global space of the objects in $\mathcal{P}(n)$.

We have shown in 9.9: If X belongs to $\mathcal{P}(n)$, then $u(X^+) = uX + n$, $w(X^+) = wX + n$ (therefore $v(X^+) = vX + 2n$), and $b(X^+) = bX + 3$. These assertions can be refined as follows:

Proposition. *If $X = (U, V, W)$ belongs to $\mathcal{P}(n)$, then:*

(a) *The global space of X^+ is*

$$V(X^+) = VX \oplus [n, n - 2, 2]$$

with subspace $U(X^+) = UX \oplus [n-2, 2]$ and factor space $W(X^+) = WX \oplus [n-2, 2]$.

(b) The parts occurring in U, V, W are $[1], [2], [n-2], [n-1], [n]$.

Note that (a) implies immediately that $u(X^+) = uX + n$, $v(X^+) = vX + 2n$, $w(X^+) = wX + n$, and $b(X^+) = bX + 3$.

Outline of a proof of Proposition. We denote by $[\mathcal{N}(n)]$ the set of isomorphism classes $[N]$ of the objects of $\mathcal{N}(n)$, or, what is the same, the set of partitions of height at most n . For $1 \leq t \leq n$, let $[\mathcal{N}(n)]_t$ be the subset of all $[N]$ in $[\mathcal{N}(n)]$ such that $[t]$ is a direct summand of N , thus the set of partitions of height at most n with at least one part equal to t . We define functions κ_i with $i \in \mathbb{N}_1$ and with $\kappa_i = \kappa_j$ for $i \equiv j \pmod{6}$, all with values in $[\mathcal{N}(n)]$, as follows: The functions $\kappa_1, \kappa_4, \kappa_5$ are defined on all of $[\mathcal{N}(n)]$, the functions $\kappa_2, \kappa_3, \kappa_6$ are defined on $[\mathcal{N}(n)]_n, [\mathcal{N}(n)]_{n-1}$, and $[\mathcal{N}(n)]_1$, respectively, namely as follows:

$$\begin{aligned}\kappa_1[N] &= [N \oplus [n]], \\ \kappa_2[N \oplus [n]] &= [N \oplus [n-1]], \\ \kappa_3[N \oplus [n-1]] &= [N \oplus [n, n-2]], \\ \kappa_4[N] &= [N], \\ \kappa_5[N] &= [N \oplus [1]], \\ \kappa_6[N \oplus [1]] &= [N \oplus [2]].\end{aligned}$$

It is easy to check that for all $i \in \mathbb{N}_1$, we have

$$(1) \quad \kappa_{i+5}\kappa_{i+4} \cdots \kappa_{i+1}\kappa_i[N] = [N \oplus [n, n-2, 2]],$$

provided $\kappa_i[N]$ is defined.

Let $Z_1 = S$, $Z_2 = ([n], [n])$, $Z_3 = ([n-1], [n-1])$, $Z_4 = (0, [n])$, $Z_5 = ([1], [n])$, $Z_6 = ([1], [1])$, and $Z_j = Z_i$ provided $i \equiv j \pmod{6}$. Thus, Z_1, \dots, Z_6 are the coray-simple objects.

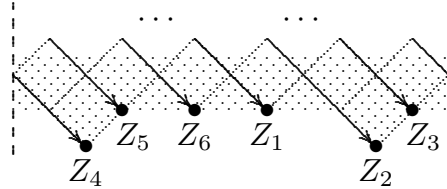

We denote by $[t]Z$ the object of quasi-length t in the coray ending in Z , thus any object in $\mathcal{P}(n)$ is of the form $[t]Z$, and a sectional path $X \rightarrow X^+$ is of the form

$$X = [t]Z_i \rightarrow [t+1]Z_{i+1} \rightarrow \cdots \rightarrow [t+5]Z_{i+5} \rightarrow [t+6]Z_{i+6} = X^+.$$

There is the following formula

$$[V([t+1]Z_{i+1})] = \kappa_i(V([t]Z_i))$$

which can be shown by induction on t .

It follows that

$$(2) \quad [V(X^+)] = \kappa_{i+5} \cdots \kappa_{i+1} \kappa_i [VX].$$

The equalities (2) and (1) show:

$$[V(X^+)] = \kappa_{i+5} \cdots \kappa_{i+1} \kappa_i [VX] = [VX \oplus [n, n-2, 2]].$$

Proof of (b). It is sufficient to consider V . Let \mathbf{N} be the subset of $|\mathcal{N}(n)|$ given by the objects N whose indecomposable direct summands are of the form $[1], [2], [n-2], [n-1], [n]$. Then we have $\kappa_i(\mathbf{N}) \subseteq \mathbf{N}$, for $1 \leq i \leq 6$. Also, if X is ray-simple in $\mathcal{P}(n)$, then VX belongs to \mathbf{N} . It follows by induction on the quasi-length that for all objects X in $\mathcal{P}(n)$, we have $[VX] \in \mathbf{N}$. \square

Here are the partitions $[VX]$ for the objects X in $\mathcal{P}(n)$ with quasi-length at most 7. For the objects of the form X^+ (they have quasi-length 6 or 7), we have encircled $[VX]$ (it occurs as a part of the partition $[V(X^+)]$).

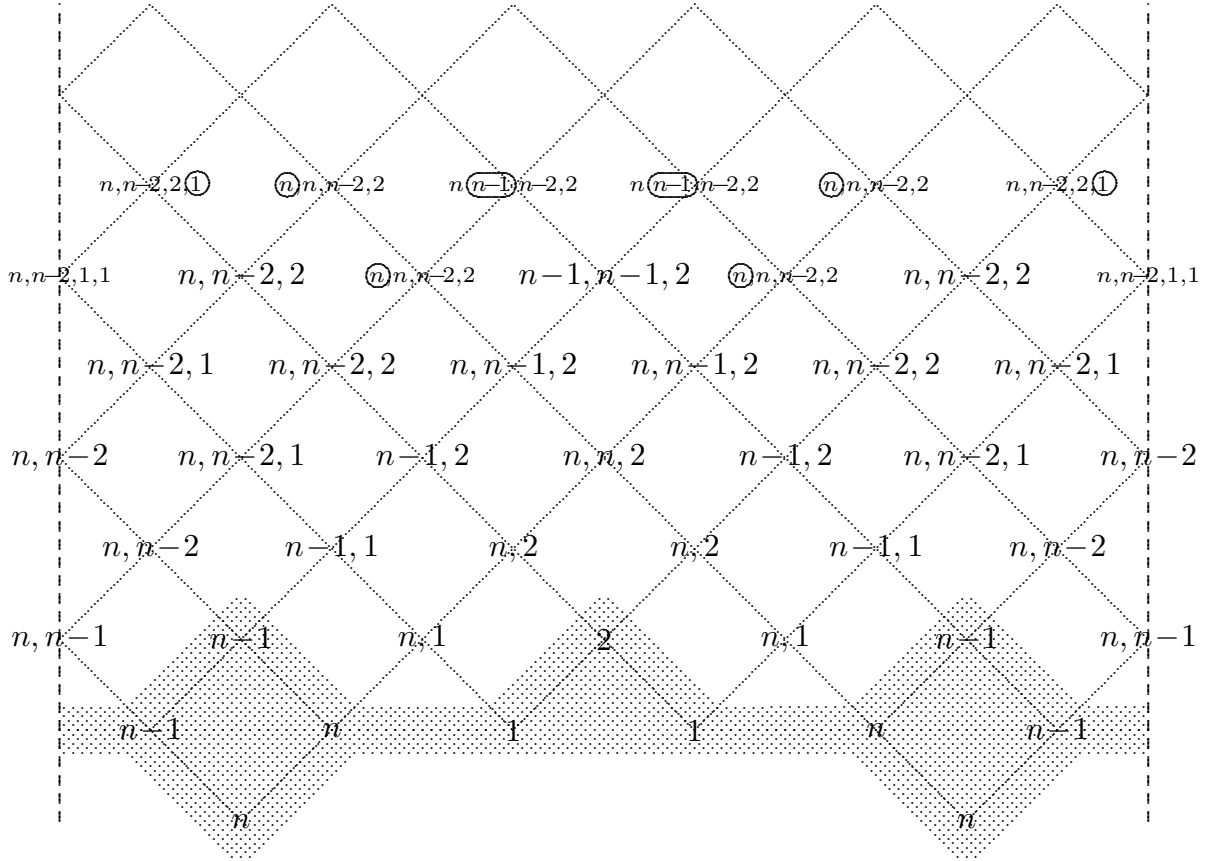

Remark. Theorem 5 provides a numerical comparison between X and X^+ , for any indecomposable object X in $\mathcal{S}(n)$. Also, we know that there is a sectional path from X to X^+ and one may analyse this path. In case X belongs to a stable tube, this path yields

a monomorphism (whose cokernel belongs to the same component as X); in particular X is a subobject of X^+ . In case X belongs to the principal component $\mathcal{P}(n)$, we may get a different behaviour.

Let X be indecomposable in $\mathcal{S}(n)$. The following conditions are equivalent:

- (i) X is a subobject of X^+ .
- (ii) A sectional path $X \rightarrow \cdots \rightarrow X^+$ yields a monomorphism $X \rightarrow X^+$.
- (iii) X does not belong to the coray ending in $([n], [n])$.
- (iv) There is no sectional path from X to $([n], [n])$.

Proof (outline). We may assume that X belongs to $\mathcal{P}(n)$. If X does not belong to the coray ending in $([n], [n])$, then it is easy to see that again any sectional path $X \rightarrow \cdots \rightarrow X^+$ yields a monomorphism $X \rightarrow X^+$, thus X is again a subobject of X^+ .

On the other hand, we have to consider the case that X belongs to the coray ending in $([n], [n])$. Then the Auslander-Reiten quiver exhibits a short exact sequence

$$0 \rightarrow X \rightarrow X[1] \oplus ([n], [n]) \rightarrow ([n-1], [n-1]) \rightarrow 0$$

hence the map $X \rightarrow X[1]$ cannot be a monomorphism. But this implies that μ has a non-trivial kernel. A contradiction. \square

9.11. Half-lines. As the title of this section indicates, we also will deal with half-lines: these are half-lines in the pr-plane $\mathbb{T}(n)$, in the usual sense: if we start with a line in $\mathbb{T}(n)$, any vertex x of the line decomposes the line into two half-lines with initial vertex x (it is common to consider x as an element of both half-lines, and the two half-lines which are obtained will be said to be *complementary*). If $y \neq x$ are different vertices in $\mathbb{T}(n)$, we write $[x, y)$ for the half-line with initial vertex x passing through y .

We recall that the center of $\mathbb{T}(n)$ is $z(n) = (\frac{n}{3}, \frac{n}{3})$ and that a line in $\mathbb{T}(n)$ is said to be central, provided $z(n)$ belongs to it; a half-line is said to be central provided its initial vertex is $z(n)$. Also, an indecomposable object X with $\mathbf{pr} X = z(n) = (\frac{n}{3}, \frac{n}{3})$ is said to be central. Note that *an indecomposable object X with $\tau^2 X = X$ is central.*

9.12. Arithmetical sequences. We are going to prove the Corollary of Theorem 5. Starting with a non-central object X , the central half-line which passes through $\mathbf{pr} X$ contains infinitely many vertices of the form $\mathbf{pr} X_i$, with $X_0 = X$ such that all the objects X_i belong to the same (categorical) ray.

There is the following obvious generalization of Theorem 5 (see also 9.8). We define inductively X^{+t} for $t \in \mathbb{N}_0$ as follows: $X^{+0} = X$, and if X^{+t} is already defined, then $X^{+(t+1)} = (X^{+t})^+$.

Theorem 5 (general form). *Let X be indecomposable in the Auslander-Reiten component \mathcal{C} . Then for all $t \in \mathbb{N}_0$*

$$\frac{u|w}{b} X^{+t} = \frac{u|w}{b} X + \beta \mathcal{C} \cdot t \cdot \frac{n|n}{3}.$$

Corollary. *Let X be indecomposable. If X is central, all objects X^{+t} are central. Otherwise, the sequence $X = X^{+0}, X^{+1}, X^{+2}, \dots$ lies on the half-line $[z(n), \mathbf{pr} X)$ in $\mathbb{T}(n)$.*

The distance of $\mathbf{pr} X^{+t}$ to the center $z(n)$ is strictly decreasing and converges to zero. (In particular, the vertices $\mathbf{pr} X_t$ are pairwise different.)

If X is not central, we may visualize the setting as follows: on the half-line $[z(n), \mathbf{pr} X)$, we mark the (pr-vectors of the) objects X_t by bullets.

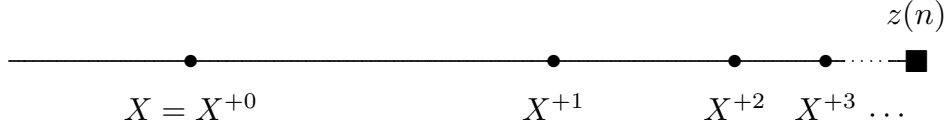

Remark. We may add to Theorem 5 and Proposition 9.11 the following observation: If X is indecomposable, then

$$\frac{u|w}{b} X^{+t} = \frac{u|w}{b} (X \oplus Y^t),$$

where $Y = X^+/X$ in case X belongs to a stable tube, and where Y is one of the indecomposable objects in $\mathcal{P}(n)$ with $\frac{u|w}{b} Y = \frac{n|n}{3}$, in case X belongs to $\mathcal{P}(n)$. Thus, always Y is indecomposable and belongs to the same Auslander-Reiten component as X . \square

9.13. Proposition. *Let X be indecomposable in $\mathcal{S}(n)$. Then X is central if and only if X^+ is central. Also, X is u -minimal if and only if X^+ is u -minimal. If X is not central, then $dX < d(X^+)$ and the sequence $d(X^{+t})$ converges to $n/3$.*

Proof. The first two assertions follow directly from Theorem 5. It remains to show the last assertions. Thus, assume that X is not central. Assume that X belongs to the component \mathcal{C} and let $\beta = \beta\mathcal{C}$. We may assume that X is u -minimal, thus $uX/bX < n/3$, therefore $3uX < nbX$. It follows that

$$dX = uX/bX < (uX + n\beta)/(bX + 3\beta) = d(X^+).$$

It is easy to verify that the sequence $d(X^{+t}) = (uX + n\beta \cdot t)/(bX + 3\beta \cdot t)$ converges to $n/3$. \square

9.14. Proposition. *If \mathcal{C} is a stable component, the number of objects in \mathcal{C} with fixed boundary distance $d < n/3$ is at most 30. The number of objects in $\mathcal{P}(n)$ with fixed boundary distance $d < n/3$ is at most 33.*

Proof. This follows from the inequality $dX < d(X^+)$ given in 9.12 and the following obvious assertions (see the end of subsection 9.1). If \mathcal{C} is a stable component, then any plus-orbit of non-central objects in \mathcal{C} has a representative which has quasi-length at most 5, thus the number of plus-orbits is at most 30. Any plus-orbit of non-central objects in $\mathcal{P}(n)$ has a representative which has quasi-length $0 \leq \ell \leq 5$ or is equal to $S[6]$, thus the number of plus-orbits is at most 33.

Remark. We will see at the beginning of 10.7 that the number 33 for $\mathcal{P}(n)$ is optimal.

10. The half-line support and the triangle support of a component.

In this section, we usually suppose that $n \geq 6$, but in subsection 10.9 and 10.10, we deal with all values $n \geq 1$.

We have attached to every indecomposable non-central object X the central half-line $H(X)$ which starts at the center $z(n)$ and contains the pr-vector of X . Since we have $H(X^+) = H(X)$, we see that for any Auslander-Reiten component \mathcal{C} , we may obtain at most 36 different half-lines. Actually, since for \mathcal{C} being stable, the six objects of quasi-length 6 are central, we see that the half-line support of a stable component consists of at most 30 half-lines. Similarly, the three central objects in $\mathcal{P}(n)$ with quasi-length 6 show that the half-line support of $\mathcal{P}(n)$ can contain at most 33 central half-lines. As we will see below, the number 30 for stable components is optimal. However, the half-line support of $\mathcal{P}(n)$ consists of only 18 half-lines in case $n = 6$, and of 24 half-lines in case $n \geq 7$.

First, we look at the half-line support of a stable tube.

10.1. Complementary half-lines. We look at a stable tube \mathcal{C} and want to show: if a central half-line supports \mathcal{C} , also the complementary half-line supports \mathcal{C} . There is the following Proposition.

Proposition. *Let X be indecomposable object in some stable component \mathcal{C} . Then there is X' in \mathcal{C} such that*

$$\frac{u|w}{b}X + \frac{u|w}{b}X'$$

is an integral multiple of $\beta\mathcal{C} \cdot \frac{n|n}{3}$.

Proof. We assume that $X = Z[6t - i]$ for some ray-simple object Z , with $t \geq 1$ and $0 \leq i \leq 5$. If X is not central, the quasi-length $6t - i$ of X is not divisible by 6, thus $i > 0$. Let $X' = Z[6t]/Z[6t - i]$. Since $i \geq 1$, X' is indecomposable and belongs to \mathcal{C} . Also, we have

$$\frac{u|w}{b}X + \frac{u|w}{b}X' = \frac{u|w}{b}Z[6t]$$

and $\frac{u|w}{b}Z[6t]$ is a multiple of $\beta\mathcal{C} \cdot \frac{n|n}{3}$, see 9.7. □

There is the following consequence:

Corollary 1. *If X is indecomposable, non-central and belongs to a stable tube \mathcal{C} , then there is X' in \mathcal{C} such that X and X' live on complementary half-lines.*

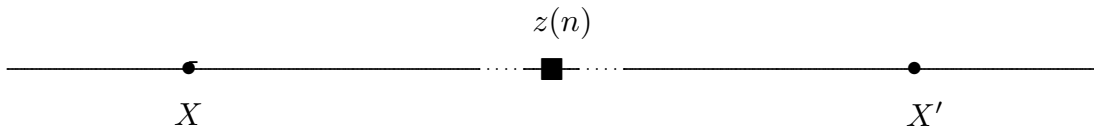

Proof. Let $X = Z[\ell]$ with Z ray-simple and $\ell \geq 1$. According to Proposition 10.1, X lives on the same central half-ray as some $Z[t]$ with $1 \leq t \leq 5$. Let $X' = \tau^{-t}Z[6 - t]$. The formula in Proposition 9.6 asserts that X' lives on the complementary central half-line. □

Remark. Proposition 10.1 provides a recipe how to relate complementary half-lines in the support of a stable tube. We may refine these considerations by taking into account the precise τ -period of the objects in question.

Namely, let X be a non-central indecomposable in a stable tube. Then the τ -period of X is 3 or 6.

Corollary 2. *The half-line support of a stable tube \mathcal{C} consists of g pairs of complementary central half-lines, where $0 \leq g \leq 15$ is divisible by 3.*

If \mathcal{C} has rank 3, the half-line support of \mathcal{C} consists of g pairs of complementary half-lines, where $g = 0$ or $g = 3$. \square

10.2. Example of a stable tube with half-line support given by 15 complementary pairs of half-lines. Here we deal with the Auslander-Reiten component in $\mathcal{S}(7)$ which contains E_2^3 .)

We start with the bipicket $X = ([4], [7, 2], [4, 1])$, as shown on the right:

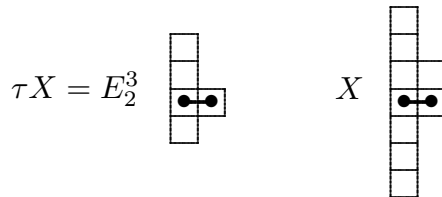

According to Section 3, we have $\tau X = ([2], [4, 1], [3]) = E_2^3$ and $\tau^2 X = ([4, 1], [7, 3], [5])$. Put $Y = \tau X[2]$ and $Z = \tau^2 X[3]$. Then:

	uwv-vector	$\phi = \frac{3u-7b}{3w-7b}$
X	$\frac{4 5}{2}$	-2
τX	$\frac{2 3}{2}$	$\frac{8}{5}$
$\tau^2 X$	$\frac{5 5}{2}$	1
Y	$\frac{6 8}{4}$	$\frac{5}{2}$
τY	$\frac{7 8}{4}$	$\frac{7}{4}$
Z	$\frac{11 13}{6}$	3

The number ϕ in the last column is the ratio for the line through $z(7)$ and the pr-vector $(\frac{u}{b}, \frac{w}{b})$, see 10.3.

Here are the pr-vectors of X , τX , $\tau^2 X$, Y , τY , Z in $\mathbb{T}(7)$:

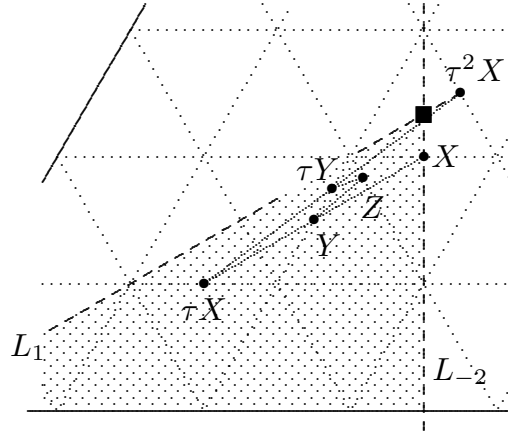

We see that the uwv-vectors of X , τX , Y , τY , Z lie in the (shaded) fundamental region bounded by the lines L_1 , L_{-2} and $p = 0$ (and not on L_1). If we apply the rotations ρ and ρ^2 (thus τ^2 and τ^4), the 5 central half-lines which pass through X , τX , Y , τY , Z yield a set of 15 half-lines which belong to the half-line support of \mathcal{C} , and which contains no pair of complementary half-lines. Thus the half-line support of \mathcal{C} consists of 15 pairs of complementary half-lines.

10.3. Some central lines and half-lines.

A central line L which is not parallel to a boundary line, is the union of two central half-lines which are denoted by L_s (the short one) and L_ℓ (the long one); here "short" and "long" refer to the intersection with $\mathbb{T}(n)$; for example, in case L contains a vertex of the form $(0, r)$ with $0 \leq r \leq n$, then $(0, r)$ belongs to L_s if and only if $\frac{n}{3} < r < \frac{2n}{3}$.

We denote by $\mathbb{P}(n)$ the union of the central lines which are parallel to the three coordinate axes, to the boundary lines: These are the lines $p = \frac{n}{3}$, $r = \frac{n}{3}$, $n - q = \frac{n}{3}$. We denote by $\mathbb{D}(n)$ the union of the diagonal lines (the reflection lines): These are the lines $p = r$, $r = n - q$, $p = n - q$.

We denote by $\mathbb{H}(n)$ the union of the central lines which pass through a vertex in the Σ_3 -orbit of $\mathbf{pr} S = (0, 1)$, and by $\mathbb{K}(n)$, for $n \geq 5$, the central lines which pass through a vertex in the Σ_3 -orbit of $\mathbf{pr} E_2^{n-2} = (1, (n-2)/2)$. Note that for $n = 6$, $\mathbb{K}(n) = \mathbb{P}(n)$, since in this case $\mathbf{pr} E_2^{n-2} = (1, 2)$.

Here are the lines $\mathbb{P}(n), \mathbb{D}(n)$ and the half-lines $\mathbb{H}_\ell(n)$ (for $n \geq 4$), as well as the half-lines $\mathbb{K}_s(n)$ (for $n \geq 7$):

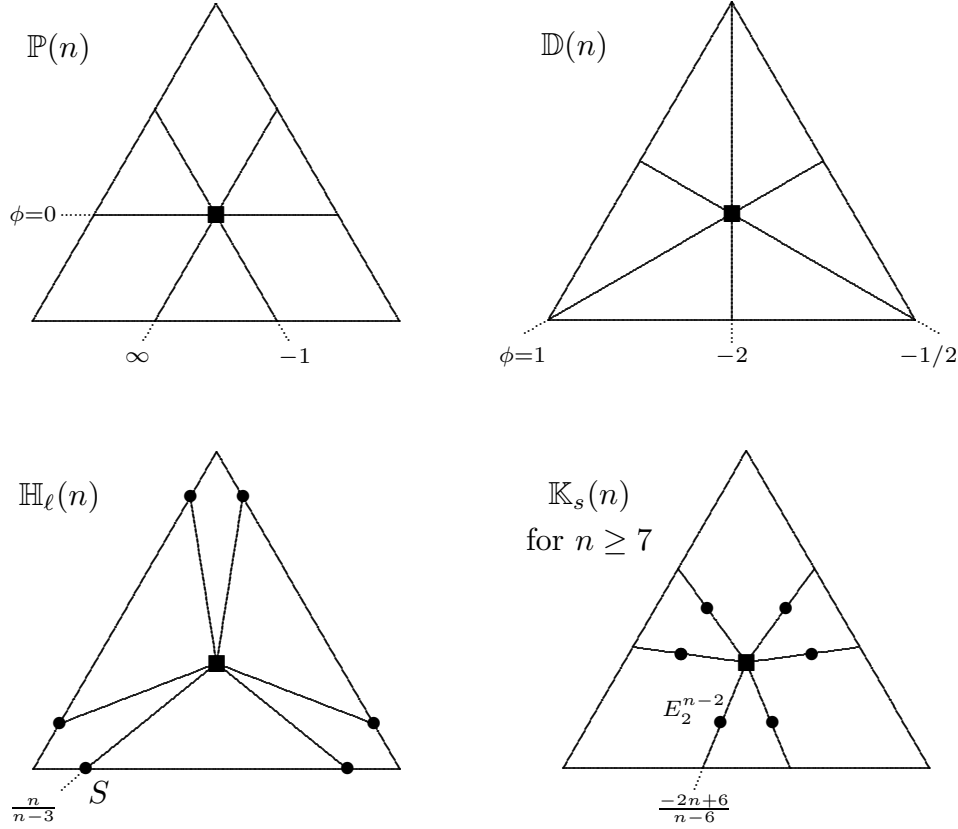

For $\phi \in \mathbb{R} \cup \{\infty\}$, let L_ϕ be the set of elements of $\mathbb{T}(n)$ with $p - \frac{n}{3} = \phi \cdot (r - \frac{n}{3})$. This is a line which contains $z(n) = (\frac{n}{3}, \frac{n}{3})$, thus a central line. We call ϕ the *slope* of L_ϕ . (It is the slope of the line through $z(n)$ and (p, r) in the cartesian coordinate system with axes $x = r, y = p$.) We stress that *the non-central pr-vector (p, r) belongs to L_ϕ with $\phi = \frac{3p-n}{3r-n}$.*

The central lines $p = \frac{n}{3}, r = \frac{n}{3}, n - q = \frac{n}{3}$ in $\mathbb{P}(n)$ have slope 0, $\infty, -1$, respectively. The diagonal lines $p = r, r = n - q, p = n - q$ in $\mathbb{D}(n)$ have slope 1, $-2, -1/2$, respectively.

In the lower row, we mention the slope $\frac{n}{n-3}$ of the central line through S and the slope $\frac{-2n+6}{n-6}$ of the central line through E_2^{n-2} .

Lemma. *The union $\mathbb{P}(6) \cup \mathbb{D}(6) \cup \mathbb{H}_\ell(6)$ consists of 18 central half-lines. For $n \geq 7$, the union $\mathbb{P}(n) \cup \mathbb{D}(n) \cup \mathbb{H}_\ell(n) \cup \mathbb{K}_s(n)$ consists of 24 central half-lines.*

For any $n \geq 6$, precisely 12 of these central half-lines form complementary pairs, namely the half-lines in $\mathbb{P}(n) \cup \mathbb{D}(n)$.

The proof is easy. In order to show that for $n \geq 7$, no half-line in $\mathbb{H}_\ell(n)$ is complementary to a half-line in $\mathbb{K}_s(n)$, it is sufficient to show that the central half-line which contains $D\tau^2 S$ is not complementary to the central half-line which contains E_2^{n-2} . Now $\mathbf{pr} D\tau^2 S = (n-1, 1)$ and $(n-1, 1)$ does not lie on the line L_ϕ with $\phi = \frac{-2n+6}{n-6}$. \square

10.4. The half-line support of $\mathcal{P}(n)$ for $n \geq 6$.

When dealing with the principal component $\mathcal{P}(n)$, where $n \geq 6$, we may use the following reference system: Besides the projective objects $([0], [n])$ and $([n], [n])$, there are the objects of the form $\tau^i S[\ell]$ with $\ell \in \mathbb{N}_1$ and $0 \leq i \leq 5$ (see the picture at the beginning of 10.6).

Note that there is a single object of quasi-length 6 which is neither of the form X^+ with $X \in \mathcal{P}(n)$, nor central, namely $S[6]$. The uwb-vector of $S[6]$ is $\frac{6|6}{4}$ (the central objects of quasi-length 6 have uwb-vector $\frac{6|6}{3}$).

First, let us determine the half-line support of $\mathcal{P}(n)$.

Proposition. *The half-line support of $\mathcal{P}(6)$ is $\mathbb{P}(6) \cup \mathbb{D}(6) \cup \mathbb{H}_\ell(6)$. For $n \geq 7$, the half-line support of $\mathcal{P}(n)$ is $\mathbb{P}(n) \cup \mathbb{D}(n) \cup \mathbb{H}_\ell(n) \cup \mathbb{K}_s(n)$.*

Proof. The objects with even quasi-length are supported by $\mathbb{D}(n)$. In 10.7 we will show a picture of $\mathcal{P}(n)$; there, the objects on the dashed vertical lines are invariant under D , and all objects of even quasi-length belong to their τ^2 -orbits. The two objects of quasi-length 2 which are invariant under D are $\tau S[2]$ with pr-vector $(1, 1)$ and $\tau^4 S[2]$ with pr-vector $((n-1)/2, (n-1)/2)$, thus they belong to complementary half-lines.

Now we look at the objects of quasi-length 1, 3, 5, and, in addition, at $S[6]$. The objects with quasi-length 1 have half-line support $\mathbb{H}_\ell(n)$, since S is one of them. The objects with quasi-length 3 have half-line support $\mathbb{K}_s(n)$, if $n \geq 7$, and half-line support $\mathbb{P}(6)$ for $n = 6$. This follows from the fact that $E_2^{n-2} = \tau^3 S[3]$. The objects with quasi-length 5 have half-line support $\mathbb{P}(n)$, since $\tau^2 S[5], \tau^5 S[5]$ have quasi-length 5 and belong to complementary half-lines in $\mathbb{P}(n)$. Finally, $S[6]$ belongs to $\mathbb{D}(n)$.

Altogether, we see: the half-line support of the class of objects in $\mathcal{P}(n)$ which have quasi-length at most 5 is $\mathbb{P}(n) \cup \mathbb{D}(n) \cup \mathbb{H}_\ell(n) \cup \mathbb{K}_s(n)$ in case $n \geq 7$, and is $\mathbb{P}(n) \cup \mathbb{D}(n) \cup \mathbb{H}_\ell(n)$ in case $n = 6$. Also, $S[6]$ belongs to a half-line in $\mathbb{D}(n)$.

It remains to use Theorem 5. □

10.5. The triangle support of a component.

We are going to proof part (b) of Theorem 6.

Proposition. *Let \mathcal{C} be an Auslander-Reiten component of $\mathcal{S}(n)$, with $n \geq 6$. The triangle support of \mathcal{C} is the union of the triangles Δ_d with $d \in \Psi(\mathcal{C})$, where $\Psi(\mathcal{C})$ is a set of rational numbers $0 \leq d < n/3$. Moreover, either $\Psi(\mathcal{C})$ is empty, or else $n/3$ is the only accumulation point of $\Psi(\mathcal{C})$. Any triangle Δ_d is the support of only finitely many indecomposable objects of \mathcal{C} .*

Proof. Let \mathcal{C} be a component, and let $\beta = \beta\mathcal{C}$. We have seen in Section 9: if X is indecomposable, and $Y = X^{+t}$, then X is u -minimal if and only if Y is u -minimal; also, $uY = uX + n\beta t$, $bY = bX + 3\beta t$.

We call a pair (u, b) of natural numbers a *primitive pair* for \mathcal{C} provided there is X in \mathcal{C} which is not central, u -minimal, and has quasi-length at most 5, such that $u = uX$ and $b = bX$.

(1) *For any component \mathcal{C} , there are at most 10 primitive pairs.*

Proof. First of all, the projective indecomposable objects are not u -minimal, thus the u -minimal objects in \mathcal{C} of quasi-length at most 5 correspond bijectively to the non-central τ^2 -orbits of objects of quasi-length between 1 and 5 (namely, any τ^2 -orbit of non-central objects contains precisely one u -minimal object). The assertion follows from the fact that there are at most 10 τ^2 -orbits of objects of quasi-length between 1 and 5. \square

If (u, b) is a primitive pair for \mathcal{C} , and $\beta = \beta\mathcal{C}$, let

$$d_{ub}^\beta(t) = (u + n\beta \cdot t)/(b + 3\beta \cdot t).$$

Let \mathcal{C} be a component. Let $\Psi(\mathcal{C})$ be the set of numbers dX with $X \in \mathcal{C}$ non-central.

(2) *Let \mathcal{C} be a component. The set $\Psi(\mathcal{C})$ is the set of all values $d_{ub}^{\beta\mathcal{C}}(t)$, where (u, b) is a primitive pair for \mathcal{C} and $t \in \mathbb{N}_0$.*

Proof. First, let (u, b) be a primitive pair for \mathcal{C} , thus there is X in \mathcal{C} with $uX = u$ and $bX = b$. Let $t \in \mathbb{N}_0$. According to Theorem 5, we have $d(X^{+t}) = d_{ub}^{\beta\mathcal{C}}(t)$. This shows that the values $d_{ub}^{\beta\mathcal{C}}(t)$ belong to $\Psi(\mathcal{C})$.

Conversely, let $X \in \mathcal{C}$ be non-central. We have to show that $dX = d_{ub}^{\beta\mathcal{C}}(t)$ for some primitive pair (u, b) and some $t \in \mathbb{N}_0$.

First, assume that $X = P$ is projective or that $X = S[6]$. Then $\mathcal{C} = \mathcal{P}(n)$. Clearly, $dP = 0$ and $d(S[6]) = n/4$ (since $u(S[6]) = n$, and $b(S[6]) = 4$). On the other hand, S is u -minimal in \mathcal{C} with $uS = 0$ and $b = 1$, thus $(0, 1)$ is a primitive pair for \mathcal{C} and $d_{01}^{\beta\mathcal{C}}(0) = 0$, whereas $d_{01}^{\beta\mathcal{C}}(1) = n/4$. This shows that in these three cases, dX has the required form.

Next, assume that X has quasi-length between 1 and 5. Then the τ^2 -orbit of X contains some object X' which is u -minimal and $dX = dX'$. Let $u = u(X')$, and $b = b(X')$. Then $d(X') = d_{ub}^{\beta\mathcal{C}}(0)$ has the required form.

Finally, we can assume that the quasi-length of X is at least 6 and that X is different from $S[6]$. Then $X = Y^{+t}$, where Y in \mathcal{C} has quasi-length at most 5 or is equal to $S[6]$. As we have seen already, $dY = d_{ub}^{\beta\mathcal{C}}(0)$ for some primitive pair (u, b) , and Theorem 5 now yields that $dX = d(Y^{+t}) = d_{ub}^{\beta\mathcal{C}}(t)$. \square

(3) *The triangle support of \mathcal{C} consists of the triangles Δ_d with $d \in \Psi(\mathcal{C})$, where $\Psi(\mathcal{C})$ is the set of rational numbers $d_{ub}^\beta(t) = (u + n\beta t)/(b + 3\beta t)$, with (u, b) is a primitive pair for \mathcal{C} , and $t \in \mathbb{N}_0$.*

Proof. This is an immediate consequence of (2). \square

(4) *The sequence $d_{ub}^\beta(t)$ is strictly increasing and converges to $n/3$.*

Proof: This can be checked easily. \square

(5) *If the set $\Psi(\mathcal{C})$ is non-empty, then $n/3$ is its only accumulation point.*

Proof: According to (2), $\Psi(\mathcal{C})$ is the union of the sequences $d_{ub}^\beta(t)$, and according to (4), these sequences are strictly increasing and converge to $n/3$. The set of sequences is indexed by the set of primitive pairs. According to (1), there are only finitely many

primitive pairs. Since $\Psi(\mathcal{C})$ is the union of finitely many sequences which converge to $n/3$, the assertion follows. \square

(6) Any standard triangle is the support of only finitely many indecomposables in \mathcal{C} .

Proof. See 9.13. \square

This completes the proof of Proposition, thus of Theorem 6 (b). \square

10.6. The primitive pairs for $\mathcal{P}(n)$.

Proposition. *The primitive pairs for $\mathcal{P}(n)$ are $(0, 1)$, $(1, 1)$, $(2, 2)$, $(n - 2, 3)$, $(n - 1, 3)$.*

Proof: We determine the u -minimal objects of quasi-length at most 5. For quasi-length 0, there is no u -minimal object. For quasi-length 1, there are two u -minimal object, namely S and $\tau^3 S$, both yield the primitive pair $(0, 1)$. For quasi-length 2, there are the u -minimal objects $\tau^i S[2]$ with $i = 1, 2$; the corresponding primitive pairs are $(1, 1)$, $(2, 2)$, respectively. There are two u -minimal objects of quasi-length 3, namely $\tau^2 S[3]$ and $\tau^3 S[3]$, both with primitive pair $(2, 2)$. There are two u -minimal objects of quasi-length 4, namely $S[4]$ with primitive pair $(n - 2, 3)$ and $\tau^3 S[4]$ with primitive pair $(2, 2)$. Finally, $S[5]$ and $\tau S[5]$ are the u -minimal objects of quasi-length 5, both yield the primitive pair $(n - 1, 3)$. Here are the u -minimal objects in $\mathcal{P}(n)$ which have quasi-length at most 5:

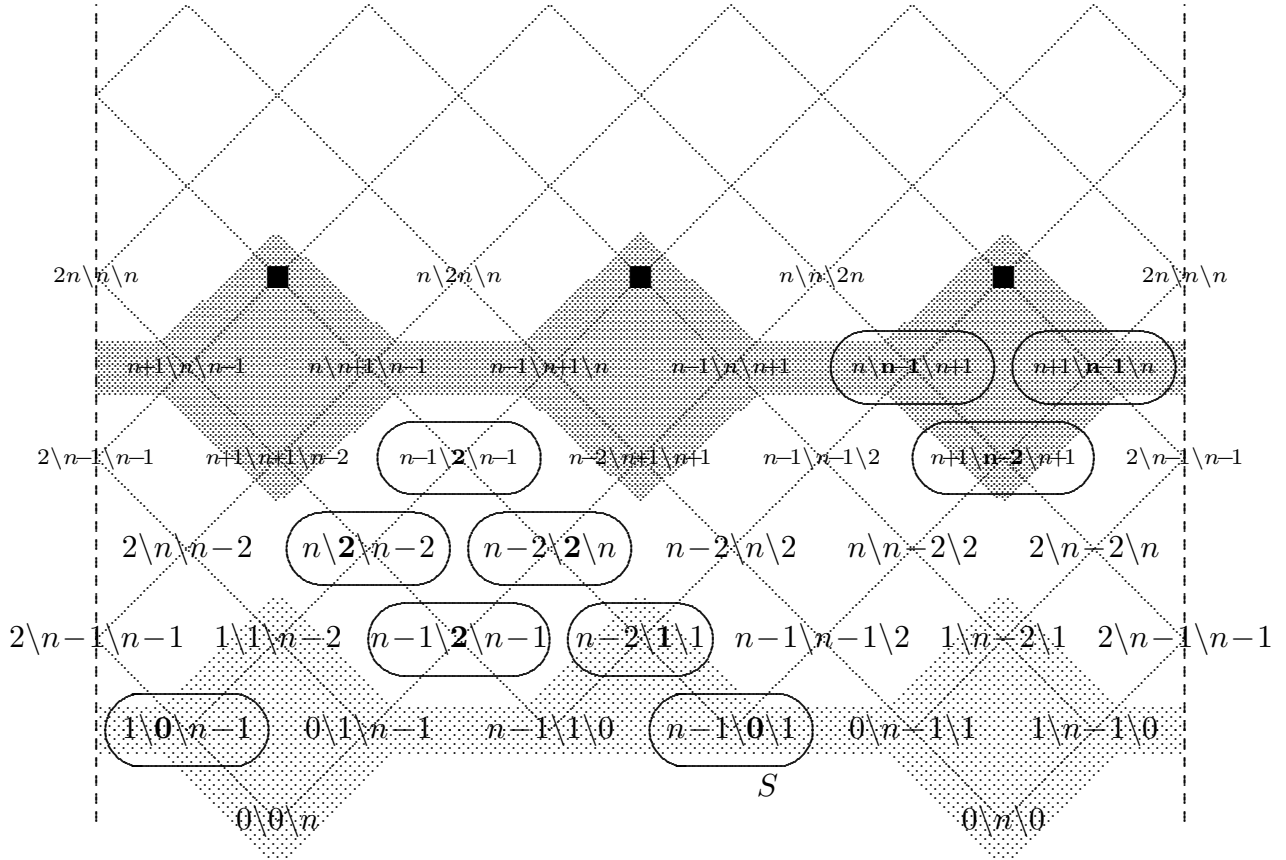

□

10.7. The m -partition and the width partition of $\mathcal{P}(n)$, for $n \geq 6$.

We denote by \mathcal{P}_m the class of objects X in $\mathcal{P}(n)$ with $mX = m$. (Recall from Section 3.6 that $mX = \min(|\Omega V|, |U|, |V/U|)$ for $X = (U, V) \in \mathcal{S}(n)$.) We are going to study the m -partition in detail. Before we do this, let us insert the following remark which concerns Corollary 9.13.

Remark. *The bound 33 in Corollary 9.14 is optimal: There are 33 objects in $\mathcal{P}(7)$ with boundary distance $d = 2$. Namely consider the objects in \mathcal{P}_6 , \mathcal{P}_8 , \mathcal{P}_{12} , \mathcal{P}_{14} and \mathcal{P}_{16} . For $n = 7$, the objects in \mathcal{P}_m with $m = 6, 8, 12, 14, 16$ have width 3, 4, 6, 7, 8 respectively, thus $d = m/b = 2$. And we have $|\mathcal{P}_m| = 6, 3, 3, 9, 12$, respectively.*

Lemma. *Let $n \geq 6$. Let X be an object in \mathcal{P}_m with $mX = u + nt$, where $0 \leq u \leq n-1$, then $u = 0, 1, 2, n-2, n-1$ and the width of X is $b+3t$ with $b = 1, 1, 2, 3, 3$, respectively. Thus, the m -partition refines the width-partition of the class of non-central objects in $\mathcal{P}(n)$.*

Proof. First, assume that X has quasi-length at most 5 and is u -minimal. Then (uX, bX) is just one of the 5 primitive pairs $(0, 1), (1, 1), (2, 2), (n-2, 3), (n-1, 3)$ and the width of X is as asserted. If X is not necessarily u -minimal, we look at its τ^2 -orbit: both mX and the width of X are constant on the τ^2 -orbit.

We also have to look at $X = S[6]$. We have $m(S[6]) = n = 0 + nt$ with $t = 1$, and $b(S[6]) = 4 = 1 + 3t$, as asserted.

Now any plus-orbit of non-central objects in $\mathcal{P}(n)$ contains either an object of quasi-length at most 5 or else $S[6]$. Theorem 5 asserts that $m(X^+) = mX + n$, and $b(X^+) = bX + 3$. □

Let us denote by $\mathcal{P}\langle b \rangle$ the class of objects in $\mathcal{P}(n)$ with width b . Then the Lemma asserts that for $t \geq 0$, we have

$$\begin{aligned} \mathcal{P}\langle 3t + 1 \rangle &= \mathcal{P}_{nt} \cup \mathcal{P}_{nt+1} \\ \mathcal{P}\langle 3t + 2 \rangle &= \mathcal{P}_{nt+2} \\ \mathcal{P}\langle 3t + 3 \rangle &= \mathcal{P}_{nt+n-2} \cup \mathcal{P}_{nt+n-1} \cup \mathcal{Z}(6t + 6) \end{aligned}$$

where $\mathcal{Z}(\ell)$ is the class of central objects in $\mathcal{P}(n)$ with quasi-length ℓ .

The following picture shows parts \mathcal{P}_m of the m -partition (and the cardinalities $|\mathcal{P}_m|$), as well as (using shading) parts of the width partition.

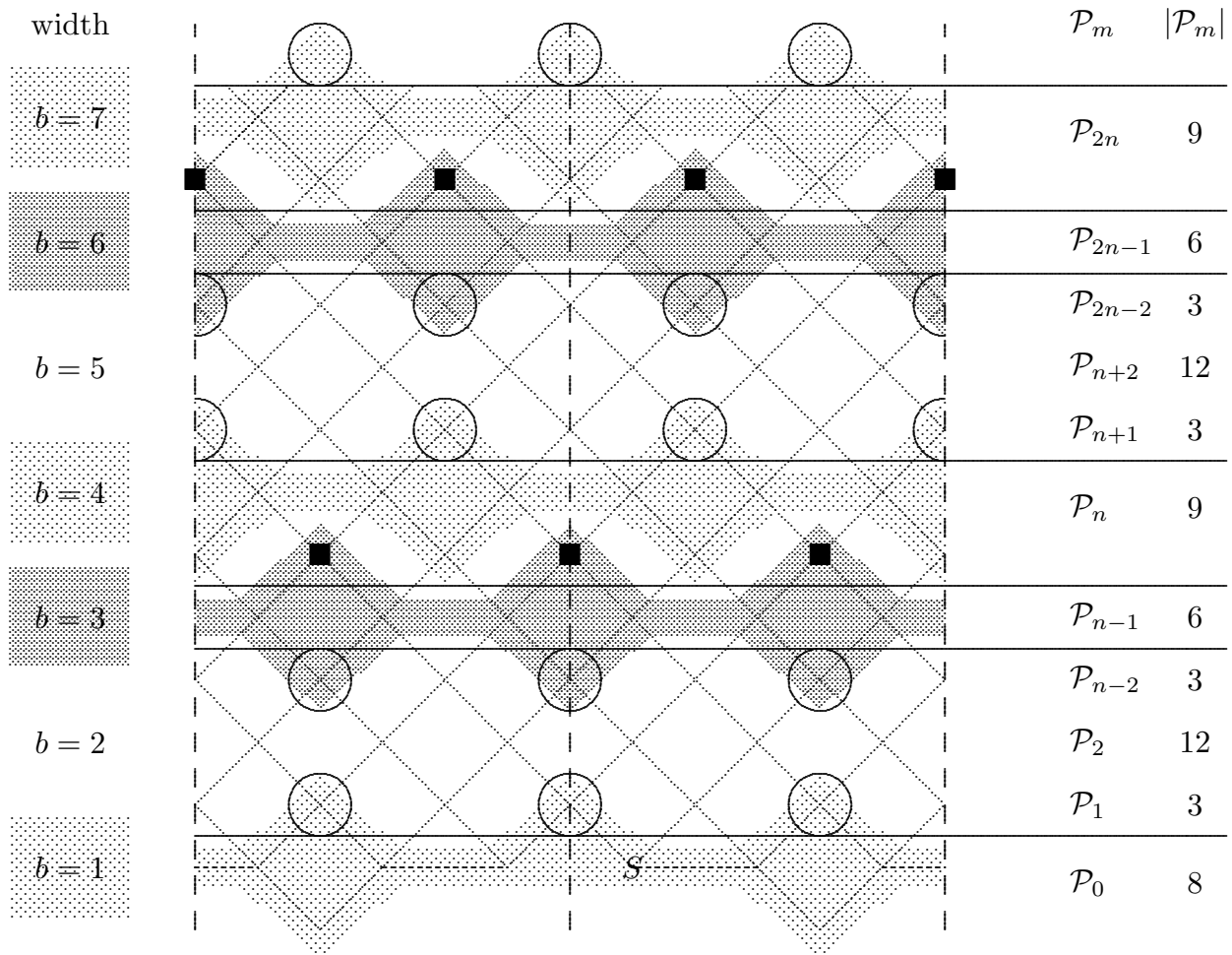

The left scale describes the width of the various shaded areas, the right scale names the parts \mathcal{P}_m (the objects in \mathcal{P}_m with $m = 1, n - 2, n + 1, 2n - 2, 2n + 1$ are encircled); the black squares \blacksquare are the central objects, they do not belong to any class \mathcal{P}_m .

Let us return to the triangle support of $\mathcal{P}(n)$. As we know, any class \mathcal{P}_m lives on a single standard triangle, thus the triangle support of the classes $\mathcal{P}\langle b \rangle$ with $b \equiv 1, 2, 3 \pmod 3$ consists of 2, 1, 2, standard triangles, respectively:

Here are the corresponding pictures for all $b \geq 1$ (for $b = 1$, one has to delete the small circle at the left lower corner):

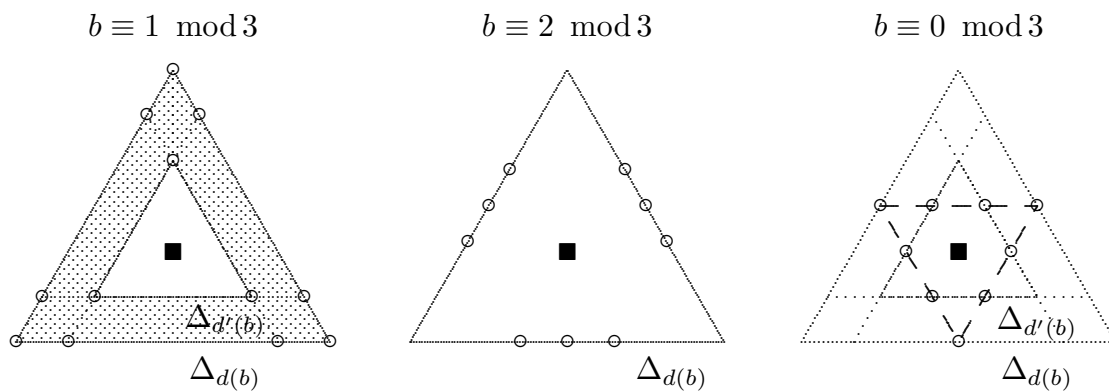

Here we write $d(3t + 1) = \frac{nt}{3t+1}$, $d'(3t + 1) = \frac{nt+1}{3t+1}$, $d(3t + 2) = \frac{nt+2}{3t+2}$, $d(3t + 3) = \frac{n(t+1)-2}{3t+3}$ and $d'(3t + 3) = \frac{n(t+1)-1}{3t+3}$.

Nablas. The last picture suggests to look not only at standard triangles, but also at costandard ones (“nablas”): The *costandard triangle* ∇_d is defined for $n/3 < d \leq n$ as follows: one of its sides is given by the line $p = d$, the remaining two are obtained using the rotations ρ and ρ^2 . One checks easily that for $b = 3t + 3$, the class $\mathcal{P}(b)$ lies on the costandard triangle $\nabla_{d''(b)}$, with $d'' = n/3 + 1/b$.

Circles. The objects X in $\mathcal{P}(n)$ with fixed odd quasi-length have equal width: if the quasi-length of X is $2b - 1$, then $bX = b$. It follows that the τ -orbit of X lies on a circle (the dashed circles in the following picture). The remaining objects are all supported by $\mathbb{D}(n)$.

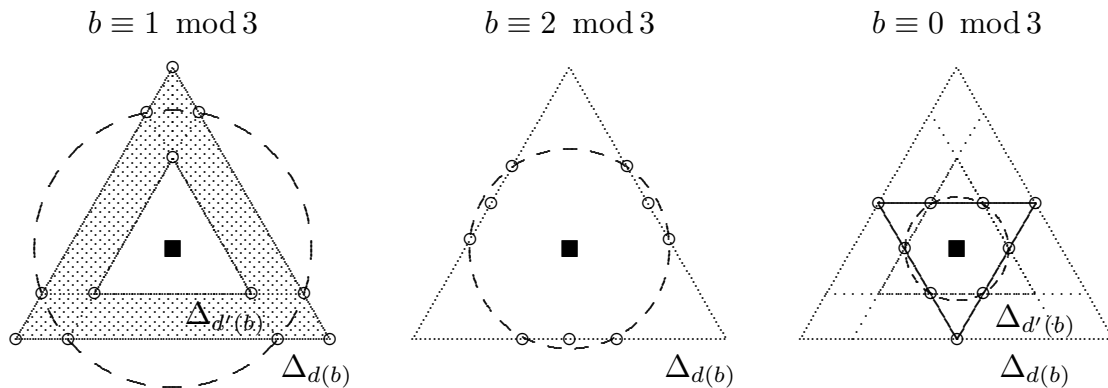

However, one should be aware that these circles just indicate that the **set** of the corresponding τ -orbit is contained in the circle, whereas the circle usually does **not** describe the action of τ on the orbit! The graph which describes the action of τ is topologically also a circle, but its embedding into the pr-triangle $\mathbb{T}(n)$ may be different, namely it looks as follows:

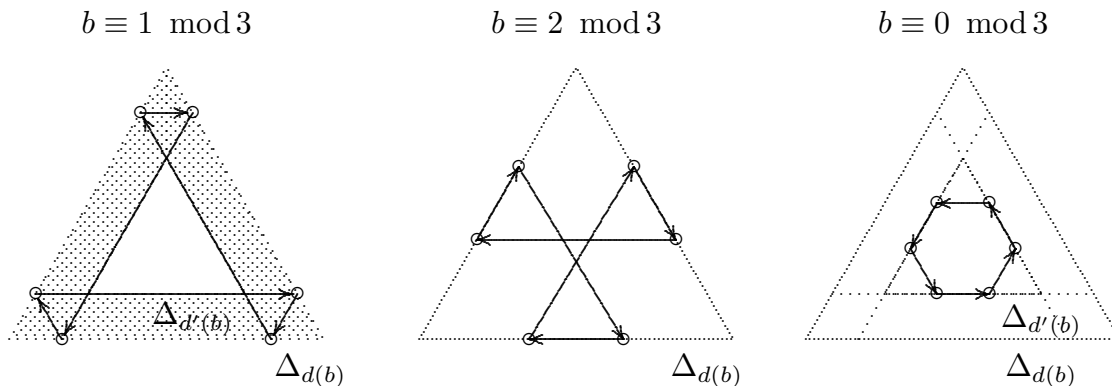

Summary. The following picture presents the pr-vectors of all the objects in $\mathcal{P}\langle b \rangle$ with $b \leq 4$.

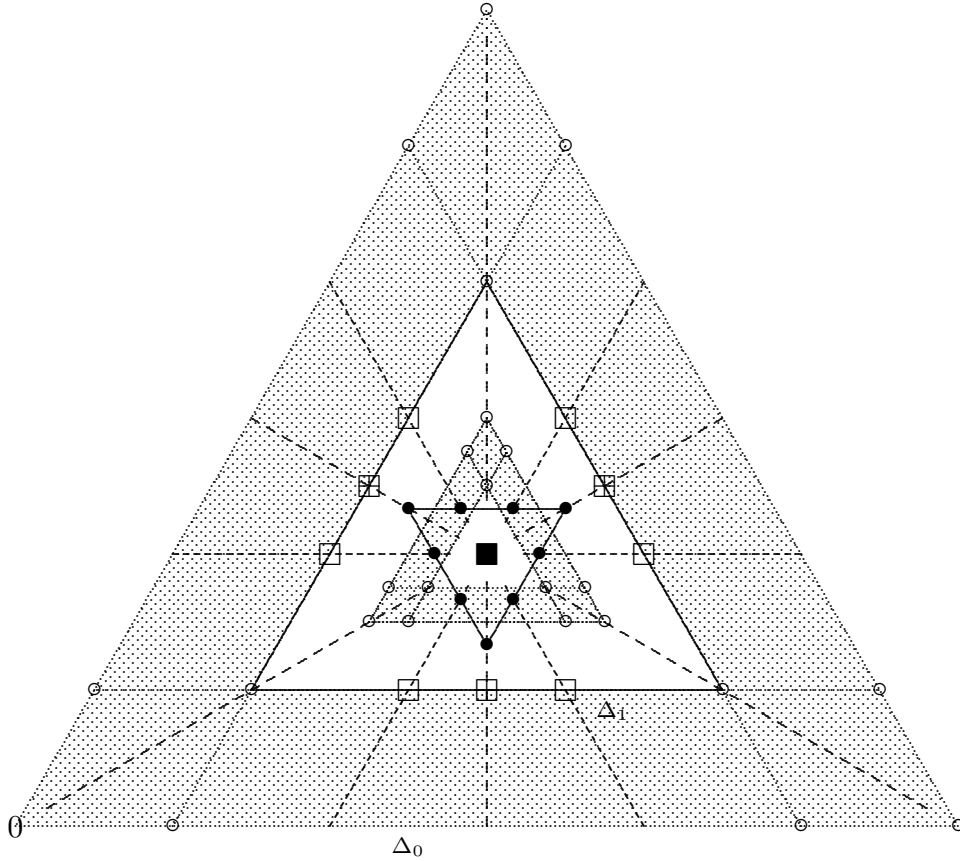

There is $\mathcal{P}\langle 1 \rangle$, it is part of the outer dotted region with boundary $\Delta_{d(1)} \cup \Delta_{d'(1)} = \Delta_0 \cup \Delta_1$; the vertices are marked by small circles. — Then there is $\mathcal{P}\langle 2 \rangle$, it is part of the solid triangle $\Delta_{d(2)} = \Delta_1$ (note that Δ_1 plays a role both for $\mathcal{P}\langle 1 \rangle$ and $\mathcal{P}\langle 2 \rangle$). The vertices for $\mathcal{P}\langle 2 \rangle$ are drawn as square boxes; the boxes on the diagonal lines are endowed with a plus sign in order to indicate that they are the pr-vectors of two isomorphism classes. — Then there is $\mathcal{P}\langle 3 \rangle$, lying on the (solid) costandard triangle $\nabla_{d''(3)}$, marked by small bullets. — Finally, $\mathcal{P}\langle 4 \rangle$ is part of the inner dotted region with boundary $\Delta_{d(4)} \cup \Delta_{d'(4)}$; the vertices are marked again by small circles. — Next, one should insert $\mathcal{P}\langle 5 \rangle$ as part of the triangle $\Delta_{d(5)}$, then $\mathcal{P}\langle 6 \rangle$ as part of $\nabla_{d''(6)}$, then $\mathcal{P}\langle 7 \rangle$, and so on.

We also have indicated the central lines in the half-line support of $\mathcal{P}(n)$, namely the lines in $\mathbb{P}(n) \cup \mathbb{D}(n)$ (but not the remaining half-lines). In the diagram, note that for $n > 6$ the six objects of quasi-length 3 in $\mathcal{P}\langle 2 \rangle$ lie on $\mathbb{K}_s(n)$, not on $\mathbb{P}(n)$, see Sections 10.3, 10.4.

10.8. The central objects in $\mathcal{P}(n)$.

Let us finish our study of the principal components $\mathcal{P}(n)$ with $n \geq 6$ by looking at the central objects in $\mathcal{P}(n)$. The central objects have quasi-length divisible by 6, thus, let us add a description of the objects in $\mathcal{P}(n)$ of quasi-length $6t$ with $t \in \mathbb{N}_0$. For $t = 0$, we deal with the two indecomposable projective objects; they belong to $\mathcal{P}\langle 1 \rangle$. For any $t \geq 1$, there

are 3 central objects, they have uwb-vector $(nt, nt, 3t)$; the remaining 3 objects belong to $\mathcal{P}\langle 3t+1 \rangle$; they have uwb-vectors $(nt, nt, 3t+1)$, $(nt, nt+n, 3t+1)$ and $(nt+n, nt, 3t+1)$; they are supported by $\mathbb{D}(n)$, and their pr-vectors are the corners of the triangle $\Delta_{nt/(3t+1)}$.

10.9. The half-line support of $\mathcal{P}(n)$, for $1 \leq n \leq 5$.

Up to now, we have considered the cases $n \geq 6$. Of course, one may also ask for the half-line support of $\mathcal{P}(n)$ for $n \leq 5$ (considering, as we did up to now, **central** half-lines). Here is the statement for $n = 5$.

The number of central half-lines which contain the pr-vector of a non-central object in $\mathcal{P}(5)$ is 30. First of all, there are the 12 half-lines in $\mathbb{P}(5) \cup \mathbb{D}(5)$. The additional 18 half-lines pass through the τ -orbits of S , E_2^3 and $(0, [2])$. The half-lines which pass through the objects in the τ -orbit of E_2^3 are complementary to the half-lines which pass through the objects in the τ -orbit of $(0, [2])$.

Proof. Parts of $\mathcal{P}(5)$ can be constructed in the same way as $\mathcal{P}(n)$ is constructed, for $n \geq 6$. The indecomposable projective objects are said to have quasi-length 0. Then we consider the τ -orbit of $S = (0, [1])$ and we call these the objects of quasi-length 1. The non-projective neighbors of objects of quasi-length 1 are said to have quasi-length 2. We proceed in this way in order to construct the objects of quasi-length 2 to 5. When we try to construct objects of quasi-length 6, we obtain no longer indecomposable objects: what we get are two τ -orbits, namely the τ -orbit of $([1], [3])$, and the τ -orbit of E_2^2 ; both τ -orbits live on the diagonal lines. Finally, there is a further τ -orbit, namely the τ -orbit of $(0, [2])$.

As we see: most of the indecomposables live on the diagonal lines and on the central lines parallel to the boundary, namely (as in the cases $n \geq 7$) the objects of quasi-length 0, 2, 4, and 5, but in addition also those in two of the three new orbits. The only exceptions are the τ -orbit of S , the objects of quasi-length 3 (this is the τ -orbit of E_2^3), as well as one of the new orbits, namely the orbit of $(0, [2])$. In order to see that we obtain in this way 18 additional half-lines, we look at the triangles \mathbb{F}_1 and \mathbb{F}_2 of vectors (p, r) with $p \leq r \leq \frac{1}{3}n$ and $\frac{1}{3}n \leq r \leq \frac{1}{2}(n-p)$, respectively. The object S lies in the interior of \mathbb{F}_1 (since $0 < 1 < \frac{5}{3}$, we have $p < r < \frac{1}{3}n$); the object E_2^3 also lies in the interior of \mathbb{F}_1 (since $1 < \frac{3}{2} < \frac{5}{3}$, we again have $p < r < \frac{1}{3}n$). Note that S and E_2^3 live on different central half-lines (since there is no a such that $(1-a)(\frac{5}{3}, \frac{5}{3}) + a(0, 1) = (1, \frac{3}{2})$). The object $(0, [2])$ lives in the interior of \mathbb{F}_2 (since $\frac{5}{3} < 2 < \frac{5}{2}$ we have $\frac{1}{3}n < r < \frac{1}{2}(n-p)$). Altogether we obtain three different central half-lines inside $\mathbb{F}_1 \cup \mathbb{F}_2$.

It remains to observe that $\tau^5(0, [2]) = ([3], [5])$ and that the central half-lines passing through E_2^3 and $([3], [5])$ are complementary. \square

Summary. Let g be the number of central lines with non-central objects of $\mathcal{P}(n)$ living on both of its central half-lines (for $n \neq 5$, these lines turn out to be diagonal lines or central lines parallel to the boundary, thus lines in $\mathbb{P}(n) \cup \mathbb{D}(n)$). Let h be the number of half-lines in the half-line support of $\mathcal{P}(n)$ such that the complementary half-line does not belong to the half-line support. Thus $g+h$ is the number of central **lines** which pass through non-central objects in $\mathcal{P}(n)$, whereas $2g+h$ is the number of central **half-lines**

which pass through non-central objects in $\mathcal{P}(n)$.

n	1	2	3	4	5	6	7	8	9	...
g	0	2	3	3	12	6	6	6	6	...
h	2	1	2	6	6	6	12	12	12	...
$g + h$	2	3	5	9	18	12	18	18	18	...
$2g + h$	2	5	8	12	30	18	24	24	24	...

We have separated the representation types: finite, tame, wild. For $n \leq 5$, we deal with finite type, the dotted case $n = 6$ is tame, the cases $n \geq 7$ are wild. Note that for the wild cases, the numbers do not change. It comes as a surprise that all the numbers g , $g + h$ and $2g + h$ in the tame case are much smaller than the corresponding ones in the finite case $n = 5$.

These numbers concern **central** half-lines and lines. If we allow also non-central lines, we get different numbers, at least in the finite type cases. There is the following interesting observation: *If X is an indecomposable object in $\mathcal{S}(5)$, then at least one of the numbers pX , qX , rX is an integer.* This may be reformulated as follows: If X is an indecomposable object in $\mathcal{S}(n)$, then $\mathbf{pr} X$ lies on one of the 15 lines $p = 0, 1, 2, 3, 4$, or $q = 1, 2, 3, 4, 5$, or $r = 0, 1, 2, 3, 4$. But actually, one checks easily that X lies on one of the **seven** lines $p = 1, 2$, or $q = 3, 4, 5$, or $r = 1, 2$.

10.10. The triangle support of $\mathcal{P}(n)$, for $1 \leq n \leq 5$.

We also look at the triangle support of $\mathcal{S}(n)$, where $1 \leq n \leq 5$. We denote by $\Psi(\mathcal{S}(n))$ the set of numbers d of the form $d = u/b$, where $u = uX$, and $b = bX$ for some indecomposable object X in $\mathcal{S}(n)$ which is u -minimal and not central.

It is easy to see that

$$\Psi(\mathcal{S}(1)) = \Psi(\mathcal{S}(2)) = \Psi(\mathcal{S}(3)) = \{0\},$$

and that

$$\Psi(\mathcal{S}(4)) = \{0, 1\}.$$

For $n = 5$, we get (see for example 15.1) that

$$\Psi(\mathcal{S}(5)) = \{0, 1, 4/3, 3/2\}.$$

Actually, looking at the case $n = 5$, we see that it is very convenient to work with costandard triangles, since it turns out that the indecomposable objects in $\mathcal{S}(5)$ which live on $\Delta_{4/3}$ and $\Delta_{3/2}$ all have support in ∇_2 .

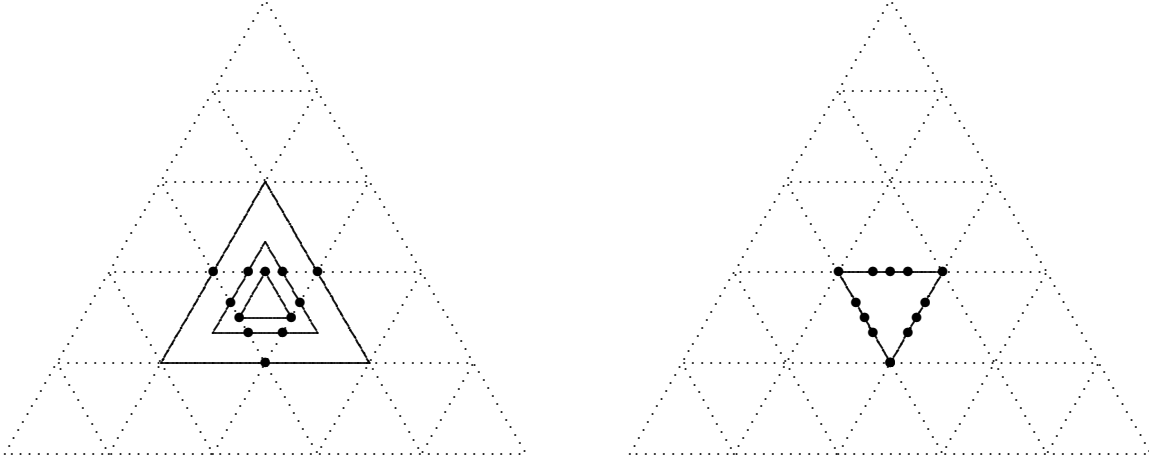

We see: A single nabla takes care of a lot of indecomposables which live on different triangles. In particular, we can describe $\mathcal{S}(5)$ by using (central half-lines as well as) just two standard triangles and one costandard triangle.

* * *

The principal component $\mathcal{P}(n)$ is closed under the duality D . Components which are closed under duality have some special properties which we are going to mention at the end of this Section.

10.11. Components closed under duality.

As we will see in 10.12, the τ -orbits of components closed under duality have a quite restricted behaviour. In 10.11, we describe basic properties of components which are closed under duality.

Lemma. (a) *Let \mathcal{C} be an Auslander-Reiten component of $\mathcal{S}(n)$, where $n \geq 2$. The following conditions are equivalent:*

- (i) *\mathcal{C} is closed under duality.*
- (ii) *All τ -orbits in \mathcal{C} are closed under duality.*
- (iii) *There is a τ -orbit in \mathcal{C} which is closed under duality.*
- (iv) *There is an object X in \mathcal{C} such that $D X$ belongs to \mathcal{C} .*
- (v) *There exists an object X in \mathcal{C} which is self-dual.*

(b) *If $n \geq 6$ there is the following additional equivalent condition.*

- (vi) *There are infinitely many objects X in \mathcal{C} which are self-dual.*

Proof: The duality D is a contravariant equivalence, thus it sends an irreducible map $X \rightarrow Y$ to an irreducible map $D Y \rightarrow D X$. It follows that it sends Auslander-Reiten components to Auslander-Reiten components, thus (iv) implies (i). For $n \geq 6$, the duality preserves the quasi-length of an indecomposable object X . This shows that (i) implies (ii) in case $n \geq 6$. For the cases $n \leq 5$, the implication (i) implies (ii) can be checked easily.

Of course, (ii) implies (iii), and (iii) implies (iv). Also, (v) implies (iv).

Finally, let us show that (ii) implies (v). We assume (ii).

First, let us show that there is at least one object in \mathcal{C} which is self-dual. The component $\mathcal{C} = \mathcal{P}(n)$ for $n \geq 2$ satisfies (v): namely, there is $X = ([1], [2])$ in $\mathcal{P}(n)$. Thus, we can assume that $n \geq 6$ and that \mathcal{C} is a stable tube. Let Z belong to the boundary of \mathcal{C} , thus, according to (ii), $DZ = \tau^i Z$ for some $i \geq 0$. Let $X = (\tau^i Z)[i+1]$. We claim that DX is isomorphic to X . Namely, the chain of irreducible epimorphism $\tau^i(Z[i+1]) \rightarrow \cdots \rightarrow \tau(Z[2]) \rightarrow Z$ is sent under D to the chain of irreducible monomorphism $D\tau^i(Z[i+1]) \leftarrow \cdots \leftarrow D\tau(Z[2]) \leftarrow DZ$. Since $DZ = \tau^i Z$, we see that $D\tau^i(Z[i+1]) \simeq (\tau^i Z)[i+1]$, thus X is self-dual.

For part (b), it remains to observe: If X is self-dual, then also X^+ is self-dual. \square

Remark. If X belongs to a component which is closed under duality, then (ii) asserts that $DX = \tau^i X$ for some $0 \leq i \leq 5$. Note that all cases do occur: The τ -orbit of S yields (for $n \geq 3$) objects X with $i = 1, 3, 5$ (and the minimal τ -period of S is 6). The τ -orbit of $([1], [2])$ yields (for $n \geq 4$) objects X with $i = 0, 2, 4$ (and the minimal τ -period of $([1], [2])$ is 6). Of course, the case $i = 0$ has already been addressed in (v).

10.12. The τ -orbits closed under duality.

Proposition. *Let \mathcal{O} be a τ -orbit in $\mathcal{S}(n)$ which is closed under duality and which contains an object which does not lie on a diagonal line. Then \mathcal{O} has cardinality 6, lies on a central circle, and no object in \mathcal{O} belongs to a diagonal line. There are the following two possibilities:*

- (a) *The half-line support of \mathcal{O} is $\mathbb{P}(n)$.*
- (b) *The half-line support of \mathcal{O} consists of six central half-lines outside of $\mathbb{P}(n)$ and does not contain half-lines which are complementary.*

Proof. We assume that $X \in \mathcal{O}$ does not lie on a diagonal line. In particular, X is not central, thus $X, \tau^2 X$, and $\tau^4 X$ have pairwise different pr-vectors. Also, by assumption, D maps \mathcal{O} into itself. Since X does not lie on a diagonal line, the pr-vectors of the objects in \mathcal{O} are six points on a central circle — this set is the orbit of $\mathbf{pr} X$ under the symmetry group Σ_3 of $\mathbb{T}(n)$.

If \mathcal{O} lies inside $\mathbb{P}(n)$, all objects in \mathcal{O} lie on the central lines parallel to the boundary, and the half-line support of \mathcal{O} are the six central half-lines parallel to the boundary. This is case (a).

If \mathcal{O} does not lie inside $\mathbb{P}(n)$, then we consider as in 10.9 the triangles \mathbb{F}_1 and \mathbb{F}_2 of all vectors (p, r) with $p \leq r \leq \frac{1}{3}n$ and $\frac{1}{3}n \leq r \leq \frac{1}{2}(n-p)$, respectively. Since one point in \mathcal{O} is contained in the union of the interiors $\mathbb{F}_1^\circ \cup \mathbb{F}_2^\circ$, the remaining ones are obtained by applying Σ_3 . Note that for each i , the union $\cup_{\sigma \in \Sigma_3} \sigma \cdot \mathbb{F}_i^\circ$ does not contain points on complementary half-lines. This yields case (b). \square

Remark 1. A typical example of case (a) are the objects of quasi-length 3 in $\mathcal{P}(6)$. A typical example of case (b) are the objects of quasi-length 1 in $\mathcal{P}(6)$.

Remark 2. If the τ -orbit \mathcal{O} is a closed under duality, and contains an object which lies on a diagonal line, there are many possibilities:

- $|\mathcal{O}| \leq 2$, and then all objects in \mathcal{O} are central; see for $n = 6$ the objects in any stable tube of rank 1 or 2. Thus, the half-line support of \mathcal{O} is empty.

- $|\mathcal{O}| = 3$, and all objects in \mathcal{O} are central: see for $n = 6$ the τ -orbit of $([4, 2], [6, 3, 3])$. Again, the half-line support of \mathcal{O} is empty. The objects in this and in the following two examples occur in the tube of rank 3 with rationality index 0.
- $|\mathcal{O}| = 3$, no object in \mathcal{O} is central, and the half-line support of \mathcal{O} consists of the three diagonal half-lines which contain the corners of $\mathbb{T}(6)$: see for $n = 6$ the τ -orbit of $([3], [4, 2])$.
- $|\mathcal{O}| = 3$, no object in \mathcal{O} is central, and the half-line support of \mathcal{O} consists of the three diagonal half-lines which do not contain the corners of $\mathbb{T}(6)$: see for $n = 6$ the τ -orbit of $([3], [6])$.
- $|\mathcal{O}| = 6$, and all objects in \mathcal{O} are central: see for $n = 6$ the objects of quasi-length 6 in any stable tube. Again, the half-line support of \mathcal{O} is empty.
- $|\mathcal{O}| = 6$, and precisely 3 objects in \mathcal{O} are central: for $n = 6$, see the objects of quasi-length 6 in $\mathcal{P}(6)$, or see the objects of quasi-length 2 or 4 in the tube of rank 6 with rationality index 1 (for quasi-length 2, the half-lines contain the corners of $\mathbb{T}(6)$; for quasi-length 4, we obtain the complementary half-lines).
- $|\mathcal{O}| = 6$, no object in \mathcal{O} is central, and the half-line support of \mathcal{O} are three central half-lines: see the objects of quasi-length 4 in $\mathcal{P}(6)$ (here, the half-lines do not contain the corners of $\mathbb{T}(6)$; is there a similar example where the half-lines contain the corners? There is no such example for $n = 6$; after all $\mathcal{S}(6)$ has only two components of rank 6 which are self-dual.)
- $|\mathcal{O}| = 6$, no object in \mathcal{O} is central, and the half-line support of \mathcal{O} consists of six half-lines: see the objects of quasi-length 2 in $\mathcal{P}(6)$.

Remark 3. If X belongs to a component which is **not** closed under duality, X may lie on a diagonal line, whereas τX does not lie on a diagonal line. See the example 10.2.

Remark 4. For $n = 6$, there are just 6 components which are closed under duality and which are not homogeneous tubes, namely the non-homogeneous components with rationality index 0 and 1. (In section 12 we will consider the case $n = 6$ in detail, based on our previous investigations in [RS1]. In particular, we will recall the rationality index of any component in $\mathcal{S}(6)$, it is a non-negative rational number.)

It follows from Lemma 10.11 that there are infinitely many indecomposable objects X in $\mathcal{S}(6)$ which are self-dual. If $n < n'$, any self-dual indecomposable object in $\mathcal{S}(n)$ yields a component in $\mathcal{S}(n')$ which is closed under duality, thus, using again Lemma 10.11, we obtain many new indecomposable objects which are self-dual, and, in this way, components which are closed under duality. It follows: *For $n \geq 7$, there are infinitely many components which are closed under duality and which are not homogeneous.*

Fourth part: The case $n = 6$.

11. The case $n = 6$.

Here we consider the case $n = 6$. We are going to determine the half-line support as well as the triangle support of the whole category $\mathcal{S}(6)$. The main results to be established are Theorems 7 and 8. For the proofs, we need details about the category $\mathcal{S}(6)$ which have been obtained in our previous paper [RS1], a report will be given in 11.1. In particular, the root system for the covering $\tilde{\mathcal{S}}(6)$ will play an essential role. Some of the considerations in this section will be parallel to arguments presented in [RS1] in order to compare the invariants u and v (or u and w). As we mentioned already, in the new paper we focus the attention to b as an additional relevant invariant, and the formulae in Theorem 7 provide a corresponding comparison of b with u, v, w .

11.1. The structure of the category $\mathcal{S}(6)$. (A report).

In order to deal with $\mathcal{S}(6)$, we follow the previous paper [RS1]. In particular, we use again covering theory as explained in 2.3. In this way, the classification problem for $\mathcal{S}(6)$ was reduced in [RS1] to deal with tubular algebras.

Since the principal component $\mathcal{P}(6)$ is known, we may concentrate on the objects of $\mathcal{S}(6)$ which lie in stable tubes. In order to deal with the objects which lie in stable tubes, we use as in [RS1] the following algebra Θ , with vertices $0, 1, \dots, 6$ and $2', 3', 4'$,

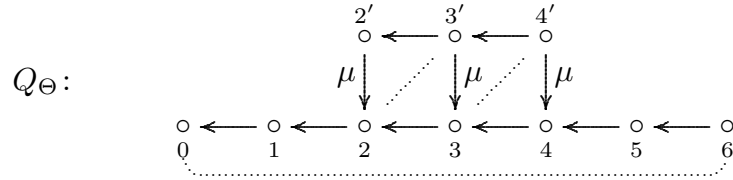

with two commutativity relations and one zero relation. Given a representation M of Θ , let VM be the restriction of M to the full subquiver with vertices $0, 1, \dots, 6$ (this is a Θ -submodule of M), and let UM be the submodule of VM generated by M_0, M_1 and the images of the three maps μ .

Note that VM is a representation of the quiver \mathbb{Z} (with vertex set \mathbb{Z} and with arrows $(i-1) \leftarrow i$ for all $i \in \mathbb{Z}$). Starting with a finite-dimensional representation V of the quiver \mathbb{Z} , let πV be the $k[T]$ -module with underlying vector space $\bigoplus_{i \in \mathbb{Z}} V_i$, and with T operating on this vector spaces via the given maps $V_{i-1} \leftarrow V_i$. Starting with a representation M of Θ , the zero relation of Θ shows that the $k[T]$ -module $\pi(VM)$ belongs to $\mathcal{N}(6)$. Due to the commutativity relations, $\pi(UM)$ is an invariant subspace of $\pi(VM)$. Altogether, we obtain a functor $\pi: \text{mod } \Theta \rightarrow \mathcal{S}(6)$, namely $\pi M = (\pi(UM), \pi(VM))$.

The algebra Θ is a tubular algebra, see [RS1]. The shape of the category of Θ -modules is as follows:

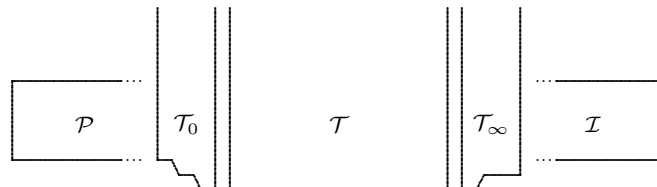

There are a preprojective component \mathcal{P} of type $\widetilde{\mathbf{E}}_7$, a preinjective component \mathcal{I} of type $\widetilde{\mathbf{E}}_8$, as well as tubular families \mathcal{T}_γ with γ a non-negative rational number or the symbol ∞ . In [RS1], the number γ was called the index of the modules in \mathcal{T}_γ ; in order to be more specific, we now prefer to call it the *rationality index*. Let $\mathcal{T} = \bigcup_{0 < \gamma < \infty} \mathcal{T}_\gamma$. Note that the indecomposable projective Θ -modules corresponding to the vertices different from $4'$ and 6 belong to \mathcal{P} , the remaining two belong to a tube of rank 6 in \mathcal{T}_0 . The indecomposable injective Θ -modules corresponding to the vertices different from 0 belong to \mathcal{I} , the remaining one belongs to a tube of rank 6 in \mathcal{T}_∞ .

We denote by $'\mathcal{D}$ the union of \mathcal{T} and the stable tubes in \mathcal{T}_0 . Note that $'\mathcal{D}$ can be considered as part of the fundamental region of the universal covering $\widetilde{\mathcal{S}}(6)$ of $\mathcal{S}(6)$ under the shift operation (the fundamental region was labelled \mathcal{D} in [RS1]), and π can be considered as part of the pushdown functor from $\widetilde{\mathcal{S}}(6)$ to $\mathcal{S}(6)$. It has been shown in [RS1] that π provides a bijection between $'\mathcal{D}$ and the class of those objects in $\mathcal{S}(6)$ which lie in stable tubes. For X in a stable component, we define \widetilde{X} as the Θ -module $\widetilde{X} = M$ in $'\mathcal{D}$ with $\pi M = X$ (according to [RS1], M exists and is uniquely determined). In this way, we obtain a bijection π between the class of Θ -modules in $'\mathcal{D}$ and the objects in $\mathcal{S}(n)$ which belong to stable tubes.

Using this bijection, we attach to any indecomposable object in $\mathcal{S}(6)$ its *rationality index*; it is a non-negative rational number. If X in $\mathcal{S}(6)$ belongs to a stable component, the *rationality index* of X is just the rationality index of \widetilde{X} . If X belongs to $\mathcal{P}(6)$, then, by definition, its rationality index is 0 (of course, if X belongs to $\pi(\mathcal{T}_0)$, its rationality index is also 0, whereas if X is in $\pi\mathcal{T}$, then its rationality index is positive).

We also need the algebra Ξ , obtained from Θ by deleting the vertices 0 and $4'$. The algebra Ξ is a tilted algebra of type \mathbf{E}_8 . If M is an indecomposable Θ -module, then $\mathbf{dim} M$ is a radical vector or a positive root of χ_Θ , and we can write

$$\mathbf{dim} M = \mathbf{r} + a_0 \mathbf{h}_0 + a_\infty \mathbf{h}_\infty,$$

where $\mathbf{r} = \mathbf{r}(M)$ is either zero or a (positive or negative) root of χ_Ξ , where

$$\mathbf{h}_0 = \begin{matrix} 2 & 1 & 0 \\ 1 & 2 & 3 & 3 & 2 & 1 & 0 \end{matrix}, \quad \mathbf{h}_\infty = \begin{matrix} 2 & 2 & 1 \\ 0 & 1 & 2 & 3 & 3 & 2 & 1 \end{matrix},$$

and where $a_0 = \dim M_0$ and $a_\infty = \dim M_{4'}$. In case $\mathbf{r} = 0$, the fraction a_∞/a_0 is just the *rationality index* of M . (For further information about the root system of Ξ , we refer to Appendix A.) If X belongs to a stable tube of $\mathcal{S}(6)$, let $\mathbf{r}(X) = \mathbf{r}(\widetilde{X})$. In this way, we attach to any indecomposable object of $\mathcal{S}(6)$ which belongs to a stable tube an element of \mathbb{R}^8 which is a root of χ_Ξ or the zero vector.

Starting with an indecomposable object X in $\mathcal{S}(6)$, it often is of interest to know its rationality index. The following Lemma shows that for some objects X in $\mathcal{S}(6)$, the width of X provides at least some partial information: It shows that for all objects X in stable tubes with $\mathbf{r}(X) = 0$, there are coprime positive integers i, j with $bX = 3(i + j)$, such that the rationality index of X is i/j .

Lemma. *Let M be an indecomposable $k\Theta$ -module which belongs to \mathcal{T}_γ , where $\gamma = i/j$ with coprime positive integers i, j . Assume that the endomorphism ring of M is k and that M has non-trivial self-extensions. Then*

$$bM = 3(i + j).$$

Proof. By assumption, M belongs to a stable tube, say of rank r . Since $\text{End}(M) = k$, the quasi-length ℓ of M is at most r , since $\text{Ext}^1(M, M) \neq 0$, we have $\ell \geq r$. Thus, $\ell = r$. Using again that $\text{End}(M) = k$, we see that $\mathbf{dim} M = j\mathbf{h}_0 + i\mathbf{h}_\infty$. Since $b\mathbf{h}_0 = b\mathbf{h}_\infty = 3$, we have $bM = 3(i + j)$. \square

Let us also mention that the rationality index of any indecomposable non-projective object $X \in \mathcal{S}(6)$ determines the indices of the objects in its Σ_3 -orbit: The objects X , $\tau^2 X$ and $\tau^4 X$ have the same rationality index, since they belong to the same tube as X . If X has rationality index $\gamma = 0$ or 1 , the object DX belong to the same tube as X , thus DX has the same rationality index as X . Finally, if X has rationality index $\gamma \neq 0, 1$, the object DX has rationality index γ^{-1} . (It is enough to verify this for the objects X of quasi-length 6. In this case, we have $\mathbf{r}(X) = 0$, thus $\mathbf{dim} \tilde{X} = a_0\mathbf{h}_0 + a_\infty\mathbf{h}_\infty$, and the rationality index is a_∞/a_0 . For $Y = DX$, we have $\mathbf{dim} \tilde{Y} = a_\infty\mathbf{h}_0 + a_0\mathbf{h}_\infty$, thus the rationality index of Y is a_0/a_∞ .)

11.2. The width.

Lemma. *If M is an indecomposable Θ -module which belongs to a stable tube, then*

$$b(\pi M) = \dim M_3.$$

Proof. Let $\overline{\mathcal{R}}$ be the class of indecomposable Θ -modules which belong to stable tubes. We denote by $\overline{S(2)}$ the 2-dimensional indecomposable Θ -module with $\overline{S(2)}_2 = k = \overline{S(2)}_{2'}$. The essential observation for the proof of Lemma is the fact that $\overline{S(2)}$ belongs to the non-stable tube in \mathcal{T}_0 and that $S(4)$ belongs to the non-stable tube in \mathcal{T}_∞ .

Given any algebra A , and indecomposable A -modules X, Y , we say that X is a *predecessor* of Y provided there is a sequence $X = X_0, X_1, \dots, X_t = Y$ of A -modules such that $\text{Hom}_A(X_{i-1}, X_i) \neq 0$.

Note that $\text{Ext}^1(Y, X) \neq 0$ implies that X is a predecessor of Y . In the case of $A = \Theta$, we see in this way that $S(0)$ is a predecessor of $S(1)$, that $S(1)$ is a predecessor of $\overline{S(2)}$, that $S(4)$ is a predecessor of $S(5)$, and that $S(5)$ is a predecessor of $S(6)$.

On the other hand, since Θ is a tubular algebra, we know that no module in \mathcal{R} is a predecessor of $\overline{S(2)}$ (since $\overline{S(2)}$ belongs to the non-stable tube in \mathcal{T}_0), and $S(4)$ is not a predecessor of any module in \mathcal{R} (since $S(4)$ belongs to the non-stable tube in \mathcal{T}_∞).

Let M be a Θ -module in \mathcal{R} . We claim that the maps $M_{i-1} \leftarrow M_i$ are injective, for $4 \leq i \leq 6$ (thus, equivalently, that $S(i)$ with $i = 4, 5, 6$ is not a submodule of VM) and that the maps $M_{i-1} \leftarrow M_i$ are surjective, for $1 \leq i \leq 3$ (thus, equivalently, that $S(i)$ with $i = 0, 1, 2$ is not a factor module of VM).

Namely, if $S(i)$ is a submodule of VM , then $0 \neq \text{Hom}(S(i), VM) \subseteq \text{Hom}(S(i), M)$, therefore $S(i)$ is a predecessor of M . As we have mentioned, this is not the case for $M \in \mathcal{R}$ and $i = 4, 5, 6$. Similarly, if $S(0)$ or $S(1)$ is a factor module of VM , then $S(0)$ or $S(1)$ is a factor module of M itself, thus M is a predecessor of $S(0)$ or $S(1)$, respectively. Again, for $M \in \mathcal{R}$, this is not the case. The situation is slightly more complicated for $i = 2$: If $S(2)$ is a factor module of VM , then we may have $\text{Hom}(M, S(2)) = 0$, but at least we have $\text{Hom}(M, \overline{S(2)}) \neq 0$, thus M is a predecessor of $\overline{S(2)}$. Again, for $M \in \mathcal{R}$ this is not the case.

This shows that for $M \in \mathcal{R}$, the maps $M_{i-1} \leftarrow M_i$ are injective, for $4 \leq i \leq 6$, and the maps $M_{i-1} \leftarrow M_i$ are surjective, for $1 \leq i \leq 3$. But this implies that $b\pi(VM) = \dim M_3$ (and, of course, $b\pi(VM) = b(\pi M)$). \square

Remark. The formula given by the lemma is very important for dealing with those indecomposable objects in $\mathcal{S}(6)$ which belong to stable tubes. The assumption that we deal with stable tubes is essential. We stress that there is no corresponding formula for the remaining indecomposable objects of $\mathcal{S}(6)$, those belonging to the principal component $\mathcal{P}(6)$.

There are two facts which one has to be aware of. First of all, there are many objects in $\mathcal{P}(6)$ which are not of the form πM where M is a $k\Theta$ -module. This concerns not only the two projective objects but also all the objects of $\mathcal{P}(6)$ which occur in the intersection of the ray starting in the projective object $(0, [6])$ with the coray ending in the projective object $([6], [6])$. Second, even if X in $\mathcal{P}(6)$ is of the form $X = \pi M$ for some Θ -module M in \mathcal{T}_0 , we may have $bX \neq \dim M_3$. A typical example is the object $X = S[6]$ with $bX = 4$, but $\dim M_i \leq 3$ for all vertices i .

Of course, this really does not matter, since all the objects of $\mathcal{P}(6)$, in particular also their width, are known, see 9.5, 9.10, as well as 10.6, 10.7.

11.3. Central objects.

Lemma. *If M is an indecomposable Θ -module which belongs to a stable tube, and $\mathbf{dim} M$ is a radical vector, then πM is a central object.*

Proof. We have $\mathbf{dim} M = a_0 \mathbf{h}_0 + a_\infty \mathbf{h}_\infty$, therefore $v(\pi M) = 12a_0 + 12a_\infty$. According to the Lemma in (11.2), we have $b(\pi M) = \dim M_3 = 3a_0 + 3a_\infty$. Thus $q(\pi M) = v(\pi M)/b(\pi M) = 4$. \square

Remark. The assumption in the Lemma that M belongs to a stable tube is essential. Namely, the object $S[6]$ in $\mathcal{P}(n)$ is of the form πM with $\mathbf{dim} M = \mathbf{h}_0$, thus $\mathbf{dim} M$ is a radical vector, whereas $\mathbf{pr} S[6] = (6/4, 6/4)$ is not central.

11.4. Proof of Theorem 7.

Lemma 1. *Any indecomposable Θ -module M satisfies the inequality*

$$|vM - 4 \dim M_3| \leq 4.$$

Proof. We have $\mathbf{dim} M = \mathbf{r} + a_0 \mathbf{h}_0 + a_\infty \mathbf{h}_\infty$, where \mathbf{r} is zero or a root of χ_Ξ . The function $v(M) - 4 \dim M_3$ is additive on the Grothendieck group and vanishes on \mathbf{h}_0 as well as on \mathbf{h}_∞ , thus we only have to look at its values on the roots of χ_Ξ . As in the proof of (2.4.1) in [RS1], we use the fact that the roots of χ_Ξ are explicitly known (they are related to the roots of \mathbf{E}_8 , since Ξ is a tilted algebra of type \mathbf{E}_8 , see Appendix A.1). It is quite easy to verify the desired inequality for the roots \mathbf{r} . \square

Lemma 2. *For all indecomposable X in stable tubes of $\mathcal{S}(6)$, we have $|vX - 4 \cdot bX| \leq 4$.*

Proof. Let $X = \pi M$, where M is an indecomposable Θ -module which belongs to a stable tube. According to 11.2, we have $bX = b(\pi M) = \dim M_3$. Of course, we have $vX = vM$. Thus Lemma 1 shows that $|4bX - vX| = |4 \dim M_3 - vM| \leq 4$. \square

Proof of Theorem 7. Let us write $\eta X = vX - 4 \cdot bX$. According to Lemma 2, we have $|\eta| \leq 4$ in case X belongs to a stable tube. Thus, it remains to show the same in case X belongs to the principal tube.

The values of b, u, w , thus also of $v = u + w$, on the principal tube are exhibited in Section 9.5. As a consequence, we have the following values of η on the objects $Z[\ell]$ with Z ray-simple and $0 \leq \ell \leq 8$ in the principal component:

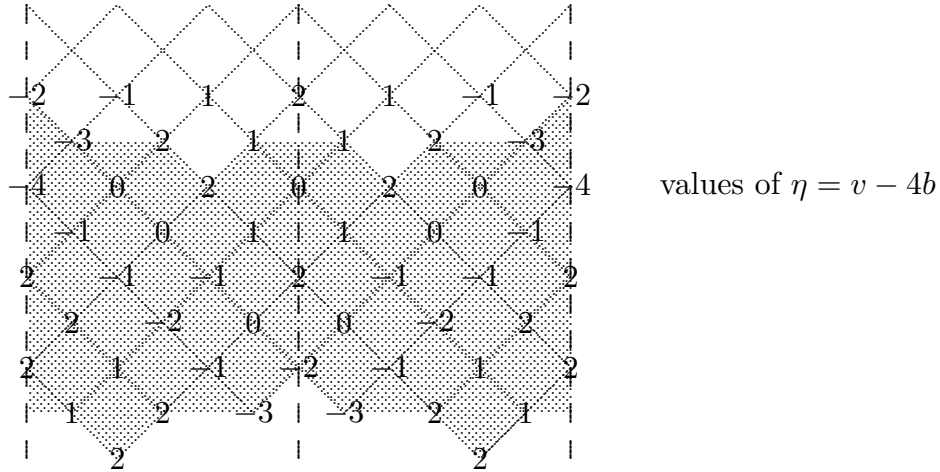

(Actually, we do not have to refer to 9.5. Since η is additive on the adjusted tube, we only have to determine the values of η at the boundary of the adjusted tube (the corresponding objects all are pickets), and use the additivity of η .)

As we see, we have $\eta Z^+ = \eta Z$ for all objects Z on the boundary of the adjusted translation quiver. Again, using the additivity of η , it follows that $\eta X^+ = \eta X$ for all X in the principal component. We conclude that $-4 \leq \eta X \leq 2$ for all X in the principal component; a fortiori, $|\eta X| \leq 4$. \square

Remark. As we have seen, we have the inequalities $-4 \leq v - 4b \leq 2$ for all $X \in \mathcal{P}(6)$. Let us add that we also have the inequalities $-2 \leq u - 2b \leq 4$. Here are the values of $u - 2b$:

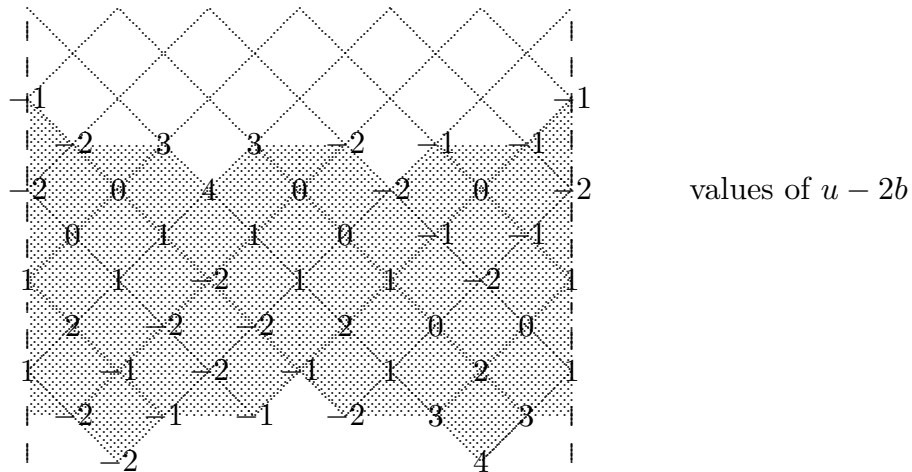

By duality, we similarly have $-2 \leq w - 2b \leq 4$ on $\mathcal{P}(6)$.

11.5. A finiteness result.

Proposition. *For any $a < 2$, there are only finitely many indecomposable objects $X \in \mathcal{S}(6)$ with $dX \leq a$.*

For the proof, we need some preparation. Let $\eta X = vX - 4 \cdot bX$. The inequality $|\eta Y| \leq 4$ for Y indecomposable in $\mathcal{S}(6)$ (established in 11.4) has the following consequence:

Lemma 1. *Let Y be an indecomposable object in $\mathcal{S}(6)$. Then*

$$|qY - 4| \leq \frac{24}{vY}.$$

Proof. We have

$$|qY - 4| = \left| \frac{\eta Y}{bY} \right| \leq \frac{4}{bY} \leq \frac{24}{vY},$$

where the first inequality sign is implied by $|\eta Y| \leq 4$. The second inequality sign follows from the inequality $vY \leq 6 \cdot bY$, which is valid for all Y in $\mathcal{S}(6)$. \square

Lemma 2. *If $|qY - 4| \geq \epsilon > 0$, then $vY \leq \frac{24}{\epsilon}$.*

Proof. Assume, for the contrary, that $|qY - 4| \geq \epsilon$ and $vY > \frac{24}{\epsilon}$. Then Lemma 1 yields $|qY - 4| \leq \frac{24}{vY} < \epsilon$, a contradiction. \square

Lemma 3. *For any number $c < 4$, there are only finitely many indecomposable objects X in $\mathcal{S}(6)$ with $q(X) \leq c$.*

Proof. Let $0 \leq c < 4$. There are only finitely many objects X in the non-stable tube with $vX \leq 24/(4 - c)$; objects with $vX > 24/(4 - c)$ satisfy $|qX - 4| \leq 24/vX < 4 - c$, by Lemma 1, hence $q(X) > c$.

Thus, let us look at the objects X in stable tubes. According to 11.1, we can choose $M \in \mathcal{D}$ with $\pi M = X$. Since the universal covering is controlled by the quadratic form, $\mathbf{dim} M$ is either a root or a radical vector. According to 11.3, we know that $\mathbf{dim} M$ cannot be a radical vector, thus $\mathbf{dim} M$ is a root. There are only finitely many roots with $v(X) \leq 24/(4 - c)$; as above, the remaining objects in stable tubes satisfy $q(X) > c$. \square

Proof of Proposition 11.5. Using rotation, we obtain from Lemma 3: *For any number $c < 4$, there are only finitely many indecomposable objects X in $\mathcal{S}(6)$ with $pX \geq 6 - c$.* The union of the sets of pr-vectors with $qX \leq c$ and with $pX \geq 6 - c$ contains all the pr-vectors with $r \leq 2c - 6$.

Now assume that there is given $0 \leq a < 2$. Let $c = a/2 + 3$. Then $c < 4$. As we have seen, there are only finitely many indecomposables with pr-vector (p, r) such that $r \leq 2c - 6 = a$. Using rotation, there are also only finitely many indecomposables with pr-vector (p, r) such that $p \leq a$ or $6 - q \leq a$. In particular, there are only finitely many indecomposable objects X with $dX \leq a$. \square

11.6. The half-line support of $\mathcal{S}(6)$ (proof of Theorem 8 (a)).

We have to show: *Let X be indecomposable in $\mathcal{S}(6)$. Then X lies on some line L_ϕ , with $\phi \in \Phi$.* We may assume that X belongs to a stable tube, thus there is M which belongs to a stable tube of $\text{mod } \Theta$ with $X = \pi M$. According to Lemma 11.2, we have $bM = \dim M_3$. We also can assume that X is not central (since central objects lie on all lines L_ϕ , for example on L_1 , since $pX = rX$).

For any element

$$\mathbf{z} = \begin{pmatrix} & z_{2'} & z_{3'} & z_{4'} & & & & \\ z_0 & z_1 & z_2 & z_3 & z_4 & z_5 & z_6 & \end{pmatrix}$$

in $K_0(\text{mod } \Theta)$, let

$$u\mathbf{z} = z_0 + z_1 + z_2' + z_3' + z_4', \quad v\mathbf{z} = \sum_{i=0}^6 z_i, \quad w\mathbf{z} = v\mathbf{z} - u\mathbf{z}, \quad \dim_3 \mathbf{z} = z_3.$$

We say that \mathbf{z} is *central* provided $u\mathbf{z} = 2 \dim_3 \mathbf{z} = w\mathbf{z}$, and we define, for \mathbf{z} not central,

$$\phi' \mathbf{z} = \frac{u\mathbf{z} - 2 \dim_3 \mathbf{z}}{w\mathbf{z} - 2 \dim_3 \mathbf{z}},$$

this is an element of $\mathbb{Q} \cup \{\infty\}$.

Any element $\mathbf{z} \in K_0(\text{mod } \Theta)$ can be written as

$$\mathbf{z} = \mathbf{r}(\mathbf{z}) + z_0 \mathbf{h}_0 + z_4' \mathbf{h}_\infty,$$

thus $\mathbf{r}(\mathbf{z})$ belongs to $K_0(\text{mod } \Xi)$. If M is an indecomposable Θ -module, then $\mathbf{r}(\dim M)$ is a (not necessarily positive) root of the quadratic form χ_Ξ .

Since $u(\mathbf{h}_0) = 2 \dim_3 \mathbf{h}_0 = w(\mathbf{h}_0)$, we see that

$$\begin{aligned} (u - 2 \dim_3)(\mathbf{h}_0) &= (w - 2 \dim_3)\mathbf{h}_0 = 0, \quad \text{and} \\ (u - 2 \dim_3)(\mathbf{h}_\infty) &= (w - 2 \dim_3)\mathbf{h}_\infty = 0, \end{aligned}$$

thus \mathbf{z} is central if and only if $\mathbf{r}(\mathbf{z})$ is, and if \mathbf{z} is not central, then

$$\phi'(\mathbf{z}) = \phi'(\mathbf{r}(\mathbf{z})).$$

A case-by-case calculation (presented in column (5) in Appendix A.1) shows that for all non-central roots \mathbf{r} of χ_Ξ , we have $\phi'(\mathbf{r}) \in \Phi$. Actually, we only have to look at the roots of χ_Ξ , which correspond to positive roots of \mathbf{E}_8 , since for \mathbf{z} not central, we have $\phi'(\mathbf{z}) = \phi'(-\mathbf{z})$.

Let us summarize the considerations. Recall that we want to show that any non-central X which belongs to a stable tube in $\mathcal{S}(6)$ satisfies $\phi(X) \in \Phi$ (so that X lies on one of the 12 lines L_ϕ with $\phi \in \Phi$). Now $X = \pi M$ for some non-central Θ -module which belongs to a stable tube in $\text{mod } \Theta$ and we have

$$\phi X = \phi M = \phi'(\dim M) = \phi'(\mathbf{r}),$$

where $\mathbf{r} = \mathbf{r}(\dim M)$ is a non-central root of χ_{Ξ} . Finally, we have $\phi'(\mathbf{r}) \in \Phi$. □

11.7. More about $\mathbb{L}(6)$.

Theorem 6 (shown in Section 10) asserts that the principal component $\mathcal{P}(6)$ lives on the union $\mathbb{P}(6) \cup \mathbb{D}(6) \cup \mathbb{H}_{\ell}(6)$. Recall that we denote by $\mathbb{H}_s(6)$ the union of the half-lines complementary to those in $\mathbb{H}_{\ell}(6)$. There is no non-central indecomposable object Y in $\mathcal{P}(n)$ supported by $\mathbb{H}_s(6)$. But there are such objects in $\mathcal{S}(6)$. For any half line H in $\mathbb{H}_s(6)$, let us exhibit a non-central indecomposable object Y in $\mathcal{S}(6)$ with $bY = 3$ which is supported by H .

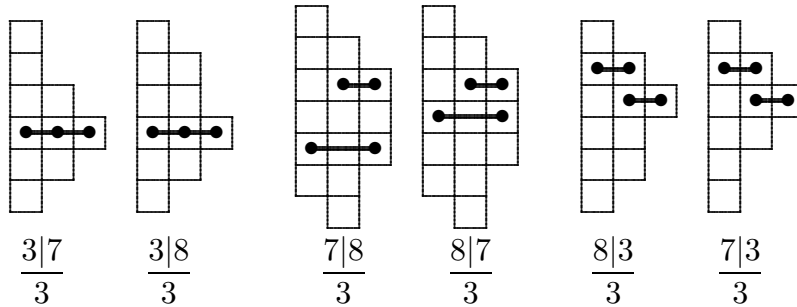

The following picture shows all the lines $L = L_{\phi}$ in $\mathbb{L}(6) = \mathbb{P}(6) \cup \mathbb{D}(6) \cup \mathbb{H}(6)$, with the corresponding label ϕ . The lines in $\mathbb{P}(6)$ and $\mathbb{D}(6)$ are solid, the remaining ones in $\mathbb{H}(6)$ are dashed. For every central half-line, the non-central objects with smallest possible width are indicated: pickets by bullets \bullet , non-pickets by small circles \circ (these are the six objects of width 3 mentioned above).

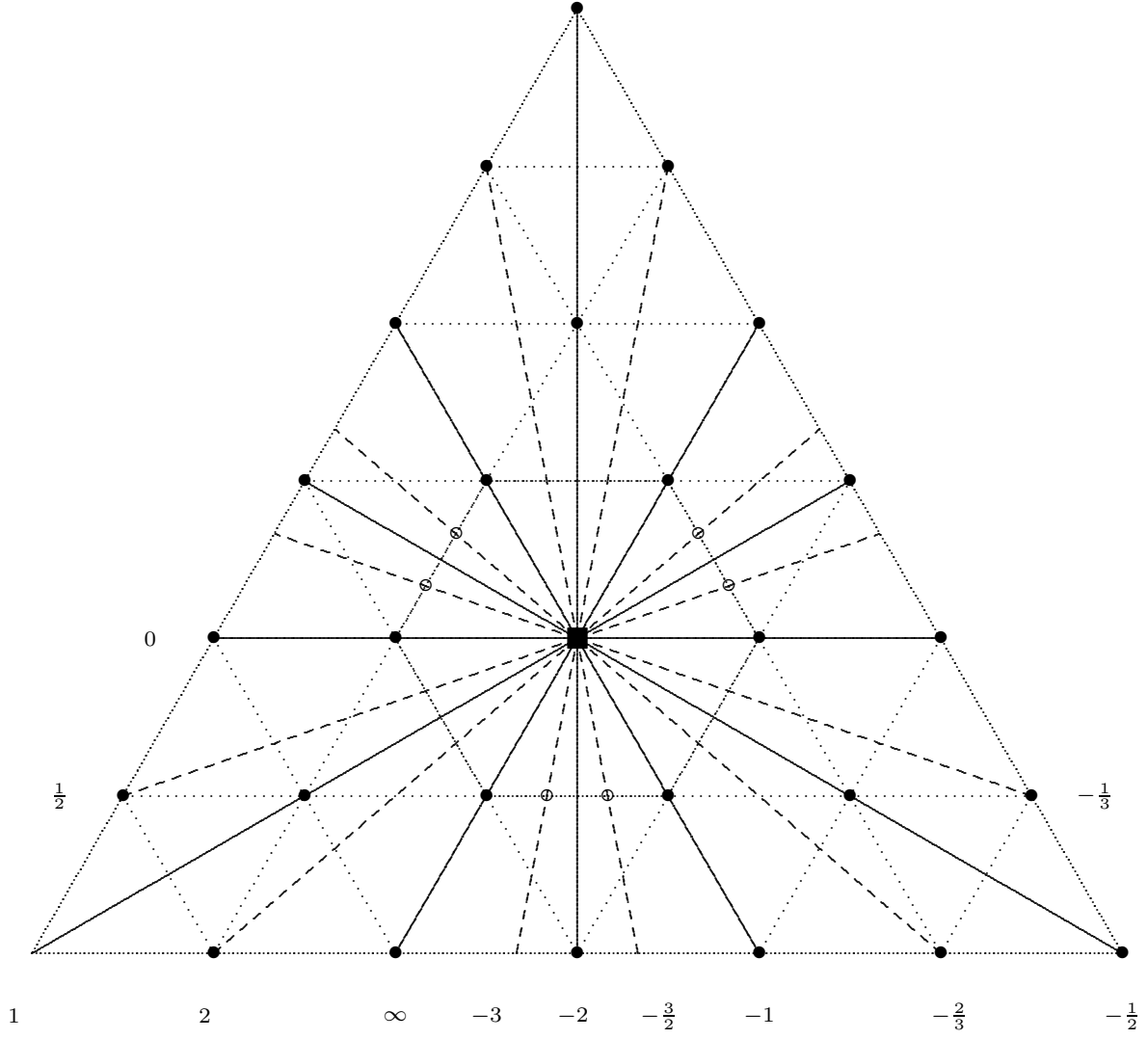

Actually, the 12 lines in $\mathbb{L}(6)$ can be described in several ways. The following table mentions three slightly different possibilities. The first column lists the slope ϕ , where $L_\phi = \frac{u-2b}{w-2b}$, the second column rewrites this description by multiplying with the denominators. Thus, the first two columns describe the lines by referring to u, w, b . The third column uses in addition $\omega = |\Omega V|$. We obtain the third column from the second one by adding or subtracting the equality $\omega + u + w = 6b$ mentioned in 3.6.

ϕ	using u, w, b	using also ω	type
0/1	$u = 2b$	$u = 2b$	\mathbb{P}
1/2	$2u - w = 2b$	$w = 2(u - b)$	\mathbb{H}
1/1	$u - w = 0$	$w = u$	\mathbb{D}
2/1	$u - 2w = -2b$	$u = 2(w - b)$	\mathbb{H}
1/0	$w = 2b$	$w = 2b$	\mathbb{P}
-3/1	$u + 3w = 8b$	$\omega = 2(w - b)$	\mathbb{H}
-2/1	$u + 2w = 6b$	$\omega = w$	\mathbb{D}
-3/2	$2u + 3w = 10b$	$w = 2(\omega - b)$	\mathbb{H}
-1/1	$u + w = 4b$	$\omega = 2b$	\mathbb{P}
-2/3	$3u + 2w = 10b$	$u = 2(\omega - b)$	\mathbb{H}
-1/2	$2u + w = 6b$	$u = \omega$	\mathbb{D}
-1/3	$3u + w = 8b$	$\omega = 2(u - b)$	\mathbb{H}

Note that the strange numbers which are needed to describe the lines in $\mathbb{L}(6)$ when we use the first or the second column, are replaced in the third column by a concise denomination. It is remarkable that the third column provides **just three** kinds of equations which define the lines in $\mathbb{L}(6)$, one for each of the types $\mathbb{P}, \mathbb{D}, \mathbb{H}$: For \mathbb{P} , one of the coordinates has to have the constant value $2b$. For \mathbb{D} , the equation asserts that two of the three coordinates u, w, ω coincide. Finally for \mathbb{H} , there are the six equations of the form $w = 2(u - b)$ (clearly, these latter equations deserve some further interest). Recall that Theorem 1 asserts that if X is an indecomposable object in $\mathcal{S}(n)$, which is not a boundary picket, then $u \geq b, w \geq b$, and $\omega \geq b$. Thus, it seems reasonable to work (as we do here) with the differences $u - b, w - b, \omega - b$. Looking at the lines of type \mathbb{H} , the equations of the form $w = 2(u - b)$ show in which way one of the coordinate value, here w , is determined by another coordinate value, here u , namely w is the double of $u - b$.

Let us stress the following consequence of the table:

Proposition. *Let X be indecomposable in $\mathcal{S}(6)$. If $u < w < 2b$, or if $2b < w < u$, then $u = 2(w - b)$, thus $w = \frac{1}{2}(u + 2b)$ is the average of u and $2b$.*

This concerns the pr-vectors in the interior of the following two shaded triangles:

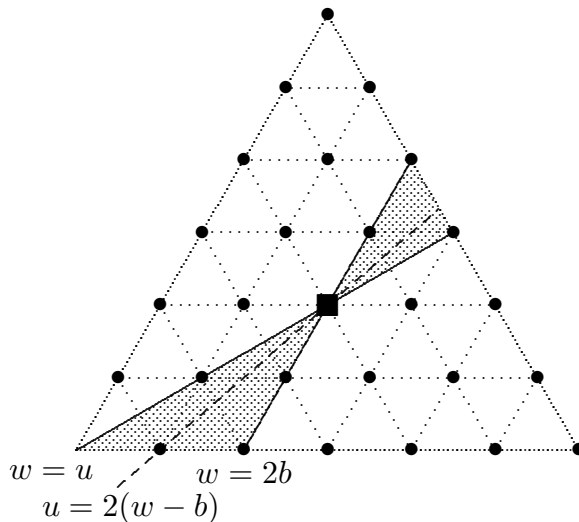

There are five similar assertions, obtained via the Σ_3 -symmetries (or, of course, using again the table).

11.8. The triangle support of $\mathcal{S}(6)$ (proof of Theorem 8 (b)).

We want to show: *The set $\Psi = \Psi(\mathcal{S}(6))$ is a monoton increasing sequence in $[0, 2[$ which converges to 2.*

We are going to define the primitive pairs (u, b) for $\mathcal{S}(6)$.

The algebra Ξ is a tilted algebra of type \mathbf{E}_8 . If M is an indecomposable Θ -module, then $\mathbf{dim} M$ is a radical vector or a positive root of χ_Θ , and we can write

$$\mathbf{dim} M = \mathbf{r}(M) + a_0 \mathbf{h}_0 + a_\infty \mathbf{h}_\infty,$$

where $\mathbf{r}(M)$ is either zero or a (not necessarily positive) root of χ_Ξ , and where

$$\mathbf{h}_0 = \begin{matrix} 2 & 1 & 0 \\ 1 & 2 & 3 & 3 & 2 & 1 & 0 \end{matrix}, \quad \mathbf{h}_\infty = \begin{matrix} 2 & 2 & 1 \\ 0 & 1 & 2 & 3 & 3 & 2 & 1 \end{matrix}$$

(here, $a_0 = \dim M_0$ and $a_\infty = \dim M_4$). Recall that π provides a bijection between $'\mathcal{D}$ and the class \mathcal{X} of indecomposable objects which belong to stable tubes.

For any root \mathbf{r} of χ_Ξ , let $'\mathcal{D}(\mathbf{r})$ be the class of indecomposable modules M in $'\mathcal{D}$ such $\mathbf{r}(M) = \mathbf{r}$. Let $M(\mathbf{r})$ be an indecomposable module in $'\mathcal{D}(\mathbf{r})$ of minimal length. Let

$$u'(\mathbf{r}) = u(\pi M(\mathbf{r})), \quad b'(\mathbf{r}) = b(\pi M(\mathbf{r})), \quad a(\mathbf{r}) = a_0 + a_\infty,$$

clearly, $u'(\mathbf{r}), b'(\mathbf{r}), a(\mathbf{r})$ only depend on \mathbf{r} , and for any object Y in $'\mathcal{D}(\mathbf{r})$, there is $t \in \mathbb{N}_0$ such that

$$u(\pi Y) = u'(\mathbf{r}) + 6t, \quad \text{and} \quad b(\pi Y) = b'(\mathbf{r}) + 3t;$$

namely, if $\mathbf{dim} Y = \mathbf{r} + a'_0 \mathbf{h}_0 + a'_\infty \mathbf{h}_\infty$, then $t = a'_0 + a'_\infty - a(\mathbf{r})$.

If $M(\mathbf{r})$ is u -minimal, let

$$d_{\mathbf{r}}(t) = (u'(\mathbf{r}) + 6t)/(b'(\mathbf{r}) + 3t);$$

this is a function $\mathbb{N}_0 \rightarrow \mathbb{R}$.

Lemma. *For any indecomposable object X in $\mathcal{S}(n)$, there is a root \mathbf{r} such that $M(\mathbf{r})$ is u -minimal and some $t \in \mathbb{N}_0$ such that $dX = d_{\mathbf{r}}(t)$.*

Proof. We know this already for X belonging to a stable component. We claim that the primitive pairs (u, b) for $\mathcal{P}(6)$ are primitive pairs for $\mathcal{S}(6)$. There are the following five primitive pairs for $\mathcal{P}(6)$, see Proposition 10.6. Below each pair (u, b) , we show an object $M(\mathbf{r})$ which is u -minimal and such that $u = u'(\mathbf{r})$ and $b = b'(\mathbf{r})$.

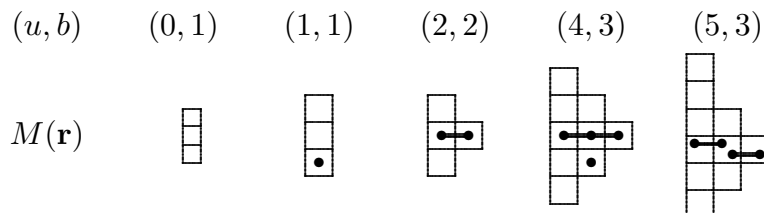

All the objects $M(\mathbf{r})$ belong to stable components, since the global space of an object in $\mathcal{P}(6)$ has no part of the form [3]. \square

Corollary. *The index set Ψ is contained in the set of values of the functions $d_{\mathbf{r}}(t)$, where \mathbf{r} is a root and $M(\mathbf{r})$ is u -minimal.*

For any root \mathbf{r} with $M(\mathbf{r})$ being minimal, the set of values $d_{\mathbf{r}}(t)$ with $t \in \mathbb{N}_0$ is a strictly increasing sequence which converges to 2. \square

Theorem 8 (b) follows from the Corollary, since the number of roots \mathbf{r} is finite.

11.9. More on the set Ψ .

Proposition. *If $d \in \Psi$, then $d = 2 - c/b$, where c is one of the numbers 1, 2, 3, 4 and $b \in \mathbb{N}_1$.*

Proof. Let $d = u/b$, where $u = uX$, $b = bX$ for some u -minimal object X . Let $c = 2b - u$. The u -minimality implies that $d = u/b < 2$, therefore $u < 2b$, thus $c > 0$.

Now, $d = u/b = (2b - c)/b = 2 - c/b$. According to Theorem 7, we have $-4 \leq u - 2b \leq 4$, thus $-4 \leq c \leq 4$. Altogether we see that $0 < c \leq 4$. Since c is an integer, $c \in \{1, 2, 3, 4\}$. \square

Here is the list of the numbers $d = 2 - c/b = (2b - c)/b$ with $1 \leq d \leq 5/3$. It is sufficient to look at the cases $c = 3$ and $c = 4$.

With $c = 3$: $3/3, 5/4, 7/5, 9/6, 11/7, 13/8, 15/9$.

With $c = 4$: $4/4, 6/5, 8/6, 10/7, 12/8, 14/9, 16/10, 18/11, 20/12$.

Not all these numbers belong to Ψ . For example, there is no indecomposable object $X \in \mathcal{S}(6)$ on Delta_d with $d = 6/5$, since X would belong to a stable tube and we would have $\mathbf{dim} \tilde{X} = \mathbf{r} + \mathbf{h}$ for a root \mathbf{r} and a radical vector \mathbf{h} with $u\mathbf{h} = 6$, $b\mathbf{h} = 3$, thus $u\mathbf{r} = 0$ and $b\mathbf{r} = 2$. But such a root \mathbf{r} does not exist.

On the other hand, we note that $d = 10/7$ does belong to Ψ , since $dX^+ = 10/7$, where $X = ([3, 1], [6, 4, 3, 1])$ (we have $uX = 4$, $bX = 4$, thus $uX^+ = 10$, $bX^+ = 7$).

11.10. Proof of Theorem 8 (c): The number is unbounded.

For $a_0, a_\infty \in \mathbb{N}_0$, there is an indecomposable Ξ -module $M(a_0, a_\infty)$ with

$$\mathbf{dim} M(a_0, a_\infty) = \mathbf{r} + a_0\mathbf{h}_0 + a_\infty\mathbf{h}_\infty,$$

where

$$\mathbf{r} = \begin{array}{ccccccc} & 0 & 0 & 0 & & & \\ 0 & 0 & 0 & 1 & 0 & 0 & 0 \end{array},$$

and we let $X(a_0, a_\infty) = \pi M(a_0, a_\infty)$. For example, the module $M(0, 0) = S_3$ is the simple module corresponding to the vertex 3, thus $X(0, 0) = S$ and $X(1, 0) = S[7]$.

Let $t = a_0 + a_\infty$. The uwb -vector of $X(a_0, a_\infty)$ is $\frac{6t|6t+1}{3t+1}$. We obtain in this way $t + 1$ indecomposable objects with the same pr -vector $(6t/(3t+1), (6t+1)/(3t+1))$.

11.11. Small objects in $\mathcal{S}(6)$.

We are going to show that Theorem 7 implies strong restrictions on the existence of indecomposable objects. In particular, it provides an interesting characterization of the object $S[6]$ in $\mathcal{S}(6)$. We recall that $S[6]$ is the unique indecomposable object with a sectional path from $S = (0, [1])$ to $S[6]$ of length 5. Of course, $S[6]$ belongs to the principal component $\mathcal{P}(6)$; its partition vector is $([4, 2], [6, 4, 1, 1], [4, 2])$ and $qS[6] = 3$.

Proposition. *Let X be indecomposable in $\mathcal{S}(6)$.*

If $qX < 16/5$, then: either X has height at most 5 or else $X = S[6]$.

If $qX < 10/3$, then $bX \leq 5$ and $vX \leq 16$.

All the indecomposable objects in $\mathcal{S}(6)$ with $bX \leq 5$ and $qX < 10/3$ will be exhibited in 15.2 and Appendix B. In this way, we see that the bounds are optimal.

Proof. According to Theorem 7, we have $|vX - 4 \cdot bX| \leq 4$, thus $|qX - 4| \leq 4/bX$ and thus $4/bX \geq 4 - qX$.

First, let $qX < 10/3$, thus $4 - qX > 4 - 10/3 = 2/3$. We get $4/bX \geq 4 - qX > 2/3$, so that $bX < 6$. Since bX is an integer, we have $bX \leq 5$. We get $vX = qX \cdot bX < 10/3 \cdot 5 = 50/3$, thus $vX \leq 16$. This finishes the proof of the second assertion.

In order to show the first assertion, we assume now that $qX < 16/5$, thus $4 - qX > 4 - 16/5 = 4/5$. We get $4/bX \geq 4 - qX > 4/5$, so that $bX < 5$, and therefore $bX \leq 4$.

Let us show that for $bX \leq 3$, the object X has height at most 5. If $bX = 1, 2$, or 3 , we have $vX = qX \cdot bX < 16/5 \cdot bX$, thus $vX \leq 3, 6$, or 9 , respectively. If $bX = 1$ or 2 , then clearly X has height at most 5. Thus let us consider the case $bX = 3$, so that $vX \leq 9$. Let us assume that X has height 6, thus $VX = [6, 2, 1]$ or $[6, 1, 1]$. But this means that $U(\tau X)$ is equal to $[2, 1]$ or to $[1, 1]$, thus $U(\tau X)$ has height at most 2. But for any indecomposable object in \mathcal{S} whose subspace has height at most 2, the subspace has to be indecomposable.

Thus, we can assume that $bX = 4$. We get $v = qX \cdot bX < 16/5 \cdot 4 = 65/5$, thus $vX \leq 12$. We assume now again that X has height 6, thus either $VX = [6, 4, 1, 1]$, or else $[6, x, y, z]$ with $3 \geq x \geq y \geq z \geq 1$. We are going to show that only the case $[6, 4, 1, 1]$ is possible. Thus, assume that $VX = [6, x, y, z]$ with $3 \geq x \geq y \geq z \geq 1$ and let $Y = \tau X$. According to Section 3, we have $UY = [x, y, z]$, thus Y belongs to $\mathcal{S}_3(6)$. Again we use the argument that UY must have height 3, thus $3 = x > y \geq z \geq 1$. According to Schmidmeier [S1], the category $\mathcal{S}_3(6)$ is known (it is representation-finite with 84 indecomposable objects, see Proposition 12 in [S1]) and there are only two indecomposable objects Y in $\mathcal{S}_3(6)$ with subspace $UY = [x, y, z]$, where $3 = x > y \geq z \geq 1$; in both cases $UY = [3, 2, 1]$. In order to get a contradiction, we consider now τY (where again $\tau = \tau_6$). It is easy to see that $b(\tau Y) = 5$. (For example, we can use Proposition 3.12.1: Since $UY = [3, 2, 1]$, we have $bUY = 3$. From the objects in [S1] we read off that in each case $bWY = 3$ and $c_6Y = 1$, so the Proposition yields $b(\tau Y) = bUY + bWY - c_6Y = 5$.) But this contradicts the fact that $b(\tau Y) = b(\tau^2 X) = bX = 4$, according to Theorem 3. As a consequence, we conclude that $V = [6, 4, 1, 1]$.

There are several ways to show that the only indecomposable object X in \mathcal{S} with $VX = [6, 4, 1, 1]$ is $X = S[6]$. Let us outline two approaches. Using the root system of Θ , one easily sees that there is no indecomposable object in a stable tube with global space $[4, 2, 1, 1]$. Thus, it remains to look at the principal component $\mathcal{P}(6)$. There are just 12

indecomposable objects in $\mathcal{P}(6)$ which have width 4, and just one of them, namely $S[6]$ has global space $[6, 4, 1, 1]$. A second possible proof invokes Proposition in Section 5: Given an indecomposable object X with $VX = [6, 4, 1, 1]$, we obtain a g -split filtration of X with two factors both being extended pickets. This allows to identify X with $S[6]$. \square

Remark 1. The Proposition and its proof provide the following characterizations of $S[6]$. *Assume that X is indecomposable in $\mathcal{S}(6)$ and does not belong in $\mathcal{S}(5)$. Then $X = S[6]$ if and only if $vX = 12$, $bX = 4$, if and only if $qX = 3$, if and only if $qX < 16/5$, if and only if $VX = [6, 4, 1, 1]$.* \square

Remark 2. There is a second interesting indecomposable object X with width 4, namely the object X with $\mathbf{par} X = ([3, 1], [6, 4, 3, 1], [5, 3, 2])$. It can be characterized as follows: *Assume that $X = (U, V)$ is indecomposable in $\mathcal{S}(6)$ and $0 \neq U$ is decomposable. Then $\mathbf{par} X = ([3, 1], [6, 4, 3, 1], [5, 3, 2])$ if and only if $uX = 4$, $bX = 4$, if and only if $pX = 1$, if and only if $pX < 5/4$, if and only if $UX = [3, 1]$ and $bX = 4$.* For the proof, one uses Theorem 8 (b) and the fact that for $d \in \Psi$, we have $d \leq 1$ or $d \geq 5/4$, see 11.9. See the line $p = 1$ in 15.2 (g). \square

11.12. The function η_n for $n \geq 7$.

We have introduced in 11.4 the function $\eta X = vX - 4 \cdot bX$ for X on $\mathcal{S}(6)$. For arbitrary n , there is the corresponding function η_n defined by $\eta_n = vX - \frac{2n}{3} \cdot bX$ for X in $\mathcal{S}(n)$.

Proposition. *For $n \geq 7$, the function $\eta_n = vX - \frac{2n}{3} \cdot bX$ is not bounded on the indecomposable objects of $\mathcal{S}(n)$.*

Proof. Let $n \geq 7$. Any indecomposable object X in $\mathcal{S}(6)$ with $VX = [6, 4, 2]^t$ can be modified in order to produce indecomposable objects X' and X'' in $\mathcal{S}(n)$ with $V(X') = [n, 4, 2]^t$ and $V(X'') = [n, n - 2, n - 4]^t$.

Now $b(X') = b(X'') = 3t$ and $v(X') = (n + 6)t$, whereas $v(X'') = (3n - 6)t$. Thus

$$\begin{aligned}\eta_n(X') &= (n + 6)t - \frac{2}{3}n \cdot 3t = (-n + 6)t \leq -t, \\ \eta_n(X'') &= (3n - 6)t - \frac{2}{3}n \cdot 3t = (n - 6)t \geq t.\end{aligned}$$

\square

11.13. Central lines and Kronecker subcategories.

As we have seen in Section 10.1, any non-central object in a stable tube \mathcal{C} of $\mathcal{S}(n)$ gives rise to a pair of complementary central half-lines in the half-line support of \mathcal{C} . For $n = 6$, there is an additional way that complementary central half-lines appear, namely as the half-line support of some Kronecker subcategories of $\tilde{\mathcal{S}}(6)$.

We say that a Kronecker-pair X, Y in $\tilde{\mathcal{S}}(6)$ is g -split provided $\text{Ext}^1(X, Y) = \text{Ext}_g^1(X, Y)$.

Proposition. *Let X, Y be a Kronecker pair in $\tilde{\mathcal{S}}(6)$ which is not central and g -split. Then the half-line support of the corresponding Kronecker subcategory \mathcal{K} is a pair of complementary central lines.*

The examples presented in 2.7 and 2.8 are non-central and g-split Kronecker pairs. For the example 2.7, with $\mathbf{uwb} X = \frac{4|2}{1}$ and $\mathbf{uwb} Y = \frac{2|4}{2}$, we obtain as half-line support the line L_∞ , for the example 2.8, with $\mathbf{uwb} X = \mathbf{uwb} \frac{\tilde{A}}{B'} = \frac{8|7}{3}$ and $\mathbf{uwb} Y = \mathbf{uwb} \frac{\tilde{B}}{C} = \frac{4|5}{3}$, we obtain the line L_2 .

Example 2.7

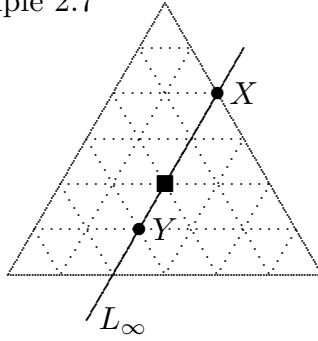

Example 2.8

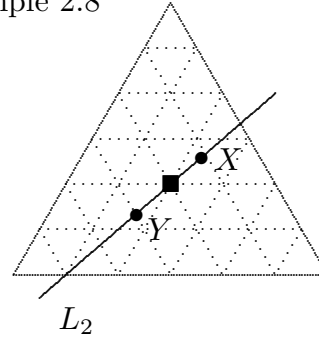

Fifth part: Some objects.

12. Pickets and bipickets.

12.1. The pickets (and their τ -orbits).

We recall that an object X in \mathcal{S} is a picket if and only if $bX = 1$.

The pickets in $\mathcal{S}(n)$ correspond bijectively to (and may be identified with) the triples (a_0, a_1, a_2) of non-negative numbers a_0, a_1, a_2 with $a_0 + a_1 + a_2 = n$ and $(a_1, a_2) \neq (0, 0)$; the picket corresponding to the triple (a_0, a_1, a_2) is $([a_1], [a_1 + a_2])$ and it will be denoted now also by $a_0 \setminus a_1 \setminus a_2$. This denomination corresponds to the general frame established in Section 3.1; with the abbreviation $a_0 \setminus a_1 \setminus a_2 = ([a_0] \setminus [a_1] \setminus [a_2]) = E([a_1], [a_1 + a_2])$. The reduced pickets correspond to the triples $a_0 \setminus a_1 \setminus a_2$ different from $0 \setminus 0 \setminus n$ and $0 \setminus n \setminus 0$, thus to the triples a_0, a_1, a_2 of non-negative numbers with $a_0 + a_1 + a_2 = n$, and such that at most one of the numbers is zero.

If $a_0 \setminus a_1 \setminus a_2$ is a reduced picket, then

$$\tau_n^2(a_0 \setminus a_1 \setminus a_2) = a_1 \setminus a_2 \setminus a_0,$$

as asserted by Theorem 3' (but also easily verified). (Note that Theorem 3 shows: if X is a reduced picket, so that X is reduced and $bX = 1$, then also $b(\tau_n^2 X) = 1$, thus $\tau_n^2 X$ is again a picket; here is the precise formula.)

If one and only one of the numbers a_0, a_1, a_2 is zero, then $\tau(a_0 \setminus a_1 \setminus a_2)$ is again a picket. Namely, $\tau_n(0 \setminus a_1 \setminus a_2) = ([a_2], [a_2])$; next $\tau_n^2(a_0 \setminus 0 \setminus a_2) = ([a_2], [n])$; and finally, $\tau(a_0 \setminus a_1 \setminus 0) = (0, [a_0])$.

If all numbers a_0, a_1, a_2 are non-zero, the object $\tau_n(a_0 \setminus a_1 \setminus a_2)$ is no longer a picket, but a bipicket (U, V, W) with the following properties: one part of the total space V is $[n]$, and both U and W are indecomposable Λ -modules, namely $\tau_n(a_0 \setminus a_1 \setminus a_2) = (U, V, W) = ([a_1 + a_2], [n, a_2], [a_0 + a_2])$, and is constructed as follows: There is a canonical embedding $\mu: [a_1 + a_2] \rightarrow [n]$ and a canonical projection $\pi: [a_1 + a_2] \rightarrow [a_2]$, in $\mathcal{N}(n)$, thus there is the map $(\mu, \pi): [a_1 + a_2] \rightarrow [n, a_2]$. The map (μ, π) is a monomorphism, say with image U , and the cokernel is $W = [a_0 + a_2]$.

$$\begin{array}{ccc}
 & [n] & \\
 \mu \nearrow & & \searrow \\
 [a_1 + a_2] & & [a_0 + a_2] \\
 \pi \searrow & & \nearrow \\
 & [a_2] &
 \end{array}$$

Then $\tau_n(a_0 \setminus a_1 \setminus a_2) = (U, [n, a_2], W)$.

Proposition. *The number of pickets of height n is $n + 1$. The number of pickets of height at most n is $\binom{n+2}{2} - 1$.*

Proof. The pickets of height n are the objects $([t], [n])$ with $0 \leq t \leq n$, thus the number of these pickets is $n + 1$. The number of pickets of height at most n is therefore $\sum_{i=1}^n (t + 1) = \binom{n+2}{2} - 1$. \square

Remark. Pickets and irreducible module varieties.

It is known that pickets and their τ -translates play a particular role in geometric representation theory: Given n (nilpotency index), v ($= \dim V$) and $u \leq v$ ($u = \dim U$), let $\mathbb{V}_n(u, v)$ be the affine variety consisting of all triples $M = (M_0, M_1, h_M)$ where M_0 is a $u \times u$ -matrix, M_1 a $v \times v$ -matrix and h_M a $u \times v$ -matrix such that $M_0^n = 0$, $M_1^n = 0$ and $M_0 h_M = h_M M_1$. (By convention, if $d', d'' \geq 0$ and either $d' = 0$ or $d'' = 0$ then there is a unique $d' \times d''$ -matrix which behaves like zero with respect to multiplication.) The group $\mathrm{GL}_{u,v} = \mathrm{GL}_u(k) \times \mathrm{GL}_v(k)$ acts on $\mathbb{V}_n(u, v)$ by

$$(g_0, g_1) \cdot (M_0, M_1, h_M) = (g_0 M_0 g_0^{-1}, g_1 M_1 g_1^{-1}, g_0 h_M g_1^{-1}).$$

It has been shown by Bobinski in [Bob, Theorem 1.1] that $\mathbb{V}_n(u, v)$ is an irreducible variety for each n, u and v . More precisely, $\mathbb{V}_n(u, v)$ has a unique dense $\mathrm{GL}_{u,v}$ -orbit. In our notation, this orbit corresponds to the following embedding where we write $u = an + b$ and $v = cn + d$ with $a, b, c, d \in \mathbb{Z}$ such that $0 \leq b, d < n$ hold. The pickets $P = ([n], [n])$ and $P' = (0, [n])$ are the indecomposable projective objects.

$$\begin{aligned} P^a \oplus P'^{c-a} & \text{ if } 0 = b = d \\ P^a \oplus P'^{c-a} \oplus (0, [d]) & \text{ if } 0 = b < d \\ P^a \oplus P'^{c-a} \oplus ([b], [b]) & \text{ if } 0 < b = d \\ P^a \oplus P'^{c-a-1} \oplus ([b], [n]) & \text{ if } 0 = d < b \\ P^a \oplus P'^{c-a} \oplus ([b], [d]) & \text{ if } 0 < b < d \\ P^a \oplus P'^{c-a-1} \oplus ([b], [n, d], [n + d - b]) & \text{ if } 0 < d < b \end{aligned}$$

Note that the bipicket $([b], [n, d], [n + d - b])$ occurs as the τ_n -translate of the picket $n - b \setminus b - d \setminus d = ([b - d], [b])$. Thus, the pickets and their τ_n -translates define exactly the indecomposable direct summands of embeddings which give rise to the dense orbits in representation spaces.

12.2. Bipickets.

Recall that an object X in \mathcal{S} is called a bipicket if and only if X is indecomposable and $bX = 2$.

Proposition 1. *Let X be a bipicket.*

- (a) *The object X is gradable. If $X = \pi(\tilde{U}, \tilde{V})$, then $\tilde{V} = \tilde{V}_1 \oplus \tilde{V}_2$ with \tilde{V}_1 , and \tilde{V}_2 indecomposable and such that \tilde{V}_2 is a subquotient of $\mathrm{rad} \tilde{V}_1 / \mathrm{soc} \tilde{V}_1$; in particular, we have $\mathrm{End} \tilde{V} = k \times k$.*
- (b) *The bipicket X is uniquely determined by $\mathbf{par} X$.*

Let c_1, \dots, c_5 be natural numbers, with c_1, c_3 and c_5 positive. For $1 \leq i < j \leq 5$, write $c_{ij} = \sum_{t=i}^j c_t$. We define $B(c_1, \dots, c_5) = (U, V)$ as follows: $V = [c_{15}, c_{24}]$, with generators

v_1, v_2 (such that $T^{c_{15}}v_1 = 0 = T^{c_{24}}v_2 = 0$). Let $u_1 = T^{c_{45}}v_1 + T^{c_4}v_2$ and $u_2 = T^{c_{34}}v_2$ (thus $u_2 = 0$ if and only if $c_2 = 0$), and U the submodule of V generated by u_1, u_2 .

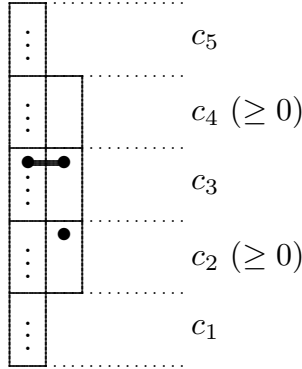

Note that U is isomorphic to $[c_{13}, c_2]$ and $W = V/U$ is isomorphic to $[c_{35}, c_4]$, so that

$$\mathbf{par} B(c_1, \dots, c_5) = ([c_{13}, c_2], [c_{15}, c_{24}], [c_{35}, c_4]).$$

Of course, *all the objects* $B(c_1, \dots, c_5)$ are gradable. The standard grading is the following: the element v_1 has degree c_{15} , the element v_2 has degree c_{14} (thus, u_1 has degree c_{13} and u_2 is zero or has degree c_{12}).

Proposition 2. *The objects $B(c_1, \dots, c_5)$ are bipickets and any bipicket is of this form, for a unique sequence c_1, \dots, c_5 .*

Proof of Proposition 2. First, let us assume that (U, V, W) is a bipicket with both U and W being cyclic. Let $V = V_1 \oplus V_2$ with V_1, V_2 indecomposable. Let $\mu = \begin{pmatrix} \mu_1 \\ \mu_2 \end{pmatrix} : U \rightarrow V_1 \oplus V_2$ be the inclusion map. Since U is not contained in $\text{rad } V_1 \oplus \text{rad } V_2$, at least one of the maps μ_1, μ_2 has to be surjective, say μ_2 . If μ_2 would be even bijective, then (U, V) would be decomposable. Thus $c_1 = \dim \text{Ker } \mu_2 \geq 1$.

Since μ_2 is not injective, μ_1 has to be injective. Again, μ_1 cannot be bijective, since (U, V) is indecomposable. Thus the dimension c_5 of the cokernel of μ_1 is at least 1. Let v_1 be a generator of V_1 . Then $\mu_1(U)$ is generated by $u = T^{c_5}v_1$, and the element $v_2 = \mu_2(u)$ generates V_2 . It follows that (U, V) is isomorphic to $(\Lambda(u + v_2), \Lambda v_1 \oplus \Lambda v_2) = B(c_1, 0, c_3, 0, c_5)$, where c_3 is the dimension of V_2 ; in particular, we have $c_3 \geq 1$.

In this way, we see that the bipickets (U, V, W) with U and W cyclic are the objects of the form $B(c_1, 0, c_3, 0, c_5)$.

In general, the isomorphism classes of the indecomposable objects (U, V, W) in $\mathcal{S}(n)$ which satisfy $U \subseteq \text{rad } V$ and which are different from $(0, k)$ correspond bijectively to the isomorphism classes of the indecomposable objects in $\mathcal{S}(n-1)$, by sending (U, V) to $(U, \text{rad } V)$ (and we have $bV = b(\text{rad } V)$). Under this bijection, the bipicket $B(c_1, c_2, c_3, c_4, c_5)$ with $c_4 \geq 1$ corresponds to the bipicket $B(c_1, c_2, c_3, c_4 - 1, c_5)$. Note that we have $U \not\subseteq \text{rad } V$ if and only if $bW < bV$.

Dually, the isomorphism classes of the indecomposable objects (U, V, W) in $\mathcal{S}(n)$ which satisfy $\text{soc } V \subseteq U$ and which are different from (k, k) correspond bijectively to

the isomorphism classes of the indecomposable objects in $\mathcal{S}(n-1)$, by sending (U, V) to $(U/\text{soc } V, V/\text{soc } V)$ (and we have $bU = b(V/\text{soc } V)$). Under this bijection, the bipicket $B(c_1, c_2, c_3, c_4, c_5)$ with $c_2 \geq 1$ corresponds to the bipicket $B(c_1, c_2 - 1, c_3, c_4, c_5)$. Note that we have $\text{soc } V \not\subseteq U$ if and only if $bU < bV$.

Thus, we see that the bipickets (U, V, W) are the objects of the form $B(c_1, c_2, c_3, c_4, c_5)$; the number c_4 is the maximal number t with $U \subseteq \text{rad}^t V$; the number c_2 is the maximal number t with $\text{soc}_t V \subseteq U$. \square

Proposition 1 follows immediately from Proposition 2. Note that we easily recover the numbers c_1, \dots, c_5 from $\mathbf{par} B(c_1, \dots, c_5)$. \square

Remarks. We have seen in Proposition 1 (b) that a bipicket $X = (U, V, W)$ is uniquely determined by $\mathbf{par} X = ([U], [V], [W])$. But X is not determined by two of the three partitions $[U], [V], [W]$. For example, the bipickets $B(1, 0, 2, 0, 2)$ and $B(2, 0, 1, 1, 1)$ have subspace $[3]$ and global space $[5, 2]$, but the factor spaces are different. The bipickets $B(2, 0, 1, 0, 2,)$ and $B(1, 0, 2, 0, 1)$ have subspace and factor space of the form $[3]$, but the global spaces are different.

Also: A bipicket $X = (U, V, W)$ in $\mathcal{S}(n)$ is uniquely determined by $EX = ([\Omega V], [U], [W])$, since $[\Omega V]$ and n together determine $[V]$.

Proposition 3. The number of bipickets in $\mathcal{S}(n)$ is $\binom{n+2}{5}$.

Proof. The binomial coefficient $\binom{n+2}{5}$ counts the number of five element subsets of $\{1, \dots, n+2\}$, thus the number of sequences $1 \leq d_1 < \dots < d_5 \leq n+2$ of cardinality 5. Given such a sequence $(d_i)_i$, let

$$c_1 = d_1, \quad c_2 = d_2 - d_1 - 1, \quad c_3 = d_3 - d_2, \quad c_4 = d_4 - d_3 - 1, \quad c_5 = d_5 - d_4.$$

Then $c_i \geq 0$ for all i , and $c_i \geq 1$ for $i = 1, 3, 5$. Also, $\sum_i c_i = (\sum_i d_i) - 2 \leq n$. We see that we can use the sequence c_1, \dots, c_5 in order to construct the bipicket $B(c_1, \dots, c_5)$ and we obtain all the bipickets of height at most n in this way. \square

Corollary. The number of bipickets of height n is $\binom{n+1}{4}$.

Proof. According to Proposition 3, the number of bipickets in $\mathcal{S}(n)$ is $\binom{n+2}{5}$, thus the number of bipickets in $\mathcal{S}(n-1)$ is $\binom{n+1}{5}$. The assertion follows from the equality

$$\binom{n+1}{5} + \binom{n+1}{4} = \binom{n+2}{5}.$$

\square

The distribution of the bipickets for $3 \leq n \leq 7$:

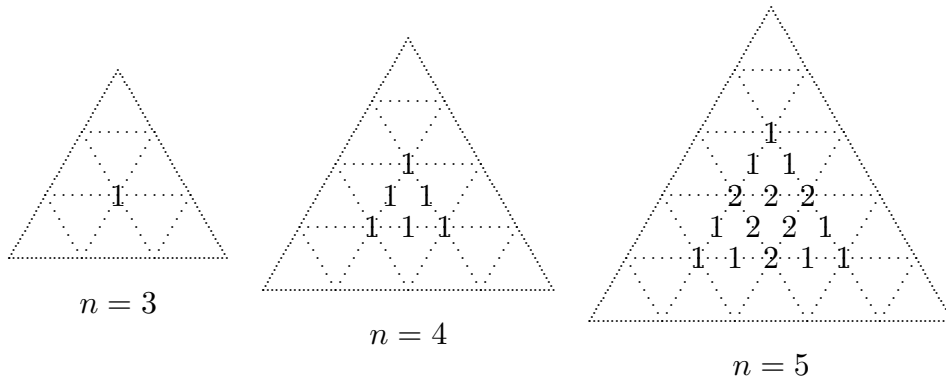

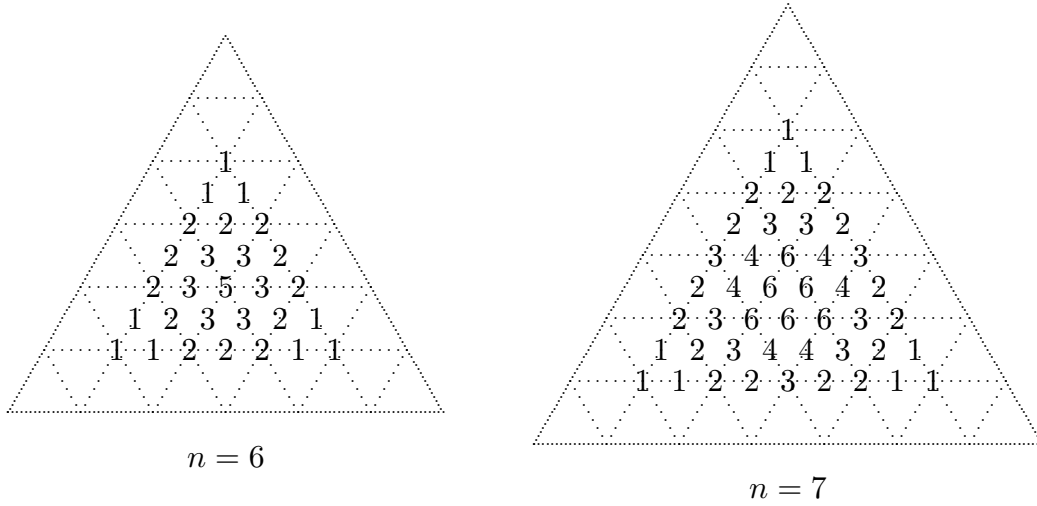

12.3. Indecomposables X with $bX \geq 3$.

Let $n = 6$. If $b \equiv \text{mod } 3$, then there is a BTh-family X in $\mathcal{S}(n)$ with $bX = b$. If $b \not\equiv \text{mod } 3$, then the indecomposables X with $bX = b$ are combinatorial.

Proof. For the first assertion, let M be the standard family and $X = M[\ell]$, where $\ell = b/3$. For the second assertion, look at the root system. \square

Let $n \geq 7$. If $b \geq 3$, there is a BTh-family X in $\mathcal{S}(n)$ with $bX = b$.

Proof. If $b \equiv 0 \pmod{3}$, we have such a family already in $\mathcal{S}(6)$.

Thus, we have to consider the cases $b \equiv 1 \pmod{3}$ and $b \equiv 2 \pmod{3}$. First, let $b \equiv 1 \pmod{3}$. If $b = 4$, take D with $V = [7, 5, 3, 1]$ and $U = [4, 2]$, so that $G_5H_4D = M$. For $b = 4 + 3\ell$, take the interpolation: one copy of D and ℓ copies of M . Finally, let $b \equiv 2 \pmod{3}$. For $b = 8 + 3\ell$, take the interpolation: two copy of D , ℓ copies of M . It remains $b = 5$. Here we take the family $\mathcal{S}_3(7)$. \square

13. The indecomposable objects $X = (U, V)$ with U being cyclic.

13.1. A first combinatorial description.

Let us attach to any non-empty subset E of $\{1, \dots, n\}$ an indecomposable module $M(E) = (\tilde{U}, \tilde{V})$ in $\mathcal{S}(\tilde{n})$ with $b\tilde{U} = 1$. We start with the non-empty subset $E = \{e_1, \dots, e_m\}$ of $\{1, \dots, n\}$. If m is even, let $b = m/2$, otherwise $b = (m + 1)/2$. For $1 \leq i \leq b$, let $d_i = e_{i+m-b} - e_b$. Thus, there are given the two sequences $1 \leq e_1 < \dots < e_b$ and $0 \leq d_1 < \dots < d_b$ (and we have $d_1 = 0$ if and only if m is odd).

Let $\tilde{V}(i)$ be the indecomposable $\tilde{\Lambda}$ -module of length $e_i + d_i$, generated in degree $e_b + d_i$, say with generator x_i . Let $y_i = T^{d_i} x_i$, this is an element of degree e_b , for all $1 \leq i \leq b$. Let \tilde{U} be generated by $y = \sum y_i$.

Here are two examples: We start with E equal to $\{2, 3, 5, 6, 8, 9\}$, or with $\{2, 3, 5, 8, 9\}$. In both cases, $b = 3$ and $\{e_1, e_2, e_3\} = \{2, 3, 5\}$; in particular, we have $b = 3$ and $e_b = 5$.

In the first case, $\{d_1, d_2, d_3\} = \{1, 3, 4\}$ (and m is even), in the second case, $\{d_1, d_2, d_3\} = \{0, 3, 4\}$ (and m is odd).

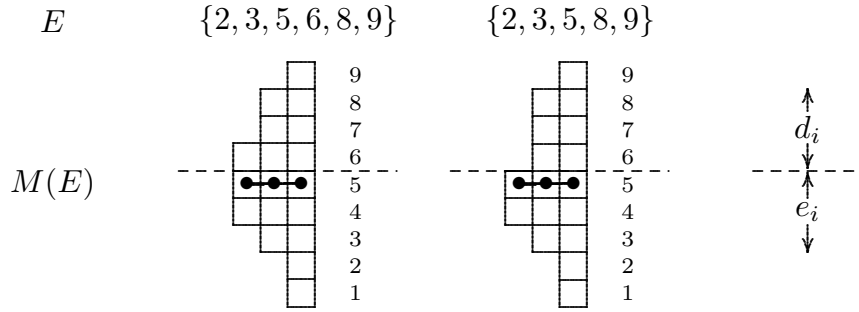

As usual, the pictures show a direct decomposition of the global space as a direct sum of $\tilde{\Lambda}$ -modules $\tilde{V}(i)$, with $1 \leq i \leq b$, as well as the generator y of \tilde{U} . We have inserted a horizontal dashed line: For $1 \leq i \leq b$, the number e_i is the length of the image of the map $\tilde{U} \rightarrow \tilde{V}(i)$, thus the number of boxes below the dashed line. the number d_i is the length of the cokernel of the map $\tilde{U} \rightarrow \tilde{V}(i)$, thus the number of boxes above the dashed line.

Proposition.

- (a) Any indecomposable object $X = (U, V)$ with $bU = 1$ is gradable.
- (b) The construction $E \mapsto \pi M(E)$ provides a bijection between the set of non-empty subsets of $\{1, \dots, n\}$ and the set of indecomposable objects $X = (U, V)$ in $\mathcal{S}(n)$ with $bU = 1$.
- (c) In particular, the number of indecomposable objects $X = (U, V)$ in $\mathcal{S}(n)$ with $bU = 1$ is $2^n - 1$, and the number of indecomposable objects $X = (U, V)$ with height n and $bU = 1$ is 2^{n-1} .
- (d) The number of indecomposable objects $X = (U, V)$ in $\mathcal{S}(n)$ with $bU = 1$ and $bX = b$ is $\binom{n}{2b-1} + \binom{n}{2b} = \binom{n+1}{2b}$.

Proof. (1) First, let us show that the modules $M(E)$ are indecomposable and pairwise non-isomorphic. For the indecomposability, we show inductively that $M(E)$ has endomorphism ring k : If E has cardinality at most 2, $M(E)$ is a picket. If E has cardinality at least 3, then $M(E)$ is an extension of an orthogonal pair, where one of the modules is a a picket, the other one a module of the form $M(E')$ such that the cardinality of E' is smaller than the cardinality of E .

In order to see that the objects $\pi M(E)$ are pairwise non-isomorphic, we show that we can recover E from $\pi M(E) = (U, V)$. The global space V is the direct sum of indecomposable Λ -modules $V(i)$ of length $e_i + d_i$ for $1 \leq i \leq b$, and the inclusion map $\mu : U \rightarrow V$ yields maps from U to $V(i)$ with image of length e_i .

(2) We show that any indecomposable object $X = (U, V)$ with $bU = 1$ is of the form $M(E)$ for some subset E of $\{1, \dots, n\}$. Let $X = (U, V)$. We decompose $V = \bigoplus V(i)$ with $V(i)$ indecomposable. The inclusion map $\mu : U \rightarrow V$ gives maps $\mu_i : U \rightarrow V(i)$. Let y be a generator of U and x_i a generator of $V(i)$. We can assume that $\mu(y) = T^{d_i} x_i$ with natural numbers $d_i \geq 0$ such that $d_1 \leq d_2 \leq \dots \leq d_b$.

Let e_i be the length of the image of μ_i . We claim that we have $e_i < e_{i+1}$. Assume for the contrary that $e_t \geq e_{t+1}$ for some $1 \leq t < b$. Then $V = V' \oplus V(t+1)$, where

V' is generated by the elements x_i with $i \neq t, t+1$ and the element $x_t + T^f x_{t+1}$, where $f = d_{t+1} - d_t$, and we have $U \subseteq V'$. Thus X is decomposable, a contradiction.

Second, we claim that $d_i < d_{i+1}$ for all $1 \leq i < b$. Assume for the contrary that $d_t = d_{t+1}$ for some $1 \leq t < b$. Then $V = V' \oplus V(t)$, where V' is generated by the elements x_i with $i \neq t, t+1$ and the element $x_t + x_{t+1}$, and we have $U \subseteq V'$. Thus X is decomposable, a contradiction.

Let $m = 2b - 1$, if $d_1 = 0$, and $m = 2b$ otherwise. For $1 \leq i \leq b$, let $e_{i+m-b} = d_i + e_b$, and let $E = \{e_1, \dots, e_m\}$. Then X is isomorphic to $\pi M(E)$.

(a) and (b) are direct consequences of (1) and (2).

(c) It follows from (b) that the number of indecomposable objects $X = (U, V)$ in $\mathcal{S}(n)$ with $bU = 1$ is $2^n - 1$. Thus, the number of indecomposable objects $X = (U, V)$ in $\mathcal{S}(n-1)$ with $bU = 1$ is $2^{n-1} - 1$. As a consequence, the number of indecomposable objects $X = (U, V)$ with height equal to n and with $bU = 1$ is $(2^n - 1) - (2^{n-1} - 1) = 2^{n-1}$.

(d) This follows from the fact that the width of $M(E)$ is b if and only if E has cardinality $2b - 1$ or $2b$. \square

Corollary. *Let $X = (U, V)$ be indecomposable in $\mathcal{S}(n)$ with $bU = 1$. Then we have $bX \leq uX$ and $bX \leq \frac{n+1}{2}$.*

Proof. According to Proposition, $X = \pi M(E)$ for a non-empty subset $E = \{e_1 < e_2 < \dots < e_m\}$ of $\{1, \dots, n\}$. Now $m \leq n$. The construction of $M(E)$ shows that $b = bX$ is equal to $\frac{m}{2}$ or to $\frac{m+1}{2}$. Thus $b \leq \frac{m+1}{2} \leq \frac{n+1}{2}$. Also, uX is the length of \tilde{U} , thus equal to e_b . Since $b \leq e_b$, we have $b \leq e_b = uX$. Of course, we have seen this inequality already in Theorem 1. \square

13.2. Insertion: The T -height sequence of a non-zero element in an object in $\mathcal{N}(n)$.

We have started to look at the objects $X = (U, V)$ in $\mathcal{S}(n)$ with $bU = 1$. This is the proper context for mentioning the concept of the T -height and the T -height sequence of a non-zero element $y \in V$, where V is an object in $\mathcal{N}(n)$, for some n , as considered by Prüfer [P] already in 1923. (Warning: The reader should be aware that height (as defined in 1.1) and T -height are completely different concepts: whereas the height of Λy is just the length of Λy and does not depend on the global space V , the T -height strongly depends on the embedding of y in V .)

Definitions. Let V be an object in $\mathcal{N}(n)$, and y a non-zero element in V : The T -height $h(y) = h_V(y)$ of y in V is the largest number d such that $y \in T^d V$. The T -height sequence $H(y) = H_V(y)$ of y in V is the sequence $h_V(y), h_V(Ty), \dots, h_V(T^{e-1}y)$, where $T^{e-1}y \neq 0$ and $T^e y = 0$. Obviously, the T -height sequence $H(y)$ of a non-zero element $y \in V$ is a strictly increasing sequence of numbers in $\{0, \dots, n-1\}$. Note that the T -height sequence does not depend on the choice of the generator y of Λy . Hence, if $U = \Lambda y$ is a non-zero cyclic submodule of V we may write $H(U) = H(y)$. We should mention that the sequence $H(x)$ and its relevance were discussed by Kaplansky [Kap], see p.57 ff (under the name Ulm sequence).

In order to be able to phrase these definitions in terms of the category $\mathcal{S}(n)$, we need the following observation.

We recall from [ARS] that a homomorphism $f: V \rightarrow V'$ in a length category is said to be *left minimal* provided any endomorphism $g: V' \rightarrow V'$ with $gf = f$ is an automorphism. And given any morphism $f: U \rightarrow V$, there is a direct decomposition $V = V' \oplus V''$ such that the image of f is contained in V' and $p_{V'}f: U \rightarrow V'$ is left minimal, where $p_{V'}$ is the projection of V onto V' ; the map $p_{V'}f: U \rightarrow V'$ is called a left minimal version of f . If $p_{V'}f: U \rightarrow V'$ and $p_{V'_1}f: U \rightarrow V'_1$ are left minimal versions of $f: U \rightarrow V$, then there is an isomorphism $h: V' \rightarrow V'_1$ with $p_{V'}f = hp_{V'_1}$.

Lemma. *Let U be indecomposable in $\mathcal{N}(n)$ and $X = (U, V)$ an object in $\mathcal{S}(n)$. Then (U, V) is indecomposable if and only if the inclusion map $U \rightarrow X$ is left minimal.*

Proof. First, assume that (U, V) is indecomposable. Let (U, V') be a left minimal version of the inclusion map $U \rightarrow V$, say with $V = V' \oplus V''$. Then we get a direct decomposition $(U, V) = (U, V') \oplus (0, V'')$ in $\mathcal{S}(n)$, thus the indecomposability of (U, V) asserts that $V'' = 0$, thus $V' = V$. This shows that the inclusion map $U \rightarrow V$ is left minimal. Conversely, assume that the inclusion map $U \rightarrow V$ is left minimal. Given any direct decomposition $(U, V) = (U', V') \oplus (U'', V'')$, we have $U = U' \oplus U''$. Since we assume that U is indecomposable, we see that one of U', U'' is zero, say $U'' = 0$, thus we deal with a direct decomposition $V = V' \oplus V''$ such that $U = U' \subseteq V'$. Since $U \rightarrow V$ is left minimal, $V'' = 0$, thus (U, V) is indecomposable. \square

Remark. In the Lemma, we need the assumption that U is indecomposable. Namely, a 0-picket $(0, [m])$ is indecomposable, but $0 \rightarrow [m]$ is not left minimal. Also, if U is non-zero and decomposable, then (U, U) is decomposable, but the identity map $U \rightarrow U$ is left minimal.

Let us return to the setting we are interested in. There is given a (usually decomposable) object V in $\mathcal{N}(n)$, and a non-zero element y in V , thus, we consider $U = \Lambda y$. Then there is a direct decomposition $V = V' \oplus V''$ in $\mathcal{N}(n)$ such that the map $U \rightarrow V'$ is a left minimal version of the inclusion map $U \rightarrow V$. Then, the pair (U, V') is indecomposable in $\mathcal{S}(n)$ and uniquely determined (up to isomorphism).

Note that given V in $\mathcal{N}(n)$, and a non-zero element $y \in V$, let $U = \Lambda y$ and let $V = V' \oplus V''$ be a direct decomposition with $U \subseteq V'$ such that $U \rightarrow V'$ is a left minimal version of the inclusion map $U \rightarrow V$. Then neither V' nor V'' are usually uniquely determined: As an example, take $V = [2, 1]$ with generators x_1, x_2 annihilated by T^2 and T , respectively, and take $y = Tx_1$. Then we have in $\mathcal{N}(n)$ the decompositions $V = \Lambda x_1 \oplus \Lambda x_2 = \Lambda(x_1 + x_2) \oplus \Lambda(Tx_1 + x_2)$ and $y = Tx_1 = T(x_1 + x_2)$.

13.3. A second combinatorial description.

We use the considerations in 13.2. in order to construct a second description of the set of indecomposable objects $X = (U, V)$ with $bU = 1$.

Starting with an arbitrary non-empty subset E of $\{1, \dots, n\}$, we may apply H to the subspace U in $M(E)$ and write $H(E) = H_{M(E)}(U)$ for the T -height sequence of U in $M(E)$.

Let us consider as an example the case $E = \{2, 3, 5, 6, 8, 9\}$,

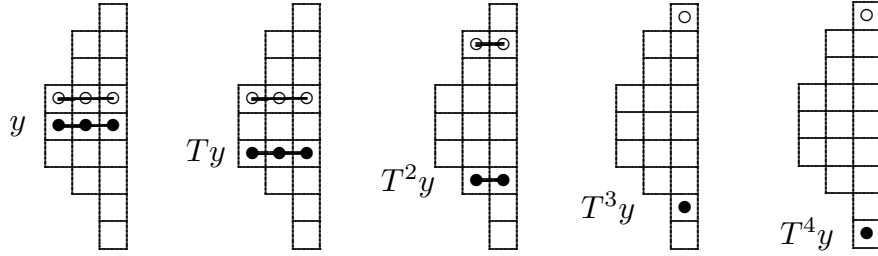

For $1 \leq i \leq 5$, we have inserted in the global space of $M(E)$ both the element $T^{i-1}y$ (using bullets), as well as an element z with $T^{H_i}z = T^{i-1}y$ (using small circles). We get $H(U) = (H_1, \dots, H_5) = (1, 2, 5, 7, 8)$.

Proposition. *The map $H: E \mapsto H(E)$ induces a bijection between the non-empty subsets of $\{1, \dots, n\}$ and the non-empty subsets of $\{0, \dots, n-1\}$.*

Proof. It is easy to see that (H_1, \dots, H_t) is the concatenation of b intervals of natural numbers, namely of the intervals

$$[d_1, \dots, d_1 + e_1 - 1], [d_2 + e_1, \dots, d_2 + e_2 - 1], \dots, [d_b + e_{b-1} + 1, \dots, d_b + e_b - 1],$$

in the prescribed order; here, the intervals have length $e_i - e_{i-1}$ (with $e_0 = 0$) and end in $d_i + e_i - 1$; in-between the intervals is always a jump by at least 2. (In the example above, the sequence $H(U)$ is cut into the intervals $[1, 2]$, $[5]$, $[7, 8]$.) This shows that we can recover from the sequence (H_1, \dots, H_t) , first the sequence e_i , then the sequence d_i , thus we recover E . We see in this way that H is an injective map, thus a bijective map. \square

Corollary. *The number of indecomposable objects $X = (U, V)$ in $\mathcal{S}(n)$ with $n \geq 1$ and $U = [m]$ is $\binom{n}{m}$. The number of indecomposable objects $X = (U, V)$ of height n with $U = [m]$ (and $n, m \geq 1$) is $\binom{n-1}{m-1}$.*

Proof. By the definition of H , the cardinality of $H(E)$ is the length of U , thus, for $U = [m]$, equal to m . Of course, the number of subsets of $\{0, \dots, n-1\}$ of cardinality m is $\binom{n}{m}$.

Let $n, m \geq 1$. The number of indecomposable objects $X = (U, V)$ in $\mathcal{S}(n)$ with $U = [m]$ is $\binom{n}{m}$, the number of indecomposable objects $X = (U, V)$ in $\mathcal{S}(n)$ which have height at most $n-1$ such that $U = [m]$ is $\binom{n-1}{m-1}$. Thus, the number of indecomposable objects $X = (U, V)$ of height n with $U = [m]$ is

$$\binom{n}{m} - \binom{n-1}{m-1} = \binom{n-1}{m}.$$

\square

13.4. The indecomposable objects $X = (U, V)$ with $bU = 1 = pX$.

We have seen in Section 7.2 that there is a bijection between, on one hand, the isomorphism classes of the indecomposable objects $X = (U, V)$ in $\mathcal{S}(n)$ with $pX = 1$ and

$bU = 1$, and, on the other hand, the strongly decreasing partitions bounded by n , by sending $X = (U, V)$ to $[V]$. The indecomposable object X corresponding to λ has been denoted by $X = C_\lambda$.

Proposition. *The number of strongly decreasing partitions λ of height n is the n -th Fibonacci number F_n .*

Proof. Let $\Pi(n)$ be the set of strongly decreasing partitions λ with $\lambda_1 = n$. Clearly, $|\Pi(0)| = 0 = F_0$, and $|\Pi(1)| = 1 = F_1$. For $i \geq 2$, let $\Pi_1(n)$ be the subset of $\Pi(n)$ consisting of those partitions which end with 1. If $\lambda = [\lambda_1, \dots, \lambda_b] \in \Pi_1(n)$, then $[\lambda_1 - 2, \dots, \lambda_{b-1} - 2]$ belongs to $\Pi(n - 2)$; this map provides a bijection between $\Pi_1(n)$ and $\Pi(n - 2)$. Similarly, if $\lambda = [\lambda_1, \dots, \lambda_b] \in \Pi(n) \setminus \Pi_1(n)$, then $[\lambda_1 - 1, \dots, \lambda_b - 1]$ belongs to $\Pi(n - 1)$; this map provides a bijection between $\Pi(n) \setminus \Pi_1(n)$ and $\Pi(n - 1)$. Altogether, we see that $|\Pi(n)| = |\Pi(n - 2)| + |\Pi(n - 1)|$. \square

Corollary. *The number of indecomposable objects $X = (U, V) \in \mathcal{S}(n)$ with $pX = 1$ and $bU = 1$ is $F_{n+2} - 1$ where F_{n+2} is the $(n + 2)$ -nd Fibonacci number.*

Proof. Note $\sum_{i=1}^n F_i = F_{n+2} - F_2 = F_{n+2} - 1$. \square

13.5. The indecomposable objects $X = (U, V)$ with $bU = 1 = bW$.

Proposition. *Let $X = (U, V)$ be indecomposable. Then $bU \leq 1$, and $bW \leq 1$ if and only if X is a picket or else a bipicket of the form $B(c_1, 0, c_3, 0, c_5)$.*

Proof. We only have to show: If $bU \leq 1$ and $bW \leq 1$, then $bV \leq 2$. Now $bU = |\text{soc } U|$ and $bW = |\text{soc } W|$. We have $\text{soc } V = \text{Hom}(k, V)$ for $V \in \mathcal{N}$. If we apply $\text{Hom}(k, -)$ to the exact sequence $0 \rightarrow U \rightarrow V \rightarrow W \rightarrow 0$, we obtain the exact sequence $0 \rightarrow \text{soc } U \rightarrow \text{soc } V \rightarrow \text{soc } W$. \square

We see: If $X = (U, V)$ is indecomposable with $bU = 1 = bW$, then either X is a picket which is neither void nor full, or else it is the bipicket $B(c_1, 0, c_3, 0, c_5)$ (with $U = [c_1 + c_3]$ and $W = [c_3 + c_5]$, see Section 12.2).

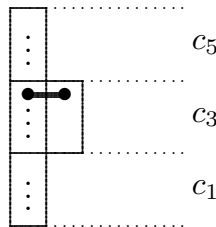

14. Objects in \mathcal{S} which are not gradable.

All the examples which have been presented until now, were gradable. But we should stress that the concepts of mean and level apply to all non-zero objects in \mathcal{S} , not only for the gradable ones.

As we have mentioned, all pickets are, of course, gradable, as are all bipickets, see Proposition 12.2. Also, it has been shown in [RS1] that all objects in $\mathcal{S}(6)$ are gradable.

14.1. Some examples. Here is a typical non-gradable object X in $\mathcal{S}(7)$:

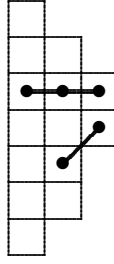

(to be precise: $X = (U, V)$ with V generated by v_1, v_2, v_3 such that $T^7 v_1 = T^5 v_2 = T^2 v_3 = 0$, and U generated by $T^2 v_1 + T v_2 + v_3$ and $T^3 v_2 + T v_4$). We have

$$\mathbf{par} X = ([5, 2], [7, 5, 2], [5, 2]),$$

thus $\mathbf{par} \tau^i X = \mathbf{par} X$ for all i . In particular, all objects $\tau^i X$ are central. More generally, let us consider the following example.

Example. Let $n \geq 6$. let us consider the following object $X = (U, V)$ in $\mathcal{S}(n)$ with

$$\mathbf{par} X = ([n - 2, 2], [n, n - 2, 2], [n - 2, 2]),$$

with V generated by v_1, v_2, v_3 such that $T^n v_1 = T^{n-2} v_2 = T^2 v_3 = 0$, and U generated by

$$u_1 = T^2 v_1 + T v_2 + v_3 \quad \text{and} \quad u_2 = T^{n-4} v_2 + T v_4.$$

For example, for $n = 7$, we obtain the object X shown above.

Proposition. *Let $n \geq 7$. There are no indecomposable objects \tilde{X} in $\tilde{\mathcal{S}}(n)$ with $\mathbf{par} \tilde{X} = ([n - 2, 2], [n, n - 2, 2], [n - 2, 2])$.*

Proof. All the algebras and the modules considered in the proof are \mathbb{Z} -graded, and the elements considered are homogeneous elements. To simplify the notation, we will usually omit the use of a tilde.

We assume that $X = (U, V)$ is an indecomposable (graded!) object in $\tilde{\mathcal{S}}(n)$ with $\mathbf{par} X = ([n - 2, 2], [n, n - 2, 2], [n - 2, 2])$. We decompose $V = V(1) \oplus V(2) \oplus V(3)$ with $V(1), V(2), V(3)$ of length $n, n - 2, 2$, respectively, with $V(i)$ generated in degree $d(i)$, say by x_i , for $1 \leq i \leq 3$. Without loss of generality, we may assume that $d(1) = n$.

(1) *The canonical map $U \rightarrow V \rightarrow V(2)$ is not surjective.* *Proof.* Otherwise, there is an element $u \in U$ of the form $u = \lambda_1 x_1 + x_2 + \lambda_3 x_3$ (with $\lambda_1, \lambda_3 \in \Lambda$). Then V is generated by x_1, u, x_3 . Now Λu must have length $n - 2$, thus $V = \Lambda u \oplus (V(1) + V(3))$. Since $\Lambda u \subseteq U$, the modular law shows that $U = \Lambda u \oplus ((V(1) + V(3)) \cap U)$, therefore (U, V) is decomposable, a contradiction.

(2) *The canonical map $U \rightarrow V \rightarrow V(3)$ is surjective.* Otherwise, U is contained in $\text{rad } V(1) \oplus \text{rad } V(2) \oplus \text{rad } V(3) = \text{rad } V$, and $W = V/U$ has $bW = 3$, a contradiction.

(3) *There is no element $u' \in U$ such that $\Lambda u'$ has length 2 and maps onto $V(3)$.* Assume there is an element $u' \in U$ of the form $u' = \lambda_1 x_1 + \lambda_2 x_2 + x_3$. Then V is generated by

x_1, x_2, u' . As in (1) we see that $V = \Lambda u' \oplus (V(1) + V(2))$ and $U = \Lambda u' \oplus ((V(1) + V(2)) \cap U)$, therefore (U, V) is decomposable, a contradiction.

(4) According to (2) and (3), there is an element $u \in U$ such that Λu has length $n - 2$ and maps onto $V(3)$. According to (1), we can assume that $u = T^2 x_1 + T^m x_2 + x_3$ for some $m \geq 1$ (changing, if necessary, the generators x_1, x_2).

(5) *We must have $m \geq 2$.* Assume, for the contrary, that $m = 1$. Then, for $m \geq 7$, the global space V with u inserted looks as follows:

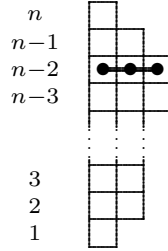

Since the partition of U is $[n - 2, 2]$, we have $U = \Lambda u \oplus \Lambda u'$, where $\Lambda u'$ has length 2. Since $\Lambda u'$ has length 2, the degree d' of u' has to be 2, 3 or $n - 2$. Now $d' = n - 2$ is impossible, according to (3). Also $d' = 2$ is impossible, since in this case both $\text{soc } \Lambda u'$ and $\text{soc } \Lambda u$ are the elements in V of degree 1, thus $\Lambda u' \cap \Lambda u \neq 0$. It follows that u' has degree 3. In this case, all elements of V of degree at most 3 belong to U (here, we use $n \geq 7$). As a consequence, $W = V/U$ is annihilated by T^{n-3} , thus its partition cannot be $[n - 2, 2]$.

(6) *We can assume that $u = T^2 x_1 + x_3$.* Namely, consider a case where $2 \leq m \leq n - 3$. Since $T^m x_2 \neq 0$, the homogeneous element u with degree $n - 2$ shows that $d(2) = n - 2 + m$, thus $T^{m-2} x_2$ has degree n . Let $x'_1 = x_1 + T^{m-2} x_2$. Then V is generated by x'_1, x_2, x_3 and the element $T^2 x'_1 + x_3 = T^2(x_1 + T^{m-2} x_2) + x_3$ is just the element u , and therefore belongs to U . Thus, it is sufficient to replace x_1 by x'_1 .

(7) Finally, we are in the situation that V is generated by x_1, x_2, x_3 and U is generated by the element $u = T^2 x_1 + x_3$ with Λu of length $n - 2$ and an additional element u' with $\Lambda u'$ of length 2. According to (3), u' lies in $\Lambda x_1 + \Lambda x_2 + \Lambda T x_3$, thus in $\Lambda T^{n-2} x_1 + \Lambda T^{n-4} x_2 + \Lambda T x_3$, since Λu has length 2. Now $T^{n-2} x_1 = T^{n-4} u$ belongs to U , thus we can assume that u' belongs to $\Lambda T^{n-4} x_2 + \Lambda T x_3$, or even that $u' = T^{n-4} x_2 + T x_3$. It follows that $T^{n-3} x_2 = T u'$ belongs to U . Since also $T^{n-3} x_1$ belongs to U , we see also here that $W = V/U$ is annihilated by T^{n-3} , thus its partition cannot be $[n - 2, 2]$. \square

Corollary. *For $n \geq 7$, the objects $X = (U, V)$ in $\mathcal{S}(n)$ with*

$$\mathbf{par} X = ([n - 2, 2], [n, n - 2, 2], [n - 2, 2])$$

presented above, are not gradable. \square

14.2. These objects belong to homogeneous tubes.

We recall from [RS2, Corollary 6.5] that all indecomposable objects in $\mathcal{S}(n)$ for $n \geq 6$ occur in tubes of rank 1, 2, 3, or 6; the tubes of rank 1 are said to be homogeneous.

Proposition. *Let $n > 6$. Let X be one of the objects as defined in 14.1. Then $\tau_n X = X$.*

Proof. We work in the category $\mathcal{N}(n)$ of all Λ -modules, where $\Lambda = k[T]/\langle T^n \rangle$. Canonical inclusion maps in $\mathcal{N}(n)$ are denoted by μ , canonical epimorphisms by ε , and we denote the multiplication map by T just by T .

If we use the generators $v_1, v_2, -v_3$ of $[n, n-2, 2]$, we see that $X = (U, V)$ is given by the inclusion map

$$\begin{bmatrix} \mu & 0 \\ T & \mu \\ -\varepsilon & -T \end{bmatrix} : [n-2, 2] \rightarrow [n, n-2, 2],$$

or also by the inclusion map

$$X' = \begin{bmatrix} 1-T^{n-6} & 0 & 0 \\ 0 & 1 & 0 \\ 0 & 0 & 1 \end{bmatrix} \cdot \begin{bmatrix} \mu & 0 \\ T & \mu \\ -\varepsilon & -T \end{bmatrix} : [n-2, 2] \rightarrow [n, n-2, 2]$$

(obtained from X by applying an automorphism of $[n, n-2, 2]$).

We are going to form $\tau_n X = \tau_n X' = \text{Mimo } \tau_\Lambda \text{ Cok } X'$ (see [RS2]).

There is the commutative diagram

$$\begin{array}{ccccc} & & [n] & \xrightarrow{1-T^{n-6}} & [n] & & \begin{bmatrix} \varepsilon \\ 0 \end{bmatrix} \\ & \nearrow [\mu \ 0] & & & & \searrow & \\ [n-2, 2] & & & & & & [n-2, 2] \\ & \searrow \begin{bmatrix} T & \mu \\ -\varepsilon & -T \end{bmatrix} & & & & \nearrow \begin{bmatrix} T & \mu \\ \varepsilon & T \end{bmatrix} & \\ & & [n-2, 2] & & & & \end{array}$$

since for both paths, the composition from left to right is equal to $\begin{bmatrix} T^2 - T^{n-4} & 0 \\ 0 & 0 \end{bmatrix}$.

It shows that the following sequence is exact:

$$0 \longrightarrow [n-2, 2] \xrightarrow{X'} [n, n-2, 2] \xrightarrow{Y} [n-2, 2] \longrightarrow 0$$

with

$$Y = \begin{bmatrix} -\varepsilon & T & \mu \\ 0 & \varepsilon & T \end{bmatrix} : [n, n-2, 2] \rightarrow [n-2, 2]$$

(namely, the commutativity shows that the composition YX' is zero; we know that the map X' is a monomorphism, and we easily see that the map Y is an epimorphism; finally, the length of the middle term is the sum of the length of the end-terms).

Now $\tau_\Lambda Y$ is given by the matrix

$$\tau_\Lambda Y = \begin{bmatrix} T & \mu \\ \varepsilon & T \end{bmatrix} : [n-2, 2] \rightarrow [n-2, 2].$$

It remains to form

$$\text{Mimo } \tau_\Lambda Y = \begin{bmatrix} \mu & 0 \\ T & \mu \\ \varepsilon & T \end{bmatrix} : [n-2, 2] \rightarrow [n, n-2, 2],$$

but this is just X . This completes the proof. \square

Corollary. *Each category $\mathcal{S}(n)$ for $n \geq 6$ contains homogeneous tubes.* \square

Remark. Proposition asserts that for $n > 6$, the object defined in 14.1 belongs to a homogeneous tube. In contrast, for $n = 6$, the object lies in the tube of rank 3 and rationality index 0.

14.3. Homogeneous tubes containing graded objects.

Proposition. *There exist homogeneous tubes of gradable objects in $\mathcal{S}(n)$ if and only if 6 divides n .*

Proof. If 6 does not divide n , then see [RS2, Corollary 6.6].

Thus, let us assume that 6 divides n . We want to exhibit objects $M_c(n)$ which are homogeneous. Write $n = 6\ell$ and define $M_c(n) = (U, V)$ with V generated by elements v_1, v_2, v_3 of height $6\ell, 4\ell$ and 2ℓ , respectively, and let U be generated by $u_1 = T^{2\ell}v_1 + c_0T^\ell v_2 + c_1v_3$ and $u_2 = T^{2\ell}v_2 + T^\ell v_3$, thus $\mathbf{par} M_c(n) = ([4\ell, 2\ell], [6\ell, 4\ell, 2\ell], [4\ell, 2\ell])$. Then $M_c(n)$ is gradable, in fact, if $M_c(n) = \pi \widetilde{M}_c(n)$ then $\tau_{\widetilde{\mathcal{S}}} \widetilde{M}_c(n) = \widetilde{M}_c(n)[\frac{n-6}{6}] = \widetilde{M}_c(n)[\ell - 1]$, for $(c_0 : c_1) \neq (0 : 1), (1 : 0), (1 : 1)$. Namely, the representation $\widetilde{M}_c(n)$ is obtained from $\widetilde{M}_c(6)$ by replicating the vector spaces ℓ times. Applying the dual of the transpose in $\widetilde{\mathcal{S}}(n)$ results in a representation obtained from $\tau_{\widetilde{\mathcal{S}}} \widetilde{M}_c(6)$ by a corresponding replication of its vector spaces. It follows that $M_c(n)$ lies on the mouth of a homogeneous tube. \square

14.4. Auslander-Reiten components in $\mathcal{S}(n)$ containing gradable objects.

For $n \geq 6$, every Auslander-Reiten component in $\mathcal{S}(n)$ is an m -tube for m a divisor of six [RS2]. We have seen in 14.3 that, unless n is a multiple of 6, no Auslander-Reiten component in $\mathcal{S}(n)$ which contains gradable objects is homogeneous. For tubes of rank 2 or 3 we have the following statement.

Proposition. *Let $n \geq 6$.*

- (a) *The category $\mathcal{S}(n)$ has 3-tubes consisting of gradable objects if and only if n is even.*
- (b) *$\mathcal{S}(n)$ has 2-tubes consisting of gradable objects if and only if n is divisible by 3.*

Proof. We first show the “only if” direction. Let X be a gradable object in $\mathcal{S}(n)$ which is indecomposable and not projective. Denote by m its minimal τ -period. Of course, we know that m is a divisor of 6, thus $mm' = 6$ for some integer m' . We show that m' is a divisor of $n - 6$.

Since X is gradable, there is \widetilde{X} in $\widetilde{\mathcal{S}}(n)$ with $\pi \widetilde{X} = X$. Since $\tau^m X = X$, there is an integer s such that $\widetilde{\tau}^m \widetilde{X} = \widetilde{X}[s]$; here, $\widetilde{\tau}$ is the Auslander-Reiten translation in $\widetilde{\mathcal{S}}(n)$ and $[1]$ is the shift-operator in $\widetilde{\mathcal{S}}(n)$. It follows that $\widetilde{\tau}^6 \widetilde{X} = \widetilde{\tau}^{mm'} \widetilde{X} = \widetilde{X}[sm']$.

According to [RS2], the Auslander-Reiten translation in any $\widetilde{\mathcal{S}}(n)$ satisfies $\widetilde{\tau}^6 M = M[n - 6]$ for any indecomposable non-projective object M in $\widetilde{\mathcal{S}}(n)$, therefore $\widetilde{\tau}^6 \widetilde{X} = \widetilde{X}[n - 6]$.

Altogether, we see that $\widetilde{X}[sm'] = \widetilde{\tau}^6 \widetilde{X} = \widetilde{X}[n - 6]$, therefore $sm' = n - 6$, thus m' is a divisor of $n - 6$. In particular, if $m = 3$ then n must be even and if $m = 2$ then n must be divisible by 3.

For the converse direction, if $n \geq 6$ is even, we can consider the picket $(0; [\frac{n}{2}])$ which is determined uniquely by its partition type. The mouth of the 3-tube which contains this object has the following shape.

$$(0; [\frac{n}{2}]) \xleftarrow{\tau} ([\frac{n}{2}]; [n]) \xleftarrow{\tau} ([\frac{n}{2}]; [\frac{n}{2}]) \xleftarrow{\tau} (0; [\frac{n}{2}])$$

Similarly, if n is divisible by 3, the picket $([\frac{n}{3}]; [\frac{2n}{3}])$ occurs on the mouth of a 2-tube.

$$([\frac{n}{3}]; [\frac{2n}{3}]) \xleftarrow{\tau} ([\frac{2n}{3}]; [n, \frac{n}{3}]; [\frac{2n}{3}]) \xleftarrow{\tau} ([\frac{n}{3}]; [\frac{2n}{3}])$$

□

Corollary. *Any Auslander-Reiten component in $\mathcal{S}(7)$ which contains gradable objects is a 6-tube.* □

14.5. Gradability of objects.

As we have mentioned, all objects in $\mathcal{S}(6)$ are gradable, see [RS1]. The novice may be surprised by this fact, thus let us consider explicitly three objects $X = (U, V)$ in $\mathcal{S}(6)$ which look similar to the objects in $\mathcal{S}(7)$ which have been shown to be non-gradable. In all cases, let V be generated by v_1, v_2, v_3 of height 6, 4, 2, respectively, and U generated by $u_1 = T^2v_1 + Tv_2 + v_3$ and a further element u_2 .

(1) Let $u_2 = T^2v_2 + v_3$. Then V is generated by $v'_1 = v_1, v'_2 = v_2 - Tv_2, v'_3 = v_3 + T^2v_2$, and U is generated by $u_1 = T^2v'_1 + Tv'_2$ and $u_2 = v'_3$, thus even decomposable.

(2) Let $u_2 = T^3v_2 + v_3$. Then V is generated by $v'_1 = v_1, v'_2 = v_2 - T^2v_2, v'_3 = v_3 + T^3v_2$, and U is generated by $u_1 = T^2v'_1 + Tv'_2$ and $u_2 = v'_3$, thus again decomposable.

(3) Let $u_2 = T^3v_2 + Tv_3$. Then V is generated by $v'_1 = v_1, v'_2 = v_2 - Tv_2, v'_3 = v_3 + T^2v_2$, and U is generated by $u_1 = T^2v'_1 + Tv'_2 + v'_3$ and $u_2 = Tv'_3$, thus indecomposable, but obviously gradable.

Here are the corresponding pictures:

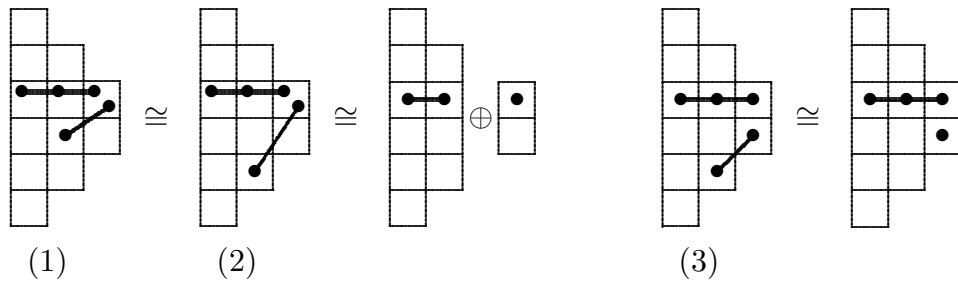

Thus, we have found objects isomorphic to (1), (2) and (3) which are gradable.

15. Gallery: Some Examples.

We are going to exhibit some examples of objects in \mathcal{S} which are worth to be aware of.

15.1. The cases $\mathcal{S}(n)$ with $n \leq 5$.

In this Section we present the pr-triangles for the representation finite categories $\mathcal{S}(n)$ where $n \leq 5$. The corresponding Auslander-Reiten quivers can be found in [RS1].

In view of later questions, it seems to be interesting to watch in 15.2 (g) and 15.3 how the lines $p = 1$ (horizontal) and $q = 3$ (diagonal) evolve as n increases, and which objects arise in the regions $2 < q < 3$ and $3 < q < 4$.

The case $n = 1$. (Note that this case is not covered in [RS1], but is, of course, trivial: It is the so-called Basis Extension Theorem from linear algebra which provides the classification of the indecomposable objects in $\mathcal{S}(1)$.)

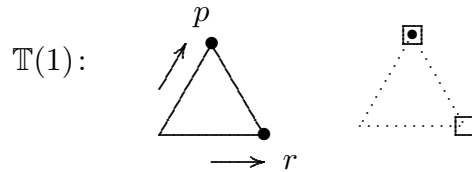

The case $n = 2$. The objects in $\mathcal{S}(2)$ are determined in [RS1, (6.2)]. We stress: *Each indecomposable object (U, V) in $\mathcal{S}(2)$ lies on the boundary of $\mathbb{T}(2)$; in particular, it is a picket.*

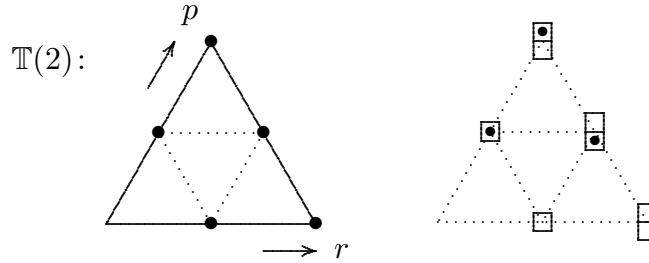

The case $n = 3$. There is a single indecomposable object which is not a picket, namely $E = E_2^2$ with uwb-vector $\frac{2|2}{2}$, thus with pr-vector $(1, 1) = z(3)$. *Each indecomposable object (U, V) in $\mathcal{S}(3)$ lies on the grid of $\mathbb{T}(3)$ with integral coefficients.*

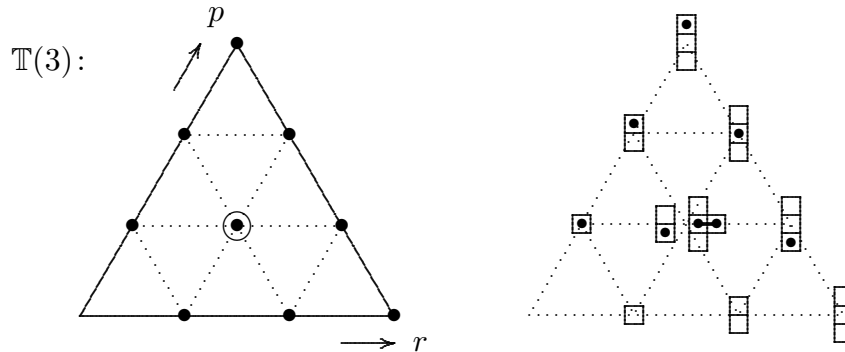

Case $n = 4$. The τ_n -orbits of the pickets provide all but 3 indecomposable objects,

the missing ones form the τ_n -orbit of $E_2^2 = C_{(3,1)}$.

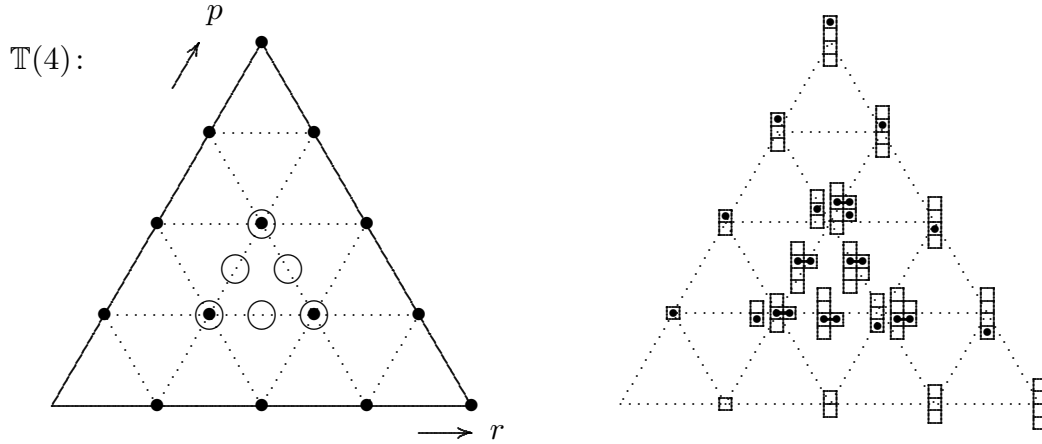

Case $n = 5$. The τ_n -orbits of the pickets provide 26 indecomposable objects. There are 24 additional objects, they form four τ_n -orbits of cardinality 6. Three of these orbits contain objects of the form C_λ , with λ a partition (see 7.2 and 13.4): One orbit contains $C_{(4,1)}$ and $C_{(5,2)}$, a second one contains $C_{(4,2)}$ and $C_{(5,3,1)}$, a third one contains $C_{(3,1)}$ and $C_{(5,3)}$. The fourth one is the branching orbit, it is the orbit of the object X with $\text{par } X = ([3, 1], [5, 3, 1], [3, 2])$.

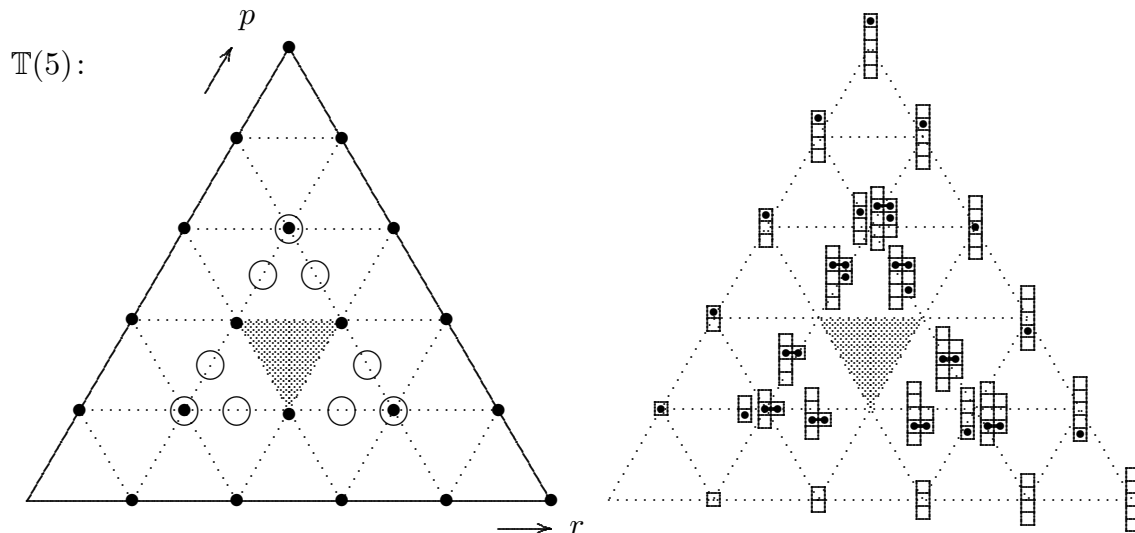

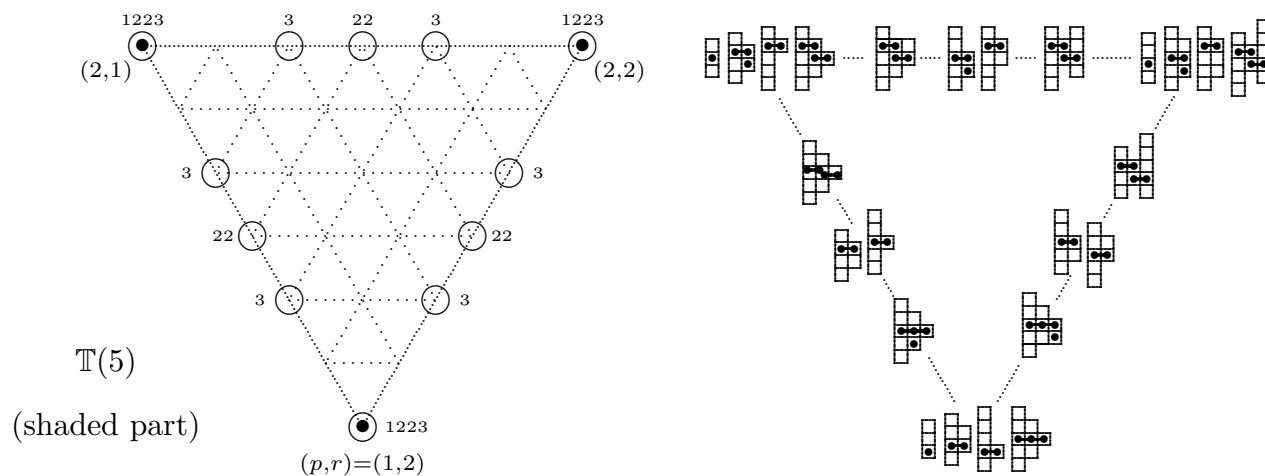

15.2. Some indecomposables in $\mathcal{S}(6)$.

The Auslander-Reiten quiver of $\mathcal{S}(6)$ has been discussed in [RS1]. Some of the components, in particular the principal component $\mathcal{P}(6)$, are displayed in [RS1]. The remaining components which contain pickets or bipickets are exhibited in [S2].

We first sketch the pr-triangle for $\mathcal{S}(6)$ and exhibit the objects outside the central hexagon.

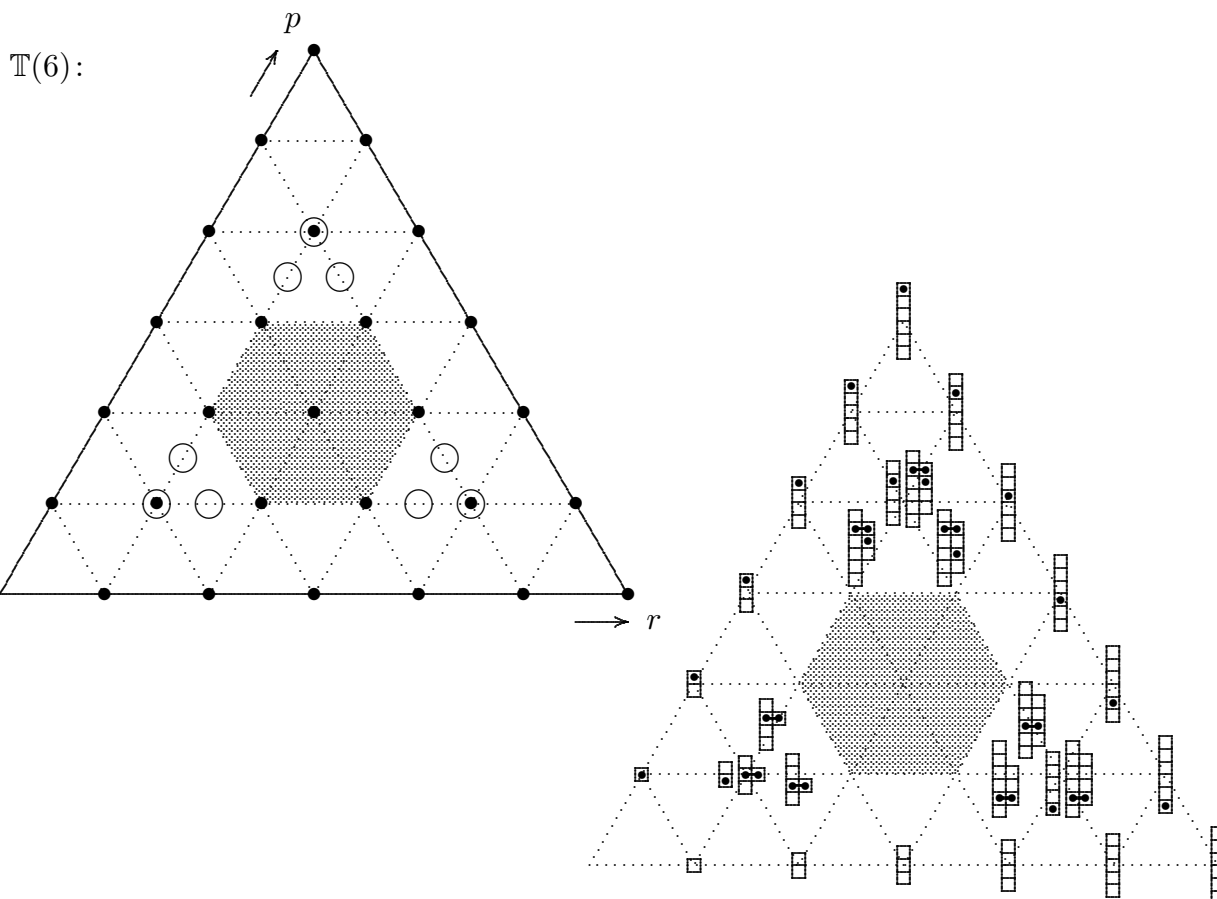

Now we are going to exhibit the boundary of the hexagon.

(a) The pickets in the boundary of the hexagon of $\mathcal{S}(6)$:

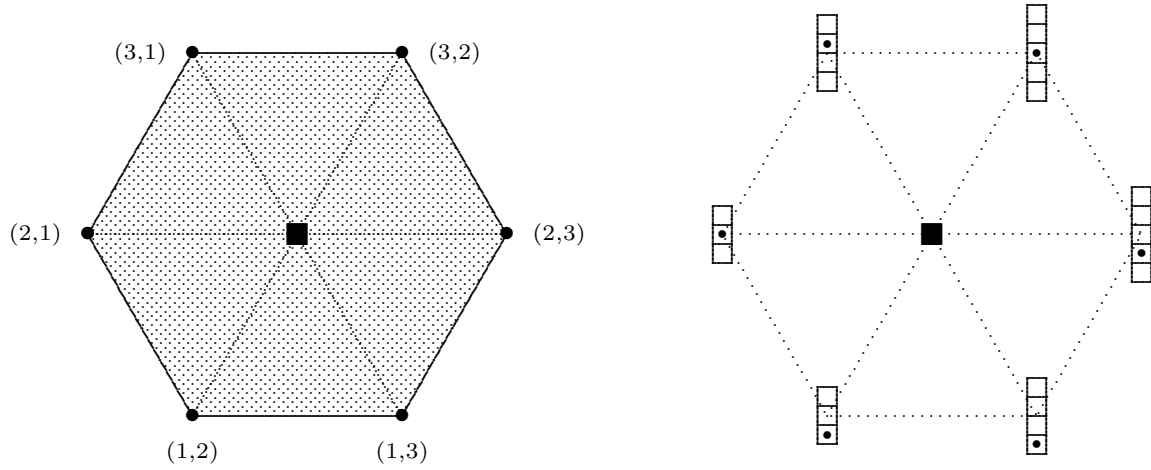

(b) The bipickets in the boundary of the hexagon of $\mathcal{S}(6)$:

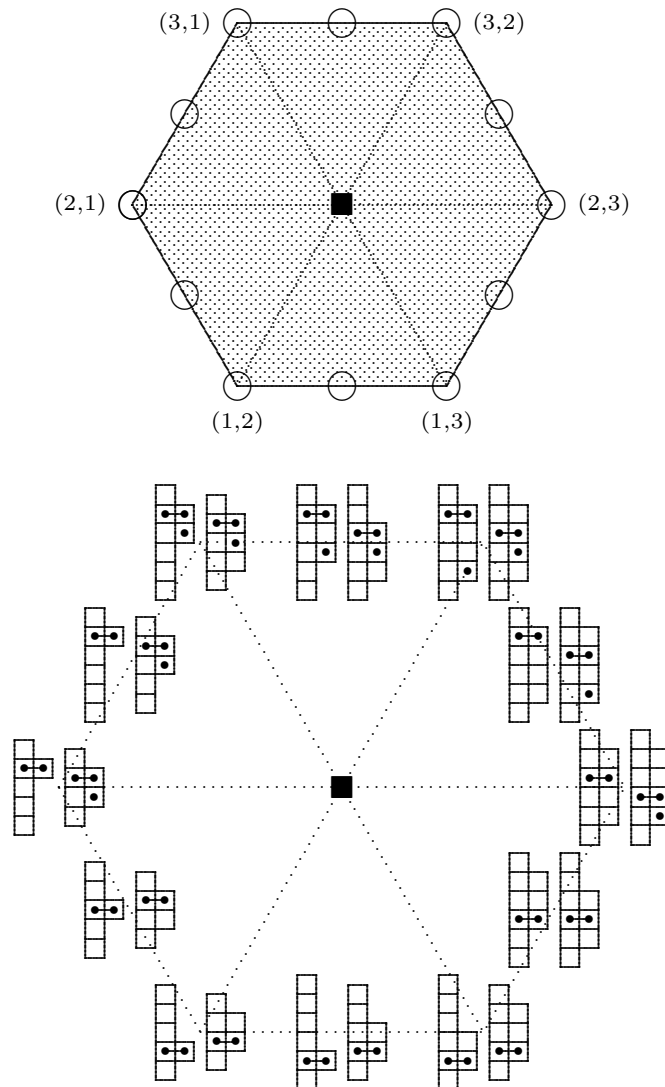

The position (rationality index, rank of tube) of each bipicket in $\mathcal{S}(6)$ is specified in 15.2 (g).

(c) The tripickets in the boundary of the hexagon of $\mathcal{S}(6)$:

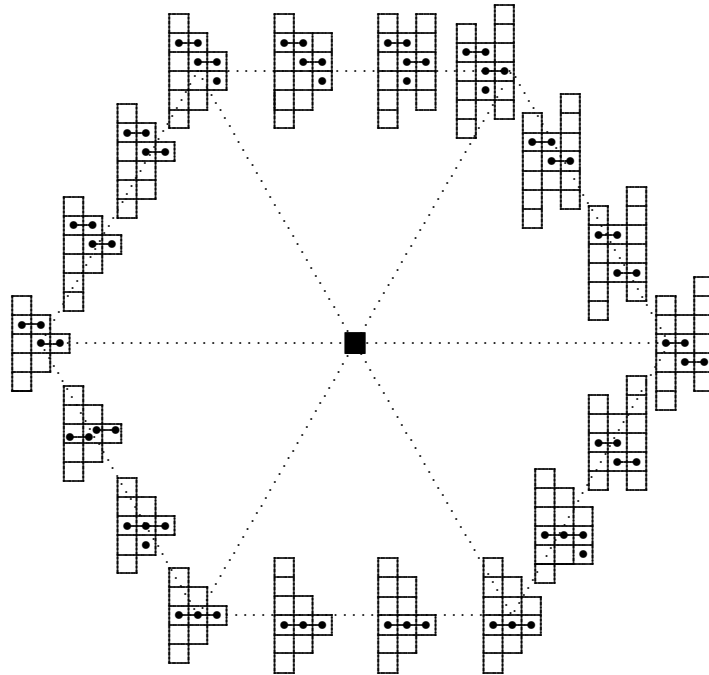
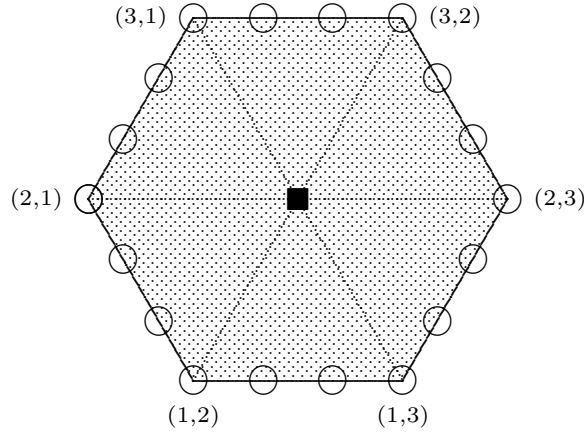

The 18 objects form 3 orbits under Σ_3 . The leftmost object in the bottom row occurs on the mouth of the tube of rank 3 and rationality index $\frac{1}{2}$. Its left and right neighbors are on the mouth of the tube of rank 6 and index $\frac{3}{4}$ and $\frac{2}{3}$, respectively.

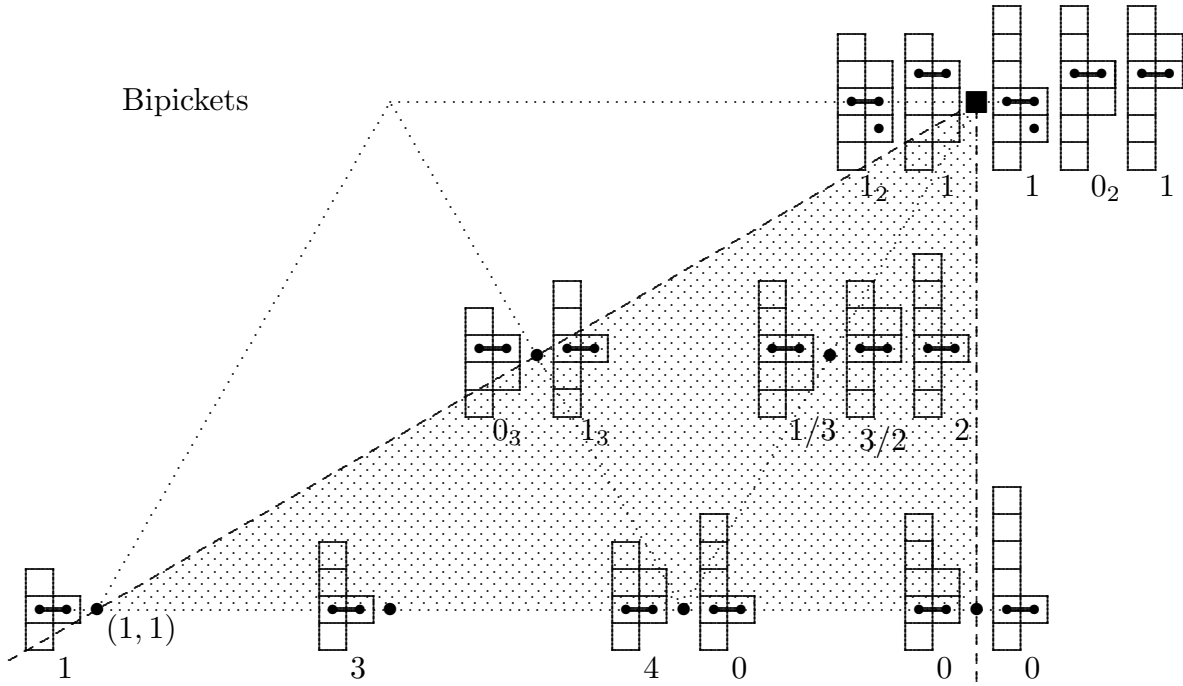

The number mentioned below an object X is its rationality index γ , this is a number in \mathbb{Q}_0^+ (see 11.1). Usually, the object X belongs to a tube which has rank 6. In case X belongs to a tube \mathcal{C} with rank 2 or 3 (this happens only for $\gamma = 0$ and 1), we write γ_r with $r \in \{2, 3\}$ in order to indicate that \mathcal{C} has rationality index γ and rank r . Note that the pickets and bipickets labeled 0 are those which belong to $\mathcal{P}(6)$, the remaining pickets and bipickets belong to stable tubes. Altogether we see: *There are 14 Auslander-Reiten components in $\mathcal{S}(6)$ which contain pickets or bipickets, namely the tubes of rank 6, 3, 2 with rationality index 0 or 1, and the tubes of rank 6 with rationality index*

$$\frac{1}{4}, \frac{1}{3}, \frac{1}{2}, \frac{2}{3}, \frac{3}{2}, 2, 3, 4.$$

Most pickets and bipickets which occur in stable tubes have quasi-length 1, the only exception are the bipickets in the tube of rank 6 and rationality index 1/1 which have quasi-length 2. The pickets and bipickets in $\mathcal{P}(n)$ have quasi-length at most 4.

The tubes with rank 6, 3, 2 and rationality index 0 have been presented in detail in [RS1], for the remaining tubes containing pickets or bipickets, see [S2].

Remark. *There are bipickets in $\mathcal{S}(6)$ with $p = r$ which are not self-dual, namely the bipickets $X = ([4], [6, 2], [3, 1])$ and $D X = ([3, 1], [6, 2], [4])$ (which are dual to each other).*

In contrast, for $n \leq 5$, all indecomposable objects X with $p = r$ (equivalently, with $u = w$) are self-dual. Namely, according to [RS1], 6.5, all but one indecomposable objects in $\mathcal{S}(5)$ with $u = w$ are pickets or bipickets. The exception is of course self-dual. Pickets with $u = w$ are self-dual. And a bipicket X in $\mathcal{S}(5)$ satisfies $q \leq 4$, thus if $u = v$, then X belongs to the fundamental region \mathbb{F} of $\mathbb{T}(6)$ presented above: the 5 bipickets of this kind are all self-dual.

(f) The tetrapickets on the triangle $\Delta_{5/4}$:

All tetrapickets in $\mathcal{S}(6)$ occur inside the hexagon pictured below, each on an intersection point of dotted lines (thus, both pr-coordinates are integer multiples of $\frac{1}{4}$). In Section 15.2 (d) we have already pictured the three tetrapickets on the boundary of Δ_1 .

Here we show the tetrapickets on the boundary of $\Delta_{5/4}$, their positions are as indicated. There are no other objects on the boundary of $\Delta_{5/4}$, and the only objects outside $\Delta_{5/4}$ are the pickets on Δ_0 and the objects on Δ_1 shown in Section 15.2, (a)–(d).

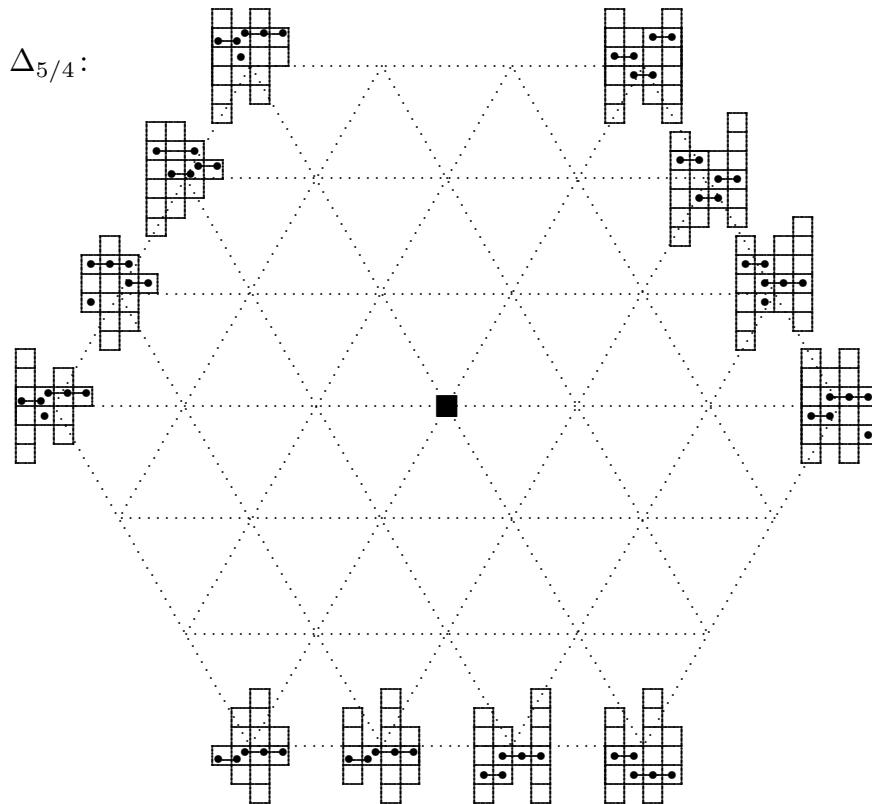
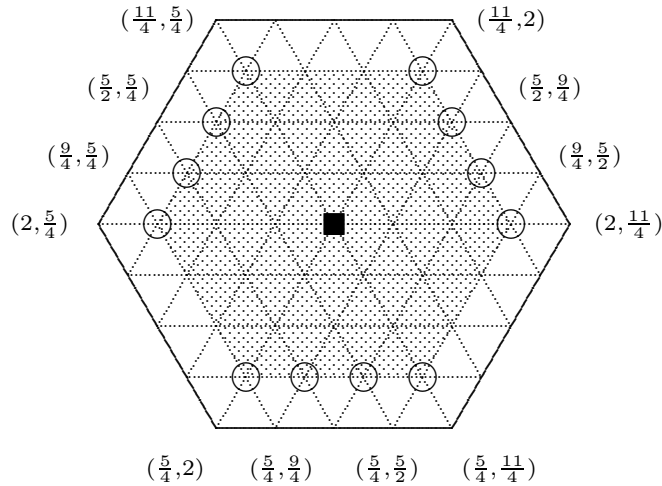

The objects in position $(\frac{5}{4}, 2)$ and its rotations have quasi-length 2 in the 6-tube with rationality index 3; those in position $(\frac{5}{4}, \frac{9}{4})$ and its rotations on the mouth of the 6-tube with rationality index $\frac{5}{3}$; the modules at $(\frac{5}{4}, \frac{5}{2})$ and its rotations on the mouth of the 6-tube with rationality index $\frac{3}{5}$; and the objects at $(\frac{5}{4}, \frac{11}{4})$ and its rotations have quasi-length 2 in the 6-tube with rationality index $\frac{1}{3}$.

(g) The line $p = 1$ for $\mathcal{S}(6)$:

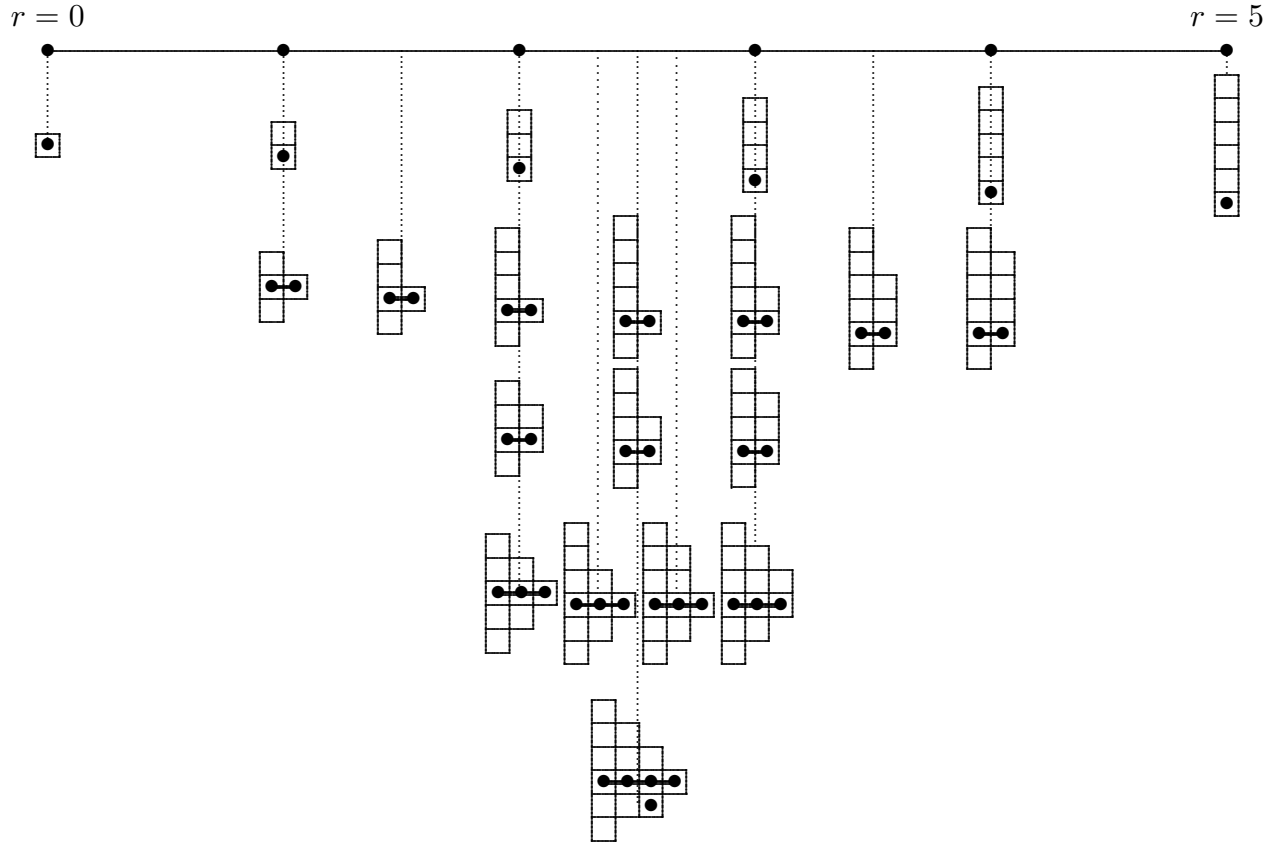

15.3. Objects in \mathcal{S} with $q < 4$.

(a) Indecomposable objects in \mathcal{S} with $2 < qX < 3$:

Here are the known indecomposable objects X with $2 < qX < 3$. They have $qX = \frac{5}{2}$:

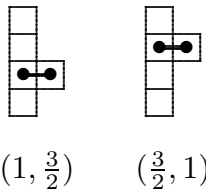

(b) The indecomposable objects X in $\mathcal{S}(6)$ with $qX = 3$.

There are fifteen indecomposable objects X with $qX = 3$.

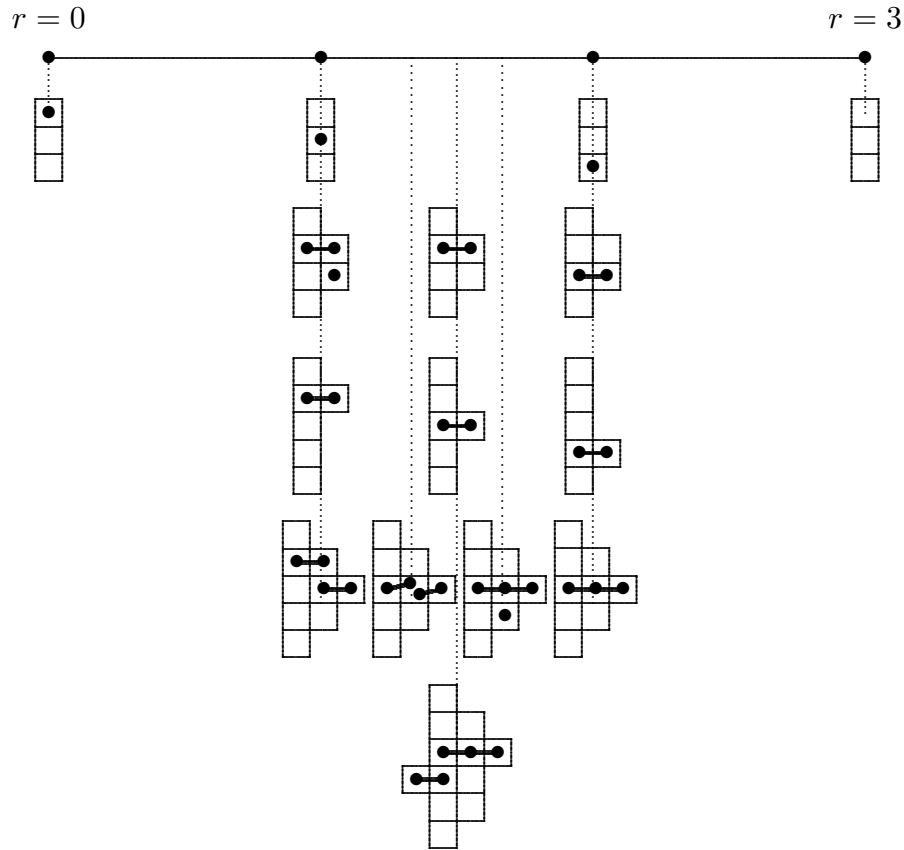

(c) Indecomposable objects in $\mathcal{S}(9)$ with $q < 4$.

It is easy to modify some indecomposable objects in $\mathcal{S}(6)$ with mean strictly smaller than 4, in order to obtain objects X in $\mathcal{S}(n)$ with $n = 7, 8, 9$ which still satisfy the condition $qX < 4$. Here are some objects X in $\mathcal{S}(9)$ with $vX = 15$ and $bX = 4$, thus $qX = 15/4 < 4$; they are obvious modifications of the object $Y = S[6]$ in $\mathcal{S}(6)$.

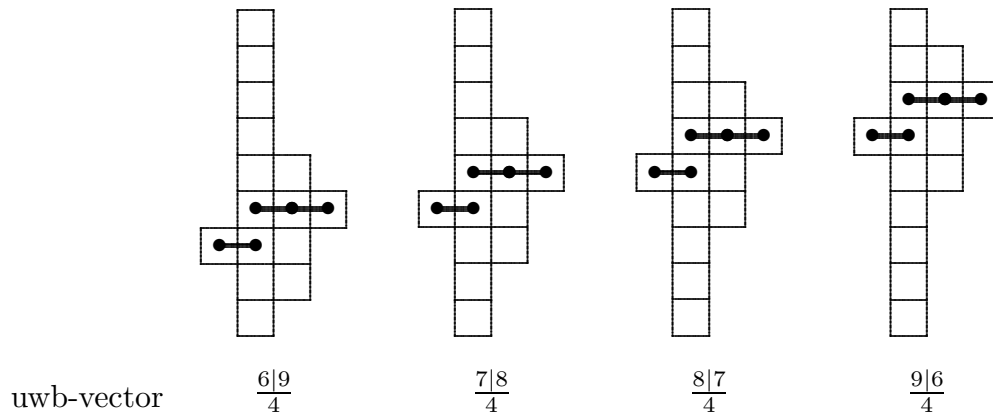

These objects have non-trivial extensions with Y . Here are indecomposable objects in

$\mathcal{S}(9)$ which occur in this way (using the first of the four objects presented above):

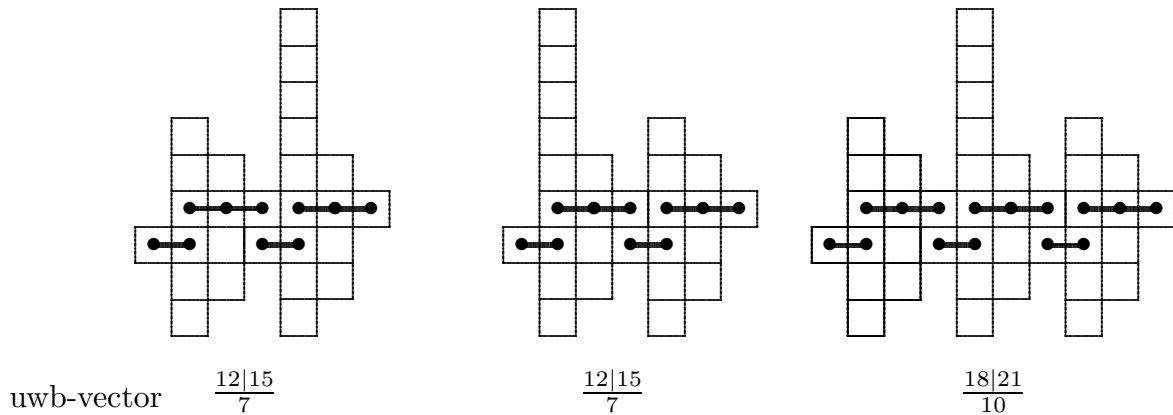

Using induction, we can construct indecomposable objects in $\mathcal{S}(9)$ with uwb-vector of the form $\frac{6t|6t+3}{3t+1}$ for any $t \geq 1$, thus with mean $(12t + 3)/(3t + 1) < 4$. Of course, the sequence of the corresponding pr-vectors converges to $(2, 2)$. For $t = 1, 2, 3$, we may start with the following objects:

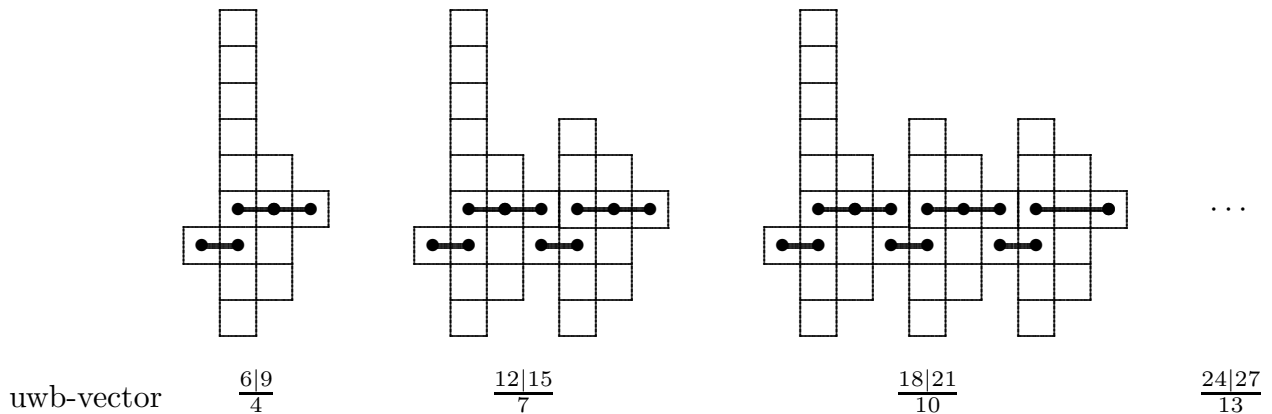

16. Questions.

We will formulate a lot of open questions, the reader will observe that at present there are more questions than results. In case we consider pr-vectors (p, r) in $\mathbb{T}(n)$, we write $q = p + r$.

16.1. First question: Finite pr-vectors.

Let us call a pr-vector (p, r) *n-finite* provided there are only finitely many indecomposable objects in $\mathcal{S}(n)$ with pr-vector (p, r) , and *finite*, provided (p, r) is *n-finite* for all $n \in \mathbb{N}$.

According to Theorem 1, we know that all pr-vectors (p, r) with $p < 1$ or $r < 1$ are finite. According to Theorem 2, also the pr-vector $(1, 1)$ is finite. The first question to be

mentioned is: *Which additional pr-vectors are finite?* We expect that many, may-be all vectors (p, r) with $q < 4$ are finite.

16.2. Second: Indecomposable objects X with $qX < 4$.

(1) Let X be indecomposable with $qX < 3$. Is X in $\mathcal{S}(4)$, thus a picket or a bipicket?

(2) Let X be indecomposable with $qX = 3$. Is X in $\mathcal{S}(6)$, thus $bX \leq 4$?

The 15 indecomposable objects X in $\mathcal{S}(6)$ with $qX = 3$ are exhibited in 15.3 (c).

(3) Is there an indecomposable object X in \mathcal{S} with $3 < qX < \frac{16}{5}$?

In (B.6) we present two pentapickets, each satisfies $qX = \frac{16}{5}$.

(4) Is the height of the indecomposable objects X with $qX < 4$ bounded? Or, at least: Let $\epsilon > 0$. Is the height of the indecomposable objects X with $qX \leq 4 - \epsilon$ bounded?

(5) Is there a BTh-vector with $q < 4$?

(6) The region $p \geq 1, r \geq 1, q < 4$ is of great interest. Can one determine the values q for indecomposable objects in this region? Does there exist an accumulation point different from 4 ?

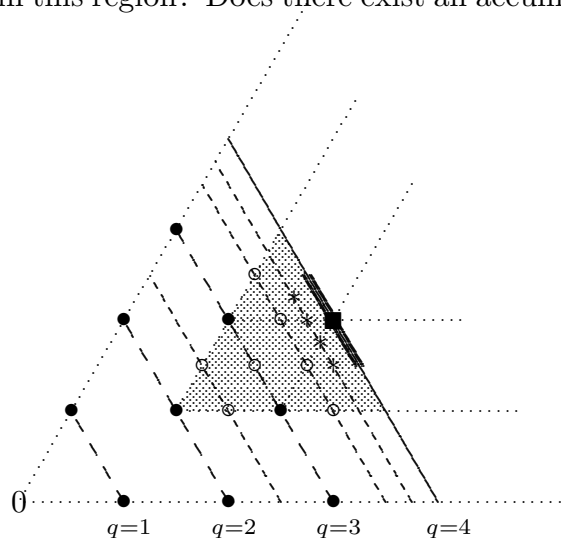

Here, the dashed lines show the pr-vectors with constant mean q , equal to 1, 2, $5/2$, 3, $7/2$, and $15/4$. The four stars $*$ on the line $q = 15/4$ indicate the position of the four indecomposables with mean equal to $15/4$ which have been exhibited at the beginning of 15.3(c). (Of course, there are also indecomposables with $q = 9/3, 10/3$, and $11/3$, see 15.2(c) as well as Appendix B.)

16.3. What is the role of the line $3p + r = 7$?

Question. Are there BTh-vectors in the triangle with corners $(1, 1), (2, 1)$, and $(1, 4)$?

Here is the triangle. The four marked points represent BTh-families discussed in this paper. See (8.1) for the family in $\mathcal{S}(7)$ with uwb-vector $\frac{6|10}{4}$. The family in $\mathcal{S}_3(7)$ with uwb-vector $\frac{7|14}{5}$ is presented in (8.2). In (8.3) we exhibit the family in $\mathcal{S}(8)$ with uwb-vector $\frac{6|17}{5}$. The last point marks the position of the family in $\mathcal{S}(9)$ of uwb-vector $\frac{6|24}{6}$ from (7.4).

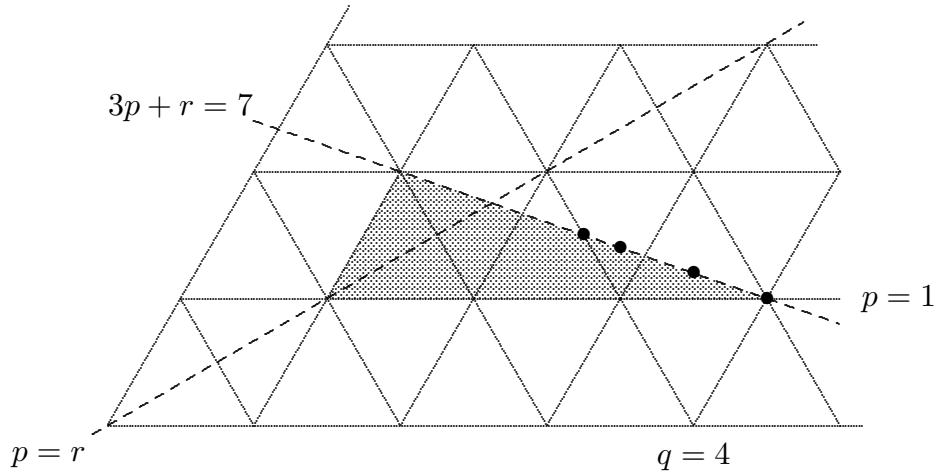

16.4. Terra Incognita.

Many questions concern the convex closure of the pr-vectors $(1, 1)$, $(1, 4)$, $(2, 4)$, $(2, 2)$,

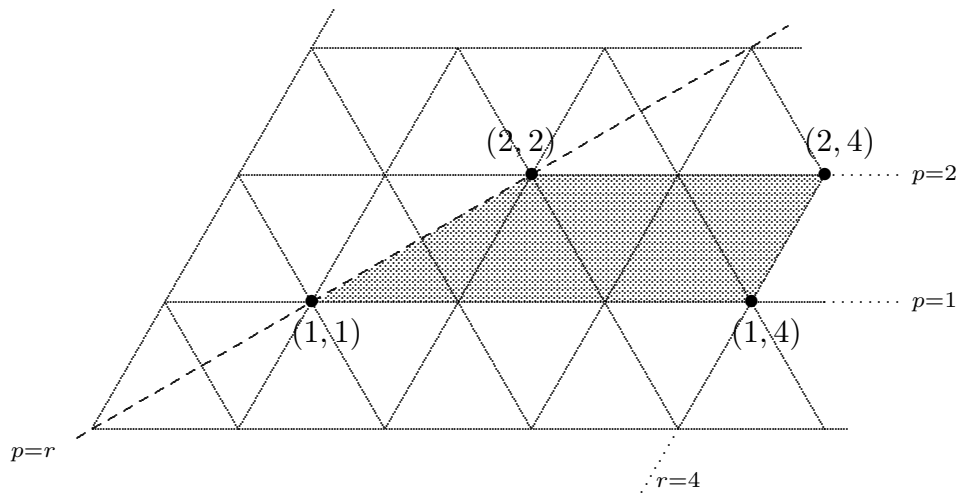

Note that the corner $(2, 2)$ is the pr-vector of the standard family in $\mathcal{S}(6)$, whereas the corner $(1, 4)$ is the pr-vector of the family in $\mathcal{S}(9)$ with $p = 1$.

A pr-vector with boundary distance at least 1 either lies, up to the symmetries, in this trapezoid, or else it is known to be a BTh-vector, see Theorems 4 and 10.

16.5. The set of BTh-vectors.

One of the main aims of the present paper concerns the existence of BTh-vectors. There are many questions. As we have mentioned already: Is there a BTh-vector with $q < 4$? Is there a BTh-vector with $3p + r < 7$? Further questions:

- (1) Is there a BTh-vector for $\mathcal{S}(8)$ with $p = 1$? (There is one for $\mathcal{S}(9)$.)
- (2) For any n , is the region of all BTh-vectors for $\mathcal{S}(n)$ convex in $\mathbb{T}(n) \cap \mathbb{Q}^2$?

(3) Is the region of all BTh-vectors for $\mathcal{S}(n)$ even the convex hull of the BTh-vectors exhibited in Sections 6, 7, 8? Here are the cases $n = 7, 8, 9, 10, 15$. The dark region is the convex hull in question.

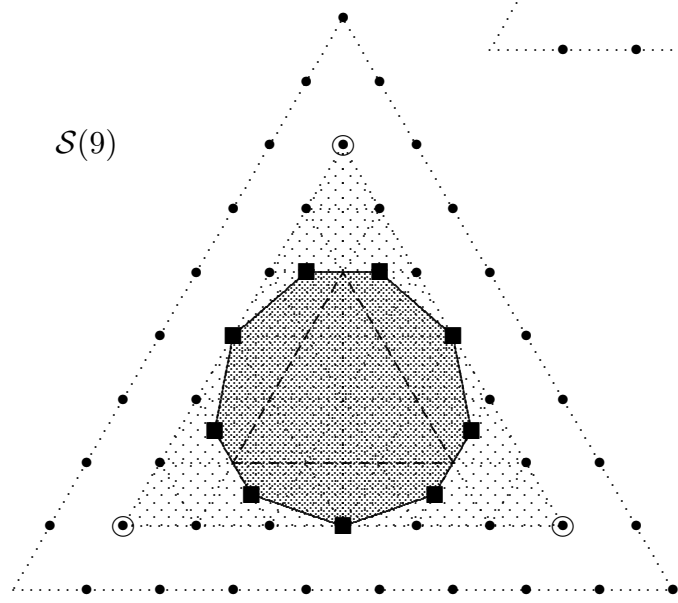
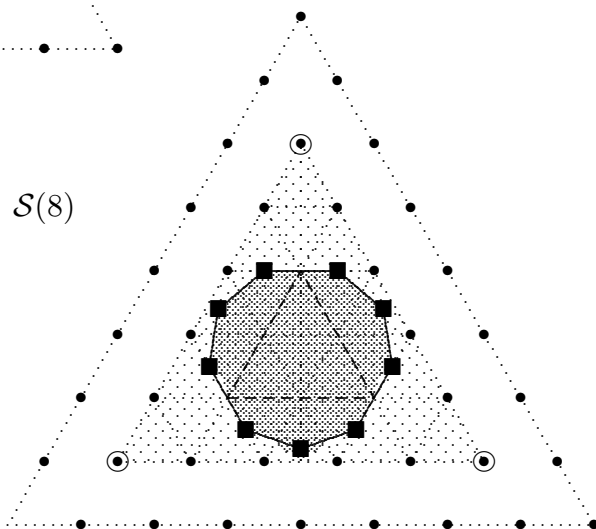
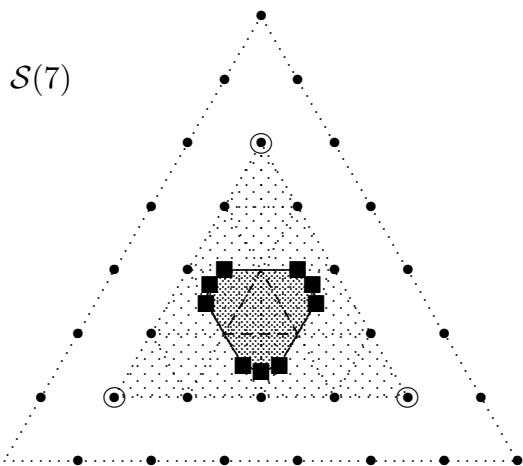

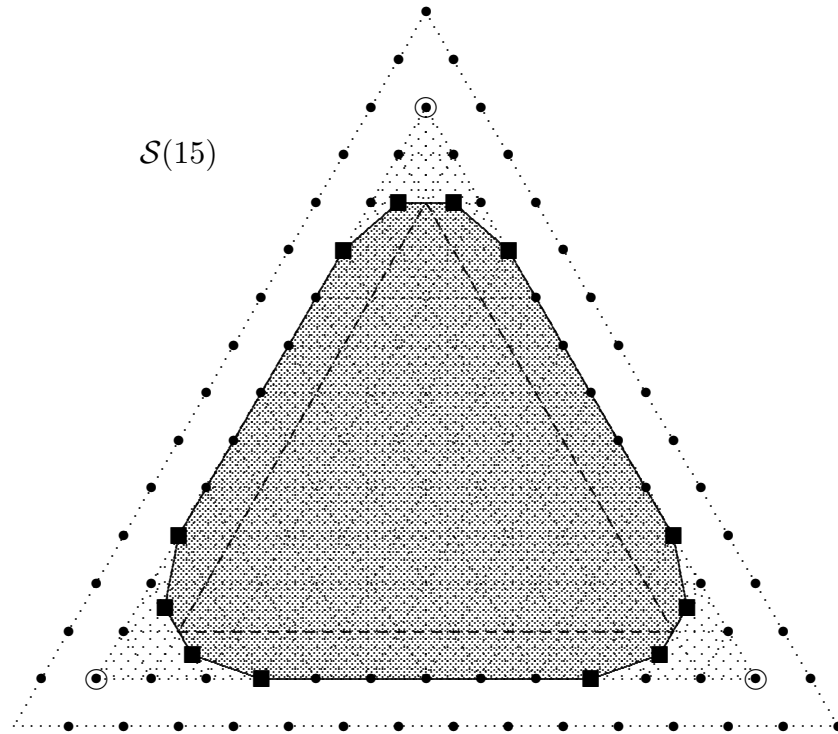
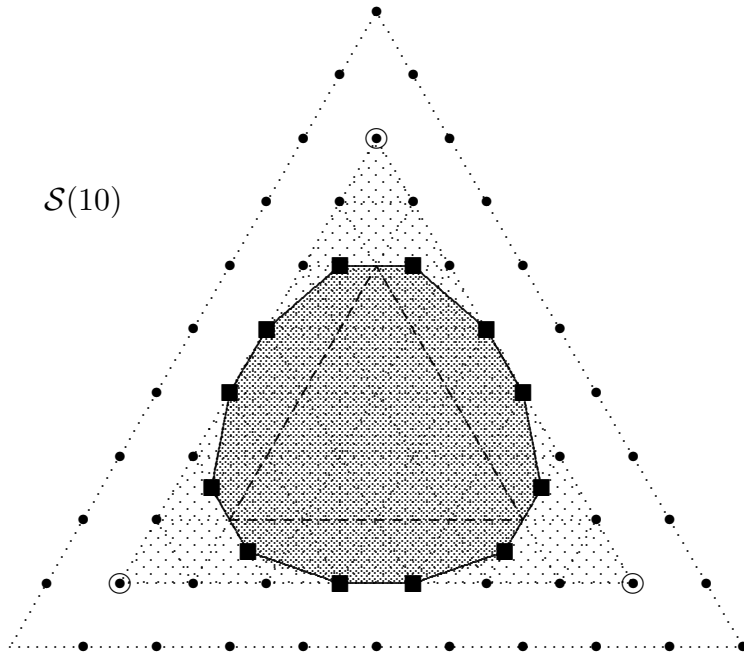

16.6. Tame and wild.

Starting from a tame family, using expansion we get a wild family. But this increases the collevel r .

(1) Is there a wild family with $q \leq 4$?

(2) Is there a wild family with pr-vector $(7/5, 14/5)$?

(3) What can we say about the region of rational points in $\mathbb{T}(n)$ which support wild families?

16.7. Infinite-dimensional objects.

In this paper (but also in earlier ones) we have restricted the attention to finite-dimensional vector spaces. But it is of interest (also for applications) to deal with arbitrary vector spaces. Thus, in general, the setting should be expanded as follows: one should look at pairs (U, V) , where V is an arbitrary, not necessarily finite dimensional, vector space with a locally nilpotent operator, and U is an invariant subspace of V , thus (U, V) is a direct limit of objects in \mathcal{S} .

16.8. The case $n = 6$.

Looking at [RS1] and Section 11 of the present paper, one may be inclined to believe that the case $n = 6$ is now well established. But this is definitely not the case. As usually, such a boundary case between finite and wild type is of special interest, since one hopes that it sheds light on the general behaviour. Here are some questions.

(1) Is there a formula (or at least a reasonable estimate) for the number of indecomposable objects in $\mathcal{S}(6)$ with fixed pr-vector? In which way do these numbers increase in the direction towards the center? Of course, it is sufficient to consider the central half-lines in $\mathbb{T}(6)$ which pass through one of the five vertices $(0, 0)$, $(0, 1)$, $(0, 2)$, $(0, 8/3)$, and $(0, 3)$.

(2) For any $t \geq 1$, what is the support of the indecomposable objects X with fixed width $bX = t$?

(3) The reference space $\mathbb{T}(6)$ does not provide any clue on central objects: they just vanish in the center $(2, 2)$ (thus, we call it the black hole). What is the structure of the full subcategory of central objects?

(4) Are there central objects in $\mathcal{S}(6)$ which are at the boundary of a 6-tube or a 3-tube?

(5) The reference space $\mathbb{T}(6)$ seems to provide not much information about the rationality index of the objects in $\mathcal{S}(6)$. In which way can one combine the combinatorial information provided by $\mathbb{T}(6)$ with the information provided by the rationality index?

17. Final comments.

17.1. The mystery of boundary distance 1.

Let us draw the attention to the dichotomy between $p < 1$ and $p \geq 1$; and similarly between $q \leq n - 1$ and $q > n - 1$.

We have seen in the paper: On the one hand, there do exist (for $n \geq 9$) infinite families of indecomposable objects X in $\mathcal{S}(n)$ with $qX = n - 1$. On the other hand, there are no non-trivial indecomposable objects Y in $\mathcal{S}(n)$ with $n - 1 < qY$ (non-trivial means: $bY \geq 2$).

Thus, starting with $X = (U, V)$, it is impossible to make a proper enlargement $V \subseteq V'$ and $U \subseteq U'$ in $\mathcal{S}(n)$ with $bV = bV'$ and keeping indecomposability ...

In contrast, look at the family X_c with covering modules $\begin{smallmatrix} 2 & 1 \\ 1 & 2 & 3 & 3 & 2 & 1 \end{smallmatrix}$, such that the map $3 \leftarrow 3$ is an isomorphism. There is a (unique) indecomposable object Y with covering $\begin{smallmatrix} 2 & 2 \\ 1 & 2 & 3 & 3 & 2 & 1 \end{smallmatrix}$, and such that any X_c is a submodule of Y . Thus, here we deal with a situation that starting with $X = (U, V)$, we can enlarge U to U' (inside V) and $Y = (U', V)$ is still indecomposable.

There are also examples of families $X = (U, V)$ where we enlarge just V , not U : Start with $V = [7, 4, 2]$ and $U = [4, 2]$ and enlarge V to $V' = [7, 5, 2]$... But as we have shown this cannot happen in case $qX = n - 1$.

17.2. The plus-construction. The plus-construction defined in Section 9.1 focuses the attention for $n \geq 6$ to an important property of the category $\mathcal{S}(n)$: it provides for any indecomposable object X an arithmetical sequence of indecomposable objects which describes a move towards the center of $\mathbb{T}(n)$. We may call this a process of concentration or amplification: There is the path $X \rightarrow X^+ \rightarrow X^{+2} \rightarrow \dots$ along a ray which has to be seen as a sequence of amplifications of X and of moves towards the center.

But there is also the dual feature of decentration or shrinking: Namely, using duality, the sectional path $X \rightarrow X^+$ yields a corresponding sectional path $D(X^+) \rightarrow DX$, and actually we have $D(X^+) = (DX)^+$: thus for any indecomposable object Y there is an arithmetical sequence of indecomposable objects which moves away from the center of $\mathbb{T}(n)$ and shows a shrinking of the objects: this concerns the path $\dots \rightarrow Y^{+2} \rightarrow Y^+ \rightarrow Y$ along a coray.

As we have seen in Section 10, there is a difference between the stable components and the principal component $\mathcal{P}(n)$: If we deal with a stable component \mathcal{C} , the arithmetical sequence defined by an object X say supported by the half-line H gives rise to a corresponding arithmetical sequence defined again by an object of \mathcal{C} but now supported by the complementary half-line H' of H . Thus, we observe an oscillation behaviour on the central line $H \cup H'$. In contrast, for the principal component $\mathcal{P}(n)$, there are half-lines which occur in the half-line support in $\mathcal{P}(n)$, where the complementary half-line does not play a role.

Altogether, we should have the following picture in mind: There are the half-lines $\mathbb{H}_\ell(n)$, and for $n \geq 7$ also the half-lines $\mathbb{K}_s(n)$ which support the concentration or amplification along rays inside $\mathcal{P}(n)$, then, inside the stable components, we observe the oscillation on complementary half-lines, and finally we look again at the principal component with its arithmetical sequences in corays, moving away from the center of $\mathbb{T}(n)$, as a sign of decentration or shrinking.

This picture has some similarity to the flow in the categories $\text{mod } K(m)$ with $m \geq 2$, where we start in the preprojective component and end in the preinjective component, passing in-between through the regular components. The regular components are of tree class \mathbf{A}_∞ , and we always use first a coray (which means decrease), then a ray (which means increase). Of course, the fact that $\mathcal{S}(n)$ is a Frobenius category (where projective objects and injective objects coincide) explains that the exceptional behaviour of dealing with half-lines without complements is not devoted to two components (as in the case of $\text{mod } K(m)$), a preprojective and a preinjective one, but to the single principle component

which contains the indecomposable projective-injective objects. All components of $\mathcal{S}(n)$ with $n \geq 6$ are of tree type \mathbf{A}_∞ ; and clearly, the principal component combines features of a preprojective and a preinjective component. We are convinced that the categories $\text{mod } K(m)$ and $\mathcal{S}(n)$ are basic examples in representation theory and their similarities should be kept in mind.

17.3. Combinatorics versus algebra. As a summary, we want to stress that the target of our investigations is to single out settings which are purely combinatorial.

Dealing with finite-dimensional representations of a k -algebra, the invariants which have to be described may or may not refer to the number of elements of the ground field k or to properties of k . Invariants which do not refer to k may be said to be *combinatorial* invariants; the remaining ones we will call *algebraic* invariants.

The algebraic invariants which we encounter usually refer just to the cardinality of k , sometimes also to the algebraic closure of k , but it seems that more information about the structure of k , about its characteristic or about completeness properties never play a role.

In order to facilitate the reading (say even for undergraduate students), we avoid the use of field extensions. In particular, the projective line \mathbb{P}^1 over k is defined just as the set of its rational points. We hope that the more advanced reader has no problem to invoke also the non-rational points ...

The combinatorics which we encounter leads first of all to formulae which involve binomial coefficients as well as Fibonacci numbers. It should not come as a surprise that also the exceptional root systems, in particular the root system \mathbf{E}_8 , play a prominent role. After all, we have seen already in [RS1] and [S1] in which way the root systems known from Lie theory come into play.

Our detailed study of the case $n = 6$ in [RS1] as well as in the present paper relies on the conviction that this tame border case between finite and wild type may be crucial for a general understanding of the categories $\mathcal{S}(n)$. But is this conviction justified? We do not know! One should be aware of the fact that the categories $\mathcal{S}(n)$ form what is called an even **ADE** chain, see for example [Bi]: The categories $\mathcal{S}(1), \mathcal{S}(2), \mathcal{S}(3), \mathcal{S}(4), \mathcal{S}(5)$ are of tree type $\mathbf{A}_0, \mathbf{A}_2, \mathbf{D}_4, \mathbf{E}_6, \mathbf{E}_8$, respectively, the category $\mathcal{S}(6)$ is of tubular type $(6, 3, 2)$. One may expect that the extension of this chain to the wild cases may shed some light on the structure of the categories $\mathcal{S}(n)$ with $n \geq 7$.

17.4. The category $\mathcal{S}(6)$ and the root system \mathbf{E}_8 . Our detailed study of the category $\mathcal{S}(6)$ in [RS1] and in Section 11 of the present paper relies on the relationship between $\mathcal{S}(6)$ and the module category of the tubular algebra Θ , and this furnishes a relationship between $\mathcal{S}(6)$ and the root system \mathbf{E}_8 .

We need to distinguish between the objects of $\mathcal{S}(6)$ living in stable tubes and those belonging to $\mathcal{P}(6)$. The objects in $\mathcal{P}(6)$ are known explicitly, thus one can check any question directly. It is decisive to understand the objects which live in stable tubes. For every indecomposable object X which lives in a stable tube, we have attached the element $\mathbf{r}(X)$ which is a root of χ_Ξ or the zero vector. Note that the roots of χ_Ξ form a root system of type \mathbf{E}_8 .

This approach to distinguish between the objects of $\mathcal{S}(6)$ living in stable tubes and those belonging to $\mathcal{P}(6)$, has been used four times in our investigations. In [RS1], we have

discussed in this way the relationship between u and v , Theorem 7 deals in the same way with the relationship between u and b . Then there is Theorem 8 which focuses the attention first to the 12 support lines and second to the nested sequence of standard triangles which support the category. To repeat: we always had to distinguish between the objects of $\mathcal{S}(6)$ living in stable tubes and those belonging to $\mathcal{P}(6)$. For an object X in a stable component, we used properties of $\mathbf{r}(X)$, and we could refer to the table provided in Appendix A. (Let us stress that we have used this appendix only for dealing with objects of $\mathcal{S}(6)$ which belong to stable tubes). As we know, the remaining objects in $\mathcal{P}(6)$ can be described very well, and we have checked the required properties directly.

Let us insert a short remark, concerning the separation of $\mathcal{S}(6)$ into $\mathcal{P}(6)$ and the stable tubes: It is fascinating to see that $\mathcal{S}(6)$ can be reconstructed by starting from the stable tubes of $\text{mod } k\Theta$, identifying the stable tubes in \mathcal{T}_0 and in \mathcal{T}_∞ , and then adding the principal component $\mathcal{P}(6)$. Note that the identified categories \mathcal{T}_0 and \mathcal{T}_∞ together with $\mathcal{P}(6)$ yield the objects with rationality index 0. Looking at the function \mathbf{r} defined for all objects in stable tubes of $\mathcal{S}(6)$, it would be proper to attach to an object X which belongs to a stable tube with rationality index 0 not just the one element $\mathbf{r}(X)$, but the **pair** $\{\mathbf{r}(X), \mathbf{r}'(X)\}$, where $\mathbf{r}'(X)$ is obtained from $\mathbf{r}(X)$ by shifting the coefficients one step to the right.

As we have mentioned, we have used known properties of the tubular algebra Θ in order to get information about $\mathcal{S}(6)$. But conversely, our investigation of $\mathcal{S}(6)$ may provide a new insight into $\text{mod } k\Theta$, and this could be helpful for a better understanding of the module categories of tubular algebras. It seems that the relevance of the 12 central lines in $\mathbb{T}(6)$ which we encounter when dealing with $\mathcal{S}(6)$, but which are of similar interest for $\text{mod } k\Theta$, was not yet noticed for $k\Theta$. For any tubular algebra, there should exist a corresponding set of planar lines which deserves to be investigated.

17.5. The spider web for $n = 6$. Theorem 8 presents two essential features for the case $n = 6$, namely the 12 lines and the nested sequence of standard triangles which provide the support of $\mathcal{S}(6)$. There cannot be any doubt about the importance of the 12 lines. However, there may be questions about the relevance of the triangles. Instead of the triangles one may also look at costandard triangles or at a corresponding nested sequence of hexagons. Actually, the authors had numerous discussions which point of view should be preferable. Of course, the triangles (the standard and the costandard ones) as well as the hexagons, all these shapes are definitely of interest, but for simplicity, we wanted to focus the first attention to a single shape.

In order to be precise: the *hexagons* H_d which play a role are given as the boundary of the convex hull of the Σ_3 -orbit of a vertex of the form $(d, 2)$, where $1 \leq d < 2$ (it is a subset of the union of the standard triangle Δ_d and the costandard triangle ∇_{4-d}). The configuration given by the 12 lines $\mathbb{L}(6)$ and the hexagons H_d which support indecomposable objects in $\mathcal{S}(6)$ seems to look like an impressive spider web.

The first hexagon H_1 has been featured prominently at the end of 1.8. Here, all the vertices on H_1 which belong to one of the 12 lines support indecomposable objects of $\mathcal{S}(6)$. But this is no longer true for some of the further hexagons H_d which occur.

Next, one should look at the hexagon $H_{5/4}$. as shown in 15.2 (f) and B.5. Here we encounter a missing symmetry with respect to the reflection $(p, r) \mapsto (4 - p, p + r - 2)$:

there is a unique indecomposable object in $\mathcal{S}(6)$ supported by $(9/4, 5/4)$, but there are two indecomposable objects supported by $(7/4, 6/4)$. Similarly, looking at $H_{4/3}$, B.2 shows that the number of tripickets with support $(5/3, 5/3)$ is 2, whereas the number of tripickets with support $(7/3, 4/3)$ is 3. Obviously, one has to be aware that not all symmetries of the hexagon are realised in our setting.

In-between H_1 and $H_{5/4}$, a further hexagon is needed, namely $H_{6/5}$ in order to accommodate the 6 pentapickets exhibited in B.6, for example the two pentapickets with pr-vector $(8/5, 8/5)$. But note that only three vertices of this hexagon $H_{6/5}$ support indecomposable objects of $\mathcal{S}(6)$, namely the corners of $\Delta_{8/5}$. This may be a hint that the use of the standard triangles is more appropriate than that of the hexagons.

We finally decided to stress the relevance of the standard triangles Δ_d and to postpone a study of the hexagons for later investigations.

Some hexagons H_d (with $d = 1, \frac{6}{5}, \frac{5}{4}, \frac{4}{3}, \frac{7}{5}, \frac{10}{7}, \frac{3}{2}$), and the position of the indecomposables on H_d with $d = 1, \frac{6}{5}, \frac{5}{4}$:

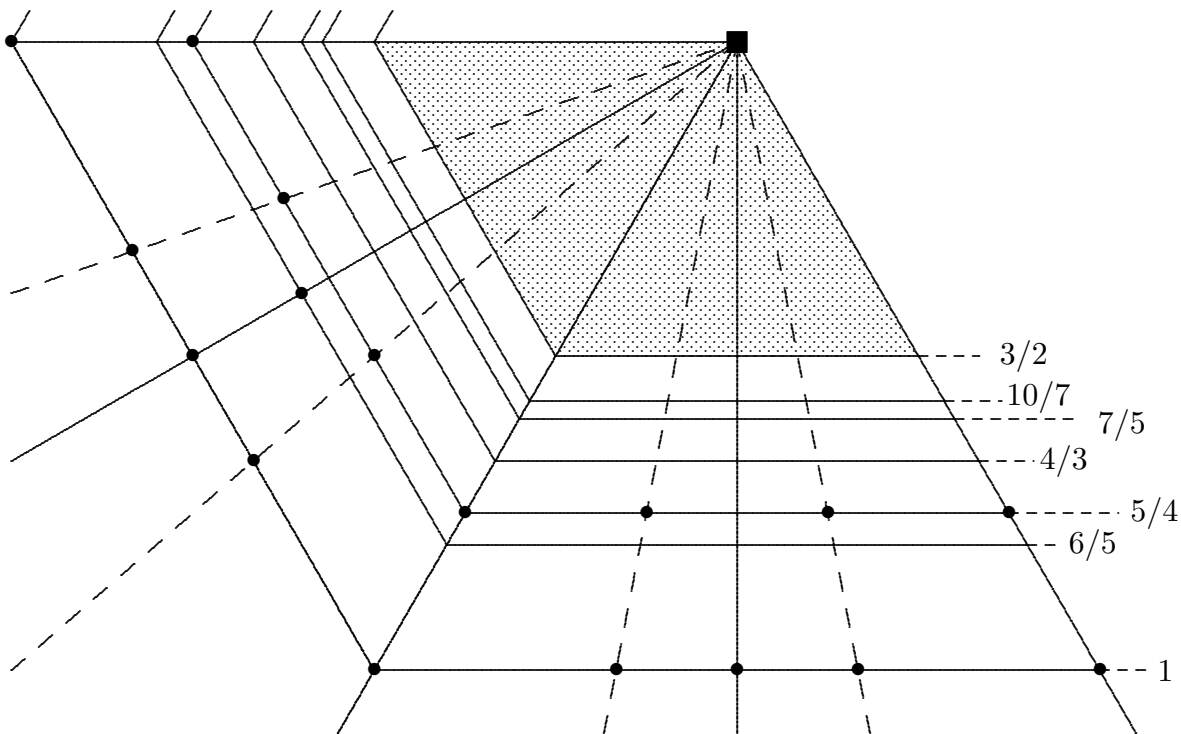

Following the discussion in 17.4, the spider web of $\mathcal{S}(6)$ should be seen as a kind of shadow of the root system of χ_Θ . It should be possible to draw similar spider webs also for tubular algebras.

17.6. The triangle $\mathbb{T}(n)$. The title of the paper refers to three invariants: level p , mean q and colevel r , as well as to the use of these numbers by invoking the triangle $\mathbb{T}(n)$. Our visualization of $\mathbb{T}(n)$ focuses the attention to the level: level 0 is the horizontal basis of the triangle, the increase of the level corresponds to going upwards in the triangle. However, in this way the important duality functor D is not seen well, being the reflexion at an inclined line.

This flaw could be remedied by a rotation of $\mathbb{T}(n)$: by drawing the origin $(0,0)$ of the triangle at the bottom, so that going upwards corresponds to an increase of q , see the following picture on the left. Then the duality D is seen well as the reflection through the central vertical line.

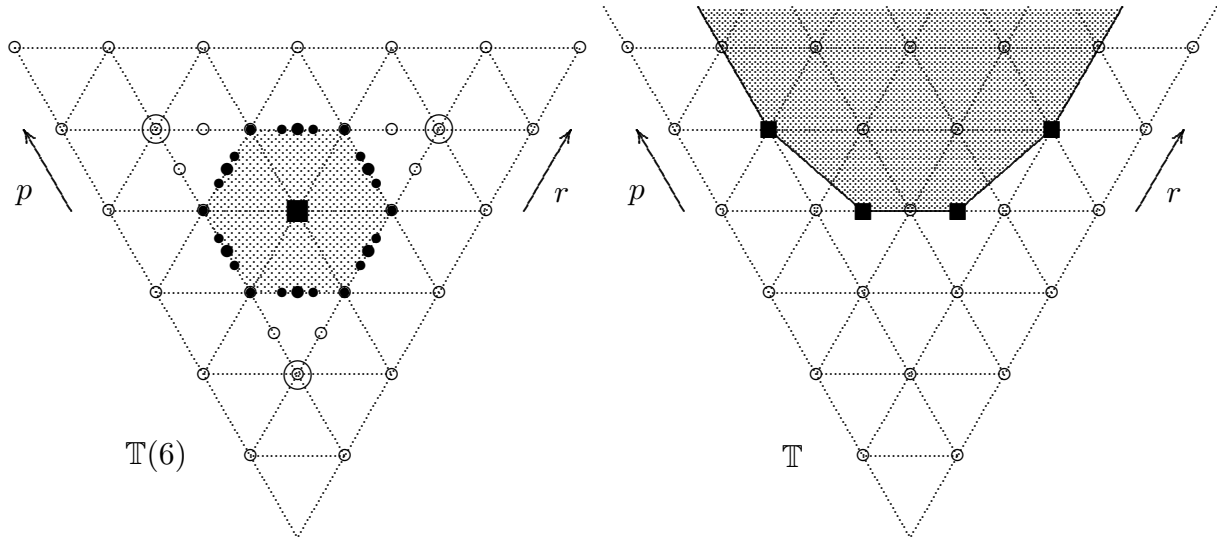

The rotated triangles $\mathbb{T}(n)$ seem to be of special interest when looking at the whole category $\mathcal{S} = \bigcup_n \mathcal{S}(n)$ and the corresponding (now infinite) triangle $\mathbb{T} = \bigcup_n \mathbb{T}(n)$. On the right, we have drawn part of the rotated triangle \mathbb{T} , with the region of suspected BTh-vectors.

17.7. The rotation of $\mathbb{T}(n)$. Whatever optical presentation of $\mathbb{T}(n)$ the reader prefers (to stress $p = 0$ as the basis of $\mathbb{T}(n)$ as usually done in the paper, or else to use the cone version with vertical increase of the mean, as mentioned in 17.6), it is the rotation by 120° which really is the outstanding feature of the reference space $\mathbb{T}(n)$. This surprising rotation was discovered by Schmidmeier a long time ago, it has been the fundament of our description of the Auslander-Reiten translation [RS2] and now has led us to introduce the set $\mathbb{E}(n)$, see Section 3.1. As we have mentioned, it is a main ingredient for nearly all the results of the present paper. A look at the hexagon pictures in Section 15 and in Appendix B shows that this hidden symmetry relates objects which on a first view seem to be really different. Clearly, the rotation should be helpful also for any further investigation of $\mathcal{S}(n)$.

There is the following surprising observation: *if X is a reduced object of $\mathcal{S}(n)$, then $pX = n - q(\tau_n^2 X)$.* Why is this relationship between p and q so astonishing? Whereas for the calculation of pX , one needs to know both the global space VX and the subspace UX , the value of qY only depends on the global space VY . Namely, we have $pX = uX/bX = |U|/bV$, but $qX = vX/bX = |V|/bV$. Looking at the triangle $\mathbb{T}(n)$, there are the three barycentric coordinates p, r, ω , with $\omega = n - p - q$ and the existence of the rotation $\rho = \tau^2$ shows that the three coordinates are on an equal footing, in sharp contrast to an intuitive interpretation of the invariants p and r on the one hand, and q on the other.

18. References.

Essential References (needed for proofs and providing illustrations).

- [ARS] M. Auslander, I. Reiten, S.O. Smalø. Representation Theory of Artin Algebras. Cambridge studies in advanced mathematics 36. Cambridge 1995.
- [AS] M. Auslander, S. O. Smalø. *Almost split sequences in subcategories*, J. Algebra **69** (1981), 426–454.
- [DLS] P. Dowbor, H. Lenzing, A. Skowronski. *Galois coverings by algebras of locally support-finite categories*, in: Representation Theory I, Proc. Conf. Ottawa (1984), 91–93.
- [R1] C. M. Ringel, *Representations of K -species and bimodules*, J. Algebra **41** (1976), 269–302.
- [R2] C. M. Ringel, *Tame Algebras and Integral Quadratic Forms*, Springer Lect. Notes Math. **1099** (1984).
- [R3] C. M. Ringel, *Covering Theory*, Izmir Lectures (2014), 1–8. Reprinted (slightly revised) as Appendix D below.
- [RS1] C. M. Ringel, M. Schmidmeier, *Invariant subspaces of nilpotent linear operators. I*, J. reine angew. Math. **614** (2008), 1–52.
- [RS2] C. M. Ringel, M. Schmidmeier, *The Auslander-Reiten translation in submodule categories*, Trans. Amer. Math. Soc. **360** (2008), 691–716.
- [S1] M. Schmidmeier, *Bounded submodules of modules*, J. Pure Appl. Alg. **203** (2005), 45–82.
- [S2] M. Schmidmeier, *Invariant subspaces of nilpotent linear operators. II*, in preparation.
- [S3] M. Schmidmeier, *Systems of submodules and an isomorphism problem for Auslander-Reiten quivers*. Bull. Belg. Math. Soc. Simon Stevin **15** (2008), 523–546

Additional references (history, relevance).

- [Bi] Birep. *The ADE chain workshop*. <https://www.math.uni-bielefeld.de/~sek/ADE/>, aufgerufen am 11.05.2024.
- [Bh] G. Birkhoff, *Subgroups of abelian groups*, Proc. Lond. Math. Soc. (II) **38** (1934), 385–401.
- [Bob] G. Bobinski, *Algebras with irreducible module varieties III: Birkhoff varieties*, International Mathematics Research Notices, Vol. 2021, No. 4, pp. 2497–2525.
- [GKKP] N. Gao, J. Külshammer, S. Kvamme, Ch. Psaroudakis. *A functorial approach to monomorphism categories II: Indecomposables*, (2023), 46pp., arXiv:2303.07753
- [Kap] I. Kaplansky, *Infinite Abelian Groups*, Ann Arbor, 1954.
- [Kva] S. Kvamme, *An introduction to monomorphism categories*, manuscript (2023), 42pp.
- [KSS] J. Kosakowska, M. Schmidmeier, M. Schreiner, *Abelian p -groups with a p -bounded factor or a p -bounded subgroup*. arXiv:2312.01451.
- [P] H. Prüfer, *Untersuchungen über die Zerlegbarkeit der abzählbaren primären Abelschen Gruppen*, Math. Z. **17** (1923), 35–61.
- [Z] Interview mit G. M. Ziegler. In *Ein Moment für Mensch und Mathematik*. Hrg. C. Cederbaum, Ph. von Homeyer. Freiburg im Breisgau (2007). 102–111.

Appendix A. The roots of \mathbf{E}_8 .

Markus Schmidmeier

In the root table (A.1), we list for each positive root of \mathbf{E}_8 some data which describe the corresponding representations of the algebra Θ in (11.1). Some examples are given in (A.2).

A.1. The root table.

Consider the following two quivers, Q_Ξ , which is a restriction of Q_Θ in (11.1), and Q_H , which is the quiver of a path algebra of type \mathbf{E}_8 .

$$\begin{array}{ccc}
 Q_\Xi: & \begin{array}{c} 2' \xleftarrow{\alpha} 3' \\ \downarrow \quad \downarrow \beta \\ 1 \leftarrow 2 \leftarrow 3 \leftarrow 4 \leftarrow 5 \leftarrow 6 \end{array} & Q_H: \begin{array}{c} 2' \\ \gamma \downarrow \\ 1 \leftarrow 2 \leftarrow 3 \xleftarrow{\delta} 3 \leftarrow 4 \leftarrow 5 \leftarrow 6 \end{array}
 \end{array}$$

The indecomposable representations M for Ξ for which the map $(M_\alpha, M_\beta)^t : M_{3'} \rightarrow M_{2'} \oplus M_3$ is injective are in one-to-one correspondence to the indecomposable representations N for H for which the map $(N_\gamma, N_\delta) : N_{2'} \oplus N_3 \rightarrow N_{\bar{3}}$ is surjective. To see this, form the pushout of the commutative square. All indecomposable representations for Ξ are obtained from roots for \mathbf{E}_8 , for the indecomposable representations of Θ see (11.1).

In the table we list for each of the 120 positive roots of \mathbf{E}_8 :

- (1) The number of the root as listed on [W].
- (2) The root for \mathbf{E}_8 . For roots 5, 13, and 20, the corresponding map (N_γ, N_δ) is not onto.
- (3) The corresponding root for χ_Ξ . The roots for 5, 13, and 20 are mixed roots for χ_Ξ , we abbreviate “-1” by “-”. (Note that given an indecomposable module M in \mathcal{D} , the root $\mathbf{r}(M)$ of χ_Ξ does not have to be positive, but may be negative or mixed. Of course, the negative of a mixed root is again mixed.)
- (4) For a root \mathbf{r} for χ_Ξ , the formal uwb-vector:

$$u = \mathbf{r}_1 + \mathbf{r}_{2'} + \mathbf{r}_{3'}, \quad w = \sum_{i=1}^6 \mathbf{r}_i - u, \quad b = \mathbf{r}_3$$

- (5) The slope ϕ of the corresponding central half-line, presented in the following format:

$$\frac{u - 2b}{w - 2b} = \phi$$

- (6) For non-central objects, the type of the corresponding central half-line.

\mathbb{P} : The half-line is parallel to one of the coordinate axes: The lines $p = 2$, $r = 2$, $6 - q = 2$ have slope 0, ∞ , and -1 respectively.

- \mathbb{D} : The diagonal lines $p = r$, $r = 6 - q$, $p = 6 - q$ have slope $1, -2, -\frac{1}{2}$ respectively.
 \mathbb{H} : The object lies on a central half-line in $\mathbb{H}(6)$, its slope is $\frac{1}{2}, 2, -3, -\frac{3}{2}, -\frac{2}{3}$ or $-\frac{1}{3}$
 c : The object is central.

The symbols \mathbb{D} and \mathbb{H} carry a subscript, s or ℓ , depending on whether objects corresponding to the root occur on the short or the long half-line of the central line. In this case, and also when the symbol is \mathbb{P} , the negative root will give rise to objects on the opposite side of the same central line.

(7) Two numbers r_Δ, r_∇ , defined as follows.

$$r_\Delta = \max\{2b - u, v - 4b, 2b - w\} \quad \text{and} \quad r_\nabla = \max\{u - 2b, 4b - v, w - 2b\}$$

are computed from the formal uwb -vector in column (4).

Suppose $X \in \mathcal{S}(n)$ occurs in a stable tube and has (positive) root $\mathbf{r} = \mathbf{r}(X)$. We can compute

- the in-radius of the standard (Δ -)triangle through $\mathbf{pr} X$ as $\frac{r_\Delta}{bX}$;
- the boundary distance as $dX = 2 - \frac{r_\Delta}{bX}$, so $\mathbf{pr} X$ lies on Δ_{dX} ;
- the in-radius of the costandard (∇ -)triangle as $\frac{r_\nabla}{bX}$ (so $\mathbf{pr} X$ occurs on $\nabla_{2+r_\nabla/bX}$, using notation from 10.7);
- the primitive pair as $(u, b) = (2bX - r_\Delta, bX)$ (using notation from 11.8).
- and the in-radius of the hexagon as $r_H(X) = \frac{\max\{r_\Delta, r_\nabla\}}{bX}$ (so $\mathbf{pr} X$ lies on $H_{2-r_H(X)}$, see 17.4).

If X occurs in a stable tube and has (negative) root $\mathbf{r}(X) = -\mathbf{r}$, the five above quantities are computed as $\frac{r_\nabla}{bX}$ (in-radius of the standard triangle), $dX = 2 - \frac{r_\nabla}{bX}$ (boundary distance), $\frac{r_\Delta}{bX}$ (in-radius of the costandard triangle), $(2bX - r_\nabla, bX)$ (primitive pair), and $r_H(X)$ (in-radius of the hexagon), respectively.

Table of roots of \mathbf{E}_8 and χ_{Ξ} — Roots 61 to 120

61	$\frac{1}{11211111}$	$\frac{10}{1111111}$	$\frac{2 4}{1}$	$\frac{0}{2} = 0$	\mathbb{P}	2, 2	91	$\frac{2}{1232221}$	$\frac{21}{122221}$	$\frac{4 6}{2}$	$\frac{0}{2} = 0$	\mathbb{P}	2, 2
62	$\frac{1}{12211110}$	$\frac{10}{1211110}$	$\frac{2 4}{1}$	$\frac{0}{2} = 0$	\mathbb{P}	2, 2	92	$\frac{2}{1243210}$	$\frac{21}{123210}$	$\frac{4 5}{3}$	$\frac{-2}{-1} = 2$	\mathbb{H}_ℓ	2, 3
63	$\frac{1}{12211111}$	$\frac{10}{1211111}$	$\frac{2 5}{1}$	$\frac{0}{3} = 0$	\mathbb{P}	3, 3	93	$\frac{1}{1233321}$	$\frac{11}{123321}$	$\frac{3 9}{3}$	$\frac{-3}{3} = -1$	\mathbb{P}	3, 3
64	$\frac{1}{0122211}$	$\frac{11}{012211}$	$\frac{2 5}{2}$	$\frac{-2}{1} = -2$	\mathbb{D}_s	2, 1	94	$\frac{2}{1243211}$	$\frac{21}{123211}$	$\frac{4 6}{3}$	$\frac{-2}{0} = \infty$	\mathbb{P}	2, 2
65	$\frac{1}{1122111}$	$\frac{11}{112111}$	$\frac{3 4}{2}$	$\frac{-1}{0} = \infty$	\mathbb{P}	1, 1	95	$\frac{2}{1233221}$	$\frac{22}{123221}$	$\frac{5 6}{3}$	$\frac{-1}{0} = \infty$	\mathbb{P}	1, 1
66	$\frac{1}{1222110}$	$\frac{11}{122110}$	$\frac{3 4}{2}$	$\frac{-1}{0} = \infty$	\mathbb{P}	1, 1	96	$\frac{2}{1343210}$	$\frac{21}{133210}$	$\frac{4 6}{3}$	$\frac{-2}{0} = \infty$	\mathbb{P}	2, 2
67	$\frac{1}{1122210}$	$\frac{11}{112210}$	$\frac{3 4}{2}$	$\frac{-1}{0} = \infty$	\mathbb{P}	1, 1	97	$\frac{2}{1233321}$	$\frac{22}{123321}$	$\frac{5 7}{3}$	$\frac{-1}{1} = -1$	\mathbb{P}	1, 1
68	$\frac{1}{1232100}$	$\frac{10}{122100}$	$\frac{2 4}{2}$	$\frac{-2}{0} = \infty$	\mathbb{P}	2, 2	98	$\frac{2}{1243221}$	$\frac{21}{123221}$	$\frac{4 7}{3}$	$\frac{-2}{1} = -2$	\mathbb{D}_s	2, 1
69	$\frac{1}{0122221}$	$\frac{11}{012221}$	$\frac{2 6}{2}$	$\frac{-2}{2} = -1$	\mathbb{P}	2, 2	99	$\frac{2}{1343211}$	$\frac{21}{133211}$	$\frac{4 7}{3}$	$\frac{-2}{1} = -2$	\mathbb{D}_s	2, 1
70	$\frac{1}{1232110}$	$\frac{10}{122110}$	$\frac{2 5}{2}$	$\frac{-2}{1} = -2$	\mathbb{D}_s	2, 1	100	$\frac{2}{2343210}$	$\frac{21}{233210}$	$\frac{5 6}{3}$	$\frac{-1}{0} = \infty$	\mathbb{P}	1, 1
71	$\frac{1}{1122211}$	$\frac{11}{112211}$	$\frac{3 5}{2}$	$\frac{-1}{1} = -1$	\mathbb{P}	1, 1	101	$\frac{2}{1343221}$	$\frac{21}{133221}$	$\frac{4 8}{3}$	$\frac{-2}{2} = -1$	\mathbb{P}	2, 2
72	$\frac{1}{1222210}$	$\frac{11}{122210}$	$\frac{3 5}{2}$	$\frac{-1}{1} = -1$	\mathbb{P}	1, 1	102	$\frac{2}{1243321}$	$\frac{21}{123321}$	$\frac{4 8}{3}$	$\frac{-2}{2} = -1$	\mathbb{P}	2, 2
73	$\frac{1}{1222111}$	$\frac{11}{122111}$	$\frac{3 5}{2}$	$\frac{-1}{1} = -1$	\mathbb{P}	1, 1	103	$\frac{2}{2343211}$	$\frac{21}{233211}$	$\frac{5 7}{3}$	$\frac{-1}{1} = -1$	\mathbb{P}	1, 1
74	$\frac{2}{1232100}$	$\frac{21}{122100}$	$\frac{4 2}{2}$	$\frac{0}{-2} = 0$	\mathbb{P}	2, 2	104	$\frac{2}{1244321}$	$\frac{22}{124321}$	$\frac{5 8}{4}$	$\frac{-3}{0} = \infty$	\mathbb{P}	3, 3
75	$\frac{1}{1222211}$	$\frac{11}{122211}$	$\frac{3 6}{2}$	$\frac{-1}{2} = -\frac{1}{2}$	\mathbb{D}_ℓ	1, 2	105	$\frac{2}{1343321}$	$\frac{21}{133321}$	$\frac{4 9}{3}$	$\frac{-2}{3} = -\frac{2}{3}$	\mathbb{H}_ℓ	2, 3
76	$\frac{1}{1232111}$	$\frac{10}{122111}$	$\frac{2 6}{2}$	$\frac{-2}{2} = -1$	\mathbb{P}	2, 2	106	$\frac{2}{2343221}$	$\frac{21}{233221}$	$\frac{5 8}{3}$	$\frac{-1}{2} = -\frac{1}{2}$	\mathbb{D}_ℓ	1, 2
77	$\frac{1}{1122221}$	$\frac{11}{112221}$	$\frac{3 6}{2}$	$\frac{-1}{2} = -\frac{1}{2}$	\mathbb{D}_ℓ	1, 2	107	$\frac{2}{2343321}$	$\frac{21}{233321}$	$\frac{5 9}{3}$	$\frac{-1}{3} = -\frac{1}{3}$	\mathbb{H}_ℓ	2, 3
78	$\frac{1}{1232210}$	$\frac{10}{122210}$	$\frac{2 6}{2}$	$\frac{-2}{2} = -1$	\mathbb{P}	2, 2	108	$\frac{2}{1344321}$	$\frac{22}{134321}$	$\frac{5 9}{4}$	$\frac{-3}{1} = -3$	\mathbb{H}_s	3, 2
79	$\frac{2}{1232110}$	$\frac{21}{122110}$	$\frac{4 3}{2}$	$\frac{0}{-1} = 0$	\mathbb{P}	1, 1	109	$\frac{2}{2344321}$	$\frac{22}{234321}$	$\frac{6 9}{4}$	$\frac{-2}{1} = -2$	\mathbb{D}_s	2, 1
80	$\frac{1}{1233210}$	$\frac{11}{123210}$	$\frac{3 6}{3}$	$\frac{-3}{0} = \infty$	\mathbb{P}	3, 3	110	$\frac{2}{1354321}$	$\frac{21}{134321}$	$\frac{4 10}{4}$	$\frac{-4}{2} = -2$	\mathbb{D}_s	4, 2
81	$\frac{1}{1222221}$	$\frac{11}{122221}$	$\frac{3 7}{2}$	$\frac{-1}{3} = -\frac{1}{3}$	\mathbb{H}_ℓ	2, 3	111	$\frac{3}{1354321}$	$\frac{32}{134321}$	$\frac{6 8}{4}$	$\frac{-2}{0} = \infty$	\mathbb{P}	2, 2
82	$\frac{2}{1232210}$	$\frac{21}{122210}$	$\frac{4 4}{2}$	$\frac{0}{0}$	ND	c	112	$\frac{2}{2354321}$	$\frac{21}{234321}$	$\frac{5 10}{4}$	$\frac{-3}{2} = -\frac{3}{2}$	\mathbb{H}_s	3, 2
83	$\frac{1}{1232211}$	$\frac{10}{122211}$	$\frac{2 7}{2}$	$\frac{-2}{3} = -\frac{2}{3}$	\mathbb{H}_ℓ	2, 3	113	$\frac{2}{2454321}$	$\frac{21}{244321}$	$\frac{5 11}{4}$	$\frac{-3}{3} = -1$	\mathbb{P}	3, 3
84	$\frac{2}{1232111}$	$\frac{21}{122111}$	$\frac{4 4}{2}$	$\frac{0}{0}$	ND	c	114	$\frac{3}{2354321}$	$\frac{32}{234321}$	$\frac{7 8}{4}$	$\frac{-1}{0} = \infty$	\mathbb{P}	1, 1
85	$\frac{2}{1233210}$	$\frac{22}{123210}$	$\frac{5 4}{3}$	$\frac{-1}{-2} = \frac{1}{2}$	\mathbb{H}_ℓ	2, 3	115	$\frac{3}{2454321}$	$\frac{32}{244321}$	$\frac{7 9}{4}$	$\frac{-1}{1} = -1$	\mathbb{P}	1, 1
86	$\frac{1}{1233211}$	$\frac{11}{123211}$	$\frac{3 7}{3}$	$\frac{-3}{1} = -3$	\mathbb{H}_s	3, 2	116	$\frac{3}{2464321}$	$\frac{31}{244321}$	$\frac{6 10}{4}$	$\frac{-2}{2} = -1$	\mathbb{P}	2, 2
87	$\frac{1}{1232221}$	$\frac{10}{122221}$	$\frac{2 8}{2}$	$\frac{-2}{4} = -\frac{1}{2}$	\mathbb{D}_ℓ	2, 4	117	$\frac{3}{2465321}$	$\frac{32}{245321}$	$\frac{7 10}{5}$	$\frac{-3}{0} = \infty$	\mathbb{P}	3, 3
88	$\frac{2}{1232211}$	$\frac{21}{122211}$	$\frac{4 5}{2}$	$\frac{0}{1} = 0$	\mathbb{P}	1, 1	118	$\frac{3}{2465421}$	$\frac{32}{245421}$	$\frac{7 11}{5}$	$\frac{-3}{1} = -3$	\mathbb{H}_s	3, 2
89	$\frac{1}{1233221}$	$\frac{11}{123221}$	$\frac{3 8}{3}$	$\frac{-3}{2} = -\frac{3}{2}$	\mathbb{H}_s	3, 2	119	$\frac{3}{2465431}$	$\frac{32}{245431}$	$\frac{7 12}{5}$	$\frac{-3}{2} = -\frac{3}{2}$	\mathbb{H}_s	3, 2
90	$\frac{2}{1233211}$	$\frac{22}{123211}$	$\frac{5 5}{3}$	$\frac{-1}{-1} = 1$	\mathbb{D}_ℓ	1, 2	120	$\frac{3}{2465432}$	$\frac{32}{245432}$	$\frac{7 13}{5}$	$\frac{-3}{3} = -1$	\mathbb{P}	3, 3

A.2. Some special roots.

(a) **The object E_2^2 as an example.** Consider the row corresponding to root \mathbf{r}_{47} in the table:

$$47 \quad 0122100 \quad 0121100 \quad \frac{2|2}{2} \quad \frac{-2}{-2} = 1 \quad \mathbb{D}_\ell \quad 2, 4$$

The entry after the root number is the corresponding root of \mathbf{E}_8 , then the dimension vector \mathbf{r}_{47} of the object $M \in \mathcal{D}$ with $\pi M = E_2^2$, and the uwv-vector $\frac{2|2}{2}$. In $\mathbb{T}(6)$, the object E_2^2 can be found on the diagonal line with slope $\frac{-2}{-2} = 1$, on the long half line of a central line of type \mathbb{D} . The central distance is given by the in-radius $\frac{r_\Delta}{bE_2^2} = \frac{2}{2} = 1$ of the standard triangle (so the boundary distance is $dE_2^2 = 2 - \frac{r_\Delta}{bE_2^2} = 1$) and the in-radius $\frac{r_\nabla}{bE_2^2} = \frac{4}{2} = 2$ of the costandard triangle (so E_2^2 occurs on ∇_4). Finally, the corresponding primitive pair is $(2bE_2^2 - r_\Delta, bE_2^2) = (2, 2)$.

The root given by dimension vector $\mathbf{h}_0 + \mathbf{r}_{47}$ corresponds to an object X of width $3 + 2 = 5$ (a pentapicket), it occurs on the same half-line in $\mathbb{T}(6)$, but the central distances are given by the in-radii $\frac{r_\Delta}{bX} = \frac{2}{5}$ and $\frac{r_\nabla}{bX} = \frac{4}{5}$ of the standard and costandard triangles, respectively. Hence the boundary distance is $2 - \frac{2}{5} = \frac{8}{5}$, and the object has primitive pair $(8, 5)$.

The smallest realization M of a corresponding negative root $-\mathbf{r}_{47}$ within \mathcal{D} has dimension vector $\mathbf{h}_0 + \mathbf{h}_\infty - \mathbf{r}_{47}$; we abbreviate $\mathbf{h}_0 + \mathbf{h}_\infty$ as \mathbf{h}_1 . (Note that the vectors $\mathbf{h}_0 - \mathbf{r}_{47}$ and $\mathbf{h}_\infty - \mathbf{r}_{47}$ do not have their largest entry in position 3, hence cannot be realized by objects in \mathcal{D} , see Lemma 11.2.) The object $X = \pi M \in \mathcal{S}(6)$ occurs on the short half line of the same central line; since $bX = \dim M_3 = 6 - 2 = 4$, X is a tetrapicket, its central distance is given by the in-radius $\frac{r_\nabla}{bX} = \frac{4}{4}$ of the standard triangle and the in-radius $\frac{r_\Delta}{bX} = \frac{2}{4}$ of the costandard triangle. As the root is negative, the boundary distance is obtained as $dX = 2 - \frac{r_\nabla}{bX} = 2 - \frac{4}{4} = 1$ and the primitive pair as $(4, 4)$.

(b) **The objects on the costandard triangle ∇_5 .** The vertices next to the corners of the triangle $\mathbb{T}(6)$ support objects of quasi-length 1 in the principal component. All six objects can be realized by roots of χ_Θ , they have been pictured in the introduction in (15.2) and are listed in the order in which they occur on their τ -orbit.

$$\begin{array}{cccccc} S = (0, [1]) & ([1], [1]) & ([1], [6]) & (0, [5]) & ([5], [5]) & ([5], [6]) \\ \mathbf{r}_{12} & \mathbf{r}_4 & \mathbf{r}_{45} & \mathbf{r}_{38} & \mathbf{h}_1 - \mathbf{r}_{119} & \mathbf{h}_1 - \mathbf{r}_{118} \end{array}$$

By adding to each root either \mathbf{h}_0 or \mathbf{h}_∞ we obtain the dimension vectors of the 12 tetrapickets pictured in (Appendix B.5).

(c) **The bipickets in the corners of Δ_1 .** The three bipickets occur in the 6-tube of rationality index $\frac{1}{1}$, each is given by a root. We have already considered E_2^2 in (a).

$$\begin{array}{ccc} E_2^2 = ([2], [3, 1]) & ([2], [6, 4]) & ([5, 3], [6, 4], [2]) \\ \mathbf{r}_{47} & \mathbf{r}_{87} & \mathbf{h}_1 - \mathbf{r}_{110} \end{array}$$

For each of those three roots \mathbf{r} , the root $\mathbf{h}_1 - \mathbf{r}$ defines the tetrapicket on Δ_1 , on the lines $q = 5$, $r = 1$ and $p = 1$, respectively. They are pictured in (15.2 (d)).

Moreover, the roots of the form $\mathbf{h}_0 + \mathbf{r}$ and $\mathbf{h}_\infty + \mathbf{r}$ define the six pentapickets on the vertices of $\Delta_{8/5}$, see (Appendix B.6).

(d) **The six bipickets on the costandard triangle $\nabla_{7/2}$.** The objects, which lie on the lines $q = \frac{5}{2}, r = \frac{7}{2}$ and $p = \frac{7}{2}$, respectively, are listed in the counterclockwise order in which they occur around the center of $\mathbb{T}(6)$.

$$E_2^3 = \begin{matrix} ([2], [4, 1]) & ([2], [6, 3]) & ([3], [6, 4]) & ([5, 2], [6, 4], [3]) & ([5, 2], [6, 3], [2]) & ([3], [4, 1]) \\ \mathbf{r}_{52} & \mathbf{r}_{83} & \mathbf{r}_{81} & \mathbf{h}_1 - \mathbf{r}_{108} & \mathbf{h}_1 - \mathbf{r}_{112} & \mathbf{r}_{56} \end{matrix}$$

The objects are pictured at the beginning of (15.2).

(e) **The 18 tripickets on the hexagon.** We specify the roots of the 18 tripickets on the boundary of the hexagon in $\mathcal{S}(6)$, as presented in (15.2 (c)).

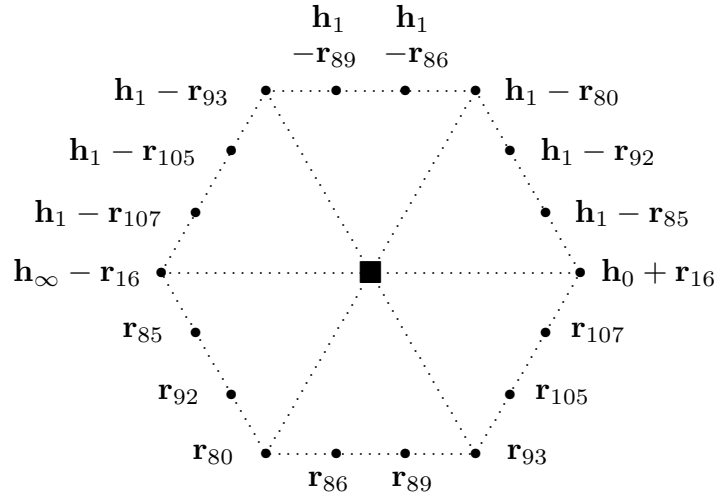

(f) **Some objects which are not roots.** In the principal component $\mathcal{P}(6)$, some objects cannot be realized by roots or radical vectors of χ_Θ . Those include the projective module $P' = ([6], [6])$: If $P' = \pi M$ for some object $M \in \tilde{\mathcal{S}}(6)$ then $\dim M_{i'} = 1$ for six consecutive integers i , which is not possible for any root of χ_Θ . Similarly, the projective module $P = (0, [6])$: Assume $P = \pi M$ with $\mathbf{dim} M$ a root of χ_Θ , then either $M_1 = 0$ or else $M_{1'} \neq 0$ and neither is possible. Also, $P[4] = ([5, 2], [6, 6, 2], [5, 2])$ cannot be realized since any $M \in \tilde{\mathcal{S}}(6)$ with $P[4] = \pi M$ has support on an interval of length 8.

Additional reference for Appendix A.

[W] Wikipedia article on \mathbf{E}_8 (2023-10-15), [https://en.wikipedia.org/wiki/E8_\(mathematics\)](https://en.wikipedia.org/wiki/E8_(mathematics))

Appendix B. The tripickets in $\mathcal{S}(6)$ and some tetrapickets and some pentapickets

Markus Schmidmeier

B.1. Overview.

All tripickets occur inside or on the boundary of the hexagon of $\mathcal{S}(6)$. In 15.2 (c), we have already determined the 18 tripickets on the boundary.

The remaining tripickets reside inside the hexagon. Several tripickets will share their position. For the 57 non-central objects in the interior of the hexagon, we indicate this multiplicity.

Finally, there are the central objects. There are 3 objects in $\mathcal{P}(6)$, 5 in the stable non-homogeneous tubes of index 0, and one on the mouth of each homogeneous tube of index 0.

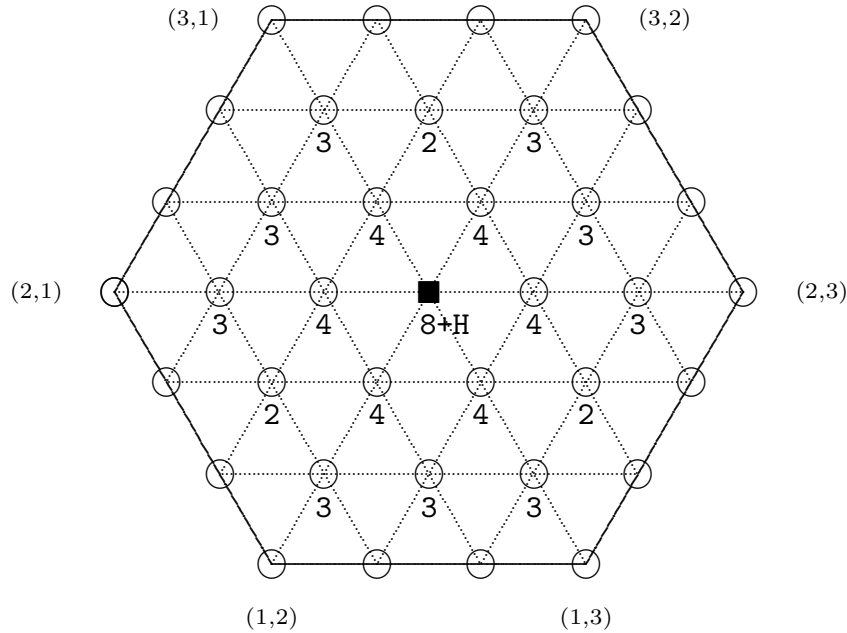

In (B.2), we picture the non-central objects on the diagonal lines (15). In (B.3), we deal with the non-central tripickets on $\Delta_{4/3}$ which lie on a central line parallel to one of the axes (18). In (B.4), we present the non-central tripickets in $\Delta_{5/3}$ which lie on a central line parallel to one of the axes (24).

In this appendix, we also exhibit some additional tetrapickets, in addition to those on the boundary of the hexagon in (15.2 (d)) and on the triangle $\Delta_{5/4}$ in (15.2 (f)). The tetrapickets on the triangle $\Delta_{5/3}$ and on the lines $q = \frac{13}{4}$, $p = \frac{11}{4}$ and $r = \frac{11}{4}$ are presented in (B.5). Finally, in (B.6) we picture some pentapickets inside but close to the boundary of the hexagon.

Here, we list the non-homogeneous central tripickets from [RS1, (2.3)] (8), the homogeneous ones are pictured in (2.7), Remark 1.

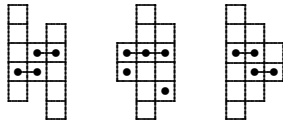

tripickets
in $\mathcal{P}(6)$
(quasi-length 6)

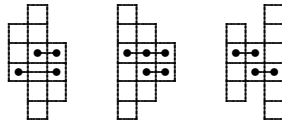

tripickets in 3-tube
of index 0
(quasi-length 3)

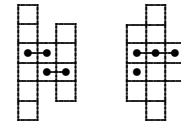

tripickets in 2-tube
of index 0
(quasi-length 2)

B.2. The non-central tripickets on the diagonal lines.

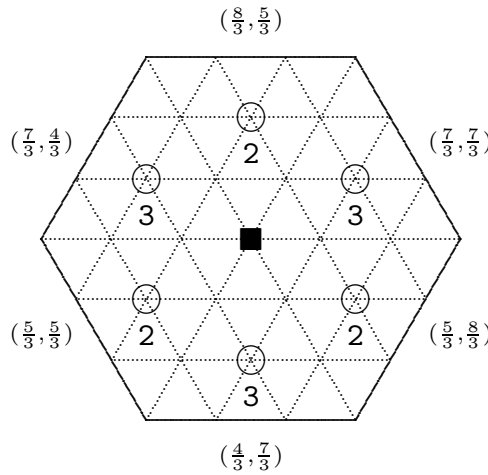

The objects pictured on the left (the right) have quasi-length 2 in the 6-tube of index $\frac{1}{2}$ (of index $\frac{2}{1}$); the middle object in the bottom row (and its rotations) occur in the principal component $\mathcal{P}(6)$ with quasi-length 4.

Note that there are 3 orbits of objects under the action of the symmetry group Σ_3 : One orbit consists of the six objects on the long central half lines \mathbb{D}_ℓ , the second has six objects (the orbits under rotation of the outer objects pictured at the bottom) on the short central half lines \mathbb{D}_s , while the third orbit contains only three objects on half lines of type \mathbb{D}_s .

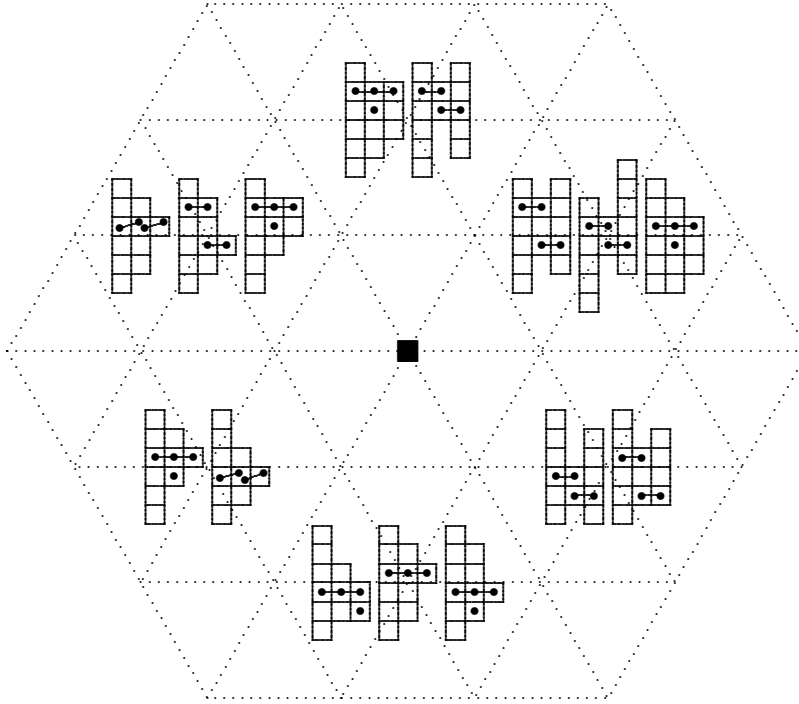

B.3. The non-central tripickets in $\Delta_{4/3}$ on axis-parallel lines.

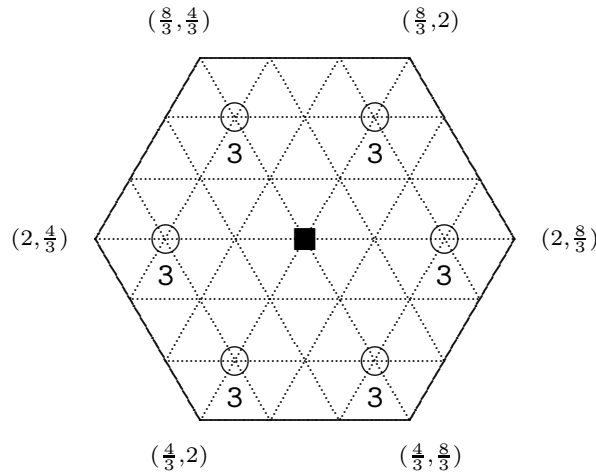

At each position, there are three tripickets, together they form three Σ_3 -orbits. In the fundamental domain, the object pictured on the left is on the mouth of the 6-tube of index $\frac{1}{4}$, the object in the middle has quasi-length 3 in the 6-tube of index $\frac{1}{1}$, and the object on the right lies on the mouth of the 6-tube of index $\frac{2}{3}$.

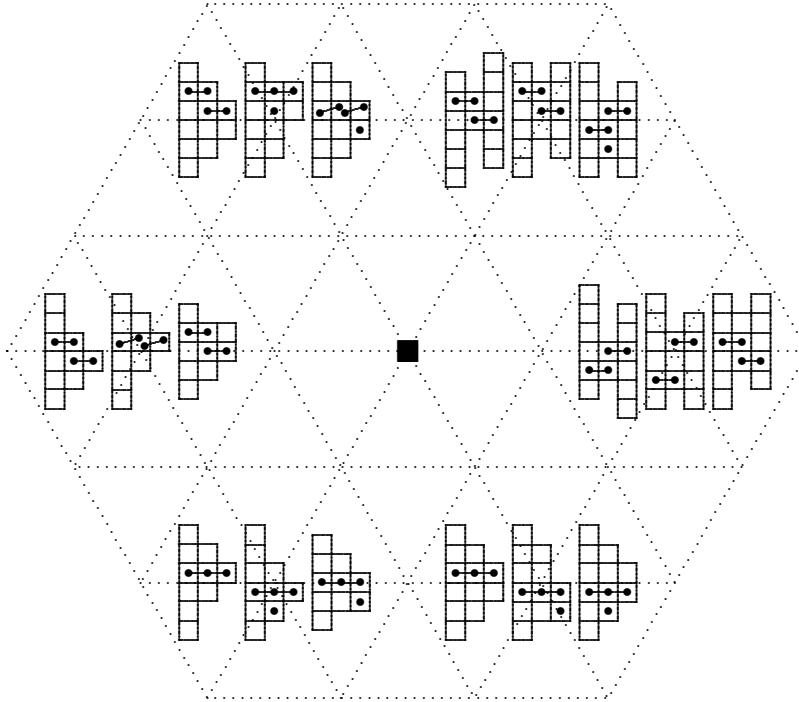

B.4. The non-central tripickets in $\Delta_{5/3}$ on axis-parallel lines.

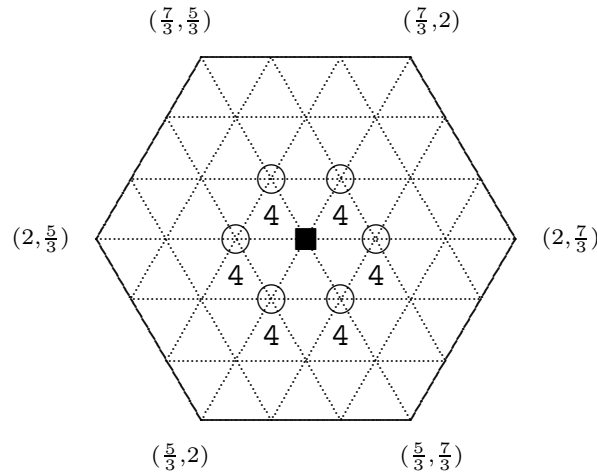

There are four tripickets at each position, they form four Σ_3 -orbits. Among the objects in the fundamental domain, the first occurs on the mouth of the 6-tube of index $\frac{1}{5}$, the second on the mouth of the 6-tube of index $\frac{5}{1}$. (Thus the first two orbits contain all the modules on the mouth of those two tubes.) The third object occurs on the 5th layer in $\mathcal{P}(6)$; the last in the tube of index $\frac{1}{6}$.

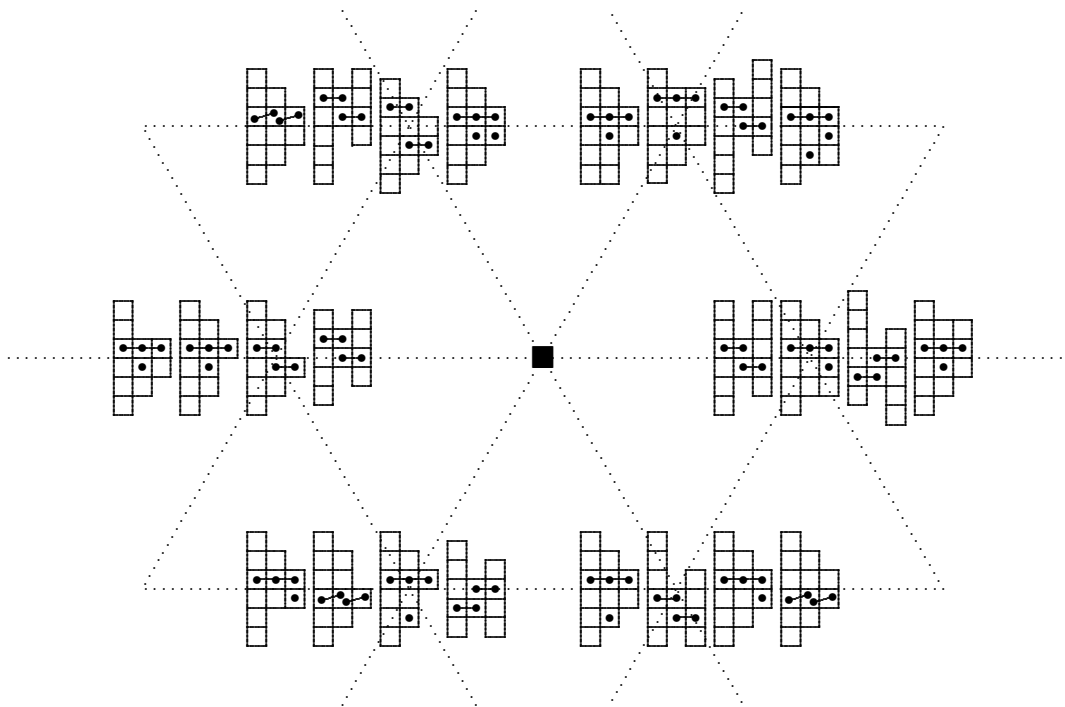

B.5. Some tetrapickets in $\mathcal{S}(6)$.

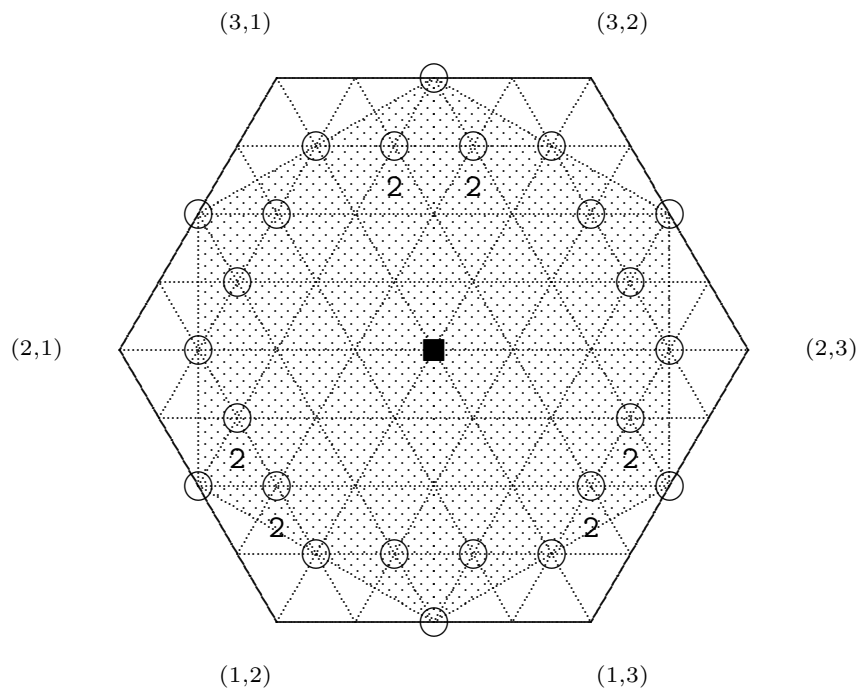

All tetrapickets in $\mathcal{S}(6)$ occur inside the hexagon, each on an intersection point of dotted lines in the above diagram. In (15.2 (d)) we have already pictured the six tetrapickets

on the boundary of the hexagon.

The 12 tetrapickets on the boundary of $\Delta_{5/4}$ are presented in (15.2 (f)). There are no other objects on the boundary of $\Delta_{5/4}$, and the only objects outside $\Delta_{5/4}$ are the pickets on Δ_0 and the objects on Δ_1 shown in (15.2).

There are 12 additional tetrapickets on the lines $q = \frac{13}{4}$, $p = \frac{11}{4}$ and $r = \frac{11}{4}$ (namely at the points marked by “2”). They lie on the half-lines connecting the center with the positions of the boundary pickets in the Σ_3 -orbit of the simple object S . At each position, two tetrapickets occur; each dimension vector is the sum of the root for the corresponding boundary picket and one of the two radical vectors \mathbf{h}_0 or \mathbf{h}_∞ for χ_Θ .

The objects lie on two orbits under the action of Σ_3 . The module pictured in the bottom row on the left occurs on the mouth of the 6-tube of index $\frac{6}{1}$, its neighbor has quasi-length 7 in the principal component.

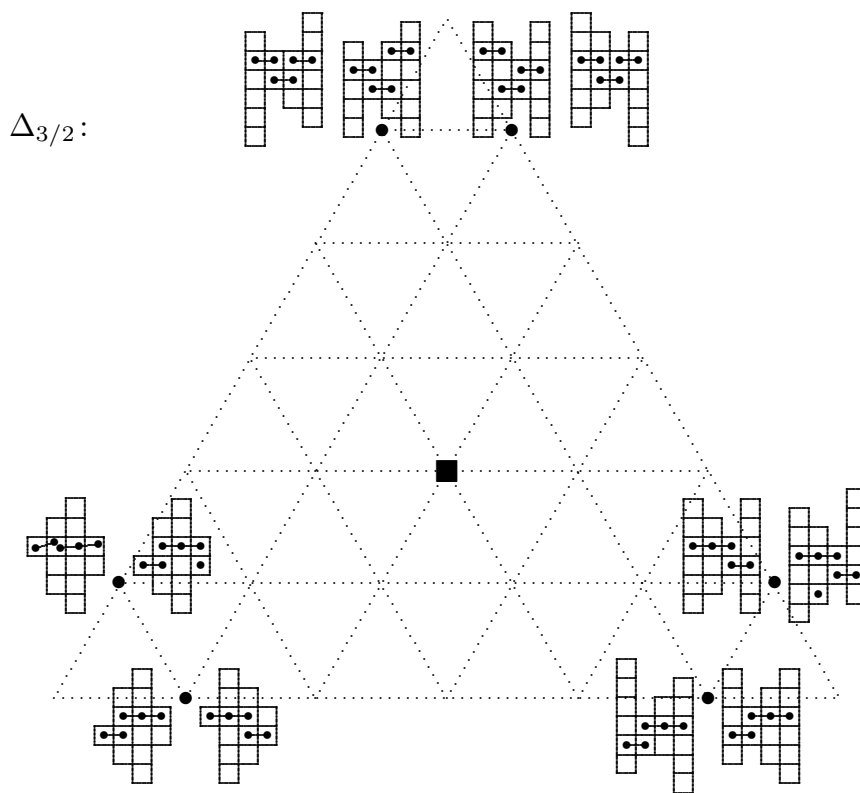

B.6. Six pentapickets.

Here, we present six pentapickets, they occur pairwise at the vertices of the triangle $\Delta_{8/5}$. Each dimension vector is the sum of the root for E_2^2 or one of its rotations and one of the two radical vectors.

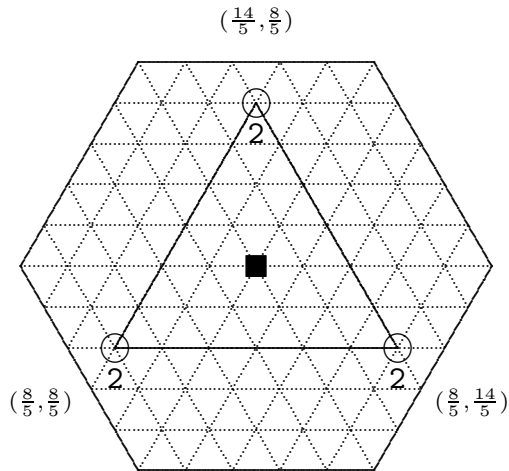

The objects form one Σ_3 -orbit consisting of modules of quasi-length two in the 6-tubes of index $\frac{1}{4}$ (left) or $\frac{4}{1}$ (right).

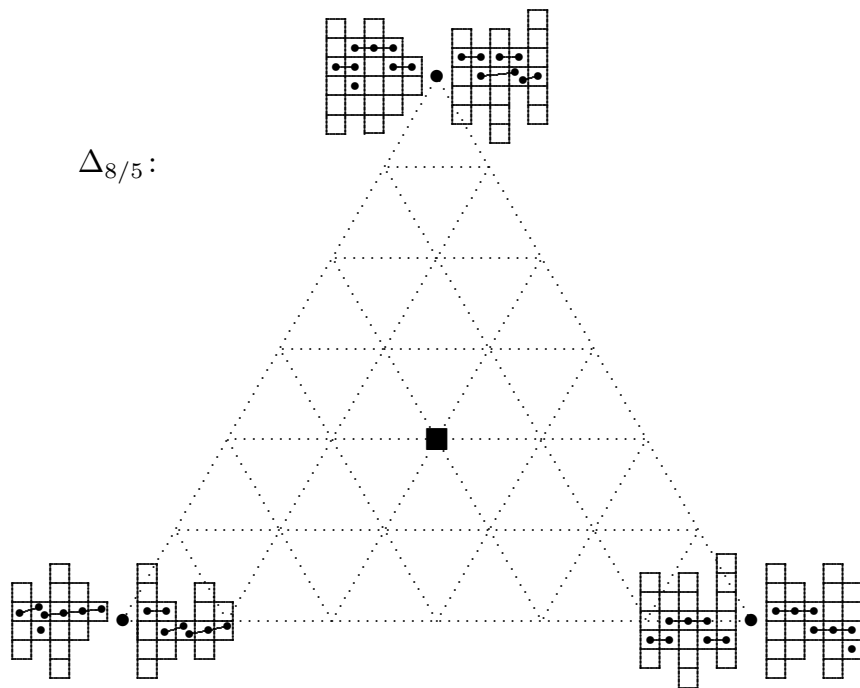

The line $q = \frac{16}{5}$ contains only the two mentioned pentapickets. This completes our description of the indecomposable objects in $\mathcal{S}(6)$ with $q \leq \frac{13}{4}$.

q	1	2	$\frac{5}{2}$	3	$\frac{16}{5}$	$\frac{13}{4}$...
# ind	2	4	2	15	2	6	...

Appendix C. Applications.

Markus Schmidmeier

Invariant subspaces are ubiquitous in pure and applied mathematics and in applications. We give a few examples as a reminder.

C.1. Invariant subspaces in undergraduate mathematics.

Invariant subspaces occur frequently in undergraduate mathematics although the student may not always be aware of it.

Consider for example the method of Undetermined Coefficients to deal with a linear higher-order non-homogeneous differential equation with constant coefficients. For illustration, in the equation

$$(DE) \quad Ly = e^{3t} + te^t, \quad \text{where} \quad Ly = y^{(4)} - 5y^{(3)} + 9y'' - 7y' + 2y,$$

the characteristic polynomial for the linear operator L has roots 1, 1, 1 and 2 (so $L = (\frac{d}{dt} - 1)^3(\frac{d}{dt} - 2)$). Consider the first term on the right hand side of (DE). Clearly, L acts invertibly on the $\frac{d}{dt}$ -invariant subspace $\langle e^{3t} \rangle$, hence a particular solution for $Ly = e^{3t}$ has the form Ae^{3t} for some coefficient $A \in \mathbb{R}$. For $n \in \mathbb{N}_0$, denote by $\text{Eig}_1(n)$ the $(n+1)$ -dimensional vector space $\langle t^n e^t, \dots, t^0 e^t \rangle$, it is $\frac{d}{dt}$ -invariant and $(\frac{d}{dt} - 2)$ acts invertibly on $\text{Eig}_1(n)$. On the other hand, the operator $(\frac{d}{dt} - 1)$ acts nilpotently with kernel $\text{Eig}_1(0)$ and image $\text{Eig}_1(n-1)$. Hence for $n = 4$, the second term on the right hand side of the differential equation, te^t , occurs in the image of $(\frac{d}{dt} - 1)^3$ acting on $\text{Eig}_1(4)$. The Ansatz $L(B_1 t^4 e^t + B_0 t^3 e^t) = te^t$ will lead to a particular solution for $Ly = te^t$. Using superposition, we see that there is a particular solution to (DE) in the form $y_p(t) = Ae^{3t} + B_1 t^4 e^t + B_0 t^3 e^t$.

The instructor can avoid exposing students to invariant subspaces at this early stage. By comparison, the proposed method in the textbook on differential equations, [C, 6.4.1], involves filling in a 5-column table...

C.2. Linear time-invariant dynamical systems.

In the theory of linear time-invariant control systems, the state-space representation of the system consists of vector spaces U' , V , W' (called the input space, the state space and the output space), a linear operator $A : V \rightarrow V$ and linear maps $B : U' \rightarrow V$, $C : V \rightarrow W'$.

$$\begin{array}{c} \begin{array}{ccc} U' & \xrightarrow{B} & V & \xrightarrow{C} & W' \\ & & \curvearrowright^A & & \end{array} \end{array}$$

The corresponding dynamical system is given by the vector equations

$$\dot{x}(t) = Ax(t) + Bu(t), \quad w(t) = Cx(t).$$

In general, the classification of control systems is considered infeasible. For example, the above quiver has infinite representation type even if the relation that $A^2 = 0$ is imposed.

Invariant subspaces occur naturally in control theory, see e.g. [KS, Theorem 1.24ff]. If the global space is given by the state space V with the action of the operator A , then both the controllable subspace $U = \sum_{i \geq 0} \text{Im } A^i B$ and the non-observable subspace $\overline{W} = \bigcap_{i \geq 0} \text{Ker } C A^i$ are invariant subspaces. (Hence the objects (U, V) or (\overline{W}, V) can be classified if A is nilpotent with nilpotence index at most 6.)

The special cases where U' and W' are one-dimensional vector spaces are called “single input” (SI) and “single output” (SO), respectively. In the first case, the controllable subspace U is cyclic (or zero) so we are dealing with an embedding (U, V) with a cyclic submodule (see Section 13).

C.3. The Algebraic Riccati Equation.

In Optimal Control Theory, the multivariable Linear-Quadratic Regulator problem gives rise to the matrix equation

$$(ARE) \quad A + BX + XC + XDX = 0$$

in the unknown $n \times n$ -matrix X . Solutions to (ARE) correspond to invariant subspaces, as follows. Let $\mathcal{H} = \begin{pmatrix} C & D \\ -A & -B \end{pmatrix}$, then the computation

$$\mathcal{H} \cdot \begin{pmatrix} I \\ X \end{pmatrix} = \begin{pmatrix} C+DX \\ -A-BX \end{pmatrix} = \begin{pmatrix} C+DX \\ XC+XDX \end{pmatrix} = \begin{pmatrix} I \\ X \end{pmatrix} \cdot (C + DX)$$

shows that the n -dimensional subspace U of k^{2n} spanned by the columns of $\begin{pmatrix} I \\ X \end{pmatrix}$ is \mathcal{H} -invariant. Conversely, any \mathcal{H} -invariant n -dimensional subspace U of k^{2n} with the extra property that the projection $U \rightarrow k^n, (u_i)_{i=1}^{2n} \mapsto (u_i)_{i=1}^n$, is onto, gives rise to a solution of (ARE).

Wikipedia [W2] writes, “The algebraic Riccati equation determines the solution of [...] two of the most fundamental problems in control theory.”

C.4. Complexes in Topological Data Analysis.

If a simplicial complex \mathcal{X} in topology is represented algebraically as a differential complex (that is, a graded square-zero linear operator $T : X_* \rightarrow X_*$), then a simplicial filtration of \mathcal{X} indexed by a poset \mathcal{P} with maximal element $*$ is represented as a system (X_i, \leq) of T -invariant subspaces of X_* , indexed by \mathcal{P} . The graded subspaces X_i satisfy $X_i \leq X_j$ whenever $i \leq j$ holds in \mathcal{P} .

In Topological Data Analysis, the persistence diagram (“bar code”) records the evolution of the topological space (typically given by the presence of homology) as the filtration parameter varies over the index set \mathcal{P} . In the single parameter case, the poset \mathcal{P} is totally ordered and the category of systems of T -invariant subspaces has discrete representation type (recall that $T^2 = 0$). In fact, the poset representations form the torsionless objects in a module category and the homology functor provides a correspondence with representations of a linear quiver [RZ].

In multi-parameter persistence, the poset \mathcal{P} needs no longer be totally ordered. Then two complications arise. The category of poset representations may be of wild representation type, and indecomposable non-projective representations may no longer be determined uniquely by homology. Multi-parameter persistence is topic of recent research, see [O] for an introduction.

C.5. The invariant subspace problem in analysis.

According to [W1], the invariant subspace problem in functional analysis is a partially unresolved problem asking whether every bounded operator on a complex Banach space sends some non-trivial closed subspace to itself. Many variants of the problem have been solved, by restricting the class of bounded operators considered or by specifying a particular class of Banach spaces.

The problem is still open for separable Hilbert spaces.

Additional references for Appendix C.

- [C] C. Constanda, *Differential equations*, 2nd ed., Springer 2017.
- [KS] H. Kwakernaak, R. Sivan, *Linear Optimal Control Systems*, Wiley-Interscience [John Wiley & Sons], New York-London-Sydney, 1972.
- [O] S. Y. Oudot, *Persistence theory: From quiver representations to data analysis*, Mathematical Surveys and Monographs **209**, AMS 2015.
- [RZ] C. M. Ringel and P. Zhang, *Representations of quivers over the algebra of dual numbers*, J. Algebra **475** (2017), 327–360.
- [W1] Wikipedia, *Invariant subspace problem*, recalled 2023-09-09.
- [W2] Wikipedia, *Algebraic Riccati equation*, recalled 2023-09-12.

Appendix D. Covering Theory, a Report.

Claus Michael Ringel

Reprint from the Izmir Lectures (2014), slightly revised

Covering theory provides an important method to construct indecomposable representations of a quiver with cycles using a suitable covering of the quiver. Let us stress that in this appendix we deal with quivers and their representations in general: relations which are satisfied by some given representations will not play a role. The quivers which can be handled, are the orbit quivers $Q = \tilde{Q}/G$, where G is a group of automorphisms of a quiver \tilde{Q} . In the application which we have in mind, namely $\mathcal{S}(n)$, the group G is just the additive group \mathbb{Z} , and the representations of \tilde{Q} are the graded (that means \mathbb{Z} -graded) $k\tilde{Q}$ -modules. Parallel to the development of covering theory by Bongartz, Gabriel and Riedtmann [BG, G, Rm], the (equivalent) theory of dealing with group-graded algebras and the corresponding graded modules was developed by Gordan and Green [GG]. In the language of covering theory, the forgetful functor from the category of graded modules to the category of ungraded modules is called the push-down functor $\pi_\lambda: \text{mod } k\tilde{Q} \rightarrow \text{mod } kQ$. The covering theory was introduced in order to deal with representation-finite algebras. It later was extended by Dowbor and Skowroński [DS] to finite-dimensional algebras in general.

From now on, we change the perspective (and thus the notation). The quiver which we will work with and which is the start of all the considerations will be denoted by Q (and not by \tilde{Q} as in the previous sentences): we start with a quiver Q and with a group G of automorphisms of Q .

D.1. Locally finite-dimensional representations of locally finite quivers.

A quiver Q is said to be *locally finite* provided any vertex x is head or target of only finitely many arrows. A representation M of a quiver Q is said to be *locally finite-dimensional* provided all the vector spaces M_x are finite-dimensional. Let us denote by $\text{Mod } kQ$ the category of locally finite-dimensional representations of Q (and by $\text{MOD } kQ$ the category of all the representations of Q).

Given a (not necessarily finite) direct sum $M = \bigoplus_{i \in I} M_i$ with indecomposable modules M_i , say we say that any indecomposable module occurs (in this direct sum decomposition) with *finite multiplicity*, provided for any module N , the number of indices $i \in I$ such that M_i is isomorphic to N , is finite.

Theorem (Dowbor-Skowroński). *Let Q be a locally finite quiver. Any indecomposable locally finite-dimensional representation has local endomorphism ring. Any locally finite-dimensional representation is the direct sum of indecomposable representations, each one occurring with finite multiplicity.*

Remark 1. Recall that the theorem of Krull-Remak-Schmidt-Azuyama asserts that for a direct sum $\bigoplus_i M_i$ of modules M_i with **local** endomorphism rings, the number of indices $i \in I$ with M_i isomorphic to a fixed module N does not depend on the decomposition. According to Theorem, we can use this result.

Proof of Theorem. First, let M be an indecomposable locally finite-dimensional representation of Q . We show that for any endomorphism $f = (f_x)_{x \in Q_0}$ of M either all the maps f_x are nilpotent (in this case f is said to be *locally nilpotent*) or else that all non-zero maps f_x are automorphisms. Recall that given a finite-dimensional vector space V and an endomorphism ϕ of V , there is a (unique!) direct decomposition $V = V' \oplus V''$ of vector spaces such that $\phi(V') \subseteq V'$, $\phi(V'') \subseteq V''$ so that the restriction $\phi' = \phi|_{V'}$ is bijective, whereas the restriction $\phi'' = \phi|_{V''}$ is nilpotent.

Looking at the vector space endomorphism f_x of M_x , we obtain in this way a direct decomposition $M_x = M'_x \oplus M''_x$ such that $f_x(M'_x) \subseteq M'_x$ and $f_x(M''_x) \subseteq M''_x$, with $f'_x = f_x|_{M'_x}$ bijective, and $f''_x = f_x|_{M''_x}$ nilpotent. Let $\alpha: x \rightarrow y$ be an arrow of Q , thus there is given $M_\alpha: M_x \rightarrow M_y$. With respect to the direct decompositions $M_x = M'_x \oplus M''_x$ we can write f_x in matrix form $\begin{bmatrix} (f'_x)^t & 0 \\ 0 & (f''_x)^t \end{bmatrix}$. Similarly, we use the direct decompositions $M_x = M'_x \oplus M''_x$ and $M_y = M'_y \oplus M''_y$ in order to write M_α in matrix form $M_\alpha = \begin{bmatrix} A & B \\ C & D \end{bmatrix}$. Since f is an endomorphism of M , there is the commutativity condition $M_\alpha f_x = f_y M_\alpha$, thus also $M_\alpha f_x^t = f_y^t M_\alpha$ for all $t \geq 0$. In terms of matrices, this means that

$$\begin{bmatrix} A & B \\ C & D \end{bmatrix} \begin{bmatrix} (f'_x)^t & 0 \\ 0 & (f''_x)^t \end{bmatrix} = \begin{bmatrix} (f'_y)^t & 0 \\ 0 & (f''_y)^t \end{bmatrix} \begin{bmatrix} A & B \\ C & D \end{bmatrix},$$

in particular, we have

$$B(f''_x)^t = (f'_y)^t B, \quad \text{and} \quad C(f'_x)^t = (f''_y)^t C,$$

for all $t \geq 0$. Since f''_y is nilpotent, the maps $B(f''_y)^t$ and $(f''_y)^t C$ are zero for t large. Since f'_x is invertible, we conclude that $B = 0$, $C = 0$.

This shows that we have vector space decompositions $M_x = M'_x \oplus M''_x$ such that for any arrow $\alpha: x \rightarrow y$, the map M_α maps M'_x into M'_y and M''_x into M''_y , thus $M = M' \oplus M''$ is a direct decomposition of kQ -modules. By assumption M is indecomposable, thus either $M = M'$ or $M = M''$. In the first case, all non-zero maps f_x are automorphisms, in the second case, f is locally nilpotent.

It follows as usual that the set of locally nilpotent endomorphisms of M is an ideal in the endomorphism ring $\text{End}(M)$ of M and that this ideal is the unique maximal ideal of $\text{End}(M)$, thus $\text{End}(M)$ is a local ring.

Now let us consider arbitrary locally finite-dimensional representations M of Q , where Q is a locally finite quiver. Without loss of generality, we may assume that Q is connected, thus clearly Q_0 is a countable set. Since the assertion of the theorem is well-known for finite quivers, we assume that Q is infinite, thus we can label the vertices as an infinite sequence $x(1), x(2), \dots$ and we put $\mathcal{X}(t) = \{x(1), x(2), \dots, x(t)\}$.

If \mathcal{X} is a set of vertices of Q , we say that $M \in \text{Mod } kQ$ is \mathcal{X} -*indecomposable* provided for any direct decomposition $M = M' \oplus M''$, we have $M'_x = 0$ for all $x \in \mathcal{X}$ or $M''_x = 0$ for all $x \in \mathcal{X}$. Note that we do not require that $M_x \neq 0$, not even that $M \neq 0$, thus a direct summand of an \mathcal{X} -indecomposable module is \mathcal{X} -indecomposable.

A finite direct decomposition $M = \bigoplus_{i=1}^m M(i)$ is called an \mathcal{X} -*decomposition* provided all the $M(i)$ are \mathcal{X} -indecomposable.

Lemma. *If \mathcal{X} is a finite set, then any $M \in \text{Mod } kQ$ has an \mathcal{X} -decomposition (but note that the direct summands $M(i)$ in an \mathcal{X} -decomposition are usually not unique, not even up to isomorphism).*

Proof. Either M is already \mathcal{X} -indecomposable, then nothing has to be done. Otherwise, there is a direct decomposition $M = M' \oplus M''$ with $M'_x \neq 0$ for some $x \in \mathcal{X}$ and $M''_y \neq 0$ for some $y \in \mathcal{X}$. Next we consider M' and M'' separately, and so on. Why does this process stop? Let $d(M) = \sum_{x \in \mathcal{X}} \dim M_x$, this is a finite number (since \mathcal{X} is finite and M is locally finite-dimensional). We have $d(M) = d(M') + d(M'')$ and by assumption, $d(M') \neq 0$, and $d(M'') \neq 0$, thus $d(M') < d(M)$ and $d(M'') < d(M)$. Thus, we see that after a finite number of steps, the process has to stop: this means that the corresponding direct summands are \mathcal{X} -indecomposable. \square

Now we start with a module $M \in \text{Mod } kQ$ and want to decompose it. This is done inductively, looking at the vertices $x(1), x(2), \dots$. The direct summands $M(v)$ of M obtained in step t will be indexed by a set $I(t)$ of sequences $v = (v_1, \dots, v_t)$ of natural numbers. In step 1, take an $\mathcal{X}(1)$ -decomposition

$$M = \bigoplus_{v_1=1}^{m(1)} M(v_1) = \bigoplus_{I(1)} M(v)$$

where $I(1)$ is the set of numbers $1 \leq v_1 \leq m(1)$. Assume we have constructed already an $\mathcal{X}(t)$ -decomposition $M = \bigoplus_v M(v_1, \dots, v_t)$, then we take for any module $M(v_1, \dots, v_t)$ an $\{x(t+1)\}$ -decomposition

$$M(v_1, \dots, v_t) = \bigoplus_{v_{t+1}=1}^{m(v_1, \dots, v_t)} M(v_1, \dots, v_t, v_{t+1}).$$

Of course, since $M(v_1, \dots, v_t)$ is $\mathcal{X}(t)$ -indecomposable, all the modules $M(v_1, \dots, v_t, v_{t+1})$ are $\mathcal{X}(t+1)$ -indecomposable. Thus, we obtain in this way an $\mathcal{X}(t+1)$ -decomposition

$$M = \bigoplus_{v \in I(t+1)} M(v).$$

with $I(t+1)$ the set of sequences (v_1, \dots, v_{t+1}) such that (v_1, \dots, v_t) belongs to $I(t)$ and $1 \leq v_{t+1} \leq m(v_1, \dots, v_t)$.

Let I be the set of infinite sequences $v = (v_1, v_2, \dots)$ such that (v_1, \dots, v_t) belongs to $I(t)$, for all t . For $v \in I$, we define the module $M(v)$ as $M(v) = \bigcap_t M(v_1, \dots, v_t)$. Note that the restriction of $M(v)$ to the full subquiver with vertices in $\mathcal{X}(t)$ is equal to the restriction of $M(v_1, \dots, v_t)$ to this subquiver. This shows that $M(v)$ is $\mathcal{X}(t)$ -indecomposable, for all t and that $M = \bigoplus_I M(v)$. Since $M(v)$ is $\mathcal{X}(t)$ -indecomposable for all t , we see that $M(v)$ is either zero or else indecomposable. If we denote by I' the set of indices v such that $M(v) \neq 0$, then $M = \bigoplus_{I'} M(v)$ is a direct decomposition with indecomposable direct summands.

It remains to stress that multiplicities have to be finite: If M, N are locally finite-dimensional kQ -modules and $N_x \neq 0$ for some vertex x , then in any direct decomposition of M , the number of direct summands which are isomorphic to N is bounded by $\dim M_x$.

Remark 2. In the proof given above, we had to single out at the end the indices $v \in I$ with $M(v) = 0$, thus replacing the index set I by I' . One may wonder whether one can avoid this. Given a module M in $\text{Mod } kQ$, we have used $\{x\}$ -decompositions $M = \bigoplus M^{(i)}$. Of course, in case $M_x = 0$, we may require to use as decomposition just the trivial one $M = M$, and for $M_x \neq 0$, we may require that $M_x^{(i)} \neq 0$ for all i . In general, this will reduce the size of I , but still some of the summands $M(v)$ with $v \in I$ may be zero.

As an example, consider the quiver of type \mathbb{A}_∞ with arrows from right to left, and the following representation M :

$$k^2 \xleftarrow{\begin{bmatrix} 0 & 0 \\ 1 & 0 \end{bmatrix}} k^2 \xleftarrow{\begin{bmatrix} 0 & 0 \\ 1 & 0 \end{bmatrix}} k^2 \xleftarrow{\dots}$$

In the first decomposition $M = M(1) \oplus M(2)$, we may assume that one of the direct summands, say $M(1)$, is simple projective. In the second step, we can decompose $M(2) = M(2, 1) \oplus M(2, 2)$ with $M(2, 1)$ of length 2, then, in the next step, $M(2, 2) = M(2, 2, 1) \oplus M(2, 2, 2)$ with $M(2, 2, 1)$ of length 2, and so on. In this way, we obtain as index set I' the set of sequences of the form $(2, \dots, 2, 1, 1, \dots)$ starting with $s \geq 0$ entries equal to 2, all others equal to 1, with $M(1, 1, \dots)$ the simple projective module, all other modules $M(2, \dots, 2, 1, 1, \dots)$ of length 2. But the set I contains in addition the constant sequence $(2, 2, \dots)$ with $M(2, 2, \dots) = 0$.

Remark 3. We have seen that given an indecomposable locally finite-dimensional representation M of a locally finite quiver, any non-invertible endomorphism f of M is locally nilpotent. But note that f *does not have to be nilpotent*. Here is an example: We consider the quiver Q presented on the left, and the representation M of Q outlined on the right:

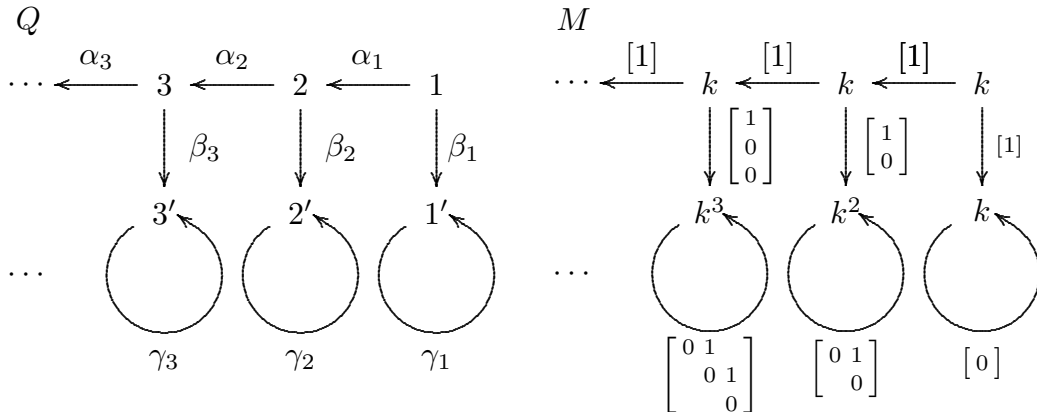

The endomorphism f of M which we are interested in, is defined by $f_i = 0$ and $f_{i'}$ being the nilpotent $i \times i$ Jordan matrix (as M_{γ_i}) for all $i \in \mathbb{N}_1$. Of course, f is locally nilpotent, but not nilpotent.

D.2. Automorphisms of a quiver Q which operate freely on Q_0 .

Let Q be a quiver and g an automorphism of Q . We say that g *operates freely* on Q_0 provided given a vertex x of Q and a natural number s with $g^s x = x$, we have $g^s = 1$. Of course, then G acts also freely on the arrow set Q_1 (namely, if $\alpha: x \rightarrow y$ is an arrow with $g(\alpha) = \alpha$, then $g(x) = x$, thus $g = 1$).

If M is a representation of Q , there is a representation M^g defined as follows: $(M^g)_x = M_{gx}$ for any vertex x , and $(M^g)_\alpha = M_{g\alpha}$ for any arrow α .

Lemma. *Assume that g is an automorphism of Q which acts freely on Q_0 and has infinite order. If $M \neq 0$ is a finite-dimensional representation of Q , then the modules M and M^g have different support. In particular, M^g is not isomorphic to M .*

Proof. Let x be a vertex of Q which belongs to the support of M . For any $i \in \mathbb{Z}$, let $x_i = g^i x$. Since g operates freely on Q_0 , we obtain in this way infinitely many pairwise different elements of Q_0 . Since M is finite-dimensional, there is i maximal such that x_i belongs to the support of M . Then $M_{x_i}^g = M_{gx_i} = M_{x_{i+1}} = 0$ shows that x_i does not belong to the support of M^g . Thus, M and M^g do not have the same support. \square

Example. Let us present a typical example of a quiver Q with an automorphism g of finite order $p \geq 2$ acting freely on Q_0 and an indecomposable representation M of Q such that $M^g = M$

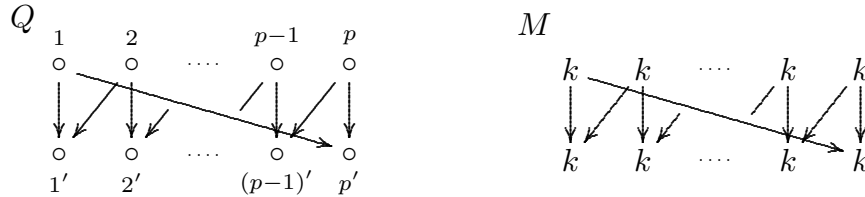

Here, M is defined by $M_x = k$ for all vertices x and $M_\alpha = 1_k$ for all arrows α . The automorphism g of Q is defined by $g(i) = i+1$ and $g(i') = (i+1)'$ (modulo p).

D.3. Groups operating freely on a quiver.

Assume now that there is given an automorphism group G of a quiver Q which operates freely on Q_0 . We denote by Q/G the orbit quiver: if x is a vertex of Q , let $\pi(x)$ be the G -orbit of x , if $\alpha: x \rightarrow y$ is an arrow, let $\pi(\alpha): \pi(x) \rightarrow \pi(y)$ be the G -orbit of α , thus $\pi: Q \rightarrow Q/G$ is a morphism of quivers.

Our interest concerns the functor $\pi_\lambda: \text{mod } kQ \rightarrow \text{mod } k(Q/G)$ which is defined as follows: If N is a finite-dimensional representation of Q , then

$$(\pi_\lambda N)_z = \bigoplus_{x \in \pi^{-1}(z)} N_x, \quad (\pi_\lambda N)_\gamma = \bigoplus_{\alpha \in \pi^{-1}(\gamma)} N_\alpha,$$

for all vertices z and all arrows γ of Q ; this functor π_λ is usually called the *push-down functor*.

Theorem (Gabriel). *Let Q be a locally finite quiver and G a group of automorphisms of Q which acts freely on Q_0 . Let N be a finite-dimensional indecomposable representation of Q such that the representations N^g for $g \in G$ are pairwise non-isomorphic. Then $\pi_\lambda N$ is an indecomposable representation of Q/G . If N' is a finite-dimensional indecomposable representation of Q such that the representations $\pi_\lambda N$ and $\pi_\lambda N'$ are isomorphic, then there is $g \in G$ such that N' is isomorphic to N^g .*

Proof. We need a further functor, namely $\pi_i: \text{mod } k(Q/G) \rightarrow \text{Mod } kQ$ which is defined as follows: If M is a finite-dimensional $k(Q/G)$ -module, then

$$(\pi.M)_x = M_{\pi(x)}, \quad (\pi.M)_\alpha = M_{\pi(\alpha)},$$

for all vertices x and all arrows α of Q ; this functor is called the *pull-up functor* (note that by definition $\pi.M$ is locally finite-dimensional, thus in $\text{Mod } kQ$). Of course, for any element $g \in G$, we have $(\pi.M)^g = \pi.M$.

Given a finite-dimensional kQ -module N , let us consider $\pi.\pi_\lambda N$. For x a vertex of Q , we have

$$(\pi.\pi_\lambda N)_x = (\pi_\lambda N)_{\pi(x)} = \bigoplus_{y \in \pi^{-1}\pi(x)} N_y.$$

The set $\pi^{-1}\pi(x)$ is by definition the G -orbit of x , thus

$$(\pi.\pi_\lambda N)_x = \bigoplus_{g \in G} N_{g(x)} = \bigoplus_{g \in G} N_x^g = \left(\bigoplus_{g \in G} N^g \right)_x.$$

It follows that

$$\pi.\pi_\lambda N = \bigoplus_{g \in G} N^g.$$

Since by assumption the modules N^g are pairwise non-isomorphic (and indecomposable), we have obtained in this way a direct decomposition of $\pi.\pi_\lambda N$ using pairwise non-isomorphic modules with local endomorphism rings.

Let us show now that $\pi_\lambda N$ is indecomposable. Thus, assume there is given a direct decomposition $\pi_\lambda N = M \oplus M'$ of $k(Q/G)$ -modules. Then

$$\bigoplus_{g \in G} N^g = \pi.\pi_\lambda N = \pi.M \oplus \pi.M'.$$

According to D.1 and the Krull-Remak-Schmidt-Azumaya theorem, there is a subset $H \subseteq G$ such that $\pi.M$ is isomorphic to $\bigoplus_{h \in H} N^h$. If $M \neq 0$, then H is not empty. Since $(\pi.M)^g = \pi.M$ for all $g \in G$, it follows that $\pi.M$ is also isomorphic to $\bigoplus_{h \in H} N^{hg}$, for all $g \in G$, thus there is a direct decomposition of $\pi.M$ into indecomposable modules such that one of the summands is isomorphic to N . Assume now that both M, M' are non-zero. Then there is a direct decomposition of $\pi.M \oplus \pi.M' = \pi.\pi_\lambda N$ into indecomposable modules such that two of the summands are isomorphic to N . This contradicts the theorem of Krull-Remak-Schmidt-Azumaya.

Finally, assume that N, N' are finite-dimensional indecomposable representations of Q such that the representations $\pi_\lambda N$ and $\pi_\lambda N'$ are isomorphic. Then $\pi_\lambda N$ is isomorphic

to $\bigoplus_{g \in G} N^g$ as well as to $\bigoplus_{g \in G} (N')^g$. Again using the assumption that the modules N^g are pairwise non-isomorphic (and indecomposable) and that N' is indecomposable, the theorem of Krull-Remak-Schmidt-Azumaya implies that N' is isomorphic to some N^g . This completes the proof.

Corollary. *Let Q be a locally finite quiver and G a torsionfree group of automorphisms of Q which acts freely on Q_0 . Then π_λ provides an injective map from the set of G -orbits of isomorphism classes of indecomposable kQ -modules to the set of isomorphism classes of indecomposable $k(Q/G)$ -modules.*

Let us rephrase what it means that the map given by π_λ is injective:

- (a) If M is a finite-dimensional indecomposable representation of Q , then $\pi_\lambda M$ is an indecomposable representation of Q/G .
- (b) If M, M' are finite-dimensional indecomposable representations of Q , with $\pi_\lambda M, \pi_\lambda M'$ being isomorphic representations of Q/G , then there is $g \in G$ such that M' is isomorphic to M^g .

Corollary is a direct consequence of the theorem using the lemma in D.2.

Remark. The map given by π_λ is injective, but usually not surjective. A typical example is provided by the quiver Q of type \mathbb{A}_∞^∞ with bipartite orientation

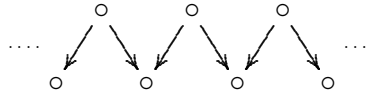

and the shift automorphism g so that there are precisely two g -orbits, the sources and the sinks. Then Q/G is the Kronecker quiver. Obviously, the indecomposable representation M of Q/G with $M_x = k$ for both vertices and $M_\alpha = 1_k$ for both arrows is not isomorphic to a representation of the form $\pi_\lambda N$.

Additional references for Appendix D.

- [BG] K. Bongartz, P. Gabriel. *Covering Spaces in Representation-Theory*. *Inventiones mathematicae* 65 (1981/82), pp 331–378.
- [D] P. Dowbor. *Properties of G -atoms and full Galois covering reduction to stabilizers*, *Colloq. Math.* 83 (2000), 231–265.
- [GG] R. Gordon, E. L. Green, *Representation theory of graded Artin algebras*. *J. Algebra* 76 (1982), 138–152.
- [DS] P. Dowbor, A. Skowroński. *Galois coverings of representation-infinite algebras*, *Comment. Math. Helvetici* 62 (1987)
- [G] P. Gabriel. *The universal cover of a representation-finite algebra*, in: *Lecture Notes in Math.*, vol. 903, Springer-Verlag, Berlin/New York (1981), 68–105.
- [Rm] Chr. Riedtmann. *Algebren, Darstellungskcher, Überlagerungen und zurück*. *Comm. Math. Helv.* 55 (1980), 199–224.

Table of contents.

Abstract

1. Introduction

Basic definitions.

First results. Theorem 1 and 2. Reformulations.

Symmetries: duality and rotation.

Uwb-vectors and the pr-triangle $\mathbb{T}(n)$. Boundary distance.

Pr-vectors with boundary distance at least 2. BTh-vectors. Theorem 4.

Central half-lines. Theorem 5.

The half-line support and the triangle support of a component. Theorem 6.

The case $n = 6$. Theorems 7 and 8. The 12 lines. The relevant hexagon.

Optimal results?

General context: Birkhoff problem, Gorenstein-projective modules, operator theory.

Outline of the paper.

2. Preliminaries

Further definitions and notation.

Visualization of objects in \mathcal{S} .

Report: Covering theory.

Report: The d -Kronecker algebras $K(d)$.

Report: Simplification.

Kronecker subcategories, Kronecker families.

Example: The standard family in $\mathcal{S}(6)$.

Some \mathbb{P}^1 -families in $\mathcal{S}(6)$ with width 6.

3. The functor τ^2 . Proof of Theorem 3. The invariant c_n .

The set $\mathbb{E}(n)$.

Proof of Theorem 3.

Remark on reduced pickets and bipickets.

Corollary. The average of p and r on a τ^2 -orbit.

The uwb-vectors and the triples $(|E_0|, |E_1|, |E_2|)$. u -minimal objects.

Barycentric coordinates.

Central objects.

The functor τ . Warnings.

Proposition. $b(\tau_n X) \leq bU + bW$ for $X \in \mathcal{S}(n)$.

Proposition. Upper and lower bound for $b(\tau_n X)$.

Proposition on $bX + b(\tau_n X)$.

The invariant c_n .

First part: Sparsity.

4. Telescope filtrations. Proof of Theorem 1.

5. Special filtrations, nice filtrations. Proof of Theorem 2. Theorem 9.

Second part: Density.

6. BTh-vectors. Proof of Theorem 4.

Some endofunctors of $\tilde{\mathcal{S}}(n)$.

Solid objects and strongly solid objects.
 Expansion and coexpansion of solid Kronecker families.
 A triangle of BTh-vectors for $n = 7$.
 The trapezoid T in $\mathbb{T}(7)$.
 Proof of Theorem 4.
 Remark. Some BTh-vectors with boundary distance less than 2.

7. Objects with level 1.

Objects without direct summands which are 0-pickets.
 The indecomposable objects $X = (U, V)$ with $bU = 1 = pX$. The objects C_λ .
 Example: $Y \in \mathcal{S}(6)$ with $pY = 1, bU = 2$.
 Example: A \mathbb{P}^1 -family of indecomposable objects $X \in \mathcal{S}(9)$ with $pX = 1$.
 Wildness. An example.

8. Further BTh-vectors. Theorem 10.

For $n = 7$, the uwb-vector $\frac{6|10}{4}$.
 A BTh-family in $\tilde{\mathcal{S}}_3(7)$ with uwb-vector $\frac{7|14}{5}$.
 A BTh-family in $\tilde{\mathcal{S}}(8)$ with uwb-vector $\frac{6|17}{5}$.
 Interpolation between $\frac{6|17}{5}$ and $\frac{6|16}{4}$.
 Theorem 10.

Third part: Half-line support. Triangle support.

9. Rays and central half-lines: the plus-construction. Proof of Theorem 5.

Rays, corays and the quasi-length of indecomposable objects. The plus-construction.
 The weight $\beta\mathcal{C}$ of a component \mathcal{C} .
 The additivity of the function b .
 The principal component. uwb-vectors.
 Central objects of quasi-length 6.
 Proof of Theorem 5 for stable tubes.
 The induction step.
 Proof of Theorem 5 for the principal component $\mathcal{P}(n)$.
 The global space for the objects in $\mathcal{P}(n)$.
 Half-lines. Central half-lines. Complementary half-lines.
 Arithmetical sequences. Generalization of Theorem 5.
 Proposition on u -minimal objects. The sequence $d(X^{+t})$.
 Proposition on objects with fixed boundary distance.

10. The half-line support and the triangle support of a component. Proof of Theorem 6.

Complementary half-lines.
 Example of a stable tube with half-line support given by 15 complementary pairs.
 Some central lines and half-lines. $\mathbb{P}(n), \mathbb{D}(n), \mathbb{H}_\ell(n), \mathbb{K}_s(n)$.
 The half-line support of $\mathcal{P}(n)$ for $n \geq 6$.
 The triangle support of a component. Primitive pairs.
 The primitive pairs for $\mathcal{P}(6)$.
 The m -partition and the width partition for $\mathcal{P}(n)$ for $n \geq 6$. Nablas and circles.
 The central objects in $\mathcal{P}(n)$.
 The half-line support of $\mathcal{P}(n)$ for $1 \leq n \leq 5$.

The triangle support of $\mathcal{P}(n)$ for $1 \leq n \leq 5$.
 Components closed under duality.
 The τ -orbits closed under duality.

Fourth part: The case $n = 6$.

11. The case $n = 6$. Proof of Theorems 7 and 8.
 The structure of the category $\mathcal{S}(6)$. (A report.)
 The width. The formula $b\pi M = \dim M_3$ for $M \in {}'\mathcal{D}$.
 Central objects.
 Proof of Theorem 7. The values of $\eta = v - 4b$ and of $u - 2b$.
 A finiteness result regarding $dX \leq a < 2$ and $qX \leq b < 4$ for $X \in \mathcal{S}(6)$.
 The half-line support of Kronecker subcategories. Proof of Theorem 8 (a).
 More about $\mathbb{L}(6)$. Slope and equations for the 12 lines.
 The triangle support of $\mathcal{S}(6)$. Proof of Theorem 8 (b).
 More on the set Ψ .
 Proof of Theorem 8 (c).
 Small objects in $\mathcal{S}(6)$.
 The function η_n for $n \geq 7$.
 Central lines and Kronecker subcategories.

Fifth part: Some objects.

12. Pickets and bipickets.
 Pickets. Their τ -orbits. Irreducible module varieties.
 Bipickets.
 Indecomposable objects X with $bX \geq 3$.
13. The indecomposable objects $X = (U, V)$ with U being cyclic.
 A first combinatorial description.
 The T -height sequence of a non-zero element in an object in $\mathcal{N}(n)$.
 A second combinatorial description.
 The indecomposable objects $X = (U, V)$ with $bU = 1 = pX$. Fibonacci numbers.
 The indecomposable objects $X = (U, V)$ with $bU = 1 = bW$.
14. Non-gradable objects.
 Some examples.
 Homogeneous tubes containing non-gradable objects.
 Homogeneous tubes containing graded objects.
 Auslander-Reiten components in $\mathcal{S}(n)$ containing gradable objects.
 Gradability of objects.
15. Gallery: Basic examples.
 $\mathcal{S}(1), \dots, \mathcal{S}(5)$.
 The case $n = 6$.
 Indecomposable objects with $q < 4$.
16. Questions.
 Finite pr-vectors.
 Indecomposable objects X with $qX < 4$.
 The role of the line $3p + r = 7$.

Terra incognita.
The set of BTh-vectors. Convexity.
Tame and wild.
Infinite dimensional objects.
The case $n = 6$.

17. Comments.

The mystery of boundary distance 1.
The plus-construction.
Combinatorics versus algebra: Combinatorial features of the subspace problems.
The category $\mathcal{S}(6)$ and the root system \mathbf{E}_8 .
The spider web for $n = 6$.
The triangle $\mathbb{T}(n)$. The infinite region \mathbb{T} .
The rotation of $\mathbb{T}(n)$.

18. References.

Appendices.

- A. Appendix. The roots of \mathbf{E}_8 . By Markus Schmidmeier.
- B. Appendix. The tripickets, and some tetrapickets and pentapickets for $\mathcal{S}(6)$.
By Markus Schmidmeier.
- C. Appendix. Applications. By Markus Schmidmeier.
- D. Appendix. Covering Theory. A Report. By Claus Michael Ringel.
(Reprinted from the Izmir Lectures (2014), slightly revised)

Relevant pictures:

- The uwv-vectors of the objects in $\mathcal{P}(n)$ (Section 9.5).
- The partitions VX of the objects X in $\mathcal{P}(n)$ (Section 9.10).
- The 12 lines $\mathbb{L}(6)$ and their slopes (Section 11.7).
- The 18 tripickets on the boundary of the hexagon of $\mathcal{S}(6)$ (Section 15.2 (c))
- Terra incognita (Section 16.5 (3))
- The nested hexagons (“spider web”) (Section 17.5)

C. M. Ringel
Fakultät für Mathematik, Universität Bielefeld
POBox 100131, D-33501 Bielefeld, Germany
ringel@math.uni-bielefeld.de
ORCID: 0000-0001-7434-0436

M. Schmidmeier
Department for Mathematics and Statistics, Florida Atlantic University
777 Glades Road, Boca Raton, Florida 33431, United States of America
markusschmidmeier@gmail.com
ORCID: 0000-0003-3365-6666