

$K_{1,2,2,2}$  HAS NO  $n$ -FOLD PLANAR COVER GRAPH FOR  $n < 14$ 

DICKSON Y. B. ANNOR, YURI NIKOLAYEVSKY, AND MICHAEL S. PAYNE

ABSTRACT. S. Negami conjectured in 1988 that a connected graph has a finite planar cover if and only if it embeds in the projective plane. It follows from the works of D. Archdeacon, M. Fellows, P. Hliněný, and S. Negami that this conjecture is true if the graph  $K_{1,2,2,2}$  has no finite planar cover. We prove a number of structural results about putative finite planar covers of  $K_{1,2,2,2}$  that may be of independent interest. We then apply these results to prove that  $K_{1,2,2,2}$  has no planar cover of fold number less than 14.

## 1. INTRODUCTION

In this paper, we deal with finite simple undirected graphs. For a graph  $K$ , let  $V(K)$  and  $E(K)$  respectively denote the vertex set and edge set of  $K$ . A graph  $G$  is a *cover* of a graph  $K$  if there exists an onto mapping  $\pi : V(G) \rightarrow V(K)$ , called a (cover) *projection*, such that  $\pi$  maps the neighbours of any vertex  $v$  in  $G$  bijectively onto the neighbours of  $\pi(v)$  in  $K$ . A cover is called *planar* if it is a planar graph. Note that every planar graph has a planar cover by the identity projection, but there are also non-planar graphs having planar covers. If  $K$  is connected, then  $|\pi^{-1}(v)| = n$  is the same for all  $v \in V(K)$  and  $\pi$  is called an  $n$ -fold cover.

In 1988 S. Negami made the following conjecture.

**Conjecture 1** (Negami’s Conjecture [8]). *A connected graph has a finite planar cover if and only if it embeds in the projective plane.*

If a graph embeds in the projective plane, then the lift of this embedding to the sphere is a planar 2-fold cover. Thus every projective-planar graph has a planar cover. The converse is not true for disconnected graphs. For example, the graph consisting of two disjoint copies of  $K_5$  has a planar cover, but does not embed in the projective plane.

In the years after Conjecture 1 was posed, the results of D. Archdeacon [1], M. Fellows [4], P. Hliněný [5] and [7], and S. Negami [10] combined to show that it is equivalent to the following statement ‘ $K_{1,2,2,2}$  has no finite planar cover’. The graph  $K_{1,2,2,2}$  consists of the octahedron with an apex vertex connected to all other vertices, see Figure 1.

---

2020 *Mathematics Subject Classification*. Primary: 05C10; Secondary: 57M15.

*Key words and phrases*. Planar cover, projective plane, Negami’s conjecture.

Department of Mathematical and Physical Sciences, La Trobe University, Bendigo 3552 and Bundoora 3086, Australia.

Corresponding author’s email: d.annor@latrobe.edu.au.

Dickson Annor was supported by a La Trobe Graduate Research Scholarship.

Michael Payne was partially supported by a DECRA from the Australian Research Council.

Furthermore, Archdeacon and Richter [3] showed that for any planar cover of a non-planar graph, the fold number is even. It is also known that  $K_{1,2,2,2}$  has no planar 2-fold cover [9]. For other related partial results on Negami's conjecture, we refer interested readers to [6].

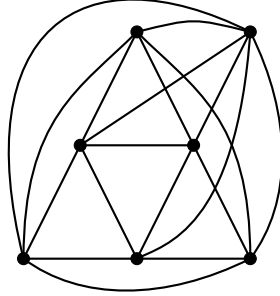

FIGURE 1. The graph  $K_{1,2,2,2}$ .

The purpose of this paper is to study the structure of planar covers of  $K_{1,2,2,2}$  in the hope that we might make useful progress towards a proof of Conjecture 1. As an application of our results we prove the following.

**Theorem 1.** *No 4, 6, 8, 10 or 12-fold cover of the graph  $K_{1,2,2,2}$  is planar.*

Combined with the earlier results mentioned above this implies:

**Corollary 1.** *If a connected graph  $a$  has planar cover of fold number less than 14, then it embeds in the projective plane.*

Moreover, since any possible counterexample to Conjecture 1 would contain  $K_{1,2,2,2}$  (or another excluded minor for projective planar graphs that reduces to  $K_{1,2,2,2}$  via  $Y\Delta$ -transformations, see [6]) as a minor, its planar cover graph would have fold number at least 14 and at least 98 vertices.

We note that N. Takahashi [12] worked on finite planar covers of  $K_{1,2,2,2}$  in his Master's Thesis supervised by K. Ota. He proved that  $K_{1,2,2,2}$  has no planar cover of fold number less than 12. His method of proof was a form of discharging argument. In contrast, our approach is inspired by the 'structural' methods employed by Archdeacon [1].

The paper is organised as follows. In Section 2, we state some necessary definitions and known lemmas. In Section 3 we prove an important lemma, that if Conjecture 1 fails there must be a planar cover  $G$  of  $K_{1,2,2,2}$  in which triangular facial cycles are the only facial cycles that cover triangles. In Section 4, we select a particular subgraph  $G'$  of  $G$ , and a cover  $H$  of  $K_4$  inside  $G'$ , then go on to establish a number of useful properties of  $G'$  and  $H$ . In Section 5 we show that  $H$  cannot have just one internal non-triangular face and in Section 6 we show that  $H$  cannot have just two internal non-triangular faces. Up to this point, the results presented do not depend on the fold number of the cover  $G$ . In Section 7 we turn our attention to covers of low fold number and prove Theorem 1.

## 2. PRELIMINARIES

Let graph  $G$  be a cover of graph  $K$ . For any subgraph  $K'$  of  $K$ , we call the graph  $G' = \pi^{-1}(K')$  the *lift of  $K'$  into  $G$* . The lift of a cycle  $C$  of  $K$  into  $G$  is a collection of disjoint cycles  $C'_1, C'_2, \dots, C'_s$ . Note that the length of  $C$  divides the length of  $C'_i$ , for  $i = 1, 2, \dots, s$ . A cycle  $C'$  in  $G$  is called *short* if its length is equal to the length of  $C$ . Otherwise, it is called *long*. A cycle  $C$  is *peripheral* in a graph  $K$  if it is chordless and  $K \setminus C$  is connected.

**Lemma 1.** (*Archdeacon [1]*) *Let  $G$  be a plane cover of a graph  $K$ . Let  $C'$  be a short cycle of  $G$  covering a peripheral cycle  $C$  in  $K$ . Then  $C'$  is a face boundary.*

Let  $G$  be a plane graph, and let  $f$  be the outer face of  $G$ . The graph  $G$  is a *semi-cover* of a graph  $K$  if there exists an onto mapping  $\rho : V(G) \rightarrow V(K)$ , called a *semi-projection*, such that for each vertex  $v$  of  $G$  not incident with  $f$ ,  $\rho$  maps the neighbours of  $v$  bijectively onto the neighbours of  $\rho(v)$  in  $K$ , and for each vertex  $w$  of  $G$  incident with  $f$ ,  $\rho$  maps the neighbours of  $w$  injectively to the neighbours of  $\rho(w)$ . It is clear that every cover is a semi-cover but the converse is not true. The notion of semi-cover was first introduced by Hliněný [7].

We will need the following fact about planar covers of  $K$  with minimum fold number [11, Corollary 10].

**Lemma 2.** *Suppose graph  $G$  is a minimum fold planar cover of graph  $K$ . Then if  $K$  is 3-connected, then  $G$  is 3-connected.*

Throughout this paper, we label every vertex of  $G$  with the name of the corresponding vertex in  $K$  (except sometimes we add a subscript or dash in order to distinguish particular vertices). That is, each vertex  $v$  in  $G$  gets the same label as  $\pi(v)$  in  $K$ . For the sake of brevity, we will often refer to a vertex of  $G$  labelled  $x$  simply as ‘a vertex  $x$ ’, or to a triangle in  $G$  labelled  $(a, b, c)$  as just ‘a triangle  $(a, b, c)$ ’.

We label the vertices of  $K_{1,2,2,2}$  as follows: the vertex of degree 6 is labelled 0, and the six vertices of degree 5 are labelled  $\{\pm 1, \pm 2, \pm 3\}$  in such a way that the vertices  $i$  and  $-i$  are not adjacent for  $i = 1, 2, 3$ . Note that every vertex  $\pm i$  of degree 5 is adjacent to the vertex 0 and to four vertices  $\pm j, \pm k$ , where  $\{i, j, k\} = \{1, 2, 3\}$ .

## 3. SELECTING A PARTICULAR COVER

Assume  $K_{1,2,2,2}$  has a finite planar cover graph. We identify each cover with its plane drawing. Note that this identification is well-defined by Whitney’s theorem, as the cover is 3-connected by Lemma 2. Out of all such covers we choose one with the following properties:

- (A) It has the smallest fold number.
- (B) Out of those covers satisfying (A), it has the maximal number of triangular faces.
- (C) Any short cycle covering a triangle in  $K_{1,2,2,2}$  bounds a face. (This property is guaranteed by Lemma 1.)

**Lemma 3.** *Out of those planar covers satisfying (A), (B) and (C), there is a cover such that:*

(D) *No long cycle covering a triangle in  $K_{1,2,2,2}$  bounds a face.*

*Proof.* Call a face bounded by a long cycle covering a triangle in  $K_{1,2,2,2}$  *long cyclic*. Arguing by contradiction, suppose that any cover satisfying (A) and (B) contains a long cyclic face. Let  $\mathcal{G}$  be the set of such covers having the smallest possible number of long cyclic faces.

We claim that there exists  $G \in \mathcal{G}$  with all the faces but one being triangular, and with this remaining face being long cyclic. Suppose this is not true, and so any  $G \in \mathcal{G}$  contains a long cyclic face  $F$  (potentially, more than one) and a non-triangular face  $F' \neq F$  (which may or may not also be long cyclic). Define the distance  $d(F, F')$  between  $F$  and  $F'$  to be the smallest number  $m \geq 1$  for which there exists a sequence of faces  $F', F_1, F_2, \dots, F_{m-1}, F$  of  $G$ , in which any two consecutive faces share an edge. Let  $m(G) \geq 1$  be the minimum of the numbers  $d(F, F')$  where  $F$  is a long cyclic face of  $G$  and  $F' \neq F$  is a non-triangular face of  $G$ .

Denote  $M = \min\{m(G) : G \in \mathcal{G}\}$  (note that  $M \geq 1$  by our assumption), and choose a drawing  $G$ , a long cyclic face  $F$  of  $G$  and a non-triangular face  $F' \neq F$  of  $G$  such that  $d(F, F') = M$ . Let  $F', F_1, F_2, \dots, F_{M-1}, F$  be a sequence of faces of  $G$  that realises this distance; note that  $F_i$  and  $F$  have no common edges for  $1 \leq i \leq M - 2$ .

Suppose the boundary  $C$  of  $F$  is the lift of a cycle  $abc$  of  $K_{1,2,2,2}$  and that the vertices of  $C$  are labelled  $abcabc\dots$  in the positive direction. Suppose  $(c, a)$  is an edge shared by  $F_{M-1}$  and  $F$ . We simultaneously replace the union of all edges  $(c, a)$  of  $C$  by the union of disjoint edges lying in  $F$  by joining every vertex  $a$  of  $C$  to the next vertex  $c$  in the positive direction on  $C$ . We get another planar cover  $G'$  of  $K_{1,2,2,2}$ . Note that in  $G'$ , all the faces are still discs (by (A)). Moreover, every face of  $G$  sharing an edge  $(c, a)$  with  $F$  in  $G$  must be triangular (note that this implies  $M > 1$ ), for otherwise  $G'$  would have had more triangular faces than  $G$ , in contradiction with (B). The third vertex of any such triangular face has a label different from any of  $a, b$  or  $c$ , and all these vertices are different vertices of  $G$ . If at least two of them have different labels, then  $G'$  still satisfies (A) and (B), and has one fewer long cyclic faces than  $G$ , in contradiction with the fact that  $G \in \mathcal{G}$ . Hence all these third vertices must have the same label, so that the above procedure produces a long cyclic face  $F''$  of  $G'$  (and destroys the long cyclic face  $F$  of  $G$ ). As all the faces of  $G$  that do not share an edge  $(c, a)$  with  $F$  are still faces of  $G'$ , we deduce that  $G' \in \mathcal{G}$ . By the same reason, all the faces  $F', F_1, \dots, F_{M-2}$  of  $G$  are faces of  $G'$ , with any consecutive two sharing an edge. Moreover, by our construction, the face  $F_{M-2}$  of  $G'$  shares an edge with  $F''$  (one of the edges of the “former” triangular face  $F_{M-1}$  of  $G$ ). It follows that the distance  $d(F'', F')$  in  $G$  is at most  $M - 1$ , a contradiction.

We have now constructed a cover  $G \in \mathcal{G}$  with the property that one of its faces  $F$  is long cyclic and all the other faces are triangular. We want to show that such  $G$  cannot exist.

Denote  $3m$ ,  $m \geq 2$ , the length of the cycle  $C$  bounding  $F$ , and assume that  $F$  is the external face. As above, suppose that  $C$  covers a cycle  $abc$  in  $K_{1,2,2,2}$ . If  $G$  is an  $n$ -fold cover of  $K_{1,2,2,2}$ , then it has  $7n$  vertices and  $18n$  edges, and hence  $11n + 2$  faces, by Euler’s formula. Since one of the faces has length  $3m$  and all others are triangular, a simple calculation gives  $n = m + 1$ . It follows that inside  $C$  we have only one of each vertices

with labels  $a, b$  and  $c$ , which must then be the vertices of a triangular face  $\Delta$  of  $G$  by (C). Moreover, as  $n$  is even by [3] we obtain that  $m$  is odd and  $m \geq 3$ . Let  $d \notin \{a, b, c\}$  be a vertex of  $K_{1,2,2,2}$  connected to all three vertices  $a, b$  and  $c$ . There are  $n \geq 4$  vertices labelled  $d$  in the annular domain bounded by  $C$  and  $\Delta$ , and so at least one of them is not connected to any vertex of  $\Delta$ . Any such vertex of  $G$  (call it  $d'$ ), is connected to three vertices labelled  $a', b'$  and  $c'$  lying on  $C$ . These three vertices cannot form a 2-path on  $C$ , as otherwise the one in the middle would have no other edges of  $G$  incident to it, by (C). For each of the three domains into which the edges  $(d', a')$ ,  $(d', b')$  and  $(d', c')$  split the interior of  $C$ , consider the intersection of its boundary with  $C$ . That intersection is a path on  $C$ , and for at least two of the three domains, that path contains vertices labelled  $a, b$  or  $c$  of  $C$  other than its endpoints. Hence there is at least one domain with this property that does not contain  $\Delta$ . We now consider all domains constructed in this way (for different choices of  $d'$ ), and out of them, choose a domain  $D$  the intersection  $P$  of whose boundary with  $C$  is the shortest possible. By construction, the path  $P \subset C$  contains at least one vertex labelled  $a, b$  or  $c$  which is not one of its endpoints, which implies that  $D$  contains a vertex labelled  $d$ . As  $D$  does not contain  $\Delta$ , that vertex  $d$  is connected to three internal vertices labelled  $a, b$  and  $c$  of  $P$  hence creating a domain that subtends a shorter path of length greater than one; a contradiction.  $\square$

#### 4. SELECTING A PARTICULAR SUBGRAPH OF THE COVER

Assume that we have a cover  $G$  of  $K_{1,2,2,2}$  satisfying the conditions (A), (B), (C) and (D). We refer to 3-cycles in  $K_{2,2,2}$  as *octahedral* 3-cycles. Clearly, there must be at least one octahedral 3-cycle whose lift is not a union of 3-cycles in  $G$  (otherwise,  $G$  has an octahedron subgraph and condition (C) means that there are no other vertices). Among all long cycles covering an octahedral 3-cycle, choose a cycle  $C$  which contains no other such long cycle inside the closed domain that it bounds; call this interior domain  $F$ . Without loss of generality, we can assume that  $C$  covers the 3-cycle  $(1, 2, 3)$ . The domain  $F$  is not a face of  $G$  by condition (D). Furthermore,  $C$  contains no chords, and so there are vertices of  $G$  lying in  $F$ , and hence some vertices labelled  $0, -1, -2$  and  $-3$  lying in  $F$ .

In light of the preceding observations, we define  $H$  to be a connected component of the lift of the  $K_4$  subgraph on the vertices  $0, -1, -2$ , and  $-3$  lying inside the domain  $F$  that contains no other such component in its interior. Moreover, we define  $G'$  to be the semi-cover of  $K_{1,2,2,2}$  consisting of  $H$  and all the edges and vertices of  $G$  that lie in the internal faces of  $H$ .

**Lemma 4.** *The semi-cover  $G'$  of  $K_{1,2,2,2}$  and the subgraph  $H \subset G'$  have the following properties.*

- (a)  $H \subset G'$  is the lift of the subgraph  $K_4 \subset K_{1,2,2,2}$  whose vertices are  $0, -1, -2, -3$ ,  $H$  is connected, the restriction of the projection map to  $H$  is a (genuine) cover of  $K_4$ , and the outer boundary of  $G'$  is a cycle of  $H$ .
- (b) All 3-cycles of  $G'$  are facial.
- (c) Any cycle in  $G'$  covering an octahedral 3-cycle is a triangular face.

- (d) Every component of the lift of an octahedral 3-cycle in  $G'$  that is not a cycle is a path that starts and ends on the boundary of  $G'$ . Such a path cannot cover  $(1, 2, 3)$  or  $(-1, -2, -3)$ , so the lift of these triangles in  $G'$  consists only of triangles.
- (e)  $H$  is not isomorphic to  $K_4$ .
- (f)  $G'$  contains at least one triangle labelled  $(1, 2, 3)$ .
- (g)  $H$  is 2-connected, and so every internal face of  $H$  is homeomorphic to a disc.
- (h) The cyclic order of vertex labels around any non-triangular face of  $H$  is  $0, a_1, b_1, 0, a_2, b_2, \dots, 0, a_m, b_m$ , where  $a_i, b_i \in \{-1, -2, -3\}$ ; in particular, the length of any facial cycle is a multiple of 3.
- (i) No internal face of  $H$  is hexagonal.
- (j) If an internal face of  $H$  is  $3m$ -gonal, where  $m \geq 1$ , and contains  $t$  triangles labelled  $(1, 2, 3)$ , then  $t < \frac{2}{3}m$ .

*Proof.* Property (a) follows from the definition of  $H$ . Property (b) follows from (C). Properties (c) and (d) follow from the fact that the cycle  $C$  contains no long octahedral 3-cycle in its interior.  $H$  is not isomorphic to  $K_4$  (property (e)) because if it were, the middle vertex would be incident only to triangular faces of  $H$ , and thus no vertex labelled 1, 2 or 3. Property (f) holds because otherwise  $H$  would be an outerplanar cubic graph.

For property (g), assume that  $H$  contains a bridge  $(a, b)$ . Let  $H_1$  be the component of  $H$  that contains the vertex  $b$  of the bridge when  $(a, b)$  is deleted. Let  $m$  be the number of vertices  $c \neq a, b$  in  $H_1$ . Then  $H_1$  has exactly  $m$  vertices  $b$  and exactly  $m$  vertices  $a$ , which is a contradiction, as there is a vertex  $b$  in  $H_1$  not connected to any vertex  $a$  in  $H_1$ . Since  $H$  is 3-regular and contains no bridge it is 2-connected.

For property (h), assume a cycle  $C'$  bounds a face  $F'$  of  $H$ . If  $C'$  has length 3, then it bounds a triangular face by (C). Suppose the length of  $C'$  is at least 4. Then out of any three consecutive vertices along  $C'$  we must have at least one 0 (for if the vertices were  $-1, -2, -3$ , in this order, then there would be an edge  $(-2, 0)$  lying outside  $F'$  and inside the triangular face  $(-1, -2, -3)$ ). Clearly out of any three consecutive vertices along  $C'$  we cannot have more than one 0, which proves the claim.

For property (i), assume that  $F'$  is an internal hexagonal face. We say that an internal face of  $H$  is *empty* if it contains no vertices labelled 1, 2, or 3 inside it, and is *full* otherwise. By assertion (h), the cyclic order of vertex labels on its boundary  $C'$  is  $0, a_1, b_1, 0, a_2, b_2$ , where  $a_i, b_i \in \{-1, -2, -3\}$ . Moreover,  $\{a_1, a_2\} \cap \{b_1, b_2\} = \emptyset$ , so without loss of generality we can assume that  $a_1 = a_2 = -1$  and  $b_1 = -2$ . If  $b_2 = -2$ , then the face  $F'$  is empty (there is no  $-3$  vertex on  $C'$ ), and so it is a face of  $G$ , in contradiction with condition (D). Suppose  $b_2 = -3$ , so that the sequence of labels along  $C'$  is  $0, -1, -2, 0, -1, -3$ . First suppose that  $F'$  is full. Then  $F'$  contains exactly one triangle  $(1, 2, 3)$ , as there is only one  $-3$  on  $C'$  to connect to 1. Then the union of the two edges  $(1, -2)$  and  $(1, -3)$  splits  $F'$  into two pentagonal domains, and the two vertices 2 and 3 both lie in one of them. But then both vertices 2 and 3 are connected to each of the vertices  $0, -1$  on the boundary of this pentagonal domain which gives a crossing. Now assume  $F'$  is empty (and  $b_2$  is still  $-3$ ). We note that the face of  $H$  adjacent to the edge  $(-1, -2)$  from the opposite side of  $F'$  is a triangle  $(-1, -2, -3')$  (where we write  $-3'$  to indicate that this vertex is different from the vertex  $-3$  on  $C'$ ). If the face  $F''$  of  $H$



adjacent to the first edge  $(0, -1)$  in our sequence  $0, -1, -2, 0, -1, -3$  from the opposite side of  $F'$  is a triangle, then  $F''$  must be the triangle  $(0, -1, -3')$ , and so out of the three faces adjacent to the vertex  $-1$ , two are triangles, and the third is  $F'$ , which implies that  $F'$  must be full. It follows that  $F''$  is not a triangle. But then, as  $F'$  is empty, it must be a face of  $G$ , and so replacing two edges  $(0, -1)$  of  $C'$  by the two chords  $(0, -1)$  we increase the number of triangles in  $G$ , in contradiction with (B).

For property (j), let  $F'$  be such a face. Denote  $q_i$ ,  $i = 1, 2, 3$ , the number of labels  $(-i)$  on its boundary  $C'$ . We have  $q_1 + q_2 + q_3 = 2m$  and  $t \leq \min(q_1, q_2, q_3)$ . This immediately gives a non-strict inequality  $t \leq \frac{2}{3}m$ . Assuming there is an equality, we must necessarily have  $m = 3s$ , for some  $s \in \mathbb{N}$ , and then  $t = q_1 = q_2 = q_3 = 2s$ . But then every vertex labelled  $(-i)$  on  $C'$  is connected to vertices labelled  $j$  and  $k$ , both lying in  $F'$ , where  $\{i, j, k\} = \{1, 2, 3\}$ . This means that any cycle in the lift of any triangle  $(-i, j, k)$  of  $K_{1,2,2,2}$  which starts in  $F'$ , does not leave (the closure of)  $F'$ . So by property (c), any such lift is the union of triangles. Thus for example, any vertex  $-1$  on  $C'$  is connected to two vertices labelled 2 and 3 in  $F'$ , which are connected to each other and both connected to the same vertex labelled 1 lying in  $F'$ . So for any triangle  $\Delta = (1, 2, 3)$  lying in  $F'$ , there are vertices  $-1, -2, -3$  on  $C'$  each of which is connected to the corresponding pair of vertices of  $\Delta$ . Furthermore, each vertex of  $\Delta$  is connected to a vertex labelled 0 on  $C'$ ; these three 0 vertices alternate along  $C'$  with the above vertices  $-1, -2, -3$ . We denote  $T(\Delta)$  the union of all the edges of  $G$  connected to the vertices of a triangle  $\Delta = (1, 2, 3)$ . Choose one such triangle,  $\Delta_1$ , construct  $T(\Delta_1)$  as above and choose a path  $\gamma_1$  on  $C'$  between two 0 vertices of  $T(\Delta_1)$  and not containing the third 0 vertex of  $T(\Delta_1)$ . By property (h),  $\gamma_1$  contains at least two vertices of  $C'$  with non-zero labels, and so at least one such vertex not belonging to  $T(\Delta_1)$ . Then there exists a triangle  $\Delta_2 = (1, 2, 3)$  lying in  $F' \setminus T(\Delta_1)$  such that  $T(\Delta_2)$  contains that vertex and that all the six vertices of  $C' \cap T(\Delta_2)$  lie on  $\gamma_1$ . We can then choose a path  $\gamma_2 \subset C'$  between two 0 vertices of  $C' \cap T(\Delta_2)$  which is a proper sub-path of  $\gamma_1$ , and repeat the argument. As the cover is finite, we arrive at a contradiction.  $\square$

For the rest of the paper we consider a planar semi-cover  $G'$  of  $K_{1,2,2,2}$  and its subgraph  $H$  that satisfies the conditions listed in Lemma 4, and such that  $H$  has the smallest possible number of vertices (i.e. the smallest fold number as a cover of  $K_4$ ). Our overall aim is to show that such a semi-cover does not exist. In fact the following is a strengthening of Conjecture 1.

**Conjecture 2.** *There is no planar semi-cover  $G'$  of  $K_{1,2,2,2}$  having the properties listed in Lemma 4.*

## 5. BEADS AND NECKLACES

Consider the subgraph  $H$  of a semi-cover  $G'$  satisfying Lemma 4. Recall that it is a cover of  $K_4$  with vertices  $\{0, -1, -2, -3\}$  with all cycles that cover the triangle  $(-1, -2, -3)$  being triangular faces of  $G'$ .

The central argument in the proofs of non-existence of a planar cover for several graphs was based on the study of the ‘beads’ and their arrangements called the ‘necklaces’ [1]. In our setting, a *bead* is a labelled subgraph of  $H$  as shown on the left in Figure 2, where

$\{i, j, k\} = \{1, 2, 3\}$ . A maximal subgraph of  $H$  consisting of a sequence of beads, every two consecutive ones of which are connected by an edge, together with the two edges attached to the first and to the last bead is called a *string*, as in the middle in Figure 2, where  $k \in \{1, 2, 3\}$  (maximality means that the subgraph is not properly contained in any other such subgraph). Note that all the vertices of a string labelled  $-k$  are indeed forced to have the same label (we will say that the string has *type*  $-k$ ), while the labelling of other vertices may be different for different beads. We define a *necklace* as a cyclic string of beads. Our main aim in this section is to prove that  $H$  cannot be a necklace.

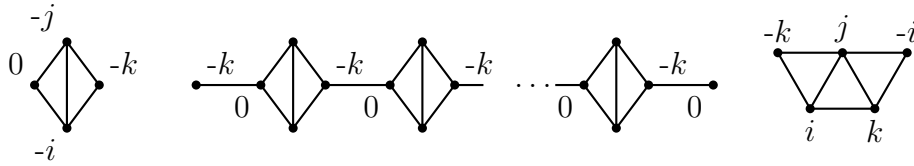

FIGURE 2. Left to right: a bead, a string (of type  $-k$ ) and a trapezium (of type  $j$ ).

We call the vertices  $-i$  and  $-j$  of the bead on the left in Figure 2 the *inner vertices*, and we say that a bead *lies* on the boundary of a face  $F$  of  $H$  if one of its inner vertices belongs to the boundary of  $F$ . Clearly, any inner vertex of a bead belongs to a single non-triangular face of  $H$  (which can be the external face  $F_e$ ), and it is not hard to see that two inner vertices of a bead must belong to the boundaries of two different non-triangular faces  $F'$  and  $F''$ ; in that case, we say that the faces  $F'$  and  $F''$  *share a bead*. It is also clear (and this is the most valuable property of a bead) that if an inner vertex  $-i$  of a bead lies on the boundary of a non-triangular face  $F$  of  $H$ , then both edges  $(-i, j)$  and  $(-i, k)$  of  $G'$  incident to that vertex, where  $\{i, j, k\} = \{1, 2, 3\}$ , go in the domain  $F$  (that is, lie in the closure of  $F$ ).

Suppose  $F$  is an internal, non-triangular face of  $H$  having a string  $s$  lying on its boundary. A triangle  $\Delta$  with the vertices  $(1, 2, 3)$  lying in  $F$  has nine edges of  $G'$  joining its vertices with some vertices on the boundary of  $F$  (because each vertex has degree 5). We call these vertices *vertices of attachment (of  $\Delta$ )*. We say that a triangle  $\Delta$  with the vertices  $(1, 2, 3)$  lying in  $F$  is *supported on the string  $s$* , if all its vertices of attachment lie on  $s$ . For a triangle  $\Delta$  supported on a string  $s$ , consider the union  $U_\Delta$  of the domains each of which is bounded by two edges between the vertices of  $\Delta$  and of  $s$ , a path on  $s$  between the corresponding vertices of attachment (and possibly an edge of  $\Delta$ ). If  $U_\Delta$  contains another triangle  $\Delta'$  with the vertices  $(1, 2, 3)$ , we write  $\Delta' \prec \Delta$ . Note that the triangle  $\Delta'$  is also supported on  $s$  and that the relation  $\prec$  is a strict partial order on the set of triangles  $(1, 2, 3)$  supported on  $s$ . We call a triangle  $\Delta$  supported on  $s$  *minimal*, if it is minimal relative to  $\prec$ .

In the following, given a string  $s$  (of type  $-k$ ,  $k \in \{1, 2, 3\}$ ) lying on the boundary of a face  $F$ , we refer to the direction on the path of  $s$  lying on the boundary of  $F$  from its endpoint labelled 0 to its other endpoint labelled  $-k$  as the direction “up” (so we think of  $s$  as being positioned vertically, as in Figure 3); in this sense, we will speak of a vertex



of  $s$  lying “above” another vertex of  $s$  or of the “top” and the “bottom” vertex of a set of vertices of that path.

We prove the following technical lemma first. We call a *trapezium (of type  $j$ )* a labelled subgraph of  $H$  shown on the right in Figure 2, where  $\{i, j, k\} = \{1, 2, 3\}$ .

**Lemma 5.** *Suppose  $F$  is an internal, non-triangular face of  $H$  having a string  $s$  of type  $-k$ ,  $k \in \{1, 2, 3\}$ , lying on its boundary.*

- (a) *Let  $(1, 2, 3)$  be a minimal triangle supported on the string  $s$  and lying in  $F$ . Then the triangle and the nine edges incident to its vertices are positioned as in one of the three cases given in Figure 3, where  $\{i, j, k\} = \{1, 2, 3\}$  (the three cases only differ by the positions of the two edges,  $(-k, i)$  and  $(0, j)$ ).*
- (b) *Given a non-empty set of triangles  $(1, 2, 3)$  lying in  $F$  and supported on the string  $s$ , consider the set  $A$  of all their vertices of attachment. Then the top vertex of  $A$  has label  $-k$  and the bottom vertex has label  $0$ .*
- (c) *Suppose a trapezium of type  $j$  (as on the right in Figure (2)) lies in the (closure of the) face  $F$ , with both vertices  $-k$  and  $-i$  lying on  $s$ , where  $\{i, j, k\} = \{1, 2, 3\}$ . Then the vertex  $-k$  of the trapezium lies above the vertex  $-i$  on the string  $s$ .*

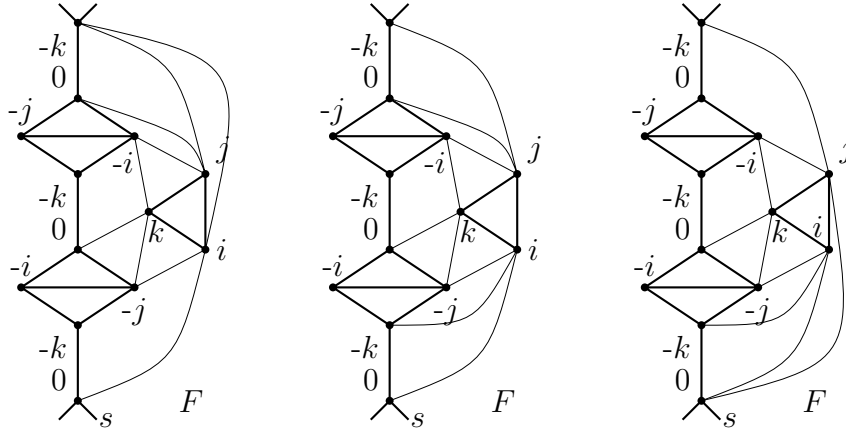

FIGURE 3. A minimal triangle  $(1, 2, 3)$  supported on the string  $s$ .

*Proof.* For assertion (a) we place the string  $s$  vertically and assume (up to reflection in the vertical axis) that the minimal triangle  $(1, 2, 3)$  supported on  $s$  lies in the domain  $F$  to the right of it, as in Figure 3. All the edges incident to the vertices of the triangle have their endpoints on  $s$ , and so lie on the path  $p$  of  $s$  between the bottom and the top vertices of attachment. The vertices  $-i$  and  $-j$  on  $p$  incident to the edges  $(k, -i)$  and  $(k, -j)$  must be the inner vertices of the beads of  $s$ , and moreover, the interior of  $p$  cannot contain any other inner vertices of the beads of  $s$ ; in particular, these two beads must be consecutive along  $s$ . Furthermore, both vertices  $i$  and  $j$  must lie outside the domain bounded by the two edges  $(k, -i)$  and  $(k, -j)$  and the segment of  $p$  between the vertices  $-i$  and  $-j$  (for otherwise we will not be able to connect both  $i$  and  $j$  to both  $0$  and  $-k$  within that domain). Then the path  $p$  has to contain at least one vertex  $0$  of  $s$

lying below both  $-i$  and  $-j$ , and at least one vertex  $-k$  of  $s$  lying above both  $-i$  and  $-j$ . This forces the position of the edges  $(-i, j)$  and  $(-j, i)$ , and also of the edge  $(k, 0)$ . Then using the fact that  $p$  can have no other interior vertices of the beads of  $s$  in its interior, it is easy to see that all the other edges except for two are forced. We arrive at one of the three cases shown in Figure 3 which only differ by the positions of the edges  $(-k, i)$  and  $(0, j)$ . Note that the proof depends only on the structure of the part of  $G'$  lying in (the closure of)  $F$  and not on the rest of  $G'$ .

To prove assertion (b) it suffices to consider a set consisting of a single triangle  $\Delta$  supported on  $s$ . Denote  $\Delta_{\succeq}$  the set consisting of the triangle  $\Delta$  and all the triangles  $\Delta' \prec \Delta$ . All the triangles in the set  $\Delta_{\succeq}$  lie in  $F$  and are supported on  $s$ , and moreover, the top and the bottom attachment points of the set  $\Delta_{\succeq}$  are the same as those for the triangle  $\Delta$ . Let  $m$  be the cardinality of the set  $\Delta_{\succeq}$ . If  $m = 1$ , then  $\Delta$  is minimal, and the claim follows from assertion (a). If  $m > 1$ , choose a minimal triangle  $\Delta' \in \Delta_{\succeq}$ . Since  $\Delta' \prec \Delta$ , its top (respectively, bottom) attachment point either coincides or lies below (respectively, above) the top (respectively, the bottom) attachment point of  $\Delta$ . We now remove from  $F$  the minimal triangle  $\Delta' \in \Delta_{\succeq}$ , together with all the edges connected to its vertices, and replace the part of the string  $s$  between the bottom attachment vertex 0 and the top attachment vertex  $-k$  of  $\Delta'$  with a single edge  $(0, -k)$  (refer to Figure 3). This gives a set  $\Delta_{\succeq}$  of cardinality  $m - 1$ , with the same top and bottom points of attachment (note that performing this surgery may violate the property of  $G'$  to be a semi-cover, as there may be edges attached to  $s$  “from the other side of  $F$ ”; however, as the proof of assertion (a) only depends on the structure of the part of  $G'$  lying in  $F$  and not on the rest of  $G'$ , the inductive argument works).

For assertion (c), we suppose to the contrary that the vertex  $-k$  of the trapezium lies below the vertex  $-i$  on the string  $s$ . Denote  $p$  the path of  $s$  lying on the boundary of  $F$  between these vertices  $-i$  and  $-k$ , and let  $p'$  be the one of the two paths  $(-i, k, i, -k)$  and  $(-i, j, -k)$  lying on the trapezium which lies “closer” to  $s$  (so that the domain  $F'$  bounded by  $p \cup p'$  contains no vertices of the trapezium inside). First suppose that  $p' = (-i, j, -k)$ . Then the (interior of the) edge  $(j, 0')$  lies in  $F'$ , with  $0'$  being an inner vertex of the path  $p$ . Consider the vertex  $v$  of  $s$  lying on the boundary of  $F$  immediately below the vertex  $0'$ . It is labelled  $-i$  or  $-j$ , is still an inner vertex of  $p$  and is the inner vertex of a bead. Therefore  $v$  must be connected to a vertex labelled  $k$  lying in the subdomain of  $F'$  bounded by the path  $(-k, 0')$  of  $p$  and the two edges  $(j, 0')$  and  $(j, -k)$ . That vertex  $k$  belongs to some triangle  $(1, 2, 3)$  lying in  $F'$  and supported on  $s$ . But then the top vertex of attachment of that triangle is either  $0'$  or  $v \neq -k$ , in contradiction with assertion (b). Now suppose that  $p' = (-i, k, i, -k)$ , and let  $v$  be the vertex of  $p$  lying immediately above  $-k$ . Then  $v$  is labelled  $-i$  or  $-j$ , is still an inner vertex of  $p$  (as  $p$  must contain more than one edge) and is the inner vertex of a bead. If  $v$  is connected to a vertex of some triangle  $(1, 2, 3)$  other than the triangle belonging to our trapezium, then that triangle is supported on  $s$ , with the bottom vertex of attachment being  $v \neq 0$ , which again contradicts assertion (b). So the vertex  $v$  has label  $-j$  and is connected to the vertices  $i$  and  $k$  on the path  $p'$ . But this is again a contradiction, as we cannot connect  $i$  to any vertex labelled 0.  $\square$

From Lemma 5 we obtain the following immediate corollary.

**Corollary 2.** *Let  $G'$  be a semi-cover satisfying the conditions of Lemma 4.*

- (a) *If  $G'$  is minimal among all such semi-covers (so that  $H$  as the cover of  $K_4$  has the smallest fold) and  $s$  is a string shared by an internal face  $F$  and the external face  $F_e$  of  $H$ , then no triangle  $(1, 2, 3)$  lying in  $F$  can be supported on  $s$ .*
- (b) *The graph  $H$  cannot be a necklace (that is, cannot have only one internal, non-triangular face).*

*Proof.* Assertion (a) follows from the argument similar to the one in the proof of assertion (b) of Lemma 5. Assuming that an internal face  $F$  of  $H$  and the external face  $F_e$  share a string and that a triangle  $\Delta$  with the vertices  $(1, 2, 3)$  lies in  $F$  and is supported on  $s$ , we can find a minimal triangle  $\Delta' \preceq \Delta$  lying in  $F$  and supported on  $s$ . Then removing from  $G'$  the triangle  $\Delta'$ , together with all the edges connected to its vertices, and replacing the part of the string  $s$  between the bottom attachment vertex  $0$  and the top attachment vertex  $-k$  of  $\Delta'$  with a single edge  $(0, -k)$  (refer to Figure 3) we arrive at a semi-cover which still satisfies conditions conditions of Lemma 4 and which has a smaller  $H$ .

Assertion (b) follows by the same argument if we start with a smallest necklace and note that the removal procedure described in the previous paragraph results in a semi-cover for which  $H$  is still a necklace.  $\square$

## 6. THE GRAPH $H$ WITH TWO INTERNAL NON-TRIANGULAR FACES

In this section, we strengthen Corollary 2(b) to the case of the subgraph  $H$  having two internal, non-triangular faces.

**Proposition 1.** *There is no semi-cover  $G'$  satisfying the conditions of Lemma 4 such that  $H$  has exactly two internal, non-triangular faces.*

*Proof.* Arguing by contradiction, we assume that such a semi-cover exists and then choose  $G'$  to be minimal among all such semi-covers (so that  $H$  as the cover of  $K_4$  has the smallest fold).

Our starting point, the drawing of  $H$  (with some labels) is as the one shown in Figure 4. It consists of three strings joining the vertex  $0'$  (at the bottom in Figure 4) with the vertices of the triangle  $(-1', -2', -3')$  (on the top). We call  $l$  (respectively,  $r$ ) the string shared by  $F_1$  (respectively,  $F_2$ ) and  $F_e$ , and we call  $s$  the sting shared by  $F_1$  and  $F_2$ .

We first note that no triangle  $(1, 2, 3)$  lying in the face  $F_1$  (respectively, in the face  $F_2$ ) can be supported on the string  $l$  (respectively, on the string  $r$ ). This follows from Corollary 2(a) (more precisely, from its proof, as the removal procedure described there results in a smaller semi-cover still having two internal, non-triangular faces).

Moreover, regardless of the labelling of individual beads in Figure 4, the face  $F_1$  lies in the inner domains bounded by a cycle of  $H$  with vertices  $0, -1, -3$  and by a cycle of  $H$  with vertices  $0, -1, -2$ . By Lemma 4(d), all the paths  $(-3, 1, 2)$  and  $(-2, 1, 3)$  in the closure of  $F_1$  lie on the corresponding triangles. As by Lemma 4(b), the cycles of  $G'$  covering the cycle  $(1, 2, 3)$  are also triangles, we obtain that every triangle  $(1, 2, 3)$  lying in  $F_1$  is a subgraph of a trapezium of type 1 (see Figure 2), with both vertices  $-2$  and

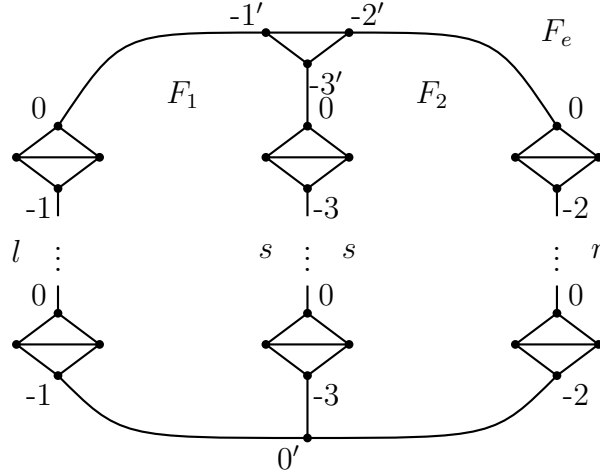

FIGURE 4.  $H$  has two internal, non-triangular faces  $F_1$  and  $F_2$ .

$-3$  lying on the boundary of  $F_1$ . A similar argument shows that every triangle  $(1, 2, 3)$  lying in  $F_2$  is a subgraph of a trapezium of type 2, with the vertices  $-1$  and  $-3$  lying on the boundary of  $F_2$ .

Consider the vertex  $-3$  of  $s$  lying immediately above the vertex  $0'$  (in the notation of Figure 4). Without loss of generality we can assume that it is a vertex of a trapezium  $T$  of type 2 lying in (the closure of) the face  $F_2$ , with the vertices  $-3$  and  $-1$  lying on the boundary of  $F_2$ . From Lemma 5(c) it follows that the vertex  $-1$  of  $T$  lies on the string  $r$ . If there is at least one inner vertex of a bead in the interior of the path of  $r$  lying on the boundary of  $F_2$  and joining  $0'$  to the vertex  $-1$  of  $T$ , then that vertex is connected to vertices labelled 2 and  $i \in \{1, 3\}$ , of which at least one does not belong to  $T$ , and hence lies on a triangle  $(1, 2, 3)$  which then must be supported on  $r$ , a contradiction. It follows that the trapezium  $T$  is positioned as shown in Figure 5, with the edge  $(2, 0')$  forced (clearly the path  $(-3, 1, 3, -1)$  of the trapezium cannot lie below the path  $(-3, 2, -1)$  for we need to connect each of the vertices  $1, 3$  to each of the vertices  $0', -2$ ).

Consider the edge  $(1, 0)$ . First suppose that its endpoint 0 lies on the string  $r$ . This cannot be the bottom vertex 0 on  $r$  lying above the vertex  $-1$  of  $T$ , as we need an edge  $(3, -2)$ . If this is any other vertex labelled 0 of  $r$ , then the path of  $r$  between it and the vertex  $-1$  of  $T$  contains at least one inner vertex of a bead. That vertex must be connected to a vertex labelled 2 which then is one of the vertices of a triangle  $(1, 2, 3)$  supported on  $r$ , which is again a contradiction. Thus the endpoint 0 of the edge  $(1, 0)$  lies on  $c$ . Let  $v$  be the vertex of  $c$  on the boundary of  $F_2$  lying immediately below that vertex 0. Then  $v$  is connected to a vertex labelled 3 which is not a vertex of  $T$ . Then this vertex 3 lies on a triangle  $(1, 2, 3)$  which is supported on  $s$  and whose top vertex of attachment to  $s$  is either 0 or  $v \neq -3$  which contradicts Lemma 5(b).  $\square$

Next we establish the following important property of the subgraph  $H$ .

**Proposition 2.** *There is no semi-cover  $G'$  satisfying the conditions of Lemma 4 in which two internal faces of  $H$  of length at most  $3m$  each ( $m \geq 3$ ) share  $m - 2$  beads.*

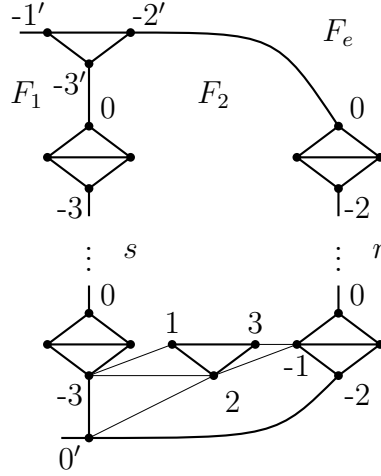

FIGURE 5. The trapezium lying in  $F_2$ .

For example, when  $m = 3$ , we obtain that two 9-faces of  $H$  cannot share a bead. Note that a face of length  $3l$ ,  $l \geq 3$ , cannot have more than  $l$  beads on its boundary, and if it has exactly  $l$ , we obtain a necklace which is not possible by Corollary 2(b). So the proposition effectively applies only when both faces are of length  $3m$ , or when one is of length  $3m$ , and another one, of length  $3(m - 1)$ .

During the proof we will use the following easy fact which, in the setting of Proposition 2, will strengthen Lemma 4(d).

**Remark 1.** For  $\{i, j, k\} = \{1, 2, 3\}$ , consider the components of the lift of  $(-i, j, k)$  that are paths in  $G'$ . By Lemma 4(d) these paths start and end on the boundary of  $G'$ , so their endpoints are distinct vertices with label  $-i$ . In particular, if the boundary of  $G'$  has one or zero vertices labelled  $-i$ , there are no such paths, and the lift consists of only triangular faces.

*Proof of Proposition 2.* Suppose to the contrary that two faces  $F_1$  and  $F_2$  of  $H$  of lengths  $3l_1$  and  $3l_2$  respectively, where  $l_1, l_2 \leq m$ , share  $m - 2$  beads. We can assume that  $l_1, l_2 \in \{m - 1, m\}$ . First prove that all the beads shared by  $F_1$  and  $F_2$  lie on a single string. The argument is easier seen if we consider the quotient  $H'$  of the graph  $H$  obtained by contracting every triangle  $(-1, -2, -3)$  to a single vertex. The resulting graph is again planar, and is cubic and bipartite, with beads projecting to double edges. For  $i = 1, 2$ , the face  $F_i$  of  $H$  projects to a face  $F'_i$  of  $H'$  of length  $2l_i$ . Then the faces  $F'_1$  and  $F'_2$  share  $m - 2$  double edges. Note that two pairs of double edges are vertex-disjoint (for there are no triple edges and the graph  $H'$  is cubic), so on the boundary of  $F'_i$ ,  $i = 1, 2$ , there are  $2l_i - 2(m - 2) \in \{2, 4\}$  vertices not incident to any double edges shared by  $F'_1$  and  $F'_2$ . Each of these vertices has a single edge incident to it and going to the outside of  $F'_i$ . Moreover, no such edge may border the other face  $F'_{3-i}$  on both of its sides (as  $H$  and hence  $H'$  are at least 2-edge connected). Now if  $l_i = m - 1$ , we have exactly two such edges, and then they must be incident to the two consecutive vertices of  $F'_i$  which implies that  $F'_1$  and  $F'_2$  share a path of length  $2l_i - 1 = 2m - 3$  having  $m - 2$

pairs of double edges (which lifts to a string of  $m - 2$  beads shared by  $F_1$  and  $F_2$  in  $H$ ). If  $l_1 = l_2 = m$ , then we have four such edges incident to four vertices on the boundary of  $F'_1$ . If these vertices are consecutive, we arrive at the same conclusion as above, and in all the other cases, the face  $F'_2$  appears to be longer than  $2m$ .

We first suppose that both faces are of length  $3m$ . Then our starting configuration, with some labelling, is as in Figure 6, with  $\{u_1, u_2\} = \{-1, -2\}$  and with  $\{v_1, v_2\} \subset \{-1, -2, -3\}$  such that  $v_1 \neq -1, u_1$  and  $v_2 \neq -2, u_2$ .

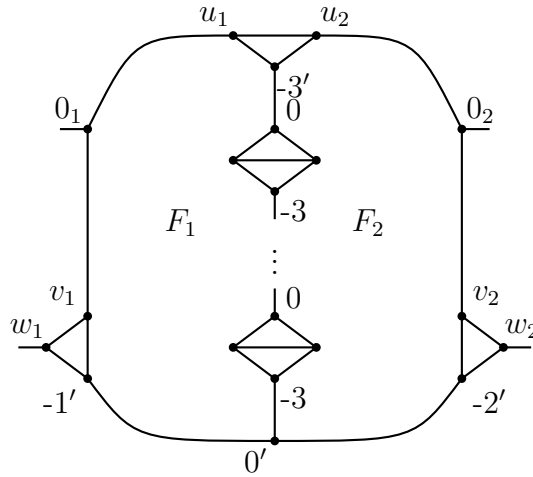

FIGURE 6. Two  $3m$ -faces  $F_1$  and  $F_2$  of  $H$  which share a string of  $m - 2$  beads.

Let  $a_i$  be the number triangles  $(1, 2, 3)$  lying in the face  $F_i$ ,  $i = 1, 2$ , and let  $b_1$  (respectively,  $b_2$ ) be the number of beads lying on the string which have vertex  $-1$  (respectively,  $-2$ ) on the boundary of  $F_1$ . Clearly,  $b_1 + b_2 = m - 2$ . There are  $m - 1$  vertices labelled  $-3$  on the string, which gives  $a_1 + a_2 \geq m - 1$ .

We consider two cases.

First suppose that  $u_1 = -2$ ,  $u_2 = -1$ . Then  $v_1 = v_2 = -3$  and each of the faces  $F_1, F_2$  has a single vertex labelled  $-1$  and a single vertex labelled  $-2$  on its boundary which is not an inner vertex of a bead. By Remark 1 we obtain that all the paths  $(-1, 2, 3)$  and  $(-2, 1, 3)$  lying in the closure of  $F_1 \cup F_2$  lie on the corresponding triangles. In particular, for each of the vertices  $-1', u_1$  (respectively,  $-2', u_2$ ), the pair of edges which connect them to the vertices of the triangles  $(1, 2, 3)$  lies either entirely inside or entirely outside the domain  $F_1$  (respectively,  $F_2$ ).

Suppose that both pairs of edges  $(-1', 2), (-1', 3)$  and  $(u_1, 1), (u_1, 3)$  go in  $F_1$ . We can then construct a necklace as follows: we retain the string, the part of  $G'$  lying in  $F_1$ , the triangles  $(-3', u_1, u_2)$  and  $(-1', v_1, w_1)$  (recall that  $u_1 = w_1 = -2$ ,  $u_2 = -1$ ,  $v_1 = -3$ ), draw the new edges  $(0', w_1)$  and  $(0_1, u_2)$ , and remove everything else from  $G'$ . This gives the drawing as on the left in Figure 7 (with  $u_1 = -2$ ,  $u_2 = -1$ ) leading to a contradiction with Corollary 2(b). Obviously, a similar argument applies when both pairs of edges  $(-2', 1), (-2', 3)$  and  $(u_2, 2), (u_2, 3)$  go in  $F_2$ .



Next suppose that both pairs of edges  $(-1', 2), (-1', 3)$  and  $(u_1, 1), (u_1, 3)$  go out of  $F_1$ . Counting the edges  $(-1, 3)$  and  $(-2, 3)$  in  $F_1$  we obtain  $a_1 = b_1 = b_2$ , and so  $m = b_1 + b_2 = 2a_1$ . Counting the edges  $(-3, 1)$  incident to the vertices  $-3$  lying on the string we obtain  $a_1 + a_2 \geq m + 1$  which gives  $a_2 \geq a_1 + 1$ . Then counting the edges  $(-1, 3)$  and  $(-2, 3)$  in  $F_2$  we obtain that  $a_2 = a_1 + 1$  and that both pairs of edges  $(-2', 1), (-2', 3)$  and  $(u_2, 2), (u_2, 3)$  must go in  $F_2$  which reduces this case to the one above.

Now suppose that the edges  $(u_1, 1), (u_1, 3)$  go in  $F_1$ , and the edges  $(-1', 2), (-1', 3)$  go out. The count similar to the above gives  $a_1 = b_1 = b_2 + 1$ ,  $m = 2a_1 - 1$ . There are  $m + 1 = 2a_1$  vertices labelled  $-3$  on the string; counting the edges  $(-3, 1)$  incident to them we get  $a_2 \geq a_1$ . Moreover, there are  $b_2 + 1 = a_1$  vertices labelled  $-1$  on the boundary of  $F_2$  which gives  $a_1 \geq a_2$ . We deduce that  $a_1 = a_2$ , and hence all the edges  $(-3, 1)$  and  $(-3, 2)$  lying in  $F_1 \cup F_2$  are incident to the vertices  $-3$  on the string. Then both edges  $(v_1, 1)$  and  $(v_1, 2)$  go out of  $F_1$  (recall that  $v_1 = -3$ ). Furthermore, we have  $m = 2a_1$  vertices labelled  $0$  on the string, not counting the vertex  $0'$ . As there are  $2a_1$  triangles  $(1, 2, 3)$  lying in  $F_1 \cup F_2$  in total, no two out of the three vertices  $0', 0_1$  and  $0_2$  can be connected to vertices lying in  $F_1 \cup F_2$  and having the same label  $i \in \{1, 2, 3\}$ . In particular, the set of labels  $i \in \{1, 2, 3\}$  such that the edge  $(0', i)$  lies in  $F_1$  and the set of labels  $j \in \{1, 2, 3\}$  such that the edge  $(0_1, j)$  lies in  $F_1$  are disjoint. We can now construct a necklace as follows: we retain the string, the part of  $G'$  lying in  $F_1$ , the triangles  $(-3', u_1, u_2)$ , remove the the triangle  $(-1', v_1, w_1)$ , identify  $0_1$  with  $0'$  and draw the new edge  $(0_1, u_2)$ , and then remove everything else from  $G'$ . The surgery is showing in the middle and on the right in Figure 7 (in the drawing, in the middle, each vertex  $0', 0_1$  has one edge lying in  $F_1$ ,  $(0', i)$  and  $(0_1, j)$  respectively; there can be more of such edges or there can be none, but in any case, all the endpoints of these edges have different labels). We arrive at a contradiction with Corollary 2(b).

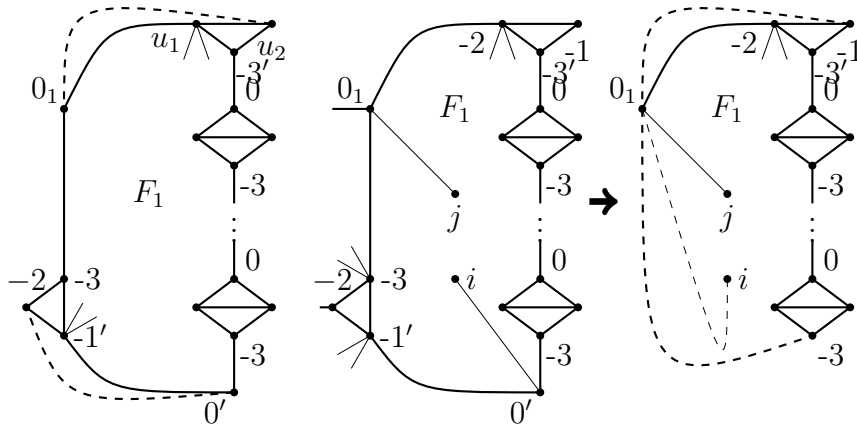

FIGURE 7. Constructing a necklace.

We now proceed to the second case:  $u_1 = -1, u_2 = -2$ .

First suppose that not all the paths  $(-3, 1, 2)$  lying in the closure of  $F_1 \cup F_2$  lie on the triangles  $(-3, 1, 2)$ . By Remark 1, we must necessarily have  $v_1 = v_2 = -3$ , and moreover, at one of these vertices, the edge  $(-3, 1)$  goes in  $F_1 \cup F_2$  and the edge  $(-3, 1)$  goes out, and

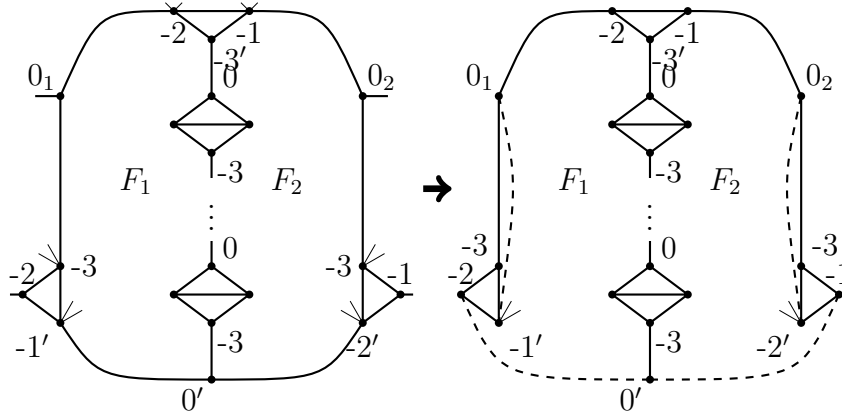

FIGURE 8. Constructing a semi-cover having two internal, non-triangular faces.

at the other one, they go opposite way. Counting the edges  $(-2, 1)$  in  $F_1$  and  $(-1, 2)$  in  $F_2$  we obtain  $a_1 = a_2 = b_2$ . Counting the edges  $(-3, 1)$  in  $F_1 \cup F_2$  we get  $a_1 + a_2 = m + 2$  which gives  $b_1 = a_1 - 2$ . It follows that there are exactly  $a_1$  vertices labelled  $-1$  on the boundary of  $F_1$ , and so all four edges  $(-1', 2)$ ,  $(-1', 3)$ ,  $(u_1, 2)$  and  $(u_1, 3)$  go in  $F_1$ . Performing the surgery as on the left in Figure 7 (with  $u_1 = -1$ ,  $u_2 = -2$ ) we obtain a necklace which is a contradiction with Corollary 2(b).

Now suppose that every path  $(-3, 1, 2)$  lying in the closure of  $F_1 \cup F_2$  lies on a triangle  $(-3, 1, 2)$ . By Remark 1 applied to  $U = F_1$  and  $i = 2$ , every path  $(-2, 1, 3)$  lying in the closure of  $F_1$  lies on a triangle  $(-2, 1, 3)$ , and similarly, every path  $(-1, 2, 3)$  lying in the closure of  $F_2$  lies on a triangle  $(-1, 2, 3)$ . It follows that every triangle  $(1, 2, 3)$  lying in  $F_i$ ,  $i = 1, 2$ , is a subgraph of a trapezium of type  $i$ , lying in the closure of  $F_i$ , with both vertices  $i - 3$  and  $-3$  of the trapezium lying on the boundary of  $F_i$ .

We now use a simplified version of the argument in the last two paragraphs of the proof of Proposition 1. Consider the vertex  $-3$  on the string lying immediately above the vertex  $0'$  (in the notation of Figure 6). Without loss of generality we can assume that it is a vertex of a trapezium  $T$  of type 2 lying in (the closure of) the face  $F_2$ , with the vertices  $-3$  and  $-1$  lying on the boundary of  $F_2$ . From Lemma 5(c) it follows that the vertex  $-1$  of  $T$  does not lie on the string, and so it can only be the vertex  $v_2$ . Then the path  $(-3, 1, -1, 3)$  of  $T$  lies above the paths  $(-3, 2, -1)$ , similar to how they are positioned in Figure 5 (for otherwise we cannot connect both vertices 1 and 3 of  $T$  to both  $0'$  and  $-2'$ ), with the edge  $(2, 0')$  forced. Then the vertex 1 of  $T$  cannot be connected to  $0_2$ , as we need an edge  $(3, -2)$ . Hence the vertex 1 of  $T$  is connected to a vertex 0 lying on the string. Consider the vertex  $v$  on the string lying on the boundary of  $F_2$  immediately below that vertex 0. Then  $v$  is connected to a vertex labelled 3 which is not a vertex of  $T$ . This vertex 3 lies on a triangle  $(1, 2, 3)$  which is supported on the string and whose top vertex of attachment to the string is either 0 or  $v \neq -3$  which contradicts Lemma 5(b). This completes the proof in the case when both  $F_1$  and  $F_2$  are of length  $3m$ .

Examining the above proof we can see that a contradiction is reached by considering only the part of  $G'$  lying in the closure of  $F_1 \cup F_2$ . Hence in the case when one of the faces  $F_i$ ,  $i = 1, 2$ , has length  $3m$  and another one,  $3(m - 1)$ , we can just add three vertices  $0, i, j$  to the boundary of the shorter face  $F_i$  (outside the string), assume that all the other edges of  $G'$  incident to these vertices go out of  $F_i$ , and repeat the above argument. It should be noted however that one *can* have  $m - 2$  beads on a boundary of a single face of length  $3(m - 1)$ : it is not hard to construct an example of a 9-face with two beads on its boundary and with a single triangle  $(1, 2, 3)$  inside.  $\square$

## 7. PROOF OF THEOREM 1

Recall that in the construction of the semi-cover  $G'$  in Section 4 we began with a cover  $G$  of  $K_{1,2,2,2}$  satisfying conditions (A), (B), (C) and (D). We then chose a long cycle  $C$  covering an octahedral 3-cycle that contained no other such cycle in its interior. The graph  $G'$  and its subgraph  $H$  were located inside the interior domain of  $C$ .

Note that in fact  $G$  must contain at least two such domains, one inside  $C$  and one outside. (To see this we could re-embed  $G$  with a face of  $G'$  as the outer face). The other may also be bounded by  $C$ , or may be bounded by another long cycle  $C'$  covering an octahedral 3-cycle. In any case, within each of these two domains there must be a planar semi-cover of  $K_{1,2,2,2}$  satisfying the conditions of Lemma 4, and these two semi-covers are disjoint. In each semi-cover there is a subgraph  $H$  covering a  $K_4$  subgraph of  $K_{1,2,2,2}$  that includes the vertex 0. Thus, if we show that  $H$  has fold number at least  $n$ , this implies  $G$  has fold number at least  $2n$ .

We can improve slightly on this bound by considering all long cycles in  $G$  that cover an octahedral 3-cycle. We will refer to such cycles as *long octahedral 3-cycles*. Firstly note that every vertex of  $G$  not labelled 0 lies on a long octahedral 3-cycle, otherwise it is surrounded by four short octahedral 3-cycles that induce a 4-cycle in its neighbourhood, and no neighbour labelled 0 can be present. So if  $G$  has fold number  $n$  we can immediately see that the total length of all long octahedral 3-cycles is at least  $6n$ . In fact, we can say that it is strictly greater than  $6n$  because inside a subcover  $G'$  satisfying Lemma 4 there must be long octahedral 3-cycles present that intersect the surrounding long octahedral 3-cycle  $C$  (otherwise  $C$  is not minimal). So there are certainly some vertices that lie in two long octahedral 3-cycles.

In the other direction, we can bound the total length of long octahedral 3-cycles from above as follows.

**Lemma 6.** *Suppose  $G$  has fold number  $n$  and every possible  $H$  satisfying Lemma 4 has fold number at least  $h$  and contains at least  $t$  triangles (with labels not appearing in  $H$ ) inside its internal faces. Then the set of long octahedral 3-cycles labelled  $i, j, k$  or  $-i, -j, -k$ , where  $\{|i|, |j|, |k|\} = \{1, 2, 3\}$ , has total length at most  $3(2n - 2h - 2t)$ . Thus the total length of all long octahedral 3-cycles is at most  $12(2n - 2h - 2t)$*

*Proof.* The set of long octahedral 3-cycles labelled either  $i, j, k$  or  $-i, -j, -k$  (which are pairwise disjoint) bounds at least two domains that contain a subcover satisfying Lemma 4.

The label 1 appears at least  $x + y$  times in these subcovers, for  $x, y \in \{h, t\}$ , and the label  $-1$  appears at least  $(h + t - x) + (h + t - y)$  times. So in total they appear at least  $2h + 2t$  times. Thus the remaining vertices labelled 1 or  $-1$  that are not in these two subcovers number at most  $2n - 2h - 2t$ . Hence the total length of long cycles labelled  $i, j, k$  or  $-i, -j, -k$  is at most  $3(2n - 2h - 2t)$ . Since there are four pairs of disjoint faces in the octahedron, the final claim follows.  $\square$

To complete the proof of Theorem 1, we will show that we can take the values  $h = 6$  and  $t = 3$  in Lemma 6. As observed above, this would immediately exclude the possibility that  $G$  has fold number less than 12. Now suppose  $G$  is a 12-fold cover. Then it has 72 octahedral vertices, and long octahedral 3-cycles with total length at most  $12(24 - 12 - 6) = 72$ , contradicting the observation that some vertex is in two such cycles.

When  $H$  is an  $h$  fold cover of  $K_4$  with  $3m$  vertices on the outer face, we have  $3h - 2m$  internal octahedral vertices. Each has two neighbours in a triangle labelled  $(1, 2, 3)$ , and each vertex in these triangles has two octahedral neighbours in  $H$ . So the number of such triangles is at least  $\lceil \frac{2(3h-2m)}{2 \cdot 3} \rceil = \lceil h - \frac{2m}{3} \rceil$ . When  $h = 6$ , this is at least 3 unless  $m = 6$ , in which case  $H$  is a necklace, contradicting Corollary 2(b). Thus we may take  $t = 3$  if  $h = 6$  in Lemma 6.

It remains to show that there can be no  $H$  subgraph satisfying Lemma 4 that has fold number  $h \leq 5$ .

By contracting all the triangles  $(-1, -2, -3)$  in  $H$  to single vertices and replacing strings of beads in  $H$  with edges, we obtain a graph  $H''$  which is connected, 3-regular, bipartite and planar. Note that  $H''$  may have double edges. If  $a$  is the number of 0 vertices in  $H''$  then there are  $2a$  vertices,  $3a$  edges and  $a + 2$  faces. It follows from Corollary 2(b) and Proposition 1 that  $H$  has at least three internal, non-triangular faces. This means that  $H''$  cannot be the graph with two vertices and three parallel edges, i.e.  $a \geq 2$ .

Let  $f_i$  be the number of  $i$ -faces in  $H''$ . Then the number of edges is  $3a = \frac{1}{2} \sum_i i f_i$  and by Euler's formula we have  $6 = 6a - 9a + 3 \sum_i f_i = 3 \sum_i f_i - \frac{1}{2} \sum_i i f_i$ . This implies that

$$(1) \quad 2f_2 + f_4 = 6 + f_8 + 2f_{10} + 3f_{12} + \dots$$

Let  $b$  be the number of beads in  $H$ , so the fold number is  $h = a + b$ . We know by Lemma 4(i) that every internal, non-triangular face of  $H$  has length at least 9. Thus any internal 2-face of  $H''$  must have at least 2 beads on its boundary, and any internal 4-face of  $H''$  needs one bead on its boundary. If the outer face is a 2-face it requires at least one bead, otherwise it corresponds to a non-facial 3-cycle in  $G$ , contradicting condition (C). Since a single bead lies on only two faces, these requirements allow us to estimate the number of beads by double counting. Moreover, it follows from Proposition 2 that two internal 2- or 4-faces of  $H''$  cannot share all their beads.

If  $f_2 = 0$  then  $f_4 \geq 6$  by (1) and thus  $a \geq 4$  (since the number of faces is  $a + 2$ ). There must be at least 5 internal 4-faces, and thus at least  $5/2$  beads, so  $h = a + b \geq 7$ .

If  $f_2 = 1$  then  $f_4 \geq 4$  by (1) and  $a \geq 3$ . If the 2-face is internal then there are at least 3 internal 4-faces, giving  $b \geq 5/2$ . If the 2-face is external, then there are at least 4 internal 4-faces and all faces require at least one bead, giving  $b \geq 5/2$ . Thus  $h \geq 6$ .

If  $f_2 \geq 3$  or  $f_2 = 2$  and the outer face is not a 2-face, then we have two internal 2-faces and thus at least 4 beads because 2-faces cannot share an edge, so  $h \geq 6$ .

Finally, suppose  $f_2 = 2$  and the outer face is a 2-face. Then we have at least 2 beads on the internal 2-face and another on the outer 2-face. If  $a = 2$  then  $f_4 = 2$  and  $H''$  is as shown in Figure 9. It can be seen that in this case 4 beads are required to satisfy the requirement (Proposition 2) that two internal faces do not share all their beads.

Thus in every case we have  $h \geq 6$ , completing the proof of Theorem 1.

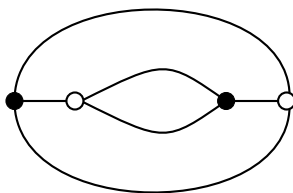

FIGURE 9.  $H''$  that requires 4 beads.

### REFERENCES

- [1] D. Archdeacon, *Two graphs without planar covers*, J. Graph Theory, **41**, 318-326 (2002).
- [2] D. Archdeacon, *A Kuratowski theorem for the projective plane*, J. Graph Theory **5**, 243-246 (1981).
- [3] D. Archdeacon, R. B. Richter, *On the parity of planar cover*, J. Graph Theory **14**, 199-204 (1990).
- [4] M. Fellows, *Encoding graphs in graphs*, Ph.D Dissertation, Univ. of California, San Diego (1985).
- [5] P. Hliněný,  *$K_{4,4} - e$  has no finite planar cover*, J. Graph Theory, **27**, 51-60 (1998).
- [6] P. Hliněný, *20 years of Negami's planar cover conjecture*, Graphs Combin. **26**, 525-536 (2010).
- [7] P. Hliněný, *Another two graphs having no planar cover*, J. Graph Theory **37**, 227-242 (2001).
- [8] S. Negami, *The spherical genus and virtually planar graphs*, Discrete Math. **70**, 159-168 (1988).
- [9] S. Negami, *Enumeration of projective-planar embeddings of graphs*, Discrete Math. **62**, 299-306 (1986).
- [10] S. Negami, *Graphs which have no finite planar covering*, Bull. of the Inst. of Math. Academia Sinica **16**, 378-384 (1988).
- [11] S. Negami, *Another approach to planar cover conjecture focusing on rotation systems*, J. Math. Soc. Japan, **76**(3), 975-96 (2024).
- [12] N. Takahashi, *On finite planar covering of  $K_{1,2,2,2}$*  (in Japanese), Mater's Thesis, Keio University, (2001).