

Decomposition space theory

Boldizsár Kalmár

1. Introduction

In these notes we give a brief introduction to decomposition theory and we summarize some classical and well-known results. The main question is that if a partitioning of a topological space (in other words a *decomposition*) is given, then what is the topology of the quotient space. The main result is that an *upper semi-continuous* decomposition yields a homeomorphic decomposition space if the decomposition is *shrinkable* (i.e. there exist self-homeomorphisms of the space which shrink the partitions into arbitrarily small sets in a controllable way). This is called *Bing shrinkability criterion* and it was introduced in [Bi52, Bi57]. It is applied in major 4-dimensional results: in the disk embedding theorem and in the proof of the 4-dimensional topological Poincaré conjecture [Fr82, FQ90, BKKPR]. It is extensively applied in constructing approximations of manifold embeddings in dimension ≥ 5 , see [AC79] and Edwards's cell-like approximation theorem [Ed78]. If a decomposition is shrinkable, then a decomposition element has to be *cell-like* and *cellular*. Also the quotient map is approximable by homeomorphisms. A cell-like map is a map where the point preimages are similar to points while a cellular map is a map where the point preimages can be approximated by balls. There is an essential difference between the two types of maps: ball approximations always give cell-like sets but in a smooth manifold for a cell-like set C the complement has to be simply connected in a nbhd of C in order to be cellular. Finding conditions for a decomposition to be shrinkable is one of the main goal of the theory. For example, cell-like decompositions are shrinkable if the non-singleton decomposition elements have codimension ≥ 3 , that is any maps of disks can be made disjoint from them [Ed16]. In many constructions Cantor sets (a set of uncountably many points that cutting out from the real line we are left with a manifold) arise as limits of sequences of sets defining the decomposition. The interesting fact is that a limit Cantor set can be non-standard and it can have properties very different from the usual middle-third Cantor set in $[0, 1]$. An example for such a non-standard Cantor set is given by Antoine's necklace but many other explicit constructions are studied

in the subsequent sections. The present notes will cover the following: upper semi-continuous decompositions, defining sequences, cellular and cell-like sets, examples like Whitehead continuum, Antoine's necklace and Bing decomposition, shrinkability criterion and near-homeomorphism, approximating by homeomorphisms and shrinking countable upper semi-continuous decompositions. We prove for example that every cell-like subset in a 2-dimensional manifold is cellular, that Antoine's necklace is a wild Cantor set, that in a complete metric space a usc decomposition is shrinkable if and only if the decomposition map is a near-homeomorphism and that every manifold has collared boundary.

2. Decompositions

A neighborhood (nbhd for short) of a subset A of a topological space X is an open subset of X which contains A .

DEFINITION 2.1. Let X be a topological space. A set $\mathcal{D} \subset \mathcal{P}(X)$ is a *decomposition* of X if the elements of \mathcal{D} are pairwise disjoint and $\bigcup \mathcal{D} = X$. An element of \mathcal{D} which consists of one single point is called a *singleton*. A non-singleton decomposition element is called *non-degenerate*. The elements of \mathcal{D} are the *decomposition elements*. The set of non-degenerate elements is denoted by $\mathcal{H}_{\mathcal{D}}$.

If $f: X \rightarrow Y$ is an arbitrary (not necessarily continuous) map between the topological spaces X and Y , then the set

$$\{f^{-1}(y) : y \in Y\}$$

is a decomposition of X . A decomposition defines an equivalence relation on X as usual, i.e. $a, b \in X$ are equivalent iff a and b are in the same element of \mathcal{D} .

DEFINITION 2.2. If \mathcal{D} is a decomposition of X , then the *decomposition space* $X_{\mathcal{D}}$ is the space \mathcal{D} with the following topology: the subset $U \subset \mathcal{D}$ is open exactly if $\pi^{-1}(U)$ is open. Here $\pi: X \rightarrow \mathcal{D}$ is the *decomposition map* which maps each $x \in X$ into its equivalence class.

In other words $X_{\mathcal{D}}$ is the quotient space with the quotient topology and

$$\pi: X \rightarrow X_{\mathcal{D}}$$

is just the quotient map. Recall that by well-known statements $X_{\mathcal{D}}$ is compact, connected and path-connected if X is compact, connected and path-connected, respectively. Obviously π is continuous.

PROPOSITION 2.3. *The decomposition space is a T_1 space if the decomposition elements are closed.*

PROOF. We have to show that the points in the space $X_{\mathcal{D}}$ are closed. If U is a point complement in $X_{\mathcal{D}}$, then $\pi^{-1}(U)$ is the complement of a decomposition element, which is open so U is also open. \square

We would like to construct and study such decompositions which have especially nice properties concerning the behavior of the sequences of decomposition elements.

DEFINITION 2.4. Let $f: X \rightarrow \mathbb{R}$ be a function. It is *upper semi-continuous* (resp. *lower semi-continuous*) if for every $x \in X$ and $\varepsilon > 0$ there is a nbhd V_x such that $f(V_x) \subset (-\infty, f(x) + \varepsilon)$ (resp. $f(V_x) \subset (f(x) - \varepsilon, \infty)$).

For us, upper semi-continuous functions will be important. They are such functions, where a sequence $f(x_n)$ can have only smaller or equal values than $f(x) + \varepsilon_n$ as $x_n \rightarrow x$, where $\varepsilon_n \geq 0$ and $\varepsilon_n \rightarrow 0$. Let $f: \mathbb{R} \rightarrow \mathbb{R}$ be an upper semi-continuous, positive function and consider the following decomposition of \mathbb{R}^2 . Take the vertical segments of the form

$$(2.1) \quad A_x = \{(x, y) : y \in [0, f(x)]\}$$

for each $x \in \mathbb{R}$. Together with the points in \mathbb{R}^2 which are not in these segments (these points are the so-called singletons) this gives a decomposition of \mathbb{R}^2 . This has an interesting property: let $y \in [0, f(x)]$ for some $x \in \mathbb{R}$ and let $(x_n) \in \mathbb{R}$ be a sequence (which is not necessarily convergent). If every nbhd of the point (x, y) intersects all but finitely many segments A_{x_n} , then the points $(u, v) \in \mathbb{R}^2$ each of whose nbhds intersects all but finitely many A_{x_n} are in A_x as well, see Figure 1. The set of the points (u, v) is called the *lower limit* of the sequence A_{x_n} . In other words, if an A_x intersects the lower limit of a sequence A_{x_n} , then all the lower limit is a subset of A_x . More generally we have the following.

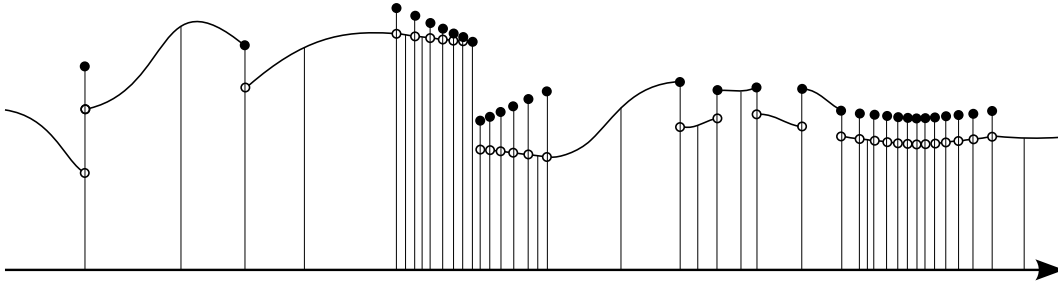

FIGURE 1. The graph of an upper semi-continuous function f and some segments A_x . If the segments A_{x_n} “converge” to a segment A_x , then $f(x_n)$ converges to a number $\leq f(x)$.

DEFINITION 2.5. Let A_n be a sequence of subsets of the space X . The *lower limit* of A_n is the set of the points $p \in X$ each of whose nbhds intersects all but finitely many A_n . It is denoted by $\liminf A_n$. The *upper limit* of A_n is the set of the points $p \in X$ each of whose nbhds intersects infinitely many A_n s. It is denoted by $\limsup A_n$.

Note that $\liminf A_n \subset \limsup A_n$ is always true. In the previous example the sets A_{x_n} could approach the set A_x only in a manner determined by the function f . This leads to the following general definition.

DEFINITION 2.6. Let \mathcal{D} be a decomposition of a space X such that all elements of \mathcal{D} are closed and compact and they can converge to each other only in the following way: if $A \in \mathcal{D}$, then for every nbhd U of A there is a nbhd V of A with the property $V \subset U$ such that if some element $B \in \mathcal{D}$ intersects V , then $B \subset U$, i.e. the set B is completely inside the nbhd U . Then \mathcal{D} is an *upper semi-continuous decomposition* (*usc decomposition* for short). If all the decomposition elements are closed but not necessarily compact, then we say it is a *closed upper semi-continuous decomposition*.

For example, the decomposition defined in (2.1) is usc.

LEMMA 2.7. *Let \mathcal{D} be a decomposition of the space X such that each decomposition element is closed. The following are equivalent:*

- (1) \mathcal{D} is a closed usc decomposition,
- (2) for every $D \in \mathcal{D}$ and every nbhd U of D there is a saturated nbhd $W \subset U$ of D , that is an open set W which is a union of decomposition elements,
- (3) for each open subset $U \subset X$, the set $\cup\{D \in \mathcal{D} : D \subset U\}$ is open,
- (4) for each closed subset $F \subset X$, the set $\cup\{D \in \mathcal{D} : D \cap F \neq \emptyset\}$ is closed,
- (5) the decomposition map $\pi : X \rightarrow X_{\mathcal{D}}$ is a closed map.

PROOF. Suppose \mathcal{D} is usc and U is a nbhd of D . Let W be the union of all decomposition elements which are subsets of U . Then $D \subset W$ obviously and W is open because if $x \in W$, then $x \in D'$ for some decomposition element $D' \subset W$ and $D' \subset U$, so by definition $D' \subset V \subset U$ for a nbhd V but the nbhd V of x is in W since all the decomposition elements intersecting V have to be in U , which means they are in W as well. This shows that (1) implies (2). Suppose (2) holds. If U is an open set, then for each decomposition element $D \subset U$ a saturated nbhd W of D is also in U and also in $\cup\{D \in \mathcal{D} : D \subset U\}$. This means that the set $\cup\{D \in \mathcal{D} : D \subset U\}$ is a union of open sets, which proves (3). We have that (3) and (4) are equivalent because we can take the complement of a given closed set F or an open set U . We have that (4) and (5) are equivalent: from (4) we can show (5) by taking an arbitrary closed set $F \subset X$, then $\cup\{D \in \mathcal{D} : D \cap F \neq \emptyset\}$ is closed, its complement is a saturated open set whose π -image is open so $\pi(F)$ is closed. If we suppose (5), then for a closed set $F \subset X$ the set

$$\pi^{-1}(\pi(F)) = \cup\{D \in \mathcal{D} : D \cap F \neq \emptyset\}$$

is closed so we get (4). Finally (3) implies (1): if $D \in \mathcal{D}$ and U is a nbhd of D , then let V be the open set $\cup\{D \in \mathcal{D} : D \subset U\}$, this is a nbhd of D , it is in U and if a $D' \in \mathcal{D}$ intersects V , then it is in V and hence also in U . \square

There is also the notion of *lower semi-continuous decomposition*: a decomposition \mathcal{D} of a metric space is lower semi-continuous if for every element $A \in \mathcal{D}$ and for every $\varepsilon > 0$ there is a nbhd V of A such that if some decomposition element B intersects V , then A is in the ε -nbhd of B . A decomposition of a metric space is *continuous* if it is upper and lower semi-continuous, see Figure 2. We will not study decompositions which are only lower semi-continuous.

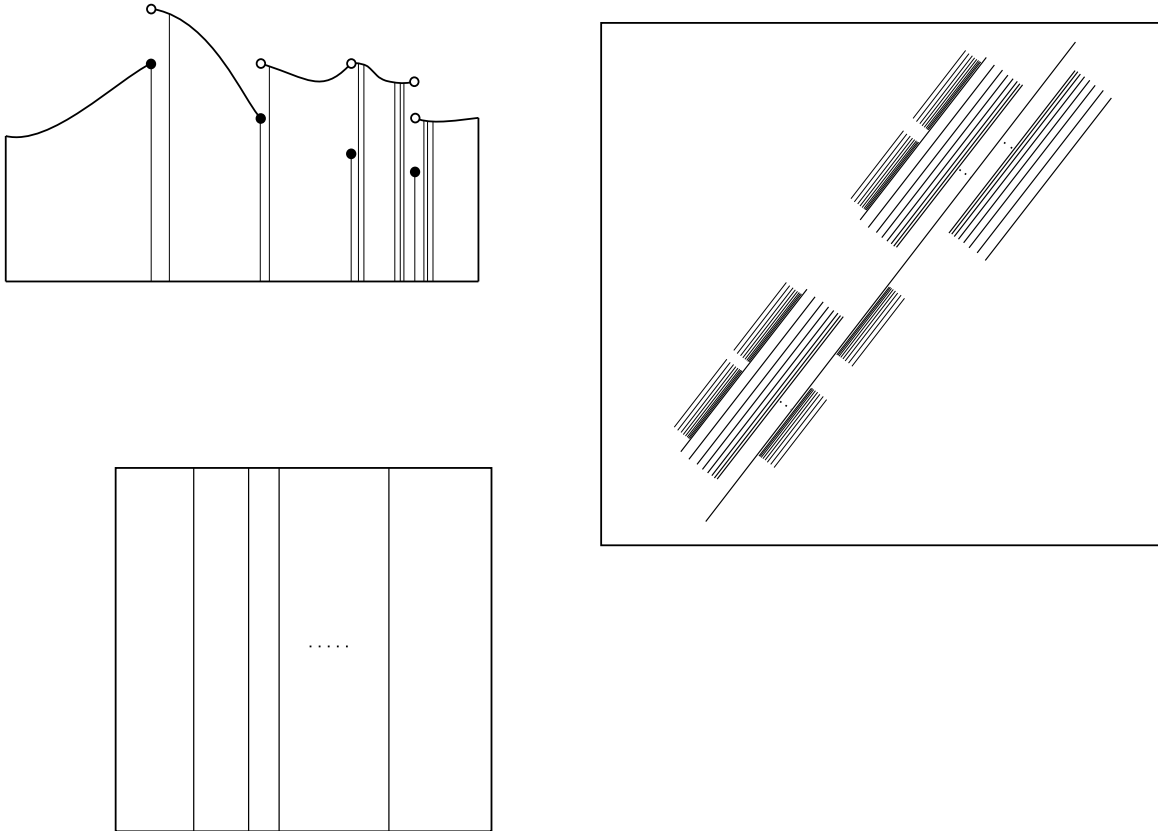

FIGURE 2. A lower semi-continuous, an upper semi-continuous and a continuous decomposition. In each of the cases the non-degenerate decomposition elements are line segments, which converge to other line segments. The dots indicate convergence. Only the non-singleton decomposition elements are sketched. The lower semi-continuous decomposition consists of decomposing the area under the graph of a lower semi-continuous function into vertical line segments, there are no singletons among the decomposition elements and the decomposed space itself is not closed. The upper semi-continuous and continuous decompositions are decompositions of the rectangle. Only the upper semi-continuous decomposition has singletons.

THEOREM 2.8. *Let X be a T_3 space and \mathcal{D} is a closed usc decomposition. If $A_n \in \mathcal{D}$ is a sequence of decomposition elements and $A \in \mathcal{D}$ are such that $A \cap \liminf A_n \neq \emptyset$, then $\limsup A_n \subset A$.*

PROOF. Suppose there is a point $x \in A$ such that $x \in \liminf A_n$ as well. By contradiction suppose that $\limsup A_n \not\subseteq A$, this means that a point $y \in \limsup A_n$ is such that $y \notin A$. Since $y \in D$ for a decomposition element, we get $D \neq A$ so D is disjoint from the decomposition element A . The space X is T_3 , the sets D and $\{x\}$ are closed so there is a nbhd U of D and a nbhd V of x which are disjoint from each other. We also have a nbhd $W \subset U$ of D which is a union of decomposition elements by Lemma 2.7. Since $x \in \liminf A_n$, we have that for an integer k the sets A_k, A_{k+1}, \dots intersect V . The nbhd W is saturated, this implies that a decomposition element does not intersect both of W and V . So A_k, A_{k+1}, \dots are disjoint from W . This contradicts to that W is a nbhd of y and so infinitely many A_n has to intersect W because $y \in \limsup A_n$. \square

An other example for a usc decomposition is the equivalence relation on S^n defined by $x \sim -x$. Here the decomposition elements are not connected and the decomposition space is the projective space $\mathbb{R}P^n$. Or another example is the closed usc decomposition of \mathbb{R}^2 , where the two non-singleton decomposition elements are the two arcs of the graph of the function $x \mapsto 1/x$, all the other decomposition elements are singletons. The decomposition space is homeomorphic to

$$A \cup_{\varphi} B \cup_{\psi} A',$$

where A and A' are open disks, each of them with one additional point in its frontier denoted by a and a' respectively. The space B is an open disk with two additional points b, b' in its frontier and the gluing homeomorphisms are $\varphi: \{a\} \rightarrow \{b\}$ and $\psi: \{a'\} \rightarrow \{b'\}$. If a decomposition is given, then we would like to understand the decomposition space as well.

PROPOSITION 2.9. *The decomposition space of a closed usc decomposition of a normal space is T_4 .*

PROOF. We have to show that if \mathcal{D} is a usc decomposition of a normal space X , then any two disjoint closed sets in the space $X_{\mathcal{D}}$ can be separated by open sets. Let A, B be disjoint closed sets in $X_{\mathcal{D}}$. Then $\pi^{-1}(A)$ and $\pi^{-1}(B)$ are disjoint closed sets and by being X normal and by Lemma 2.7 they have disjoint saturated nbhds U_1 and U_2 . Taking $\pi(U_1)$ and $\pi(U_2)$ we get disjoint nbhds of A and B . The decomposition elements are closed so $X_{\mathcal{D}}$ is T_1 , which finally implies that $X_{\mathcal{D}}$ is T_4 . \square

If a space X is not normal, then it is easy to define such closed usc decomposition, where the decomposition space is even not T_2 . Take two disjoint closed sets A, B in X which can not be separated by open sets. For example the direct product of the Sorgenfrey line with itself is not normal and choose the points with rational and irrational coordinates in the antidiagonal respectively, to have two closed sets A and B . These two sets are the two non-singleton elements of the decomposition \mathcal{D} , other elements are singletons. Then \mathcal{D} is closed usc but $X_{\mathcal{D}}$ is not T_2 because $\pi(A)$ and $\pi(B)$ can not be separated by open sets.

DEFINITION 2.10. Let \mathcal{D} be a decomposition of the space X . A decomposition is *finite* if it has only finitely many non-degenerate elements and *countable* if it has countably many non-degenerate elements. A decomposition is *monotone* if every decomposition element is connected. If X is a metric space, then a decomposition is *null* if the decomposition elements are bounded and for every $\varepsilon > 0$ there is only a finite number of elements whose diameter is greater than ε .

PROPOSITION 2.11. *Let \mathcal{D} be a decomposition and suppose that all elements are closed. If \mathcal{D} is finite, then it is a closed usc decomposition.*

PROOF. Let $C \subset X$ be a closed subset, then $\pi^{-1}(\pi(C))$ is closed because it is the finite union of the closed set C and the non-degenerate elements which intersect C . Then by Lemma 2.7 (4) the statement follows. \square

PROPOSITION 2.12. *If \mathcal{D} is a closed and null decomposition of a metric space, then it is usc.*

PROOF. Denote the metric by d . All the decomposition elements are compact because they are bounded. Let U be a nbhd of a $D \in \mathcal{D}$, then there is an $\varepsilon > 0$ such that the ε -nbhd of D is in U . Since \mathcal{D} is null, there are only finitely many decomposition elements D_1, \dots, D_n whose diameter is greater than $\varepsilon/4$ and $D_i \neq D$. Let δ be the minimum of $\varepsilon/4$ and the distances between D and the D_i s. If $D' \in \mathcal{D}$ is such that the distance between D' and D is less than δ , then D' is in the ε -nbhd of D : there are $x \in D$ and $y \in D'$ such that $d(x, y) < \delta$ so for every $a \in D'$

$$\inf\{d(a, b) : b \in D\} \leq d(a, y) + d(y, x) + \inf\{d(x, b) : b \in D\} = d(a, y) + d(y, x) \leq \text{diam } D' + \delta \leq \varepsilon/2,$$

which means that D' is in the ε -nbhd of D so $D' \subset U$. \square

PROPOSITION 2.13. *Let \mathcal{D} be a usc decomposition of a space X .*

- (1) *If X is T_2 , then $X_{\mathcal{D}}$ is T_2 as well.*
- (2) *If X is regular, then $X_{\mathcal{D}}$ is T_3 .*

PROOF. The decomposition elements are compact so every $\pi^{-1}(a)$ and $\pi^{-1}(b)$ for different $a, b \in X_{\mathcal{D}}$ can be separated by open sets. The statement follows easily. \square

PROPOSITION 2.14. *Let \mathcal{D} be a usc decomposition of a T_2 space X . The decomposition \mathcal{D}' whose elements are the connected components of the elements of \mathcal{D} is a monotone usc decomposition.*

PROOF. Take an element $D' \in \mathcal{D}'$ and denote by D the decomposition element in \mathcal{D} which contains D' . Suppose $D \neq D'$. Then $D - D'$ is closed in D so it is closed in X . Let U be a nbhd of D' . Then there exists a nbhd $U' \subset U$ of D' which

is disjoint from a nbhd U'' of the closed set $D - D'$. By the usc property we can find a nbhd V of D such that $V \subset U' \cup U''$ and if a $C \in \mathcal{D}$ intersects V , then $C \subset U' \cup U''$. If $C' \in \mathcal{D}'$ intersects $V \cap U'$, then the element $C \in \mathcal{D}$ which contains C' as a connected component intersects V hence $C \subset U' \cup U''$. Since U' and U'' are disjoint, the component C' of C is in U' because it intersects U' . We got that $C' \subset U$. \square

For example, it follows that the decomposition of a compact T_2 space X whose elements are the connected components of the space is a usc decomposition. To see this, at first take the decomposition \mathcal{D} , where $\mathcal{H}_{\mathcal{D}} = \{X\}$ and hence the decomposition has no singletons. This is usc so we can apply the previous proposition.

PROPOSITION 2.15. *If X is a metric space and \mathcal{D} is its usc decomposition, then $X_{\mathcal{D}}$ is metrizable. If X is separable, then $X_{\mathcal{D}}$ is also separable.*

PROOF. By [St56] if there is a continuous closed map f of a metric space onto a space Y such that for every $y \in Y$ the closed set $f^{-1}(y) - \text{int } f^{-1}(y)$ is compact, then Y is metrizable. But for every $y \in X_{\mathcal{D}}$ the set $\pi^{-1}(y)$ and so its closed subset $\pi^{-1}(y) - \text{int } \pi^{-1}(y)$ are compact hence $X_{\mathcal{D}}$ is metrizable. Moreover if X is separable, then there is a countable subset $S \subset X$ intersecting every open set, which gives the countable set $\pi(S)$ intersecting every open set in $X_{\mathcal{D}}$. \square

3. Examples and properties of decompositions

Usually, we are interested in the topology of the decomposition space if a decomposition of X is given. Especially those situations are stimulating where the decomposition space turns out to be homeomorphic to X .

Let $X = \mathbb{R}$ and let \mathcal{D} be a decomposition such that $\mathcal{H}_{\mathcal{D}}$ consists of countably many disjoint compact intervals. Then this is a usc decomposition: any open interval $U \subset \mathbb{R}$ contains at most countably many compact intervals of $\mathcal{H}_{\mathcal{D}}$ and the infimum of the left endpoints of these intervals could be in U or it could be the left boundary point of U . Similarly, we have this for the right endpoints. In all cases the union of the decomposition elements being in U is open. For an arbitrary open set $U \subset \mathbb{R}$ we have the same, this means we have a usc decomposition. Later we will see, that the decomposition space $X_{\mathcal{D}}$ is homeomorphic to \mathbb{R} . Moreover the decomposition map $\pi: X \rightarrow X_{\mathcal{D}}$ is approximable by homeomorphisms, which means there are homeomorphisms from \mathbb{R} to \mathbb{R} arbitrarily close to π in the sense of uniform metric. For example, let $X = \mathbb{R}$ and consider the infinite Cantor set-like construction by taking iteratively the middle third compact intervals in the interval $[0, 1]$. These are countably many intervals and define the decomposition \mathcal{D} so that the non-degenerate elements are these intervals. We can obtain this decomposition \mathcal{D} by

taking the connected components of $[0, 1] - \text{Cantor set}$ and then taking the closure of them. This is usc and we will see that the decomposition space is \mathbb{R} .

If $X = \mathbb{R}^2$, then an analogous decomposition is that $\mathcal{H}_{\mathcal{D}}$ consists of countably many compact line segments. More generally, let $\mathcal{H}_{\mathcal{D}}$ be countably many *flat arcs*, that is such subsets A of \mathbb{R}^2 for which there exist self-homeomorphisms h_A of \mathbb{R}^2 mapping A into the standard compact interval $\{(x, 0) \in \mathbb{R}^2 : 0 \leq x \leq 1\}$. Such a decomposition is not necessarily usc, for example take the function $f: [0, 1] \rightarrow \mathbb{R}$, $f(x) = 1 + x$, and the sequence $x_n = 1 - 1/n$. Define the decomposition by $\mathcal{H}_{\mathcal{D}} = \{(x_n, y) : y \in [0, f(x_n)], n \in \mathbb{N}\}$ and the singletons are all the other points of \mathbb{R}^2 . Then $\mathcal{H}_{\mathcal{D}}$ consists of countably many straight line segments but this decomposition is not usc: consider the point $(1, 3/2) \in \mathcal{D}$ and its ε -nbhds for small $\varepsilon > 0$. These intersect infinitely many non-degenerate decomposition elements but none of the elements is a subset of any of these ε -nbhds. The decomposition space is not T_2 : the points $\pi((1, y))$, where $0 \leq y \leq 2$, cannot be separated by disjoint nbhds because the sequence $\pi((x_n, 0))$ converges to all of them.

However, if \mathcal{D} is such a decomposition of \mathbb{R}^2 that $\mathcal{H}_{\mathcal{D}}$ consists of countably many flat arcs and further we suppose that \mathcal{D} is usc, then the decomposition space $X_{\mathcal{D}}$ is homeomorphic to \mathbb{R}^2 and again π can be approximated by homeomorphisms, we will see this later.

We get another interesting example by taking a smooth function with finitely many critical values on a closed manifold M . Then the decomposition elements are defined to be the connected components of the point preimages of the function. This is a monotone decomposition \mathcal{D} and it is usc because the decomposition map $\pi: M \rightarrow M_{\mathcal{D}}$ is a closed map: in M a closed set is compact, its π -image is compact as well and $M_{\mathcal{D}}$ is T_2 because it is a graph [Iz88, Re46, Sa20] so this π -image is also closed.

If X is 3-dimensional, then the possibilities increase tremendously. This is illustrated by the following surprising statement.

PROPOSITION 3.1. *For every compact metric space Y there exists a monotone usc decomposition of the compact ball D^3 such that Y can be embedded into the decomposition space.*

PROOF. Recall that by the Alexandroff-Hausdorff theorem the Cantor set in the $[0, 1]$ interval can be mapped surjectively and continuously onto every compact metric space. Let T be a tetrahedron in D^3 , denote two of its non-intersecting edges by e and f . Identify these edges linearly with $[0, 1]$ and let C_1 and C_2 be the Cantor sets in e and f , respectively. For $i = 1, 2$ denote the existing surjective maps of C_i onto Y by $\psi_i: C_i \rightarrow Y$. For every $x \in Y$ take the union of all the line segments in T connecting all the points of $\psi_1^{-1}(x)$ to all the points of $\psi_2^{-1}(x)$. Denote this subset of T by D_x , see Figure 3. They are compact and connected for all $x \in Y$ and they are pairwise disjoint because all the lines in T connecting points

of e and f are pairwise disjoint. So we have a monotone usc decomposition with $\mathcal{H}_{\mathcal{D}} = \{D_x : x \in Y\}$. Define the embedding i of Y into $D_{\mathcal{D}}^3$ by $i(x) = \pi(\psi_1^{-1}(x))$. This map is injective, closed because π is closed and continuous because ψ_1 is closed. \square

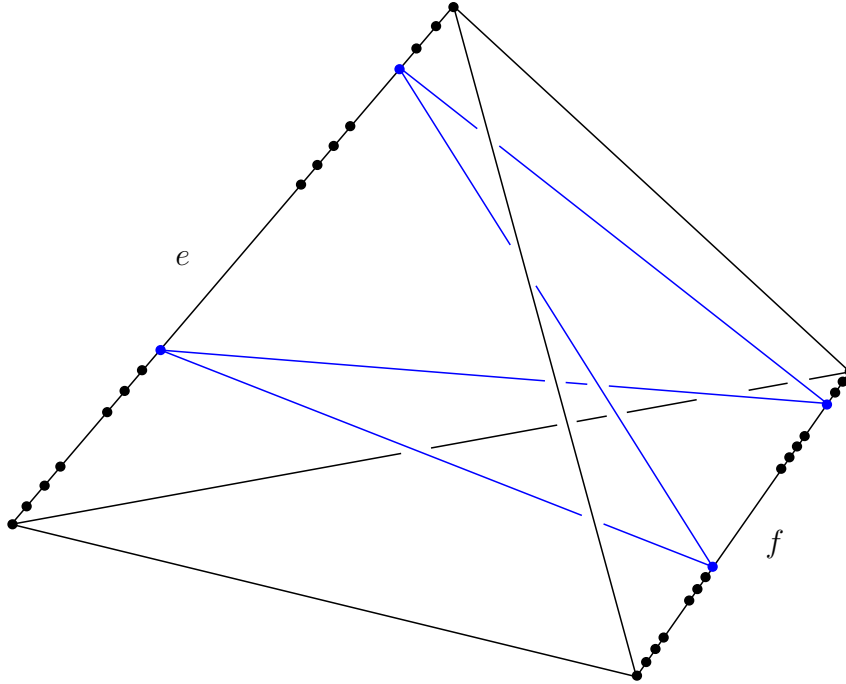

FIGURE 3. The tetrahedron T , the edges e and f and a set D_x pictured in blue.

To see further examples in \mathbb{R}^3 let us introduce some notions.

DEFINITION 3.2 (Defining sequence). Let X be a connected n -dimensional manifold. A *defining sequence* for a decomposition of X is a sequence

$$C_1, C_2, \dots, C_n, \dots$$

of compact n -dimensional submanifolds-with-boundary in X such that $C_{n+1} \subset \text{int } C_n$. The decomposition elements of the defined decomposition are the connected components of $\bigcap_{n=1}^{\infty} C_n$ and the other points of X are singletons.

Obviously a decomposition defined in this way is monotone. The set $\bigcap_{n=1}^{\infty} C_n$ is closed and compact so its connected components are closed and compact as well. Also the space $\bigcap_{n=1}^{\infty} C_n$ is T_2 hence its decomposition to its connected components is usc. Then adding all the points of $X - \bigcap_{n=1}^{\infty} C_n$ to this decomposition as singletons results our decomposition. This is usc: the only thing which is not completely obvious is that in a nbhd of an added point the conditions being usc are satisfied or not. But $\bigcap_{n=1}^{\infty} C_n$ is closed, its complement is open so every such singleton has a nbhd disjoint from $\bigcap_{n=1}^{\infty} C_n$.

PROPOSITION 3.3. *If all C_n in a defining sequence is connected, then $\bigcap_{n=1}^{\infty} C_n$ is connected.*

PROOF. Let C denote the non-empty set $\bigcap_{n=1}^{\infty} C_n$. Suppose C is not connected, this means there are disjoint closed non-empty subsets $A, B \subset C$ such that $A \cup B = C$. These A and B are closed in the ambient manifold X as well, so there exist disjoint nbhds U of A and V of B in X . It is enough to show that for some $n \in \mathbb{N}$ we have $C_n \subset U \cup V$, because then $C_n \cap U \neq \emptyset$, $C_n \cap V \neq \emptyset$ imply that C_n is not connected, which is a contradiction. If we suppose that for every $n \in \mathbb{N}$ we have $C_n \cap (X - (U \cup V)) \neq \emptyset$, then for every n we have $C_n \cap (X - U) \cap (X - V) \neq \emptyset$, i.e. the closed set $F = (X - U) \cap (X - V)$ and each element of the nested sequence C_1, C_2, \dots satisfy

$$C_n \cap F \neq \emptyset.$$

Of course

$$C_{n+1} \cap F \subset C_n \cap F$$

which implies that

$$F \cap C = F \cap (\bigcap_{n=1}^{\infty} C_n) = \bigcap_{n=1}^{\infty} (C_n \cap F) \neq \emptyset$$

because all $C_n \cap F$ is closed in the compact space C_1 . But $F \cap C \neq \emptyset$ contradicts to $C \subset U \cup V$. \square

The π -image of the union of non-degenerate elements of a decomposition associated to a defining sequence is closed and also totally disconnected because if $\bigcap_{n=1}^{\infty} C_n$ is not connected, then all the pairs of decomposition elements have disjoint saturated nbhds which yield disjoint nbhds of their π -image.

3.1. The Whitehead continuum. One of the most famous such decomposition is related to the so called Whitehead continuum. Its defining sequence consists of solid tori embedded into each other in such a way that C_{i+1} is a thickened Whitehead double of the center circle of C_i , see Figure 4. The intersection $\bigcap_{i=1}^{\infty} C_i$ is a compact subset of \mathbb{R}^3 , this is the Whitehead continuum, which we denote by \mathcal{W} . The decomposition consists of the connected components of \mathcal{W} and the singletons in the complement of them. If the diameters d_i of the meridians of the tori C_i converges to 0 as i goes to ∞ , then \mathcal{W} intersects the vertical sheet S in Figure 4 in a Cantor set: $C_i \cap S$ is equal to 2^{i-1} copies of disks of diameter d_i nested into each other. The intersection $S \cap (\bigcap_{i=1}^{\infty} C_i)$ is then a Cantor set. The Whitehead continuum \mathcal{W} is connected because the C_i tori are connected but it is not path-connected. We will see later that the decomposition space $\mathbb{R}_{\mathcal{W}}^3$ is not homeomorphic to \mathbb{R}^3 but taking its direct product with \mathbb{R} we get \mathbb{R}^4 . An important property of $\mathbb{R}^3 - \mathcal{W}$ is that it is a contractible 3-manifold, which is not homeomorphic to \mathbb{R}^3 .

For understanding further properties of this decomposition, we are going to define some notions.

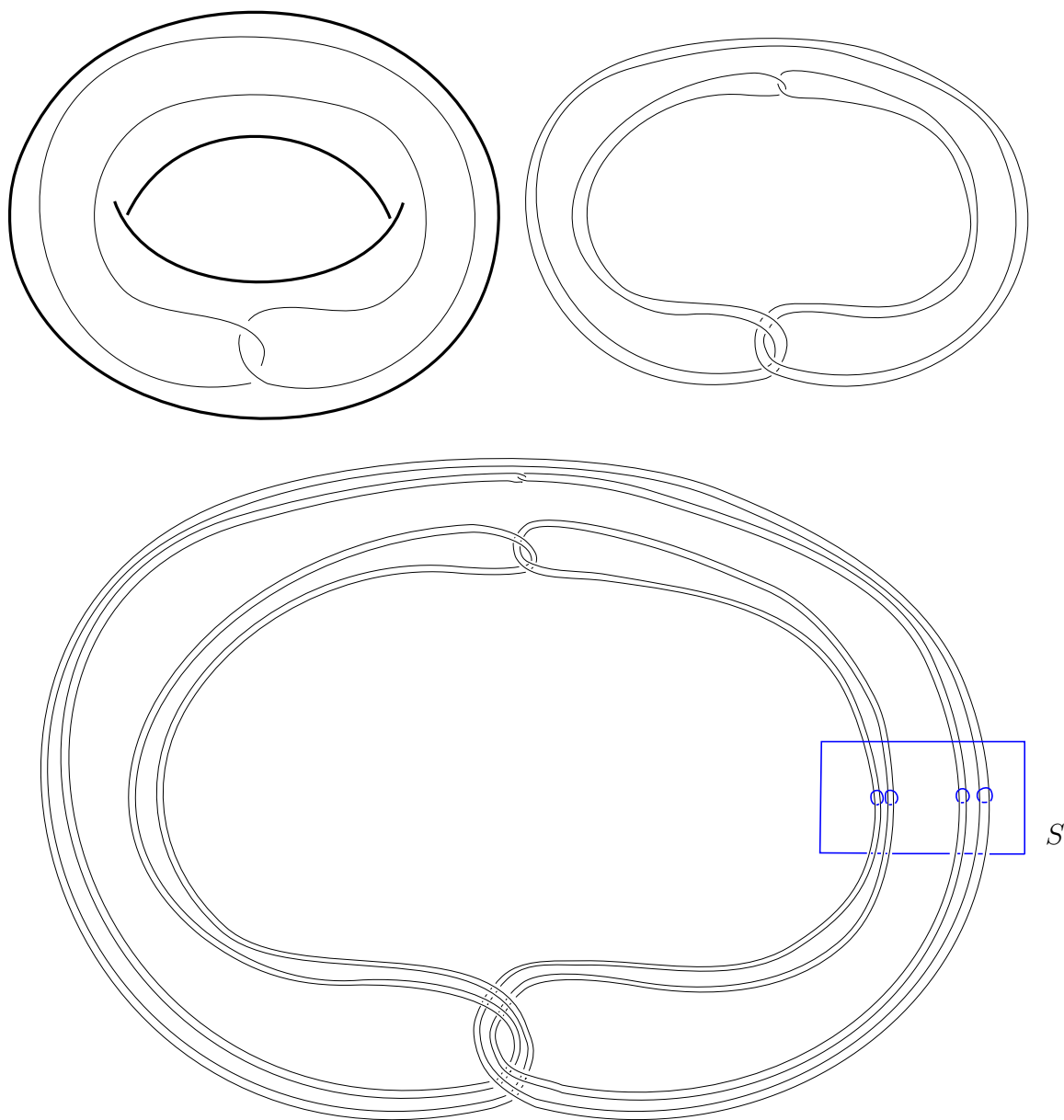

FIGURE 4. A sketch of the defining sequence of the Whitehead decomposition. The first figure shows the solid torus C_1 and the Whitehead double of its center circle. The second figure shows the Whitehead double of the center circle of C_2 . The torus C_2 is not shown but we get it by thickening the Whitehead double in C_1 . Then thicken the knot in the second figure (so we get the solid torus C_3) and take its center circle. Take the Whitehead double of this circle and so we get the knot embedded in C_3 in the third figure. In the third figure we can see the intersection of C_3 with a vertical sheet S , which is four small disks. This vertical sheet S intersects the Whitehead continuum in a Cantor set.

DEFINITION 3.4 (Cellular set, cell-like set). Let X be an n -dimensional manifold and $C \subset X$ be a subset of X . The set C is *cellular* if there is a sequence $B_1, B_2, \dots, B_n, \dots$ of closed n -dimensional balls in X such that $B_{n+1} \subset \text{int } B_n$ and $C = \bigcap_{n=1}^{\infty} B_n$. A compact subset C of a topological space X is *cell-like* if for every nbhd U of C there is a nbhd V of C in U such that the inclusion map $V \rightarrow U$ is homotopic in U to a constant map. Similarly, a decomposition is called cellular or cell-like if each of its decomposition elements is cellular or cell-like, respectively.

For example the ‘‘topologist’s sine curve’’ in \mathbb{R}^2 is cellular. A cellular set is compact and also connected but not necessarily path-connected. It is also easy to see that every compact contractible subset of a manifold is cell-like. Also a compact and contractible metric space is cell-like in itself. A cell-like set C is connected because if there were two open subsets U_1 and U_2 in X separating some connected components of C , then it would be not possible to contract any nbhd $V \subset U_1 \cup U_2$ of C to one single point.

PROPOSITION 3.5. *The set \mathcal{W} is cell-like but not cellular.*

PROOF. Let U be a nbhd of \mathcal{W} . Then there is an n such that $C_i \subset U$ for all $i \geq n$. Let V be such a small tubular nbhd of C_{n+1} which is inside C_n . Then since the Whitehead double of the center circle of C_n is null-homotopic in the solid torus C_n , the thickened Whitehead double C_{n+1} and its nbhd V are also null-homotopic in C_n , hence the map $V \rightarrow U$ is homotopic in U to a constant map.

LEMMA 3.6. *The 3-manifold $S^3 - \mathcal{W}$ is not simply connected at infinity.*

PROOF. We have to show that there is a compact subset $C \subset S^3 - \mathcal{W}$ such that for every compact set $D \subset S^3 - \mathcal{W}$ containing C the induced homomorphism

$$\varphi: \pi_1(S^3 - \mathcal{W} - D) \rightarrow \pi_1(S^3 - \mathcal{W} - C)$$

is not the zero homomorphism. Let C be the closure of $S^3 - C_1$. If D is a compact set in $S^3 - \mathcal{W}$ containing C , then $S^3 - D$ is a nbhd of \mathcal{W} in C_1 . Then there is an n such that $C_i \subset S^3 - D$ for all $i \geq n$. Consider the commutative diagram

$$\begin{array}{ccc} \pi_1(S^3 - C_n - D) & \longrightarrow & \pi_1(S^3 - C_n - C) \\ \downarrow & & \downarrow \alpha \\ \pi_1(S^3 - \mathcal{W} - D) & \xrightarrow{\varphi} & \pi_1(S^3 - \mathcal{W} - C). \end{array}$$

By [NW37] the generator of the group $\pi_1(S^3 - C_n - C)$ represented by the meridian of the torus C_n is mapped by α into a generator of $\pi_1(S^3 - \mathcal{W} - C)$. Since this meridian also represents an element of $\pi_1(S^3 - C_n - D)$, we get that φ is not the zero homomorphism. \square

Let us continue the proof of Proposition 3.5. If \mathcal{W} is cellular, then there are $B_1, B_2, \dots, B_n, \dots$ closed n -dimensional balls in S^3 such that $B_{n+1} \subset \text{int } B_n$ and $\mathcal{W} = \bigcap_{n=1}^{\infty} B_n$. This would imply that $S^3 - \mathcal{W}$ is simply connected at infinity because

if $C \subset S^3 - \mathcal{W}$ is a compact set, then take a $B_n \subset S^3 - C$ and a loop in $\text{int}B_n - \mathcal{W}$, then there is a $B_m \subset \text{int}B_n$ not containing this loop and the loop is null-homotopic in $\text{int}B_n - B_m$ because $\pi_1(\text{int}B_n - B_m) = 0$. Hence we obtain that $S^3 - \mathcal{W}$ is not cellular. \square

With more effort we could show that $S^3 - \mathcal{W}$ is contractible so it is homotopy equivalent to \mathbb{R}^3 but by the previous statement it is not homeomorphic to \mathbb{R}^3 . It is known that the set $\mathcal{W} \times \{0\}$ is cellular in $\mathbb{R}^3 \times \mathbb{R}$ and the decomposition space of the decomposition of $\mathbb{R}^3 \times \mathbb{R}$ whose only non-degenerate element is $\mathcal{W} \times \{0\}$ is homeomorphic to \mathbb{R}^4 . This fact is the starting point of the proof of the 4-dimensional Poincaré conjecture.

Being cell-like often does not depend on the ambient space. To understand this, we have to introduce a new notion.

DEFINITION 3.7 (Absolute nbhd retract). A metric space Y is an *absolute nbhd retract* (or *ANR* for short) if for an arbitrary metric space X and its closed subset A every map f from A to Y extends to a nbhd of A . In other words, the nbhd U and the dashed arrow exist in the following diagram and make the diagram commutative.

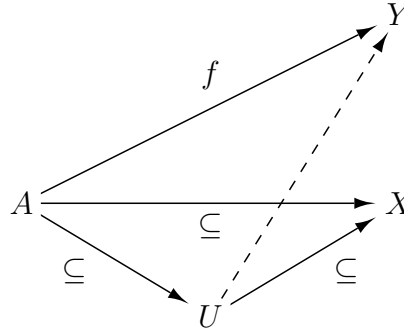

This is equivalent to say that for every metric space Z and embedding $i: Y \rightarrow Z$ such that $i(Y)$ is closed there is a nbhd U of $i(Y)$ in Z which retracts onto $i(Y)$, that is $r|_{i(Y)} = \text{id}_{i(Y)}$ for some map $r: U \rightarrow i(Y)$. It is a fact that every manifold is an ANR.

The property of cell-likeness is independent of the ambient space until that is an ANR as the following statement shows.

PROPOSITION 3.8. *If $C \subset X$ is a compact cell-like set in a metric space X , then the embedded image of C in an arbitrary ANR is also cell-like.*

PROOF. Suppose $e: C \rightarrow Y$ is an embedding into an ANR Y . We have to show that $e(C)$ is cell-like. Let U be a nbhd of $e(C)$. Since Y is ANR, there is a nbhd \tilde{V} of C in X such that e extends to an $\tilde{e}: \tilde{V} \rightarrow Y$. Let $V \subset X$ be the open set $\tilde{V} \cap \tilde{e}^{-1}(U)$, it is a nbhd of C . There is a nbhd W of C such that $C \subset W \subset V$ and there is a homotopy of the inclusion $W \subset V$ to the constant in V since C is

cell-like, denote this homotopy by $\varphi: W \times [0, 1] \rightarrow V$. Then $\varphi|_{C \times [0,1]}$ is a homotopy of the inclusion $C \subset V$ to the constant. Take

$$\tilde{e} \circ \varphi|_{C \times [0,1]} \circ (e^{-1}|_{e(C)} \times \text{id}_{[0,1]}),$$

this is a homotopy of the inclusion $e(C) \subset U$ to the constant in U . The space $e(C) \times [0, 1]$ is compact in $Y \times [0, 1]$ and the homotopy maps it into Y , which is ANR. This implies that there is a nbhd $\tilde{U} \subset U$ of $e(C)$ such that the inclusion $\tilde{U} \subset U$ is homotopic to constant in U . \square

For example, this shows that a compact and contractible metric space is cell-like if we embed it into any ANR. In practice, we do not consider cell-like sets as subsets in some ambient space but rather as compact metric spaces which are cell-like if we embed them into an arbitrary ANR.

It is clear that every cellular set C is cell-like because in every nbhd U of C some open ball is contractible. Also, we have seen that the Whitehead continuum is cell-like but not cellular. In order to compare cell-like and cellular sets we introduce the notion of cellularity criterion.

DEFINITION 3.9 (Cellularity criterion). A subset $Y \subset X$ satisfies the *cellularity criterion* if for every nbhd U of Y there is a nbhd V of Y such that $V \subset U$ and every loop in $V - Y$ is null-homotopic in $U - Y$.

The cellularity criterion and being cellular measure how wildly a subset is embedded into a space. The next theorem compares cell-like and cellular sets in a PL manifold. We omit its difficult proof here.

THEOREM 3.10. *Let C be a cell-like subset of a PL n -dimensional manifold, where $n \geq 4$. Then C is cellular if and only if C satisfies the cellularity criterion.*

In dimension 2 we have a simpler statement:

THEOREM 3.11. *Every cell-like subset in a 2-dimensional manifold X is cellular.*

PROOF. At first suppose $X = \mathbb{R}^2$ and $C \subset \mathbb{R}^2$ is a cell-like set. Let U be a bounded nbhd of C and let $V \subset U$ a nbhd of C such that the inclusion $V \rightarrow U$ is homotopic to constant. Choose another nbhd $W \subset V$ of C as well such that $\text{cl}W \subset V$. Take a compact smooth 2-dimensional manifold $H \subset V$ such that $C \subset \text{int}H$, $\partial H \subset V - \text{cl}W$ and $\text{int}H$ is connected. Such an H can be obtained by taking a Morse function $f: V \rightarrow [0, 1]$ which maps the nbhd W of C into 0 and a small nbhd of $\mathbb{R}^2 - V$ into 1. Then the preimage of a regular value r close to $1/2$ is a smooth 1-dimensional submanifold of \mathbb{R}^2 and the preimage of $(-\infty, r]$ is a compact subset containing W and C , denote this $f^{-1}((-\infty, r])$ by H . Then H is a compact smooth 2-dimensional submanifold of \mathbb{R}^2 , see Figure 5. Take its connected

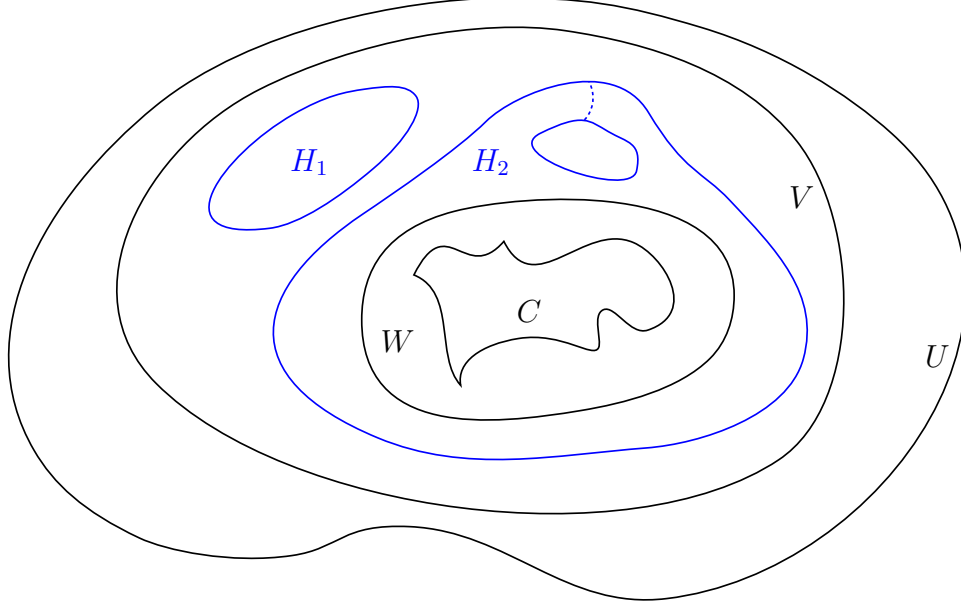

FIGURE 5. The compact manifold $H = H_1 \cup H_2$. Its component H_2 contains C . Since $H_2 - C$ is path-connected, there is a path (dashed in the figure) in H_2 connecting two different components of the boundary of H_2 .

component (this is also a path-connected component because H is a manifold) which contains C and denote this by H as well.

We show that $H - C$ is connected. For this consider the commutative diagram

$$\begin{array}{ccccccc}
 H_1(H; \mathbb{Z}_2) & \longrightarrow & H_1(H, H - C; \mathbb{Z}_2) & \longrightarrow & H_0(H - C; \mathbb{Z}_2) & \longrightarrow & H_0(H) \longrightarrow 0 \\
 \downarrow & & \downarrow & & \downarrow & & \downarrow \\
 H_1(\mathbb{R}^2; \mathbb{Z}_2) & \longrightarrow & H_1(\mathbb{R}^2, \mathbb{R}^2 - C; \mathbb{Z}_2) & \longrightarrow & H_0(\mathbb{R}^2 - C; \mathbb{Z}_2) & \xrightarrow{i_*} & H_0(\mathbb{R}^2) \longrightarrow 0
 \end{array}$$

coming from the long exact sequences and the inclusion $(H, H - C) \subset (\mathbb{R}^2, \mathbb{R}^2 - C)$. This is just the diagram

$$\begin{array}{ccccccc}
 H_1(H; \mathbb{Z}_2) & \longrightarrow & H_1(H, H - C; \mathbb{Z}_2) & \longrightarrow & H_0(H - C; \mathbb{Z}_2) & \longrightarrow & \mathbb{Z}_2 \longrightarrow 0 \\
 \downarrow & & \downarrow \cong & & \downarrow & & \downarrow \cong \\
 0 & \longrightarrow & H_1(\mathbb{R}^2, \mathbb{R}^2 - C; \mathbb{Z}_2) & \longrightarrow & H_0(\mathbb{R}^2 - C; \mathbb{Z}_2) & \xrightarrow{i_*} & \mathbb{Z}_2 \longrightarrow 0
 \end{array}$$

If the group $H_0(\mathbb{R}^2 - C; \mathbb{Z}_2)$ is \mathbb{Z}_2 , i.e. the manifold $\mathbb{R}^2 - C$ is connected, then exactness implies that $H_0(H - C; \mathbb{Z}_2) \cong \mathbb{Z}_2$ so $H - C$ is connected. To show that $\mathbb{R}^2 - C$ is connected, we apply [HW41, Theorem VI.5, page 86], which implies that if C is a closed subset of a space D and f, g are homotopic maps of C into S^1 such that f extends to D , then g extends to D and the extensions are homotopic. Suppose the open set $\mathbb{R}^2 - C$ is not connected, then it is the disjoint union of two

open sets A and B . At least one of these is bounded because for large enough s the set $\mathbb{R}^2 - [-s, s]^2$ is disjoint from C and it is connected hence it is in A or B but then $[-s, s]^2$ contains B or A , respectively. Suppose A is bounded, $p \in A$ and $q \in B$. For a subset $S \subset \mathbb{R}^2$ and point $x \in \mathbb{R}^2$ denote by $\pi_{S,x}: S - \{x\} \rightarrow S^1$ the radial projection of $S - \{x\}$ to the circle S^1 of radius 1 centered at x . Then $\pi_{C,q}$ extends to $\mathbb{R}^2 - \{q\}$ so also to $A \cup C$ but $\pi_{C,p}$ does not extend to $A \cup C$ because such an extension would extend to a much larger disk P centered at p as well by radial projection and then a retraction of P onto its boundary (if we identify it with the target circle of $\pi_{C,p}$) would exist. Consequently $\pi_{C,q}$ and $\pi_{C,p}$ are not homotopic and so at least one of them is not homotopic to constant. This means if $\mathbb{R}^2 - C$ is not connected, then there is a map $C \rightarrow S^1$ which is not homotopic to constant. But since the inclusion $V \subset U$ and then also $C \subset U$ are homotopic to constant, we get that $\mathbb{R}^2 - C$ is connected.

Finally, we get that $H - C$ is a path-connected smooth 2-dimensional manifold with boundary. Hence if the number of components of ∂H is larger than one, then there exists a smooth curve transversal to ∂H , disjoint from C and connecting different components of ∂H . We can cut H along this curve and by repeating this process we end up with ∂H being a single circle. By the Jordan curve theorem H is a compact 2-dimensional disk. In this way we get

$$C \subset W \subset \text{int}H \subset H \subset V \subset U.$$

Since in \mathbb{R}^2 every compact set is a countable intersection of open sets which form a decreasing sequence, we have $C = \bigcap_{n=1}^{\infty} U_n$, where $U_1 \supset U_2 \supset \dots \supset U_n \supset \dots$, where the sets U_n are open. We can also assume that for each n we have $\text{cl}U_{n+1} \subset U_n$.

We obtain countably many compact 2-dimensional disks H_1, H_2, \dots by the previous construction, which satisfy

$$C \subset U_{n+1} \subset \text{int}H_n \subset H_n \subset V \subset U_n.$$

Hence $C = \bigcap_{n=1}^{\infty} H_n$ so C is cellular.

In the case of X is an arbitrary 2-dimensional manifold, since C is cell-like, there exists a nbhd of C which is homotopic to constant so C is contained in a simply-connected 2-dimensional manifold nbhd, which is homeomorphic to \mathbb{R}^2 . Hence a similar argument gives that C is cellular. \square

PROPOSITION 3.12. *If C is cell-like in a smooth n -dimensional manifold X , where $n \geq 3$, then $C \times \{0\}$ is cellular in $X \times \mathbb{R}^3$.*

PROOF. It is enough to show that $C \times \{0\}$ satisfies the cellularity criterion. It is easy to see that $C \times \{0\}$ is cell-like in $X \times \mathbb{R}^3$. Let U be a nbhd of $C \times \{0\}$ in $X \times \mathbb{R}^3$. It is obvious that there is a nbhd $V \subset U$ of $C \times \{0\}$ such that every loop $\gamma: [0, 1] \rightarrow V$ is null-homotopic in U . Let γ be an arbitrary loop in $V - C \times \{0\}$, it is homotopic to a smooth loop in $\tilde{\gamma}: V - C \times \{0\}$ by a homotopy H . A homotopy of $\tilde{\gamma}$ to constant can be approximated by a smooth map $\tilde{H}: D^2 \rightarrow U$, where $\tilde{H}|_{\partial D^2} = \tilde{\gamma}$.

In the subspace $X \times \{0\}$ of $X \times \mathbb{R}^3$ let W be a nbhd of $C \times \{0\}$ which is disjoint from the homotopy \tilde{H} . Perturb \tilde{H} keeping $\tilde{H}|_{\partial D^2}$ fixed to get a transversal map to the n -dimensional manifold W in U , hence we get that γ is null-homotopic in $U - C \times \{0\}$. So the cellularity criterion holds for $C \times \{0\}$. \square

3.2. Antoine's necklace. Take the defining sequence where

- C_1 is a solid torus,
- C_2 is a finite number of solid tori embedded in C_1 in such a way that each torus is unknotted and linked to its neighbour as in a usual chain,
- C_3 is again a finite number of similarly linked solid tori,

..., etc., see Figure 6.

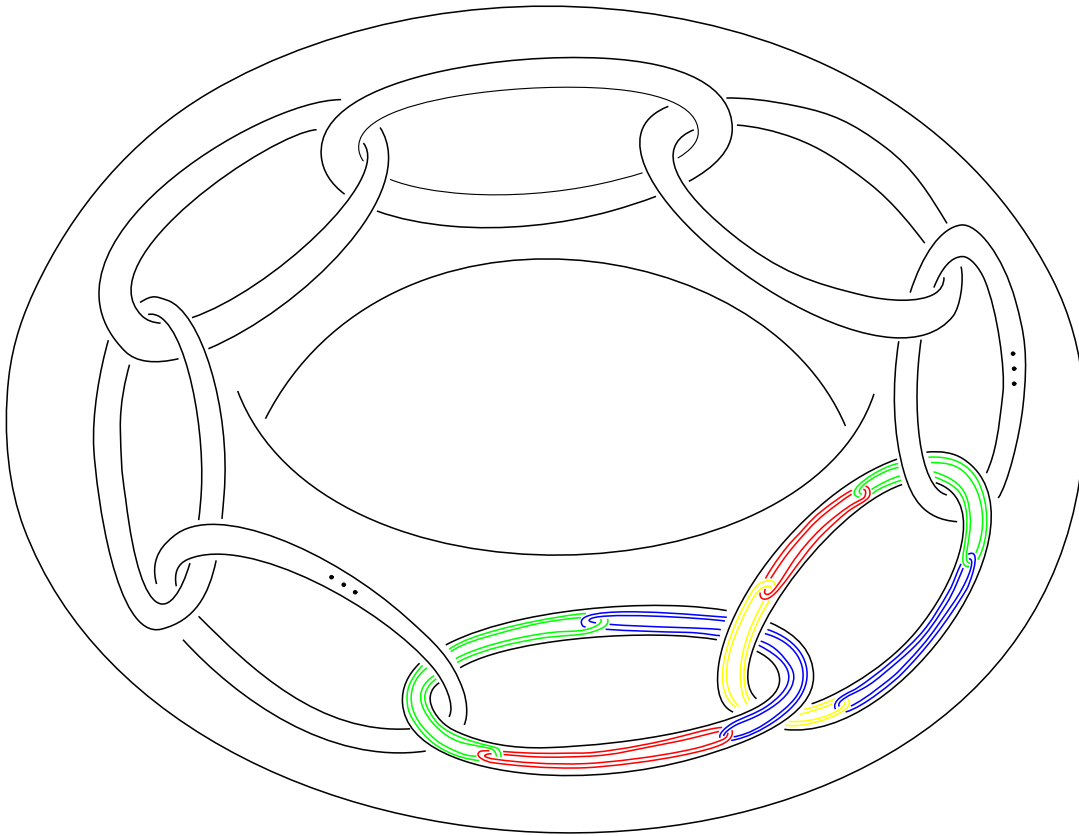

FIGURE 6. A sketch of the defining sequence of Antoine's necklace. We can see the solid torus C_1 , the linked tori C_2 and some linked tori from the collection C_3 , etc. The number of components of C_{n+1} in C_n is large enough to make the diameters of the tori converge to 0.

We always consider at least three tori in each C_n . We require that the maximal diameter of tori in C_n converges to 0. The set $\bigcap_{n=1}^{\infty} C_n$ is called Antoine's necklace and denoted by \mathcal{A} . It is easy to see that each of its components is cell-like. Unlike

Whitehead continuum the components of \mathcal{A} are cellular because every component of C_{n+1} is inside a ball in C_n .

Recall that the Cantor set is the topological space

$$D_1 \times D_2 \times \cdots \times D_n \times \cdots,$$

where every space D_n is a finite discrete metric space with $|D_n| \geq 2$.

PROPOSITION 3.13. *The space $\bigcap_{n=1}^{\infty} C_n$ is homeomorphic to the Cantor set.*

PROOF. Denote the number of tori embedded in C_1 by m_1 , these tori are

$$C_{2,1}, \dots, C_{2,m_1}$$

whose disjoint union is C_2 . For $1 \leq i_1 \leq m_1$ take the i_1 -th torus C_{2,i_1} and denote the number of tori embedded into it by m_{2,i_1} , these tori are

$$C_{3,i_1,1}, \dots, C_{3,i_1,m_{2,i_1}}$$

whose disjoint union is C_3 . Again for $1 \leq i_2 \leq m_{2,i_1}$ take the i_2 -th torus C_{3,i_1,i_2} and denote the number of tori embedded into it by m_{3,i_1,i_2} , these tori are

$$C_{4,i_1,i_2,1}, \dots, C_{4,i_1,i_2,m_{3,i_1,i_2}}$$

whose disjoint union is C_4 . In general in the n -th step for $1 \leq i_n \leq m_{n,i_1,\dots,i_{n-1}}$ take the i_n -th torus C_{n+1,i_1,\dots,i_n} and denote the number of tori embedded into it by m_{n+1,i_1,\dots,i_n} , these tori are

$$C_{n+2,i_1,\dots,i_n,1}, \dots, C_{n+2,i_1,\dots,i_n,m_{n+1,i_1,\dots,i_n}}$$

whose disjoint union is C_{n+2} .

Now we construct a Cantor set \mathcal{C} in the interval $[0, 1]$. Divide $[0, 1]$ into $2m_1 - 1$ closed intervals

$$I_{2,1}, \dots, I_{2,2m_1-1} \subset [0, 1]$$

of equal length and disjoint interiors. Then divide the i_1 -th interval I_{2,i_1} , where i_1 is odd, into $2m_{2,i_1} - 1$ closed intervals

$$I_{3,i_1,1}, \dots, I_{3,i_1,2m_{2,i_1}-1}$$

of equal length. Then divide the i_2 -th interval I_{3,i_1,i_2} , where i_2 is odd, into $2m_{3,i_1,i_2} - 1$ closed intervals

$$I_{4,i_1,i_2,1}, \dots, I_{4,i_1,i_2,2m_{3,i_1,i_2}-1}$$

of equal length. In the n -th step divide the i_n -th interval I_{n+1,i_1,\dots,i_n} , where i_n is odd, into the closed intervals

$$I_{n+2,i_1,\dots,i_n,1}, \dots, I_{n+2,i_1,\dots,i_n,2m_{n+1,i_1,\dots,i_n}-1}$$

of equal length and so on. So all the intervals I_{n+1,i_1,\dots,i_n} have length

$$\frac{1}{(2m_1 - 1) \cdots (2m_{n,i_1,\dots,i_{n-1}} - 1)}.$$

Then let

$$\mathcal{C} = \bigcap_{n=1}^{\infty} \bigcup_{\substack{1 \leq i_1 \leq m_1 \\ 1 \leq i_2 \leq m_{2,i_1} \\ \dots \\ 1 \leq i_n \leq m_{n,i_1, \dots, i_{n-1}}}} I_{n+1, 2i_1-1, \dots, 2i_n-1}.$$

Assign to a point $x \in \bigcap_{n=1}^{\infty} C_n$ the point

$$\bigcap_{n=1}^{\infty} I_{n+1, 2i_1(x)-1, \dots, 2i_n(x)-1},$$

which is the intersection of the closed intervals containing x . This defines a map

$$f: \bigcap_{n=1}^{\infty} C_n \rightarrow \mathcal{C},$$

which is clearly surjective. It is injective as well because if $x \neq x'$, then for large n they are in different C_n so they are mapped into different intervals as well. The map f is continuous because if x and x' are in the same C_n until some large enough n , then they are mapped to the same intervals until a large index so $f(x)$ and $f(x')$ are close enough. Then f is a homeomorphism since its domain is compact and it maps injectively into a T_2 space. \square

Of course the components of \mathcal{A} are points so the decomposition space is obviously \mathbb{R}^3 . An important property of \mathcal{A} is that it is *wild*, i.e. there is no self-homeomorphism of \mathbb{R}^3 mapping \mathcal{A} onto the Cantor set in a line segment. To prove this, we study the local behaviour of the complement of \mathcal{A} .

DEFINITION 3.14. Let $k \geq 0$. A closed subset A of a space X is locally k -co-connected (k -LCC for short) if for every point $a \in A$ and for every nbhd U of a in X there is a nbhd $V \subset U$ of a in X such that if $\varphi: \partial D^{k+1} \rightarrow V - A$ is a map of the k -sphere, then φ extends to a map of D^{k+1} into $U - A$.

PROPOSITION 3.15. *The set \mathcal{A} in \mathbb{R}^3 is not 1-LCC.*

SKETCH OF THE PROOF. At first we show that if $\alpha: S^1 \rightarrow C_1$ is the meridian of the torus C_1 , then every smooth embedding $\tilde{\alpha}: D^2 \rightarrow \mathbb{R}^3$ extending α is such that $\tilde{\alpha}(D^2)$ intersects \mathcal{A} . If this was not true, then $\tilde{\alpha}(D^2)$ would intersect at most finitely many tori C_1, \dots, C_n and it would be possible to perturb $\tilde{\alpha}$ to get a smooth embedding transversal to each ∂C_n . Then it is possible to show that there is a disk $D_1 \subset D^2$ such that $\tilde{\alpha}(\partial D_1)$ intersects some torus $\partial C_{2,i_1}$ in a meridian. Inductively, $\tilde{\alpha}(D^2)$ has to intersect some torus $\partial C_{m,i_1, \dots, i_{m-1}}$ for arbitrarily large $m > n$, which is a contradiction. Suppose that \mathcal{A} is 1-LCC. Let $\beta: D^2 \rightarrow \mathbb{R}^3$ be a smooth embedding such that $\beta(\partial D^2)$ is a meridian of C_1 . Cover $\beta(D^2) \cap \mathcal{A}$ by open sets $\{U_\gamma\}_{\gamma \in \Gamma}$ around each of its points, then there is a covering $\{V_\gamma\}_{\gamma \in \Gamma}$ such that for all $\gamma \in \Gamma$ we have $V_\gamma \subset U_\gamma$ and each map $\partial D^2 \rightarrow (\mathbb{R}^3 - \mathcal{A}) \cap V_\gamma$ can be extended to a map $D^2 \rightarrow (\mathbb{R}^3 - \mathcal{A}) \cap U_\gamma$. We can also suppose that $\cup_\gamma U_\gamma$ is disjoint from $\beta(\partial D^2)$. By Lebesgue lemma there is a refinement of D^2 into finitely many small disks with disjoint interiors such that each of their boundary circles is mapped by β into some

V_γ . After a small perturbation we can suppose that each of the β -images of these boundary circles is disjoint from C_n for some common large n but it is still in some V_γ . Now change β on each of the small disks to get a map into $(\mathbb{R}^3 - \mathcal{A}) \cap U_\gamma$. By Dehn's lemma there are embeddings as well of the small disks into $(\mathbb{R}^3 - \mathcal{A}) \cap U_\gamma$. In this way we get an embedding of the original disk D^2 which is disjoint from \mathcal{A} . This contradicts to the fact that every embedded disk $D^2 \subset \mathbb{R}^3$ with boundary circle being a meridian of C_1 intersects \mathcal{A} . \square

The standard Cantor set $C \subset \mathbb{R} \times \{0\} \times \{0\} \subset \mathbb{R}^3$ is 1-LCC, because having a small loop in its complement $\mathbb{R}^3 - C$ yields by approximation a small smooth loop in $\mathbb{R}^3 - C$ transversal to and disjoint from $\mathbb{R} \times \{0\} \times \{0\}$. Then deform this loop by compressing it in a direction parallel to $\mathbb{R} \times \{0\} \times \{0\}$ until the loop sits in the plane $\{x\} \times \mathbb{R}^2$ for some number $x \in \mathbb{R}^3 - C$. After these the loop can be squeezed easily inside this plane to a point in $\mathbb{R}^3 - C$. This implies that Antoine's necklace is a wild Cantor set in \mathbb{R}^3 .

3.3. Bing decomposition. If in the construction of Antoine's necklace there are always two tori components of C_{n+1} in each component of C_n , then we call the arising decomposition Bing decomposition. Apriori there could be many different Bing decompositions depending on how the solid tori are embedded into each other. It is not obvious that we can arrange the components of C_n embedded in such a way that $\bigcap_{n=1}^\infty C_n$ is a Cantor set, which would follow if the maximal diameter of the tori in C_n converges to 0. A random defining sequence can be seen in Figure 7.

Now we construct a defining sequence, where the maximal diameter of the tori in C_n converges to 0. For this, consider the following way to define a finite sequence of finite sequences of embeddings:

$$D_0,$$

$$D_0 \supset D_{2,1},$$

$$D_0 \supset D_{3,1} \supset D_{3,2},$$

$$D_0 \supset D_{4,1} \supset \dots \supset D_{4,3},$$

..., etc., where $D_{n,0} = D_0$ is a solid torus, $D_{n,k}$ is a disjoint union of 2^k copies of solid tori and the components of $D_{n,k}$ are pairwise embedded in the components of $D_{n,k-1}$, moreover these pairs are linked just like in the defining sequence of Bing decomposition, for further subtleties see Figure 8.

Arriving to the tori $D_{n+1,n}$ and assuming that their meridional size is small enough, we obtain a regular $2n$ -gon-like arrangement of 2^n copies of solid tori as Figure 8 shows. Two conditions are satisfied: the meridional size of all the tori is small and an "edge" of this $2n$ -gon is also small. This means that if this $D_{n+1,n}$ is embedded into a torus (as the figure suggests) whose meridional size is small, then the maximal diameter of the torus components of $D_{n+1,n}$ is small if n is large.

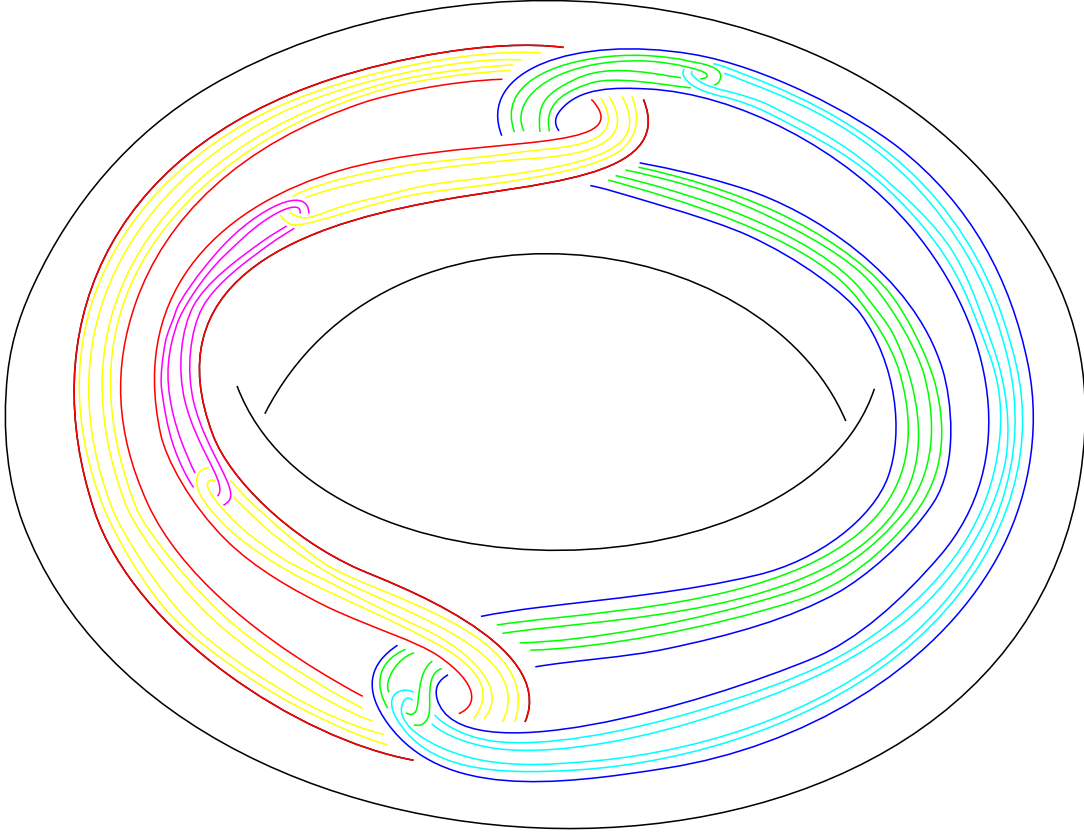

FIGURE 7. A sketch of a defining sequence of the Bing decomposition. We can see the torus C_1 , the two torus components of C_2 and the four torus components of C_3 . The maximal diameter of tori in C_n does not converge to 0 necessarily.

PROPOSITION 3.16. *There is a defining sequence C_1, \dots, C_n, \dots of the Bing decomposition, where the maximal diameter of tori in C_n converges to 0. Hence $\bigcap_{n=1}^{\infty} C_n$ is homeomorphic to the Cantor set.*

PROOF. Let $\varepsilon_n > 0$ be a sequence whose limit is 0. Let n_1 be so large that in C_{n_1} in a defining sequence the meridional size of tori is smaller than ε_1 . Let m_1 be so large that we can embed D_{m_1+1, m_1} into the torus components of C_{n_1} so that the maximal diameter of tori in the obtained $C_{n_1+m_1}$ is smaller than ε_1 . Then let $n_2 > n_1 + m_1$ be so large that in a continuation of the defining sequence in C_{n_2} the meridional size of tori is smaller than ε_2 . Let m_2 be so large that we can embed D_{m_2+1, m_2} into the torus components of C_{n_2} so that the maximal diameter of tori in the obtained $C_{n_2+m_2}$ is smaller than ε_2 . And so on. It is easy to see that the maximal diameter of tori converges to 0. \square

This implies that the decomposition space of this decomposition is \mathbb{R}^3 . For an arbitrary defining sequence the space $\bigcap_{n=1}^{\infty} C_n$ may be not the Cantor set, however

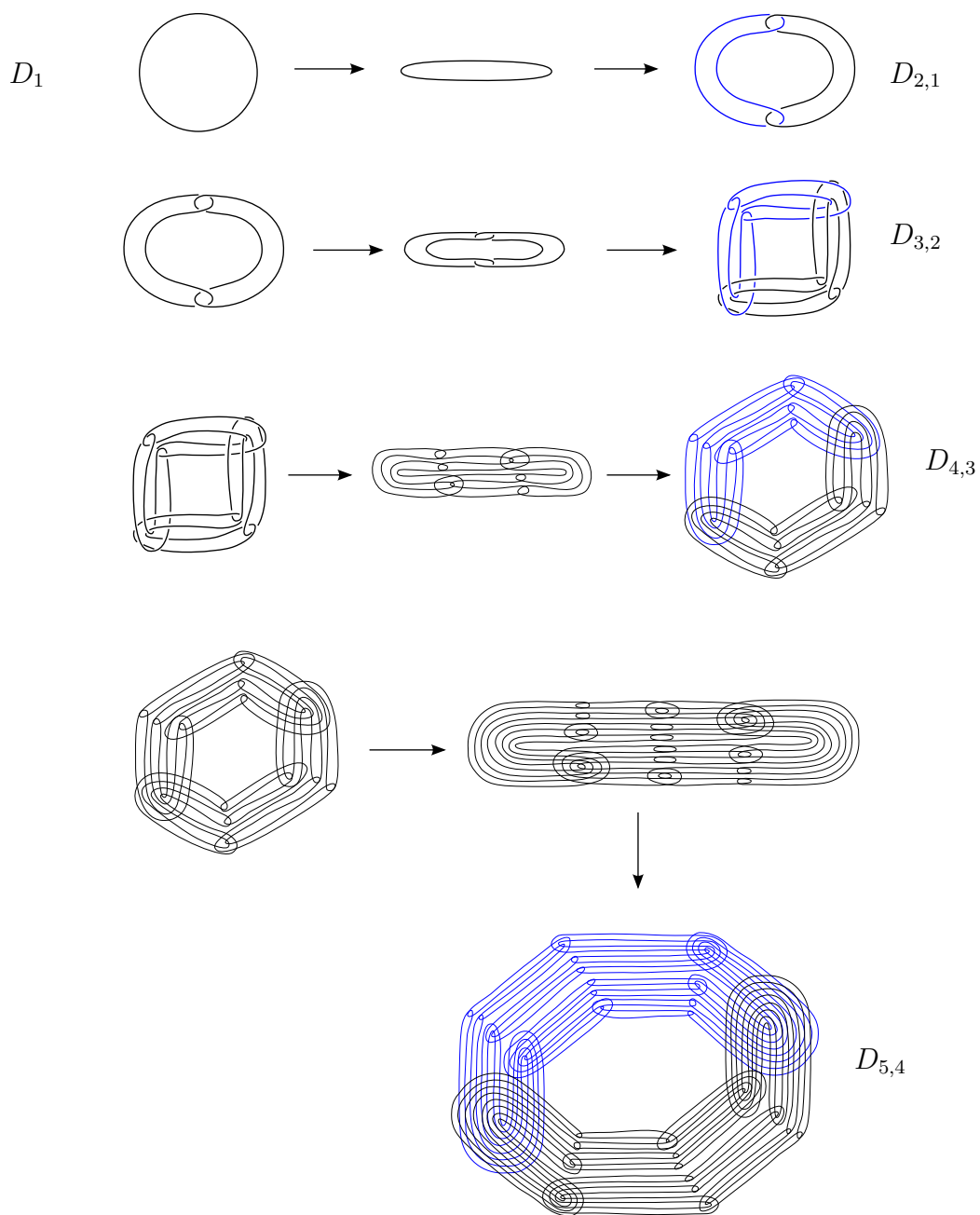

FIGURE 8. A sketch of constructing the tori $D_{n+1,n}$. Instead of the solid tori we just draw their center circles. We always take the previously obtained linked tori $D_{n,n-1}$, squeeze them to become “flat” as the figure shows, then curve them a little and link them with another copy at the two “endings”. Hence we get $D_{n+1,n}$. The sequence of embeddings $D_0 \supset D_{n+1,1} \supset \cdots \supset D_{n+1,n}$ can be kept in sight by checking all the smaller linkings.

the decomposition space could be still homeomorphic to the ambient space \mathbb{R}^3 . It is a very important observation that the embedding of the tori in $D_{n+1,n}$ can be obtained by an isotopy of $C_1 \subset \cdots \subset C_{n+1}$ in any defining sequence, see [Bi52]. By such an isotopy for a given defining sequence we can manage something similar to the previous statement: if n is large enough, then the meridional size of the torus components in C_n is smaller than a given $\varepsilon > 0$. Then apply the required isotopy for C_{n+1}, \dots, C_{n+k} for some large k to make the maximal diameter of the torus components of C_{n+k} smaller than ε . Note that since n is large enough and all the isotopy happens inside C_n , all the isotopy happens inside an arbitrarily small nbhd of $\bigcap_{n=1}^{\infty} C_n$. This means that for every $\varepsilon > 0$ there is a self-homeomorphism h of \mathbb{R}^3 with support C_1 such that $h(\mathcal{D}) < \varepsilon$ for every decomposition element $\mathcal{D} \subset \bigcap_{n=1}^{\infty} C_n$ and also $\pi \circ h(\mathcal{D})$ stays in the ε -nbhd of $\pi(\mathcal{D})$ for some metric on the decomposition space. This condition is called shrinkability criterion and it implies that the decomposition space is homeomorphic to the ambient space \mathbb{R}^3 as we will see in the next section.

4. Shrinking

Let X be a topological space and \mathcal{D} a decomposition of X . An open cover \mathcal{U} of X is called \mathcal{D} -saturated if every $U \in \mathcal{U}$ is a union of decomposition elements.

DEFINITION 4.1 (Bing shrinkability criterion). Let \mathcal{D} be a usc decomposition of the space X . We say \mathcal{D} is *shrinkable* if for every open cover \mathcal{V} and \mathcal{D} -saturated open cover \mathcal{U} there is a self-homeomorphism h of X such that for every $D \in \mathcal{D}$ the set $h(D)$ is in some $V \in \mathcal{V}$ and for every $x \in X$ there is a $U \in \mathcal{U}$ such that $x, h(x) \in U$. In other words, h shrinks the elements of \mathcal{D} to arbitrarily small sets and h is \mathcal{U} -close to the identity. We say \mathcal{D} is *strongly shrinkable* if for every open set W containing all the non-degenerate elements of \mathcal{D} the decomposition \mathcal{D} is shrinkable so that the support of h is in W .

In other words \mathcal{D} is shrinkable if its elements can be made small enough simultaneously so that this shrinking process does not move the points of X too far in the sense of measuring the distance in the decomposition space. If X has a shrinkable decomposition, then we expect that the local structure of X is similar to the structure of the nbhds of the decomposition elements.

PROPOSITION 4.2. *Let X be a regular space and let \mathcal{D} be a shrinkable usc decomposition of X . If every $x \in X$ has arbitrarily small nbhds satisfying a fixed topological property, then every $D \in \mathcal{D}$ has arbitrarily small nbhds satisfying the same property.*

PROOF. Let W be an arbitrary nbhd of an element $D \in \mathcal{D}$. Then there is a saturated nbhd \tilde{U}_1 of D such that $\tilde{U}_1 \subset W$. Let U_1 denote $\pi(\tilde{U}_1)$. Since $X_{\mathcal{D}}$ is

regular, there are open sets U_2 and U_3 such that

$$\pi(D) \subset U_3 \subset \text{cl } U_3 \subset U_2 \subset \text{cl } U_2 \subset U_1.$$

Then take the sets

$$\pi^{-1}(U_3), \pi^{-1}(U_2) - D, \pi^{-1}(U_1 - \text{cl } U_3), \text{ and } X - \pi^{-1}(\text{cl } U_2),$$

see Figure 9. These yield a \mathcal{D} -saturated open cover \mathcal{U} of X . Let \mathcal{V} be an open cover of X which refines \mathcal{U} and consists of open sets with our fixed property. Since \mathcal{D} is shrinkable, we have a homeomorphism $h: X \rightarrow X$ such that $h(D) \subset V$ for some $V \in \mathcal{V}$ and h is \mathcal{U} -close to the identity. Then $D \subset h^{-1}(V)$ so it is enough to show that

$$h^{-1}(V) \subset W.$$

Suppose there exists some $x \in h^{-1}(V) - W$, then $x \in h^{-1}(V) - \pi^{-1}(U_1)$ since $\pi^{-1}(U_1) \subset W$. Hence among the sets in \mathcal{U} only $X - \pi^{-1}(\text{cl } U_2)$ contains x so $h(x) \in V$ has to be in $X - \pi^{-1}(\text{cl } U_2)$ as well. This implies that $V \subset X - \pi^{-1}(\text{cl } U_3)$ because V is a subset of some sets in \mathcal{U} . Also we know that $h(D) \subset \pi^{-1}(U_3)$ since $D \subset \pi^{-1}(U_3)$. This means that $h(D) \subset V \subset X - \pi^{-1}(\text{cl } U_3)$ cannot hold so $h^{-1}(V) \subset W$. \square

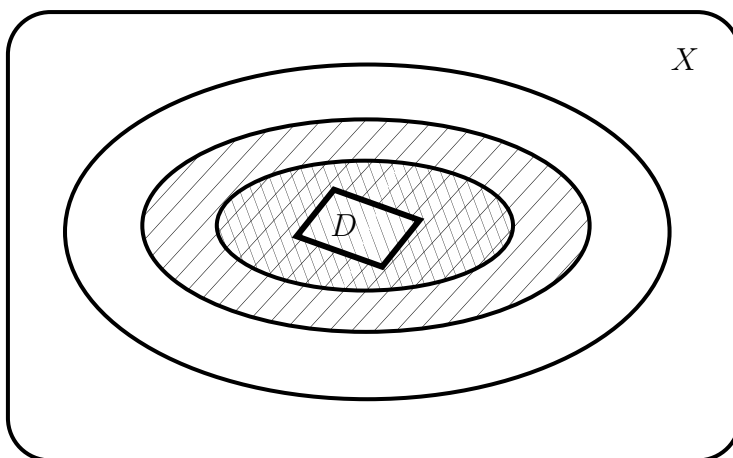

FIGURE 9. The set D and the π -preimages of the sets $U_3 \subset U_2 \subset U_1$ in X . In the figure the sets $\pi^{-1}(U_3)$ and $\pi^{-1}(U_2) - D$ are shaded.

For example every decomposition element of a shrinkable decomposition of a manifold is cellular.

It is often not too difficult to check whether a decomposition of a space X is shrinkable. A corollary of shrinkability is that the decomposition space is homeomorphic to X . This is often applied when we want to construct embedded manifolds and the construction uses mismatched pieces, which we eliminate by taking them as the decomposition elements and then looking at the decomposition space.

DEFINITION 4.3 (Near-homeomorphism, approximating by homeomorphism). Let X and Y be topological spaces. An $f: X \rightarrow Y$ surjective map is a *near-homeomorphism* if for every open covering \mathcal{W} of Y there is a homeomorphism $h: X \rightarrow Y$ such that for every $x \in X$ the points $f(x)$ and $h(x)$ are in some $W \in \mathcal{W}$, in other words h is \mathcal{W} -close to f .

If (Y, ϱ) is a metric space, then f being a near-homeomorphism implies that f can be approximated by homeomorphisms in the possibly infinite-valued metric $d(f, g) = \sup\{\varrho(f(x), g(x))\}$. Notice that if $f: X \rightarrow Y$ is a near-homeomorphism, then X and Y are actually homeomorphic.

The main result is that a usc decomposition yields a homeomorphic decomposition space if the decomposition is shrinkable. This is applied in major 4-dimensional results: in the disk embedding theorem and in the proof of the 4-dimensional topological Poincaré conjecture [Fr82, BKKPR]. It is extensively applied in constructing approximations of manifold embeddings in dimension ≥ 5 , see [AC79] and Edwards's cell-like approximation theorem.

For an open cover \mathcal{W} of a space X and a subset $A \subset X$ let $St(A, \mathcal{W})$ denote the subset

$$\bigcup\{W \in \mathcal{W} : W \cap A \neq \emptyset\}.$$

This is called the *star* of A and it is a nbhd of A . Of course if $A \subset B$, then $St(A, \mathcal{W}) \subset St(B, \mathcal{W})$. If \mathcal{W}' is an open cover which is a refinement of the open cover \mathcal{W} , then obviously $St(A, \mathcal{W}') \subset St(A, \mathcal{W})$. We will use often that if the covering \mathcal{W}' is a *star-refinement* of the covering \mathcal{W} , that is the collection

$$\{St(W_\alpha, \mathcal{W}') : W_\alpha \in \mathcal{W}'\}$$

of stars of elements of \mathcal{W}' is a refinement of \mathcal{W} , then for every point $x \in X$ we have $St(\{x\}, \mathcal{W}') \subset W$ for some $W \in \mathcal{W}$.

The following theorem requires a complete metric on the space X , for example the statement holds for an arbitrary manifold.

THEOREM 4.4. *Let \mathcal{D} be a usc decomposition of a space X admitting a complete metric. Then the following are equivalent:*

- (1) *the decomposition map $\pi: X \rightarrow X_{\mathcal{D}}$ is a near-homeomorphism,*
- (2) *\mathcal{D} is shrinkable.*

If additionally X is also locally compact and separable, then shrinkability is equivalent to

- (3) *if $C \subset X$ is an arbitrary compact set, $\varepsilon > 0$ and \mathcal{U} is a \mathcal{D} -saturated open cover of X , then there is a homeomorphism $h: X \rightarrow X$ such that $\text{diam } h(D) < \varepsilon$ for every $D \subset C$, $D \in \mathcal{D}$ and h is \mathcal{U} -close to the identity.*

PROOF. Near-homeomorphism (1) implies shrinking (2) and (3). Of course (2) implies (3) so we are going to prove only that (1) implies (2). At first, suppose that the decomposition map $\pi: X \rightarrow X_{\mathcal{D}}$ is a near-homeomorphism. We have to show that \mathcal{D} is shrinkable by finding an appropriate homeomorphism h . We know that since X is metric, the decomposition space $X_{\mathcal{D}}$ is metrizable hence it is paracompact. (To show that \mathcal{D} is shrinkable, we will use only that the space X is paracompact and T_4 .) Let \mathcal{V} be an open cover and let \mathcal{U} be a \mathcal{D} -saturated open cover of X . Take the open covering $\{\pi(U) : U \in \mathcal{U}\}$ of $X_{\mathcal{D}}$. Since $X_{\mathcal{D}}$ is paracompact, this covering has a star-refinement \mathcal{W}_0 , i.e. \mathcal{W}_0 is a covering and the collection of stars of elements of \mathcal{W}_0 , that is the collection

$$\{St(W_\alpha, \mathcal{W}_0) : W_\alpha \in \mathcal{W}_0\}$$

is a refinement of $\{\pi(U) : U \in \mathcal{U}\}$, see [Du66, Section 8.3]. Similarly \mathcal{W}_0 has a star-refinement covering \mathcal{W}_1 . Then there is a homeomorphism

$$h_1: X \rightarrow X_{\mathcal{D}}$$

which is \mathcal{W}_1 -close to π because π is a near-homeomorphism. Take the open cover

$$\mathcal{W}_1 \bigcap h_1(\mathcal{V}) = \{W \cap h_1(V) : W \in \mathcal{W}_1, V \in \mathcal{V}\}$$

and a star-refinement \mathcal{W}_2 of it. Of course \mathcal{W}_2 is a star-refinement of \mathcal{W}_1 and $h_1(\mathcal{V})$ as well. There is a homeomorphism

$$h_2: X \rightarrow X_{\mathcal{D}}$$

which is \mathcal{W}_2 -close to π . Let $h: X \rightarrow X$ be the composition

$$h_1^{-1} \circ h_2.$$

At first we show that h shrinks every decomposition element $D \in \mathcal{D}$ into some $V \in \mathcal{V}$. Let $D \in \mathcal{D}$. It is enough to show that $h_2(D) \subset h_1(V)$ for some $V \in \mathcal{V}$. We have that for every $x \in D$ the points $\pi(D)$ and $h_2(x)$ are in the same $W_x \in \mathcal{W}_2$ so

$$h_2(D) \subset St(\{\pi(D)\}, \mathcal{W}_2) \subset h_1(V)$$

for some $V \in \mathcal{V}$ because \mathcal{W}_2 is a star-refinement of $h_1(\mathcal{V})$. Now we show that h is \mathcal{U} -close to the identity. We have that for every $x \in D$ the points $\pi(D)$ and $h_1(x)$ are in the same $W_x \in \mathcal{W}_1$ because h_1 is \mathcal{W}_1 -close to π so

$$h_1(D) \subset St(\{\pi(D)\}, \mathcal{W}_1).$$

Since \mathcal{W}_2 is a refinement of \mathcal{W}_1 , we have

$$h_2(D) \subset St(\{\pi(D)\}, \mathcal{W}_2) \subset St(\{\pi(D)\}, \mathcal{W}_1).$$

These imply that

$$h_1(D) \cup h_2(D) \subset St(\{\pi(D)\}, \mathcal{W}_1) \subset W_0$$

for some $W_0 \in \mathcal{W}_0$ because \mathcal{W}_1 is a star-refinement of \mathcal{W}_0 . Hence for every $D \in \mathcal{D}$ we have

$$D \cup h(D) = h_1^{-1} \circ h_1(D \cup h_2(D)) = h_1^{-1}(h_1(D) \cup h_2(D)) \subset h_1^{-1}(W_0)$$

so if we show that

$$h_1^{-1}(W_0) \subset U$$

for some $U \in \mathcal{U}$, then we prove the statement. Since h_1 and π are \mathcal{W}_1 -close, they are \mathcal{W}_0 -close as well. This means that for every $x \in X$ the points $\pi(x)$ and $h_1(x)$ are in the same $W_x \in \mathcal{W}_0$. So if $x \in h_1^{-1}(W_0)$, then

$$\pi(x) \in St(W_0, \mathcal{W}_0),$$

which gives that

$$\pi(h_1^{-1}(W_0)) \subset St(W_0, \mathcal{W}_0) \subset \pi(U)$$

for some $U \in \mathcal{U}$ because W_0 is a star-refinement of $\pi(\mathcal{U})$. Then the statement follows because

$$h_1^{-1}(W_0) \subset \pi^{-1} \circ \pi(h_1^{-1}(W_0)) \subset \pi^{-1} \circ \pi(U) = U.$$

Shrinking (2) or (3) implies near-homeomorphism (1). At first observe that in the case of (3) if X is locally compact and separable, then X is σ -compact so X is the union $\bigcup_{n=1}^{\infty} C_n$ of countably many compact sets

$$C_1 \subset C_2 \subset \dots \subset C_n \subset \dots.$$

We also suppose that every C_n is \mathcal{D} -saturated and has non-empty interior. Let \mathcal{W} be an arbitrary open cover of $X_{\mathcal{D}}$. We have to construct a homeomorphism $h: X \rightarrow X_{\mathcal{D}}$ which is \mathcal{W} -close to π . At first, we construct a sequence

$$\mathcal{U}_0, \mathcal{U}_1, \dots, \mathcal{U}_n, \dots$$

of \mathcal{D} -saturated open covers of X and a sequence

$$h_0, h_1, \dots, h_n, \dots$$

of self-homeomorphisms of X with some useful properties. Let \mathcal{U}_0 be a \mathcal{D} -saturated open cover of X such that the collection of the closures of the elements of \mathcal{U}_0 refines the open cover $\pi^{-1}(\mathcal{W})$. This obviously exists because $X_{\mathcal{D}}$ is regular so around every point of $X_{\mathcal{D}}$ there is a small closed nbhd contained in some element of \mathcal{W} . Let h_0 be the identity homeomorphism. Let $\varepsilon_n > 0$ be a decreasing sequence converging to 0. Define ε_0 to be ∞ . Denote the metric on X by d . Suppose inductively that we constructed already the covers $\mathcal{U}_0, \dots, \mathcal{U}_n$ and the homeomorphisms h_0, \dots, h_n with the following properties:

- (1) (a) \mathcal{U}_{i+1} is a \mathcal{D} -saturated open cover, which refines \mathcal{U}_i for $0 \leq i \leq n-1$,
- (b) for all $0 \leq i \leq n$ the set \mathcal{U}_i refines the collection of ε_i -nbhds of the elements of \mathcal{D} and also refines the collection $\{\pi^{-1}(B_{\varepsilon_i}(y)) : y \in X_{\mathcal{D}}\}$, where $B_{\varepsilon_i}(y)$ is the open ball of radius ε_i around y ,
- (2) (a) for every $0 \leq i \leq n-1$ every $D \in \mathcal{D}$ has a nbhd $U \in \mathcal{U}_i$ such that for every $U' \in \mathcal{U}_{i+1}$ which contains D we have

$$h_i(U') \cup h_{i+1}(U') \subset h_i(U),$$

- (b) for every $0 \leq i \leq n$ the diameter of each $h_i(U)$, $U \in \mathcal{U}_i$, is smaller than ε_i ,

- (b') in the case of X is σ -compact we require only that for every $0 \leq i \leq n$ and for every nbhd $U \in \mathcal{U}_i$ such that $U \cap C_i \neq \emptyset$ the diameter of each $h_i(U)$ is smaller than ε_i .

There will be some important corollaries of these constructions. Part (a) of (2) implies that every $D \in \mathcal{D}$ has a nbhd $U \in \mathcal{U}_i$ such that for every $k \geq 1$ and $U' \in \mathcal{U}_{i+k}$ which contains D we have

$$(4.1) \quad h_{i+k}(U') \subset h_i(U).$$

For $k = 1$ this is immediate from (2)(a) and for $k \geq 2$ this follows by a simple induction. This means that once we have U_n and h_n for every $n \in \mathbb{N}$ satisfying (1) and (2), the sequence h_n is a Cauchy sequence in the sense of local uniform convergence in the space of maps of X into X . Indeed, if $x \in X$, then for some $D \in \mathcal{D}$ we have $x \in D$ and then D has a nbhd $U \in \mathcal{U}_n$ for every n such that by applying (4.1) for all $k \in \mathbb{N}$

$$(4.2) \quad h_{n+k}(D) \subset h_n(U),$$

which means that $d(h_n(x), h_{n+k}(x)) < \varepsilon_n$ for all $x \in X$ by (2)(b). In the case of X is σ -compact we have that for some $m \in \mathbb{N}$ the intersection $D \cap C_n \neq \emptyset$ for $n \geq m$ hence by (2)(b') we have $\text{diam } h_n(U) < \varepsilon_n$ for every $n \geq m$ and nbhd $U \in \mathcal{U}_n$ of D . This implies that for all $n \geq m$ we get $d(h_n(x), h_{n+k}(x)) < \varepsilon_n$ for all k and $x \in D$, where $D \subset C_n$. Since (X, d) is complete, the sequence h_n converges locally uniformly to a continuous map

$$\chi: X \rightarrow X,$$

which will be a good candidate for obtaining our desired near-homeomorphism.

Defining \mathcal{U}_{n+1} and h_{n+1} . So let us return to the definition of the covers \mathcal{U}_n and homeomorphisms h_n . Suppose inductively that we constructed already the covers $\mathcal{U}_0, \dots, \mathcal{U}_n$ and the homeomorphisms h_0, \dots, h_n with the properties (1) and (2). We are going to define \mathcal{U}_{n+1} and h_{n+1} . The metrizable space $X_{\mathcal{D}}$ is paracompact so the open cover $\pi(\mathcal{U}_n)$ has a star-refinement whose π -preimage \mathcal{U}'_n is a \mathcal{D} -saturated open cover of X , which star-refines \mathcal{U}_n . Let \mathcal{V} be an open cover of X such that the diameter of each of its elements is smaller than ε_{n+1} . Then we have two possibilities.

- If \mathcal{D} is shrinkable, then there is a self-homeomorphism H of X , which is $h_n(\mathcal{U}'_n)$ -close to the identity and shrinks the elements of $h_n(\mathcal{D})$ into the sets of \mathcal{V} . Let

$$h_{n+1} = H \circ h_n.$$

Clearly the diameter of each $h_{n+1}(D)$, where $D \in \mathcal{D}$, is smaller than ε_{n+1} .

- If only those elements of \mathcal{D} are shrinkable which are in a chosen compact set as we suppose in (3) of the statement of Theorem 4.4, then there is a homeomorphism $H_0: X \rightarrow X$ such that the elements of \mathcal{D} in the compact set C_{n+1} are mapped by H_0 into some element of $h_n^{-1}(\mathcal{V})$ and H_0 is \mathcal{U}'_n -close to the identity. This implies that $h_n \circ H_0 \circ h_n^{-1}$ is such a self-homeomorphism of X that maps the elements of $h_n(\mathcal{D})$ which are in $h_n(C_{n+1})$ into the sets

of \mathcal{V} and it is $h_n(\mathcal{U}'_n)$ -close to the identity. Denote $h_n \circ H_0 \circ h_n^{-1}$ by H . Then let

$$h_{n+1} = H \circ h_n.$$

So h_{n+1} maps every $D \in \mathcal{D}$, $D \subset C_{n+1}$ into a set of diameter smaller than ε_{n+1} .

The definition of \mathcal{U}_{n+1} is a little more complicated. For every $U'_n \in \mathcal{U}'_n$

$$h_{n+1}(U'_n) \subset h_n(St(U'_n, \mathcal{U}'_n))$$

because

$$h_{n+1}(U'_n) = H \circ h_n(U'_n) \subset St(h_n(U'_n), h_n(\mathcal{U}'_n))$$

since H is $h_n(\mathcal{U}'_n)$ -close to the identity and also

$$St(h_n(U'_n), h_n(\mathcal{U}'_n)) = h_n(St(U'_n, \mathcal{U}'_n)).$$

The covering \mathcal{U}'_n star-refines \mathcal{U}_n so for every $U'_n \in \mathcal{U}'_n$ there is an $U_n \in \mathcal{U}_n$ such that

$$h_n(St(U'_n, \mathcal{U}'_n)) \subset h_n(U_n),$$

which obviously implies that for every $U'_n \in \mathcal{U}'_n$ there is an $U_n \in \mathcal{U}_n$ such that

$$h_n(U'_n) \cup h_{n+1}(U'_n) \subset h_n(St(U'_n, \mathcal{U}'_n)) \subset h_n(U_n).$$

Let \mathcal{S} be a \mathcal{D} -saturated open cover of X with the following properties:

- (i) the elements of \mathcal{S} are nbhds of the elements of \mathcal{D} such that the diameter of each $h_{n+1}(S)$, where $S \in \mathcal{S}$, is smaller than ε_{n+1} (in the case of $S \cap C_{n+1} \neq \emptyset$ if X is σ -compact),
- (ii) \mathcal{S} refines the collection of ε_{n+1} -nbhds of the elements of \mathcal{D} ,
- (iii) \mathcal{S} also refines the \mathcal{D} -saturated coverings
 - (a) \mathcal{U}'_n and
 - (b) the collection $\{\pi^{-1}(B_{\varepsilon_{n+1}}(y)) : y \in X_{\mathcal{D}}\}$,
- (iv) for every $S \in \mathcal{S}$ there is a $U_n \in \mathcal{U}_n$ such that

$$h_n(S) \cup h_{n+1}(S) \subset h_n(U_n).$$

Let \mathcal{U}_{n+1} be the π -preimage of an open cover of $X_{\mathcal{D}}$ which star-refines the open cover $\pi(\mathcal{S})$. It follows that \mathcal{U}_{n+1} star-refines \mathcal{S} . After we defined \mathcal{U}_{n+1} and h_{n+1} let us check if $\mathcal{U}_0, \dots, \mathcal{U}_{n+1}$ and h_0, \dots, h_{n+1} satisfy the conditions (1) and (2) on page 28. The cover \mathcal{U}_{n+1} refines the cover \mathcal{U}_n because \mathcal{U}'_n refines \mathcal{U}_n , \mathcal{S} refines \mathcal{U}'_n by (iii)(a) and \mathcal{U}_{n+1} refines \mathcal{S} . So (1)(a) holds. Also (1)(b) holds because of (ii) and (iii)(b). To prove (2)(a) observe that for every $D \in \mathcal{D}$ the set $St(D, \mathcal{U}_{n+1})$ is a subset of $St(U, \mathcal{U}_{n+1})$ for some $U \in \mathcal{U}_{n+1}$. Then $St(D, \mathcal{U}_{n+1}) \subset S$ for some $S \in \mathcal{S}$ since \mathcal{U}_{n+1} star-refines \mathcal{S} . By (iv) there exists a $U \in \mathcal{U}_n$ such that

$$h_n(S) \cup h_{n+1}(S) \subset h_n(U)$$

so

$$h_n(St(D, \mathcal{U}_{n+1})) \cup h_{n+1}(St(D, \mathcal{U}_{n+1})) \subset h_n(U).$$

But every $U' \in \mathcal{U}_{n+1}$ which contains D is in $St(D, \mathcal{U}_{n+1})$ so we have

$$h_n(U') \cup h_{n+1}(U') \subset h_n(U),$$

which proves (2)(a). Finally, the diameter of each $h_{n+1}(U)$, $U \in \mathcal{U}_{n+1}$, is smaller than ε_{n+1} (if $U \cap C_{n+1} \neq \emptyset$ in the case of σ -compact X), because \mathcal{U}_{n+1} refines \mathcal{S} and we can apply (i).

Constructing the near-homeomorphism. After having these infinitely many \mathcal{D} -saturated open coverings

$$\mathcal{U}_0, \mathcal{U}_1, \dots$$

and homeomorphisms

$$h_0, h_1, \dots$$

take the map

$$\chi: X \rightarrow X$$

that we obtained applying (4.2) and defined to be the pointwise limit of the sequence h_n . At first, we show that χ is surjective. Let $x \in X$ and $x_n = h_{n+1}^{-1}(x)$. Let $D_n \in \mathcal{D}$ be such that $x_n \in D_n$, then by (2)(a) we get a nbhd $U_n \in \mathcal{U}_n$ of D_n such that for every $U' \in \mathcal{U}_{n+1}$ containing D_n we have

$$h_n(U') \cup h_{n+1}(U') \subset h_n(U_n).$$

In this way we get a decreasing sequence

$$U_1 \supset U_2 \supset \dots \supset U_n \supset \dots$$

because of the following. It is enough to show that $D_n \subset U_{n+1}$ as well, then by (2)(a) we obtain $h_n(U_{n+1}) \subset h_n(U_n)$ so $U_{n+1} \subset U_n$. But $D_n \subset U_{n+1}$ because

$$h_{n+2}(V) \subset h_{n+1}(U_{n+1})$$

by (2)(a) for every $V \in \mathcal{U}_{n+2}$ containing D_{n+1} , so we also have

$$h_{n+2}(x_{n+1}) \in h_{n+2}(D_{n+1}) \subset h_{n+2}(V),$$

which implies

$$x \in h_{n+1}(U_{n+1})$$

hence

$$h_{n+1}(x_n) \in h_{n+1}(U_{n+1}) \quad \text{and so} \quad x_n \in U_{n+1}$$

but U_{n+1} is \mathcal{D} -saturated hence also $D_n \subset U_{n+1}$.

The sequence (x_n) has a Cauchy (hence convergent) subsequence: since $x_n \in U_n$, for all $k \geq 0$

$$x_{n+k} \in U_n$$

and for every $\varepsilon > 0$ there is $\varepsilon_n < \varepsilon$ such that U_n is in the ε -nbhd of some $D \in \mathcal{D}$ by (1)(b). Since the metric space X is complete, there is an $x_0 \in X$ such that a subsequence (x_{n_k}) of (x_n) converges to x_0 .

All of these imply that because of the definition of χ and the locally uniform convergence of h_n we have

$$\chi(x_0) = \lim_{k \rightarrow \infty} h_{n_k+1}(x_{n_k}) = \lim_{k \rightarrow \infty} x = x.$$

This means χ is surjective.

It will turn out that χ is not injective so it is not a homeomorphism. However, the composition $\pi \circ \chi^{-1}$ of the relation χ^{-1} and the decomposition map π is a homeomorphism. To see this, we show that the sets $\chi^{-1}(x)$, where $x \in X$, are exactly the decomposition elements of \mathcal{D} . By (4.2) for every $n \in \mathbb{N}$ and $D \in \mathcal{D}$ there is a nbhd $U \in \mathcal{U}_n$ of D such that for every $k \geq 0$

$$h_{n+k}(D) \subset h_n(U)$$

hence

$$\chi(D) = \lim_{k \rightarrow \infty} h_{n+k}(D) \subset \text{cl } h_n(U).$$

It is a fact that $\text{diam cl } A = \text{diam } A$ for an arbitrary subset A of a metric space so by (2)(b) we obtain $\chi(D) < \varepsilon_n$ for each n and by (2)(b') for some $C_m \supset D$ we obtain $\chi(D) < \varepsilon_n$ for each $n \geq m$, which implies that $\chi(D)$ is a point. To show that the χ -preimage of a point is not bigger than a decomposition element, observe that for different elements D_1 and D_2 and for large enough n by (1)(b) there are $U, V \in \mathcal{U}_n$ which lie in the small ε_n -nbhds of D_1 and D_2 , respectively, hence U and V are disjoint. Then similarly to above,

$$\chi(D_1) \subset \text{cl } h_n(U) \quad \text{and} \quad \chi(D_2) \subset \text{cl } h_n(V),$$

which implies that $\chi(D_1)$ and $\chi(D_2)$ are different so the sets $\chi^{-1}(x)$, where $x \in X$, are exactly the decomposition elements of \mathcal{D} .

This means that $\pi \circ \chi^{-1}$ is a bijection. Its inverse is continuous because χ is continuous and π is a closed map since the decomposition is usc. To prove that $\pi \circ \chi^{-1}$ is continuous it is enough to show that χ is a closed map. Let $A \subset X$ be a closed set and observe that a point $y \in X$ is in $X - \chi(A)$ if and only if $\chi^{-1}(y) \cap \chi^{-1}(\chi(A)) = \emptyset$, which holds exactly if $\chi^{-1}(y) \cap \pi^{-1}(\pi(A)) = \emptyset$. This means that in order to show that $\chi(A)$ is closed it is enough to prove that for any decomposition element D such that $D \cap \pi^{-1}(\pi(A)) = \emptyset$ the point $\chi(D)$ is an inner point of $X - \chi(A)$. If ε_n is small enough, then since $D \cap \pi^{-1}(\pi(A)) = \emptyset$, by (1)(b) for every $U_n \in \mathcal{U}_n$ containing D we have

$$\text{cl } U_n \cap \text{cl } St(A, \mathcal{U}_n) = \emptyset.$$

By (4.2) we have $\chi(D) \in h_n(\text{cl } U_n)$ and obviously

$$\chi(A) \subset h_n(\text{cl } St(A, \mathcal{U}_n)) = \text{cl } h_n(St(A, \mathcal{U}_n))$$

so finally we get

$$\chi(D) \in X - \text{cl } h_n(St(A, \mathcal{U}_n)) \subset X - \chi(A)$$

implying that $\chi(D)$ is an inner point of $X - \chi(A)$. As a consequence the map $\pi \circ \chi^{-1}$ is a homeomorphism. We have to prove that it is \mathcal{W} -close to the identity. By (4.1) for every D and for all n there exist $U_n \in \mathcal{U}_n$ nbhds of D such that

$$U_0 = h_0(U_0) \supset h_1(U_1) \supset \cdots \supset h_n(U_n) \supset \cdots .$$

So $h_n(D) \in U_0$ for every n and then $\chi(D) \in \text{cl}U_0$. Since the collection of the closures of the elements in \mathcal{U}_0 refines the cover $\pi^{-1}(\mathcal{W})$, both of D and $\chi(D)$ are in the same $\pi^{-1}(W) \in \mathcal{W}$. This implies that if we denote $\chi(D)$ by x , then both of $\chi^{-1}(x)$ and x are in $\pi^{-1}(W)$. As a result $\chi(\chi^{-1}(x)) = x$ and $\chi(x)$ are in $\chi(\pi^{-1}(W))$ so by applying the map $\pi \circ \chi^{-1}$ we get that

$$\pi \circ \chi^{-1}(x) \quad \text{and} \quad \pi \circ \chi^{-1}(\chi(x)) = \pi(x)$$

are in W . This shows that $\pi \circ \chi^{-1}$ is \mathcal{W} -close to π . \square

The goal of most of the applications of shrinking is to obtain some kind of embedding of a manifold by the process of approximating a given map. Let \mathbb{R}_+^d denote the closed halfspace in \mathbb{R}^d .

DEFINITION 4.5 (Flat subspace and locally flat embedding). Let $A \subset X$ be a chosen subspace of a topological space X . We say that the subspace $B \subset X$ homeomorphic to A is *flat* if there is a homeomorphism $h: X \rightarrow X$ such that $h(B) = A$. Let X be an n -dimensional manifold. An embedding $e: B \rightarrow X$ of a d -dimensional manifold B is *locally flat* if every point $e(b)$ has a nbhd U in X such that the pair

$$(U, e(B) \cap U) \text{ is homeomorphic to } \begin{cases} (\mathbb{R}^n, \mathbb{R}^d) & \text{if } b \text{ is an inner point of } B \\ (\mathbb{R}^n, \mathbb{R}_+^d) & \text{if } b \text{ is a boundary point of } B. \end{cases}$$

DEFINITION 4.6 (Collared and bicollared subspaces). The subspace $A \subset X$ is *collared* if there is an embedding $f: A \times [0, 1) \rightarrow X$ onto an open subspace of X such that $f(a, 0) = a$. The subspace $A \subset X$ is *bicollared* if there is an embedding $f: A \times (-1, 1) \rightarrow X$ such that $f(a, 0) = a$. The subspace $A \subset X$ is *locally collared* (or *locally bicollared*) if every $a \in A$ has a nbhd U in X such that $A \cap U$ is collared (resp. bicollared).

A typical application of shrinking is the following.

THEOREM 4.7. *Let X be an n -dimensional manifold with boundary ∂X . Then ∂X is collared in X .*

PROOF. Attach the manifold $\partial X \times [0, 1]$ to X along $\partial X \subset X$ by the identification

$$\begin{aligned} \varphi: \partial X \times \{0\} &\rightarrow X, \\ \varphi(x, 0) &= x. \end{aligned}$$

In this way we get a manifold \tilde{X} , which contains the attached $\partial X \times [0, 1]$ as a subset. The boundary of \tilde{X} is $\partial X \times \{1\}$ and so the boundary $\partial \tilde{X}$ is obviously collared.

Let \mathcal{D} be the decomposition of \tilde{X} into the intervals $\{\{x\} \times [0, 1] : x \in \partial X\}$ and the singletons in $\tilde{X} - \partial X \times [0, 1]$. Then X and the quotient space $\tilde{X}_{\mathcal{D}}$ are homeomorphic by the map

$$\begin{aligned} \alpha: X &\rightarrow \tilde{X}_{\mathcal{D}}, \\ \alpha(x) &= [x], \end{aligned}$$

where $[x]$ denotes the equivalence class of x . Indeed, α is a bijection mapping $X - \partial X$ to the classes consisting of single points and mapping the boundary points $x \in \partial X$ to the class $[x]$. It is easy to see that α and also α^{-1} are continuous so α is a homeomorphism. If we prove that \tilde{X} is also homeomorphic to the decomposition space $\tilde{X}_{\mathcal{D}}$ by a map β as the diagram

$$\begin{array}{ccc} X & & \tilde{X} \\ & \searrow \alpha & \swarrow \beta \\ & \tilde{X}_{\mathcal{D}} & \end{array}$$

shows, then we obtain that X and \tilde{X} are homeomorphic through the map $\beta^{-1} \circ \alpha$, which finishes the proof. A homeomorphism β exists if we prove that \mathcal{D} is shrinkable because then $\pi: \tilde{X} \rightarrow \tilde{X}_{\mathcal{D}}$ is a near-homeomorphism. Let \mathcal{V} be an arbitrary open cover of \tilde{X} and let \mathcal{U} be a \mathcal{D} -saturated open cover of \tilde{X} . Let \mathcal{W} be a refinement of \mathcal{V} such that \mathcal{W} contains all the small nbhds of the form $U_x \times [1, 1 - \varepsilon_x)$ for all $(x, 1) \in \partial \tilde{X}$ and for some appropriate $\varepsilon_x > 0$ and relative nbhd $U_x \subset \partial X$. We also suppose that in \mathcal{W} the nbhds of the inner points of \tilde{X} are only these or such nbhds which do not intersect $\partial \tilde{X}$. We will apply Theorem 4.4. Let $C \subset \tilde{X}$ be a compact set and let $E \subset \tilde{X}$ be a compact set containing the attached $\{x\} \times [0, 1]$ for all $(x, 1) \in \partial \tilde{X}$ such that $\{x\} \times [0, 1]$ intersects C . Since E is compact, there are finitely many nbhds in \mathcal{W} and also in \mathcal{U} which cover E . Let us restrict ourselves to these finitely many nbhds. Let $\varepsilon > 0$ be such that $\varepsilon < \varepsilon_x$ for all these finitely many points $(x, 1) \in \partial \tilde{X}$. Let U be the union of the chosen finitely many nbhds in \mathcal{U} and let $\delta > 0$ be such that for a metric on \tilde{X} the δ -nbhd of

$$\bigcup_{(x,1) \in \partial \tilde{X} \cap E} \{x\} \times [0, 1]$$

is inside U . Then define a homeomorphism $h: \tilde{X} \rightarrow \tilde{X}$ which maps

$$\bigcup_{(x,1) \in \partial \tilde{X} \cap E} \{x\} \times [0, 1]$$

into

$$\bigcup_{(x,1) \in \partial \tilde{X} \cap E} \{x\} \times [1, 1 - \varepsilon]$$

by mapping each arc $\{x\} \times [0, 1]$, where $(x, 1) \in \partial \tilde{X}$, into itself. We suppose that the support of h is inside the $\delta/2$ -nbhd of $\bigcup_{(x,1) \in \partial \tilde{X} \cap E} \{x\} \times [0, 1]$. This h

satisfies (3) of Theorem 4.4 so π is a near-homeomorphism which yields the claimed homeomorphism β . \square

5. Shrinkable decompositions

The following notions are often used to describe types of decompositions which turn out to be shrinkable.

DEFINITION 5.1. Let \mathcal{D} be a usc decomposition of \mathbb{R}^n .

- \mathcal{D} is *cell-like* if every decomposition element is cell-like,
- \mathcal{D} is *cellular* if every decomposition element is cellular,
- the decomposition elements are *flat arcs* if for every $D \in \mathcal{D}$ there is a homeomorphism $h: \mathbb{R}^n \rightarrow \mathbb{R}^n$ such that $h(D)$ is a straight line segment,
- \mathcal{D} is *starlike* if every decomposition element D is a starlike set, that is, D is a union of compact straight line segments with a common endpoint $x_0 \in \mathbb{R}^n$,
- \mathcal{D} is *starlike-equivalent* if for every $D \in \mathcal{D}$ there is a homeomorphism $h: \mathbb{R}^n \rightarrow \mathbb{R}^n$ such that $h(D)$ is starlike,
- \mathcal{D} is *thin* if for every $D \in \mathcal{D}$ and every nbhd U of D there is an n -dimensional ball $B \subset \mathbb{R}^n$ such that $D \subset B \subset U$ and ∂B is disjoint from the non-degenerate elements of \mathcal{D} ,
- \mathcal{D} is *locally shrinkable* if for each $D \in \mathcal{D}$ we have that for every nbhd U of D and open cover \mathcal{V} of \mathbb{R}^n there is a homeomorphism $h: \mathbb{R}^n \rightarrow \mathbb{R}^n$ with support U such that $h(D) \subset V$ for some $V \in \mathcal{V}$,
- \mathcal{D} *inessentially spans* the disjoint closed subsets $A, B \subset \mathbb{R}^n$ if for every \mathcal{D} -saturated open cover \mathcal{U} of \mathbb{R}^n there is a homeomorphism $h: \mathbb{R}^n \rightarrow \mathbb{R}^n$ which is \mathcal{U} -close to the identity and no element of \mathcal{D} meets both of $h(A)$ and $h(B)$,
- the decomposition element D has *embedding dimension k* if for every $(n - k - 1)$ -dimensional smooth submanifold M of \mathbb{R}^n and open cover \mathcal{V} of \mathbb{R}^n there is a homeomorphism $h: \mathbb{R}^n \rightarrow \mathbb{R}^n$ which is \mathcal{V} -close to the identity, $h(M) \cap D = \emptyset$ and this is not true for $(n - k)$ -dimensional submanifolds.

Most of these notions have the corresponding versions in arbitrary manifolds or spaces. A condition that is obviously satisfied by at least 5-dimensional Euclidean spaces is the following.

DEFINITION 5.2 (Disjoint disks property). The metric space X has the *disjoint disks property* if for arbitrary maps f_1 and f_2 from D^2 to X and for every $\varepsilon > 0$ there are approximating maps g_i from D^2 to X ε -close to f_i , $i = 1, 2$, such that $g_1(D^2)$ and $g_2(D^2)$ are disjoint.

The next theorem [Ed78] is one of the fundamental results of decomposition theory, we omit its proof here.

THEOREM 5.3. *Let X be an at least 5-dimensional manifold and let \mathcal{D} be a cell-like decomposition of X . Then \mathcal{D} is shrinkable if and only if $X_{\mathcal{D}}$ is finite dimensional and has the disjoint disks property.*

Recall that a separable metric space is finite dimensional if every point has arbitrarily small nbhds having one less dimensional frontiers and dimension -1 is by definition the dimension of the empty set. For example, a manifold is finite dimensional.

In the following statement we enumerate several conditions which imply that a (usc) decomposition is shrinkable.

THEOREM 5.4. *The following decompositions are strongly shrinkable:*

- (1) *cell-like usc decompositions of a 2-dimensional manifold,*
- (2) *countable usc decompositions of \mathbb{R}^n if the decomposition elements are flat arcs,*
- (3) *countable and starlike usc decompositions of \mathbb{R}^n ,*
- (4) *countable and starlike-equivalent usc decompositions of \mathbb{R}^3 ,*
- (5) *null and starlike-equivalent usc decompositions of \mathbb{R}^n ,*
- (6) *thin usc decompositions of 3-manifolds,*
- (7) *countable and thin usc decompositions of n -dimensional manifolds,*
- (8) *countable and locally shrinkable usc decompositions of a complete metric space if $\cup \mathcal{H}_{\mathcal{D}}$ is G_{δ} ,*
- (9) *monotone usc decompositions of n -dimensional manifolds if \mathcal{D} inessentially spans every pair of disjoint, bicollared $(n-1)$ -dimensional spheres,*
- (10) *null and cell-like decompositions of smooth n -dimensional manifolds if the embedding dimension of every $D \in \mathcal{D}$ is $\leq n-3$,*

Before proving Theorem 5.4 let us make some observations and preparations. At first, note that there are usc decompositions of \mathbb{R}^3 into straight line segments which are not shrinkable: in the proof of Proposition 3.1 for any given compact metric space Y we constructed a decomposition of \mathbb{R}^3 into straight line segments and singletons such that Y is a subspace of the decomposition space. Since \mathbb{R}^3 is a complete metric space and the decomposition is usc it is also shrinkable if and only if π is approximable by homeomorphisms. This means that if Y cannot be embedded into \mathbb{R}^3 , then the decomposition space cannot be homeomorphic to \mathbb{R}^3 and then this decomposition is not shrinkable.

If the decomposition is countable, then we can shrink successively the decomposition elements if there is a guaranty of not expanding an already shrunken element while shrinking another one. The next proposition is a technical tool for this process.

PROPOSITION 5.5. *Let \mathcal{D} be a countable usc decomposition of a locally compact metric space X . Suppose for every $D \in \mathcal{D}$, for every $\varepsilon > 0$ and for every homeomorphism $f: X \rightarrow X$ there exists a homeomorphism $h: X \rightarrow X$ such that*

- (1) *outside of the ε -nbhd of D the homeomorphism h is the same as f ,*
- (2) *diam $h(D) < \varepsilon$ and*
- (3) *for every $D' \in \mathcal{D}$ we have $\text{diam } h(D') < \varepsilon + \text{diam } f(D')$.*

Then \mathcal{D} is strongly shrinkable.

SKETCH OF THE PROOF. Let $\varepsilon > 0$ and let \mathcal{U} be a \mathcal{D} -saturated open cover of X . We enumerate the non-degenerate elements of \mathcal{D} which have diameter at least $\varepsilon/2$ as D_1, D_2, \dots . We can find \mathcal{D} -saturated open sets U_1, U_2, \dots such that for all n we have $D_n \subset U_n$ and all sets U_n are pairwise disjoint or coincide. These U_n are subsets of sets in \mathcal{U} and they will ensure \mathcal{U} -closeness. We produce a sequence $\text{id} = h_0, h_1, \dots$ of self-homeomorphisms of X and a sequence C_1, C_2, \dots of \mathcal{D} -saturated closed nbhds of D_1, D_2, \dots , respectively, such that a couple of conditions are satisfied for every $n \geq 1$:

- (a) $h_n|_{X-U_n} = h_{n-1}|_{X-U_n}$,
- (b) $\text{diam } h_n(D_n) < \varepsilon$,
- (c) for every $D \in \mathcal{D}$ we have $\text{diam } h_n(D) < (1 - \frac{1}{2^n})\frac{\varepsilon}{2} + \text{diam } D$,
- (d) $h_{n+1}|_{C_1 \cup \dots \cup C_n} = h_n|_{C_1 \cup \dots \cup C_n}$,
- (e) if some $D \in \mathcal{D}$ is in C_n , then $\text{diam } h_n(D) < \varepsilon$ and
- (f) $h_n = h_{n-1}$ if $\text{diam } h_{n-1}(D_n) < \varepsilon$.

The sets C_n serve as protective buffers in which no further motion will occur. For $n = 1$ by the conditions (1), (2) and (3) in the statement of Proposition 5.5 with the choice $f = \text{id}$ we can find a homeomorphism $h_1: X \rightarrow X$ satisfying (a), (b) and (c) and also an appropriate C_1 such that (d) and (e) are satisfied as well. If h_k and C_k are defined already for $1 \leq k \leq n$, then we find h_{n+1} and C_{n+1} as follows. If $\text{diam } h_n(D_{n+1}) < \varepsilon$, then let $h_{n+1} = h_n$. If the diameter of $h_n(D_{n+1})$ is at least ε , then by the conditions (1), (2) and (3) with the choice $f = h_n$ we can find a homeomorphism $h_{n+1}: X \rightarrow X$ satisfying

- (i) $h_{n+1}|_{X-U_{n+1}} = h_n|_{X-U_{n+1}}$
- (ii) $\text{diam } h_{n+1}(D_{n+1}) < \varepsilon/2^{n+2}$,
- (iii) for every $D \in \mathcal{D}$ we have $\text{diam } h_{n+1}(D) < \varepsilon/2^{n+2} + \text{diam } h_n(D)$

furthermore (iii) and (c) imply that for every $D \in \mathcal{D}$ we have

$$\text{diam } h_{n+1}(D) < \varepsilon/2^{n+2} + \left(1 - \frac{1}{2^n}\right)\frac{\varepsilon}{2} + \text{diam } D = \left(1 - \frac{1}{2^{n+1}}\right)\frac{\varepsilon}{2} + \text{diam } D$$

so (a), (b) and (c) are satisfied. It is not too difficult to get (d) and (e) with some C_{n+1} as well. After having all h_1, h_2, \dots and C_1, C_2, \dots with properties (a)-(f) it is easy to see by (d), (e) and (f) that every $D \in \mathcal{D}$ which is in $C_1 \cup \dots \cup C_n$ is

shrunk by h_n to size smaller than ε and other h_{n+i} does not modify this. If some $D \in \mathcal{D}$ had diameter smaller than $\varepsilon/2$ originally, then (c) implies that its diameter is smaller than ε during all the process. These imply that the sequence h_1, h_2, \dots is locally stationary and it converges to a shrinking homeomorphism h . \square

We are going to give a sketch of the proof of Theorem 5.4. For the detailed proof of (1) see [Mo25], for the proofs of (2) and (3) see [Bi57], for the proof of (4) see [DS83], for (5) see [Be67], for (6) see [Wo77] and for (7), (8), (9) and (10) see [Pr66], [Bi57], [Ca78] and [Ca79, Ed16], respectively.

SKETCH OF THE PROOF OF THEOREM 5.4. (1) follows from the fact that in a 2-dimensional manifold X a cell-like decomposition is thin. The reason of this is that an arbitrarily small 2-dimensional disk nbhd B with the property $\partial B \cap (\cup \mathcal{H}_{\mathcal{D}}) = \emptyset$ can be obtained by finding the circle ∂B in X as a limit of a sequence of maps $f_n: S^1 \rightarrow X$ avoiding smaller and smaller decomposition elements. A thin usc decomposition of a 2-dimensional manifold is shrinkable if the points of $\pi(\cup \mathcal{H}_{\mathcal{D}})$ do not converge to each other in a too complicated way. Since the quotient space $X_{\mathcal{D}}$ can be filtered in a way which implies this, the decomposition map π can be successively approximated by maps which are homeomorphisms on the induced filtration in X .

(2)-(5) follows from Proposition 5.5: the flat arcs, starlike sets and starlike-equivalent sets can be shrunk successively because of geometric reasons.

To prove (6) and (7) we also use Proposition 5.5. Let $D \in \mathcal{D}$ be a non-degenerate decomposition element, U a nbhd of D and let B be a ball such that $D \subset B \subset U$ and ∂B is disjoint from the non-degenerate elements of \mathcal{D} . After applying a self-homeomorphism of X , we can suppose that B is the unit ball. Let k be some large enough integer and let $1 > \delta_0 > \delta_1 > \dots > \delta_{k-1} > 0$ be such that if $D' \in \mathcal{D}$ intersects the δ_{n+1} -nbhd of ∂B , then D' is inside the δ_n -nbhd of ∂B . Define a homeomorphism $f: B \rightarrow B$ which is the identity on ∂B , keeps the center of B fixed and on each radius R the point at distance δ_n from ∂B , where $1 \leq n \leq k-1$, is mapped to the point at distance n/k from the center. We require that the homeomorphism f is linear between these points. After applying this homeomorphism, every $D' \in \mathcal{D}$ in B is shrunk to size small enough.

In the proof of (8) we enumerate the non-degenerate decomposition elements and we construct a sequence of homeomorphisms of the ambient space which shrink the decomposition elements successively using the locally shrinkable property.

To prove (9) for a given $\varepsilon > 0$ we cover the manifold by two collections $\{B_{\alpha}\}_{\alpha \in A}$ and $\{B'_{\alpha}\}_{\alpha \in A}$ of n -dimensional balls such that $B_{\alpha} \subset \text{int } B'_{\alpha}$ and $\text{diam } B'_{\alpha} < \varepsilon$. Then the closed sets $\pi(\partial B_{\alpha})$ and $\pi(\partial B'_{\alpha})$ are made disjoint by applying homeomorphisms h_{α} successively. This implies that the homeomorphism h obtained by composing all the homeomorphisms h_{α} is such that for every $D \in \mathcal{D}$ the set $h(D)$ is fully contained in some ball B'_{α} so its diameter is smaller than ε .

In the proof of (10) at first we obtain that every decomposition element D is cellular because of the following. By assumption D is cell-like and it behaves like an at most $(n - 3)$ -dimensional submanifold so the 2-skeleton of the ambient manifold is disjoint from D . This means that D satisfies the cellularity criterion since the 2-skeleton carries the fundamental group. Hence D is cellular, which implies that it is contained in an n -dimensional ball and also in a starlike-equivalent set C of embedding dimension $\leq n - 2$. Now it is possible to use an argument similar to the proof of Proposition 5.5: we can shrink C to become smaller than an $\varepsilon > 0$ by successively compressing C and in each iteration carefully controlling and avoiding other decomposition elements close to C which would become too large during the compression procedure. \square

References

- [Al27] P. S. Alexandroff, Über stetige Abbildungen kompakter Räume, *Math. Ann.* **96** (1927), 555–571.
- [AC79] F. D. Ancel and J. W. Cannon, The locally flat approximation of cell-like embedding relations, *Ann. of Math.* **109** (1979), 61–86.
- [Be67] R. J. Bean, Decompositions of E^3 with a null sequence of starlike equivalent nondegenerate elements are E^3 , *Illinois J. Math.* **11** (1967), 21–23.
- [BKKPR] S. Behrens, B. Kalmár, M. H. Kim, M. Powell, and A. Ray, editors, *The disc embedding theorem*, Oxford University Press, to appear.
- [Bi52] R. H. Bing, A Homeomorphism Between the 3-Sphere and the Sum of Two Solid Horned Spheres, *Ann. of Math.* **56** (1952), 354–362.
- [Bi55] ———, Partially continuous decompositions, *Proceedings of the Amer. Math. Soc.* (1955), 124–133.
- [Bi57] ———, Upper semicontinuous decompositions of E^3 , *Ann. of Math.* **65** (1957), 363–374.
- [Bi83] ———, *The geometric topology of 3-manifolds*, Amer. Math. Soc., 1983.
- [Ca78] J. W. Cannon, $(E^3/X) \times E^1 \approx E^4$ (X , a cell-like set): an alternative proof, *Trans. Amer. Math. Soc.* **240** (1978), 277–285.
- [Ca79] ———, Shrinking cell-like decompositions of manifolds. Codimension three, *Ann. of Math.* **110** (1979), 83–112.
- [Da86] R. J. Daverman, *Decompositions of manifolds*, Academic Press, 1986.
- [DV09] R. J. Daverman and G. A. Venema, *Embeddings in manifolds*, Amer. Math. Soc., 2009.
- [DS83] R. Denman and M. Starbird, Shrinking countable decomposition of S^3 , *Trans. Amer. Math. Soc.* **276** (1983), 743–756.
- [Du66] J. Dugundji, *Topology*, Allyn and Bacon, 1966.
- [Ed78] R. D. Edwards, The topology of manifolds and cell-like maps, *Proc. Inter. Cong. Math.*, Helsinki 1978, 111–127.
- [Ed16] ———, Approximating certain cell-like maps by homeomorphisms, arXiv:1607.08270.
- [Fr82] M. H. Freedman, The topology of four-dimensional manifolds, *J. Diff. Geom.* **17** (1982), 357–453.
- [FQ90] M. H. Freedman and F. Quinn, *Topology of 4-manifolds*, Princeton Univ. Press, Princeton, N.J., 1990.
- [Ha27] F. Hausdorff, *Mengenlehre*, zweite, neubearbeitete Auflage, Verlag Walter de Gruyter & Co., Berlin, 1927.
- [HW41] W. Hurewicz and H. Wallman, *Dimension theory*, Princeton University Press, 1941.
- [Iz88] S. A. Izar, Funcoes de Morse e topologia das superficies I: O grafo de Reeb de $f: M \rightarrow \mathbb{R}$, *Metrica* no. 31, Estudo e Pesquisas em Matematica, IBILCE, Brazil, 1988.
- [Mo25] R. L. Moore, Concerning upper semicontinuous collections of compacta, *Trans. Amer. Math. Soc.* **27** (1925), 416–428.
- [NW37] M. H. A. Newman and J. H. C. Whitehead, On the group of a certain linkage, *The Quarterly Journal of Mathematics*, **8** (1937), 14–21.

- [Pr66] T. M. Price, A necessary condition that a cellular upper semicontinuous decomposition of E^n yield E^n , *Trans. Amer. Math. Soc.* **122** (1966), 427–435.
- [Re46] G. Reeb, Sur les points singuliers d’une forme de Pfaff complètement integrable ou d’une fonction numérique, *Comptes Rendus Hebdomadaires des Seances de l’Academie des Sciences* 222 (1946), 847–849.
- [Sa20] O. Saeki, Reeb spaces of smooth functions on manifolds, arXiv:2006.01689
- [St56] A. H. Stone, Metrizable Decomposition Spaces, *Proc. of the Amer. Math. Soc.* **7** (1956), 690–700.
- [Wh35] J. H. C. Whitehead, *The Quarterly Journal of Mathematics*, **6** (1935), 268–279.
- [Wo77] E. P. Woodruff, Decomposition spaces having arbitrarily small neighborhoods with 2-sphere boundaries, *Trans. Amer. Math. Soc.* **232** (1977), 195–204.
- [Yo18] S. Yokura, On decomposition spaces, Alexandroff spaces and related topics, *RIMS* (2018), 5–26.