

Bounded Dyck paths, bounded alternating sequences, orthogonal polynomials, and reciprocity

J. CIGLER AND C. KRATTENTHALER[†]

Fakultät für Mathematik, Universität Wien,
Oskar-Morgenstern-Platz 1, A-1090 Vienna, Austria.
WWW: <http://homepage.univie.ac.at/johann.cigler>
WWW: <http://www.mat.univie.ac.at/~kratt>

ABSTRACT. The theme of this article is a “reciprocity” between bounded up-down paths and bounded alternating sequences. Roughly speaking, this “reciprocity” manifests itself by the fact that the extension of the sequence of numbers of paths of length n , consisting of diagonal up- and down-steps and being confined to a strip of bounded width, to negative n produces numbers of alternating sequences of integers that are bounded from below and from above. We show that this reciprocity extends to families of non-intersecting bounded up-down paths and certain arrays of alternating sequences which we call alternating tableaux. We provide as well weighted versions of these results. Our proofs are based on Viennot’s theory of heaps of pieces and on the combinatorics of non-intersecting lattice paths. An unexpected application leads to a refinement of a result of Bousquet-Mélou and Viennot on the width-height-area generating function of parallelogram polyominoes. Finally, we exhibit the relation of the arising alternating tableaux to plane partitions of strip shapes.

1. Introduction. *Reciprocity* is a much used term in mathematics. The immediate association is with the quadratic reciprocity law of number theory and its numerous generalisations and variations. In combinatorics, however, “reciprocity” has a different meaning. The term “reciprocity law” was introduced by Richard Stanley in [31]. It refers to a situation where we encounter numbers a_n , for $n \geq 0$, with a_n being the number of certain combinatorial objects of “size” n . If these numbers a_n satisfy a linear recurrence with constant coefficients then we may extend the sequence $(a_n)_{n \geq 0}$ to *negative* integers n by applying the recurrence “backwards”. If it should happen that $|a_n|$, for $n < 0$, has a combinatorial meaning as well, then we speak of a (*combinatorial*) “*reciprocity law*”. The simplest case of such a (combinatorial) “reciprocity law” occurs when one considers the binomial coefficients $\binom{n}{k}$ (for fixed k), giving the number of subsets of cardinality k of

2020 *Mathematics Subject Classification.* Primary 05A15; Secondary 05A19 05A30 11C20 15A15 33C45 42C05.

Key words and phrases. Dyck paths, ballot paths, alternating sequences, heaps of pieces, non-intersecting lattice paths, tableaux, plane partitions, parallelogram polyominoes, Chebyshev polynomials, orthogonal polynomials, combinatorial reciprocity law.

[†]Research partially supported by the Austrian Science Foundation FWF (grant S50-N15) in the framework of the Special Research Program “Algorithmic and Enumerative Combinatorics”.

$\{1, 2, \dots, n\}$ on the one hand, and $|\binom{-n}{k}| = \binom{n+k-1}{k}$, giving the number of submultisets (i.e., “sets” where repeated elements are allowed) of cardinality k of $\{1, 2, \dots, n\}$, on the other hand. The most well-known non-trivial instance of this phenomenon is *Ehrhart–Macdonald reciprocity* for counting integer points in polytopes, generalised by Stanley in [31] (see also [34, Theorem 4.5.14]). As a matter of fact, a whole book has been devoted to this kind of “reciprocity”, see [3]. For further instances of combinatorial reciprocity laws see [1, 9, 27, 29, 30, 33].

The subject of this article is a reciprocity relation that seemingly has not been noticed earlier. It is a reciprocity between *up-down paths* whose height is bounded from below and from above and *alternating sequences* whose elements are bounded from below and from above. More precisely, let $C_{2n}^{(k)}$ denote the number of paths with steps $(1, 1)$ and $(1, -1)$ starting at $(0, 0)$ and ending at $(2n, 0)$ never passing below the x -axis and never passing above the horizontal line $y = k$. (These paths are also known as bounded *Dyck paths*.) It is not difficult to see — and well-known — that, for fixed k , the numbers $C_{2n}^{(k)}$ satisfy a linear recurrence with constant coefficients in n .¹ This recurrence can also be applied in the backwards direction, thus defining numbers $C_{2n}^{(k)}$ for *negative* integers n . With this notation, the first author observed that

$$\det \left(C_{2n+2i+2j+2}^{(2k+1)} \right)_{0 \leq i, j \leq k-1} = C_{-2n}^{(2k+1)}. \quad (1.1)$$

He posted this conjecture on [MathOverflow](#). In response, Stanley identified the number $C_{-2n}^{(2k+1)}$ as the number of sequences $a_1 \leq a_2 \geq a_3 \leq a_4 \geq a_5 \geq \dots \geq a_{2n-1}$ of integers with $1 \leq a_i \leq k+1$ for all i . (See Corollary 13 with k replaced by $k+1$ for a formal proof; in his posting, Stanley referred to [35, Ex. 3.66] and [32, Ex. 3.2].) With this observation, and the observation that the determinant on the left-hand side of (1.1) can be interpreted as the number of families of non-intersecting bounded Dyck paths, it is then rather simple to confirm the above reciprocity law, see the proof of Theorem 15 with $m = 1$.

As it turned out, the relation (1.1) is just the peak of an iceberg. In this article — so-to-speak — we “unearth” the iceberg (or rather: “lift the iceberg out of the sea”).

The first manifestation of this “iceberg” arises if we lift the upper bound $2k+1$ on the height of the paths to $2k+2m-1$, where m is a positive integer. Then there is still a reciprocity relation, where on the right-hand side a *determinant* of numbers of paths “with negative length” has to be placed; see Theorem 15 in Section 5.² For the proof, a bijection is set up between families of non-intersecting Dyck paths and certain arrays of integers of trapezoidal shape in which each row is an alternating sequence of odd length, see Proposition 16. Due to their resemblance to semistandard tableaux (cf. e.g. [34, Sec. 7.10] for their definition), we call these arrays *alternating tableaux*. The key for the proof of

¹Equivalently, the generating function $\sum_{n \geq 0} C_{2n}^{(k)} x^{2n}$ is rational. Theorem 1 with $r = s = 0$ shows that this is indeed the case.

²We apologise to the reader that our presentation in this introduction follows the order in which things and ideas developed, which is not entirely the same order as they appear in the article. We will come back to Sections 2–4 in our presentation shortly; in a sense, these sections contain preparatory material for the later sections.

Theorem 15 is to show that these alternating tableaux of trapezoidal shape are counted by the determinant on the right-hand side of (5.1), which is done in Theorem 17.

Section 6 presents a second manifestation of the mentioned “iceberg”, with many parallels to the first manifestation: it is a reciprocity between bounded up-down paths starting at height 0 and *ending at the maximally allowed height* and bounded alternating sequences of *even* length. The main theorem of Section 6 is Theorem 18, which is analogous to Theorem 15. It is based on a bijection between families of non-intersecting up-down paths of the described kind and alternating tableaux of *rhomboidal* shape in which each row has even length, see Proposition 19, and the proof in Theorem 20 that these rhomboidal alternating tableaux are counted by the determinant on the right-hand side of (6.1).

However, the reciprocity between bounded up-down paths and alternating sequences occurs even at a finer level. It is known that generating functions for the numbers of bounded up-down paths with specified starting and ending height can be expressed as fractions involving Chebyshev polynomials of the second kind, see Theorem 1 in Section 2. In Section 3, we show that the same is true for generating functions for bounded alternating sequences with specified first and last element, see Theorem 4. Although both theorems could be proved using recurrence relations and matrix algebra, here we present proofs that use Viennot’s [37] theory of heaps of pieces. A comparison of the two results then entails further reciprocity relations, see Section 4.

This finer reciprocity relation leads to a third manifestation of the “iceberg”, which is the subject of Section 7. The main results of this section are Theorems 21 and 24 presenting equalities between a determinant of numbers of bounded up-down paths with positive lengths with specified starting and ending heights and a similar determinant where however the path lengths are negative. Here the proof is based on a bijection between families of non-intersecting paths with given starting and ending points and *flagged* alternating tableaux of *rectangular* shape, “flagged” meaning that the first and last entry in each row is specified, see Propositions 22 and 25. Theorems 23 and 26 then show that these alternating tableaux of rectangular shape are counted by the determinants on the right-hand sides of (7.1) and (7.5), respectively.

Sections 8–11 are complements to the material in Sections 2–7. First, the reader may wonder whether weights could be introduced in the enumeration results in Sections 2–7. Sections 8–10 are devoted to the derivation of the weighted generalisations of these results. Here, the Chebyshev polynomials are replaced by more general orthogonal polynomials $P_n(x)$ that are even for even n and odd for odd n . Section 8 addresses the weighted enumeration of bounded up-down paths and bounded alternating sequences, the main results being Theorems 27 and 28. In Section 9, we extend the enumeration results of Section 4 for paths “with negative length” to the weighted setting. Section 10 then compiles the weighted versions of the reciprocity laws from Sections 5–7, see Theorems 34, 37, 41, and 44. Remarkably, one of these, namely Theorem 37, implies a general reciprocity relation between Hankel determinants of sequences that satisfy a linear recurrence with constant coefficients, see Theorem 40.

Second, the enumeration of alternating tableaux plays an important role in Sections 5–7. The purpose of Section 11 is to show that these enumeration results are actually special cases of two fundamental theorems for alternating tableaux, see Theorems 47 and 48. In

the second part of that section, we explain that alternating tableaux are plane partitions in disguise, and we discuss some insights and consequences resulting from this observation. In particular, it turns out that our determinantal formulae for generating functions for alternating tableaux are closely related to (but not equivalent to) the ribbon determinant formulae for Schur functions due to Lascoux and Pragacz [25].

We close our article in Section 12 by a discussion and a presentation of some questions raised by the material presented in this article. In particular, we discuss what happens for *even* upper bounds on the up-down paths, we discuss the possibility of a further extension to Motzkin paths, including a precise conjecture (see Conjecture 56) perhaps hinting at another iceberg, a “coincidental” application of Theorem 4 to the enumeration of parallelogram polyominoes which produces a seemingly new result (see Theorem 58), the link being the heaps of segments that we use in the proof of our enumeration results for bounded alternating sequences in Section 3, and several curious Hankel determinant evaluations involving numbers of bounded up-down paths respectively of bounded alternating sequences (see Theorems 52 and 59 and Corollaries 63 and 64).

As a kind of “afterthought”, we added a “Final Note” at the end of the article pointing the reader to some interesting more recent developments.

2. Enumeration of bounded up-down paths. In this section, we discuss the enumeration of bounded up-down paths. The main result is Theorem 1, in which the generating function for bounded up-down paths with given starting and ending height is computed. Although this is a known result, we present a proof that makes use of Viennot’s [37] theory of heaps of pieces because it has not been recorded anywhere before, and since it constitutes the inspiration for the proof of Theorem 4 in the next section.

To start with, we fix notation. We write $C_n^{(k)}(r \rightarrow s)$ for the *number* of up-down paths from $(0, r)$ to (n, s) that do not pass below the x -axis and do not pass above the horizontal line $y = k$.³ If $r = s = 0$, i.e., if we are talking of Dyck paths, then, instead of $C_n^{(k)}(0 \rightarrow 0)$, we frequently write $C_n^{(k)}$ for short (as we have done in the introduction). There is another special case where we use an abridged notation: we write $D_{2n}^{(k)}$ instead of $C_{2n+k}^{(k)}(0 \rightarrow k)$ for short.

In the results of this section and later sections, the *Chebyshev polynomials of the second kind* are ubiquitous. As usual, we write $U_n(x)$ for the n -th Chebyshev polynomial of the second kind, which is explicitly given by

$$U_n(\cos \theta) = \frac{\sin((n+1)\theta)}{\sin \theta},$$

$$U_n(x) = \sum_{j \geq 0} (-1)^j \binom{n-j}{j} (2x)^{n-2j}. \quad (2.1)$$

It is well-known that these Chebyshev polynomials satisfy the two-term recurrence

$$2xU_n(x) = U_{n+1}(x) + U_{n-1}(x), \quad (2.2)$$

³It should be noted that, due to the geometry of the paths, we need the condition $r + s \equiv n \pmod{2}$ for this number to be non-zero.

with initial conditions $U_0(x) = 1$ and $U_1(x) = 2x$.

With the above notations, we are now ready to state the announced theorem, giving closed form expressions for the generating function for bounded up-down paths with given starting and ending height.

Theorem 1. *For all non-negative integers r, s, k with $0 \leq r, s \leq k$, we have*

$$\sum_{n \geq 0} C_n^{(k)}(r \rightarrow s) x^n = \begin{cases} \frac{U_r(1/2x) U_{k-s}(1/2x)}{x U_{k+1}(1/2x)}, & \text{if } r \leq s, \\ \frac{U_s(1/2x) U_{k-r}(1/2x)}{x U_{k+1}(1/2x)}, & \text{if } r \geq s. \end{cases} \quad (2.3)$$

As already mentioned, this is a known theorem, however not “as known” as it should be. The oldest source that we are aware of is [36, Ch. V, Eq. (27)], where a combinatorial proof, based on the combinatorial theory developed in [36], is sketched. The simplest proof is one that uses the transfer matrix method, see [19, proof of Theorem A2] or [22, proof of Theorem 10.11.1]. (As a matter of fact, these three sources discuss a weighted generalisation for Motzkin paths. See Section 12.(3).) In our opinion, the most illuminating proof is one that is based on Viennot’s theory of heaps of pieces [37], the latter being a geometric realisation of the “*monoïde partiellement commutatif*” of Cartier and Foata [5], now known as the *Cartier–Foata monoid* (see also [20]). This is the proof that we are going to present here since it cannot be found anywhere else in the literature. It is inspired by ideas that one finds in [10, Ch. 4]. Moreover, it prepares for the — slightly more complicated — proof of Theorem 4 on generating functions for alternating sequences.

The heaps that we need here are heaps of dimers that are contained in the interval $[0, k]$. Here, a dimer is a vertical segment connecting the points (a, b) and $(a, b + 1)$, for some positive integer a and non-negative integer b . We write d_b for such a dimer. It is intentional that we ignore the abscissa a in this notation since we allow to move dimers horizontally, thus modifying a . The “rule of the game” is that two dimers d_i and d_j can be (horizontally) moved past one another if and only if they do not block each other “physically”, that is, if and only if either $i > j + 1$ or $j > i + 1$. In our picture, gravity pulls dimers (horizontally) to the left. A *heap of dimers on $[0, k]$* is then what the name suggests: one piles dimers d_i with $0 \leq i < k$ on each other, and gravity pulls them to their left-most possible position according to the “rule of the game”. An example of such a heap on $[0, k]$ is shown in Figure 1.b. We denote the set of all possible dimers on $[0, k]$ by \mathcal{D}_k , that is, $\mathcal{D}_k = \{d_0, d_1, \dots, d_{k-1}\}$. It should be noted that a heap may contain several copies of a dimer d_i . For example, the heap in Figure 1.b contains three copies of the dimer d_1 .

We define a weight function w on dimers by $w(d_i) = x^2$, and, given a heap H , we extend the weight function to H by declaring that $w(H)$ equals the product of the weights of all dimers of H .

A *maximal dimer* of a heap is a dimer that can be moved to the far right without being blocked by any other dimer. Analogously, a *minimal dimer* of a heap is a dimer that can be moved to the far left without being blocked by any other dimer. In our example in Figure 1.b, the maximal dimers of the heap shown there are the right-most dimer d_{r-1} , the right-most dimer d_{r+1} , and the dimer d_s , while the minimal dimers are the dimer d_0 ,

the left-most dimer d_{r+1} , and the dimer d_{s+1} . Finally, a *trivial heap* is one in which all its dimers are maximal.

With these definitions, the main theorem in the theory of heaps [37, Prop. 5.3] (see also [20, Theorem 4.1]) implies that the generating function $\sum_H w(H)$ for all heaps H whose maximal dimers are contained in a given subset \mathcal{M} of \mathcal{D}_k is given by

$$\sum_{\substack{H \text{ heap of dimers on } [0,k] \\ \text{maximal dimers} \subseteq \mathcal{M}}} w(H) = \frac{\sum_{\substack{T \text{ trivial heap} \\ \text{dimers} \subseteq \mathcal{D}_k \setminus \mathcal{M}}} (-1)^{|T|} w(T)}{\sum_{\substack{T \text{ trivial heap} \\ \text{dimers} \subseteq \mathcal{D}_k}} (-1)^{|T|} w(T)}, \quad (2.4)$$

where $|T|$ denotes the number of dimers of T .

The purpose of the next lemma is to transfer the problem of enumeration of bounded up-down paths to a problem of enumeration of heaps of dimers.

Lemma 2. *Let n, k, r, s be non-negative integers with $0 \leq r \leq s \leq k$ and $n \equiv r + s \pmod{2}$. There is a bijection between up-down paths from $(0, r)$ to (n, s) that do not pass below the x -axis and do not pass above the horizontal line $y = k$ and heaps H of $(n - (s - r))/2$ dimers on $[0, k]$ whose maximal dimers are contained in $[r - 1, s + 1]$.*

PROOF. Let P be an up-down path P as in the statement of the lemma. See Figure 1.a for an example. Out of P , we are going to, step-by-step, build a heap H of dimers. In the beginning, H is empty.

We cut P into path portions at the touching points with the horizontal line $y = r$. In the figure, these touching points are marked by circles. Path portions between touching points with $y = r$ are treated differently depending on whether they stay above or below that line. We call the path portions which stay above *positive*, and those which stay below *negative*.

We now scan the path from left to right. While scanning a positive path portion, we ignore up-steps, and for each down-step from height $h + 1$ to h we put a dimer d_h on H , in the order we encounter the down-steps. On the other hand, while scanning a negative path portion, we ignore down-steps, and for each up-step from height h to $h + 1$ we put a dimer d_h on H , in the order we encounter the up-steps. So, for instance, our example path in Figure 1.a starts with a positive portion $UUDD$ (here, U stands for an up-step and D for a down-step). The first down-step in this portion is from height $r + 2$ to $r + 1$, therefore we put the dimer d_{r+1} on the (at this point empty) heap H . The second down-step is from height $r + 1$ to height r , therefore we next put a dimer d_r on H . On the other hand, the second path portion, $DDDUUU$ is negative. We ignore the down-steps, and the up-steps, read from left to right, correspond to the dimers d_0, d_1, d_2 , in this order. They are put on H , in this order.

This process is continued until all steps of P have been taken into account.

It is not difficult to see that a heap obtained in this way has indeed the property that its maximal dimers are contained in $[r - 1, s + 1]$.

inserted in order to connect with (n, s)). See Figure 1.a. We remove d_s from the heap. Now the top-most maximal dimer is d_{k-1} . Hence, we prepend a down-step from height k to height $k - 1$ to the path portion constructed so far. See again Figure 1.a. We remove d_{k-1} from the heap. Now the top-most maximal dimer is d_{r+1} . Consequently, we prepend a down-step from height $r + 2$ to height $r + 1$ followed by five up-steps to the already constructed path portion. After removal of d_{r+1} , the top-most maximal dimer is d_{r+2} . We prepend a down-step from height $r + 3$ to height $r + 2$ to our path portion, and we remove d_{r+2} from the heap. Now the top-most maximal dimer is a dimer d_{r-1} .

We now continue the description of the general case. If, during the process, we encounter a dimer d_{r-1} , then we push this dimer to the left. Thereby, due to the “rule of the game” that dimers cannot be moved past one another if they “physically” touch each other, other dimers may also be moved to the left. We are only interested into those which lie strictly below the horizontal line $y = r$ and do not have another dimer d_{r-1} “in between”. In that way, a subheap is determined. In our example in Figure 1.b, subheaps arising in this way are surrounded by dotted paths. The subheap that we would encounter next is the subheap labelled H_1 .

Such a subheap is now treated in the following way: in the beginning, the top-most maximal dimer is d_{r-1} . We prepend an up-step (!) from height $r - 1$ to height r followed by the appropriate number of up-steps to connect to the previously constructed path portion. Subsequently, we remove d_{r-1} from the subheap. Next we consider the — now — top-most maximal dimer *in the subheap*, d_j say. We prepend an up-step (!) from height j to height $j + 1$ followed by the appropriate number of down-steps (!) to connect to the so far constructed path portion, and we remove d_j from the subheap. We repeat this latter procedure until the subheap is emptied.

This process is iterated, that is, again the maximal dimer is determined and it is treated as above depending on whether it is a dimer d_i with $i \geq r$ or with $i = r - 1$.

It is not too difficult to see that this algorithm is the inverse of the map from up-down paths to heaps that we described in the first part of this proof. \square

REMARK. The obvious extension of the above bijection between up-down paths and heaps of dimers to a bijection between paths with allowed steps being $(1, 1)$, $(1, 0)$, $(1, -1)$ and heaps of dimers *and monomers* also proves the earlier mentioned more general result in [36, Ch. V, Eq. (27)], [19, Theorem A2], and [22, Theorem 10.11.1].

If we combine Lemma 2 with (2.4), then we see that, for the proof of Theorem 1, we need to compute the generating function $\sum_T (-1)^{|T|} w(T)$ for all trivial heaps with dimers in \mathcal{D}_k , that is, all trivial heaps on $[0, k]$, and the analogous generating function for trivial heaps whose dimers are in $[0, r - 1] \cup [s + 1, k]$. The former is accomplished in the lemma below. The computation of the latter is then an easy consequence as, due to the shift-invariance of our weight w , it decomposes into the product of the generating function for trivial heaps on $[0, s - 1]$ and the generating function for trivial heaps on $[0, k - s - 1]$.

Lemma 3. *Let k be a non-negative integer. The generating function $\sum_T (-1)^{|T|} w(T)$, where the sum is over all trivial heaps T of dimers on $[0, k]$, is given by $x^{k+1} U_{k+1}(1/2x)$.*

PROOF. We prove the claim by induction on k . The claim is certainly true for $k = 0$ — in this case there is only the empty heap with weight 1; indeed, $x^1 U_1(1/2x) = 1$ —,

and for $k = 1$ — in this case there exist two heaps: the empty heap with weight 1, and the heap consisting of the dimer d_0 that has weight x^2 ; indeed, $x^2 U_2(1/2x) = 1 - x^2$.

For the induction step, consider trivial heaps of dimers on $[0, k + 1]$. There are two possibilities:

- (a) the heap contains the dimer d_k ;
- (b) the heap has all its dimers in $[0, k]$.

By induction hypothesis, the contribution to the generating function of the heaps in Case (a) is $(-x^2)x^{k-1}U_{k-1}(1/2x)$. Similarly, the contribution of the heaps in Case (b) is $x^k U_k(1/2x)$. Hence, in total we obtain

$$(-x^2)x^{k-1}U_{k-1}(1/2x) + x^k U_k(1/2x) = x^{k+1}U_{k+1}(1/2x), \quad (2.5)$$

the equality following from the two-term recurrence (2.2) for Chebyshev polynomials. \square

We are now ready for the proof of Theorem 1.

PROOF OF THEOREM 1. We treat the case $r \leq s$. The other case follows by a reflection of paths in a vertical line which implies a switch of the roles of r and s .

We use Lemma 2 to see that the up-down paths that we are interested in are in bijection with heaps that are described in the statement of the lemma. Thus, by (2.4) with \mathcal{M} the set of dimers contained in $[r - 1, s + 1]$, we see that

$$\sum_{n \geq 0} C_n^{(k)}(r \rightarrow s) x^n = x^{s-r} \frac{\sum_{\substack{T \text{ trivial heap on } [0, k] \\ \text{dimers} \subseteq [0, r-1] \cup [s+1, k]}} (-1)^{|T|} w(T)}{\sum_{T \text{ trivial heap on } [0, k]} (-1)^{|T|} w(T)}.$$

Here, the factor x^{s-r} must be inserted since an up-down path from height r to height s has $s - r$ more up-steps than down steps. The claimed expression in the first line on the right-hand side of (2.3) now follows from Lemma 3. \square

3. Enumeration of bounded alternating sequences. In this section, we discuss the enumeration of bounded alternating sequences. The main result is Theorem 4, in which we compute the generating function for bounded alternating sequences with given first and last element. Also here, we present a proof that makes use of Viennot's [37] theory of heaps of pieces. Specialisations of Theorem 4 can be used to find the generating functions for the numbers of alternating sequences in which first and last element are not specified. These are recorded here in Corollaries 9–11. In particular, the final result in this section, Corollary 11, sets up the connection to Stanley's observation mentioned in the introduction.

We start again by fixing notation. We let $\mathcal{A}_n^{(k)}(r \rightarrow s)$ denote the *set* of alternating sequences

$$r \leq a_2 \geq a_3 \leq a_4 \geq \cdots \diamond a_{n-1} \square s,$$

where $\diamond = \geq$ and $\square = \leq$ if n is even and $\diamond = \leq$ and $\square = \geq$ if n is odd, in which all a_i 's are integers between 1 and k . If we do not want to specify the first and last element of an alternating sequence then we omit the corresponding indication. More precisely, we write $\mathcal{A}_n^{(k)}$ for the union of the sets $\mathcal{A}_n^{(k)}(r \rightarrow s)$ over all r and s .⁴

The theorem below gives closed form expressions for the generating function for bounded alternating sequences with given first and last element. The reader should note the similarities with the result in Theorem 1. These will be subsequently exploited in Section 4.

Theorem 4. *For all positive integers r, s, k with $1 \leq r, s \leq k$, we have*

$$\sum_{n \geq 0} |\mathcal{A}_{2n+1}^{(k)}(r \rightarrow s)| x^{2n} = \begin{cases} (-1)^{r+s+1} \frac{x U_{2r-2}(x/2) U_{2k+1-2s}(x/2)}{U_{2k}(x/2)}, & \text{if } r < s, \\ 1 - \frac{x U_{2r-2}(x/2) U_{2k+1-2r}(x/2)}{U_{2k}(x/2)}, & \text{if } r = s, \\ (-1)^{r+s+1} \frac{x U_{2s-2}(x/2) U_{2k+1-2r}(x/2)}{U_{2k}(x/2)}, & \text{if } r > s, \end{cases} \quad (3.1)$$

and

$$\sum_{n \geq 0} |\mathcal{A}_{2n+2}^{(k)}(r \rightarrow s)| x^{2n+1} = \begin{cases} (-1)^{r+s+1} \frac{x U_{2r-2}(x/2) U_{2k-2s}(x/2)}{U_{2k}(x/2)}, & \text{if } r \leq s, \\ (-1)^{r+s+1} \frac{x U_{2s-1}(x/2) U_{2k-2r+1}(x/2)}{U_{2k}(x/2)}, & \text{if } r > s. \end{cases} \quad (3.2)$$

As already announced, for the proof of Theorem 4 we use again Viennot's theory of heaps of pieces [37]. The heaps that we need here are heaps of segments that are contained in the interval $[1, k]$. Here, a segment $j-i$, with $1 \leq i \leq j \leq k$, is a vertical segment connecting the points (a, i) and (a, j) , for some positive integer a . The "rule of the game" is that two segments j_1-i_1 and j_2-i_2 can be (horizontally) moved past one another if and only if they do not block each other "physically", that is, if and only if either $i_1 > j_2$ or $i_2 > j_1$. As in Section 2, in our picture, gravity pulls segments (horizontally) to the left. An example of such a *heap of segments on* $[1, k]$ is shown in the bottom of Figure 2. We denote the set of all possible segments in $[1, k]$ by \mathcal{S}_k . Also here it should be noted that a heap can contain several copies of a segment $j-i$. For example, the heap in Figure 2 contains two copies of the segment 3-2. We point out that this kind of heaps of segments (without the upper bound imposed by k) appeared earlier in [4] in the context of enumeration of directed convex polyominoes, see Section 12.(5) for more details on this coincidence, including an implied generating function result for parallelogram polyominoes that seems to be new.

We define a weight function w on the segments by $w(j-i) = x^2$, and, given a heap H , we extend the weight function to H by declaring that $w(H)$ equals the product of the weights of all segments of H .

⁴The reader should be aware that the meaning of the shorthand in the abridged notations $C_n^{(k)}$ from Section 2 and $\mathcal{A}_n^{(k)}$ is *not* the same: while in $C_n^{(k)}$ the omission of " $(r \rightarrow s)$ " means $r = s = 0$, the omission of " $(r \rightarrow s)$ " in $\mathcal{A}_n^{(k)}$ means that we allow *all* possible r and s .

We define *maximal* and *minimal segments* of a heap in the same way as in Section 2. In our example in Figure 2, the maximal segments of the heap shown there are the segments 1–1, 2–2 and 8–6, while the minimal segments are 4–3 and 6–6. Finally, a *trivial heap* is one in which all its segments are maximal.

With these definitions, the main theorem in the theory of heaps [37, Prop. 5.3] (see also [20, Theorem 4.1]) implies that the generating function $\sum_H w(H)$ for all heaps H whose maximal segments are contained in a given subset \mathcal{M} of \mathcal{S}_k is given by

$$\sum_{\substack{H \text{ heap of segments on } [1, k] \\ \text{maximal segments} \subseteq \mathcal{M}}} w(H) = \frac{\sum_{\substack{T \text{ trivial heap} \\ \text{segments} \subseteq \mathcal{S}_k \setminus \mathcal{M}}} (-1)^{|T|} w(T)}{\sum_{\substack{T \text{ trivial heap} \\ \text{segments} \subseteq \mathcal{S}_k}} (-1)^{|T|} w(T)}, \quad (3.3)$$

where, as before, $|T|$ denotes the number of segments of T .

The next lemma says that an alternating sequence can be converted into a heap of segments in a rather straightforward way, and that this conversion is actually a bijection. However, the obtained heaps do not form a set of heaps to which we could apply (3.3). We need to modify this construction. This is what we do in the proof of Lemma 6. The construction in the proof of Lemma 5 will however be a part of it.

Lemma 5. *Let n, k, r, s be non-negative integers with $1 \leq r \leq s \leq k$. There is a bijection between $\mathcal{A}_{2n+1}^{(k)}(r \rightarrow s)$ and heaps H of n segments on $[1, k]$ with the following three properties:*

- (1) H has a maximal segment of the form $j-s$ with $j \geq s$.
- (2) H does not have any maximal segments that are contained in $[s+1, k]$.
- (3) H does not have any minimal segments that are contained in $[1, r-1]$.

PROOF. Given an alternating sequence $r \leq a_2 \geq a_3 \leq a_4 \geq \dots \leq a_{2n} \geq s$, we build a heap by piling the segments $a_2-a_3, a_4-a_5, \dots, a_{2n}-s$ on each other, in this order. See Figure 2 for an example in which $n = 14, k = 8, r = 4$, and $s = 6$. We also mark the point $(0, r)$ and the lower point of the segment $a_{2n}-s$ in order to transfer the information about the first and last entry in the alternating sequence to the heap picture. Thus, in Figure 2 the points $(0, 4)$ and $(8, 6)$ are marked.

It is not difficult to see that a heap obtained in this way satisfies the properties (1)–(3).

In order to see that this is indeed a bijection we describe the inverse mapping. Again, we work from the “back to the front”. Given a heap as described in the statement of the lemma, we look for the top-most maximal segment, say $j-i$. Then $j \geq i$ are the last two entries in the corresponding alternating sequence. Subsequently, we remove this segment from the heap and proceed iteratively to reconstruct the remaining entries of the alternating sequence. \square

As announced earlier, the heaps in the statement of Lemma 5 are not suited for application of (3.3) since Condition (3) above is one on *minimal* segments. In order to achieve our goal — the proof of Theorem 4 — we need to modify the above bijection.

$$4 \leq 4 \geq 3 \leq 3 \geq 1 \leq 1 \geq 1 \leq 3 \geq 2 \leq 6 \geq 6 \leq 8 \geq 4 \leq 7 \geq 4 \leq 4 \geq 2$$

$$\leq 3 \geq 2 \leq 2 \geq 2 \leq 5 \geq 5 \leq 6 \geq 3 \leq 6 \geq 5 \leq 8 \geq 6$$

↕

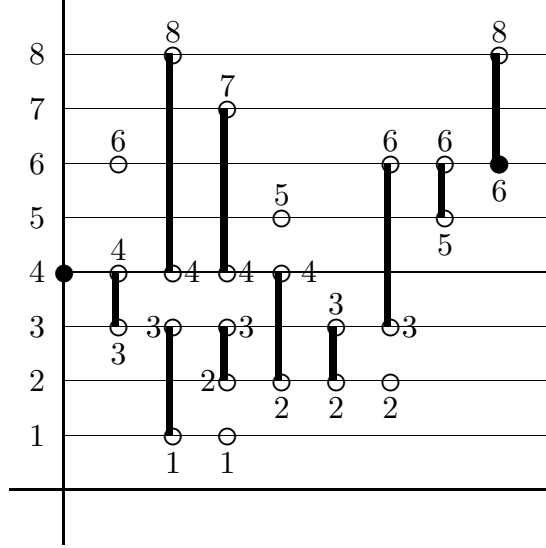

Illustration of the bijection of Lemma 5 for $n = 14$, $k = 8$, $r = 4$, $s = 6$

Figure 2

Lemma 6. *Let n, k, r, s be non-negative integers with $1 \leq r \leq s \leq k$. There is a bijection between $\mathcal{A}_{2n+1}^{(k)}(r \rightarrow s)$ and heaps H' of n segments on $[1, k]$ with the following two properties:*

- (1') H' has a maximal segment of the form $j-s$ with $j \geq s$.
- (2') H' does not have any maximal segments that are contained in $[1, r-1]$ or $[s+1, k]$.

PROOF. Given an alternating sequence $r \leq a_2 \geq a_3 \leq a_4 \geq \dots \leq a_{2n} \geq s$, we again group the entries in pairs: $a_2-a_3, a_4-a_5, \dots, a_{2n}-s$. However, before piling them on each other, we first modify the order of these pairs (which will become segments in the heap picture).

The reordering is accomplished by the following algorithm, in which we construct a sequence, S say, of pairs. Initialise $\ell := 1$ and $S := \emptyset$, the empty sequence.

PROCEDURE. If $\ell = n + 1$ then the algorithm terminates and its output is S .

Otherwise, consider the pair $a_{2\ell}-a_{2\ell+1}$. From the construction, whenever we arrive at this point, we have $a_{2\ell} \geq r$. For $\ell = 1$, this is true since the first element of our alternating sequence is r . If also $a_{2\ell+1} \geq r$, then we let $S := S, a_{2\ell}-a_{2\ell+1}$ and $\ell := \ell + 1$, and we repeat the Procedure.

If, on the other hand, $a_{2\ell+1} < r$, then we continue reading the pairs $a_{2i}-a_{2i+1}$, for $i = \ell + 1, \ell + 2, \dots$, until we meet again a pair $a_{2j}-a_{2j+1}$ in which $a_{2j} \geq r$. In the alternating sequence in Figure 3, we have $a_2-a_3 = 4-3$, $a_4-a_5 = 3-1$,

$$4 \leq 4 \geq 3 \leq 3 \geq 1 \leq 1 \geq 1 \leq 3 \geq 2 \leq 6 \geq 6 \leq 8 \geq 4 \leq 7 \geq 4 \leq 4 \geq 2$$

$$\leq 3 \geq 2 \leq 2 \geq 2 \leq 5 \geq 5 \leq 6 \geq 3 \leq 6 \geq 5 \leq 8 \geq 6$$

↓

$$3-2, 1-1, 3-1, 4-3, \mid 6-6, \mid 8-4, \mid 7-4, \mid$$

$$2-2, 3-2, 4-2, \mid 5-5, \mid 6-3, \mid 6-5, \mid 8-6$$

↓

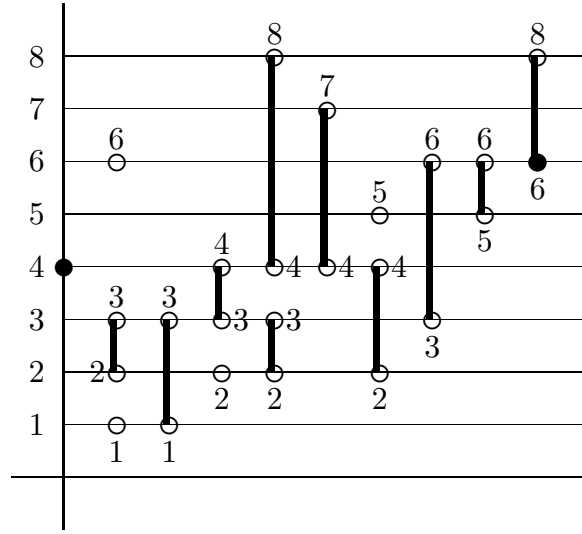

Illustration of the bijection of Lemma 6 for $n = 14$, $k = 8$, $r = 4$, $s = 6$

Figure 3

$a_6 - a_7 = 1 - 1$, $a_8 - a_9 = 3 - 2$, $a_{10} - a_{11} = 6 - 6$, that is, $j = 5$. We reverse the order of the pairs $a_{2\ell} - a_{2\ell+1}, \dots, a_{2j-2} - a_{2j-1}$ and append this reversed sequence to S , that is, we let

$$S := S, a_{2j-2} - a_{2j-1}, \dots, a_{2\ell} - a_{2\ell+1}.$$

Next we let $\ell := j$ and we repeat the Procedure.

In the centre of Figure 3, the sequence of pairs that is produced by the above algorithm when applied to the alternating sequence on the top of Figure 3 is displayed. The bars indicate when a new loop in the Procedure was started.

Finally, these pairs are interpreted as segments as in the proof of Lemma 5, and they are piled on each other as described in that proof. The bottom of Figure 3 shows the resulting heap in our example.

It is clear from the construction that a heap constructed in the above manner will satisfy Conditions (1') and (2'). The question is how one goes back from the heap to the

corresponding alternating sequence. In order to get an idea that this is non-trivial, one should observe that the inverse mapping of the proof of Lemma 5 applied to the heap in Figure 3 *does not* produce the sequence of pairs in the centre of the figure.

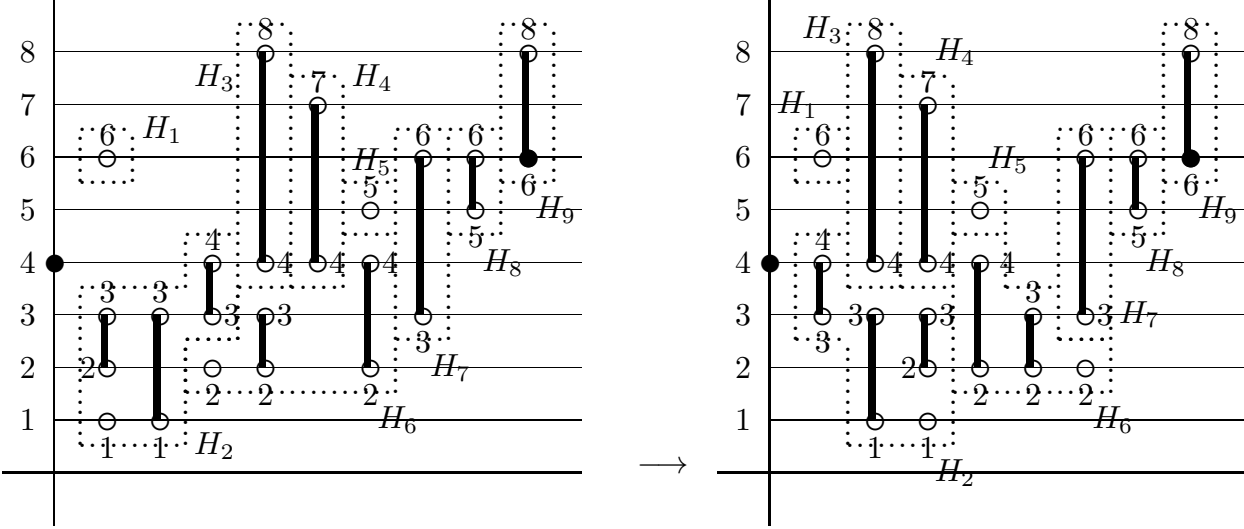

Local modification of the heap

Figure 4

Instead, given a heap H' as described in the statement of the lemma, we consider the top-most *minimal* segment, α say. If it should not be contained in $[1, r - 1]$, then we consider it as a subheap (consisting of a single segment), remove it from H' , and put it on a heap H'' that we are going to build up. On the other hand, if it is contained in $[1, r - 1]$, then we push it to the right. Thereby, due to the “rule of the game” that segments cannot be moved past one another if they “physically” touch each other, other segments may also be moved to the right. We collect all segments that are between α and the left-most moved segment not contained in $[1, r - 1]$, ω say, into a subheap which we denote by G . We illustrate the construction in Figure 4. In the left part of the figure, the heap from Figure 3 is shown. (At this point, dotted paths and labels should be ignored.) The top-most minimal segment is 6–6. It is not contained in $[1, r - 1] = [1, 3]$ and therefore it is considered as a subheap consisting of a single segment, indicated by dotted paths that surround it, and labelled by H_1 in the left part of Figure 4. As a subheap, it is subsequently removed, and it is put on a new heap H'' , which we show in the right part of Figure 4. (At this point, the reader should ignore the subheaps H_2, \dots, H_9 ; by now, H'' just consists of H_1 .) After removal of 6–6, the top-most minimal segment of H' is 3–2. This is contained in $[1, r - 1] = [1, 3]$. If we push it to the right then also the segments 3–1 and 4–3 are moved to the right, where 4–3 is the left-most moved segment that is not contained in $[1, r - 1] = [1, 3]$, that is, $\omega = 4-3$ in the example. Thus, the subheap G consists of the segments 3–2, 3–1, and 4–3 at this point. (It is true that also the segment 2–2 is moved to the right when 3–2 is pushed to the right. However, 2–2 is not *between*

$\alpha = 3-2$ and $\omega = 4-3$ since $4-3$ stays put when $2-2$ is pushed to the right.) For the moment, we leave G at its place.

We now consider the next-to-the-top-most minimal element, β say, and push it to the right. If the left-most moved segment not contained in $[1, r-1]$ is again ω , then we put all moved elements between β and ω also into the subheap G . In our running example, the next-to-the-top-most minimal segment is $1-1$, that is, we have $\beta = 1-1$. If we move it to the right, then also $1-1$, $3-1$, $4-3$ are moved to the right. Since $\omega = 4-3$ is among these elements, we augment our subheap G to $3-2$, $1-1$, $3-1$, $4-3$. See the left part of Figure 4, where the subheap G that we found so far is the subheap labelled by H_2 on the left of Figure 4. We continue in this manner until there are no minimal segments left, or until a minimal segment is found that does not move ω . We then remove the subheap G that we built up to this point from H' , reflect it into a vertical line, and put it in this reflected order on H'' . In our example, there are no more minimal segments to be considered, therefore $G = H_2$ is removed from the heap H' on the left of Figure 4, it is reflected, and then put in this reflected order on the heap H'' (at this point just consisting of the segment $6-6$), see the right part of Figure 4.

This process is repeated until H' is emptied and a modified heap H'' has been built up. In Figure 4, the subheaps that were found during the construction and moved from H' (on the left) to H'' (on the right) are surrounded by closed dotted paths and labelled H_1, H_2, \dots, H_9 .

The final step then consists in applying the inverse mapping from the proof of Lemma 5 to H'' in order to obtain an alternating sequence with $2n + 1$ elements, all of which between 1 and k , and which starts with r and ends with s . It can be seen that this yields the inverse mapping of the map from alternating sequences to heaps that was described at the beginning of this proof and illustrated in Figure 3. \square

If we combine Lemma 6 with (3.3), then we see that, for the proof of Theorem 4, we need to compute the generating function $\sum_T (-1)^{|T|} w(T)$ for all trivial heaps with segments in \mathcal{S}_k , that is, all trivial heaps on $[1, k]$, and the analogous generating function for trivial heaps whose segments are in $[1, r-1] \cup [s+1, k]$ and with a maximal segment of the form $j-s$ for some $j \geq s$. The former is accomplished in the lemma below, while the latter is done in Lemma 8.

Lemma 7. *Let k be a non-negative integer. The generating function $\sum_T (-1)^{|T|} w(T)$, where the sum is over all trivial heaps T of segments on $[1, k]$, is given by $(-1)^k U_{2k}(x/2)$.*

PROOF. We prove the claim by induction on k . The claim is certainly true for $k = 0$ — in this case there is only the empty heap — and for $k = 1$ — in this case there exist two heaps: the empty heap with weight 1, and the heap consisting of the segment $1-1$ contributing $-x^2$ to the signed sum of weights; indeed, $(-1)^1 U_2(x/2) = 1 - x^2$.

For the induction step, consider trivial heaps on $[1, k+1]$. There are three possibilities:

- (a) the heap contains the segment $(k+1)-(k+1)$;
- (b) the heap contains a segment $(k+1)-j$ with $j < k+1$;
- (c) the heap does not contain a segment $(k+1)-j$ for any j .

By induction hypothesis, the contribution to the generating function of the heaps in Case (a) is $(-x^2)(-1)^k U_{2k}(x/2)$. Similarly, the contribution of the heaps in Case (c)

is $(-1)^k U_{2k}(x/2)$. Finally, if we have a heap in Case (b), then we may replace the segment $(k+1)-j$ by the segment $k-j$. Thus, we obtain a heap on $[1, k]$, and the correspondence is a bijection between heaps in Case (b) and heaps on $[1, k]$ with one segment of the form $k-j$. Again by induction, the contribution of these heaps to the generating function is $(-1)^k U_{2k}(x/2) - (-1)^{k-1} U_{2k-2}(x/2)$. Hence, in total we obtain

$$\begin{aligned} & (-x^2)(-1)^k U_{2k}(x/2) + 2(-1)^k U_{2k}(x/2) + (-1)^k U_{2k-2}(x/2) \\ &= (-1)^{k+1} (x^2 U_{2k}(x/2) - 2U_{2k}(x/2) - U_{2k-2}(x/2)) \\ &= (-1)^{k+1} U_{2k+2}(x/2), \end{aligned}$$

where in the last line we used the recurrence formula (2.2) for Chebyshev polynomials iteratively. \square

As we said above Lemma 7, we must also compute the generating function for trivial heaps whose segments are in $[1, r-1] \cup [s+1, k]$ and with a maximal segment of the form $j-s$ for some $j \geq s$. In such heaps, there is in particular no maximal segment in $[1, r-1] \cup [j+1, k]$. Obviously, the same applies when we remove the segment $j-s$, which has weight x^2 , from the top of this heap. The corresponding generating function is given in the lemma below.

Lemma 8. *Let r, s, k be positive integers with $1 \leq r \leq s \leq k$. The sum of generating functions*

$$\sum_{j=s}^k x^2 \sum_{\substack{T \text{ trivial heap} \\ T \subseteq [1, r-1] \cup [j+1, k]}} (-1)^{|T|} w(T) \quad (3.4)$$

is given by

$$(-1)^{k+r+s+1} x U_{2r-2}(x/2) U_{2k+1-2s}(x/2).$$

PROOF. We may rewrite the sum in (3.4) as

$$- \sum_{\substack{T \text{ trivial heap} \\ T \subseteq [1, r-1] \cup [s, k] \\ T \not\subseteq [1, r-1] \cup [s+1, k]}} (-1)^{|T|} w(T), \quad (3.5)$$

that is, we sum over all trivial heaps on $[1, r-1] \cup [s, k]$ that contain a segment $j-s$ for some j with $j \geq s$.

The parts of the trivial heap T on $[1, r-1]$ and on $[s, k]$ are independent. Therefore the generating function is the product of the corresponding generating functions. Thus, by Lemma 7, we obtain

$$\begin{aligned} & - (-1)^{r-1} U_{2r-2}(x/2) ((-1)^{k-s+1} U_{2k-2s+2}(x/2) - (-1)^{k-s} U_{2k-2s}(x/2)) \\ &= - (-1)^{r-1} U_{2r-2}(x/2) (-1)^{k-s+1} x U_{2k-2s+1}(x/2), \quad (3.6) \end{aligned}$$

which implies the claimed expression. \square

We have now collected all ingredients in order to establish Theorem 4.

PROOF OF THEOREM 4. We start with the proof of (3.1) in the case where $r \leq s$.

As we already announced before Lemma 7, we use Lemma 6 to see that the alternating sequences that we are interested in are in bijection with the heaps that are described in the statement of Lemma 6. If we give an alternating sequence with $2n + 1$ elements the weight x^{2n} , then this bijection is weight-preserving.

Let us now consider heaps as described in Lemma 6 with a maximal segment $j-s$. By Condition (2') in Lemma 6, there is no maximal segment in $[1, r-1] \cup [j+1, k]$. Obviously, the same applies when we remove the segment $j-s$, which has weight x^2 , from the top of this heap. Consequently, by (3.3), the generating function for these heaps is equal to

$$x^2 \times \frac{\sum_{\substack{T \text{ trivial heap} \\ \text{segments} \subseteq [1, r-1] \cup [j+1, k]}} (-1)^{|T|} w(T)}{\sum_{T \text{ trivial heap on } [1, k]} (-1)^{|T|} w(T)}.$$

In the end, we have to sum these expressions over $j = s, s+1, \dots, k$. Lemma 7 provides a closed form expression for the denominator in the above fraction, while in Lemma 8 the sum of the numerators is computed. This yields the first expression on the right-hand side of (3.1). In the case where $r = s$ one needs to add 1, the weight of the empty heap. Symmetry in r and s then also proves the third expression on the right-hand side of (3.1).

The proof of (3.2) amounts to an exercise in summing Chebyshev polynomials. We start with the case where $r > s$. By straightforward reasoning, we have

$$|\mathcal{A}_{2n+2}^{(k)}(r \rightarrow s)| = \sum_{j=1}^s |\mathcal{A}_{2n+1}^{(k)}(r \rightarrow j)|, \quad (3.7)$$

and therefore

$$\sum_{n \geq 0} |\mathcal{A}_{2n+2}^{(k)}(r \rightarrow s)| x^{2n+1} = \sum_{j=1}^s \sum_{n \geq 0} |\mathcal{A}_{2n+1}^{(k)}(r \rightarrow j)| x^{2n+1}.$$

By the third case of (3.1), we obtain

$$\begin{aligned} \sum_{n \geq 0} |\mathcal{A}_{2n+2}^{(k)}(r \rightarrow s)| x^{2n+1} &= \sum_{j=1}^s x(-1)^{r+j+1} \frac{xU_{2j-2}(x/2)U_{2k+1-2r}(x/2)}{U_{2k}(x/2)} \\ &= (-1)^r \frac{xU_{2k+1-2r}(x/2)}{U_{2k}(x/2)} \sum_{j=1}^s (-1)^{j-1} xU_{2j-2}(x/2) \\ &= (-1)^r \frac{xU_{2k+1-2r}(x/2)}{U_{2k}(x/2)} \sum_{j=1}^s (-1)^{j-1} (U_{2j-1}(x/2) + U_{2j-3}(x/2)) \\ &= (-1)^r \frac{xU_{2k+1-2r}(x/2)}{U_{2k}(x/2)} (-1)^{s-1} U_{2s-1}(x/2). \end{aligned}$$

Here we used the recurrence (2.2) to obtain the next-to-last line, and a telescoping argument to arrive at the last line. Thus, we obtain exactly the second expression on the right-hand side of (3.2).

In the case where $r \leq s$, we could do an analogous (but more complicated) computation. However, there is a simpler argument, using again heaps of segments. Namely, given a sequence $r \leq a_2 \geq a_3 \leq a_4 \geq \cdots \geq a_{2n+1} \leq s$, we apply the bijections from the proofs of Lemmas 5 and 6 to map the sequence to a heap of n segments (ignoring the last element s of the sequence). As is easy to see, this sets up a bijection between $\mathcal{A}_{2n+2}^{(k)}(r \rightarrow s)$ and heaps of n segments on $[1, k]$ whose maximal segments are not contained in $[1, r-1] \cup [s+1, k]$. Hence, according to (3.3), the generating function on the left-hand side of (3.2) equals

$$\frac{\sum_{\substack{T \text{ trivial heap on } [1, k] \\ \text{segments} \subseteq [1, r-1] \cup [s+1, k]}} (-1)^{|T|} w(T)}{\sum_{T \text{ trivial heap on } [1, k]} (-1)^{|T|} w(T)}. \quad (3.8)$$

Now application of Lemma 7 immediately yields the first expression on the right-hand side of (3.2).

This completes the proof of the theorem. \square

Next we show that specialisations of Theorem 4 may be used to find the generating functions for the numbers of alternating sequences in which first and last element are not specified.

Corollary 9. *For all positive integers k , we have*

$$\sum_{n \geq 1} |\mathcal{A}_{2n-1}^{(k)}| x^{2n} = -\frac{x U_{2k-1}(x/2)}{U_{2k}(x/2)}. \quad (3.9)$$

PROOF. The special case $r = s = 1$ of (3.1) is equivalent with (3.9). Indeed, in any sequence

$$1 \leq a_2 \geq a_3 \leq a_4 \geq \cdots \leq a_{2n} \geq 1$$

with entries between 1 and k , we may skip the 1's at the beginning and at the end, and then replace every a_i by $k+1-a_i$ in order to obtain

$$k+1-a_2 \leq k+1-a_3 \geq k+1-a_4 \leq \cdots \geq k+1-a_{2n},$$

which is an element of $\mathcal{A}_{2n-1}^{(k)}$.

Alternatively, by using that $U_{2k-2}(x/2) = xU_{2k-1}(x/2) - U_{2k}(x/2)$ (cf. (2.2)), it can also be seen that the special case $r = s = k$ of (3.2) is also equivalent with (3.9). \square

Corollary 10. For all positive integers k , we have

$$\sum_{n \geq 0} |\mathcal{A}_{2n}^{(k)}| x^{2n+1} = (-1)^k \frac{x}{U_{2k}(x/2)}. \quad (3.10)$$

PROOF. The special case $r = 1$ and $s = k$ of (3.2) is equivalent with (3.10). Indeed, similarly to the first proof of Corollary 9, this is seen by skipping the 1 at the beginning and the k at the end of a sequence in $\mathcal{A}_{2n+2}^{(k)}(1 \rightarrow k)$ and then replacing each element a_i in the sequence by $k + 1 - a_i$.

Alternatively, with some additional work one can see that the special case $r = k$ and $s = 1$ of (3.1) is also equivalent with (3.10). \square

In Exercise 3.66 of [35], Stanley considers the cumulative generating function

$$G_k(x) = 1 + \sum_{n \geq 0} |\mathcal{A}_n^{(k)}| x^{n+1}$$

for *all* bounded alternating sequences, regardless whether they have odd or even length. In the solution section in [35], it is shown how to derive a recursion formula for $G_k(x)$. Furthermore, it is pointed out that [32, Ex. 3.2] gives an explicit formula for $G_k(x)$. This formula is not very illuminating. Only specialists may notice that, in the background, there lurk Chebyshev polynomials of the second kind, which the corollary below reveals. Our proof is independent of the above mentioned results as it is based on our findings in Corollaries 9 and 10.

Corollary 11. For $k \geq 1$, we have

$$G_k(x) = -\frac{U_{k-2}(x/2) + (-1)^k U_{k-3}(x/2)}{U_k(x/2) + (-1)^k U_{k-1}(x/2)}. \quad (3.11)$$

PROOF. According to Corollaries 9 and 10, we have

$$G_k(x) = 1 + (-1)^k \frac{x}{U_{2k}(x/2)} - \frac{x U_{2k-1}(x/2)}{U_{2k}(x/2)}. \quad (3.12)$$

Let first k be even. We remember that, according to the definition (2.1) of Chebyshev polynomials of the second kind, we have

$$U_n(X) = \frac{z^{n+1} - z^{-n-1}}{z - z^{-1}},$$

where $z = e^{it}$ and $X = \cos t = \frac{1}{2}(z + z^{-1})$. We substitute these alternative expressions in z in the right-hand side of (3.12) and simplify (using a computer). The result is

$$G_k(x) = -\frac{z^{2k} - z^3}{z(z^{2k+1} - 1)}.$$

If one does the same substitutions on the right-hand side of (3.11) (with k even), then one obtains the same result.

The case of odd k can be treated similarly. \square

4. Numbers of bounded up-down paths “with negative length” and bounded alternating sequences. The strong similarity between the expressions in Theorems 1 and 4 has interesting consequences, which we reveal in this section. It leads to first reciprocity relations of the kind that numbers of certain bounded up-down paths “of negative length” give numbers of certain bounded alternating sequences; see Corollaries 12–14.

The reader should recall that, given a rational power series

$$f(x) = \frac{p(x)}{q(x)} = \sum_{n \geq 0} f_n x^n, \quad (4.1)$$

where the degree in x of $p(x)$ is less than the degree of $q(x)$, we have (cf. [35, Prop. 4.2.3])

$$\sum_{n \geq 1} f_{-n} x^n = -f(1/x), \quad (4.2)$$

where the f_{-n} ’s are defined by “running” the linear recurrence for the sequence $(f_n)_{n \geq 0}$ that results from (4.1) “backwards”.

Corollary 12. *Let n, k, r, s be positive integers with $1 \leq r, s \leq k$. The number $(-1)^{r+s} C_{-2n}^{(2k-1)}(2r-2 \rightarrow 2s-2)$ equals the number of sequences $r \leq a_2 \geq a_3 \leq a_4 \geq \dots \leq a_{2n} \geq s$, in which all a_i ’s are integers between 1 and k . Furthermore, the number $(-1)^{r+s} C_{-2n+1}^{(2k-1)}(2r-2 \rightarrow 2s-1)$ equals the number of sequences $r \leq a_2 \geq a_3 \leq a_4 \geq \dots \geq a_{2n-1} \leq s$, in which all a_i ’s are integers between 1 and k .*

PROOF. By (2.3) and (4.2), we have

$$\sum_{n \geq 1} C_{-2n}^{(2k-1)}(2r-2 \rightarrow 2s-2) x^{2n} = \begin{cases} -\frac{x U_{2r-2}(x/2) U_{2k+1-2s}(x/2)}{U_{2k}(x/2)}, & \text{if } r \leq s, \\ -\frac{x U_{2s-2}(x/2) U_{2k+1-2r}(x/2)}{U_{2k}(x/2)}, & \text{if } r \geq s. \end{cases}$$

Comparison with Theorem 4 completes the proof of the first claim.

The second claim is established completely analogously, here using (3.2) instead of (3.1). \square

By comparison with appropriate special cases of Theorem 1, we obtain more “reciprocity relations”.

Corollary 13. *For positive integers n and k , the number $C_{-2n}^{(2k-1)}$ equals the number of sequences $a_1 \leq a_2 \geq a_3 \leq a_4 \geq \dots \geq a_{2n-1}$ of positive integers with $a_i \leq k$ for all i .*

PROOF. This follows from applying (4.2) to Theorem 1 with $r = s = 0$ and k replaced by $2k - 1$, and comparing the result with Corollary 9. \square

For the statement of the next reciprocity relation, let us recall from the beginning of Section 2 that we write $D_{2n}^{(k)}$ instead of $C_{2n+k}^{(k)}(0 \rightarrow k)$ for short.

Corollary 14. For integers n and k with $n \geq 0$ and $k \geq 1$, the number $(-1)^{k+1} D_{-2n-2k}^{(2k-1)}$ equals the number of sequences $a_1 \leq a_2 \geq a_3 \leq a_4 \geq \cdots \leq a_{2n}$ of positive integers with $a_i \leq k$ for all i .

PROOF. By Theorem 1 with k replaced by $2k - 1$, $r = 0$, and $s = 2k - 1$, we have

$$\sum_{n \geq 0} D_{2n}^{(2k-1)} x^{2n+2k-1} = \sum_{n \geq 0} C_n^{(2k-1)}(0 \rightarrow 2k-1) x^n = \frac{1}{x U_{2k}(1/2x)},$$

or, equivalently,

$$\sum_{n \geq 0} D_{2n}^{(2k-1)} x^{2n} = \frac{1}{x^{2k} U_{2k}(1/2x)}.$$

We now apply (4.2) to get

$$\sum_{n \geq 1} D_{-2n}^{(2k-1)} x^{2n} = -\frac{x^{2k}}{U_{2k}(x/2)}.$$

Comparison with Corollary 10 completes the proof. \square

5. A first reciprocity theorem. The main result in this section is a reciprocity law for Hankel determinants of numbers of bounded Dyck paths, see Theorem 15. As we show in Proposition 16 and Theorem 17, in combinatorial terms this reciprocity sets up a correspondence between families of non-intersecting bounded Dyck paths and alternating tableaux (see Section 11 for their formal definition) of trapezoidal shape.

Theorem 15. For all non-negative integers n, k, m , we have

$$\det \left(C_{2n+2i+2j+4m-2}^{(2k+2m-1)} \right)_{0 \leq i, j \leq k-1} = \det \left(C_{-2n-2i-2j}^{(2k+2m-1)} \right)_{0 \leq i, j \leq m-1}. \quad (5.1)$$

REMARK. Equation (1.1) is the special case $m = 1$ of this theorem.

Our strategy to prove Theorem 15 is as follows. By the Lindström–Gessel–Viennot theorem [26, Lemma 1] (see also [12, 13]), the determinant on the left-hand side of (5.1) equals the number of families $(P_0, P_1, \dots, P_{k-1})$ of non-intersecting Dyck paths of height at most $2k + 2m - 1$, where P_i runs from $(-2i, 0)$ to $(2n + 4m + 2i - 2, 0)$, $i = 0, 1, \dots, k - 1$. An example of such a family of non-intersecting Dyck paths for $k = 4$, $m = 3$, and $n = 3$ is shown in Figure 5. (At this point, circled points and attached labels, as well as dotted lines should be ignored.)

In Proposition 16 below, we shall show that there is a bijection between these families of non-intersecting Dyck paths and certain trapezoidal arrays of alternating sequences. Subsequently, in Theorem 17, it is shown that the number of these trapezoidal arrays is given by the determinant on the right-hand side of (5.1). Hence, the combination of the above observation with Proposition 16 and Theorem 17 will establish Theorem 15.

PROOF. It should be noted that, by Corollary 13, the determinant in (5.8) can be alternatively written as

$$\det \left(|\mathcal{A}_{2n+2i+2j-1}^{(k+m)}| \right)_{0 \leq i, j \leq m-1}. \quad (5.9)$$

To be in line with $C_0^{(2k+2m-1)} = 1$, we have to *define* that $\mathcal{A}_{-1}^{(k+m)}$ consists of just one element, namely the empty sequence.

We shall interpret the determinant in (5.9) in terms of non-intersecting lattice paths. The underlying directed graph for these paths is the graph \mathcal{G}_{k+m} , which by definition is the graph with vertices being the integer lattice points (x, y) , where $x \geq 0$ and $1 \leq y \leq k+m$, and with directed edges in the set

$$\begin{aligned} & \{(2i, j+1) \rightarrow (2i, j) : i \geq 0 \text{ and } 1 \leq j \leq k+m-1\} \\ & \cup \{(2i+1, j) \rightarrow (2i+1, j+1) : i \geq 0 \text{ and } 1 \leq j \leq k+m-1\} \\ & \cup \{(i, j) \rightarrow (i+1, j) : i \geq 0 \text{ and } 1 \leq j \leq k+m\}. \end{aligned}$$

See Figure 6 for a portion of the directed graph \mathcal{G}_{k+m} for $k=4$ and $m=3$.

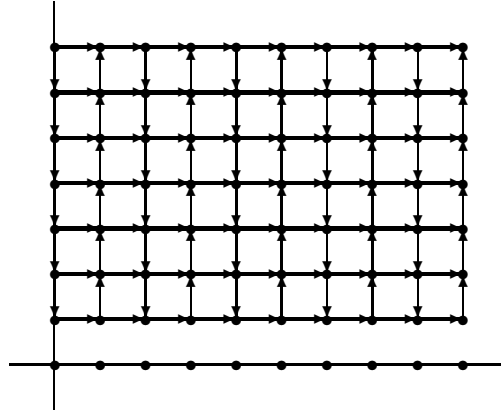

The directed graph \mathcal{G}_7

Figure 6

Now let first $n \geq 1$. We claim that the determinant in (5.9) equals the number of families $(P_0, P_1, \dots, P_{m-1})$ of non-intersecting lattice paths in the directed graph \mathcal{G}_{k+m} , where P_i runs from $(2m-2i-2, k+m)$ to $(2n+2m+2i-3, k+m)$. Figure 7 shows an example of such a path family for $k=4$, $m=3$, and $n=3$. (The numbers should be ignored at this point.)

By the Lindström–Gessel–Viennot theorem [26, Lemma 1], to verify the claim it suffices to show that the number of paths from $(2x, k+m)$ to $(2x+2s-1, k+m)$ in the graph \mathcal{G}_{k+m} is equal to $|\mathcal{A}_{2s-1}|$, the number of alternating sequences of integers $a_1 \leq a_2 \geq a_3 \leq \dots \geq a_{2s-1}$ with $1 \leq a_i \leq k+m$ for all i . This is indeed easy to see if one labels each horizontal step from $(i, j) \rightarrow (i+1, j)$ by j , for all i and j . See Figure 7 for these labels. If one then reads labels along a path from left to right, then one reads an alternating sequence, and this correspondence sets up a bijection between paths from

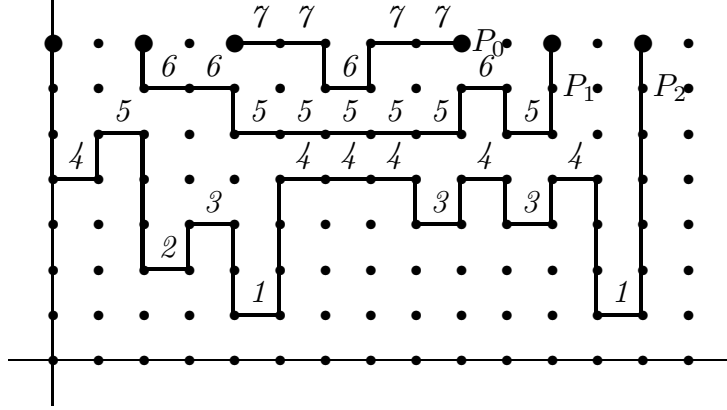

A family of non-intersecting paths in the directed graph \mathcal{G}_7

Figure 7

$(2x, k+m)$ to $(2x+2s-1, k+m)$ in the graph \mathcal{G}_{k+m} and alternating sequences in $\mathcal{A}_{2s-1}^{(k+m)}$. For example, the path P_2 in Figure 7 corresponds to the alternating sequence $4 \leq 5 \geq 2 \leq 3 \geq 1 \leq 4 \geq 4 \leq 4 \geq 3 \leq 4 \geq 3 \leq 4 \geq 1$.

In view of the above considerations, the proof would be complete if there is a bijection between families $(P_0, P_1, \dots, P_{m-1})$ of non-intersecting lattice paths in \mathcal{G}_{k+m} , where P_i runs from $(2m-2i-2, k+m)$ to $(2m+2i-3, k+m)$, and arrays of integers as described in Proposition 16. This bijection is easily set up: the i -th row in an array of the form (5.2) is translated into a path P_{i-1} in \mathcal{G}_{k+m} , $i = 1, 2, \dots, m$; more precisely, for $i = 1, 2, \dots, m$, the entry $a_{i,j}$ (if it exists) is translated into the horizontal step $(j-1, a_{i,j}) \rightarrow (j, a_{i,j})$, for all $j \geq 1$, and these horizontal steps are then connected by vertical up- and down-steps to form a path in \mathcal{G}_{k+m} . This correspondence is illustrated in Figure 7, which shows in fact the family of non-intersecting paths corresponding to the array in (5.7).

Finally we address the special case where $n = 0$. In that case, when we attempt to carry through the same programme, we face the problem that there is no family $(P_0, P_1, \dots, P_{m-1})$ of non-intersecting lattice paths in \mathcal{G}_{k+m} , where P_i runs from $(2m-2i-2, k+m)$ to $(2m+2i-3, k+m)$, because P_0 would have to run from $(2m-2, k+m)$ to $(2m-3, k+m)$. We remedy the situation by extending \mathcal{G}_{k+m} by the additional “artificial” (backwards) edge $(2m-2, k+m) \rightarrow (2m-3, k+m)$. It is not difficult to see that, with this modified graph, the earlier arguments now also apply to this case.

This completes the proof of the theorem. \square

6. A second reciprocity theorem. In this section, the main result is a reciprocity law for Toeplitz determinants of numbers of bounded up-down paths connecting the x -axis with the upper boundary, see Theorem 18. As we show in Proposition 19 and Theorem 20, in combinatorial terms this reciprocity sets up a correspondence between families of non-intersecting bounded up-down paths connecting the x -axis with the upper boundary and alternating tableaux (see Section 11 for their formal definition) of rhomboidal shape.

Theorem 18. For all non-negative integers n and positive integers k, m , we have

$$\det \left(D_{2n+2j-2i}^{(2k+2m-1)} \right)_{0 \leq i, j \leq k-1} = (-1)^{km} \det \left(D_{-2n-2j+2i-2k-2m}^{(2k+2m-1)} \right)_{0 \leq i, j \leq m-1}. \quad (6.1)$$

For the proof of the theorem, we proceed in a similar manner as for the proof of Theorem 15. Namely, by the Lindström–Gessel–Viennot theorem [26, Lemma 1], the determinant on the left-hand side of (6.1) equals the number of families $(P_0, P_1, \dots, P_{k-1})$ of non-intersecting up-down paths of height at most $2k + 2m - 1$ that do not pass below the x -axis, where P_i runs from $(2i, 0)$ to $(2n + 2m + 2k + 2i - 1, 2k + 2m - 1)$, $i = 0, 1, \dots, k - 1$. An example of such a family of non-intersecting up-down paths for $k = 4$, $m = 3$, and $n = 5$ is shown in Figure 8. (At this point, circled points and attached labels, as well as dotted lines should be ignored.)

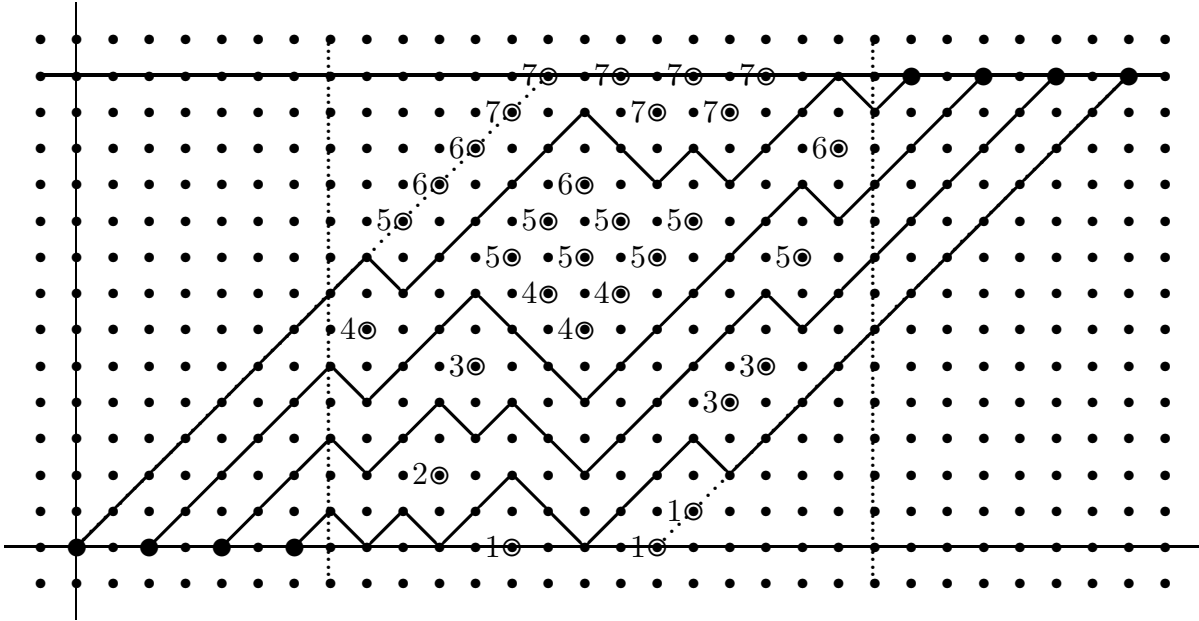

A family of non-intersecting up-down paths starting at the x -axis and ending at the upper bound

Figure 8

In Proposition 19 below, we shall show that there is a bijection between these families of non-intersecting up-down paths and certain rhomboidal arrays of alternating sequences. Then, in Theorem 20, it is shown that the number of these rhomboidal arrays is given by the determinant on the right-hand side of (6.1). Hence, the combination of the above observation with Proposition 19 and Theorem 20 will establish Theorem 18.

Proposition 19. Let n be a non-negative integer and k, m be positive integers. There is a bijection between families $(P_0, P_1, \dots, P_{k-1})$ of non-intersecting up-down paths of height at most $2k + 2m - 1$ that do not pass below the x -axis, where P_i runs from $(2i, 0)$ to $(2n + 2m + 2k + 2i - 1, 2k + 2m - 1)$, $i = 0, 1, \dots, k - 1$, and rhomboidal arrays of integers

of the form

$$\begin{array}{cccccccccccc}
 & & & & & a_{1,2m-1} & \dots & & & a_{1,2m+2n-4} & a_{1,2m+2n-3} & a_{1,2m+2n-2} \\
 & & & & & a_{2,2m-3} & a_{2,2m-2} & a_{2,2m-1} & \dots & a_{2,2m+2n-6} & a_{2,2m+2n-5} & a_{2,2m+2n-4} \\
 & & & a_{3,2m-5} & a_{3,2m-4} & a_{3,2m-3} & \dots & & & a_{3,2m+2n-6} & & \\
 & \ddots & & & & & & & & & & \ddots \\
 a_{m,1} & a_{m,2} & a_{m,3} & \dots & & & & & & & & a_{m,2n}
 \end{array} \tag{6.2}$$

in which each row is alternating, that is,

$$a_{i,2m-2i+1} \leq a_{i,2m-2i+2} \geq a_{i,2m-2i+3} \leq a_{i,2m-2i+4} \geq \dots \leq a_{i,2n+2m-2i} \tag{6.3}$$

for all i , and in which we have

$$1 \leq a_{i,j} \leq k + m \tag{6.4}$$

and

$$a_{i+1,2j} < a_{i,2j+1} > a_{i+1,2j+2} \tag{6.5}$$

for all i and j . In the case where $n = 0$, the array in (6.2) as to be interpreted as the empty array.

PROOF. The reader should consult Figure 8 while reading the following explanations. As mentioned earlier, the figure shows an example of a family of non-intersecting up-down paths as described in the statement of the proposition for $k = 4$, $m = 3$, and $n = 5$.

Since the paths are non-intersecting, the path P_i has to start with $2k - 2i - 1$ up-steps, and it has to end with $2i + 1$ up-steps, for $i = 0, 1, \dots, k - 1$. In other words, everything is uniquely determined left of the abscissa $x = 2k - 1$ and right of the abscissa $x = 2n + 2m + 2k - 2$. (These abscissa are marked by dotted vertical lines in the figure.) Only “in between” there is (some) “freedom”.

Now, for all i and j , we mark all lattice points $(2i - 1, 2j - 1)$ and all lattice points $(2i, 2j)$ in the region

$$\{(x, y) : 0 \leq y \leq 2k + 2m - 1, 2k \leq x \leq 2n + 2m + 2k - 3, y \leq x \leq y + 2n + 2k - 2\}$$

that are not occupied by any of the paths. (This region is the rhomboidal region bounded below by the x -axis, bounded above by the horizontal line $y = 2k + 2m - 1$, bounded on the left by the abscissa $x = 2k$ and the diagonal line starting in the left-most starting point of the paths, and bounded on the right by the abscissa $x = 2n + 2m + 2k - 3$ and the diagonal line ending in the right-most end point of the paths.) In the figure, these lattice points are marked by circles.

As before, each marked point X acquires a label, given by 1 plus the number of paths and marked points that are below X and have the same abscissa as X . Again, equivalently, the label of a marked point $X = (x, y)$ equals $\lceil (y + 1)/2 \rceil$. The figure shows the labels of these marked points.

Finally, for $i = 2k, 2k + 1, \dots, 2n + 2m + 2k - 3$, we read the labels of the marked points with abscissa i and put them into a column, and then we concatenate the columns into an

array of rhomboidal shape as in (6.2). In this way, for the example in Figure 8, we obtain the array

$$\begin{array}{cccccccccccc}
 & & & & 7 & 7 & 6 & 7 & 7 & 7 & 7 & 5 & 6 \\
 & & & & 6 & 6 & 5 & 5 & 5 & 5 & 5 & 3 & 3 \\
 4 & 5 & 2 & 3 & 1 & 4 & 4 & 4 & 1 & 1 & & &
 \end{array} \tag{6.6}$$

It is not difficult to see that (in general) the obtained array satisfies the constraints in (6.3)–(6.5).

Conversely, given an array of the form (6.2) which satisfies (6.3)–(6.5), if one reverses the previously described construction then one sees that this array determines a unique family of non-intersecting up-down paths as described in the statement of the proposition. \square

Theorem 20. *Let n be a non-negative integer and k, m be positive integers. The number of rhomboidal arrays of integers of the form (6.2) that satisfy (6.3)–(6.5) is equal to*

$$\begin{aligned}
 (-1)^{km} \det \left(D_{-2n-2i+2j-2k-2m}^{(2k+2m-1)} \right)_{0 \leq i, j \leq m-1} \\
 = (-1)^{km + \binom{m}{2}} \det \left(D_{-2n-2j-2i-2k-2}^{(2k+2m-1)} \right)_{0 \leq i, j \leq m-1} \\
 = (-1)^{km} \det \left(D_{-2n-2j+2i-2k-2m}^{(2k+2m-1)} \right)_{0 \leq i, j \leq m-1}.
 \end{aligned} \tag{6.7}$$

SKETCH OF PROOF OF THEOREM 20. Obviously, the equality between the above three determinants results from reversing the order of rows and/or columns.

Next, it should be observed that, by Corollary 14, the first determinant in (6.7) can be alternatively written as

$$\det \left(|\mathcal{A}_{2n+2i-2j}^{(k+m)}| \right)_{0 \leq i, j \leq m-1}.$$

We claim that this determinant equals the number of families $(P_0, P_1, \dots, P_{m-1})$ of non-intersecting lattice paths in the directed graph \mathcal{G}_{k+m} (see the proof of Theorem 17 and in particular Figure 6), where P_i runs from $(2i, k+m)$ to $(2n+2i, 0)$. Figure 9 shows an example of such a path family for $k = 4$, $m = 3$, and $n = 5$. (The numbers should be ignored at this point.)

From here on, everything just works completely analogously to the corresponding arguments in the proof of Theorem 17. In particular, under the correspondence between families of non-intersecting paths and arrays of alternating sequences described there, the path family in Figure 9 corresponds to the array in (6.6). We leave the details to the reader. \square

7. A third and fourth reciprocity theorem. The main results in this section are reciprocity laws for determinants of numbers of bounded up-down paths with specified starting and ending heights, see Theorems 21 and 24. As we show in Propositions 22, 25 and Theorems 23, 26, in combinatorial terms these reciprocity laws set up correspondences

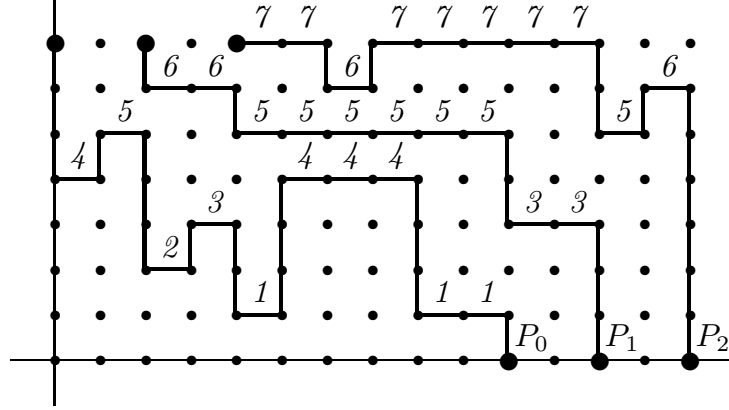

A family of non-intersecting paths in the directed graph \mathcal{G}_7

Figure 9

between families of non-intersecting bounded up-down paths with specified starting and ending heights and flagged alternating tableaux (see Section 11 for their formal definition) of rectangular shape.

The first set of results in this section concerns determinants of numbers of paths of even length and flagged alternating tableaux of rectangular shape with an odd number of columns.

Theorem 21. *Let n be a non-negative integer and k, m be positive integers, and let $r_0 < r_1 < \dots < r_{k-1}$ and $s_0 < s_1 < \dots < s_{k-1}$ be sequences of positive integers with $1 \leq r_i, s_i \leq k + m$ for all i . Then*

$$\begin{aligned} & \det \left(C_{2n}^{(2k+2m-1)}(2r_i - 2 \rightarrow 2s_j - 2) \right)_{0 \leq i, j \leq k-1} \\ &= (-1)^{\sum_{i=0}^{m-1} (\bar{r}_i + \bar{s}_i)} \det \left(C_{-2n}^{(2k+2m-1)}(2\bar{r}_i - 2 \rightarrow 2\bar{s}_j - 2) \right)_{0 \leq i, j \leq m-1}, \end{aligned} \quad (7.1)$$

where

$$\begin{aligned} \{\bar{r}_0, \bar{r}_1, \dots, \bar{r}_{m-1}\} &= \{1, 2, \dots, k + m\} \setminus \{r_0, r_1, \dots, r_{k-1}\}, \\ \{\bar{s}_0, \bar{s}_1, \dots, \bar{s}_{m-1}\} &= \{1, 2, \dots, k + m\} \setminus \{s_0, s_1, \dots, s_{k-1}\}, \end{aligned}$$

and where we assume that $\bar{r}_0 < \bar{r}_1 < \dots < \bar{r}_{m-1}$ and $\bar{s}_0 < \bar{s}_1 < \dots < \bar{s}_{m-1}$.

Our line of argument to prove the above theorem is completely analogous to the ones proving Theorems 15 and 18. Namely, by the Lindström–Gessel–Viennot theorem [26, Lemma 1], the determinant on the left-hand side of (7.1) equals the number of families $(P_0, P_1, \dots, P_{k-1})$ of non-intersecting up-down paths of height at most $2k + 2m - 1$ that do not pass below the x -axis, where P_i runs from $(0, 2r_i - 2)$ to $(2n, 2s_i - 2)$, $i = 0, 1, \dots, k - 1$. An example of such a family of non-intersecting up-down paths for $k = 4$, $m = 3$, $n = 10$, $r_0 = 1$, $r_1 = 4$, $r_2 = 5$, $r_3 = 7$, $s_0 = 2$, $s_1 = 3$, $s_2 = 5$, and $s_3 = 7$ is shown in Figure 10. (At this point, circled points and attached labels should be ignored.)

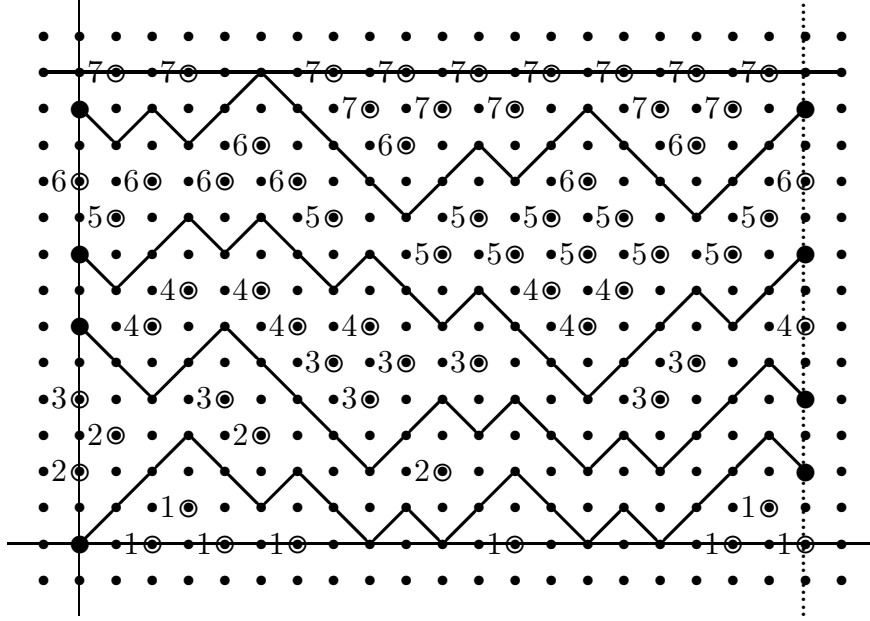

A family of non-intersecting bounded up-down paths with arbitrary starting and ending points

Figure 10

In Proposition 22 below, we shall show that there is a bijection between these families of non-intersecting up-down paths and certain rectangular arrays of alternating sequences. Subsequently, in Theorem 23, it is shown that the number of these rectangular arrays is given by the determinant on the right-hand side of (7.1). Hence, the combination of the above observation with Proposition 22 and Theorem 23 will establish Theorem 21.

Proposition 22. *With the assumptions and notation of Theorem 21, there is a bijection between families $(P_0, P_1, \dots, P_{k-1})$ of non-intersecting up-down paths of height at most $2k + 2m - 1$ that do not pass below the x -axis, where P_i runs from $(0, 2r_i - 2)$ to $(2n, 2s_i - 2)$ and rectangular arrays of integers of the form*

$$\begin{array}{cccc}
 a_{1,1} & a_{1,2} & \cdots & a_{1,2n+1} \\
 a_{2,1} & a_{2,2} & \cdots & a_{2,2n+1} \\
 \dots & \dots & \dots & \dots \\
 a_{m,1} & a_{m,2} & \cdots & a_{m,2n+1}
 \end{array} \tag{7.2}$$

where $a_{i,1} = \bar{r}_{m-i}$ and $a_{i,2n+1} = \bar{s}_{m-i}$ for all i , in which each row is alternating, that is,

$$a_{i,1} \leq a_{i,2} \geq a_{i,3} \leq a_{i,4} \geq \cdots \geq a_{i,2n+1}$$

for all i , and in which we have

$$1 \leq a_{i,j} \leq k + m$$

and

$$a_{i+1,2j} < a_{i,2j+1} > a_{i+1,2j+2}$$

for all i and j .

PROOF. The reader should consult Figure 10 while reading the following explanations. As mentioned earlier, the figure shows an example of a family of non-intersecting up-down paths as described in the statement of the proposition for $k = 4$, $m = 3$, $n = 10$, $r_0 = 1$, $r_1 = 4$, $r_2 = 5$, $r_3 = 7$, $s_0 = 2$, $s_1 = 3$, $s_2 = 5$, and $s_3 = 7$.

Analogously to the proofs of Propositions 16 and 19, for all i and j , we mark all lattice points $(2i - 1, 2j - 1)$ and all lattice points $(2i, 2j)$ in the rectangular region

$$\{(x, y) : 0 \leq y \leq 2k + 2m - 1, 0 \leq x \leq 2n\},$$

that are not occupied by any of the paths. In the figure, these lattice points are marked by circles.

Also here, each marked point acquires a label. As earlier, the label is equal to 1 plus the number of paths and marked points that are below X and have the same abscissa as X . Equivalently, the label of a marked point $X = (x, y)$ equals $\lceil (y + 1)/2 \rceil$. The figure shows the labels of these marked points.

Finally, for $i = 0, 1, \dots, 2n$, we read the labels of the marked points with abscissa i and put them into a column, and then we concatenate the columns into an array of rectangular shape as in (7.2). In this way, for the example in Figure 10, we obtain the array

$$\begin{array}{cccccccccccccccccccc} 6 & 7 & 6 & 7 & 6 & 6 & 6 & 7 & 7 & 7 & 7 & 7 & 7 & 6 & 7 & 7 & 7 & 7 & 7 & 6 \\ 3 & 5 & 4 & 4 & 3 & 4 & 4 & 5 & 4 & 6 & 5 & 5 & 5 & 5 & 5 & 5 & 6 & 5 & 5 & 4 \\ 2 & 2 & 1 & 1 & 1 & 2 & 1 & 3 & 3 & 3 & 2 & 3 & 1 & 4 & 4 & 4 & 3 & 3 & 1 & 1 & 1 \end{array} \quad (7.3)$$

It is not difficult to see that (in general) the obtained array satisfies the constraints in the statement of the proposition.

Conversely, given an array of the form (7.2) as in the statement of the proposition, if one reverses the previously described construction then one sees that this array determines a unique family of non-intersecting up-down paths as described in the statement of the proposition. \square

Theorem 23. *With the assumptions and notation of Theorem 21, the number of rectangular arrays of integers of the form (7.2) that satisfy the constraints given in the statement of Proposition 22 is equal to*

$$(-1)^{\sum_{i=0}^{m-1} (\bar{r}_i + \bar{s}_i)} \det \left(C_{-2n}^{(2k+2m-1)}(2\bar{r}_i - 2 \rightarrow 2\bar{s}_j - 2) \right)_{0 \leq i, j \leq m-1}. \quad (7.4)$$

SKETCH OF PROOF OF THEOREM 23. We observe that, by Corollary 12, the determinant in (7.4) can be alternatively written as

$$\det \left(|\mathcal{A}_{2n+1}^{(k+m)}(\bar{r}_i \rightarrow \bar{s}_j)| \right)_{0 \leq i, j \leq m-1}.$$

We claim that this determinant equals the number of families $(P_0, P_1, \dots, P_{m-1})$ of non-intersecting lattice paths in the directed graph \mathcal{G}_{k+m} (see the proof of Theorem 17 and in

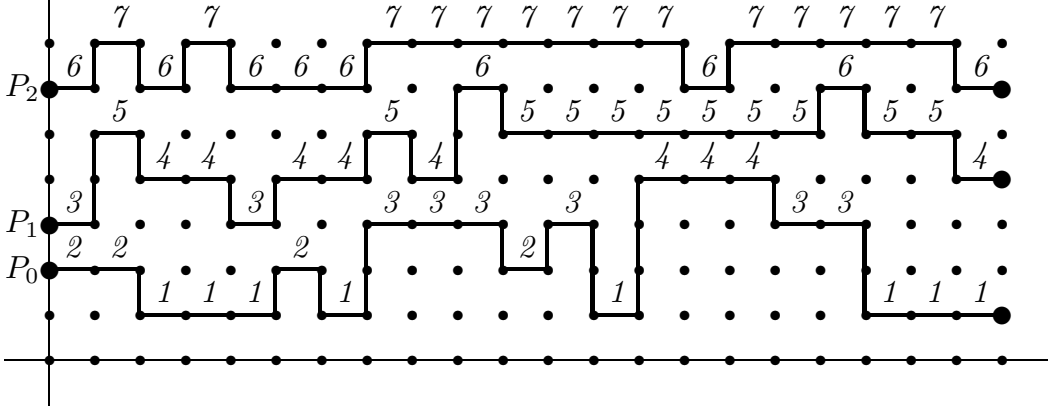

A family of non-intersecting paths in the directed graph \mathcal{G}_7

Figure 11

particular Figure 6), where P_i runs from $(0, \bar{r}_i)$ to $(2n + 1, \bar{s}_i)$, and starts and ends with a horizontal step. Figure 11 shows an example of such a path family for $k = 4$, $m = 3$, $n = 10$, $r_0 = 1$, $r_1 = 4$, $r_2 = 5$, $r_3 = 7$, $s_0 = 2$, $s_1 = 3$, $s_2 = 5$, and $s_3 = 7$, so that $\bar{r}_0 = 2$, $\bar{r}_1 = 3$, $\bar{r}_2 = 6$, $\bar{s}_0 = 1$, $\bar{s}_1 = 4$, and $\bar{s}_2 = 6$. (The numbers should be ignored at this point.)

From here on, everything just works completely analogously to the corresponding arguments in the proof of Theorem 17. In particular, under the correspondence between families of non-intersecting paths and arrays of alternating sequences described there, the path family in Figure 11 corresponds to the array in (7.3). We leave the details to the reader. \square

The second set of results in this section concerns determinants of numbers of paths of odd length and flagged alternating tableaux of rectangular shape with an even number of columns. Since the proofs are completely analogous to the previous proofs in this section, we skip them here entirely for the sake of brevity and leave them to the reader.

Theorem 24. *Let n, k, m be positive integers, and let $r_0 < r_1 < \dots < r_{k-1}$ and $s_0 < s_1 < \dots < s_{k-1}$ be sequences of positive integers with $1 \leq r_i, s_i \leq k + m$ for all i . Then*

$$\begin{aligned} \det \left(C_{2n-1}^{(2k+2m-1)}(2r_i - 2 \rightarrow 2s_j - 1) \right)_{0 \leq i, j \leq k-1} \\ = (-1)^{\sum_{i=0}^{m-1} (\bar{r}_i + \bar{s}_i)} \det \left(C_{-2n+1}^{(2k+2m-1)}(2\bar{r}_i - 2 \rightarrow 2\bar{s}_j - 1) \right)_{0 \leq i, j \leq m-1}, \end{aligned} \quad (7.5)$$

where

$$\begin{aligned} \{\bar{r}_0, \bar{r}_1, \dots, \bar{r}_{m-1}\} &= \{1, 2, \dots, k + m\} \setminus \{r_0, r_1, \dots, r_{k-1}\}, \\ \{\bar{s}_0, \bar{s}_1, \dots, \bar{s}_{m-1}\} &= \{1, 2, \dots, k + m\} \setminus \{s_0, s_1, \dots, s_{k-1}\}, \end{aligned}$$

and where we assume that $\bar{r}_0 < \bar{r}_1 < \dots < \bar{r}_{m-1}$ and $\bar{s}_0 < \bar{s}_1 < \dots < \bar{s}_{m-1}$.

By the Lindström–Gessel–Viennot theorem [26, Lemma 1], the determinant on the left-hand side of (7.1) equals the number of families $(P_0, P_1, \dots, P_{k-1})$ of non-intersecting

up-down paths of height at most $2k + 2m - 1$ that do not pass below the x -axis, where P_i runs from $(0, 2r_i - 2)$ to $(2n - 1, 2s_i - 1)$, $i = 0, 1, \dots, k - 1$.

Hence, we see that Theorem 24 will follow by combining the above observation with Proposition 25, Corollary 12 with k replaced by $k + m$, and Theorem 26.

Proposition 25. *With the assumptions and notation of Theorem 24, there is a bijection between families $(P_0, P_1, \dots, P_{k-1})$ of non-intersecting up-down paths of height at most $2k + 2m - 1$ that do not pass below the x -axis, where P_i runs from $(0, 2r_i - 2)$ to $(2n - 1, 2s_i - 1)$ and rectangular arrays of integers of the form*

$$\begin{array}{cccc} a_{1,1} & a_{1,2} & \dots & a_{1,2n} \\ a_{2,1} & a_{2,2} & \dots & a_{2,2n} \\ \dots & \dots & \dots & \dots \\ a_{m,1} & a_{m,2} & \dots & a_{m,2n} \end{array} \tag{7.6}$$

where $a_{i,1} = \bar{r}_{m-i}$ and $a_{i,2n} = \bar{s}_{m-i}$ for all i , in which each row is alternating, that is,

$$a_{i,1} \leq a_{i,2} \geq a_{i,3} \leq a_{i,4} \geq \dots \leq a_{i,2n}$$

for all i , and in which we have

$$1 \leq a_{i,j} \leq k + m$$

and

$$a_{i+1,2j} < a_{i,2j+1} > a_{i+1,2j+2}$$

for all i and j .

Theorem 26. *With the assumptions and notation of Theorem 24, the number of rectangular arrays of integers of the form (7.6) that satisfy the constraints given in the statement of Proposition 25 is equal to*

$$(-1)^{\sum_{i=0}^{m-1} (\bar{r}_i + \bar{s}_i)} \det \left(C_{-2n+1}^{(2k+2m-1)}(2\bar{r}_i - 2 \rightarrow 2\bar{s}_j - 1) \right)_{0 \leq i, j \leq m-1}. \tag{7.7}$$

8. Weighted enumeration. We now embark on the extension of the results from Sections 2–7 to a weighted setting. In this section we begin with the extensions of the enumeration results for paths and alternating sequences in Sections 2 and 3. In doing so, the Chebyshev polynomials of the second kind get replaced by two more general sequences of orthogonal polynomials. We define the sequence $(P_n(x))_{n \geq 0}$ of polynomials by the two-term recurrence

$$P_{n+1}(x) = xP_n(x) - B_n P_{n-1}(x), \quad \text{for } n \geq 1, \tag{8.1}$$

with initial conditions $P_0(x) = 1$ and $P_1(x) = x$. Here, the B_i 's are indeterminates. The sequence $(P_n(x))_{n \geq 0}$ is a sequence of orthogonal polynomials (in the formal sense) due to Favard's theorem (cf. [7] and [36, Cor. 19 on p. I-15]). Comparison with (2.2) shows

that $P_n(x) = U_n(x/2)$ if all B_i 's are equal to 1. Later we shall use two q -analogues of the Chebyshev polynomials (2.1) (with x replaced by $x/2$), namely

$$P_n(x) \Big|_{B_i=q^{i-1}} = \sum_{j \geq 0} (-1)^j q^{j(j-1)} \begin{bmatrix} n-j \\ j \end{bmatrix}_q x^{n-2j} \quad (8.2)$$

and

$$P_n(x) \Big|_{B_i=q^i} = \sum_{j \geq 0} (-1)^j q^{j^2} \begin{bmatrix} n-j \\ j \end{bmatrix}_q x^{n-2j}, \quad (8.3)$$

where the q -binomial coefficient is defined by

$$\begin{bmatrix} N \\ j \end{bmatrix}_q = \frac{(1-q^N)(1-q^{N-1}) \cdots (1-q^{N-j+1})}{(1-q^j)(1-q^{j-1}) \cdots (1-q)}. \quad (8.4)$$

The validity of (8.2) and (8.3) is easily verified by induction on n , using the recurrence (8.1).

Our second sequence, $(Q_n(x))_{n \geq 0}$ is defined by

$$Q_{n+1}(x) = \begin{cases} V_{(n+2)/2} x Q_n(x) - Q_{n-1}(x), & \text{if } n \text{ is even,} \\ A_{(n+1)/2} x Q_n(x) - Q_{n-1}(x), & \text{if } n \text{ is odd,} \end{cases} \quad \text{for } n \geq 1, \quad (8.5)$$

with initial conditions $Q_0(x) = 1$ and $Q_1(x) = V_1 x$. Here, the A_i 's and V_i 's are indeterminates. The sequence $(Q_n(x))_{n \geq 0}$ is also a sequence of orthogonal polynomials (in the formal sense), for the same reason as above. If all A_i 's and V_i 's equal 1, then $Q_n(x)$ reduces to $U_n(x/2)$. Otherwise, however, the polynomials $Q_n(x)$ are not monic, as opposed to the polynomials $P_n(x)$. Namely, the leading coefficient of $Q_{2n}(x)$ is $A_1 A_2 \cdots A_n V_1 V_2 \cdots V_n$, while the leading coefficient of $Q_{2n+1}(x)$ is $A_1 A_2 \cdots A_n V_1 V_2 \cdots V_{n+1}$. Let $Q_n^*(x)$ denote the monic form of $Q_n(x)$, that is, $Q_n(x)$ divided by its leading coefficient. Then, rewriting (8.5), we have

$$\begin{aligned} Q_{2n}^*(x) &= x Q_{2n-1}^*(x) - \frac{1}{A_n V_n} Q_{2n-2}^*(x), \\ Q_{2n+1}^*(x) &= x Q_{2n}^*(x) - \frac{1}{A_n V_{n+1}} Q_{2n-1}^*(x). \end{aligned}$$

If we compare these relations with (8.1), then we see how the polynomials $Q_n(x)$ are related to the polynomials $P_n(x)$: we have

$$P_n(x) \Big|_{\substack{B_{2i-1}=A_i^{-1}V_i^{-1} \\ B_{2i}=A_i^{-1}V_{i+1}^{-1}}} = Q_n^*(x), \quad \text{for } n \geq 0. \quad (8.6)$$

We are now going to extend Theorem 1 to a weighted setting. We introduce the following weight for up-down paths, which we are going to denote by w_B . To all up-steps we assign

a weight of 1, while to a down-step from height h to height $h - 1$ we assign a weight of B_h . The weight $w_B(P)$ of an up-down path P is defined to be the product of the weights of all its steps. Thus, the weight of the second path from top in Figure 5 (the path from $(-4, 0)$ to $(18, 0)$) is $B_5 B_7 B_6 B_5 B_6 B_6 B_6 B_5 B_4 B_3 B_2 B_1 = B_1 B_2 B_3 B_4 B_5^3 B_6^4 B_7$.

Here, and in the following, given a set \mathcal{O} of combinatorial objects, we write $\text{GF}(\mathcal{O}; w)$ for the generating function $\sum_{t \in \mathcal{O}} w(t)$.

With the above notations and definitions, the weighted extension of Theorem 1 is the following. (As indicated earlier, a further generalisation to Motzkin paths is possible, see [36, Ch. V, Eq. (27)], [19, proof of Theorem A2], [22, proof of Theorem 10.11.1]. While it is not relevant here, we shall come back to it in Section 12.(3).)

Theorem 27. *For all non-negative integers r, s, k with $0 \leq r, s \leq k$, we have*

$$\sum_{n \geq 0} \text{GF} \left(\mathcal{C}_n^{(k)}(r \rightarrow s); w_B \right) x^n = \begin{cases} \frac{P_r(1/x) T_B^{s+1} P_{k-s}(1/x)}{x P_{k+1}(1/x)}, & \text{if } r \leq s, \\ B_{s+1} B_{s+2} \cdots B_r \frac{P_s(1/x) T_B^{r+1} P_{k-r}(1/x)}{x P_{k+1}(1/x)}, & \text{if } r \geq s, \end{cases} \quad (8.7)$$

where the operator T_B , when applied to a polynomial in the B_i 's, replaces each B_i by B_{i+1} , for all i . Here, as before, $\mathcal{C}_n^{(k)}(r \rightarrow s)$ stands for the set of all up-down paths from $(0, r)$ to (n, s) of height at most k that do not pass below the x -axis.

SKETCH OF PROOF. The proof of Theorem 1 using the theory of heaps also proves the present theorem. The only thing that has to be done is to extend Lemma 3 to our weighted setting. Indeed, we claim that

$$\sum_T (-1)^{|T|} w_B(T) x^{2|T|} = x^{k+1} P_{k+1}(1/x),$$

where the sum is over all trivial heaps T of dimers on $[0, k]$, and in which $w_B(T)$ is the obvious transfer of the weight w_B to heaps of dimers where the weight of a dimer d_i is B_{i+1} .⁵ The proof of the claim works in exactly the same way as the proof of Lemma 3. In particular, the extension of the computation (2.5) is

$$(-B_k x^2) x^{k-1} P_{k-1}(1/x) + x^k P_k(1/x) = x^{k+1} P_{k+1}(1/x),$$

here following from the two-term recurrence (8.1).

The appearance of the shift T_B^{s+1} in the first case of (8.7) is explained by the fact that the second factor in the numerator represents the contribution of trivial heaps of dimers on $[s + 1, k]$, that is, in comparison to heaps on $[0, k - s - 1]$ there is a shift of $s + 1$ in the B_i 's that appears in the weights of heaps. There is an analogous explanation for the

⁵We alert the reader that our definition of weight of a dimer here is not consistent with the definition of weight of a dimer in Section 2 in that, here, we do not include x^2 — which keeps track of the length of a path, respectively of the size of a heap — in the weight. This choice makes the exposition in Section 10 more convenient. We hope that the reader bears with us.

appearance of T_B^{r+1} in the second case of (8.7). In that case, we also have to insert the factor $B_{s+1}B_{s+2}\cdots B_r$ because the reflection argument used in the proof of Theorem 1 maps down-steps to up-steps and vice versa, which is weight-preserving only for *pairs* consisting of an up- and a matching down-step;⁶ indeed, if $r > s$ then there are unmatched down-steps from height r to height $r - 1$, from height $r - 1$ to height $r - 2$, \dots , from height $s + 1$ to height s , which altogether contribute a weight of $B_r B_{r-1} \cdots B_{s+1}$. \square

If we specialise B_i to q^{i-1} then the weight $w_B(P)$ of a Dyck path P reduces to the classical *area weight* $q^{a(P)}$ of P , with $a(P)$ denoting the number of full squares that fit between the path and the zigzag lower bound on the Dyck path caused by the x -axis. This is illustrated in Figure 12. The full squares between path and x -axis are indicated by the dotted line segments. Thus, for the path P_0 in the figure we have $a(P_0) = 11$.

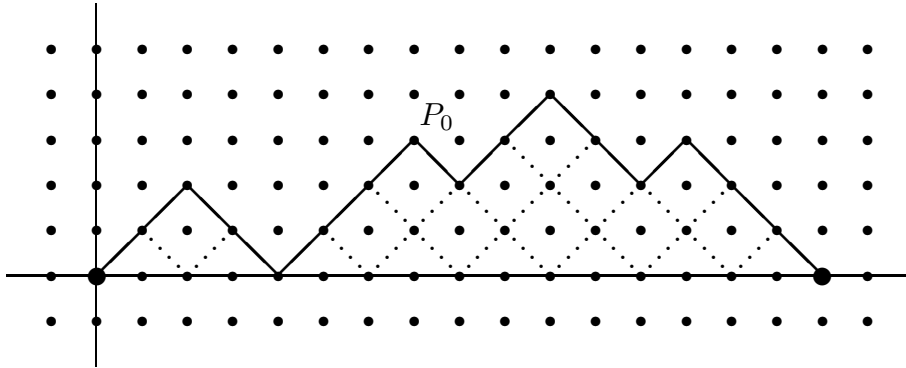

Area below a Dyck path

Figure 12

Theorem 27 with $r = s = 0$ and $B_i = q^{i-1}$ for all i together with (8.2) and (8.3) then implies that the area generating function for Dyck paths is given by (cf. [28, Cor. 2])

$$\sum_{n \geq 0} \text{GF} \left(\mathcal{C}_n^{(k)}; q^{a(\cdot)} \right) x^n = \frac{\sum_{j \geq 0} (-1)^j q^{j^2} \begin{bmatrix} k-j \\ j \end{bmatrix}_q x^{2j}}{\sum_{j \geq 0} (-1)^j q^{j(j-1)} \begin{bmatrix} k+1-j \\ j \end{bmatrix}_q x^{2j}}. \quad (8.8)$$

Next we turn to alternating sequences. We define the weight $w_{AV}(S)$ of an alternating sequence $S = a_1 \leq a_2 \geq a_3 \leq a_4 \geq \cdots \diamond a_{n-1} \square a_n$, where $(\diamond, \square) = (\geq, \leq)$ if n is even and $(\diamond, \square) = (\leq, \geq)$ if n is odd, by $\left(\prod_{i=1}^{\lfloor n/2 \rfloor} A_{a_{2i}} \right) \left(\prod_{i=1}^{\lceil n/2 \rceil} V_{a_{2i-1}} \right)$. In colloquial terms, the “top entries” in the alternating sequence are assigned the A -variables as weights, and the

⁶“Matching” up- and down-steps in up-down paths refers to the following procedure: for an up-step look to the right; if there is a down-step on the same height as the up-step then this is the “matching” down-step. Conversely, for a down-step look to the left; if there is an up-step on the same height as the down-step then this is the “matching” down-step.

“bottom entries” the V -variables.⁷ Thus, the weight of the alternating sequence on the top of Figure 2 is

$$\begin{aligned} V_4 A_4 V_3 A_3 V_1 A_1 V_1 A_3 V_2 A_6 V_6 A_8 V_4 A_7 V_4 A_4 V_2 A_3 V_2 A_2 V_2 A_5 V_5 A_6 V_3 A_6 V_5 A_8 V_6 \\ = A_1 A_2 A_3^3 A_4^2 A_5 A_6^3 A_7 A_8^2 V_1^2 V_2^4 V_3^2 V_4^3 V_5^2 V_6^2. \end{aligned}$$

The weighted extension of Theorem 4 then reads as follows.

Theorem 28. *For all positive integers r, s, k with $1 \leq r, s \leq k$, we have*

$$\begin{aligned} \sum_{n \geq 0} \text{GF} \left(\mathcal{A}_{2n+1}^{(k)}(r \rightarrow s); w_{AV} \right) x^{2n} \\ = \begin{cases} (-1)^{r+s+1} V_r V_s \frac{x Q_{2r-2}(x) T_{AV}^{s-1} R_{AV}^{(k-s+1)} Q_{2k+1-2s}(x)}{Q_{2k}(x)}, & \text{if } r < s, \\ V_r - V_r^2 \frac{x Q_{2r-2}(x) T_{AV}^{r-1} R_{AV}^{(k-r+1)} Q_{2k+1-2r}(x)}{Q_{2k}(x)}, & \text{if } r = s, \\ (-1)^{r+s+1} V_r V_s \frac{x Q_{2s-2}(x) T_{AV}^{r-1} R_{AV}^{(k-r+1)} Q_{2k+1-2r}(x)}{Q_{2k}(x)}, & \text{if } r > s, \end{cases} \quad (8.9) \end{aligned}$$

and

$$\begin{aligned} \sum_{n \geq 0} \text{GF} \left(\mathcal{A}_{2n+2}^{(k)}(r \rightarrow s); w_{AV} \right) x^{2n+1} \\ = \begin{cases} (-1)^{r+s+1} V_r A_s \frac{x Q_{2r-2}(x) T_{AV}^s Q_{2k-2s}(x)}{Q_{2k}(x)}, & \text{if } r \leq s, \\ (-1)^{r+s+1} V_r A_s \frac{x Q_{2s-1}(x) T_{AV}^{r-1} R_{AV}^{(k-r+1)} Q_{2k+1-2r}(x)}{Q_{2k}(x)}, & \text{if } r > s, \end{cases} \quad (8.10) \end{aligned}$$

where the operator T_{AV} , when applied to a polynomial in the A_i 's and V_i 's, replaces each A_i by A_{i+1} and each V_i by V_{i+1} , for all i , while the operator $R_{AV}^{(j)}$ replaces A_i by V_{j+1-i} and V_i by A_{j+1-i} for all i .⁸ Here, as before, $\mathcal{A}_n^{(k)}(r \rightarrow s)$ is the set of alternating sequences $r \leq a_2 \geq a_3 \leq a_4 \geq \cdots \diamond a_{n-1} \square s$, where $\diamond = \geq$ and $\square = \leq$ if n is even and $\diamond = \leq$ and $\square = \geq$ if n is odd, in which all a_i 's are integers between 1 and k .

SKETCH OF PROOF. The proof of Theorem 4 via the bijection of Lemma 6 between alternating sequences and heaps of segments also works here. In particular, this bijection

⁷As the reader may have guessed, the choice of letters for the weights has its explanation in the interpretation of the letter A as an arrow-like symbol pointing up and of the letter V as arrow-like symbol pointing down.

⁸While it seems that such a substitution may produce non-positively indexed A_{j+1-i} and V_{j+1-i} , this is in fact not so since, in all situations where the operator $R_{AV}^{(j)}$ is applied, it is applied to A_i 's and V_i 's with $i \leq j$.

will be weight-preserving with respect to w_{AV} if we declare the weight⁹ of a segment $j-i$ to be $w_{AV}(j-i) := V_i A_j$, and the weight $w_{AV}(H)$ of a heap H with marked vertex $(0, r)$ (corresponding to the first element r of the associated alternating sequence; see Figure 3) to be V_r times the product of all the weights $w_{AV}(s)$ of segments s of H .

Here we have to extend Lemmas 7 and 8 to our weighted setting. In generalisation of Lemma 7, we claim that

$$\sum_{T \text{ trivial heap on } [1, k]} (-1)^{|T|} w_{AV}(T) x^{2|T|} = (-1)^k Q_{2k}(x). \quad (8.11)$$

Proceeding again by induction, and recalling the three possibilities (a)–(c) in the proof of Lemma 7, the sum of the contributions of these three possible sets of trivial heaps is

$$\begin{aligned} & V_{k+1} A_{k+1} (-x^2) (-1)^k Q_{2k}(x) + (-1)^k Q_{2k}(x) + \frac{A_{k+1}}{A_k} ((-1)^k Q_{2k}(x) - (-1)^{k-1} Q_{2k-2}(x)) \\ &= (-1)^{k+1} (V_{k+1} A_{k+1} x^2 Q_{2k}(x) - Q_{2k}(x) - A_{k+1} x Q_{2k-1}(x)) \\ &= (-1)^{k+1} (A_{k+1} x Q_{2k+1}(x) - Q_{2k}(x)) \\ &= (-1)^{k+1} Q_{2k+2}(x), \end{aligned}$$

where, during the computation, we applied (8.5) for $n = 2k - 1, 2k, 2k + 1$, in that order. This establishes the induction step.

In order to extend Lemma 8 to our weighted setting, we start with the observation that

$$R_{AV}^{(j)} Q_{2j}(x) = Q_{2j}(x), \quad \text{for } j \geq 0. \quad (8.12)$$

This is not obvious at all from the definition (8.5) of the polynomials $Q_n(x)$, but it is obvious from (8.11) by vertically reflecting the heaps. The same reasoning yields

$$R_{AV}^{(j+1)} T_{AV} Q_{2j}(x) = Q_{2j}(x), \quad \text{for } j \geq 0. \quad (8.13)$$

Recalling (3.5), we have to compute the sum

$$- \sum_{\substack{T \text{ trivial heap} \\ T \subseteq [1, r-1] \cup [s, k] \\ T \not\subseteq [1, r-1] \cup [s+1, k]}} (-1)^{|T|} w_{AV}(T) x^{2|T|}.$$

⁹Here also, our definition of weight of a segment is not consistent with the definition of weight of a segment in Section 3 in that, here, we do not include x^2 — which keeps track of the size of an alternating sequence, respectively of a heap — in the weight. This choice makes the exposition in Section 10 more convenient. Again, we hope that the reader bears with us.

By the analogue of the computation (3.6) in the weighted setting, this sum is equal to

$$\begin{aligned}
& -(-1)^{r-1}Q_{2r-2}(x) \left((-1)^{k-s+1}T_{AV}^{s-1}Q_{2k-2s+2}(x) - (-1)^{k-s}T_{AV}^sQ_{2k-2s}(x) \right) \\
& = (-1)^{k+r+s+1}Q_{2r-2}(x) T_{AV}^{s-1} \left(Q_{2k-2s+2}(x) + T_{AV}Q_{2k-2s}(x) \right) \\
& = (-1)^{k+r+s+1}Q_{2r-2}(x) \\
& \quad \times T_{AV}^{s-1}R_{AV}^{(k-s+1)} \left(R_{AV}^{(k-s+1)}Q_{2k-2s+2}(x) + R_{AV}^{(k-s+1)}T_{AV}Q_{2k-2s}(x) \right) \\
& = (-1)^{k+r+s+1}Q_{2r-2}(x) T_{AV}^{s-1}R_{AV}^{(k-s+1)} \left(Q_{2k-2s+2}(x) + Q_{2k-2s}(x) \right) \\
& = (-1)^{k+r+s+1}Q_{2r-2}(x) T_{AV}^{s-1}R_{AV}^{(k-s+1)}A_{k-s+1}x Q_{2k-2s+1}(x) \\
& = (-1)^{k+r+s+1}V_sx Q_{2r-2}(x) T_{AV}^{s-1}R_{AV}^{(k-s+1)}Q_{2k-2s+1}(x). \tag{8.14}
\end{aligned}$$

Here we used (8.12) and (8.13) to obtain the third equality and the defining two-term recurrence (8.5) to obtain the fourth equality.

These arguments prove (8.9).

For the proof of the first case in (8.10), we use the weighted version of the recurrence (3.7),

$$\text{GF} \left(\mathcal{A}_{2n+2}^{(k)}(r \rightarrow s); w_{AV} \right) = \sum_{j=1}^s A_s \text{GF} \left(\mathcal{A}_{2n+1}^{(k)}(r \rightarrow j); w_{AV} \right).$$

The recurrence implies

$$\sum_{n \geq 0} \text{GF} \left(\mathcal{A}_{2n+2}^{(k)}(r \rightarrow s); w_{AV} \right) x^{2n+1} = A_s \sum_{j=1}^s \sum_{n \geq 0} \text{GF} \left(\mathcal{A}_{2n+1}^{(k)}(r \rightarrow j); w_{AV} \right) x^{2n+1}.$$

Let $r > s$. By the second and third case of (8.9), we obtain

$$\begin{aligned}
& \sum_{n \geq 0} \text{GF} \left(\mathcal{A}_{2n+2}^{(k)}(r \rightarrow s); w_{AV} \right) x^{2n+1} \\
& = A_s \sum_{j=1}^s xV_rV_j (-1)^{r+j+1} \frac{xQ_{2j-2}(x) T_{AV}^{r-1}R_{AV}^{(k-r+1)}Q_{2k+1-2r}(x)}{Q_{2k}(x)} \\
& = (-1)^r V_r A_s \frac{xT_{AV}^{r-1}R_{AV}^{(k-r+1)}Q_{2k+1-2r}(x)}{Q_{2k}(x)} \sum_{j=1}^s (-1)^{j-1} V_j xQ_{2j-2}(x) \\
& = (-1)^r V_r A_s \frac{xT_{AV}^{r-1}R_{AV}^{(k-r+1)}Q_{2k+1-2r}(x)}{Q_{2k}(x)} \sum_{j=1}^s (-1)^{j-1} (Q_{2j-1}(x) + Q_{2j-3}(x)) \\
& = (-1)^r V_r A_s \frac{xT_{AV}^{r-1}R_{AV}^{(k-r+1)}Q_{2k+1-2r}(x)}{Q_{2k}(x)} (-1)^{s-1} Q_{2s-1}(x),
\end{aligned}$$

where we used (8.5) to obtain the next-to-last equality. Thus, we obtain exactly the second expression on the right-hand side of (8.10).

Now let $r \leq s$. We proceed as in the proof of Theorem 4, where we mapped the alternating sequences S in $\mathcal{A}_{2n+2}^{(k)}(r \rightarrow s)$ bijectively to heaps H of n segments on $[1, k]$ whose maximal segments are not contained in $[1, r-1] \cup [s+1, k]$. This bijection is weight-preserving in the sense that $w_{AV}(S) = V_r A_s w_{AV}(H)$. Then, by (3.8), with the weight w being defined by $w_{AV}(T)x^{2|T|}$, and by (8.11), we obtain the first expression on the right-hand side of (8.10) straightforwardly.

This completes the proof of the theorem. \square

As consequences of the above theorem, we can now give the weighted generalisations of Corollaries 9 and 10. We omit the proofs since they are identical with those of these corollaries, except that they use Theorem 28 instead of Theorem 4.

Corollary 29. *For all positive integers k , we have*

$$\sum_{n \geq 1} \text{GF} \left(\mathcal{A}_{2n-1}^{(k)}; w_{AV} \right) x^{2n} = -\frac{x Q_{2k-1}(x)}{Q_{2k}(x)}. \quad (8.15)$$

Corollary 30. *For all positive integers k , we have*

$$\sum_{n \geq 0} \text{GF} \left(\mathcal{A}_{2n}^{(k)}; w_{AV} \right) x^{2n+1} = (-1)^k \frac{x}{Q_{2k}(x)}. \quad (8.16)$$

For later use, we work out one more special case of Theorem 28. Namely, in Section 12.(5) we shall need the special case of (8.9) in which $r = s = 1$,

$$\sum_{n \geq 0} \text{GF} \left(\mathcal{A}_{2n+1}^{(k)}(1 \rightarrow 1); w_{AV} \right) x^{2n} = -V_1^2 \frac{x R_{AV}^{(k)} Q_{2k-1}(x)}{Q_{2k}(x)}, \quad (8.17)$$

in which $A_i = (yq)^i$ and $V_i = y^{-i}$ for $i \geq 1$. We claim that we have

$$Q_{2k}(x) \Big|_{\substack{A_i=(yq)^i \\ V_i=y^{-i}}} = 1 + \sum_{j=1}^k (-1)^{k-j} x^{2j} q^{\binom{j+1}{2}} \sum_{i=0}^{k-j} (yq)^i \begin{bmatrix} k-i \\ j \end{bmatrix}_q \begin{bmatrix} i+j-1 \\ j-1 \end{bmatrix}_q, \quad (8.18)$$

and

$$Q_{2k-1}(x) \Big|_{\substack{A_i=(yq)^i \\ V_i=y^{-i}}} = \sum_{j=1}^k (-1)^{k-j} x^{2j-1} q^{\binom{j}{2}} \sum_{i=0}^{k-j} y^{-k+i} \begin{bmatrix} k-i-1 \\ j-1 \end{bmatrix}_q \begin{bmatrix} i+j-1 \\ j-1 \end{bmatrix}_q.$$

This is easily verified by induction on k using the defining recurrence (8.5). However, what we need in (8.17) is not the above specialisation of $Q_{2k-1}(x)$, but rather that specialisation of $R_{AV}^{(k)} Q_{2k-1}(x)$. The key to obtain the latter specialisation is the identity

$$V_1 x R_{AV}^{(k)} Q_{2k-1}(x) = Q_{2k}(x) + T_{AV} Q_{2k-2}(x)$$

that we (implicitly) established in (8.14) (choose $r = s = 1$ there). Since the total degree in the A_i 's in the coefficient of x^{2j} in $Q_{2k}(x)$ is j for all j , and the same is true for the total degree in the V_i 's, the specialisation

$$T_{AV}Q_{2k-2}(x) \Big|_{\substack{A_i=(yq)^i \\ V_i=y^{-i}}} = Q_{2k-2}(x) \Big|_{\substack{A_i=(yq)^{i+1} \\ V_i=y^{-i-1}}}$$

can be easily obtained from (8.18) by replacing x by $xq^{1/2}$. After simplification, we obtain

$$R_{AV}^{(k)}Q_{2k-1}(x) \Big|_{\substack{A_i=(yq)^i \\ V_i=y^{-i}}} = y \sum_{j=1}^k (-1)^{k-j} x^{2j-1} q^{\binom{j+1}{2}} \sum_{i=0}^{k-j} (yq)^i \begin{bmatrix} k-i-1 \\ j-1 \end{bmatrix}_q \begin{bmatrix} i+j-1 \\ j-1 \end{bmatrix}_q. \quad (8.19)$$

9. Generating functions for bounded paths “with negative length” and bounded alternating sequences. Our next goal is to find the weighted generalisations of Corollaries 12–14 on “numbers of paths with negative length”. We shall abuse notation here: when, for a *positive* integer n we write

$$\text{GF} \left(\mathcal{C}_{-n}^{(k)}(r \rightarrow s); w_B \right), \quad (9.1)$$

then we mean the value of the corresponding term in the continuation of the sequence

$$\left(\text{GF} \left(\mathcal{C}_n^{(k)}(r \rightarrow s); w_B \right) \right)_{n \geq 0},$$

to negative integers, using the linear recurrence that it satisfies in the backward direction. (The above sequence satisfies indeed a linear recurrence since its generating function is rational; cf. Theorem 27.)

In view of (8.6), we introduce the weight w_{BAV} on up-down paths by what we get from w_B when we do the replacements $B_{2i-1} = A_i^{-1}V_i^{-1}$ and $B_{2i} = A_i^{-1}V_{i+1}^{-1}$ for all i . Explicitly, all up-steps are assigned a weight of 1, while a down-step from height $2i-1$ to height $2i-2$ is assigned a weight of $A_i^{-1}V_i^{-1}$, and a down-step from height $2i$ to height $2i-1$ is assigned a weight of $A_i^{-1}V_{i+1}^{-1}$.

We then have the following weighted extension of Corollary 12.

Corollary 31. *Let n, k, r, s be positive integers with $1 \leq r, s \leq k$. We have*

$$\begin{aligned} (-1)^{r+s} \left(\prod_{i=r}^{s-1} A_i^{-1} \right) \left(\prod_{i=r+1}^{s-1} V_i^{-1} \right) \text{GF} \left(\mathcal{C}_{-2n}^{(2k-1)}(2r-2 \rightarrow 2s-2); w_{BAV} \right) \\ = \text{GF} \left(\mathcal{A}_{2n+1}^{(k)}(r \rightarrow s); w_{AV} \right). \end{aligned} \quad (9.2)$$

Furthermore, we have

$$\begin{aligned} (-1)^{r+s} \left(\prod_{i=r}^{s-1} A_i^{-1} \right) \left(\prod_{i=r+1}^s V_i^{-1} \right) \text{GF} \left(\mathcal{C}_{-2n+1}^{(2k-1)}(2r-2 \rightarrow 2s-1); w_{BAV} \right) \\ = \text{GF} \left(\mathcal{A}_{2n}^{(k)}(r \rightarrow s); w_{AV} \right). \end{aligned} \quad (9.3)$$

Here and in the sequel, the products have to be interpreted in an extended sense by

$$\prod_{k=R}^{S-1} \text{Expr}(k) = \begin{cases} \prod_{k=R}^{S-1} \text{Expr}(k), & R < S, \\ 1, & R = S, \\ \prod_{k=S}^{R-1} (\text{Expr}(k))^{-1}, & R > S. \end{cases} \quad (9.4)$$

PROOF. We do the replacements $k \rightarrow 2k - 1$, $r \rightarrow 2r - 2$, $s \rightarrow 2s - 2$, and we set $B_{2i-1} = A_i^{-1}V_i^{-1}$ and $B_{2i} = A_i^{-1}V_{i+1}^{-1}$ for all i in Theorem 27. Subsequently, in order to obtain the generating function for the quantities (9.1), we apply (4.2). By (8.6) and the easily verified relations

$$T_B^2 P_n(x) \Big|_{\substack{B_{2i-1}=A_i^{-1}V_i^{-1} \\ B_{2i}=A_i^{-1}V_{i+1}^{-1}}} = T_{AV} \left(P_n(x) \Big|_{\substack{B_{2i-1}=A_i^{-1}V_i^{-1} \\ B_{2i}=A_i^{-1}V_{i+1}^{-1}}} \right) \quad (9.5)$$

and

$$T_B P_{2n+1}(x) \Big|_{\substack{B_{2i-1}=A_i^{-1}V_i^{-1} \\ B_{2i}=A_i^{-1}V_{i+1}^{-1}}} = R_{AV}^{(n+1)} \left(P_{2n+1}(x) \Big|_{\substack{B_{2i-1}=A_i^{-1}V_i^{-1} \\ B_{2i}=A_i^{-1}V_{i+1}^{-1}}} \right), \quad (9.6)$$

we obtain after some simplification

$$\begin{aligned} & \sum_{n \geq 1} \text{GF} \left(\mathcal{C}_{-2n}^{(2k-1)}(2r-2 \rightarrow 2s-2); w_{BAV} \right) x^{2n} \\ &= \begin{cases} -\frac{A_r \cdots A_{s-1} V_r \cdots V_s x Q_{2r-2}(x) T_{AV}^{s-1} R_{AV}^{(k-s+1)} Q_{2k-2s+1}(x)}{Q_{2k}(x)}, & \text{if } r \leq s, \\ -\frac{x Q_{2s-2}(x) T_{AV}^{r-1} R_{AV}^{(k-r+1)} Q_{2k-2r+1}(x)}{A_s \cdots A_{r-1} V_{s+1} \cdots V_{r-1} Q_{2k}(x)}, & \text{if } r \geq s, \end{cases} \\ &= (-1)^{r+s} \left(\prod_{i=r}^{s-1} A_i \right) \left(\prod_{i=r+1}^{s-1} V_i \right) \sum_{n \geq 1} \text{GF} \left(\mathcal{A}_{2n+1}^{(k)}(r \rightarrow s); w_{AV} \right) x^{2n}, \end{aligned}$$

where we appealed to Theorem 28 to get the last line. Comparison of coefficients of x^{2n} then establishes the relation (9.2).

For proving (9.3), we proceed in the same way. Here, we do the replacements $k \rightarrow 2k - 1$, $r \rightarrow 2r - 2$, $s \rightarrow 2s - 1$, and we set $B_{2i-1} = A_i^{-2}$ and $B_{2i} = A_i^{-1}A_{i+1}^{-1}$ for all i in Theorem 27. The generating function identity that we obtain here is

$$\begin{aligned} & \sum_{n \geq 1} \text{GF} \left(\mathcal{C}_{-2n+1}^{(2k-1)}(2r-2 \rightarrow 2s-1); w_{BAV} \right) x^{2n-1} \\ &= \begin{cases} -\frac{A_r \cdots A_s V_r \cdots V_s x Q_{2r-2}(x) T_{AV}^s Q_{2k-2s}(x)}{Q_{2k}(x)}, & \text{if } r \leq s, \\ -\frac{x Q_{2s-1}(x) T_{AV}^{r-1} R_{AV}^{(k-r+1)} Q_{2k-2r+1}(x)}{A_{s+1} \cdots A_{r-1} V_{s+1} \cdots V_{r-1} Q_{2k}(x)}, & \text{if } r \geq s, \end{cases} \\ &= (-1)^{r+s} \left(\prod_{i=r}^{s-1} A_i \right) \left(\prod_{i=r+1}^s V_i \right) \sum_{n \geq 1} \text{GF} \left(\mathcal{A}_{2n}^{(k)}(r \rightarrow s); w_{AV} \right) x^{2n-1}, \end{aligned}$$

from which (9.3) follows immediately upon comparison of coefficients of x^{2n-1} . \square

By specialising the above corollary appropriately, we obtain the weighted extensions of Corollaries 13 and 14.

Corollary 32. *For positive integers n and k , we have*

$$A_k^{-1} R_{AV}^{(k)} \text{GF} \left(\mathcal{C}_{-2n}^{(2k-1)}; w_{BAV} \right) = \text{GF} \left(\mathcal{A}_{2n-1}^{(k)}; w_{AV} \right). \quad (9.7)$$

PROOF. We put $r = s = 1$ in (9.2). Then, on the right-hand side, we have the generating function for sequences $1 \leq a_2 \geq a_3 \leq a_4 \geq \dots \leq a_{2n} \geq 1$. By skipping the 1's at the beginning and at the end, and replacing each a_i by a_{k+1-i} , we obtain a sequence in $\mathcal{A}_{2n-1}^{(k)}$. However, in terms of the weight w_{AV} , this replacement amounts to an application of the operator $R_{AV}^{(k)}$. \square

Corollary 33. *Let n and k be positive integers. Furthermore, denote the set of up-down paths from $(0, 0)$ to $(2n + 2k - 1, 2k - 1)$ of height at most $2k - 1$ that do not pass below the x -axis by $\mathcal{D}_{2n}^{(2k-1)}$. Then we have*

$$(-1)^{k+1} \left(\prod_{i=1}^k A_i^{-1} V_i^{-1} \right) \text{GF} \left(\mathcal{D}_{-2n-2k}^{(2k-1)}; w_{BAV} \right) = \text{GF} \left(\mathcal{A}_{2n}^{(k)}; w_{AV} \right). \quad (9.8)$$

PROOF. In the same way as the previous corollary, by putting $r = 1$ and $s = k$ in (9.3), we get

$$(-1)^{k+1} \left(\prod_{i=1}^k A_i^{-1} V_i^{-1} \right) R_{AV}^{(k)} \text{GF} \left(\mathcal{D}_{-2n-2k}^{(2k-1)}; w_{BAV} \right) = \text{GF} \left(\mathcal{A}_{2n}^{(k)}; w_{AV} \right),$$

or, equivalently,

$$(-1)^{k+1} \left(\prod_{i=1}^k A_i^{-1} V_i^{-1} \right) \text{GF} \left(\mathcal{D}_{-2n-2k}^{(2k-1)}; w_{BAV} \right) = R_{AV}^{(k)} \text{GF} \left(\mathcal{A}_{2n}^{(k)}; w_{AV} \right).$$

Now, by (8.12), we know that the operator $R_{AV}^{(k)}$ leaves $Q_{2k}(x)$ invariant. If we use this in combination with Corollary 30, then we see that $R_{AV}^{(k)}$ also leaves $\text{GF} \left(\mathcal{A}_{2n}^{(k)}; w_{AV} \right)$ invariant. Hence, the above identity can be simplified to (9.8). \square

10. Weighted reciprocity theorems. We now turn to the weighted versions of the reciprocity laws in Sections 5–7. We begin with the weighted generalisation of Theorem 15.

Theorem 34. For all non-negative integers n, k, m , we have

$$\begin{aligned} & \det \left(\text{GF} \left(\mathcal{C}_{2n+2i+2j+4m-2}^{(2k+2m-1)}; w_{BAV} \right) \right)_{0 \leq i, j \leq k-1} \\ &= \left(V_1^k A_{k+m}^{-m} \prod_{i=1}^{k+m} A_i^{-(n+2m+2k-2i-1)} V_i^{-(n+2m+2k-2i)} \right) \\ & \quad \times \det \left(R_{AV}^{(k+m)} \text{GF} \left(\mathcal{C}_{-2n-2i-2j}^{(2k+2m-1)}; w_{BAV} \right) \right)_{0 \leq i, j \leq m-1}. \end{aligned} \quad (10.1)$$

REMARK. A notable special case arises if we choose $A_i = V_i = q^{-i+1}$, $i \geq 1$. The reader should recall that the weight w_{BAV} resulted from the weight w_B under the substitutions $B_{2i-1} = A_i^{-1} V_i^{-1}$ and $B_{2i} = A_i^{-1} V_{i+1}^{-1}$, $i \geq 1$. Thus, the above choice of the A_i 's and V_i 's implies the choice $B_i = q^{i-1}$, $i \geq 1$. Now we should remember that for this choice of the B_i 's the weight w_B reduces to the area weight $q^{a(\cdot)}$, with the corresponding generating function for the terms $\text{GF}(\mathcal{C}_n^{(k)}; q^{a(\cdot)})$ given in (8.8). After considerable simplification, we obtain the reciprocity law

$$\begin{aligned} & \det \left(\text{GF} \left(\mathcal{C}_{2n+2i+2j+4m-2}^{(2k+2m-1)}; q^{a(\cdot)} \right) \right)_{0 \leq i, j \leq k-1} \\ &= q^{2 \binom{k}{2} \left(\frac{4k+1}{6} + n + 2m - 2 \right) - 2 \binom{m}{2} (n-1 + \frac{8m-1}{6})} \det \left(\text{GF} \left(\mathcal{C}_{-2n-2i-2j}^{(2k+2m-1)}; q^{-a(\cdot)} \right) \right)_{0 \leq i, j \leq m-1}. \end{aligned} \quad (10.2)$$

For the proof of Theorem 34, we follow the arguments of the proof of Theorem 15. Namely, the Lindström–Gessel–Viennot theorem [26, Lemma 1] shows that the determinant on the left-hand side of (10.1) is the generating function for families $\mathcal{P} = (P_0, P_1, \dots, P_{k-1})$ of non-intersecting Dyck paths of height at most $2k+2m-1$, where P_i runs from $(-2i, 0)$ to $(2n+4m+2i-2, 0)$, $i = 0, 1, \dots, k-1$, with respect to the weight w_{BAV} . Here, the weight $w_{BAV}(\mathcal{P})$ is defined as $\prod_{i=0}^{k-1} w_{BAV}(P_i)$. By the bijection in Proposition 16, the families \mathcal{P} of non-intersecting Dyck paths are related to trapezoidal arrays of alternating sequences. How the weights are related under this bijection is spelled out in Lemma 35 below. The weight w_{BAV} for families of Dyck paths has been just explained, while the weight $w_{AV}(\mathcal{A})$ of a trapezoidal array $\mathcal{A} = (a_{i,j})$ is defined by $\prod_{i,j} A_{a_{i,2j}} V_{a_{i,2j-1}}$, that is, entries in even-indexed columns contribute A -variables, while entries in odd-indexed columns contribute V -variables. Finally, the arguments in the proof of Theorem 17 together with Corollary 32, the weighted version of Corollary 13, show that, up to some scaling, the determinant on the right-hand side is the generating function for these trapezoidal arrays of alternating sequences with respect to the weight w_{AV} , see Theorem 36.

Lemma 35. Let n be a non-negative integer and k, m be positive integers. Furthermore, let $\mathcal{P} = (P_0, P_1, \dots, P_{k-1})$ be a family of non-intersecting Dyck paths of height at most $2k+2m-1$, where P_i runs from $(-2i, 0)$ to $(2n+4m+2i-2, 0)$, $i = 0, 1, \dots, k-1$, and \mathcal{A} the trapezoidal array of integers of the form (5.2) that corresponds to \mathcal{P} under the bijection of Proposition 16. Then

$$\left(V_1^{-k} \prod_{i=1}^{k+m} A_i^{-(n+2m+2k-2i-1)} V_i^{n+2m+2k-2i} \right) w_{BAV}(\mathcal{P}) = w_{AV}(\mathcal{A}). \quad (10.3)$$

SKETCH OF PROOF. The reader should recall that the bijection of Proposition 16 worked as follows: in the region (5.6) all the lattice points (x, y) with x and y of the same parity, which are not occupied by any of the Dyck paths of \mathcal{P} , contribute an entry to the trapezoidal array \mathcal{A} ; more precisely, such a lattice point contributes the entry $\lceil (y+1)/2 \rceil$. If we now look at the weight w_{AV} of arrays, then we see that such a lattice point contributes $V_{(y+2)/2}$ to the weight $w_{AV}(\mathcal{A})$ of the array \mathcal{A} if y is even, while it contributes $A_{(y+1)/2}$ if y is odd.

In order to see how the weights $w_{BAV}(\mathcal{P})$ and $w_{AV}(\mathcal{A})$ are related, we change w_{BAV} to the equivalent weight \bar{w}_{BAV} . This weight \bar{w}_{BAV} is defined by assigning a weight of A_y^{-1} to up-steps from height $2y-2$ to height $2y-1$ and to down-steps from height $2y$ to height $2y-1$, and assigning a weight of V_{y+1}^{-1} to up-steps from height $2y-1$ to height $2y$ and to down-steps from height $2y+1$ to height $2y$. For a Dyck path P we have indeed $w_{BAV}(P) = \bar{w}_{BAV}(P)$ since up- and down-steps in Dyck paths can be paired up (cf. Footnote 6), and a matching pair of steps $(x_1, y-1) \rightarrow (x_1+1, y)$ and $(x_2, y) \rightarrow (x_2+1, y-1)$ contributes a weight of $A_{\lceil (y+1)/2 \rceil}^{-1} V_{\lceil (y+1)/2 \rceil}^{-1}$ to $\bar{w}_{BAV}(P)$ as well as to $w_{BAV}(P)$.

We should think of the weight $A_{(y+1)/2}^{-1}$, respectively $V_{(y+2)/2}^{-1}$, as attached to the end point (x, y) of a step (up or down). More precisely, due to the fact that x and y must have the same parity, the weight $A_{(y+1)/2}^{-1}$ is attached to (x, y) if x and y are odd, and if x and y are even then it is $V_{(y+2)/2}^{-1}$ which is attached to it. It then becomes apparent that the weighting \bar{w}_{BAV} is chosen so as to “kill” the contribution of (x, y) to the array weight w_{AV} . Hence, to verify the relation (10.3), all that remains is to determine the total contribution of lattice points (x, y) with x and y of the same parity in the region (5.6). A small detail is that, in this count, we have to leave out the points $(-2i, 0)$, $i = 0, \dots, k-1$, since all these points are occupied by paths (being actually the starting points of the paths) but are not end points of steps. \square

Theorem 36. *Let n be a non-negative integer and k, m be positive integers. The generating function $\sum_{\mathcal{A}} w_{AV}(\mathcal{A})$, where the sum is over all trapezoidal arrays of integers of the form (5.2) that satisfy (5.3)–(5.5), and the additional restrictions mentioned in the statement of Proposition 16 in the case where $n = 0$, is equal to*

$$A_{k+m}^{-m} \det \left(R_{AV}^{(k+m)} \text{GF} \left(\mathcal{C}_{-2n-2i-2j}^{(2k+2m-1)}; w_{BAV} \right) \right)_{0 \leq i, j \leq m-1}. \quad (10.4)$$

PROOF. It should be noted that, by Corollary 32, the determinant in (5.8) can be alternatively written as

$$\det \left(\text{GF} \left(\mathcal{A}_{2n+2i+2j-1}^{(k+m)}; w_{AV} \right) \right)_{0 \leq i, j \leq m-1}.$$

The proof of Theorem 17 can then be used verbatim, the only difference being that here the paths in the application of the Lindström–Gessel–Viennot theorem carry weights. \square

Following the same line of argument, we obtain the following weighted generalisation of Theorem 18. We content ourselves with stating the result together with the auxiliary

result addressing the weight property that the bijection in Proposition 19 satisfies and the relevant generating function result for arrays of alternating sequences, see Lemma 38 and Theorem 39 below. We point out a subtlety in the proof of Lemma 38 though: since the paths are not Dyck paths but rather paths starting at height 0 and ending at height $2k + 2m - 1$, not every up-step has a matching down-step, and therefore the weights w_{BAV} and \bar{w}_{BAV} do not agree on these paths. More precisely, for such a path P we have

$$w_{BAV}(P) = \left(V_1^{-1} \prod_{i=1}^{k+m} A_i V_i \right) \bar{w}_{BAV}(P). \quad (10.5)$$

A second subtlety in this context is that the invariance of $\text{GF} \left(\mathcal{A}_{2n}^{(k+m)}; w_{AV} \right)$ under the action of the operator $R_{AV}^{(k+m)}$, which was already used in the proof of Corollary 33, is also applied here. We leave the remaining details of the proofs to the reader.

Theorem 37. *With the sets $\mathcal{D}_{2n}^{(2k+2m-1)}$ explained in Corollary 33, for all non-negative integers n and positive integers k, m , we have*

$$\det \left(\text{GF} \left(\mathcal{D}_{2n+2j-2i}^{(2k+2m-1)}; w_{BAV} \right) \right)_{0 \leq i, j \leq k-1} = (-1)^{km} \left(\prod_{i=1}^{k+m} A_i^{-n-m} V_i^{-n-m} \right) \times \det \left(\text{GF} \left(\mathcal{D}_{-2n-2j+2i-2k-2m}^{(2k+2m-1)}; w_{BAV} \right) \right)_{0 \leq i, j \leq m-1}. \quad (10.6)$$

Lemma 38. *Let n be a non-negative integer and k, m be positive integers. Furthermore, let $\mathcal{P} = (P_0, P_1, \dots, P_{k-1})$ be a family of non-intersecting up-down paths of height at most $2k + 2m - 1$ that do not pass below the x -axis, where P_i runs from $(2i, 0)$ to $(2n + 2m + 2k + 2i - 1, 2k + 2m - 1)$, $i = 0, 1, \dots, k - 1$, and \mathcal{A} the rhomboidal array of integers of the form (6.2) that corresponds to \mathcal{P} under the bijection of Proposition 19. Then*

$$\left(\prod_{i=1}^{k+m} A_i^n V_i^n \right) w_{BAV}(\mathcal{P}) = w_{AV}(\mathcal{A}). \quad (10.7)$$

Theorem 39. *Let n be a non-negative integer and k, m be positive integers. The generating function $\sum_{\mathcal{A}} w_{AV}(\mathcal{A})$, where the sum is over all rhomboidal arrays of integers of the form (6.2) that satisfy (6.3)–(6.5) is equal to*

$$(-1)^{km} \left(\prod_{i=1}^{k+m} A_i^{-m} V_i^{-m} \right) \det \left(\text{GF} \left(\mathcal{D}_{-2n-2j+2i-2k-2m}^{(2k+2m-1)}; w_{BAV} \right) \right)_{0 \leq i, j \leq m-1}. \quad (10.8)$$

It is interesting to note that Theorem 37 implies a (seemingly) more general reciprocity result for Hankel determinants of sequences which satisfy a linear recurrence with constant coefficients, which we state below.

Theorem 40. Let k and m be positive integers, and let a_0, a_1, \dots, a_{k+m} be given constants. Furthermore, let the sequence $(c(n))_{n \in \mathbb{Z}}$ (with \mathbb{Z} denoting the set of all integers) be defined by the recurrence

$$\sum_{i=0}^{k+m} a_i c(n-i) = 0, \quad (10.9)$$

with initial conditions $c(n) = 0$ for $-k - m + 1 \leq n \leq -1$. It is understood that the recurrence is read both ways, that is, in the positive direction as well as in the negative direction. Then, for all non-negative integers n , we have

$$\begin{aligned} & \det \left(c(n+i+j) \right)_{0 \leq i, j \leq k-1} \\ &= (-1)^{\binom{n+k+m}{2} + \binom{n}{2}} c^{k-m}(0) \left(\frac{a(k+m)}{a(0)} \right)^{n+k+m-1} \det \left(c(-n-i-j-2k) \right)_{0 \leq i, j \leq m-1}. \end{aligned} \quad (10.10)$$

SKETCH OF PROOF. We rewrite (10.6) by replacing i by $k-1-i$ on the left-hand side and by replacing i by $m-1-i$ on the right-hand side, both replacements leaving the corresponding determinants invariant up to a sign since they amount to reversals of the order of rows of the matrices of which the determinants are taken. Subsequently, we replace n by $n+k-1$. The result is

$$\begin{aligned} \det \left(\text{GF} \left(\mathcal{D}_{2n+2i+2j}^{(2k+2m-1)}; w_{BAV} \right) \right)_{0 \leq i, j \leq k-1} &= (-1)^{\binom{k+m}{2}} \left(\prod_{i=1}^{k+m} A_i^{-n-m} V_i^{-n-m} \right) \\ &\times \det \left(\text{GF} \left(\mathcal{D}_{-2n-2i-2j-4k}^{(2k+2m-1)}; w_{BAV} \right) \right)_{0 \leq i, j \leq m-1}. \end{aligned} \quad (10.11)$$

By (8.16) and (10.7), we know that the generating function

$$\sum_{n \geq 0} \text{GF} \left(\mathcal{D}_{2n}^{(2k+2m-1)}; w_{BAV} \right) x^{2n}$$

has the form $C/Q_{2k+2m}(x)$, where C is some constant and $Q_{2k+2m}(x)$ is the polynomial defined in (8.5). We know that it is a polynomial in x^2 of degree $k+m$. In particular, these considerations imply that the quantities $\text{GF} \left(\mathcal{D}_{2n}^{(2k+2m-1)}; w_{BAV} \right)$ satisfy a linear recurrence with constant coefficients of the form (10.9). Now we argue — and this is not difficult to see — that the polynomials $Q_{2N}(\sqrt{x})$, $N = 0, 1, \dots$ (these are polynomials in x of degree N) are *generic* polynomials, by which we mean that any polynomial of degree N is equal to $Q_{2N}(\sqrt{x})$ with an appropriate choice of the A_i 's and V_i 's. However, then (10.11) describes a reciprocity relation for general sequences $(c(n))_{n \in \mathbb{Z}}$ that satisfy (10.9). It only remains to connect the A_i 's and V_i 's to the constants a_i in the statement of the theorem to see that (10.11) and (10.10) are equivalent. We leave these details to the reader. \square

Finally, we present the weighted generalisations of the reciprocity laws in Theorems 21 and 24, see Theorems 41 and 44 below, together with the relevant facts that are needed in their proofs. Since the arguments for their proofs are completely analogous to previous ones, we leave it to the reader to fill in the details.

Theorem 41. Let n be a non-negative integer and k, m be positive integers, and let $r_0 < r_1 < \dots < r_{k-1}$ and $s_0 < s_1 < \dots < s_{k-1}$ be sequences of positive integers with $1 \leq r_i, s_i \leq k + m$ for all i . Then

$$\begin{aligned}
& \det \left(\text{GF} \left(\mathcal{C}_{2n}^{(2k+2m-1)}(2r_i - 2 \rightarrow 2s_j - 2); w_{BAV} \right) \right)_{0 \leq i, j \leq k-1} \\
&= (-1)^{\sum_{i=0}^{m-1} (r_i + s_i)} \left(\prod_{i=1}^{k+m} A_i^{-n} V_i^{-n} \right) \left(\prod_{j=0}^{k-1} V_{s_j} V_{r_j}^{-1} \prod_{i=r_j}^{s_j-1} A_i^2 V_i^2 \right) \\
&\quad \times \det \left(\text{GF} \left(\mathcal{C}_{-2n}^{(2k+2m-1)}(2\bar{r}_i - 2 \rightarrow 2\bar{s}_j - 2); w_{BAV} \right) \right)_{0 \leq i, j \leq m-1} \\
&= (-1)^{\sum_{i=0}^{m-1} (\bar{r}_i + \bar{s}_i)} \left(\prod_{i=1}^{k+m} A_i^{-n} V_i^{-n} \right) \left(\prod_{j=0}^{m-1} V_{\bar{r}_j} V_{\bar{s}_j}^{-1} \prod_{i=\bar{r}_j}^{\bar{s}_j-1} A_i^{-2} V_i^{-2} \right) \\
&\quad \times \det \left(\text{GF} \left(\mathcal{C}_{-2n}^{(2k+2m-1)}(2\bar{r}_i - 2 \rightarrow 2\bar{s}_j - 2); w_{BAV} \right) \right)_{0 \leq i, j \leq m-1}, \tag{10.12}
\end{aligned}$$

where

$$\begin{aligned}
\{\bar{r}_0, \bar{r}_1, \dots, \bar{r}_{m-1}\} &= \{1, 2, \dots, k + m\} \setminus \{r_0, r_1, \dots, r_{k-1}\}, \\
\{\bar{s}_0, \bar{s}_1, \dots, \bar{s}_{m-1}\} &= \{1, 2, \dots, k + m\} \setminus \{s_0, s_1, \dots, s_{k-1}\},
\end{aligned}$$

and where we assume that $\bar{r}_0 < \bar{r}_1 < \dots < \bar{r}_{m-1}$ and $\bar{s}_0 < \bar{s}_1 < \dots < \bar{s}_{m-1}$. As earlier, the products have to be interpreted according to (9.4).

Lemma 42. Let n be a non-negative integer and k, m be positive integers. Furthermore, let $\mathcal{P} = (P_0, P_1, \dots, P_{k-1})$ be a family of non-intersecting up-down paths of height at most $2k + 2m - 1$ that do not pass below the x -axis, where P_i runs from $(0, 2r_i - 2)$ to $(2n, 2s_i - 2)$, $i = 0, 1, \dots, k - 1$, and \mathcal{A} the rectangular array of integers of the form (7.2) that corresponds to \mathcal{P} under the bijection of Proposition 22. Then

$$\left(\prod_{i=1}^{k+m} A_i^n V_i^{n+1} \right) \left(\prod_{j=0}^{k-1} V_{s_j}^{-1} \prod_{i=r_j}^{s_j-1} A_i^{-1} V_i^{-1} \right) w_{BAV}(\mathcal{P}) = w_{AV}(\mathcal{A}). \tag{10.13}$$

Given an up-down path P from height $2r - 2$ to height $2s - 2$, the weighted analogue of (10.5) that is relevant here is

$$w_{BAV}(P) = \left(\prod_{i=r+1}^s A_{i-1} V_i \right) \bar{w}_{BAV}(P), \tag{10.14}$$

where, again, the product has to be understood as explained in (9.4).

Theorem 43. Let n be a non-negative integer and k, m be positive integers, and let $r_0 < r_1 < \dots < r_{k-1}$ and $s_0 < s_1 < \dots < s_{k-1}$ be sequences of positive integers with $1 \leq r_i, s_i \leq k + m$ for all i . The generating function $\sum_{\mathcal{A}} w_{AV}(\mathcal{A})$, where the sum is over all rectangular arrays of integers of the form (7.2) that satisfy the constraints given in the statement of Proposition 22 is equal to

$$\begin{aligned} & (-1)^{\sum_{i=0}^{m-1} (\bar{r}_i + \bar{s}_i)} \left(\prod_{j=0}^{m-1} V_{\bar{r}_j} \prod_{i=\bar{r}_j}^{\bar{s}_j-1} A_i^{-1} V_i^{-1} \right) \\ & \times \det \left(\text{GF} \left(\mathcal{C}_{-2n}^{(2k+2m-1)}(2\bar{r}_i - 2 \rightarrow 2\bar{s}_j - 2); w_{BAV} \right) \right)_{0 \leq i, j \leq m-1}. \end{aligned} \quad (10.15)$$

Theorem 44. Let n, k, m be positive integers, and let $r_0 < r_1 < \dots < r_{k-1}$ and $s_0 < s_1 < \dots < s_{k-1}$ be sequences of positive integers with $1 \leq r_i, s_i \leq k + m$ for all i . Then

$$\begin{aligned} & \det \left(\text{GF} \left(\mathcal{C}_{2n-1}^{(2k+2m-1)}(2r_i - 2 \rightarrow 2s_j - 1); w_{BAV} \right) \right)_{0 \leq i, j \leq k-1} \\ & = (-1)^{\sum_{i=0}^{m-1} (r_i + s_i)} \left(\prod_{i=1}^{k+m} A_i^{-n} V_i^{-n} \right) \left(\prod_{j=0}^{k-1} A_{r_j}^2 V_{r_j} A_{s_j}^{-1} \prod_{i=r_j+1}^{s_j} A_i^2 V_i^2 \right) \\ & \quad \times \det \left(\text{GF} \left(\mathcal{C}_{-2n+1}^{(2k+2m-1)}(2\bar{r}_i - 2 \rightarrow 2\bar{s}_j - 1); w_{BAV} \right) \right)_{0 \leq i, j \leq m-1} \\ & = (-1)^{\sum_{i=0}^{m-1} (\bar{r}_i + \bar{s}_i)} \left(\prod_{i=1}^{k+m} A_i^{-n+1} V_i^{-n+1} \right) \left(\prod_{j=0}^{m-1} A_{\bar{r}_j}^{-2} V_{\bar{r}_j}^{-1} A_{\bar{s}_j} \prod_{i=\bar{r}_j+1}^{\bar{s}_j} A_i^{-2} V_i^{-2} \right) \\ & \quad \times \det \left(\text{GF} \left(\mathcal{C}_{-2n+1}^{(2k+2m-1)}(2\bar{r}_i - 2 \rightarrow 2\bar{s}_j - 1); w_{BAV} \right) \right)_{0 \leq i, j \leq m-1}, \end{aligned} \quad (10.16)$$

where

$$\begin{aligned} \{\bar{r}_0, \bar{r}_1, \dots, \bar{r}_{m-1}\} &= \{1, 2, \dots, k + m\} \setminus \{r_0, r_1, \dots, r_{k-1}\}, \\ \{\bar{s}_0, \bar{s}_1, \dots, \bar{s}_{m-1}\} &= \{1, 2, \dots, k + m\} \setminus \{s_0, s_1, \dots, s_{k-1}\}, \end{aligned}$$

and where we assume that $\bar{r}_0 < \bar{r}_1 < \dots < \bar{r}_{m-1}$ and $\bar{s}_0 < \bar{s}_1 < \dots < \bar{s}_{m-1}$. Once more, the products have to be interpreted according to (9.4).

Lemma 45. Let n, k, m be positive integers. Furthermore, let $\mathcal{P} = (P_0, P_1, \dots, P_{k-1})$ be a family of non-intersecting up-down paths of height at most $2k + 2m - 1$ that do not pass below the x -axis, where P_i runs from $(0, 2r_i - 2)$ to $(2n - 1, 2s_i - 1)$, $i = 0, 1, \dots, k - 1$, and \mathcal{A} the rectangular array of integers of the form (7.6) that corresponds to \mathcal{P} under the bijection of Proposition 25. Then

$$\left(\prod_{i=1}^{k+m} A_i^n V_i^n \right) \left(\prod_{j=0}^{k-1} \prod_{i=r_j}^{s_j} A_i^{-1} V_i^{-1} \right) w_{BAV}(\mathcal{P}) = w_{AV}(\mathcal{A}). \quad (10.17)$$

Given an up-down path P from height $2r-2$ to height $2s-1$, the weighted generalisation of (10.5) that is relevant here is

$$w_{BAV}(P) = \left(A_r \prod_{i=r+1}^s A_i V_i \right) \bar{w}_{BAV}(P), \quad (10.18)$$

where, again, the product has to be understood as explained in (9.4).

Theorem 46. *Let n, k, m be positive integers, and let $r_0 < r_1 < \dots < r_{k-1}$ and $s_0 < s_1 < \dots < s_{k-1}$ be sequences of positive integers with $1 \leq r_i, s_i \leq k+m$ for all i . The generating function $\sum_{\mathcal{A}} w_{AV}(\mathcal{A})$, where the sum is over all rectangular arrays of integers of the form (7.6) that satisfy the constraints given in the statement of Proposition 25 is equal to*

$$\begin{aligned} & (-1)^{\sum_{i=0}^{m-1} (\bar{r}_i + \bar{s}_i)} \left(\prod_{j=0}^{m-1} \prod_{i=\bar{r}_j+1}^{\bar{s}_j} A_{i-1}^{-1} V_i^{-1} \right) \\ & \times \det \left(\text{GF} \left(\mathcal{C}_{-2n+1}^{(2k+2m-1)}(2\bar{r}_i - 2 \rightarrow 2\bar{s}_j - 1); w_{BAV} \right) \right)_{0 \leq i, j \leq m-1}. \end{aligned} \quad (10.19)$$

11. Enumeration of alternating tableaux. The key for proving our reciprocity laws in Sections 5–7 and 10 has been the observation from Sections 4 and 9 that numbers (respectively generating functions) of bounded up-down paths “of negative length” are combinatorially modelled by numbers (respectively generating functions) of bounded alternating sequences and to prove enumeration results for certain arrays of alternating sequences, see Theorems 17, 20, 23, 26, 36, 39, 43, and 46. In the present section, we present two more general theorems, of which the above theorems turn out to be special cases.

To begin with, we now officially define *alternating tableaux*. Given m -tuples $\boldsymbol{\lambda} = (\lambda_1, \lambda_2, \dots, \lambda_m)$ and $\boldsymbol{\mu} = (\mu_1, \mu_2, \dots, \mu_m)$, where all elements of $\boldsymbol{\mu}$ are even and $\mu_i \leq \lambda_i$ for all i , we call an array of integers of the form

$$\begin{array}{ccccccc} & & & & a_{1, \mu_1+1} & \dots & a_{1, \lambda_1} \\ & & & & a_{2, \mu_2+1} & \dots & a_{2, \lambda_2} \\ & & & & \vdots & & \vdots \\ \dots & & & & \vdots & & \vdots \\ a_{m, \mu_m+1} & \dots & & & \dots & & a_{m, \lambda_m} \end{array} \quad (11.1)$$

an *alternating tableau of shape $\boldsymbol{\lambda}/\boldsymbol{\mu}$* if the entries along each row are alternating in the sense that

$$a_{i, 2j-1} \leq a_{i, 2j} \quad \text{and} \quad a_{i, 2j} \geq a_{i, 2j+1}, \quad (11.2)$$

for all i and j , and if

$$a_{i+1, 2j} < a_{i, 2j+1} > a_{i+1, 2j+2} \quad (11.3)$$

for all i and j , whenever the respective entries are defined. Examples of such arrays can be found in (5.7), (6.6), and (7.3). As earlier, we define the *weight* w_{AV} of such an array \mathcal{A} by $w_{AV}(\mathcal{A}) = \prod_{i,j} A_{a_{i,2j}} V_{a_{i,2j-1}}$. Then we have the following generating function results.

Theorem 47. *Let k be a positive integer or $k = \infty$, and let m be a positive integer. Furthermore, let $\lambda = (\lambda_1, \lambda_2, \dots, \lambda_m)$ and $\mu = (\mu_1, \mu_2, \dots, \mu_m)$ be sequences of integers with $\mu_i \leq \lambda_i$ for all i , where μ is decreasing and all μ_i 's are even.*

If λ is increasing and all λ_i 's are odd, then the generating function $\sum_{\mathcal{A}} w_{AV}(\mathcal{A})$, where the sum is over all alternating tableaux of shape λ/μ whose entries are at least 1 and at most k , is equal to

$$\det \left(\text{GF} \left(\mathcal{A}_{\lambda_j - \mu_i}^{(k)}; w_{AV} \right) \right)_{1 \leq i, j \leq m}. \quad (11.4)$$

If λ is decreasing and all λ_i 's are even, then the generating function $\sum_{\mathcal{A}} w_{AV}(\mathcal{A})$, where the sum is over all alternating tableaux of shape λ/μ whose entries are between 1 and k , is also given by (11.4).

REMARKS. (1) If $k = \infty$, then the generating functions $\sum_{\mathcal{A}} w_{AV}(\mathcal{A})$ and $\text{GF}(\mathcal{A}_{\lambda_j - \mu_i}^{(\infty)}; w_{AV})$ are not polynomials anymore, but instead formal power series in the A_i 's and V_i 's. If $A_i = V_i$ for all i , then it is known that $\text{GF}(\mathcal{A}_s^{(\infty)}; w_{AV})$ is a quasi-symmetric function (cf. [34, paragraph containing Eq. (7.92)], where the underlying poset P is the zigzag poset Z_s from [35, Ex. 3.66]). If we leave the variables A_i and V_i unrelated, then the functions $\text{GF}(\mathcal{A}_s^{(\infty)}; w_{AV})$ may stand at the beginning of a theory of quasi-symmetric functions in two sets of variables that would have to be developed.

(2) The special case of this theorem where $\lambda_i = 2n + 2m + 2i - 5$ and $\mu_i = 2m - 2i$, $i = 1, 2, \dots, m$, and k is replaced by $k + m$ is at the heart of the proofs of Theorems 17 and 36, while the special where $\lambda_i = 2n + 2m - 2i$ and $\mu_i = 2m - 2i$, $i = 1, 2, \dots, m$, and k is replaced by $k + m$ is at the heart of the proofs of Theorems 20 and 39.

SKETCH OF PROOF OF THEOREM 47. The theorem can be proved in the same way as Theorem 17. Here, in the first case the alternating tableaux under consideration are in bijection with families (P_1, P_2, \dots, P_m) of non-intersecting lattice paths in the directed graph \mathcal{G}_k , where P_i runs from (μ_i, k) to (λ_i, k) , $i = 1, 2, \dots, m$. In the second case, the alternating tableaux under consideration are in bijection with families (P_1, P_2, \dots, P_m) of non-intersecting lattice paths in the directed graph \mathcal{G}_k , where P_i runs from (μ_i, k) to $(\lambda_i, 0)$, $i = 1, 2, \dots, m$. We leave it to the reader to fill in the details. \square

The finer ‘‘flagged’’ version of Theorem 47 is the following.

Theorem 48. *Let k be a positive integer or $k = \infty$, let m be a positive integer, and let $\lambda = (\lambda_1, \lambda_2, \dots, \lambda_m)$ and $\mu = (\mu_1, \mu_2, \dots, \mu_m)$ be sequences of integers with $\mu_i \leq \lambda_i$ for all i , where μ is non-increasing and all μ_i 's are even. Furthermore, let $r_1 > r_2 > \dots > r_m$ and $s_1 > s_2 > \dots > s_m$ be sequences of positive integers with $1 \leq r_i, s_i \leq k$ for all i .*

If λ is non-decreasing and all λ_i 's are odd, then the generating function $\sum_{\mathcal{A}} w_{AV}(\mathcal{A})$, where the sum is over all alternating tableaux of shape λ/μ whose entries are between 1 and k , and in which the first entry in row i is r_i and the last entry is s_i , is equal to

$$\det \left(\text{GF} \left(\mathcal{A}_{\lambda_j - \mu_i}^{(k)}(r_i \rightarrow s_j); w_{AV} \right) \right)_{1 \leq i, j \leq m}. \quad (11.5)$$

If λ is non-increasing and all λ_i 's are even, then the generating function $\sum_{\mathcal{A}} w_{AV}(\mathcal{A})$, where the sum is over all alternating tableaux of shape λ/μ whose entries are between 1

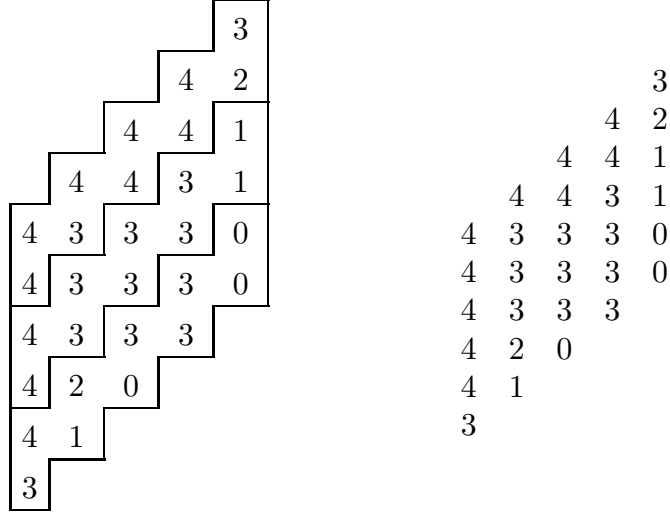

From an alternating tableau of rhomboidal shape to a plane partition

Figure 14

shape $(2n + 2m - 3, 2n + 2m - 1, \dots, 2n + 4m - 5)/(2m - 2, 2m - 4, \dots, 0)$ with entries at least 1 and at most $k + m$ (see Proposition 16) and plane partitions of shape $(n + 2m - 2, n + 2m - 3, \dots, 1)/(n - 2, n - 3, \dots, 1, 0, \dots, 0)$ with entries at least 0 and at most k . (Here, the inner shape has $2m$ occurrences of 0.) Likewise — referring to the alternating tableaux in Proposition 19 —, this mapping sets up a bijection between alternating tableaux of shape $(2n + 2m - 2, 2n + 2m - 4, \dots, 2n)/(2m - 2, 2m - 4, \dots, 0)$ with entries at least 1 and at most $k + m$ and plane partitions of shape $(n, \dots, n, n - 1, \dots, 1)/(n - 1, n - 2, \dots, 1, 0, \dots, 0)$ with entries at least 0 and at most k . Here, the outer shape has $2m$ occurrences of n , and the inner shape has $2m$ occurrences of 0.

Using the known determinant formula [18, Theorem 6.1] for the number of plane partitions of a given shape and subject to separate bounds on the entries in each row with $x = 1$, $\alpha = \beta = 0$, $r = n + 2m - 2$, $\lambda = (n + 2m - 2, n + 2m - 3, \dots, 1)$, $\mu = (n - 2, n - 3, \dots, 1, 0, \dots, 0)$, $a_i = k$ and $b_i = 0$ for all i , we get the following alternative determinantal formula for the determinants in Theorems 15 and 17.

Proposition 49. *The determinants in (5.1) and (5.8) are equal to*

$$\det \left(\binom{n + 2m - 1 - i - \max\{0, n - 1 - j\} + k}{k + i - j} \right)_{1 \leq i, j \leq n + 2m - 2}.$$

Here, the binomial coefficient has to be interpreted as 0 if its upper or lower parameter is negative.

Likewise, using [18, Theorem 6.1] with $x = 1$, $\alpha = \beta = 0$, $r = n + 2m - 1$, $\lambda = (n, \dots, n, n - 1, \dots, 1)$ (with $2m$ occurrences of n), $\mu = (n - 1, n - 2, \dots, 1, 0, \dots, 0)$ (with $2m$ occurrences of 0), $a_i = k$ and $b_i = 0$ for all i , we get the following alternative determinantal formula for the determinants in Theorems 18 and 20.

Proposition 50. *The determinants in (6.1) and (6.7) are equal to*

$$\det \left(\binom{\min\{n, n+2m-i\} - \max\{0, n-j\} + k}{k+i-j} \right)_{1 \leq i, j \leq n+2m-1}.$$

Again, the binomial coefficient has to be interpreted as 0 if its upper or lower parameter is negative.

The “strip shapes” of the plane partitions that we obtain here (see Figures 13 and 14) have been considered in [2] and in [17], however not for plane partitions, but rather for standard Young tableaux, respectively for semistandard tableaux. More precisely, in the terminology of [2] our shapes are $2m$ -strip shapes, the *width* $2m$ referring to the maximal length of the columns in the “body” of the shape. In this sense, Figures 13 and 14 contain 6-strip shapes.

A comparison with the considerations in [25, 14] reveals that our formulae in Theorems 47 and 48 have the flavour of the ribbon determinant formulae of Lascoux and Pragacz [25] and their generalisation by Hamel and Goulden [14]. However, our weight w_{AV} is incompatible with the monomial weight assigned to semistandard tableaux in order to obtain Schur functions. Hence, while our results overlap with those of [25, 14] in the case of plain counting (that is, if all weights are equal to 1), they do not follow from those of [25, 14], nor do our results imply those of [25, 14].

12. Some comments, and questions. In this concluding section, we discuss some points of interest and questions that are posed by the results (and non-results) in the present article.

(1) It will not have escaped the attention of the reader that, although Theorems 1 and 27 hold for odd *and* even upper bounds k for the up-down paths under consideration, all our reciprocity results require this upper bound to be *odd*. The obvious question therefore is:

What happens for even upper bounds?

The short answer is: there is no reciprocity law in that case.

A more elaborate answer is three-fold: first, it is a simple matter of fact that, in a straightforward manner, the sequence $(C_n^{(2k)})_{n \geq 0}$ cannot be extended to negative indices n since it already does not satisfy its linear recurrence with constant coefficients *in the beginning*. What we mean by this is best illustrated with the special case $k = 1$: here we have

$$(C_n^{(2)})_{n \geq 0} = (1, 0, 1, 0, 2, 0, 4, 0, 8, \dots).$$

Clearly, it satisfies the linear recurrence $C_{n+2}^{(2)} = 2C_n^{(2)}$ for $n \geq 1$, but not for $n = 0$. The technical explanation for this phenomenon is hidden in the generating function for these numbers, given in (2.3). Namely, recalling that $C_n^{(2k)} = C_n^{(2k)}(0 \rightarrow 0)$, we have

$$\sum_{n \geq 0} C_n^{(2k)} x^n = \frac{U_{2k}(1/2x)}{x U_{2k+1}(1/2x)}.$$

The degree of $U_m(x)$ is equal to m , but at the same time it is an even polynomial for even m and an odd polynomial for odd m . Thus, if we rewrite the above right-hand side as a reduced rational fraction, then we see that numerator degree and denominator degree are the same. The implication is that the constant term in the series expansion is “special” in that it does not fit into the linear recurrence the coefficients $C_n^{(2k)}$ satisfy otherwise.

We could remedy this by “correcting” $C_0^{(2k)}$ to $\frac{k}{k+1}$. Then the linear recurrence is satisfied from the very beginning, and thus the sequence can be extended to negative indices. The drawback here is that this extension to negative indices does not produce integers. For example, for $k = 1$ we would obtain $C_{-2n}^{(2)} = 2^{-n-1}$, or for $k = 2$ we would obtain $C_{-2n}^{(4)} = \frac{1}{2}(1 + 3^{-n-1})$. In particular, we cannot expect *combinatorial* reciprocity laws in this setting.

The second part of the more elaborate answer to the above question mentions that, at least, there is an even analogue of the identity (1.1) (the $m = 1$ case of Theorem 15), even if it is not a reciprocity law. Namely, for $n \geq 1$ we have

$$\det \left(C_{2n+2i+2j}^{(2k)} \right)_{0 \leq i, j \leq k-1} = (k+1)^{n-1}. \quad (12.1)$$

Indeed, this cannot be interpreted as a reciprocity law (in whatever sense) since the sequence $(C_n^{(2k)})_{n \geq 0}$ satisfies a linear recurrence that is fundamentally different from the (obvious) one that the right-hand side of (12.1) satisfies.

Why does (12.1) hold? This is (again) best explained by a picture. As before, the determinant on the left-hand side of (12.1) equals the number of families of non-intersecting up-down paths in a strip, here families $(P_0, P_1, \dots, P_{k-1})$ of non-intersecting Dyck paths of height at most $2k$, where P_i runs from $(-2i, 0)$ to $(2n+2i, 0)$, $i = 0, 1, \dots, k-1$. Figure 15 provides an example for $k = 4$ and $n = 8$. It illustrates a bijection between these families of non-intersecting Dyck paths and sequences $(a_1, a_2, \dots, a_{n-1})$ with $1 \leq a_i \leq k+1$ for all i , by reading the heights of the “even” lattice points that are not occupied by any of the paths, and finally dividing these heights by 2 and adding 1 to the result. In the figure, these non-occupied points are indicated by circles, and the value that is assigned to them according to the above recipe is put as a label. Thus, for our example in Figure 15 we obtain the sequence $(4, 2, 1, 5, 2, 3, 1)$. It should be emphasised that here, because of the “tighter” upper bound on the paths, there are non-occupied points only above even abscissa, and hence the elements a_i of these sequences are independent of each other. In particular, there is no condition of being alternating in this context.

This bijection immediately proves (12.1), and more generally

$$\begin{aligned} & \det \left(\text{GF} \left(C_{2n+2i+2j}^{(2k)}; w_B \right) \right)_{0 \leq i, j \leq k-1} \\ &= \prod_{i=1}^{2k} B_i^{k - \lfloor i/2 \rfloor} \left(B_1 B_3 \cdots B_{2k-1} + B_1 B_3 \cdots B_{2k-3} B_{2k} \right. \\ & \quad \left. + B_1 B_3 \cdots B_{2k-5} B_{2k-2} B_{2k} + \cdots + B_2 B_4 \cdots B_{2k} \right)^{n-1}. \end{aligned} \quad (12.2)$$

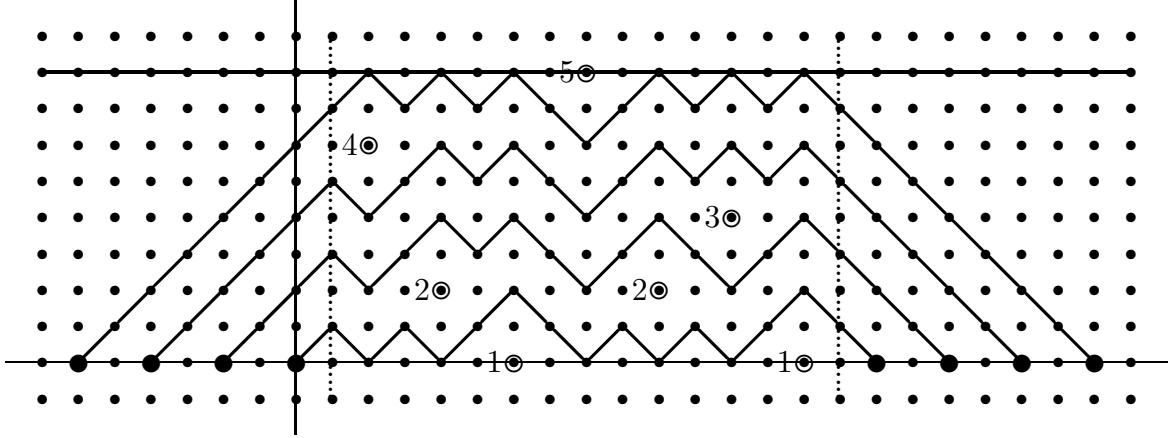

Another family of non-intersecting bounded Dyck paths

Figure 15

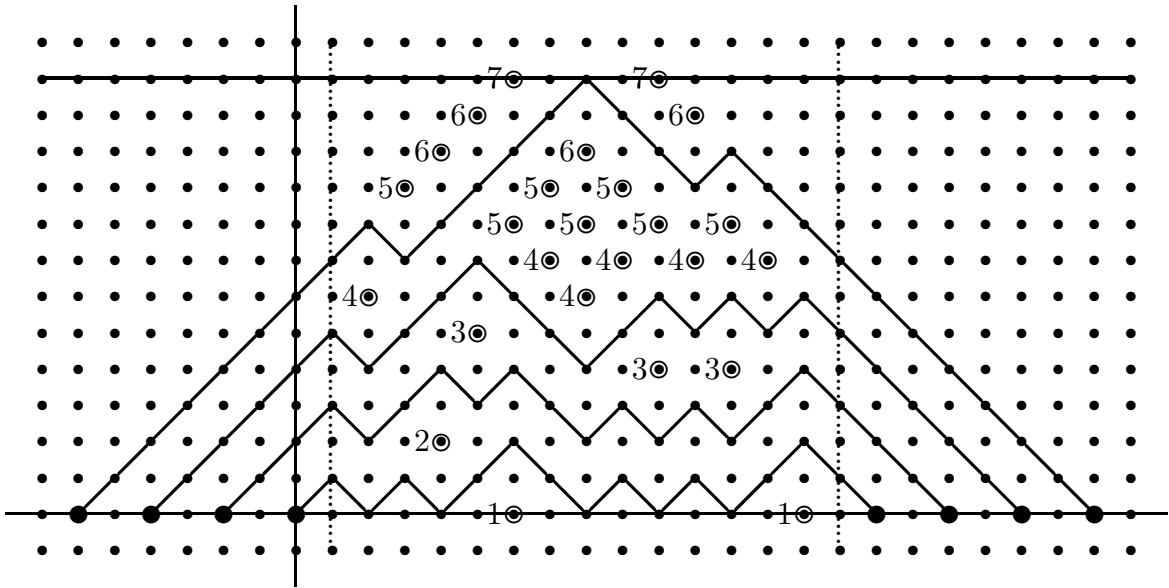

Yet another family of non-intersecting bounded Dyck paths

Figure 16

Third, we should address the question of what happens if the bound on the paths is lifted. Phrased differently, if we consider the determinants

$$\det \left(C_{2n+2i+2j+4m}^{(2k+2m)} \right)_{0 \leq i, j \leq k-1},$$

what replaces the right-hand side of (5.1) in this “even case”? We may follow the line of argument in Section 5 of interpreting the determinant in terms of families of non-intersecting bounded Dyck paths and then mapping them to alternating tableaux (see Proposition 16). Figure 16 shows an example of a family of Dyck paths for $k = 4$, $m = 2$, and $n = 4$. The array of integers that one obtains using the idea of the proof of

There are closed-form evaluations for the “even cases” of the determinants on the left-hand side of (12.3) if the up-down paths are restricted to “very tight” strips.

Theorem 52. *Let n be a non-negative integer and k be a positive integer. Then we have*

$$\det \left(\sum_{s=0}^{4k} C_{n+i+j+1}^{(4k)}(0 \rightarrow s) \right)_{0 \leq i, j \leq 2k-1} = (-1)^{k(n-1)} (2k+1)^n \quad (12.4)$$

and

$$\det \left(\sum_{s=0}^{4k-2} C_{n+i+j}^{(4k-2)}(0 \rightarrow s) \right)_{0 \leq i, j \leq 2k-1} = (-1)^{kn} 2^n. \quad (12.5)$$

PROOF. We start with (12.4). Write $a(n, k)$ for $\sum_{s=0}^k C_n^{(k)}(0 \rightarrow s)$. We claim that we have

$$\sum_{n \geq 0} a(n, k) x^n = \frac{U_{\lfloor k/2 \rfloor}(1/2x) (U_{\lfloor (k+1)/2 \rfloor}(1/2x) + U_{\lfloor (k-1)/2 \rfloor}(1/2x))}{x U_{k+1}(1/2x)}. \quad (12.6)$$

The claim can be easily verified by using (2.3) and the substitution trick explained in the proof of Corollary 11. Alternatively, one may consult [6, Eq. (1.27)].

Now let $A_k(n)$ be the matrix $(a(n+i+j, 4k))_{0 \leq i, j \leq 2k-1}$. Then we claim that

$$A_k(n+1) = A_k(n) \begin{pmatrix} 0 & 0 & \dots & -\alpha_{2k} \\ 1 & 0 & \dots & -\alpha_{2k-1} \\ 0 & 1 & \dots & -\alpha_{2k-2} \\ \vdots & \vdots & \ddots & \\ 0 & 0 & \dots & 0 & -\alpha_2 \\ 0 & 0 & \dots & 1 & -\alpha_1 \end{pmatrix}, \quad \text{for } n \geq 1, \quad (12.7)$$

where

$$\sum_{i=0}^{2k} \alpha_i x^i = \frac{x^{2k+1} U_{4k+1}(1/2x)}{U_{2k}(1/2x)} = 2x^{2k+1} T_{2k+1}(1/2x). \quad (12.8)$$

Here, $T_n(x)$ denotes the n -th Chebyshev polynomial of the first kind, given by

$$T_n(\cos \theta) = \cos(n\theta),$$

$$T_n(x) = \sum_{j \geq 0} (-1)^j \frac{n}{2(n-j)} \binom{n-j}{j} (2x)^{n-2j}. \quad (12.9)$$

The equality in (12.8) can again be checked using the aforementioned substitution trick. It should be noted that the last expression in (12.8) is visibly a polynomial of degree $2k$

with constant term 1. By multiplication of the right-hand sides of (12.6) with k replaced by $4k$ and of (12.8), we obtain

$$\sum_{n \geq 0} x^n \sum_{i=0}^{2k} \alpha_i a(n-i, 4k) = 2x^{2k} (U_{2k}(1/2x) + U_{2k-1}(1/2x)).$$

The right-hand side is a polynomial of degree $2k$. Hence,

$$\sum_{i=0}^{2k} \alpha_i a(n-i, 4k) = 0, \quad \text{for } n > 2k,$$

or, equivalently,

$$a(n, 4k) = - \sum_{i=1}^{2k} \alpha_i a(n-i, 4k), \quad \text{for } n > 2k.$$

This establishes the claim in (12.7).

Taking determinants on both sides of (12.7), we arrive at the recurrence

$$\det A_k(n+1) = \alpha_{2k} \det A_k(n), \quad \text{for } n \geq 1.$$

By the explicit form (12.9) of the Chebyshev polynomials of the first kind and (12.8), we see that $\alpha_{2k} = (-1)^k (2k+1)$.

We have everything built up for an inductive proof of (12.4), except for the start of the induction, the evaluation of $\det A_k(1)$. The (i, j) -entry of $A_k(1)$ is $a(1+i+j, 4k)$, $0 \leq i, j \leq 2k-1$, the number of up-down paths starting at $(0, 0)$ not passing below the x -axis and not passing above height $4k$. However, the paths take at most $1 + (2k-1) + (2k-1) = 4k-1$ steps so that the upper restriction is without relevance. The number of up-down paths taking n steps starting at $(0, 0)$ and never passing below the x -axis is well known to be $\binom{n}{\lfloor n/2 \rfloor}$. Therefore we have

$$\det A_k(1) = \det \left(\binom{i+j+1}{\lfloor (i+j+1)/2 \rfloor} \right) = (-1)^k,$$

where the last equality follows for instance from [24, Eq. (6.3)]. This completes the proof of (12.4).

Equation (12.5) can be proved in a similar manner. Let $B_k(n)$ be the matrix $(a(n+i+j, 4k-2))_{0 \leq i, j \leq 2k-1}$. Then we claim that

$$B_k(n+1) = B_k(n) \begin{pmatrix} 0 & 0 & \dots & -\beta_{2k} \\ 1 & 0 & \dots & -\beta_{2k-1} \\ 0 & 1 & \dots & -\beta_{2k-2} \\ \vdots & \vdots & \ddots & \\ 0 & 0 & \dots & 0 & -\beta_2 \\ 0 & 0 & \dots & 1 & -\beta_1 \end{pmatrix}, \quad \text{for } n \geq 1, \quad (12.10)$$

where

$$\sum_{i=0}^{2k} \beta_i x^i = \frac{x^{2k} U_{4k-1}(1/2x)}{U_{2k-1}(1/2x)} = 2x^{2k} T_{2k}(1/2x). \quad (12.11)$$

Here we obtain

$$\sum_{n \geq 0} x^n \sum_{i=0}^{2k} \beta_i a(n-i, 4k-2) = 2x^{2k-1} (U_{2k-1}(1/2x) + U_{2k-2}(1/2x)),$$

and consequently

$$a(n, 4k-2) = - \sum_{i=1}^{2k} \beta_i a(n-i, 4k-2), \quad \text{for } n \geq 2k.$$

This establishes the claim in (12.10).

Taking determinants on both sides of (12.10), we arrive at the recurrence

$$\det B_k(n+1) = \beta_{2k} \det B_k(n), \quad \text{for } n \geq 0.$$

By the explicit form (12.9) of the Chebyshev polynomials of the first kind and (12.11), we see that $\beta_{2k} = 2(-1)^k$.

Finally, we have to evaluate the determinant of

$$B_k(0) = (a(i+j, 4k-2))_{0 \leq i, j \leq 2k-1} = \left(\binom{i+j}{\lfloor (i+j)/2 \rfloor} \right)_{0 \leq i, j \leq 2k-1}.$$

This determinant turns out to equal 1 (cf. e.g. [24, Eq. (6.2)]). This completes the proof of (12.4) and, thus, of the theorem. \square

We refer the reader to Corollary 64 for the extension of Theorem 52 to negative integers.

The next two theorems present four further Hankel determinant evaluations of matrices where the entries are ‘‘cumulative’’ generating functions, respectively numbers, of bounded up-down paths.

Theorem 53. *For non-negative integers n and k , let*

$$s(n, k, x) = \sum_{\ell=0}^{\lfloor n/2 \rfloor} x^{n-2\ell} C_{2\ell}^{(k)}.$$

Then we have

$$\det (s(2n+2i+2j, 2k, x))_{0 \leq i, j \leq k} = (-1)^k x^{2n} (k+1)^n U_{2k}(x/2) \quad (12.12)$$

and

$$\det (s(n+i+j, 2k, x))_{0 \leq i, j \leq 2k} (-1)^{k(n+1)} x^n (k+1)^n U_{2k}(x/2). \quad (12.13)$$

SKETCH OF PROOF. In the determinant in (12.12), we subtract x^2 times the $(i - 1)$ -st row from the i -th row, $i = k, k - 1, \dots, 2$, in this order. As a result, we obtain the determinant

$$\det \begin{pmatrix} \sum_{\ell=0}^{2n+2j} x^{2n+2j-2\ell} C_{2\ell}^{(2k)}, & i = 0 \\ C_{2n+2i+2j}^{(2k)}, & i \geq 1 \end{pmatrix}_{0 \leq i, j \leq k} = \det \begin{pmatrix} \sum_{\ell=0}^{2n+2j} x^{2\ell} C_{2n+2j-2\ell}^{(2k)}, & i = 0 \\ C_{2n+2i+2j}^{(2k)}, & i \geq 1 \end{pmatrix}_{0 \leq i, j \leq k}. \quad (12.14)$$

If we use linearity of the determinant in the first row, then we get

$$\sum_{\ell=0}^{2n+2k} x^{2\ell} \det \begin{pmatrix} C_{2n+2j-2\ell}^{(2k)}, & i = 0 \\ C_{2n+2i+2j}^{(2k)}, & i \geq 1 \end{pmatrix}_{0 \leq i, j \leq k-1}.$$

By the Lindström–Gessel–Viennot theorem [26, Lemma 1], the last determinant enumerates families (P_0, P_1, \dots, P_k) of non-intersecting up-down paths which stay between the lines $y = 0$ and $y = 2k$, where P_0 runs from $(2\ell, 0)$ to $(2n + 2\sigma(0), 0)$, while for $i \geq 1$ the path P_i runs from $(-2i, 0)$ to $(2n + 2\sigma(i), 0)$, for a suitable permutation σ of $\{0, 1, \dots, k - 1\}$.

In order to have an example at our disposal, see Figure 18, which is an example for $k = 4$, $n = 5$, $\ell = 6$, $\sigma(0) = 1$, $\sigma(1) = 0$, $\sigma(2) = 2$, $\sigma(3) = 3$, and $\sigma(4) = 4$.

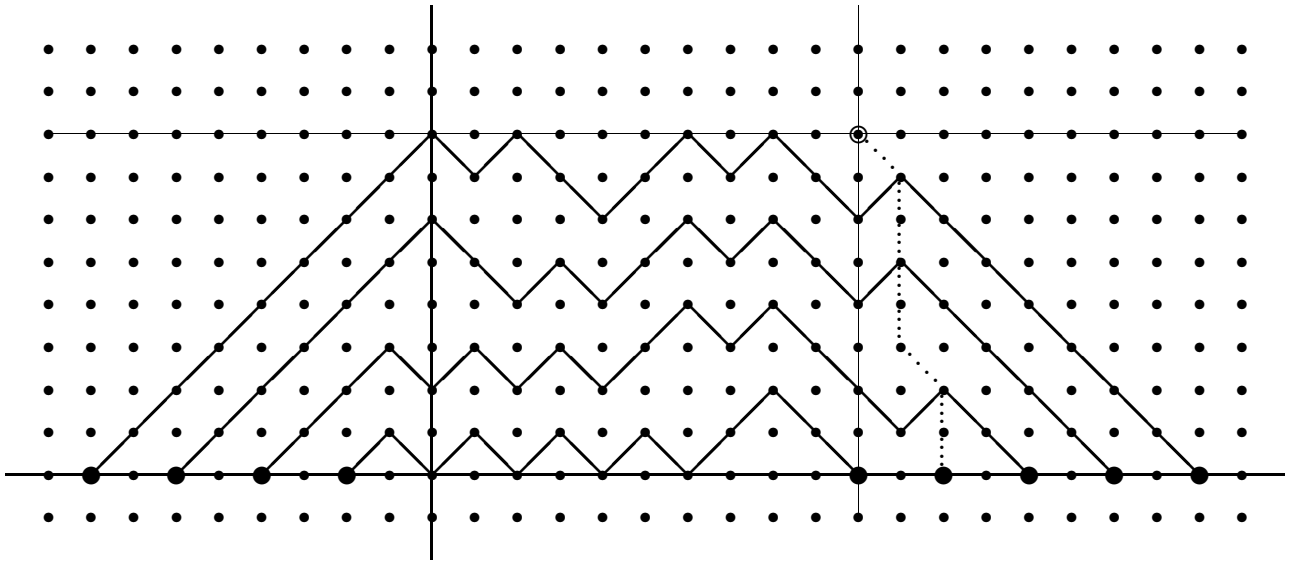

Figure 18

The path P_0 starts at $(2\ell, 0)$. If we ignore P_0 for the moment, then we see that the other paths (in the example: P_1, P_2, P_3, P_4) are uniquely determined at the beginning (to be precise: until the abscissa $x = -1$) and then “fill everything” between $x = -1$ and

$x = 2n - 1$ so that there remains no space for P_0 . Hence, we must have $\ell \geq n$ in order to have a non-empty family of non-intersecting up-down paths.

If $\ell \geq n$, then the point $(2\ell, 0)$ is not only the starting point of P_0 , but at the same time also the ending point of some path. In order to have a family of non-intersecting up-down paths, the path P_0 must be a path of length 0, which starts and ends in $(2\ell, 0)$.

In order to see how many possibilities there remain for the other paths to the right of the abscissa $x = 2n - 1$, we use Viennot's idea of a „dual“ path. Starting from the given family of non-intersecting paths, we construct a path from $(2\ell, 0)$ to $(2n, 2k)$ that consists entirely of vertical steps $(0, 2)$ and diagonal steps $(-1, 1)$. We start the path in $(2\ell, 0)$. The rule is the following: usually we proceed by diagonal steps $(-1, 1)$, except if in this way we would hit one of the paths of the family; if the latter would be the case then, instead, we proceed by a vertical step $(0, 2)$. In our example in Figure 18, the dual path is indicated as dotted path. It is indeed not difficult to see that the correspondence between path portions to the right of $x = 2n - 1$ and the just constructed dual path is a bijection.

Now everything is in place: there are $\binom{2\ell - 2n + k - \ell + n}{2\ell - 2n} = \binom{\ell - n + k}{k - \ell + n}$ such dual paths. If, in addition, we replace ℓ by $n + k - \ell$, then the binomial coefficient becomes $\binom{2k - \ell}{\ell}$, which is indeed the corresponding coefficient in the Chebyshev polynomial $U_{2k}(x/2)$. The factor x^{2n} arises since we must have $\ell \geq n$, and the sign that goes with the coefficient of the Chebyshev polynomial comes from the sign of the permutation σ . Finally, the factor $(k + 1)^n$ accounts for the number of possibilities the paths P_1, P_2, \dots, P_k have in the region between the abscissa $x = -1$ and $x = 2n - 1$.

For (12.13), we may proceed similarly. Here we subtract x (!) times the $(i - 1)$ -st row from the i -th row, $i = 2k, 2k - 1, \dots, 2$, in this order. However, since we have

$$xs(2m, 2k, x) = s(2m + 1, 2k, x),$$

after these row operations we obtain a matrix in which zeroes appear in a checkerboard pattern. Consequently, the determinant decomposes into a product of two determinants of approximately half the size. For the exact computation, one has to distinguish between n being even or odd.

If n is even, then the first determinant is

$$\det \begin{pmatrix} \sum_{\ell=0}^{n+2j} x^{2\ell} C_{n+2j-2\ell}^{(2k)}, & i = 0 \\ C_{n+2i+2j}^{(2k)}, & i \geq 1 \end{pmatrix}_{0 \leq i, j \leq k},$$

which is the one in (12.14), which we already evaluated. The second determinant is

$$\det \left(C_{n+2i+2j+2}^{(2k)} \right)_{0 \leq i, j \leq k-1},$$

which can be evaluated by means of (12.1).

If n is odd, then everything is very similar. Here, the first determinant is again the one in (12.14) up to a factor of x , and the second is again covered by (12.1). \square

Theorem 54. *With the notation of Theorem 53, we have*

$$(s(2n + 2i + 2j, 6k + 2, 1))_{0 \leq i, j \leq 3k} = (-1)^k (3k + 2)^n \quad (12.15)$$

and

$$(s(n + i + j, 6k + 2, 1))_{0 \leq i, j \leq 3k} = (-1)^{kn+n+k} (3k + 2)^n. \quad (12.16)$$

SKETCH OF PROOF. These two identities can again be handled by the matrix approach from the proof of Theorem 52. We start with (12.15). Let

$$A_k(n) = (s(2n + 2i + 2j, 6k + 2, 1))_{0 \leq i, j \leq 3k}.$$

We claim that

$$A_k(n+1) = A_k(n) \begin{pmatrix} 0 & 0 & \dots & -\alpha_{3k+1} \\ 1 & 0 & \dots & -\alpha_{3k} \\ 0 & 1 & \dots & -\alpha_{3k-1} \\ \vdots & \vdots & \ddots & \\ 0 & 0 & \dots & 0 & -\alpha_2 \\ 0 & 0 & \dots & 1 & -\alpha_1 \end{pmatrix}, \quad \text{for } n \geq 0,$$

where

$$\sum_{i=0}^{3k+1} \alpha_i x^{2i} = x^{6k+3} U_{6k+3}(1/2x).$$

To prove the claim, we observe that, by Theorem 1, we have

$$\sum_{n \geq 0} s(n, 6k + 2, 1) x^n = \frac{U_{6k+2}(1/2x)}{x(1-x)U_{6k+3}(1/2x)},$$

and consequently

$$\begin{aligned} \sum_{n \geq 0} s(2n, 6k + 2, 1) x^{2n} &= \frac{1}{2} \left(\frac{U_{6k+2}(1/2x)}{x(1-x)U_{6k+3}(1/2x)} - \frac{U_{6k+2}(-1/2x)}{x(1+x)U_{6k+3}(-1/2x)} \right) \\ &= \frac{1}{2} \left(\frac{U_{6k+2}(1/2x)}{x(1-x)U_{6k+3}(1/2x)} + \frac{U_{6k+2}(1/2x)}{x(1+x)U_{6k+3}(1/2x)} \right) \\ &= \frac{U_{6k+2}(1/2x)}{x(1-x^2)U_{6k+3}(1/2x)}. \end{aligned}$$

It follows that

$$\sum_{n \geq 0} x^{2n} \sum_{i=0}^{3k+1} \alpha_i s(2n - 2i, 6k + 2, 1) = \frac{x^{6k+2} U_{6k+2}(1/2x)}{1-x^2}.$$

The numerator on the right-hand side is a polynomial of degree $6k + 2$ that is divisible by $1 - x^2$, as is not difficult to see. Thus, the right-hand side is a polynomial of degree $6k$. In particular, we have

$$\sum_{i=0}^{3k+1} \alpha_i s(2n - 2i, 6k + 2, 1) = 0, \quad \text{for } n > 3k,$$

or, equivalently,

$$s(2n, 6k + 2, 1) = - \sum_{i=1}^{3k+1} \alpha_i s(2n - 2i, 6k + 2, 1), \quad \text{for } n > 3k.$$

This proves the claim.

By induction, we get

$$\det A_k(n) = ((-1)^{3k+1} \alpha_{3k+1})^n \det A_k(0) = (3k + 2)^n \det A_k(0).$$

For the start of the induction, we may use Theorem 53:

$$\begin{aligned} \det A_k(0) &= \det (s(2i + 2j, 6k + 2, 1))_{0 \leq i, j \leq 3k} \\ &= \det (s(2i + 2j, 6k, 1))_{0 \leq i, j \leq 3k} \\ &= (-1)^{3k} U_{6k}(1/2) \\ &= (-1)^k, \end{aligned}$$

since, for the range where we find i and j , it is irrelevant whether the height restriction is $6k + 2$ or $6k$.

For the proof of (12.16), one uses as before row operations to generate a matrix in which the zeroes form a checkerboard pattern. Then, again, the determinant decomposes into a product of two determinants of approximately half the size. One factor is the determinant that we just treated, the other is again covered by (12.1). \square

(3) It was pointed out earlier that the generating function formulae in Theorems 1 and 27 can actually be extended to the ‘‘Motzkin case’’. To make this precise, we define a *three-step path* to be a path consisting of up-steps $(1, 1)$, level steps $(1, 0)$, and down-steps $(1, -1)$. We denote the set of all three-step paths from $(0, r)$ to (n, s) of height at most k that never pass below the x -axis by $\mathcal{M}_n^{(k)}(r \rightarrow s)$. Strictly speaking, *Motzkin paths* are the paths in $\bigcup_{n \geq 0} \mathcal{M}_n^{(\infty)}(0 \rightarrow 0)$, that is, those three-step paths that start and end on the x -axis, and never pass below the x -axis.

Assign weights to the steps by defining the weight of an up-step to be 1, the weight of a level step at height h to be b_h , the weight of a down-step from height h to height $h - 1$ to be λ_h , and extend this weight, w say, to three-step paths P by defining $w(P)$ to be the product of all weights of the steps of P .

For the statement of the formula, we need to introduce the (orthogonal) polynomials $(p_n(x))_{n \geq 0}$ satisfying the three-term recurrence

$$xp_n(x) = p_{n+1}(x) + b_n p_n(x) + \lambda_n p_{n-1}(x), \quad \text{for } n \geq 1,$$

with initial conditions $p_0(x) = 1$ and $p_1(x) = x - b_0$. Finally, we introduce the operator T , which, when applied to a polynomial in the b_i 's and λ_i 's, replaces each b_i by b_{i+1} and each λ_i by λ_{i+1} for all i .

With these notations, the aforementioned formula from [36, Ch. V, Eq. (27)] (see also [22, Theorem 10.11.1]) is the following.

Theorem 55. *Let k, r, s be non-negative integers with $r, s \leq k$. Then*

$$\sum_{n \geq 0} \text{GF} \left(\mathcal{M}_n^{(k)}(r \rightarrow s); w \right) x^n = \begin{cases} \frac{p_r(1/x) T^{s+1} p_{k-s}(1/x)}{xp_{k+1}(1/x)}, & \text{if } r \leq s, \\ \lambda_r \cdots \lambda_{s+1} \frac{p_s(1/x) T^{r+1} p_{k-r}(1/x)}{xp_{k+1}(1/x)}, & \text{if } r \geq s. \end{cases}$$

In particular, the generating function for bounded three-step paths from height r to height s is again a rational function, and therefore we may think of extending the sequence $(\text{GF}(\mathcal{M}_n^{(k)}(r \rightarrow s); w))_{n \geq 0}$ to negative n .

We report here a conjecture hinting at the possibility of reciprocity laws in the Motzkin path context.

Let us write $M_n^{(k)}$ for $|\mathcal{M}_n^{(k)}(0 \rightarrow 0)|$. If we choose $r = s = 0$ and $b_i = \lambda_i = 1$ for all i , then we obtain

$$\sum_{n \geq 0} M_n^{(k)} x^n = \frac{U_k \left(\frac{1-x}{2x} \right)}{x U_{k+1} \left(\frac{1-x}{2x} \right)}, \quad (12.17)$$

as is not too difficult to see. It turns out that the sequence $(M_n^{(k)})_{n \geq 0}$ can be extended to negative indices n if and only if $k \not\equiv 1 \pmod{3}$. This is similar to the sequence $(C_n^{(k)})_{n \geq 0}$, which could be extended to negative indices n if and only if $k \not\equiv 0 \pmod{2}$. The reason is the same as in Item (1): for $k \equiv 1 \pmod{3}$, numerator and denominator of the rational fraction on the right-hand side of (12.17) have the same degree. Also here, we could remedy this by “correcting” $M_0^{(3k+1)}$ to $(2k+1)/(2k+2)$, again at the expense of obtaining non-integer values for negative indices n .

At any rate, computer experiments suggest the following conjecture.¹¹

Conjecture 56. *For all positive integers n, k, m , we have*

$$\det \left(M_{n+i+j+2m-2}^{(k+m-1)} \right)_{0 \leq i, j \leq k-1} = (-1)^{n \lfloor (k+m)/3 \rfloor} \det \left(M_{-n-i-j}^{(k+m-1)} \right)_{0 \leq i, j \leq m-1}, \quad \text{for } k+m \not\equiv 2 \pmod{3}. \quad (12.18)$$

Equation (12.18) must be seen as the “Motzkin analogue” of (5.1). There is also a “Motzkin analogue” of the “even” evaluation in (12.1). Since it can be proved by following the idea of the proof of Theorem 52, we omit its proof.

¹¹See the Final Note at the end of the article.

Theorem 57. For all positive integers n and k , we have

$$\det \left(M_{n+i+j}^{(k)} \right)_{0 \leq i, j \leq k-1} = (-1)^{n \lfloor (k+1)/3 \rfloor} \left(\frac{2k+4}{3} \right)^{n-1}, \quad \text{for } k \equiv 1 \pmod{3}. \quad (12.19)$$

It may be that there are also weighted versions of (12.18) and (12.19), as well as there may be “Motzkin analogues” of our reciprocity laws in Sections 6, 7, and 10.

At present, we do not know how to prove Conjecture 56. It is nevertheless tempting to approach a proof of (12.18), say, in the same way as we proved Theorems 15 and 34. Namely, by the Lindström–Gessel–Viennot theorem [26, Lemma 1], the determinant on the left-hand side of (12.18) equals $\sum_{\mathcal{P}} \text{sgn } \mathcal{P}$, where the sum runs over all families $(P_0, P_1, \dots, P_{k-1})$ of non-intersecting Motzkin paths¹² of height at most $k+m-1$, where P_i runs from $(-i, 0)$ to $(n+2m+\sigma(i)-2, 0)$, $i = 0, 1, \dots, k-1$, for some permutation $\sigma \in \mathfrak{S}_k$, with \mathfrak{S}_k denoting the set of permutations of $\{0, 1, \dots, k-1\}$; the sign $\text{sgn } \mathcal{P}$ is by definition equal to $\text{sgn } \sigma$. An example of such a family of non-intersecting Motzkin paths for $k = 4$, $m = 3$, $n = 7$, and the permutation σ is given by $\sigma(0) = 3$, $\sigma(1) = 2$, $\sigma(2) = 0$, $\sigma(3) = 1$, is shown in Figure 19. (At this point, circled points and attached labels, as well as dotted lines should be ignored.)

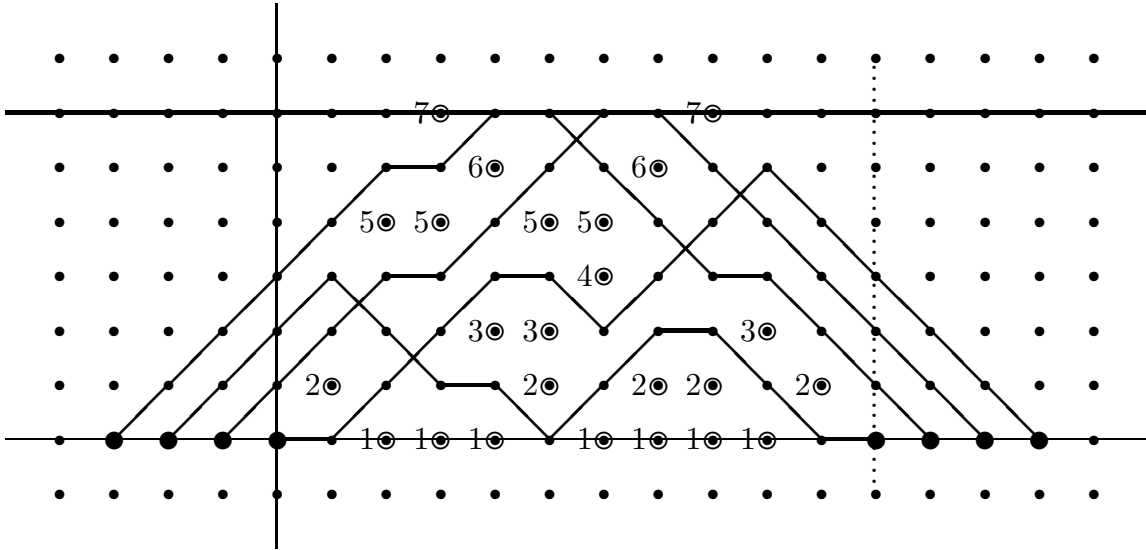

A family of non-intersecting Motzkin paths

Figure 19

Again, we may now use the non-occupied lattice points to map the family of Motzkin paths to certain arrays of numbers. In Figure 19, we have indicated the (relevant) non-occupied lattice points by circles, and the labels given equal the heights of the points

¹²However, it is important to note that a crossing of an up-step $(x, y) \rightarrow (x+1, y+1)$ and a down-step $(x, y+1) \rightarrow (x+1, y)$ is *not* a violation of the condition of being non-intersecting; according to [26, 12, 13], “non-intersecting” means that no two paths of a family of paths meet *in a vertex of the underlying graph*. In the present context, the vertices of the underlying graph are the lattice points, that is, the points with integer coordinates, in the plane.

plus 1. These labels are then assembled in an array, similar to what we did in the proof of Proposition 16. The array which corresponds to the path family in Figure 19 is

$$\begin{array}{cccccccc}
 & & 7 & 6 & 5 & 5 & 6 & 7 \\
 & & 5 & 5 & 3 & 3 & 4 & 2 & 2 & 3 \\
 2 & 1 & 1 & 1 & 2 & 1 & 1 & 1 & 1 & 2
 \end{array}$$

There are two important differences to the situation in the proof of Proposition 16: first, the arrays that we obtain have the property that entries along columns are decreasing (from top to bottom), but there is *no* condition for the entries along rows. Second, the map from path families to arrays is *not* a bijection, but rather a many-to-one mapping. Namely, if in a path family we replace a crossing¹³ of two paths by two parallel horizontal edges, or vice versa, then the corresponding array remains the same. Thus, these arrays have to be given weights taking into account all contributions of path families that map to the same array. While, given an array, it is not difficult to compute the corresponding weight in an ad hoc fashion, at present we do not know how to do this systematically (except for the case $m = 1$).

(4) One may think of variations and generalisations of the enumeration results for alternating tableaux in Section 11. We mention two such possibilities only, but will not develop them here.

In [13, Section 7], Gessel and Viennot describe a generalisation of the Jacobi–Trudi formula for skew Schur functions, the latter being the generating function for semistandard tableaux of a given skew shape, where the relation \leq that holds between entries along rows in the semistandard tableaux gets replaced by a semitransitive relation R , and the strict relation $<$ along columns gets replaced by the “reflection” \bar{R} of the negation of R , $\bar{R} = \{(a, b) : b \bar{R} a\}$. We could generalise the results in Section 11 to this setting.

A variation that one may think of is to consider “weak/strict” alternating sequences, that is, sequences $a_1 \leq a_2 > a_3 \leq a_4 > a_5 \leq \dots$. Analogues of Theorems 4 and 28 would be easy to obtain by modifying the corresponding proofs. In the mapping from alternating sequences to heaps in the proof of Theorem 4, the only difference that arises is that one forbids segments $i-i$, $i \geq 1$. Everything else carries through. There are also versions of the results in Section 11 in this setting.

(5) When we introduced heaps of segments in Section 3 (see the paragraphs after Theorem 4), we mentioned that these already appeared earlier in [4] in a completely different context. To be precise, in Proposition 3.4 of [4], Bousquet-Mélou and Viennot prove (phrased in our terminology) that there is a bijection between heaps of segments with a unique maximal segment of the form $j-1$ for some $j \geq 1$ and (so-called) *parallelogram polyominoes*. (We refer the reader to [4] for the definition of those.) Via this bijection, the number of segments of a heap corresponds to the width $w(P)$ of the corresponding polyomino P (the number of columns of the polyomino), the height $h(P)$ of P corresponds to the sum of the lengths of the segments plus 1, and the area $a(P)$ of P corresponds to the sum of the y -coordinates of the segments. Moreover, if the heap is restricted to the interval $[1, k]$ then all columns of the corresponding polyomino have a length of at most k . Our weights allow to keep track of all these statistics. This has the following consequence.

¹³See again Footnote 12.

Corollary 58. For a positive integer k and a non-negative integer n , we have

$$\begin{aligned} & \sum_{\substack{P \text{ polyomino} \\ \text{column lengths} \leq k}} q^{a(P)} y^{h(P)} x^{2w(P)} \\ &= - \frac{y \sum_{j=1}^k (-1)^j x^{2j} q^{\binom{j+1}{2}} \sum_{i=0}^{k-j} (yq)^i \begin{bmatrix} k-i-1 \\ j-1 \end{bmatrix}_q \begin{bmatrix} i+j-1 \\ j-1 \end{bmatrix}_q}{\sum_{j=0}^k (-1)^j x^{2j} q^{\binom{j+1}{2}} \sum_{i=0}^{k-j} (yq)^i \begin{bmatrix} k-i \\ j \end{bmatrix}_q \begin{bmatrix} i+j-1 \\ j-1 \end{bmatrix}_q}. \end{aligned} \quad (12.20)$$

PROOF. Heaps of segments on $[1, k]$ with a unique maximal segment $j-1$ for some $j \geq 1$ are the heaps of segments that, via the bijection in the proof of Lemma 5, correspond to alternating sequences in $\mathcal{A}_{2n+1}^{(k)}(1 \rightarrow 1)$. The corresponding generating function is given by (8.7) with $r = s = 1$, see (8.17). In our context the term V_1^2 can be ignored. The specialisation of the variables A_i and V_i which emulates the various statistics is $A_i = (yq)^i$ and $V_i = y^{-i}$ for $i \geq 1$. This specialisation of denominator and numerator in (8.17) has been computed in (8.18) and (8.19), respectively. \square

Bousquet-Mélou and Viennot [4, Prop. 4.1] derive a formula for the limiting case $k = \infty$. Their formula is easy to obtain from (12.20) by letting $k \rightarrow \infty$ and then applying the q -binomial theorem (cf. [11, Sec. 1.3])

$$\sum_{i=0}^{\infty} \begin{bmatrix} i+m-1 \\ m-1 \end{bmatrix}_q z^i = \frac{1}{(z; q)_m},$$

where $(z; q)_m := \prod_{i=1}^m (1 - zq^{i-1})$ is the standard q -shifted factorial. Indeed, we have

$$\begin{aligned} & \sum_{P \text{ polyomino}} q^{a(P)} y^{h(P)} x^{2w(P)} \\ &= - \frac{y \sum_{j=1}^{\infty} (-1)^j x^{2j} q^{\binom{j+1}{2}} \sum_{i=0}^{\infty} (yq)^i \frac{1}{(q; q)_{j-1}} \begin{bmatrix} i+j-1 \\ j-1 \end{bmatrix}_q}{\sum_{j=0}^{\infty} (-1)^j x^{2j} q^{\binom{j+1}{2}} \sum_{i=0}^{\infty} (yq)^i \frac{1}{(q; q)_j} \begin{bmatrix} i+j-1 \\ j-1 \end{bmatrix}_q} \\ &= - \frac{y \sum_{j=1}^{\infty} \frac{(-1)^j x^{2j} q^{\binom{j+1}{2}}}{(q; q)_{j-1} (yq; q)_j}}{\sum_{j=0}^{\infty} \frac{(-1)^j x^{2j} q^{\binom{j+1}{2}}}{(q; q)_j (yq; q)_j}}. \end{aligned}$$

We refer the reader to [4] and [8] for more material and references on generating functions for parallelogram polyominoes (and other classes of polyominoes).

(6) Next we report a curious fact for Hankel determinants of numbers of up-down paths in “very tight” strips, implying analogous results for Hankel determinants of numbers of bounded alternating sequences.

Theorem 59. Let n, k, r, s be non-negative integers with $0 \leq r, s \leq 2k - 1$. Then

$$\det \left(C_{2n+2i+2j+r+s}^{(2k-1)}(r \rightarrow s) \right)_{0 \leq i, j \leq k-1} = \begin{cases} 0, & \text{if } \gcd(r+1, 2k+1) \neq 1 \text{ or } \gcd(s+1, 2k+1) \neq 1, \\ (-1)^{\sum_{i=1}^k (\lfloor \frac{i(r+1)}{2k+1} \rfloor + \lfloor \frac{i(s+1)}{2k+1} \rfloor)}, & \\ \text{if } \gcd(r+1, 2k+1) = \gcd(s+1, 2k+1) = 1. \end{cases} \quad (12.21)$$

PROOF. This follows by combining Propositions 60 and 61. \square

Proposition 60. With the assumptions of Theorem 59, we have

$$\det \left(C_{2n+2i+2j+r+s}^{(2k-1)}(r \rightarrow s) \right)_{0 \leq i, j \leq k-1} = \det \left(C_{2i}^{(2k-1)}(r \rightarrow 2j + \chi(r \text{ odd})) \right)_{0 \leq i, j \leq k-1} \times \det \left(C_{2j}^{(2k-1)}(2i + \chi(s \text{ odd}) \rightarrow s) \right)_{0 \leq i, j \leq k-1}. \quad (12.22)$$

Here, $\chi(\mathcal{A}) = 1$ if \mathcal{A} is true and $\chi(\mathcal{A}) = 0$ otherwise.

PROOF. We show the assertion by using again non-intersecting lattice paths. By the Lindström–Gessel–Viennot theorem [26, Lemma 1], the determinant on the left-hand side of (12.22) equals $\sum_{\mathcal{P}} \text{sgn } \mathcal{P}$, where the sum is over all families $\mathcal{P} = (P_0, P_1, \dots, P_{k-1})$ of non-intersecting up-down paths of height at most $2k - 1$ that do not pass below the x -axis, where P_i runs from $(-2i, r)$ to $(2n + 2\sigma(i) + r + s, s)$, $i = 0, 1, \dots, k - 1$, for some permutation $\sigma \in \mathfrak{S}_k$; again, the sign $\text{sgn } \mathcal{P}$ is by definition equal to $\text{sgn } \sigma$. Figure 20 shows an example for $n = 2, k = 4, r = 2, s = 3$, and the permutation σ is given by $\sigma(0) = 0, \sigma(1) = 1, \sigma(2) = 3, \sigma(3) = 2$.

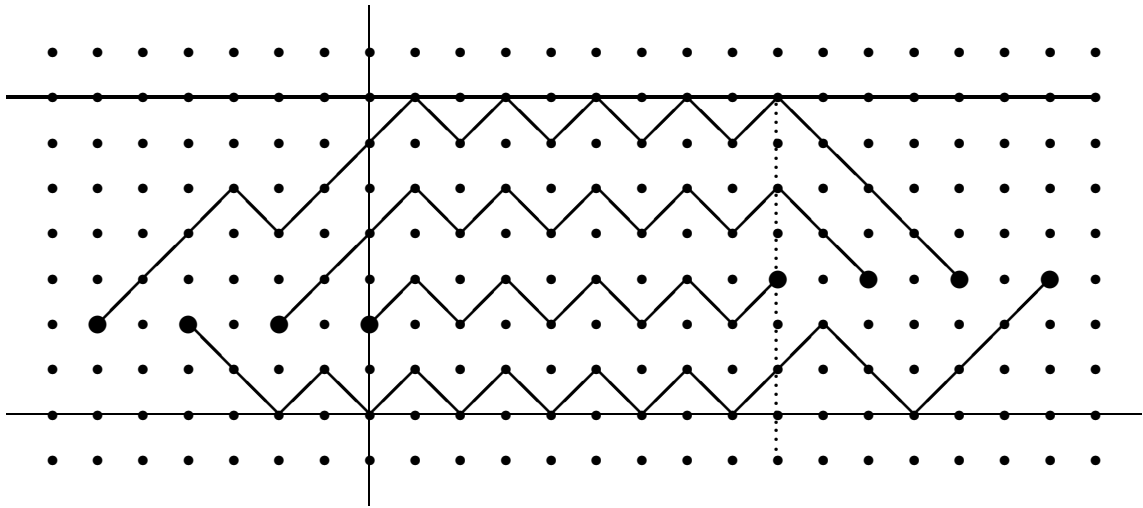

A family of non-intersecting up-down paths in a “very tight” strip

Figure 20

Because of the upper bound on the height of the paths, they are uniquely determined in the region between the abscissa $x = 0$ and $x = 2n + r + s$. In the figure, this is the region between the y -axis and the dotted vertical line. If we cut these path portions, then to the left of the y -axis there remains a family $\mathcal{Q} = (Q_0, Q_1, \dots, Q_{k-1})$ of non-intersecting up-down paths of height at most $2k - 1$ that do not pass below the x -axis, where Q_i runs from $(-2i, r)$ to $(0, 2\tau(i) + \chi(r \text{ odd}))$, $i = 0, 1, \dots, k - 1$, for some permutation $\tau \in \mathfrak{S}_k$, and to the right of the vertical line $x = 2n + r + s$ there remains a family $\mathcal{R} = (R_0, R_1, \dots, R_{k-1})$ of non-intersecting up-down paths of height at most $2k - 1$ that do not pass below the x -axis, where R_i runs from $(2n + r + s, 2i + \chi(s \text{ odd}))$ to $(2n + r + s + 2\rho(i), s)$, $i = 0, 1, \dots, k - 1$, for some permutation $\rho \in \mathfrak{S}_k$. By the Lindström–Gessel–Viennot theorem, the sum $\sum_{\mathcal{Q}} \text{sgn } \mathcal{Q}$ is given by the first determinant on the right-hand side of (12.22), and the sum $\sum_{\mathcal{R}} \text{sgn } \mathcal{R}$ is given by the second determinant on the right-hand side of (12.22). \square

Proposition 61. *Let k and s be non-negative integers with $0 \leq s \leq 2k - 1$. Then*

$$\det \left(C_{2j}^{(2k-1)}(2i + \chi(s \text{ odd}) \rightarrow s) \right)_{0 \leq i, j \leq k-1} = \begin{cases} 0, & \text{if } \gcd(s + 1, 2k + 1) \neq 1, \\ (-1)^{\sum_{i=1}^k \lfloor \frac{i(s+1)}{2k+1} \rfloor}, & \text{if } \gcd(s + 1, 2k + 1) = 1. \end{cases} \quad (12.23)$$

PROOF. It would be desirable to find a combinatorial proof of this assertion. Since we failed to find such proof, we base our arguments on a formula for bounded up-down paths that goes back to Laplace, followed by determinant manipulations.

We write $D_k(s)$ for the determinant on the left-hand side of (12.23). We first treat the case where s is odd, say $s = 2S + 1$. We use the well-known formula (see e.g. [22, Eq. (10.13)])

$$\frac{2}{K + 2} \sum_{k=1}^{K+1} \left(2 \cos \frac{\pi k}{K + 2} \right)^\ell \cdot \sin \frac{\pi k(r + 1)}{K + 2} \cdot \sin \frac{\pi k(s + 1)}{K + 2}$$

for the number of up-down paths of height at most K from $(0, r)$ to (ℓ, s) that do not pass below the x -axis. The entry $C_{2j}^{(2k-1)}(2i + 1 \rightarrow 2S + 1)$ in the determinant in (12.23) (where s was replaced by $2S + 1$) is the number of up-down paths of height at most $2k - 1$ from $(0, 2i + 1)$ to $(2j, 2S + 1)$ that do not pass below the x -axis. Therefore we have

$$\begin{aligned} D_k(2S + 1) &= \det \left(\frac{2}{2k + 1} \sum_{\ell=1}^{2k} \left(2 \cos \frac{\pi \ell}{2k + 1} \right)^{2j} \cdot \sin \frac{\pi \ell(2i + 2)}{2k + 1} \cdot \sin \frac{\pi \ell(2S + 2)}{2k + 1} \right)_{0 \leq i, j \leq k-1} \\ &= \frac{2^k}{(2k + 1)^k} \sum_{1 \leq \ell_0, \dots, \ell_{k-1} \leq 2k} \left(\prod_{i=0}^{k-1} \sin \frac{\pi \ell_i(2i + 2)}{2k + 1} \cdot \sin \frac{\pi \ell_i(2S + 2)}{2k + 1} \right) \\ &\quad \cdot \det \left(\left(2 \cos \frac{\pi \ell_i}{2k + 1} \right)^{2j} \right)_{0 \leq i, j \leq k-1}. \end{aligned}$$

We take the average of the last expression over all permutations of the ℓ_i 's and obtain

$$\begin{aligned}
D_k(2S+1) &= \frac{2^k}{(2k+1)^k} \cdot \frac{1}{k!} \sum_{\sigma \in \mathfrak{S}_k} \sum_{1 \leq \ell_0, \dots, \ell_{k-1} \leq 2k} \left(\prod_{i=0}^{k-1} \sin \frac{\pi \ell_{\sigma(i)}(2i+2)}{2k+1} \cdot \sin \frac{\pi \ell_i(2S+2)}{2k+1} \right) \\
&\quad \cdot \operatorname{sgn} \sigma \cdot \det \left(\left(2 \cos \frac{\pi \ell_i}{2k+1} \right)^{2j} \right)_{0 \leq i, j \leq k-1} \\
&= \frac{2^k}{(2k+1)^k} \sum_{1 \leq \ell_0 < \dots < \ell_{k-1} \leq 2k} \left(\prod_{i=0}^{k-1} \sin \frac{2\pi \ell_i(S+1)}{2k+1} \right) \\
&\quad \cdot \det \left(\sin \frac{2\pi \ell_j(i+1)}{2k+1} \right)_{0 \leq i, j \leq k-1} \cdot \det \left(\left(2 \cos \frac{\pi \ell_i}{2k+1} \right)^{2j} \right)_{0 \leq i, j \leq k-1}.
\end{aligned} \tag{12.24}$$

The last determinant in (12.24), a Vandermonde determinant, will vanish whenever $\ell_{i_1} = \ell_{i_2}$ for $i_1 \neq i_2$, but also whenever $\ell_{i_1} = 2k+1 - \ell_{i_2}$ since $\cos(\pi - x) = -\cos x$. Hence, non-zero contributions to the multiple sum in (12.24) arise only if for the set $\{\ell_0, \ell_1, \dots, \ell_{k-1}\}$ of indices we choose exactly one element out of $\{1, 2k\}$, exactly one element out of $\{2, 2k-1\}$, \dots , and exactly one element out of $\{k, k+1\}$. Moreover, each such choice produces the same summand as is not difficult to see using the relations $\cos(\pi - x) = -\cos x$, $\sin(2\pi + x) = \sin x$, and $\sin(-x) = -\sin x$. These arguments imply that the sum equals 2^k times the summand for the choice $\ell_i = i+1$, $i = 0, 1, \dots, k-1$. Thus, we have

$$\begin{aligned}
D_k(2S+1) &= \frac{2^{2k}}{(2k+1)^k} \left(\prod_{i=1}^k \sin \frac{2\pi i(S+1)}{2k+1} \right) \\
&\quad \cdot \det \left(\sin \frac{2\pi(j+1)(i+1)}{2k+1} \right)_{0 \leq i, j \leq k-1} \cdot \det \left(\left(2 \cos \frac{\pi(i+1)}{2k+1} \right)^{2j} \right)_{0 \leq i, j \leq k-1}.
\end{aligned}$$

Both these determinants can be evaluated in closed form. Namely, we have (cf. [21, Eq. (5.4)])

$$\begin{aligned}
\det \left(\sin \frac{\pi(i+1)\lambda_j}{m} \right)_{0 \leq i, j \leq k-1} \\
= 2^{k^2-k} \prod_{0 \leq i < j \leq k-1} \sin \frac{\pi(\lambda_i - \lambda_j)}{2m} \prod_{0 \leq i \leq j \leq k-1} \sin \frac{\pi(\lambda_i + \lambda_j)}{2m},
\end{aligned}$$

and in regard of the Vandermonde determinant we have

$$\det \left(\left(2 \cos \frac{\pi \lambda_i}{m} \right)^{2j} \right)_{0 \leq i, j \leq k-1} = 2^{k^2-k} \prod_{0 \leq i < j \leq k-1} \sin \frac{\pi(\lambda_i - \lambda_j)}{m} \sin \frac{\pi(\lambda_i + \lambda_j)}{m}.$$

Substituting this back in the last expression that we obtained in our computation, we get

$$\begin{aligned}
D_k(2S+1) &= \frac{2^{2k}}{(2k+1)^k} \left(\prod_{i=1}^k \sin \frac{2\pi i(S+1)}{2k+1} \right) \\
&\quad \cdot 2^{k^2-k} \left(\prod_{1 \leq i < j \leq k} \sin \frac{\pi(i-j)}{2k+1} \prod_{1 \leq i \leq j \leq k} \sin \frac{\pi(i+j)}{2k+1} \right) \\
&\quad \cdot 2^{k^2-k} \left(\prod_{1 \leq i < j \leq k} \sin \frac{\pi(i-j)}{2k+1} \sin \frac{\pi(i+j)}{2k+1} \right) \\
&= \frac{2^{2k^2}}{(2k+1)^k} \left(\prod_{i=1}^k \sin \frac{2\pi i(S+1)}{2k+1} \right) \\
&\quad \cdot \left(\prod_{i=1}^k \left(\sin \frac{\pi i}{2k+1} \right)^{2k-2} \right) \left(\prod_{i=1}^k \sin \frac{2\pi i}{2k+1} \right).
\end{aligned}$$

By Lemma 62 below, we have $\prod_{i=1}^k \sin \frac{\pi i}{2k+1} = 2^{-k} \sqrt{2k+1}$. However, we also have

$$\prod_{i=1}^k \sin \frac{2\pi i}{2k+1} = \prod_{i=1}^k \sin \frac{\pi i}{2k+1} = 2^{-k} \sqrt{2k+1}$$

since $\sin \frac{2\pi i}{2k+1} = \sin \frac{\pi(2k+1-2i)}{2k+1}$ for all $i = \lceil \frac{k+1}{2} \rceil, \dots, k-1, k$. Putting these observations together, we see that

$$D_k(2S+1) = \frac{2^k}{\sqrt{2k+1}} \prod_{i=1}^k \sin \frac{2\pi i(S+1)}{2k+1}. \tag{12.25}$$

If $\gcd(2S+2, 2k+1) \neq 1$, then for $i = (2k+1)/\gcd(2S+2, 2k+1)$ we have $\sin \frac{2\pi i(S+1)}{2k+1} = 0$, and consequently $D_k(2S+1) = 0$.

On the other hand, if $\gcd(2S+2, 2k+1) = 1$, then we claim that, up to a sign, the product on the right-hand side of (12.25) is also equal to $\prod_{i=1}^k \sin \frac{\pi i}{2k+1} = 2^{-k} \sqrt{2k+1}$. Indeed, for $1 \leq i \neq j \leq k$, we have $2i(S+1) \not\equiv \pm 2j(S+1) \pmod{2k+1}$, and therefore the set

$$\{2i(S+1) \pmod{2k+1} : i = 1, 2, \dots, k\}$$

contains exactly one element of the pair $\{j, 2k+1-j\}$, for $j = 1, 2, \dots, k$, proving our claim since $\sin(-x) = -\sin x$ and $\sin(\pi-x) = \sin x$. The sign of $\sin \frac{2\pi i(S+1)}{2k+1}$ depends on the ‘‘location’’ of $2i(S+1)$; more precisely, if $2i(S+1) \in [m\pi, (m+1)\pi)$, then this sign is positive if m is even and this sign is negative otherwise. If these considerations are used in (12.25), then we arrive at

$$D_k(2S+1) = (-1)^{\sum_{i=1}^k \lfloor 2i(S+1)/(2k+1) \rfloor},$$

provided $\gcd(2S + 2, 2k + 1) = 1$. This is equivalent to the assertion of the proposition for $s = 2S + 1$.

Now we turn to the case where s is even, say $s = 2S$. The reader should recall that the determinant on the left-hand side of (12.23) provides the signed enumeration of certain non-intersecting up-down paths. Hence, by a reflection in the horizontal line $y = (2k - 1)/2$, this case is transformed into the odd case, where the ending height of the paths is now $2k - 1 - 2S$. If we substitute this in the formula on the right-hand side of (12.23) and take into account that the reflection reversed the order of the starting points, creating a sign of $(-1)^{\binom{k}{2}}$, then after some manipulation we see that formula (12.23) also holds in the even case.

This finishes the proof of the proposition. \square

Lemma 62. *For non-negative integers n , we have*

$$\prod_{j=1}^{n-1} 2 \sin \frac{j\pi}{n} = n.$$

PROOF. Let $\omega = e^{\pi \mathbf{i}/n}$, where $\mathbf{i} = \sqrt{-1}$. Then we have

$$\begin{aligned} \prod_{j=1}^{n-1} 2 \sin \frac{j\pi}{n} &= (-\mathbf{i})^{n-1} \prod_{j=1}^{n-1} (\omega^j - \omega^{-j}) \\ &= \mathbf{i}^{n-1} \omega^{-\binom{n}{2}} \prod_{j=1}^{n-1} (1 - \omega^{2j}) = n, \end{aligned}$$

since ω^2 is a primitive n -th root of unity. \square

(7) It should be noted that all results of this article where this makes sense also hold for negative values of the parameter n . In order to illustrate this: let us consider Theorem 15. Our claim is that Equation (5.1) also holds for negative values of n . The reason is simple: since the sequence $(C_{2n}^{2k+2m-1})_{n \geq 0}$ satisfies a linear recurrence with constant coefficients (dictated by the denominator of the rational function on the right-hand side of (2.3) with $r = s = 0$ and k replaced by $2k + 2m - 1$), this implies a linear recurrence with constant coefficients for the left-hand side of (5.1) as well as for the right-hand side. Since (5.1) holds for all non-negative integers n , these recurrences for the left-hand side and for the right-hand side must be the same. Consequently, Equation (5.1) continues to hold also for negative values of n .

In this case, however, this is not very exciting since it turns out that, in this way, one obtains again the same identity. Namely, let us replace n by $-n$ in (5.1), to get

$$\det \left(C_{-2n+2i+2j+4m-2}^{(2k+2m-1)} \right)_{0 \leq i, j \leq k-1} = \det \left(C_{2n-2i-2j}^{(2k+2m-1)} \right)_{0 \leq i, j \leq m-1}.$$

Next we reverse the order of rows and columns in both determinants. This yields

$$\det \left(C_{-2n+4k-2i-2j+4m-4}^{(2k+2m-1)} \right)_{0 \leq i, j \leq k-1} = \det \left(C_{2n-4m+2i+2j+2}^{(2k+2m-1)} \right)_{0 \leq i, j \leq m-1}.$$

Finally we replace n by $n + 2k + 2m - 2$. Thus, we arrive at

$$\det \left(C_{-2n-2i-2j}^{(2k+2m-1)} \right)_{0 \leq i, j \leq k-1} = \det \left(C_{2n+2i+2j+4k-2}^{(2k+2m-1)} \right)_{0 \leq i, j \leq m-1}.$$

Clearly, this is (5.1) in which k and m are interchanged.

It is more interesting to apply this argument in, say, Theorem 59. Let us replace n by $-n$ in (12.21). The determinant on the left-hand side then becomes

$$\det \left(C_{-2n+2i+2j+r+s}^{(2k-1)}(r \rightarrow s) \right)_{0 \leq i, j \leq k-1}.$$

In view of Corollary 12, this determinant can be rewritten as a determinant of numbers of bounded alternating sequences. More precisely, we have

$$\begin{aligned} \det \left(C_{-2n+2i+2j+2r+2s-4}^{(2k-1)}(2r-2 \rightarrow 2s-2) \right)_{0 \leq i, j \leq k-1} \\ = (-1)^{k(r+s)} \det \left(|A_{2n-2i-2j-2r-2s+5}^{(k)}(r \rightarrow s)| \right)_{0 \leq i, j \leq k-1} \end{aligned}$$

and

$$\begin{aligned} \det \left(C_{-2n+2i+2j+2r+2s-3}^{(2k-1)}(2r-2 \rightarrow 2s-1) \right)_{0 \leq i, j \leq k-1} \\ = (-1)^{k(r+s)} \det \left(|A_{2n-2i-2j-2r-2s+4}^{(k)}(r \rightarrow s)| \right)_{0 \leq i, j \leq k-1}. \end{aligned}$$

In both determinants on the right-hand sides we reverse the order of rows and columns and then recall that, by Proposition 60, all these determinants are independent of n . This leads to

$$\begin{aligned} \det \left(C_{-2n+2i+2j+2r+2s-4}^{(2k-1)}(2r-2 \rightarrow 2s-2) \right)_{0 \leq i, j \leq k-1} \\ = (-1)^{k(r+s)} \det \left(|A_{2n+2i+2j+1}^{(k)}(r \rightarrow s)| \right)_{0 \leq i, j \leq k-1} \end{aligned}$$

and

$$\begin{aligned} \det \left(C_{-2n+2i+2j+2r+2s-3}^{(2k-1)}(2r-2 \rightarrow 2s-1) \right)_{0 \leq i, j \leq k-1} \\ = (-1)^{k(r+s)} \det \left(|A_{2n+2i+2j}^{(k)}(r \rightarrow s)| \right)_{0 \leq i, j \leq k-1}. \end{aligned}$$

In combination with Theorem 59, this proves the following result.

Corollary 63. *Let n, k, r, s be non-negative integers with $0 \leq r, s \leq 2k - 1$. Then*

$$\det \left(|\mathcal{A}_{2n+2i+2j+1}^{(k)}(r \rightarrow s)|_{0 \leq i, j \leq k-1} \right) = \begin{cases} 0, & \text{if } \gcd(2r-1, 2k+1) \neq 1 \text{ or } \gcd(2s-1, 2k+1) \neq 1, \\ (-1)^{k(r+s) + \sum_{i=1}^k (\lfloor \frac{i(2r-1)}{2k+1} \rfloor + \lfloor \frac{i(2s-1)}{2k+1} \rfloor)}, & \\ \text{if } \gcd(2r-1, 2k+1) = \gcd(2s-1, 2k+1) = 1. \end{cases} \quad (12.26)$$

and

$$\det \left(|\mathcal{A}_{2n+2i+2j}^{(k)}(r \rightarrow s)|_{0 \leq i, j \leq k-1} \right) = \begin{cases} 0, & \text{if } \gcd(2r-1, 2k+1) \neq 1 \text{ or } \gcd(2s, 2k+1) \neq 1, \\ (-1)^{k(r+s) + \sum_{i=1}^k (\lfloor \frac{i(2r-1)}{2k+1} \rfloor + \lfloor \frac{2is}{2k+1} \rfloor)}, & \\ \text{if } \gcd(2r-1, 2k+1) = \gcd(2s, 2k+1) = 1. \end{cases} \quad (12.27)$$

We present one more application of this extension idea. It concerns the identities (12.4) and (12.5). Let us again write $a(n, k)$ for $\sum_{s=0}^k C_n^{(k)}(0 \rightarrow s)$. Inspection of numerator and denominator degrees in (12.6) with k replaced by $4k - 2$ shows that the sequence $(a(n, 4k - 2))_{n \geq 0}$ can be extended to negative integers n by using the linear recurrence with constant coefficients that the sequence satisfies. This is not quite so for the sequence $(a(n, 4k))_{n \geq 0}$ since numerator and denominator degrees in (12.6) with k replaced by $4k$ are the same, causing the constant term to violate the linear recurrence with constant coefficients that the sequence satisfies otherwise. To “repair” this, we define the modified sequence $(\tilde{a}(n, 4k))_{n \geq 0}$ by $\tilde{a}(n, 4k) = a(n, 4k)$ for $n \geq 1$, and $\tilde{a}(0, 4k) = \frac{2k}{2k+1}$. This sequence can be extended to negative indices. Then, using the same reasoning as above, we obtain the following corollary from Theorem 52.

Corollary 64. *Let n be a non-negative integer and k be a positive integer. Then we have*

$$\det (\tilde{a}(-n - i - j - 1, 4k))_{0 \leq i, j \leq 2k-1} = (-1)^{k(n-1)} (2k+1)^{-n-4k} \quad (12.28)$$

and

$$\det (a(-n - i - j, 4k - 2))_{0 \leq i, j \leq 2k-1} = (-1)^{kn} 2^{-n-4k+2}. \quad (12.29)$$

PROOF. In (12.4) and (12.5), we replace n by $-n$. Furthermore, we reverse the order of rows and columns of the matrices, that is, we replace i by $2k - 1 - i$ and j by $2k - 1 - j$. To complete the proof, n has to be shifted by $4k$ to obtain (12.28), and by $4k - 2$ to obtain (12.29). \square

FINAL NOTE. Since the original version of this article appeared on the arXiv in 2020, several further developments related to parts of this article have occurred that we want to mention here. More precisely:

- (1) Zaimi [39], by a clever use of the transfer matrix idea, has proved a general reciprocity theorem for non-intersecting paths in periodic planar networks, which has

now appeared in paper form in the joint article [15] with Hopkins. It covers our Theorem 21, and the weighted version covers Theorem 41. With some adaptation (respectively preprocessing), one might also cover Theorems 24 and 44, and provide a proof of Conjecture 56. However, the connection with (arrays of) alternating sequences is not a part in this picture.

- (2) In [16], Jang et al. develop an interesting framework for computing moments of orthogonal polynomials “with negative indices”. In particular, this leads them to a combinatorial model for the number of bounded Motzkin paths “with negative indices” that involves generalisations of alternating sequences. These developments allow them in the end to give proofs of both Conjectures 51 and 56, but are in the first place extremely interesting in their own right.
- (3) In our article, the “duality” between up-down paths and alternating sequences, expressed by the reciprocity relations in Corollaries 12–14 and further results in subsequent sections, has been presented as an *observation*, by which we mean: without an intrinsic, conceptual explanation. Viennot [38] has found a beautiful such explanation based on the heap pictures for up-down paths and alternating sequences that we presented in Sections 2 and 3, respectively, via a combinatorial reciprocity between dimers and segments.

References

1. N. Anzalone, J. Baldwin, I. Bronshtein and T. Kyle Petersen, *A reciprocity theorem for monomer-dimer coverings*, Discrete models for complex systems, DMCS '03 (Lyon), Discrete Math. Theor. Comput. Sci. Proc., vol. AB, Nancy, 2003, pp. 179–193.
2. Y. Baryshnikov and D. Romik, *Enumeration formulas for Young tableaux in a diagonal strip*, Israel J. Math. **178** (2010), 157–186.
3. M. Beck and R. Sanyal, *Combinatorial reciprocity theorems. An invitation to enumerative geometric combinatorics*, Graduate Studies in Mathematics, vol. 195, American Mathematical Society, Providence, RI, 2018.
4. M. Bousquet-Mélou and X. Viennot, *Empilements de segments et q -énumération de polyominos convexes dirigés*, J. Combin. Theory Ser. A **60** (1992), 196–224.
5. P. Cartier and D. Foata, *Problèmes combinatoires de commutation et réarrangements*, Lecture Notes in Mathematics, no. 85, Springer-Verlag, Berlin, New York, 1969, republished in the “books” section of the Séminaire Lotharingien de Combinatoire.
6. J. Cigler, *Some remarks and conjectures related to lattice paths in strips along the x -axis*, manuscript, [arXiv:1501.04750](https://arxiv.org/abs/1501.04750).
7. J. Favard, *Sur les polynomes de Tchebicheff*, Comptes Rendus Acad. Sci. Paris **200** (1935), 2052–2053.
8. S. Feričić, *An alternative method for q -counting directed column-convex polyominoes*, Discrete Math. **210** (2000), 55–70.
9. S. Formichella and A. Straub, *Gaussian binomial coefficients with negative arguments*, Ann. Combin. **23** (2019), 725–748.
10. A. M. Garsia and Ö. Eğecioğlu, *Lectures in Algebraic Combinatorics*, Lecture Notes in Math., vol. 2277, Springer, Cham, 2020.
11. G. Gasper and M. Rahman, *Basic hypergeometric series*, second edition, Encyclopedia of Math. And Its Applications 96, Cambridge University Press, Cambridge, 2004.
12. I. M. Gessel and X. G. Viennot, *Binomial determinants, paths, and hook length formulae*, Adv. Math. **58** (1985), 300–321.
13. I. M. Gessel and X. G. Viennot, *Determinants, paths, and plane partitions*, preprint, 1989, available

at <http://www.cs.brandeis.edu/~ira>.

14. A. M. Hamel and I. P. Goulden, *Planar decompositions of tableaux and Schur function determinants*, *Europ. J. Combin.* **16** (1995), 461–477.
15. S. Hopkins and G. Zaimi, *Combinatorial reciprocity for non-intersecting paths*, *Enum. Combin. Appl.* **3** (2023), Article S2R13, 13 pp.
16. J. Jang, D. Kim, J. S. Kim, M. Song and U-K. Song, *Negative moments of orthogonal polynomials*, preprint, [arXiv:2201.11344](https://arxiv.org/abs/2201.11344).
17. E. Y. Jin, *Outside nested decompositions of skew diagrams and Schur function determinants*, *Europ. J. Combin.* **67** (2018), 239–267.
18. C. Krattenthaler, *Enumeration of lattice paths and generating functions for skew plane partitions*, *Manuscripta Math.* **63** (1989), 129–156.
19. C. Krattenthaler, *Permutations with restricted patterns and Dyck paths*, *Adv. Appl. Math.* **27** (2001), 510–530.
20. C. Krattenthaler, *The theory of heaps and the Cartier–Foata monoid*, appendix to reference [5] in the “books” section of the Séminaire Lotharingien de Combinatoire, 2006.
21. C. Krattenthaler, *Asymptotics for random walks in alcoves of affine Weyl groups*, *Séminaire Lotharingien Combin.* **52** (2007), Article B52i, 72 pp.
22. C. Krattenthaler, *Lattice path enumeration*, *Handbook of Enumerative Combinatorics* (M. Bóna, ed.), CRC Press, Boca Raton, London, New York, 2015, pp. 589–678.
23. C. Krattenthaler, *Plane partitions in the work of Richard Stanley and his school*, *The Mathematical Legacy of Richard P. Stanley* (P. Hersh, T. Lam, P. Pylyavskyy, V. Reiner, eds.), Amer. Math. Soc., R.I., 2016, pp. 246–277.
24. C. Krattenthaler and D. Yaqubi, *Some determinants of path generating functions, II*, *Adv. Appl. Math.* **101** (2018), 232–265.
25. A. Lascoux and P. Pragacz, *Ribbon Schur functions*, *Europ. J. Combin.* **9** (1988), 561–574.
26. B. Lindström, *On the vector representations of induced matroids*, *Bull. London Math. Soc.* **5** (1973), 85–90.
27. D. Loeb, *Sets with a negative number of elements*, *Adv. Math.* **91** (1992), 64–74.
28. A. L. Owczarek and T. Prellberg, *Enumeration of area-weighted Dyck paths with restricted height*, *Australas. J. Combin.* **54** (2012), 13–18.
29. J. Propp, *A reciprocity theorem for domino tilings*, *Electron. J. Combin.* **8** (2001), Research Paper 18, 9 pp.
30. D. Speyer, *A reciprocity sequence for perfect matchings of linearly growing graphs*, unpublished manuscript; available at <http://www-personal.umich.edu/~speyer/TransferMatrices.pdf>.
31. R. P. Stanley, *Combinatorial reciprocity theorems*, *Adv. Math.* **14** (1974), 194–253.
32. R. P. Stanley, *Decompositions of rational convex polytopes*, *Ann. Discrete Math.* **6** (1980), 333–342.
33. R. P. Stanley, *On dimer coverings of rectangles of fixed width*, *Discrete Appl. Math.* **12** (1985), 81–87.
34. R. P. Stanley, *Enumerative Combinatorics*, Vol. 2, Cambridge University Press, Cambridge, 1999.
35. R. P. Stanley, *Enumerative Combinatorics*, Vol. 1, second edition, Cambridge University Press, Cambridge, 2012.
36. X. G. Viennot, *Une théorie combinatoire des polynômes orthogonaux généraux*, UQAM, Montréal, Québec, 1983, available at http://www.xavierviennot.org/xavier/polynomes_orthogonaux.html.
37. X. G. Viennot, *Heaps of pieces. I. Basic definitions and combinatorial lemmas*, *Lecture Notes in Math.*, vol. 1234, Springer, Berlin, 1986, pp. 321–350.
38. X. G. Viennot, *Lattice paths and heaps*, lecture given at the Conference on “Lattice Paths, Combinatorics and Interactions”, CIRM, Luminy, 2021; slides and video available at <https://viennot.org>.
39. G. Zaimi, *Answer to the posting “Reciprocity for fans of bounded Dyck paths” by Sam Hopkins on MathOverflow*, available at <https://mathoverflow.net/questions/373030/reciprocity-for-fans-of-bounded-dyck-paths>.

FAKULTÄT FÜR MATHEMATIK, UNIVERSITÄT WIEN, OSKAR-MORGENSTERN-PLATZ 1, A-1090 VIENNA, AUSTRIA.

WWW: <http://homepage.univie.ac.at/johann.cigler>, <http://www.mat.univie.ac.at/~kratt>