

# ISOTOPY AND EQUIVALENCE OF KNOTS IN 3-MANIFOLDS

PAOLO ACETO, COREY BREGMAN, CHRISTOPHER W. DAVIS, JUNGHWAN PARK,  
AND ARUNIMA RAY

**ABSTRACT.** We show that in a prime, closed, oriented 3-manifold  $M$ , equivalent knots are isotopic if and only if the orientation preserving mapping class group is trivial. In the case of irreducible, closed, oriented 3-manifolds we show the more general fact that every orientation preserving homeomorphism which preserves free homotopy classes of loops is isotopic to the identity. In the case of  $S^1 \times S^2$ , we give infinitely many examples of knots whose isotopy classes are changed by the Gluck twist.

## 1. INTRODUCTION

Let  $M$  be a closed, oriented 3-manifold. A knot  $K$  in  $M$  is a (tame) embedding of the (oriented) circle in  $M$ . There are three natural equivalence relations on knots in  $M$ . We say that the knots  $K, J: S^1 \hookrightarrow M$  are *equivalent* if there is an orientation preserving homeomorphism  $f: M \rightarrow M$  such that  $f \circ K = J$ . On the other hand, we say that  $K$  and  $J$  are *isotopic* if there is a (tame) 1-parameter family of embeddings  $F_t: S^1 \times [0, 1] \rightarrow M$  such that  $F_0 = K$  and  $F_1 = J$ . We say that  $K$  and  $J$  are *ambient isotopic* if there is a 1-parameter family of homeomorphisms  $G_t: M \rightarrow M$  such that  $G_0$  is the identity and  $G_1 \circ K = J$ . By the isotopy extension theorem [EK71, Corollary 1.4], two knots in any fixed  $M$  are isotopic if and only if they are ambient isotopic. It is clear from the definitions that ambient isotopy implies equivalence of knots. It is then interesting to ask to what extent equivalence implies isotopy.

Let  $\text{Mod}^+(M)$  denote the *mapping class group* of  $M$ , that is, the set of orientation preserving homeomorphisms of the closed, oriented 3-manifold  $M$ , modulo isotopy. Any orientation preserving homeomorphism of  $S^3$  is isotopic to the identity [Fis60] (see also [BZH14, Section 1.B]); in other words, the mapping class group of  $S^3$  is trivial, and thus, the notions of equivalence and isotopy of knots coincide. Plainly, equivalent knots are isotopic in any 3-manifold with trivial mapping class group. The converse is the main result of this paper.

**Theorem 1.1.** *Let  $M$  be a prime, closed, oriented 3-manifold. Equivalent knots in  $M$  are isotopic if and only if  $\text{Mod}^+(M)$  is trivial.*

In the case of irreducible 3-manifolds, Theorem 1.1 is a direct consequence of the following more general theorem.

**Theorem 1.2.** *Let  $M$  be an irreducible, closed, oriented 3-manifold. If an orientation preserving homeomorphism  $f: M \rightarrow M$  preserves free homotopy classes of loops, that is, for every loop  $\gamma \subset M$  the loop  $f(\gamma)$  is freely homotopic to  $\gamma$ , then  $f$  is isotopic to the identity.*

---

*Date:* July 14, 2020.

*2020 Mathematics Subject Classification.* 57K10, 57K30, 20F34, 20F65.

Equivalently, Theorem 1.2 says that if  $f$  acts by the identity on the set of conjugacy classes of  $\pi_1(M)$  then  $f$  is isotopic to the identity. Theorem 1.2 implies Theorem 1.1 for irreducible, closed, oriented 3-manifolds, since isotopic knots are in particular freely homotopic.

We now describe the proof of Theorem 1.2. As usual, given a group  $G$ , the outer automorphism group  $\text{Out}(G)$  is the quotient  $\text{Aut}(G)/\text{Inn}(G)$ . Each homeomorphism of a 3-manifold  $M$  induces an element of  $\text{Out}(\pi_1(M))$ . Here, we must quotient out by the inner automorphism group since the homeomorphism may not preserve the basepoint of the fundamental group. In particular, since an isotopy may not preserve the basepoint, a self-homeomorphism of  $M$  that is isotopic to the identity can only be assumed to induce an inner automorphism on  $\pi_1(M)$ .

For irreducible, oriented 3-manifolds, it is a consequence of the work of several authors, as explained in Theorem 3.1, that the above map is an injection, that is,  $\text{Mod}^+(M) \hookrightarrow \text{Out}(\pi_1(M))$ . Then the proof would be completed by showing that if an orientation preserving homeomorphism  $f: M \rightarrow M$  on an irreducible, closed, oriented 3-manifold  $M$  preserves free homotopy classes of loops, or equivalently, fixes every conjugacy class of  $\pi_1(M)$ , then  $f_*$  is an inner automorphism.

**Definition 1.3** (Property A of groups). An automorphism of a group  $G$  is called *class preserving* if it fixes every conjugacy class of  $G$ . A group is said to have *Grossman's Property A* if every class preserving automorphism is inner.

Clearly, inner automorphisms are class preserving. Grossman introduced Property A in [Gro75] and showed that free groups and surface groups have Property A. She then used this to prove that the outer automorphism groups of free groups and surface groups are residually finite.

After Grossman's work, Property A has been shown to hold when a group exhibits some degree of hyperbolicity. First, Neshchadim proved that non-trivial free products have Property A [Nes96]. This was greatly generalized by Minasyan–Osin to the setting of relatively hyperbolic groups, who in fact showed that for such groups any automorphism that preserves normal subgroups is inner [MO10]. Most recently, Antolín–Minasyan–Sisto [AMS16] further extended the results of [MO10] to commensurating endomorphisms of acylindrically hyperbolic groups.

We prove the following result, which completes the proof of Theorem 1.2.

**Theorem 1.4.** *Let  $M$  be a closed, orientable 3-manifold. Then  $\pi_1(M)$  has Property A.*

This theorem was already known in many cases. Compact 3-manifold groups are either acylindrically hyperbolic, Seifert-fibered, or virtually solvable [MO15]. Since 3-manifold groups are known to be conjugacy separable [HWZ13], Antolín–Minasyan–Sisto prove that  $\text{Out}(\pi_1(M))$  is residually finite when  $M$  is a compact 3-manifold, using Grossman's criterion in the acylindrically hyperbolic case and a direct argument when  $\pi_1(M)$  is Seifert-fibered or virtually solvable [AMS16].

On the other hand, Allenby–Kim–Tang have shown that if  $M$  is a Seifert-fibered 3-manifold whose base orbifold is not a sphere with precisely 3 cone points nor a torus with a single cone point, then  $\pi_1(M)$  has Property A [AKT03, AKT09]. In Theorem 2.9 we establish Property A for fundamental groups of all Seifert-fibered 3-manifolds without any restriction on the base of the fibering. Finally, the case of

virtually solvable but not Seifert-fibered corresponds to those closed manifolds supporting Sol-geometry. We treat Property A for these manifolds in Proposition 2.10, completing the proof of Theorem 1.4.

The general structure of 3-manifolds suggests a more topological approach to proving Theorem 1.4. Call a homeomorphism of a 3-manifold *class preserving* if it induces a class preserving automorphism on the fundamental group. By Neshchadim's result, non-prime 3-manifold groups have Property A [Nes96]. If  $M$  is prime and has a non-trivial JSJ-decomposition, then  $M$  is irreducible and every automorphism of the fundamental group can be represented by a homeomorphism by Waldhausen's theorem [Wal68]. Then one shows that a class preserving homeomorphism  $h$  of a prime 3-manifold can be modified by isotopy so that it restricts to class preserving homeomorphisms on the JSJ-pieces, which are all either Seifert-fibered or have relatively hyperbolic fundamental group. Having established Property A for JSJ-pieces, one shows that  $h$  is isotopic to the identity. This was our strategy in an earlier draft of the paper, before learning of the results in [MO15, AMS16]. Since this version of the proof is topological and may be of independent interest, we include it in Appendix B.

Finally we turn to the case of  $S^1 \times S^2$ . The *geometric winding number* of a knot  $K \subset S^1 \times S^2$  is the minimal number of times that  $K$  intersects a non-separating sphere in  $S^1 \times S^2$  and the (*algebraic*) *winding number* of a knot  $K$  in  $S^1 \times S^2$  is the algebraic intersection number of  $K$  and  $\{pt\} \times S^2$ . The latter quantity is a well defined integer since  $\{pt\} \times S^2$  is oriented. The manifold  $S^1 \times S^2$  is the result of 0-framed Dehn surgery on  $S^3$  along the unknot. Thus, every knot  $K \subset S^1 \times S^2$  may be presented as a knot in such a surgery diagram as in Figure 1. The orientation of  $\{pt\} \times S^2$  is indicated by the arrow on the 0-framed unknot.

Define the *Gluck twist*  $\mathcal{G}: S^1 \times S^2 \rightarrow S^1 \times S^2$  by  $\mathcal{G}(\theta, s) = (\theta, \rho_\theta(s))$  where  $(\theta, s) \in S^1 \times S^2$  and  $\rho_\theta$  is given by rotating  $S^2$  about the vertical axis by angle  $\theta$ . For a given diagram of a knot  $K \subset S^1 \times S^2$ , the effect of  $\mathcal{G}$  is to insert a full positive twist in all strands intersecting  $\{pt\} \times S^2$ , as shown in Figure 1.

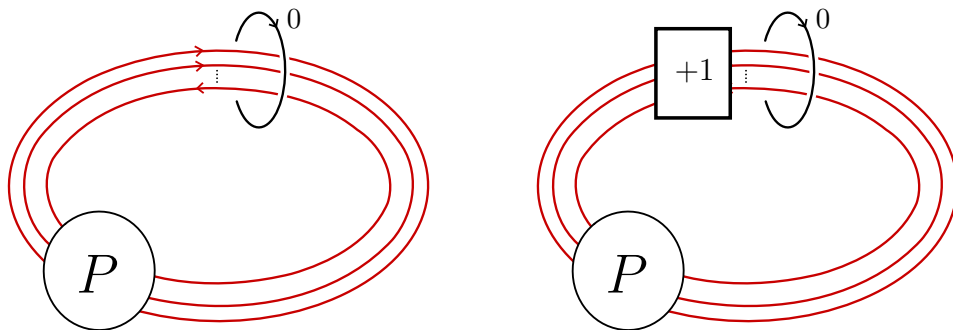

FIGURE 1. Left: A knot  $K$  in  $S^1 \times S^2$ . Right: The image  $\mathcal{G}(K)$  of  $K$  under the Gluck twist  $\mathcal{G}$ . The “+1” indicates one full right handed twist.

The mapping class group of  $S^1 \times S^2$  was shown to be  $\mathbb{Z}/2 \oplus \mathbb{Z}/2$  by Gluck [Glu62, Theorem 5.1], where the first  $\mathbb{Z}/2$ -factor is generated by the homeomorphism which reverses the orientation on both the  $S^1$ - and  $S^2$ -factors, and the second is generated

by the Gluck twist. The former reverses the orientation of the knot  $S^1 \times \{pt\}$ . However, the Gluck twist acts by the identity on free homotopy classes of loops. Indeed, for knots in  $S^1 \times S^2$  with geometric winding number 0, 1, or 2, the Gluck twist preserves isotopy classes, since the effect of a Gluck twist can be undone by a slide, in particular, an isotopy, over a non-separating 2-sphere (see Figure 2). A similar argument shows that for each even integer  $w$ , there exists a knot  $K$  with winding number  $w$  such that  $K$  is isotopic to  $\mathcal{G}(K)$ . Nevertheless, and in contrast with Theorem 1.2, we show that there exist knots in  $S^1 \times S^2$  whose isotopy classes are changed under the Gluck twist.

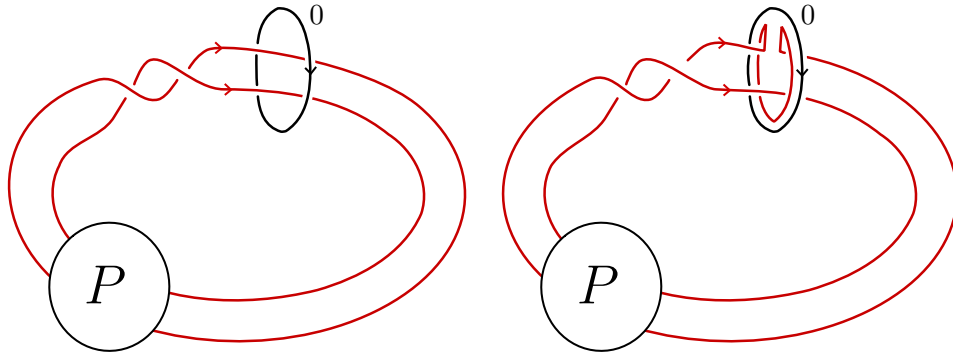

FIGURE 2. Left:  $\mathcal{G}(K)$  for some geometric winding number two knot. Right: A slide over the 0-framed curve reduces  $\mathcal{G}(K)$  back to  $K$ .

**Theorem 1.5.** *For each nonzero integer  $w$ , there exists a knot  $K \subset S^1 \times S^2$  with winding number  $w$  such that  $K$  is not isotopic to  $\mathcal{G}(K)$ .*

*Moreover, if  $K \subset S^1 \times S^2$  has odd winding number and is isotopic to  $\mathcal{G}(K)$ , then  $K$  has geometric winding number 1.*

Observe that by the lightbulb trick, there are only two isotopy classes of knots with geometric winding number 1. The one with algebraic winding number +1 is called the the *Hopf knot* in [DNPR18]. The other is its reverse. Since the only prime, reducible, oriented 3-manifold is  $S^1 \times S^2$ , Theorem 1.5 completes the proof of Theorem 1.1.

For a knot  $K \subset S^1 \times S^2$ , we may fix a diagram, such as in Figure 1. Such a diagram lies in  $S^3$  and as such, has a preferred longitudinal framing. Then any framing of the diagram may be identified with an integer, by comparing with the preferred framing. The key observation for the proof of Theorem 1.5 is that the Gluck twist and isotopies have differing effects on the framing of a given knot diagram. This is made precise in Proposition 4.1, which states that if  $D$  is a diagram for a knot  $K \subset S^1 \times S^2$  with winding number  $w$ , such that  $K$  is isotopic to  $\mathcal{G}(K)$ , then for any nonzero integer  $f$ , there is a homeomorphism of  $S^1 \times S^2$  sending the  $f$ -framing of  $D$  to the  $(f + w^2 + 2kw)$ -framing of  $D$ . This observation along with a theorem of McCullough [McC06, Theorem 1] regarding homeomorphisms of 3-manifolds restricting to nontrivial Dehn twists on the boundary implies that either  $w^2 + 2kw = 0$  or  $K$  has geometric winding number 1, proving the second half of Theorem 1.5.

For nonzero even winding numbers, the requirement that  $w^2 + 2kw = 0$  is not a contradiction. However, Proposition 4.1 implies the existence of a non-trivial self-homeomorphism of the manifold  $M(D, f)$ , for each  $f$ . Here  $M(D, n)$  is the result of Dehn surgery on  $S^1 \times S^2$  along  $D$  with framing  $n$ . For the knots obtained as  $(2n, 1)$  cables of the core curve  $S^1 \times \{pt\} \subset S^1 \times S^2$ , that is, as  $(2n, 1)$ -cables of the Hopf knot, for  $|n| > 1$  (see Figure 11), we employ the correction term defined by Ozsváth and Szabó [OS03] to obstruct the existence of such a homeomorphism. For winding number  $\pm 2$ , we use SnapPy and Sage [CDGW] to verify that for  $D$  as in Figure 12, the manifold  $M(D, 1)$  is hyperbolic with no non-trivial self-homeomorphisms.

Our key observation (Proposition 4.1) is ineffectual when  $w = 0$ , leading to the following natural open question.

**Question 1.6.** Does there exist a winding number zero knot  $K \subset S^1 \times S^2$  such that  $K$  is not isotopic to  $\mathcal{G}(K)$ ?

It is astonishing that Theorem 1.5 can be proven by studying *homeomorphism* invariants of 3-manifolds, even though  $K$  is sent to  $\mathcal{G}(K)$  by a homeomorphism. A more obvious approach to this problem is to begin with an isotopy invariant of knots which has no reason to be preserved under homeomorphism. One such invariant is the *Kauffman bracket skein module*  $\mathcal{S}(S^1 \times S^2)$  associated to  $S^1 \times S^2$  [Prz91]. This module is generated by framed knots in  $S^1 \times S^2$  and is explicitly computed in [HP95]. Using their classification we prove that this invariant is unable to detect the difference between  $K$  and  $\mathcal{G}(K)$ . Let  $\mathcal{K}$  be a framed knot that corresponds to  $K \subset S^1 \times S^2$  when one forgets the framing. For an integer  $f$ , let  $\mathcal{K}^f$  denote the framed knot obtained by adding  $f$  full positive twists to the framing of  $\mathcal{K}$ . Observe that  $\mathcal{K}$  and  $\mathcal{K}^f$  have the same underlying knot type.

**Theorem 1.7.** *Let  $\mathcal{K}$  be a framed knot in  $S^1 \times S^2$  with geometric winding number  $w$  and let  $[\mathcal{K}]$  be its class in  $\mathcal{S}(S^1 \times S^2)$ . If  $w$  is even then  $[\mathcal{K}] = [\mathcal{G}(\mathcal{K})]$ . If  $w$  is odd, then  $[\mathcal{K}] = [\mathcal{G}(\mathcal{K})^f]$  for some  $f \in \mathbb{Z}$ .*

*In particular, the class in the Kauffman skein bracket module does not distinguish the knot type of  $K$  from that of  $\mathcal{G}(K)$ .*

Lastly, while we only consider the case of prime, closed, oriented 3-manifolds in this paper, we suspect that Theorem 1.1 should hold more generally.

**Conjecture 1.8.** Let  $M$  be an oriented 3-manifold. Equivalent knots in  $M$  are isotopic if and only if  $\text{Mod}^+(M)$  is trivial.

**Outline.** In Section 2 we prove Theorem 1.4. Section 3 gives the proof of Theorem 1.2 using Theorem 1.4. In Section 4 we establish Proposition 4.1 and prove Theorem 1.5 for odd winding numbers. The case of even winding numbers is addressed in Section 5. Theorem 1.7 is proven in Appendix A. We give a topological proof for Theorem 1.4 in Appendix B.

**Notation and conventions.** In this paper, every manifold is connected and oriented. For any given knot  $K$  in  $S^3$  and  $n \in \mathbb{Z}$ , the 3-manifold obtained by  $n$ -framed Dehn surgery on  $S^3$  along  $K$  is denoted by  $S_n^3(K)$ . The symbol  $\cong$  is used for isomorphism between groups as well as homeomorphism between manifolds.

We work in the topological category. Standard results in 3-manifold topology imply that our results hold in the smooth category as well. More precisely, each 3-manifold admits a unique smooth structure [Moi52, Moi77, Bin59, Mun59, Mun60, Whi61] and any homeomorphism is homotopic to a diffeomorphism [Cer68, Hat83].

**Acknowledgments.** This project began when the authors were based at or visiting the Max Planck Institute for Mathematics. We thank the MPIM for providing an excellent environment for research. Many of the results of section 2 were completed when the second author visited the fourth in Fall 2019. We thank Georgia Tech for their generous hospitality during this time. We also thank Stefan Friedl, Marco Golla, Tye Lidman, Lisa Piccirillo, Danny Ruberman, and Laura Starkston for helpful conversations. We are grateful to Yago Antolín for pointing out several references on Property A for acylindrically hyperbolic groups and conjugacy separability for 3-manifold groups. The second author is supported by NSF grant DMS-1906269.

**Note.** When this manuscript was in its final stages of preparation, we learned that John Etnyre and Dan Margalit have a proof of Conjecture 1.8 using entirely different methods.

## 2. PROPERTY A OF GROUPS

The goal of this section is to prove Theorem 1.4. We begin by gathering some relevant results. Generalizing the work of Grossman [Gro75] and others, Minasyan and Osin showed that every torsion-free hyperbolic and relatively hyperbolic group has Property A [MO10]. In fact, they prove that for such groups, any automorphism that preserves every normal subgroup is inner. In particular, since a non-trivial free product is hyperbolic relative to its factors, every non-trivial free product has Property A. As mentioned in the introduction, this was originally proved by Neshchadim [Nes96]. Since for 3-manifolds  $M, M'$ , we have that  $\pi_1(M \# M') \cong \pi_1(M) * \pi_1(M')$ , this implies in particular that non-prime 3-manifold groups have Property A.

Antolín–Minasyan–Sisto [AMS16] generalized the results of [MO10] to the case of acylindrically hyperbolic groups. By definition, acylindrically hyperbolic groups admit an acylindrical action on a hyperbolic space. From this action one can recover many hyperbolic-like properties of the group, and among these is Property A. In [MO15], Minasyan–Osin showed that the fundamental group of a closed 3-manifold is either acylindrically hyperbolic, Seifert-fibered, or virtually polycyclic. The class of acylindrically hyperbolic groups is disjoint from the other two classes and contains all non-prime 3-manifold groups as well as all those that have a non-trivial JSJ-decomposition but whose fundamental groups are not virtually polycyclic.

The precise definition of acylindrically hyperbolic will not be relevant for our purposes, but we refer the interested reader to [MO15] and the references therein for more details.

**Theorem 2.1** ([AMS16]). *If  $\pi_1(M)$  is acylindrically hyperbolic, then  $\pi_1(M)$  has Property A.*

Thus, the Seifert-fibered and virtually polycyclic cases remain. Allenby, Kim, and Tang [AKT03, AKT09] showed that if  $M$  is a Seifert-fibered 3-manifold whose base orbifold is not a sphere with precisely 3 cone points nor a torus with a single

cone point, then  $\pi_1(M)$  has Property A. The virtually polycyclic but not Seifert-fibered case consists of those closed 3-manifolds supporting Sol-geometry. Any such 3-manifold is either a torus bundle over the circle with Anosov monodromy or the result of gluing two twisted  $I$ -bundles together along their boundaries by an Anosov homeomorphism (see e.g. [AFW15]). We will refer to the former as an *Anosov bundle* and the latter as an *Anosov double*. We will prove Theorem 1.4 by demonstrating Property A holds for the remaining Seifert-fibered and Sol-manifold cases.

We first finish the proof of Property A in the Seifert-fibered case. Each Seifert-fibered 3-manifold fibers over a 2-dimensional orbifold. In many cases, Property A is already known to hold:

**Theorem 2.2** ([AKT03, AKT09]). *If  $G$  is a Seifert-fibered 3-manifold group whose base orbifold is not a sphere with precisely 3 cone points nor a torus with a single cone point, then  $G$  has Property A.*

It remains to prove Property A when the base orbifold is a sphere with 3 cone points or a torus with 1 cone point. For each of these, since the base is orientable, the 3-manifold group will be a central extension of the 2-dimensional orbifold group.

We will write  $S^2(p, q, r)$  to denote the 2-sphere with precisely three cone points of order  $p, q, r \geq 2$ , and  $T^2(n)$  to denote the torus with a single cone point of order  $n \geq 2$ . We will denote the corresponding groups by  $G_0(p, q, r)$  and  $G_1(n)$ , respectively. Recall that both  $G_1(n)$  and  $G_0(p, q, r)$  for  $p, q, r, n \geq 2$  are non-elementary, discrete subgroups of  $\text{Isom}^+(\mathbb{H}^2)$ , and thus have trivial center, no finite normal subgroups and the centralizer of every nontrivial element is cyclic. We thus reduce the proof of Property A for Seifert-fibered groups to the proof of Property A for 2-dimensional orbifolds via the following key lemma.

**Lemma 2.3.** *Let  $\Gamma$  be a group with center  $Z(\Gamma)$ . Suppose  $\Gamma/Z(\Gamma)$  has Property A, trivial center, and is generated by elements with cyclic centralizer. Then  $\Gamma$  has Property A.*

**Remark 2.4.** As a result of the above lemma, if  $\Gamma$  is a group with center  $Z(\Gamma)$  and  $G \leq Z(\Gamma)$ , such that  $\Gamma/G$  has Property A, trivial center, and is generated by elements with cyclic centralizer, then  $\Gamma$  has Property A. This follows since if  $G \leq Z(\Gamma)$  and  $\Gamma/G$  has trivial center then  $G = Z(\Gamma)$ .

*Proof of Lemma 2.3.* Let  $Z = Z(\Gamma)$  and let  $q : \Gamma \rightarrow \Gamma/Z$  be the quotient map. Choose elements  $x_1, \dots, x_n \in \Gamma$  such that  $q(x_1), \dots, q(x_n)$  generate  $\Gamma/Z$  and have cyclic centralizer.

Suppose  $\varphi : \Gamma \rightarrow \Gamma$  is class preserving. Clearly  $\varphi|_Z = \text{Id}$ . Thus,  $\varphi$  induces a class preserving automorphism  $\bar{\varphi} : \Gamma/Z \rightarrow \Gamma/Z$ . Since  $\Gamma/Z$  has Property A,  $\bar{\varphi}$  is inner, i.e.  $\bar{\varphi} = c_{\bar{g}}$  is conjugation by some  $\bar{g} \in \Gamma/Z$ . As  $\Gamma/Z$  has trivial center,  $\text{Inn}(\Gamma/Z) \cong \Gamma/Z \cong \text{Inn}(\Gamma)$ . Choose any  $g \in \Gamma$  such that  $q(g) = \bar{g}$ , and consider  $\psi = c_g^{-1} \circ \varphi$ . We know that  $\psi$  preserves every coset  $xZ$ ,  $x \in \Gamma$ , and acts by conjugation on  $x$  for each  $x \in \Gamma$ .

Fix  $i$ . Then we have  $\psi(x_i) = yx_iy^{-1} = x_iz$  for some  $z \in Z$  and some  $y \in \Gamma$ . Then  $[y, x_i] \in Z$ , hence  $q(y)$ ,  $q(x_i)$  commute. Because the centralizer of  $q(x_i)$  is cyclic,  $q(x_i)$  and  $q(y)$  are powers of the same element. It follows that  $y$  is in the centralizer of  $x_i$  in  $\Gamma$ . Thus,  $yx_iy^{-1} = x_i$ , and  $\psi|_{x_iZ} = \text{Id}$ . Since the  $q(x_i)$  generate  $\Gamma/Z$ , we conclude that  $\psi = \text{Id}$ , and that  $\varphi$  is inner.  $\square$

Recall that 2-dimensional orbifolds are divided into 3 classes: spherical, Euclidean and hyperbolic. For every  $n \geq 2$ ,  $T^2(n)$  is hyperbolic, but for the 2-sphere with 3 cone points we have the following trichotomy (see [Sco83])

$$S^2(p, q, r) \text{ is } \left\{ \begin{array}{l} \text{spherical} \\ \text{Euclidean} \\ \text{hyperbolic} \end{array} \right\} \text{ according as } \frac{1}{p} + \frac{1}{q} + \frac{1}{r} \text{ is } \left\{ \begin{array}{l} > \\ = \\ < \end{array} \right\} 1$$

For the spherical case, there is one infinite family and 3 exceptional cases, while for the Euclidean case there are only 3 cases. Everything else is hyperbolic:

- Spherical:  $(2, 2, n)$ ,  $n \geq 2$ ;  $(2, 3, 3)$ ;  $(2, 3, 4)$ ;  $(2, 3, 5)$ ;
- Euclidean:  $(2, 3, 6)$ ;  $(2, 4, 4)$ ;  $(3, 3, 3)$ ;
- hyperbolic: all others.

In order to deal with the hyperbolic orbifolds, we will rely on a result of Minasyan–Osin [MO10], concerning normal automorphisms of (relatively) hyperbolic groups. An automorphism  $\phi$  of a group  $G$  is normal if  $\phi(N) = N$  for every  $N \trianglelefteq G$ . Observe that every class preserving automorphism of  $G$  is normal since any normal subgroup of a group is a union of conjugacy classes. For (relatively) hyperbolic groups, we have the following strengthening of Property A.

**Theorem 2.5** ([MO10, Corollary 1.2(b)]). *Suppose  $G$  is a (relatively) hyperbolic group which is non-cyclic and which does not contain any non-trivial finite normal subgroups. Then every normal automorphism of  $G$  is inner.*

Note that this result is subsumed by the results of [AMS16], but we only need (relative) hyperbolicity here. Using this theorem and Lemma 2.3 we deduce

**Proposition 2.6.** *If the base orbifold for a Seifert-fibered  $M$  is hyperbolic, then  $\pi_1(M)$  has Property A.*

*Proof.* By Theorem 2.2, the only remaining cases are when  $M$  fibers over  $T^2(n)$ ,  $n \geq 2$  or  $S^2(p, q, r)$  with  $\frac{1}{p} + \frac{1}{q} + \frac{1}{r} < 1$ . Each of these base spaces is orientable, hence  $\pi_1(M)$  is a central extension of either  $G_1(n)$  or  $G_0(p, q, r)$  by  $\mathbb{Z}$ .

As noted earlier, both  $G_1(n)$  and  $G_0(p, q, r)$  are nonelementary, discrete subgroups of  $\text{Isom}^+(\mathbb{H}^2)$ , and so have trivial center, no finite normal subgroups and the centralizer of every nontrivial element is cyclic. By Theorem 2.5, both  $G_1(n)$  and  $G_0(p, q, r)$  have Property A. Hence,  $\pi_1(M)$  verifies the hypotheses of Lemma 2.3, so we conclude that  $\pi_1(M)$  has Property A, as desired.  $\square$

It remains to prove Property A for the spherical and Euclidean cases, each of which corresponds to a sphere with 3 cone points. We refer the reader to [Mag74, Chapter II.4] for the basic facts about triangle groups and their index two counterparts, von Dyck groups, that we will use here. The latter are the orbifold fundamental groups of spheres with 3 cone points. The presentation of such a group is

$$(1) \quad G_0(p, q, r) = \langle x, y, z \mid x^p = y^q = z^r = xyz = 1 \rangle.$$

**Proposition 2.7.** *If the base orbifold for a Seifert-fibered  $M$  is Euclidean, then  $\pi_1(M)$  has Property A.*

*Proof.* By Theorem 2.2, the only remaining case is when  $M$  fibers over a Euclidean  $S^2(p, q, r)$ . Since  $S^2(p, q, r)$  is orientable,  $\pi_1(M)$  is a central extension of  $G_0(p, q, r)$



by  $\mathbb{Z}$ . Further, the group  $G_0(p, q, r)$  is an index 2 subgroup of the corresponding triangle group, and acts faithfully on the tessellation of  $\mathbb{R}^2$  by triangles with angles  $(\frac{\pi}{p}, \frac{\pi}{q}, \frac{\pi}{r})$ . We will exploit this action to verify the hypotheses of Lemma 2.3. The generators  $x$ ,  $y$ , and  $z$  appearing in the presentation (1) act by counterclockwise rotations by  $\frac{2\pi}{p}$ ,  $\frac{2\pi}{q}$ , and  $\frac{2\pi}{r}$  respectively about the three vertices of a fixed triangle in the tessellation. The sphere  $S^2(p, q, r)$  is the union of two triangles in the tessellation with angles  $(\frac{\pi}{p}, \frac{\pi}{q}, \frac{\pi}{r})$  and thus a fundamental domain for the action is the union of any two triangles that share an edge.

$G_0(p, q, r)$  is a discrete subgroup of  $\text{Isom}^+(\mathbb{R}^2) = \mathbb{R}^2 \rtimes \text{SO}(2)$ , and every finite subgroup therefore injects under the projection  $G_0(p, q, r) \rightarrow \text{SO}(2)$ . Each finite subgroup is therefore cyclic and stabilizes some vertex in the tessellation. The fact that there are 3 orbits of vertices now implies that there are exactly 3 conjugacy classes of maximal, finite cyclic subgroups. Observe that if two elements commute then they have the same fixed set. It follows that  $G_0(p, q, r)$  has trivial center and that the centralizers of the the three generators are cyclic. Thus,  $\pi_1(M)$  satisfies two of the hypotheses of Lemma 2.3, hence to prove  $\pi_1(M)$  has Property A it suffices to show that  $G_0(p, q, r)$  has Property A.

If we identify  $\mathbb{R}^2$  with  $\mathbb{C}$ , in each case the vertices will be the points of a lattice  $\Lambda \subset \mathbb{C}$ , and each element of  $G_0(p, q, r)$  can be thought of as an affine transformation of the form  $z \mapsto az + b$ , where  $a, b \in \mathbb{C}$  and  $a\bar{a} = 1$ .

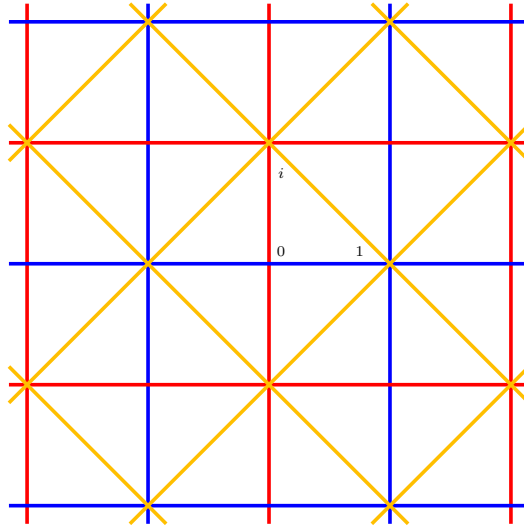

FIGURE 3. The tessellation of  $\mathbb{R}^2$  by  $(\frac{\pi}{2}, \frac{\pi}{4}, \frac{\pi}{4})$ -triangles.

**(2,4,4):** In this case  $\Lambda = \mathbb{Z}[i]$ , and we choose our base triangle to be the one with vertices  $0$ ,  $1$ ,  $i$ . See Figure 3. The generators are then given by rotations about  $0$ ,  $1$ , and  $i$ , respectively. They have the form

$$\begin{aligned} T_0 & : z \mapsto -z \\ T_1 & : z \mapsto i(z - 1) + 1 = iz + (1 - i) \\ T_i & : z \mapsto i(z - i) + i = iz + (1 + i) \end{aligned}$$

Suppose  $\phi : G_0(2, 4, 4) \rightarrow G_0(2, 4, 4)$  is class preserving. After post-composing with an inner automorphism, we may assume that  $\phi(T_0) = T_0$ . Since  $\phi(T_1)$  is conjugate to  $T_1$ ,  $\phi(T_1)$  is a counterclockwise rotation by  $\frac{\pi}{2}$  at another vertex in the orbit of the point 1. The orbit of 1 is all of the points with  $x$  coordinate odd and  $y$  coordinate even, i.e., all of the points of the form  $(2a + 1) + (2b)i$  for some  $a, b \in \mathbb{Z}$ . We can thus assume that

$$\phi(T_1): z \mapsto iz + (2a + 2b + 1) + (2b - 2a - 1)i.$$

Similarly,  $\phi(T_i)$  is a counterclockwise rotation by  $\frac{\pi}{2}$  at another vertex in the orbit of the point  $i$ , which are all the points of the form  $(2c) + (2d + 1)i$  for some  $c, d \in \mathbb{Z}$ . Hence

$$\phi(T_i): z \mapsto iz + (2c + 2d + 1) + (2d - 2c + 1)i.$$

The fact that  $\phi$  is an automorphism means that

$$\phi(T_0) \circ \phi(T_1) \circ \phi(T_i) = T_0 \circ \phi(T_1) \circ \phi(T_i) = \text{Id}.$$

Since  $T_0^{-1} = T_0$ , we therefore must have

$$\begin{aligned} -z &= \phi(T_1) \circ \phi(T_i)(z) \\ &= \phi(T_1)(iz + (2c + 2d + 1) + (2d - 2c + 1)i) \\ &= i((iz + (2c + 2d + 1) + (2d - 2c + 1)i)) + (2a + 2b + 1) + (2b - 2a - 1)i \\ &= -z + (2a + 2b + 1 - 2d + 2c - 1) + (2c + 2d + 1 + 2b - 2a - 1)i \\ &= -z + 2(a + b - d + c) + 2i(c + d + b - a) \end{aligned}$$

We thus obtain that

$$\begin{aligned} a + b - d + c &= 0 \\ c + d + b - a &= 0 \end{aligned}$$

It follows that  $d = a$  and  $c = -b$ . Substituting, we see that  $\phi(T_i)$  is a rotation about the point  $(-2b, 2a + 1)$ . The points  $(0, 0)$ ,  $(2a + 1, 2b)$ ,  $(-2b, 2a + 1)$  are the vertices of an isosceles right triangle which is one half of a fundamental domain for the action of  $T_0$ ,  $\phi(T_1)$ ,  $\phi(T_i)$  on  $\mathbb{R}^2$ . The ratio of the area of this triangle to the one with vertices 0, 1, and  $i$  is the index of  $\langle T_0, \phi(T_1), \phi(T_i) \rangle$ . Since  $T_0$ ,  $\phi(T_1)$ ,  $\phi(T_i)$  generate the whole group, the only way this triangle can have area equal to  $\frac{1}{2}$  is if  $a = 0$ ,  $b = 0$  or  $a = -1$ ,  $b = 0$ . In the first case,  $\phi$  is the identity. In the second case,  $\phi$  is conjugation by  $T_0$ . Hence  $\phi$  is inner, as desired.

**(3,3,3):** In this case  $\Lambda = \mathbb{Z}[\omega]$ , where  $\omega = e^{\frac{\pi i}{3}}$  and we choose our base triangle to be the one with vertices 0, 1,  $\omega$ . See Figure 4. Recall that  $\omega$  satisfies  $\omega^2 - \omega + 1 = 0$  and thus  $\omega^3 = -1$ . The generators are

$$\begin{aligned} T_0 &: z \mapsto \omega^2 z \\ T_1 &: z \mapsto \omega^2(z - 1) + 1 = \omega^2 z + (1 - \omega^2) = \omega^2 z + (2 - \omega) \\ T_\omega &: z \mapsto \omega^2(z - \omega) + \omega = \omega^2 z + (1 + \omega) \end{aligned}$$

Suppose  $\phi$  is class preserving. After post-composing with an inner-automorphism, we may assume that  $\phi(T_0) = T_0$ . The lattice points in the orbit of 1 are all the points of the form  $a + b\omega$ , such that  $a + 2b \equiv 1 \pmod{3}$ , and the lattice points in the orbit of  $\omega$  are all the points of the form  $c + d\omega$ , such that  $c + 2d \equiv 2 \pmod{3}$ . Since  $\phi(T_1)$

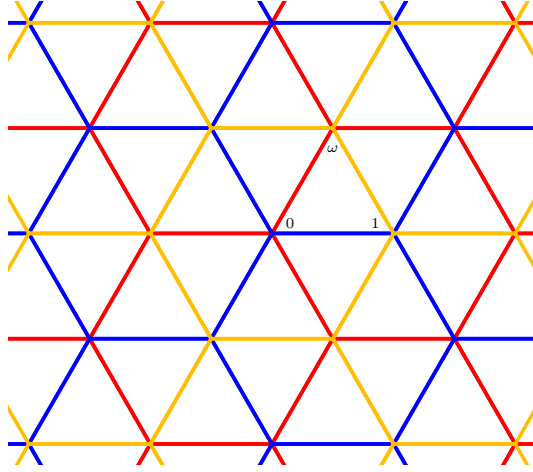
FIGURE 4. The tessellation of  $\mathbb{R}^2$  by  $(\frac{\pi}{3}, \frac{\pi}{3}, \frac{\pi}{3})$ -triangles.

is conjugate to  $T_1$ ,  $\phi(T_1)$  is a counterclockwise rotation by  $\frac{2\pi}{3}$  at another vertex in the orbit of the point 1. We can thus assume that

$$\phi(T_1): z \mapsto \omega^2 z + (2a + b) + (b - a)\omega.$$

Similarly,  $\phi(T_\omega)$  is a counterclockwise rotation by  $\frac{2\pi}{3}$  at another vertex in the orbit of the point  $\omega$ , hence has the form

$$\phi(T_\omega): z \mapsto \omega^2 z + (2c + d) + (d - c)\omega$$

The fact that  $\phi$  is an automorphism means that

$$\phi(T_0) \circ \phi(T_1) \circ \phi(T_\omega) = T_0 \circ \phi(T_1) \circ \phi(T_\omega) = \text{Id}.$$

Since  $T_0^{-1}(z) = \omega^4 z$ , we must have an equality

$$\begin{aligned} \omega^4 z &= \phi(T_1) \circ \phi(T_\omega)(z) \\ &= \phi(T_1)(\omega^2 z + (2c + d) + (d - c)\omega) \\ &= \omega^2(\omega^2 z + (2c + d) + (d - c)\omega) + (2a + b) + (b - a)\omega \\ &= \omega^4 z + \omega^2(2c + d) + (d - c)\omega^3 + (2a + b) + (b - a)\omega \\ &= \omega^4 z + (\omega - 1)(2c + d) - (d - c) + (2a + b) + (b - a)\omega \\ &= \omega^4 z + (2a + b - c - 2d) + (2c + d + b - a)\omega \end{aligned}$$

We thus obtain that

$$\begin{aligned} 2a + b - c - 2d &= 0 \\ 2c + d + b - a &= 0 \end{aligned}$$

It follows that  $d = a + b$  and  $c = -b$ . The points  $0, a + b\omega, (a + b) - b\omega$  form the vertices of an equilateral triangle which is one half the fundamental domain for the action of  $T_0, \phi(T_1), \phi(T_\omega)$  on  $\mathbb{R}^2$ . The only way this triangle can have area equal to  $\frac{1}{2}$  is if  $a = 1, b = 0, a = 1, b = -1$  or  $a = 0, b = -1$ . But then  $\phi$  is the identity, conjugation by  $T_0$ , or conjugation by  $T_0^2$ , respectively.

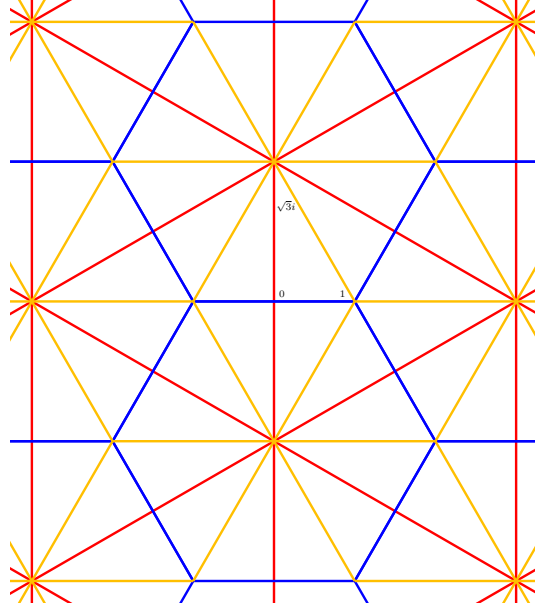

FIGURE 5. The tessellation of  $\mathbb{R}^2$  by  $(\frac{\pi}{2}, \frac{\pi}{3}, \frac{\pi}{6})$ -triangles.

**(2,3,6):** In this case the vertices of the triangle are at  $0$ ,  $1$  and  $i\sqrt{3}$ , as in Figure 5. The generators are the rotation  $T_0$  by  $\pi$  at  $0$ , the rotation  $T_1$  by  $\frac{2\pi}{3}$  at  $1$  and the rotation  $T_{i\sqrt{3}}$  by  $\frac{\pi}{3}$  at  $i\sqrt{3}$ , all counterclockwise.

As in the previous cases, given a class preserving automorphism  $\phi$ , we can assume after postcomposing with an inner automorphism that  $\phi(T_0) = T_0$ .  $\phi(T_1), \phi(T_{i\sqrt{3}})$  are rotations about some other vertices in the orbit of  $1$  and  $i\sqrt{3}$ , respectively. We let  $\xi = e^{\frac{\pi i}{6}}$ , a  $12^{\text{th}}$  root of unity. Then  $\xi^2 = \omega$  is a  $6^{\text{th}}$  root of unity. The points in the orbit of  $1$  are all of the form  $\pm 1 + 2ai\sqrt{3} + 2b\xi$ , while those in the orbit of  $i\sqrt{3}$  are of the form  $(1 + 2c)i\sqrt{3} + 2d\xi$ , for some  $a, b, c, d \in \mathbb{Z}$ . We first consider the case  $1 + 2ai\sqrt{3} + 2b\xi$ , the other will be similar. As before, since  $T_0^{-1} = T_0$ , we have

$$\begin{aligned}
 -z &= \phi(T_1) \circ \phi(T_{i\sqrt{3}})(z) \\
 &= \phi(T_1)(\omega(z - (1 + 2c)i\sqrt{3} - 2d\xi) + (1 + 2c)i\sqrt{3} + 2d\xi) \\
 &= \omega^3(z - (1 + 2c)i\sqrt{3} - 2d\xi) + \omega^2((1 + 2c - 2a)i\sqrt{3} + (2d - 2b)\xi - 1) \\
 &\quad + 1 + 2ai\sqrt{3} + 2b\xi \\
 &= -z + 1 + (1 + 2a + 2c)i\sqrt{3} + (2b + 2d)\xi + (1 + 2c - 2a)i\sqrt{3}\omega^2 \\
 &\quad + (2d - 2b)\xi\omega^2 - \omega^2
 \end{aligned}$$

Using the relations  $i\sqrt{3} = \omega + \omega^2$ ,  $\xi^2 = \omega$ , and  $\xi^4 = \xi^2 - 1$ , we write this in terms of the basis  $1, \xi, \xi^2, \xi^3$ :

$$-z = -z + (4a - 4c) + 4b\xi + (6a + 2c)\xi^2 + (2d - 2b)\xi^3$$

Since  $1, \xi, \xi^2, \xi^3$  are linearly independent over  $\mathbb{Q}$ , all of their coefficients are zero and we conclude that  $a = c = 0$ ,  $b = d = 0$ . Therefore,  $\phi(T_0) = T_0$ ,  $\phi(T_1) = T_1$  and  $\phi(T_{i\sqrt{3}}) = T_{i\sqrt{3}}$  so  $\phi = \text{Id}$ , as desired. This concludes the proof for all 3 cases, and the proposition follows.  $\square$

Next, we turn to the spherical case.

**Proposition 2.8.** *If the base orbifold for a Seifert-fibered  $M$  is spherical, then  $\pi_1(M)$  has Property A.*

*Proof.* If the base orbifold is spherical, then  $M$  supports  $\mathbb{S}^3$ -geometry. Thus  $\pi_1(M)$  is a finite subgroup of  $\mathrm{SO}(4)$  which acts freely on  $\mathbb{S}^3$ . These are all of the form  $G \times \mathbb{Z}/k$  where  $k$  is coprime to  $|G|$ , and  $G$  is either trivial or on the following list (see [AFW15]):

- (1)  $Q_{8n} = \langle x, y \mid x^2 = (xy)^2 = y^{2n} \rangle, n \geq 1$
- (2)  $P_{48}, P_{120}$
- (3)  $D_{2^m(2n+1)} = \langle x, y \mid x^{2^m} = y^{2n+1} = 1, xyx^{-1} = y^{-1} \rangle, m \geq 2, n \geq 1$
- (4)  $P'_{8,3m} = \langle x, y, z \mid x^2 = (xy)^2 = y^2, zxz^{-1} = y, zyz^{-1} = xy, z^{3^m} = 1 \rangle, m \geq 1$

The groups  $P_{48}$  and  $P_{120}$  correspond to the orbifolds  $S^2(2, 3, 4)$  and  $S^2(2, 3, 5)$ , respectively. The groups are central  $\mathbb{Z}/2$ -extensions of  $S_4$  and  $A_5$ . The outer automorphism group of  $S_4$  is trivial and the outer automorphism group of  $A_5$  is  $\mathbb{Z}/2$  generated by conjugation by a transposition. There are two conjugacy classes of 5-cycles in  $A_5$  but only one in  $S_5$ . The non-trivial outer automorphism of  $A_5$  exchanges these two, hence is not class preserving. Thus, both  $S_4$  and  $A_5$  have Property A. For  $n \geq 3$ ,  $A_n$  is generated by 3-cycles, and when  $n \leq 5$ , each of these has cyclic centralizer. To generate all of  $S_4$ , we add a 4-cycle, which also has cyclic centralizer. Since both  $S_4$  and  $A_5$  have trivial center, Lemma 2.3 applies, so we conclude that  $P_{48}$  and  $P_{120}$  also have Property A.

From the presentation of  $P'_{8,3m}$ , one can see that the subgroup generated by  $z^3$  is normal, and therefore there is a short exact sequence

$$1 \rightarrow \langle z^3 \rangle \rightarrow P'_{8,3m} \rightarrow A_4 \rightarrow 1$$

Since the center of  $A_4$  is trivial, it is easy to verify that  $z^3$  generates the center of  $P'_{8,3m}$ . The outer automorphism group of  $A_4$  is  $\mathbb{Z}/2$  generated by conjugation by a transposition in  $S_4$ . There are two conjugacy classes of 3-cycles in  $A_4$ , which are exchanged by this automorphism. Hence this automorphism is not class preserving and  $A_4$  has Property A. As in the  $A_5$  case,  $A_4$  is generated by 3-cycles, each of which have cyclic centralizer. We apply Lemma 2.3 again to obtain that  $P'_{8,3m}$  has Property A.

For any  $m \geq 2, n \geq 1$  and both  $Q_{8n}$  and  $D_{2^m(2n+1)}$ , the center is generated by  $x^2$ . For these we will prove Property A directly. From the relation  $x^2 = xyxy$  we obtain  $xyx^{-1} = y^{-1}$  for  $Q_{8n}$ , while this relation is explicit in the presentation of  $D_{2^m(2n+1)}$  above. Hence in each case the conjugacy classes for powers of  $y$  are exactly  $\{y^i, y^{2n-i}\} \mid 1 \leq i \leq n$  for  $Q_{8n}$  and  $\{y^j, y^{2n+1-j}\} \mid 1 \leq j \leq n$  for  $D_{2^m(2n+1)}$ . Let  $\phi : Q_{8n} \rightarrow Q_{8n}$  be class preserving. By composing  $\phi$  with a conjugation we may assume  $\phi(x) = x$ . Then  $\phi(y) = y$  or  $\phi(y) = y^{-1}$ ; either way  $\phi$  is inner. The case for  $D_{2^m(2n+1)}$  is completely analogous.

Finally, since abelian groups have Property A and Property A is closed under taking products, we conclude that  $\pi_1(M) = G \times \mathbb{Z}/k$  has Property A, where  $G$  is one of the groups on the list above. This completes the proof.  $\square$

Combining these results we obtain:

**Theorem 2.9.** *Let  $\Gamma$  be the fundamental group of an orientable Seifert-fibered 3-manifold. Then  $\Gamma$  has Property A.*

*Proof.* Let  $M$  be a Seifert-fibered manifold. Then  $M$  fibers over a hyperbolic, Euclidean, or spherical orbifold. Thus  $\pi_1(M)$  has Property A by one of Proposition 2.6, 2.7, or 2.8.  $\square$

We now prove Property A for  $M$  supporting Sol-geometry. Recall that in this case  $M$  is either an Anosov bundle or an Anosov double.

**Proposition 2.10.** *Let  $M$  be an Anosov bundle or an Anosov double. Then  $\pi_1(M)$  has Property A.*

*Proof.* Let  $\Gamma := \pi_1(M)$ . If  $M$  is an Anosov bundle then  $\Gamma$  fits into a short exact sequence

$$1 \rightarrow \mathbb{Z}^2 \rightarrow \Gamma \rightarrow \mathbb{Z} \rightarrow 1.$$

Since  $\mathbb{Z}$  is free the sequence splits and we can write  $\Gamma = \mathbb{Z}^2 \rtimes_A \mathbb{Z}$ , where the  $\mathbb{Z}$ -factor conjugates  $\mathbb{Z}^2$  by an Anosov matrix  $A \in \mathrm{SL}_2(\mathbb{Z})$ .

Let  $x, y$  be the standard basis elements generating  $\mathbb{Z}^2$  and  $t$  be the standard generator of  $\mathbb{Z}$ . Then  $x, y$  and  $t$  together generate  $\Gamma$  and we have  $txt^{-1} = Av$  for all  $v \in \mathbb{Z}^2$ . First observe that for any  $v, w \in \mathbb{Z}^2$ ,  $v$  is conjugate to  $w$  in  $\Gamma$  if and only if for some  $k \in \mathbb{Z}$  we have  $A^k(v) = w$ . Indeed, we have that  $t^kvt^{-k} = A^k(v)$ . Conversely, suppose that  $w = gvg^{-1}$  for some  $g \in \Gamma$ . Since  $\Gamma$  is a semi-direct product, we can write  $g = at^m$  for some  $a \in \mathbb{Z}^2$  and  $m \in \mathbb{Z}$ . Then

$$w = gvg^{-1} = a(t^mvt^{-m})a^{-1} = a(A^m(v))a^{-1} = a + A^m(v) - a = A^m(v),$$

where we have used the fact that  $a$  and  $A^m(v)$  commute since both lie in  $\mathbb{Z}^2$ .

Let  $\phi$  be a class preserving automorphism of  $\Gamma$ . Post-composing by conjugation by some element of  $\Gamma$  we may assume  $\phi(t) = t$ . Since  $\mathbb{Z}^2$  is normal, we know that  $\phi|_{\mathbb{Z}^2}$  can be represented by some matrix  $B \in \mathrm{GL}_2(\mathbb{Z})$ . *A priori*  $B$  sends  $x \mapsto A^kx$  for some  $k \in \mathbb{Z}$ , and by post-composing  $\phi$  with conjugation by  $t^{-k}$ , we can arrange that  $\phi(x) = x$  as well. Note that this does not change the fact that  $\phi(t) = t$ . Observe that  $A$  commutes with  $B$  since

$$B(Av) = \phi(Av) = \phi(txt^{-1}) = t(Bv)t^{-1} = A(Bv)$$

for each  $v \in \mathbb{Z}^2$ . In particular, we see that  $B(Ax) = Ax$ . In other words,  $B$  fixes both  $x$  and  $Ax$ . Since  $A$  is Anosov, it has two distinct and irrational eigenvectors. As  $x$  is integral,  $Ax$  cannot be a multiple of  $x$ . We now have that  $B$  fixes the two linearly independent vectors  $x, Ax \in \mathbb{Z}^2$ . This implies that  $B = I$  and that  $\phi = \mathrm{Id}$ , proving the proposition for Anosov bundles.

Suppose now  $M$  is an Anosov double with gluing map represented by

$$A = \begin{pmatrix} a & b \\ c & d \end{pmatrix} \in \mathrm{SL}_2(\mathbb{Z}).$$

By van Kampen's theorem, we get a presentation

$$\Gamma = \langle t_1, x_1, t_2, x_2 \mid t_1x_1t_1^{-1} = x_1^{-1}, t_2x_2t_2^{-1} = x_2^{-1}, t_1^2 = (t_2^2)^a x_2^c, x_1 = (t_2^2)^b x_2^d \rangle$$

The first two relations correspond to the two twisted  $I$ -bundles, each of whose fundamental group is that of the Klein bottle. The boundary tori are generated by

$\langle t_1^2, x_1 \rangle$  and  $\langle t_2^2, x_2 \rangle$ , which are then identified by  $A$ , giving the last two relations. Since  $\mathbb{Z}^2 = \langle t_1^2, x_1 \rangle = \langle t_2^2, x_2 \rangle$  is normal,  $\Gamma$  fits into a short exact sequence:

$$1 \rightarrow \mathbb{Z}^2 \rightarrow \Gamma \rightarrow \mathbb{Z}/2 * \mathbb{Z}/2 \rightarrow 1$$

where the  $t_i$ ,  $i = 1, 2$  map to the two generators of the  $\mathbb{Z}/2$  factors. As the quotient is a free product, in order to determine the conjugation action on the kernel, it is enough to know how  $t_1$  and  $t_2$  act. If we take  $\{t_1^2, x_1\}$  as a basis for  $\mathbb{Z}^2$ , then clearly  $t_1$  acts via the matrix

$$B_1 = \begin{pmatrix} 1 & 0 \\ 0 & -1 \end{pmatrix}$$

while  $t_2$  acts via the matrix  $B_2 = A^{-1}B_1A$ .

Let  $\phi$  be a class preserving automorphism of  $\Gamma$ . Since  $\mathbb{Z}^2$  is normal,  $\phi(\mathbb{Z}^2) = \mathbb{Z}^2$ . Thus,  $\phi$  induces a class preserving automorphism  $\bar{\phi}$  of  $\mathbb{Z}/2 * \mathbb{Z}/2$ . The latter, being a non-trivial free product, has Property A by the result of [Nes96]. After conjugating  $\Gamma$  by an alternating word in  $\{t_1, t_2\}$ , possibly followed by a power of  $x_1$ , we can assume that  $\bar{\phi} = \text{Id}$  and that  $\phi(t_1) = t_1$ . Now  $\phi|_{\mathbb{Z}^2}$  can be represented by a matrix  $C \in \text{GL}_2(\mathbb{Z})$  that commutes with both  $B_1$  and  $B_2$ . A straightforward calculation shows that the centralizer  $C(B_1)$  of  $B_1$  is given by the four diagonal matrices:

$$\begin{pmatrix} \pm 1 & 0 \\ 0 & \pm 1 \end{pmatrix}.$$

Thus,  $C(B_2) = A^{-1}C(B_1)A$ . Clearly  $B_1$  is not conjugate to  $\pm I$ , and another straightforward calculation shows that if  $MB_1M^{-1} = -B_1$  then  $M$  is one of the four matrices:

$$\begin{pmatrix} 0 & \pm 1 \\ \pm 1 & 0 \end{pmatrix}.$$

Since  $A$  is Anosov,  $|\text{tr}(A)| > 2$  so  $A$  is not among these eight matrices. It follows that the intersection of the centralizers of  $B_1$  and  $B_2$  is just  $\{\pm I\}$ . On the other hand, the fact that  $\phi(t_1) = t_1$  implies that  $\phi(t_1^2) = t_1^2$ . Hence,  $C$  must be the identity so  $\phi(x_1) = x_1$ ,  $\phi(x_2) = x_2$  and  $\phi(t_2^2) = t_2^2$ . From the last equality we conclude that  $\phi(t_2) = t_2$  as well. As  $\phi$  fixes a generating set, it must be the identity.  $\square$

We are now ready to prove Theorem 1.4:

*Proof of Theorem 1.4.* By [MO15, Corollary 2.9], either  $\pi_1(M)$  is acylindrically hyperbolic, Seifert-fibered or virtually polycyclic. If  $\pi_1(M)$  is acylindrically hyperbolic then  $\pi_1(M)$  has Property A by Theorem 2.1. If  $M$  is Seifert-fibered, then  $\pi_1(M)$  has Property A by Theorem 2.9. If  $\pi_1(M)$  is virtually polycyclic and not Seifert-fibered then  $M$  is either an Anosov bundle or an Anosov double. Hence,  $\pi_1(M)$  has Property A by Proposition 2.10.  $\square$

### 3. PROOF OF THEOREM 1.2

Let  $M$  be a closed, orientable 3-manifold. We will consider the following groups of self-maps of  $M$ , and the various relationships between them:

- $\text{Homeo}(M)$ : the group of self-homeomorphisms of  $M$ , endowed with the compact open topology.

- $\text{Homeo}_0(M)$ : the group of self-homeomorphisms of  $M$  which are *isotopic* to the identity. This is identified with the identity component of  $\text{Homeo}(M)$  and inherits the subspace topology.
- $\text{HE}(M)$ : the group of self-homotopy equivalences of  $M$ , endowed with the compact open topology.
- $\text{HE}_0(M)$ : the group of self-homotopy equivalences of  $M$  *homotopic* to the identity. This is identified with the identity component of  $\text{HE}(M)$  and inherits the subspace topology.

The identity component  $\text{Homeo}_0(M)$  is a normal subgroup of  $\text{Homeo}(M)$ , and the quotient is the group of connected components  $\pi_0(\text{Homeo}(M))$  or the *full mapping class group* of  $M$ , which we will denote by  $\text{Mod}(M)$ . Similarly, when we quotient  $\text{HE}(M)$  by  $\text{HE}_0(M)$  we get  $\pi_0(\text{HE}(M))$ , which we call the *homotopy mapping class group* of  $M$  and denote by  $\text{HMod}(M)$ . The inclusion homomorphisms  $\text{Homeo}(M) \rightarrow \text{HE}(M)$  and  $\text{Homeo}_0(M) \rightarrow \text{HE}_0(M)$  induce the following commutative diagram.

$$\begin{array}{ccccccc}
1 & \longrightarrow & \text{Homeo}_0(M) & \longrightarrow & \text{Homeo}(M) & \longrightarrow & \text{Mod}(M) \longrightarrow 1 \\
& & \downarrow & & \downarrow & & \downarrow \\
1 & \longrightarrow & \text{HE}_0(M) & \longrightarrow & \text{HE}(M) & \longrightarrow & \text{HMod}(M) \longrightarrow 1
\end{array}$$

For any connected manifold  $M$ , homeomorphism  $f: M \rightarrow M$ , and point  $p \in M$ , we get an associated automorphism  $\phi_\gamma \circ f_* \in \text{Aut}(\pi_1(M, p))$  where  $\phi_\gamma: \pi_1(M, f(p)) \rightarrow \pi_1(M, p)$  corresponds to conjugation with a path  $\gamma$  from  $p$  to  $f(p)$ . This descends to a well defined map  $\text{Homeo}(M) \rightarrow \text{Out}(\pi_1(M))$ .

Since homotopic homeomorphisms induce the same map on fundamental groups up to conjugacy, and since homeomorphisms isotopic to the identity induce the identity automorphism, modulo inner automorphisms, we have a factorization

$$\begin{array}{ccccc}
\text{Homeo}(M) & \longrightarrow & \text{Mod}(M) & & \\
\downarrow & & \downarrow & \searrow & \\
\text{HE}(M) & \longrightarrow & \text{HMod}(M) & \longrightarrow & \text{Out}(\pi_1(M))
\end{array}$$

The following is a summary of the work of many authors, referring to the maps in the above diagram. For more details, see [HM13, Section 3].

**Theorem 3.1.** *Let  $M$  be an irreducible, closed, oriented 3-manifold. Then*

- (1) *If  $M \neq S^3, \mathbb{R}P^3$ , then  $\text{Mod}(M)$  injects into  $\text{Out}(\pi_1(M))$ .*
- (2) *If  $M = S^3$  or  $\mathbb{R}P^3$ , then  $\text{Mod}(M) \cong \text{HMod}(M) \cong \mathbb{Z}/2$ .*

*In either case,  $\text{Mod}^+(M) \hookrightarrow \text{Out}(\pi_1(M))$ .*

*Proof.* If  $\Gamma = \pi_1(M)$  is finite, then by geometrization  $M$  is finitely covered by  $S^3$  [Per02, Per03a, Per03b]. If  $M \neq S^3, \mathbb{R}P^3$ , then  $\text{Mod}(M)$  injects into  $\text{Out}(\Gamma)$  [McC02]. When  $M = S^3$  or  $\mathbb{R}P^3$  then  $\text{Out}(\Gamma)$  is trivial, and a theorem of Fisher [Fis60] in the case of  $S^3$  (see also [Cer68]) and Bonahon [Bon83] in the case of  $\mathbb{R}P^3$  implies that  $\text{Mod}(M) \cong \text{HMod}(M) \cong \mathbb{Z}/2$ , generated by an orientation reversing homeomorphism. This gives result (2). Additionally,  $\text{Mod}^+(M)$  is trivial and thus injects into  $\text{Out}(\Gamma)$ .



If  $M$  is irreducible and  $\Gamma$  is infinite, then  $M$  is aspherical, hence  $\text{HMod}(M) \cong \text{Out}(\Gamma)$ . There are two cases to consider, when  $M$  is Haken and when  $M$  is non-Haken. If  $M$  is Haken, a well-known theorem of Waldhausen [Wal68] implies that any homotopy equivalence is homotopic to a homeomorphism, and that any two homotopic homeomorphisms are isotopic. This implies that  $\text{Mod}(M) \cong \text{HMod}(M)$ , proving (1) in this case.

When  $M$  is non-Haken, it is either hyperbolic or Seifert-fibered over  $S^2$  with 3 exceptional fibers. Gabai–Meyerhoff–Thurston [GMT03] showed that  $\text{Mod}(M) \cong \text{HMod}(M)$ ; hence (1) holds for non-Haken hyperbolic 3-manifolds. In the non-Haken Seifert-fibered case, work of Scott [Sco85] and Boileau–Otal [BO91] proved that  $\text{Mod}(M) \cong \text{HMod}(M)$  and that  $\text{Mod}(M)$  injects into  $\text{Out}(\Gamma)$ , proving (1).

For the final statement when  $M \neq S^3, \mathbb{R}P^3$ , note that either  $\text{Mod}^+(M)$  is an index two subgroup of  $\text{Mod}(M)$  if  $M$  admits an orientation reversing self-homeomorphism, or equal to  $\text{Mod}(M)$  otherwise. In either case, we see that  $\text{Mod}^+(M) \hookrightarrow \text{Out}(\Gamma)$ .  $\square$

We now use Theorem 1.4 and Theorem 3.1 to prove Theorem 1.2.

**Theorem 1.2.** *Let  $M$  be an irreducible, closed, oriented 3-manifold. If an orientation preserving homeomorphism  $f: M \rightarrow M$  preserves free homotopy classes of loops, that is, for any loop  $\gamma \subset M$  the loop  $f(\gamma)$  is freely homotopic to  $\gamma$ , then  $f$  is isotopic to the identity.*

*Proof.* Let  $M$  be an irreducible, closed, oriented 3-manifold, and let  $\Gamma = \pi_1(M)$ . Suppose  $f$  is an orientation preserving homeomorphism of  $M$  which preserves free homotopy classes of loops, and denote by  $\bar{f} \in \text{Mod}(M)$  the isotopy class of  $f$ . Since  $f$  preserves free homotopy classes of loops, it induces a class preserving element of  $\text{Out}(\pi_1(M))$ . By Theorem 1.4 this induced map is an inner automorphism and thus trivial in  $\text{Out}(\pi_1(M))$ . By Theorem 3.1, we know that  $\text{Mod}^+(M) \hookrightarrow \text{Out}(\pi_1(M))$  and thus  $\bar{f}$  is trivial in  $\text{Mod}^+(M)$ , as needed.  $\square$

#### 4. THE GLUCK TWIST ON KNOTS IN $S^1 \times S^2$ WITH ODD WINDING NUMBER

We now turn our attention to the effect of the Gluck twist on knots in  $S^1 \times S^2$ . Recall that the winding number of a knot  $K \subset S^1 \times S^2$  is the algebraic intersection number of  $K$  and  $\{pt\} \times S^2$ .

In order to consistently draw pictures of knots in  $S^1 \times S^2$  we introduce some notation. Let  $U$  be the standard unknot in  $S^3$  and  $D$  be a knot in  $S^3 \setminus U$ . Performing 0-framed Dehn surgery on  $S^3$  along  $U$  results in  $S^1 \times S^2$ . If the image of  $D$  is isotopic to  $K$  in  $S^1 \times S^2$  then we will say that  $D$  is a *diagram* for  $K$ . We will denote by  $m_D$  the meridian of  $D$  and by  $h_D$ , the meridian of  $U$  (see Figure 6).

Note that  $D$  and  $D'$  are diagrams for isotopic knots in  $S^1 \times S^2$  if and only if  $D$  and  $D'$  are related in  $S^3$  by a sequence of isotopies in the exterior of  $U$  and slides over the 0-framed knot  $U$ . We refer to the latter move as a *handleslide* for convenience, even though, technically speaking, it is an isotopy of the knot  $K$  in  $S^1 \times S^2$ . See Figure 7 for a depiction of positive and negative handleslides.

A framing of a knot  $K$  is an identification of a regular neighborhood  $\nu(K)$  with  $S^1 \times D^2$ . Equivalently, a framing is simply a choice of push-off  $K^+$  of  $K$ . Given a choice of diagram  $D$  for  $K$  and an integer  $f$ , the  *$f$ -framing of  $K$  with respect to  $D$*  is specified by taking the  $f$ -framing on  $D$ . In other words the  $f$ -framing is

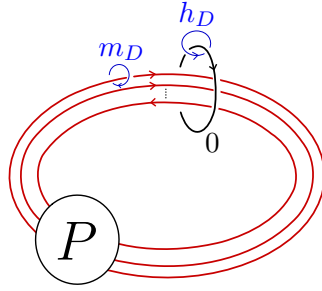

FIGURE 6. A diagram  $D$  of a knot  $K \subset S^1 \times S^2$  together with curves  $m_D$  and  $h_D$  forming a basis for the first homology of  $S^1 \times S^2 \setminus K$ .

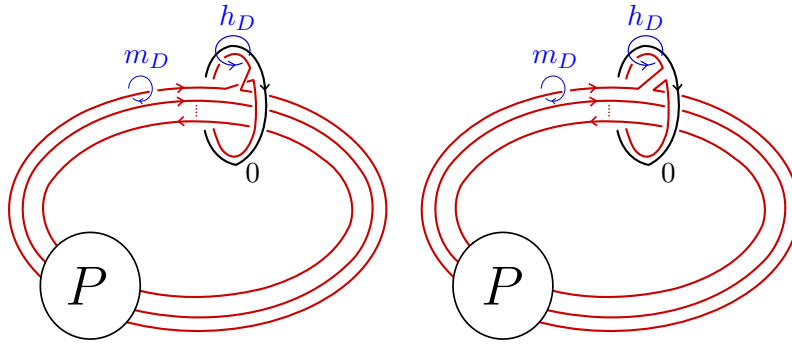

FIGURE 7. Positive (left) and negative (right) handleslides performed from  $D$  together with the image of  $m_D$  and  $h_D$  after the handleslides. To make sense of positive vs negative, observe that if  $w$  is the winding number of  $D$  then the positive orientation of  $U$  has linking number  $w$  with  $D$  while the negative orientation has linking number  $-w$ .

given by the push-off  $D^+$  so that the linking number  $\text{lk}(D, D^+) = f$ , where the latter is computed in  $S^3$ . Note that this really does depend on the choice of  $D$ , as a handleslide changes  $f$  (see Figure 8), but we avoid this by fixing a diagram of a knot. Let  $M(D, f)$  denote the 3-manifold obtained by modifying  $S^1 \times S^2$  by  $f$ -framed surgery along  $D$  where  $D$  is a diagram for  $K$ . Explicitly, this is the 3-manifold obtained by performing  $(0, f)$  framed surgery on  $S^3$  along the 2-component link  $(U, D)$ . For simplicity, we still use the letters  $m_D$  and  $h_D$  to denote the images of these curves in the surgered manifold.

**Proposition 4.1.** *Let  $K$  be a knot in  $S^1 \times S^2$  with winding number  $w$  and  $D$  be a diagram of  $K$ . Suppose  $\tilde{D}$  is the diagram of  $\mathcal{G}(K)$  obtained from  $D$  by adding a full positive twist. Suppose that  $D$  can be obtained from  $\tilde{D}$  by a sequence of isotopies in the exterior of  $U$ ,  $k_+$  positive handleslides, and  $k_-$  negative handleslides. Let  $k = k_+ - k_-$ .*

*Then for any integer  $f$ , there is a self-homeomorphism of  $S^1 \times S^2$  taking the  $f$ -framing of  $D$  to the  $(f + w^2 + 2kw)$ -framing of  $D$ .*

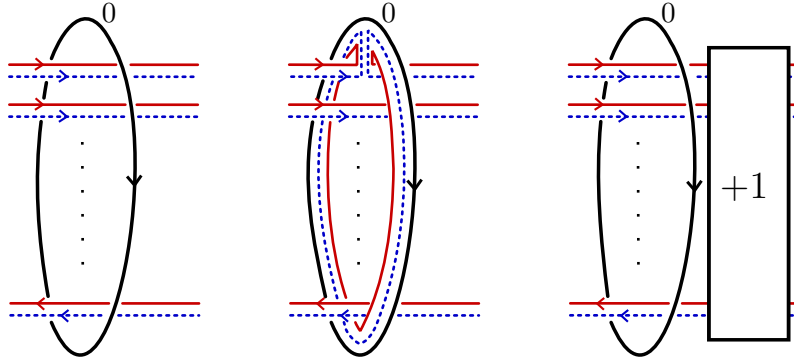

FIGURE 8. Left: The push-off (blue, dashed) corresponding to the  $f$ -framing on a diagram  $D$  (red, solid) for some knot  $K$  with winding number  $w$ . Center: The  $f$ -framed push-off is sent to the  $(f - 2w)$ -framed push-off of a diagram  $D'$  for  $K$  by a negative handleslide. Right: The  $f$ -framed push-off is sent to the  $(f + w^2)$ -framed push-off of a diagram  $\tilde{D}$  for  $\mathcal{G}(K)$  by the Gluck twist.

Consequently, for any integer  $f$ , there is a homeomorphism

$$\phi: M(D, f) \rightarrow M(D, f + w^2 + 2kw).$$

Moreover, we have that

$$\phi_*: H_1(M(D, f); \mathbb{Z}) \rightarrow H_1(M(D, f + w^2 + 2kw); \mathbb{Z})$$

is given by

$$\phi_*([m_D]) = [m_D] \text{ and } \phi_*([h_D]) = [h_D] + (w + k) \cdot [m_D].$$

*Proof.* As in the hypothesis, let  $D$  and  $\tilde{D}$  be diagrams of  $K$  and  $\mathcal{G}(K)$ , respectively, where  $\tilde{D}$  is obtained from  $D$  by adding a full positive twist. The far right panel of Figure 8 reveals that the Gluck twist sends the  $f$ -framing of  $K$  with respect to  $D$  to the  $(f + w^2)$ -framing of  $\mathcal{G}(K)$  with respect to  $\tilde{D}$ . Moreover, Figure 9 shows that  $\mathcal{G}$  sends  $m_D$  to  $m_{\tilde{D}}$  and sends the homology class  $[h_D]$  to  $[h_{\tilde{D}}] + w \cdot [m_{\tilde{D}}]$ .

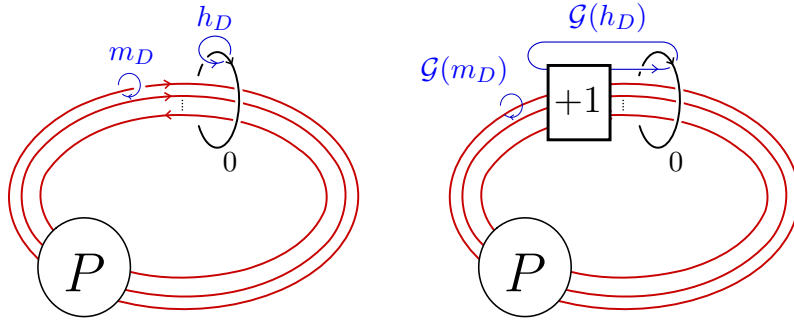

FIGURE 9. The Gluck twist together with the image of basis curves  $m_D$  and  $h_D$ .

Let  $D$  be a diagram for a knot  $K$  in  $S^1 \times S^2$ . Let  $D'$  be the result of modifying  $D$  by a negative handleslide. Figures 7 and 8 show that this handleslide sends the  $f$ -framing of  $K$  with respect to  $D$  to the  $(f - 2w)$ -framing of  $K$  with respect to the new diagram  $D'$ , sends the meridian  $m_D$  to the meridian  $m_{D'}$ , and sends the homology class  $[h_D]$  to  $[h_{D'}] - [m_{D'}]$ . If instead  $D'$  is the result of a positive handleslide, then the  $f$ -framing is sent to the  $(f + 2w)$ -framing,  $[m_D]$  is sent to  $[m_{D'}]$ , and  $[h_D]$  is sent to  $[h_{D'}] + [m_{D'}]$ . Naturally, isotopies of a diagram in the exterior of  $U$  do not change the framing.

By assumption, the diagram  $\tilde{D}$  can be changed to  $D$  by a sequence of isotopies in the exterior of  $U$ ,  $k_+$  positive handleslides, and  $k_-$  negative handleslides. Recall that  $k = k_+ - k_-$ . Composing  $\mathcal{G}$  with the homeomorphism of  $S^1 \times S^2$  induced by the claimed isotopy, we get the desired self-homeomorphism of  $S^1 \times S^2$  sending  $D$  to itself, and specifically the  $f$ -framing of  $D$  to the  $(f + w^2 + 2kw)$ -framing of  $D$ . By construction this map sends  $[m_D]$  to  $[m_D]$ , and sends  $[h_D]$  to  $[h_D] + (w + k) \cdot [m_D]$ . The desired map  $\phi$  is obtained by performing surgeries dictated by the framings.  $\square$

We now begin the proof of Theorem 1.5. In this section we address the case of odd winding numbers. The following is the goal of the remainder of this section.

**Proposition 4.2.** *Let  $K \subseteq S^1 \times S^2$  be a knot with winding number  $w$ . If  $K$  is isotopic to  $\mathcal{G}(K)$  then either  $w^2 + 2kw = 0$  for some  $k \in \mathbb{Z}$  or  $K$  is the Hopf knot or its reverse.*

The above will settle Theorem 1.5 for odd winding numbers since  $w^2 + 2kw = 0$  implies that  $w$  is even.

We will need the following definitions. A homeomorphism  $f$  of a compact 3-manifold  $M$  is said to be *Dehn twists on the boundary* if its restriction to the boundary  $\partial M$  is isotopic to the identity on the complement of a collection of disjoint simple closed curves in  $\partial M$ . If this collection is nonempty, and the restricted homeomorphism is not isotopic to the identity on the complement of any proper subset of the collection, then we say that  $f$  is Dehn twists *about* the collection. The restriction of  $f$  to  $\partial M$  is then isotopic to a composition of nontrivial (powers of) Dehn twists about the curves. We will use the following result of McCullough.

**Theorem 4.3** ([McC06, Theorem 1]). *Let  $M$  be a compact, orientable 3-manifold which admits a homeomorphism which is Dehn twists on the boundary about the collection  $C_1, \dots, C_n$  of simple closed curves in  $\partial M$ . Then for each  $i$ , either  $C_i$  bounds a disk in  $M$ , or for some  $j \neq i$ ,  $C_i$  and  $C_j$  cobound an incompressible annulus in  $M$ .*

*Proof of Proposition 4.2.* Let  $D$  be a diagram for a knot  $K \subset S^1 \times S^2$ . If  $K$  and  $\mathcal{G}(K)$  are isotopic then the diagram  $\tilde{D}$  obtained from  $D$  by adding a full positive twist is related to  $D$  by a sequence of isotopies in the exterior of  $U$  and handleslides over  $U$ . Then by Proposition 4.1, for any integer  $f$ , there is a self-homeomorphism of  $S^1 \times S^2$  taking the  $f$ -framing of  $D$  to the  $(f + w^2 + 2kw)$ -framing of  $D$ , where  $k$  is the algebraic count of handleslides needed to change  $\tilde{D}$  to  $D$ . By construction, this homeomorphism preserves a regular neighbourhood of  $D$ . On the boundary of this solid torus neighbourhood, the induced map is the identity if  $w^2 + 2kw = 0$  and the composition of  $w^2 + 2kw$  Dehn twists along  $m_D$  otherwise. By Theorem 4.3, if  $w^2 + 2kw \neq 0$ , then  $m_D$  bounds an embedded disk  $\Delta$  in  $S^1 \times S^2 \setminus \nu(K)$ . The union

of  $\Delta$  with a meridional disk for  $\nu(K)$  is a nonseparating sphere in  $S^1 \times S^2$  which intersects  $K$  precisely once, implying that  $K$  is the Hopf knot if this intersection is positive or is the reverse of the Hopf knot if it is negative.  $\square$

**Example 4.4.** While our paper is focused primarily on knots, our techniques may be applied to the study of links. We illustrate this principle now. Consider the diagram  $D$  of the  $n$ -component link  $L$  in  $S^1 \times S^2$ , consisting of the closure of the trivial  $n$ -strand braid (see Figure 10). Let  $M(D; f_1, f_2, \dots, f_n)$  denote the manifold obtained

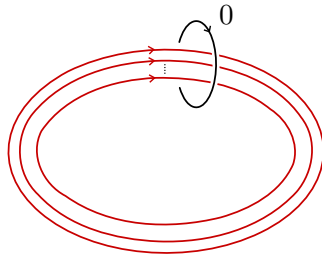

FIGURE 10. A diagram  $D$  of a link  $L$  in  $S^1 \times S^2$  obtained as the closure of the trivial  $n$ -strand braid.

by performing  $(f_1, f_2, \dots, f_n)$ -framed surgery on  $S^1 \times S^2$  along  $D$ , or more explicitly, by performing  $(0; f_1, f_2, \dots, f_n)$ -framed surgery on  $S^3$  along the link  $(U; L)$ . By the proof of Proposition 4.1 if the isotopy class of  $L$  is preserved under the Gluck twist, there is a homeomorphism  $M(D; 0, 0, \dots, 0) \cong M(D; 1 + 2x_1, 1 + 2x_2, \dots, 1 + 2x_n)$  for integers  $x_1, x_2, \dots, x_n \in \mathbb{Z}$ . By a sequence of handleslides, it is clear that  $M(D; 0, 0, \dots, 0) \cong \#_{n-1} S^1 \times S^2$ . On the other hand, the manifold  $M(D; 1 + 2x_1, 1 + 2x_2, \dots, 1 + 2x_n)$  is a Seifert-fibered space (see e.g. [NR78]). The only non-prime orientable Seifert-fibered space is  $\mathbb{R}P^3 \# \mathbb{R}P^3$  [AFW15, p. 9]. Thus for  $n \geq 3$ , the isotopy class of  $L$  is nontrivially altered by the Gluck twist. This completes the isotopy classification of closed surface braids by Grant-Sienicka [GS20] (see [GS20, Remark 1.4]).

## 5. EVEN WINDING NUMBERS

In this section, we show that for each positive even integer  $w$ , there exists a knot  $K$  with winding number  $w$  whose isotopy class is not preserved under the Gluck twist. This will complete the proof of Theorem 1.5 since the result of changing the orientation of any knot with winding number  $w$  has winding number  $-w$ .

First, we consider the case when  $w$  is greater than 2 and at the end of the section we deal with the winding number 2 case. For relatively prime integers  $p, q$ , we denote the  $(p, q)$  torus knot by  $T_{p,q}$ . As in Section 4, given a knot  $K$  in  $S^1 \times S^2$  and a diagram  $D$  for  $K$ , the meridian of  $K$  is denoted by  $m_D$  and the meridian of the unknotted surgery curve  $U$  is denoted by  $h_D$ .

**Lemma 5.1.** *Let  $K_w \subset S^1 \times S^2$  be the knot with diagram  $D_w$  and winding number  $w$  shown in Figure 11. If  $w$  is an even integer and  $K_w$  is isotopic to  $\mathcal{G}(K_w)$ , then there exists a homeomorphism*

$$\psi: S_{w^2}^3(T_{w,w+1}) \rightarrow S_{w^2}^3(T_{w,w+1}).$$

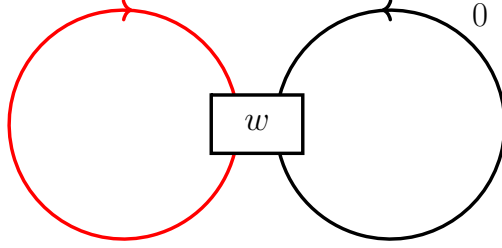

FIGURE 11. A diagram  $D_w$  for the knot  $K_w$ . The box containing  $w$  indicates  $w$  full right-handed twists.

Moreover, if  $\mu$  is the meridian of  $T_{w,w+1}$ , then

$$\psi_*: H_1(S_{w^2}^3(T_{w,w+1}); \mathbb{Z}) \rightarrow H_1(S_{w^2}^3(T_{w,w+1}); \mathbb{Z})$$

is given by

$$\psi_*([\mu]) = \left(\frac{w^2}{2} + 1\right) \cdot [\mu].$$

*Proof.* Suppose  $K_w$  is isotopic to  $\mathcal{G}(K_w)$  and let  $D_w$  be the diagram of  $K_w$  described in Figure 11. Then by Propositions 4.1 and 4.2, there is a homeomorphism

$$\phi: M(D_w, f) \rightarrow M(D_w, f)$$

for each  $f \in \mathbb{Z}$ , where

$$\phi_*: H_1(M(D_w, f); \mathbb{Z}) \rightarrow H_1(M(D_w, f); \mathbb{Z})$$

satisfies

$$\phi_*([m_{D_w}]) = [m_{D_w}] \text{ and } \phi_*([h_{D_w}]) = [h_{D_w}] + \frac{w}{2} \cdot [m_{D_w}].$$

Set  $f = -1$ . Now observe that we have a surgery description of  $M(D_w, -1)$  as the  $(-1, 0)$  framed surgery on  $S^3$  along the link  $(D_w, U)$  (see Figure 11). In particular, we may blow down  $D_w$  since it is an unknotted circle with framing  $-1$ . The second component is transformed into  $T_{w,w+1} \subset S^3$  with framing  $w^2$  (see, for example, [GS99, p. 150-151]).

To see the second statement, it suffices to note that we have the relation  $[m_{D_w}] = w[h_{D_w}]$  in  $H_1(M(D_w, -1); \mathbb{Z})$  and the curve  $h_{D_w}$  is mapped to  $\mu$  under the blowdown.  $\square$

In order to show that the homeomorphisms claimed in the above lemma do not exist, we use the Heegaard-Floer correction term  $d(M, \mathfrak{t}) \in \mathbb{Q}$  associated to a rational homology sphere  $M$  with a  $\text{Spin}^c$  structure  $\mathfrak{t}$  [OS03]. Recall that for any knot  $K$  in  $S^3$ , there is a non-increasing sequence of non-negative integers  $\{V_i(K)\}_{i \geq 0}$ , introduced by Rasmussen [Ras03]. Ni and Wu showed that the correction term of 3-manifolds obtained by surgeries on knots can be computed using this sequence [NW15]. Here we only state the formula for the integral surgery.

**Proposition 5.2** ([NW15, Proposition 1.6 and Remark 2.10]). *If  $n$  is a positive integer and  $U$  is the unknot, then for any knot  $K$ ,*

$$d(S_n^3(K), \mathfrak{t}_i) = d(S_n^3(U), \mathfrak{t}_i) - 2 \max\{V_i(K), V_{n-i}(K)\}.$$

Here we are using the identification  $\varphi: \text{Spin}^c(S_n^3(K)) \rightarrow \mathbb{Z}/n$  given in [OS11] so that the  $\text{Spin}^c$  structure that corresponds to  $i \in \mathbb{Z}/n$  under  $\varphi$  is denoted by  $\mathfrak{t}_i$ . We recall some facts about this identification (see [CH15, Appendix B]). A free transitive action by  $H^2(S_n^3(K); \mathbb{Z})$  on  $\text{Spin}^c(S_n^3(K))$ , denoted by  $\mathfrak{t} + x$  for  $x \in H^2(S_n^3(K); \mathbb{Z})$  and  $\mathfrak{t} \in \text{Spin}^c(S_n^3(K))$ , is given as follows

$$\mathfrak{t}_j = \mathfrak{t}_i + (j - i) \cdot PD[[\mu]],$$

where  $\mu$  is the positively oriented meridian of  $K$ . When  $n$  is even, the spin structures of  $S_n^3(K)$  are  $\mathfrak{t}_0$  and  $\mathfrak{t}_{\frac{n}{2}}$ . Moreover, the correction terms for lens spaces are computed in [OS03] for all  $\text{Spin}^c$  structures. In particular, we have the following.

**Proposition 5.3** ([OS03, Proposition 4.8]). *If  $n$  is a positive integer and  $U$  is the unknot, then*

$$d(S_n^3(U), \mathfrak{t}_i) = \frac{(n - 2i)^2}{4n} - \frac{1}{4}.$$

Recall that for the  $(p, q)$ -torus knot  $T_{p,q}$ , we can define the gap counting function  $I_{p,q}$  of the semigroup  $\Gamma_{p,q} = \langle p, q \rangle = \{ip + jq \mid i, j \geq 0\} \subset \mathbb{Z}_{\geq 0}$  as follows

$$I_{p,q}(j) = \#(\mathbb{Z}_{\geq j} \setminus \Gamma_{p,q}).$$

Borodzik and Livingston [BL14] proved that  $V_i$  of torus knots can be computed using the gap counting function.

**Proposition 5.4** ([BL14, Propositions 4.4 and 4.6]). *If  $p$  and  $q$  are coprime positive integers, then*

$$V_j(T_{p,q}) = I_{p,q} \left( j + \frac{(p-1)(q-1)}{2} \right).$$

Using the above proposition we get the following.

**Proposition 5.5.** *Let  $w$  be a positive even integer. If  $T_{w,w+1}$  is the  $(w, w+1)$ -torus knot, then*

$$V_0(T_{w,w+1}) = V_1(T_{w,w+1}) + 1 = \frac{w^2 + 2w}{8} \quad \text{and} \quad V_{\frac{w^2}{2}-1}(T_{w,w+1}) = V_{\frac{w^2}{2}}(T_{w,w+1}) = 0.$$

*Proof.* It is a routine computation to see that

$$\Gamma_{w,w+1} = \{i \cdot w + j \mid 0 \leq j \leq i \leq w - 2\} \cup \mathbb{Z}_{\geq w^2 - w}.$$

Combining the above equation and Proposition 5.4, we have

$$\begin{aligned}
V_0(T_{w,w+1}) &= I_{w,w+1} \left( \frac{w^2 - w}{2} \right) \\
&= \# \left( \mathbb{Z}_{\geq \frac{w^2 - w}{2}} \setminus \Gamma_{w,w+1} \right) \\
&= \# \left( \left\{ i \mid \frac{w^2 - w}{2} \leq i \leq w^2 - w - 1 \right\} \right. \\
&\quad \left. \setminus \left\{ i \cdot w + j \mid \frac{w}{2} \leq i \leq w - 2, 0 \leq j \leq i \right\} \right) \\
&= \frac{w^2 - w}{2} - \frac{3w^2 - 6w}{8} \\
&= \frac{w^2 + 2w}{8}.
\end{aligned}$$

Moreover, since

$$\frac{w-2}{2} \cdot w + \frac{w-2}{2} < \frac{w-1}{2} \cdot w < \frac{w}{2} \cdot w,$$

we see that  $\frac{w-1}{2} \cdot w \notin \Gamma_{w,w+1}$ . Hence we have

$$V_1(T_{w,w+1}) = I_{w,w+1} \left( 1 + \frac{w^2 - w}{2} \right) = \# \left( \mathbb{Z}_{\geq 1 + \frac{w^2 - w}{2}} \setminus \Gamma_{w,w+1} \right) = V_0(T_{w,w+1}) - 1.$$

Lastly, since  $w^2 - w \leq \frac{2w^2 - w - 2}{2}$ , we have  $\mathbb{Z}_{\geq \frac{2w^2 - w - 2}{2}} \subset \mathbb{Z}_{\geq w^2 - w} \subset \Gamma_{w,w+1}$  so that

$$V_{\frac{w^2}{2} - 1}(T_{w,w+1}) = \# \left( \mathbb{Z}_{\geq \frac{2w^2 - w - 2}{2}} \setminus \Gamma_{w,w+1} \right) = 0,$$

and since  $\{V_i(K)\}_{i \geq 0}$  is a non-increasing sequence of non-negative integers we also have  $V_{\frac{w^2}{2}}(T_{w,w+1}) = 0$ .  $\square$

Now we are ready to show that  $K_w$  and  $\mathcal{G}(K_w)$  are not isotopic whenever  $w$  is even and greater than 2.

**Proposition 5.6.** *Let  $K_w$  be the knot shown in Figure 11 with even winding number  $w > 2$ . Then  $K_w$  is not isotopic to  $\mathcal{G}(K_w)$ .*

*Proof.* Suppose that  $K_w$  is isotopic to  $\mathcal{G}(K_w)$  and  $w$  is even and greater than 2. By Lemma 5.1, there exists a homeomorphism

$$\psi: S_{w^2}^3(T_{w,w+1}) \rightarrow S_{\frac{w^2}{2}}^3(T_{w,w+1}),$$

such that  $\psi_*([\mu]) = \left(\frac{w^2}{2} + 1\right) \cdot [\mu]$ , where  $\mu$  is the meridian of  $T_{w,w+1}$ . Note that  $S_{w^2}^3(T_{w,w+1})$  has two spin structures,  $\mathfrak{t}_0$  and  $\mathfrak{t}_{\frac{w^2}{2}}$ , and using Propositions 5.2, 5.3,



and 5.5 we have

$$\begin{aligned}
d(S_{w^2}^3(T_{w,w+1}), \mathfrak{t}_0) &= d(S_{w^2}^3(U), \mathfrak{t}_0) - 2 \max\{V_0(T_{w,w+1}), V_{w^2}(T_{w,w+1})\} \\
&= d(S_{w^2}^3(U), \mathfrak{t}_0) - 2V_0(T_{w,w+1}) \\
&= \frac{w^4}{4w^2} - \frac{1}{4} - \frac{w^2 + 2w}{4} \\
&= -\frac{1 + 2w}{4},
\end{aligned}$$

and

$$\begin{aligned}
d(S_{w^2}^3(T_{w,w+1}), \mathfrak{t}_{\frac{w^2}{2}}) &= d(S_{w^2}^3(U), \mathfrak{t}_{\frac{w^2}{2}}) - 2V_{\frac{w^2}{2}}(T_{w,w+1}) \\
&= 0 - \frac{1}{4} - 0 \\
&= -\frac{1}{4}.
\end{aligned}$$

In particular,  $d(S_{w^2}^3(T_{w,w+1}), \mathfrak{t}_0) \neq d(S_{w^2}^3(T_{w,w+1}), \mathfrak{t}_{\frac{w^2}{2}})$ , which implies that the pull-back of  $\mathfrak{t}_0$  under  $\psi$  is  $\mathfrak{t}_0$  [OS03] (see also [JN16, Theorem 1.2]). Moreover, by the naturality of the action of  $H^2(S_{w^2}^3(T_{w,w+1}); \mathbb{Z})$  on  $\text{Spin}^c(S_n^3(K))$ , we have

$$\begin{aligned}
\psi^*(\mathfrak{t}_1) &= \psi^*(\mathfrak{t}_0 + PD[[\mu]]) = \psi^*(\mathfrak{t}_0) + \psi^*(PD[[\mu]]) \\
&= \mathfrak{t}_0 + \left(\frac{w^2}{2} + 1\right) \cdot PD[[\mu]] \\
&= \mathfrak{t}_{\frac{w^2}{2}+1}
\end{aligned}$$

hence  $d(S_{w^2}^3(T_{w,w+1}), \mathfrak{t}_1) = d(S_{w^2}^3(T_{w,w+1}), \mathfrak{t}_{\frac{w^2}{2}+1})$ . Again, by Propositions 5.2, 5.3, and 5.5 we get

$$\begin{aligned}
d(S_{w^2}^3(T_{w,w+1}), \mathfrak{t}_1) &= d(S_{w^2}^3(U), \mathfrak{t}_1) - 2 \max\{V_1(T_{w,w+1}), V_{w^2-1}(T_{w,w+1})\} \\
&= d(S_{w^2}^3(U), \mathfrak{t}_1) - 2V_1(T_{w,w+1}) \\
&= \frac{(w^2 - 2)^2}{4w^2} - \frac{1}{4} - \frac{w^2 + 2w}{4} + 2 \\
&= -\frac{2w^3 - 3w^2 - 4}{4w^2},
\end{aligned}$$

and

$$\begin{aligned}
d(S_{w^2}^3(T_{w,w+1}), \mathfrak{t}_{\frac{w^2}{2}+1}) &= d(S_{w^2}^3(U), \mathfrak{t}_{\frac{w^2}{2}+1}) - 2 \max\{V_{\frac{w^2}{2}-1}(T_{w,w+1}), V_{\frac{w^2}{2}+1}(T_{w,w+1})\} \\
&= d(S_{w^2}^3(U), \mathfrak{t}_{\frac{w^2}{2}+1}) - 2V_{\frac{w^2}{2}-1}(T_{w,w+1}) \\
&= \frac{4}{4w^2} - \frac{1}{4} - 0 \\
&= \frac{1}{w^2} - \frac{1}{4}.
\end{aligned}$$

A quick computation shows that  $w = 2$ , which gives us the desired contradiction.  $\square$

Finally, we deal with the winding number 2 case.

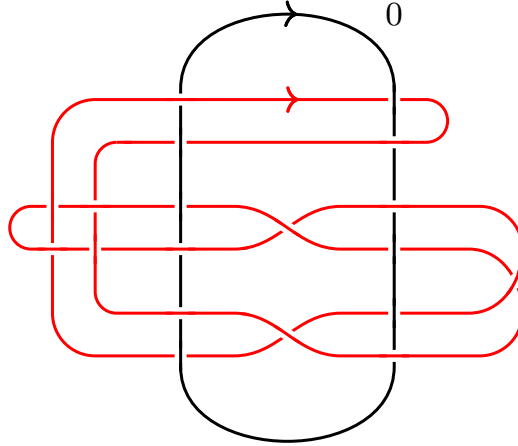

FIGURE 12. A diagram  $D$  for the winding number two knot  $K$ .

**Proposition 5.7.** *If  $K$  is the winding number 2 knot in Figure 12, then  $K$  is not isotopic to  $\mathcal{G}(K)$ .*

*Proof.* Suppose  $K$  is isotopic to  $\mathcal{G}(K)$  and let  $D$  be the diagram of  $K$  described in Figure 12. Then by Propositions 4.1 and 4.2, there is a homeomorphism

$$\phi: M(D, 1) \rightarrow M(D, 1),$$

where  $\phi_*: H_1(M(D, 1); \mathbb{Z}) \rightarrow H_1(M(D, 1); \mathbb{Z})$  is given by

$$\phi_*([m_D]) = [m_D] \text{ and } \phi_*([h_D]) = [h_D] + [m_D].$$

Since  $[m_D] = 2 \cdot [h_D]$  in  $H_1(M(D, 1); \mathbb{Z})$ , we see that  $H_1(M(D, 1); \mathbb{Z}) \cong \mathbb{Z}/4$  is generated by  $[h_D]$  and  $\phi_*([h_D]) = 3 \cdot [h_D]$ . In particular,  $\phi$  is not isotopic to the identity. Using SnapPy and Sage [CDGW], we can verify that  $M(D, 1)$  is hyperbolic with no non-trivial homeomorphisms. This gives us a contradiction and completes the proof.  $\square$

#### APPENDIX A. THE KAUFFMAN BRACKET SKEIN MODULE OF $S^1 \times S^2$

In [Prz91], Przytycki defined a  $\mathbb{Z}[A^{\pm 1}]$ -module,  $\mathcal{S}(M)$ , associated to a 3-manifold  $M$  as a quotient of the free module generated by isotopy classes of framed links in  $M$ . This is inspired by the skein relation for the classical Kauffman bracket [Kau90]. In this section, we prove Theorem 1.7 indicating that this tool, while powerful, cannot be used to differentiate the isotopy class of a knot in  $S^1 \times S^2$  from its image under a Gluck twist. Recall that given a framed knot  $\mathcal{K}$ , the framed knot obtained by adding  $f$  full positive twists to the framing is denoted by  $\mathcal{K}^f$ .

First we recall the precise definition as well as the structure of  $\mathcal{S}(S^1 \times S^2)$  appearing in [HP95]. Let  $\mathcal{M}$  be the free  $\mathbb{Z}[A^{\pm 1}]$ -module generated by isotopy classes of framed links in  $S^1 \times S^2$ . Let  $\mathcal{L}$  be a framed link and  $\mathcal{U}$  be the 0-framed unknot. The skein module,  $\mathcal{S}(S^1 \times S^2)$ , is the quotient of  $\mathcal{M}$  given by setting

$$[\mathcal{L} \sqcup \mathcal{U}] = -(A^{-2} + A^2)[\mathcal{L}]$$

and

$$[\mathcal{L}] = A[\mathcal{L}_0] + A^{-1}[\mathcal{L}_\infty]$$

where  $\mathcal{L}$ ,  $\mathcal{L}_0$ , and  $\mathcal{L}_\infty$  are identical outside of a small ball within which they are as in Figure 13 and  $\sqcup$  denotes a split union. It is a consequence of these relations that if  $\mathcal{L}$  and  $\mathcal{L}^1$  differ by changing the framing by a full positive twist about the meridian of any one component of  $\mathcal{L}$ , as in Figure 14, then

$$(2) \quad [\mathcal{L}^1] = -A^3[\mathcal{L}].$$

The Gluck twist  $\mathcal{G}$  naturally acts on  $\mathcal{S}(S^1 \times S^2)$  and by abuse of notation we will denote this action by  $\mathcal{G}$  as well.

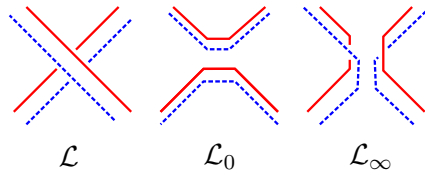

FIGURE 13. The skein relation for the module  $\mathcal{S}(S^1 \times S^2)$ . The links are shown in red and the framings are denoted by the push-offs shown in blue.

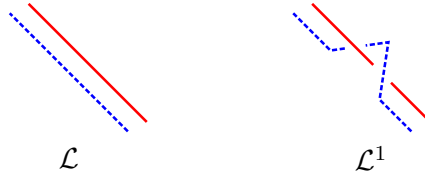

FIGURE 14. The framed link  $\mathcal{L}$ . Changing the framing by a twist about a meridian  $\mathcal{L}^1$ .

There is a natural generating set of  $\mathcal{S}(S^1 \times S^2)$  given by  $z^0$  (the empty diagram),  $z$ ,  $z^2$ ,  $\dots$ , depicted in Figure 15. Two new generating sets are used in [HP95]. The first is given by

$$e_0 = z^0, e_1 = z^1, \text{ and } e_i = ze_{i-1} - e_{i-2} \text{ for } i \geq 2.$$

The generating set consists of eigenvectors of  $\mathcal{G}$ , even regarded in  $\mathcal{S}(S^1 \times D^2)$ . More precisely, by [HP95, Equation(1), p. 67]

$$(3) \quad \mathcal{G}(e_i) = (-1)^i A^{i^2+2i} e_i.$$

The second generating set is given by  $e'_0 = e_0$ ,  $e'_1 = e_1$ ,  $e'_2 = e_2$ , and

$$(4) \quad e'_i = e_i + e'_{i-2} \text{ for } i \geq 3.$$

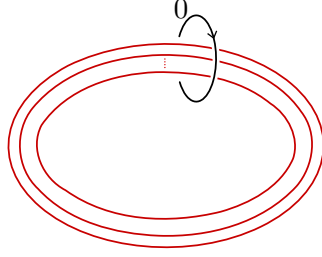

FIGURE 15. A diagram for the  $n$ -component link  $z^n$ , with the black-board framing. Together with the empty diagram  $z^0$ , the set  $\{z^i\}_{i \geq 0}$  forms a generating set for  $\mathcal{S}(S^1 \times S^2)$ .

Hoste-Przytycki prove that for  $i \geq 1$ , the element  $e'_i$  generates the  $\frac{\mathbb{Z}[A^{\pm 1}]}{(1-A^{2i+4})}$ -summand in the following direct sum decomposition [HP95, Theorem 3].

$$(5) \quad \mathcal{S}(S^1 \times S^2) \cong \mathbb{Z}[A^{\pm 1}] \oplus \bigoplus_{i=1}^{\infty} \frac{\mathbb{Z}[A^{\pm 1}]}{(1-A^{2i+4})}.$$

In particular, this means that  $e'_i = A^{2i+4}e'_i$  for each  $i \geq 1$ . Our analysis will require the following pair of observations.

**Proposition A.1.** *For all  $i \geq 0$ , we have*

$$\mathcal{G}(e'_{2i}) = e'_{2i} \text{ and } \mathcal{G}(e'_{2i+1}) = -A^{2i+3}e'_{2i+1}.$$

*Proof.* We give an inductive argument. The base cases are obvious. Next we consider  $e'_{2i+1}$  for  $i \geq 1$ . By the formula (4) for  $e'_i$  in terms of  $e_i$ ,

$$\mathcal{G}(e'_{2i+1}) = \mathcal{G}(e_{2i+1} + e'_{2i-1}).$$

By linearity, the inductive assumption, and (3)

$$\mathcal{G}(e'_{2i+1}) = -A^{4i^2+8i+3}e_{2i+1} - A^{2i+1}e'_{2i-1}.$$

Next, since  $e'_i = e_i + e'_{i-2}$ , it follows that  $e_i = e'_i - e'_{i-2}$  for  $i \geq 3$ . Thus,

$$\mathcal{G}(e'_{2i+1}) = -A^{4i^2+8i+3}e'_{2i+1} + (A^{4i^2+8i+3} - A^{2i+1})e'_{2i-1}.$$

By [HP95, Theorem 3] (see (5)), we have

$$A^{4i+6}e'_{2i+1} = e'_{2i+1} \text{ and } A^{4i+2}e'_{2i-1} = e'_{2i+1}.$$

By rewriting the equation above, we see that

$$\begin{aligned} \mathcal{G}(e'_{2i+1}) &= -A^{(4i+6)i+2i+3}e'_{2i+1} + (A^{(4i+2)(i+1)+2i+1} - A^{2i+1})e'_{2i-1} \\ &= -A^{2i+3}e'_{2i+1} + (A^{2i+1} - A^{2i+1})e'_{2i-1} \\ &= -A^{2i+3}e'_{2i+1} \end{aligned}$$

which completes the inductive step of the proof. The proof for the even case is virtually identical, again using (5).  $\square$

**Proposition A.2.** *If  $\mathcal{K}$  is a framed knot in  $S^1 \times S^2$  with geometric winding number  $w$ , then*

$$[\mathcal{K}] = \sum_{i=0}^w a_i e'_i \in \mathcal{S}(S^1 \times S^2)$$

for some  $a_i \in \mathbb{Z}[A^{\pm 1}]$  for all  $i$  and  $a_i = 0$  whenever  $i \not\equiv w \pmod{2}$ .

*Proof.* Fix a diagram  $D$  for  $\mathcal{K}$ . A glance at the skein relation reveals that when resolving any crossing of  $D$ , the terms  $\mathcal{K}$ ,  $\mathcal{K}_0$  and  $\mathcal{K}_\infty$  all have the same winding number  $\pmod{2}$ , and geometric winding number totaling at most  $w$ . Thus, if we resolve all crossings in  $D$ , we will see that

$$[\mathcal{K}] = \sum_{i=1}^w b_i z^i \in \mathcal{S}(S^1 \times S^2)$$

for some  $b_i \in \mathbb{Z}[A^{\pm 1}]$  for all  $i$ , where  $b_i = 0$  whenever  $i \not\equiv w \pmod{2}$ .

Using the recurrence relations defining  $e_i$  in terms of  $z^i$  and  $e'_i$  in terms of  $e_i$  it is now straightforward to check by induction that

$$z^i = \sum_{j=1}^i c_j e'_j$$

where  $c_j = 0$  whenever  $j \not\equiv i \pmod{2}$ . This completes the proof.  $\square$

We are now ready to prove Theorem 1.7.

*Proof of Theorem 1.7.* If  $\mathcal{K}$  has even geometric winding number  $w$ , then

$$[\mathcal{K}] = \sum_{i=0}^{w/2} a_i e'_{2i} \in \mathcal{S}(S^1 \times S^2)$$

for some  $a_i \in \mathbb{Z}[A^{\pm 1}]$  for all  $i$  by Proposition A.2. By Proposition A.1, we have

$$[\mathcal{G}(\mathcal{K})] = \mathcal{G}([\mathcal{K}]) = \mathcal{G}\left(\sum_{i=0}^{w/2} a_i e'_{2i}\right) = \sum_{i=0}^{w/2} a_i \mathcal{G}(e'_{2i}) = \sum_{i=0}^{w/2} a_i e'_{2i} = [\mathcal{K}] \in \mathcal{S}(S^1 \times S^2).$$

If  $\mathcal{K}$  has odd geometric winding number  $w$ , then

$$[\mathcal{K}] = \sum_{i=0}^{(w-1)/2} a_i e'_{2i+1} \in \mathcal{S}(S^1 \times S^2)$$

by Proposition A.2. By Proposition A.1,

$$\begin{aligned} [\mathcal{G}(\mathcal{K})] &= \mathcal{G}([\mathcal{K}]) = \mathcal{G}\left(\sum_{i=0}^{(w-1)/2} a_i e'_{2i+1}\right) = \sum_{i=0}^{(w-1)/2} a_i \mathcal{G}(e'_{2i+1}) \\ &= \sum_{i=0}^{(w-1)/2} -A^{2i+3} a_i e'_{2i+1} \in \mathcal{S}(S^1 \times S^2). \end{aligned}$$

Let  $f$  be the least common multiple of  $\{2i+3\}_{i=0}^{(w-1)/2}$ . This choice implies that for all  $i = 0, \dots, \frac{w-1}{2}$ , we have that  $3f$  is an odd multiple of  $2i+3$ . Hence  $3f + 2i + 3 \equiv 0$

$(\text{mod } 4i + 6)$  for all  $i$ . Recall that  $A^{4i+6}e'_{2i+1} = e'_{2i+1}$  from (5). Therefore in  $\mathcal{S}(S^1 \times S^2)$  we have

$$[\mathcal{G}(\mathcal{K})^f] = \sum_{i=0}^{(w-1)/2} A^{3f} A^{2i+3} a_i e'_{2i+1} = \sum_{i=0}^{(w-1)/2} A^{3f+2i+3} a_i e'_{2i+1} = \sum_{i=0}^{(w-1)/2} a_i e'_{2i+1}$$

using (2). We conclude that

$$[\mathcal{G}(\mathcal{K})^f] = \sum_{i=0}^{(w-1)/2} a_i e'_{2i+1} = [\mathcal{K}] \in \mathcal{S}(S^1 \times S^2),$$

completing the proof.  $\square$

## APPENDIX B. GEOMETRIC PROOF OF PROPERTY A

In this appendix, we present a geometric proof of Property A for orientable 3-manifolds which does not rely on the acylindrical hyperbolicity. As noted previously, if  $M$  is not prime then  $\pi_1(M)$  is a nontrivial free product, for which Property A is known to hold [Nes96]. For prime 3-manifolds, the bulk of the argument will consist of reducing the case of a non-trivial JSJ-decomposition to that of the JSJ-pieces.

The only prime, reducible, orientable 3-manifold is  $S^1 \times S^2$ . Since this has fundamental group  $\mathbb{Z}$ , it trivially enjoys Property A. Every irreducible, orientable 3-manifold admits a *JSJ-decomposition*, obtained by cutting along mutually disjoint  $\pi_1$ -injective, embedded tori (see, for example, [AFW15, Section 1.6]), into submanifolds that are either Seifert-fibered or atoroidal. By the geometrization theorem [Per02, Per03a, Per03b] (see also [AFW15, Theorem 1.7.6]), we may assume that the pieces are either Seifert-fibered or hyperbolic with finite volume. With the results of Section 2, we can easily prove Property A holds for 3-manifolds with trivial JSJ-decomposition, possibly with torus boundary, as follows.

**Proposition B.1.** *Suppose  $M$  is an orientable 3-manifold, possibly with torus boundary, which has trivial JSJ-decomposition. Then  $\pi_1(M)$  has Property A.*

*Proof.* If the interior of  $M$  admits a complete hyperbolic metric, then  $\pi_1(M)$  is hyperbolic relative to its peripheral subgroups, hence has Property A by [MO10]. If  $M$  is Seifert-fibered, then  $\pi_1(M)$  has Property A by Theorem 2.9.  $\square$

Suppose now  $M$  has a non-trivial JSJ-decomposition, and let  $M_0$  be a JSJ-component. If  $M_0$  is Seifert-fibered, then it fibers over a 2-dimensional orbifold with nonempty boundary. Since each JSJ-torus is  $\pi_1$ -injective, the base orbifold  $B_0$  has Euler characteristic  $\leq 0$ . When  $B_0$  is an annulus,  $M_0$  is  $T^2 \times I$  and when  $B_0$  is a Möbius strip or an annulus with 2 cone points of order 2,  $M_0$  is the twisted  $I$ -bundle over the Klein bottle. In every other case,  $B_0$  is hyperbolic.

Our strategy will mimic the general structure theory of compact 3-manifolds, as follows. We will prove that all prime 3-manifold groups have Property A by reducing it to showing Property A for the fundamental group of each JSJ-piece, finishing the proof by appealing to Proposition B.1. In order to do this, we will need to understand when curves in the JSJ-tori can be freely homotopic.

**Lemma B.2.** *Let  $M$  be a prime, closed, orientable 3-manifold with nontrivial JSJ-decomposition. Let  $M_0$  be a JSJ-component of  $M$ . Suppose  $\gamma_1, \gamma_2 \subset \partial M_0$  are oriented loops which are freely homotopic in  $M_0$  but not in  $\partial M_0$ . Then  $M_0$  is Seifert-fibered, and  $\gamma_1, \gamma_2$  lie in different components of  $\partial M_0$  but are freely homotopic to the same multiple of the general fiber curve.*

*Proof.* Choose a basepoint  $x_0 \in M_0$  and paths from  $x_0$  to  $\gamma_i$  to represent each as an element  $g_i \in \pi_1(M_0, x_0)$ . First suppose  $M_0$  is hyperbolic. The peripheral tori in  $M_0$  correspond to conjugacy classes of parabolic fixed points in the boundary at infinity of the universal cover  $\mathbb{H}^3$ . Therefore, if  $\gamma_1, \gamma_2$  lie in distinct boundary components  $T_1, T_2 \subseteq \partial M_0$ , a conjugacy between  $g_1$  and  $g_2$  would induce a conjugacy between the corresponding parabolic fixed points and thus  $T_1$  would equal  $T_2$  in  $M_0$ , a contradiction. If  $\gamma_1, \gamma_2$  lie in the same component of  $\partial M_0$ , then a conjugacy between  $\gamma_1$  and  $\gamma_2$  implies there exists  $g \in \pi_1(M_0)$  such that  $g$  fixes the same parabolic fixed point as  $\gamma_1, \gamma_2$  and conjugates the action of  $\gamma_1$  to  $\gamma_2$ . In this case,  $g$  would have to be elliptic, which is impossible as  $M_0$  is a manifold.

Now suppose  $M_0$  is Seifert-fibered and that  $p : M_0 \rightarrow B_0$  is the fibration to an orbifold  $B_0$ . If  $M_0$  is  $T^2 \times I$  or the twisted  $I$ -bundle over the Klein bottle, the result is clear. Otherwise,  $B_0$  is hyperbolic. Then as the  $\gamma_i$  are both boundary curves, the fact that  $p(\gamma_1)$  is freely homotopic to  $p(\gamma_2)$  implies that either  $p_*(g_1) = p_*(g_2) \neq 1$  and the  $\gamma_i$  lie in the same boundary component, or  $p_*(g_1) = p_*(g_2) = 1$ . In either case, there exists  $z \in \ker p_*$  such that  $g_1 = g_2 z$ . Since the fiber bundle is trivial over the boundary of  $B_0$ , if  $p_*(g_1) \neq 1$ , the only way  $g_1$  and  $g_2$  can be conjugate is if  $z = 1$ , hence  $g_1 = g_2$ . But then the  $\gamma_i$  are homotopic in  $\partial M_0$ , contradicting our assumption. Otherwise  $\gamma_1, \gamma_2$  are homotopic to the same multiple of the general fiber curve, as desired.  $\square$

We now describe when curves can be freely homotopic in the 3-manifold but not in a JSJ-piece.

**Lemma B.3.** *Let  $M$  be a prime, closed, orientable 3-manifold with nontrivial JSJ-decomposition. Let  $F = F_1 \cup \dots \cup F_n$  be a maximal, embedded, mutually disjoint union of 2-sided tori for the JSJ-decomposition. Suppose  $M_1, M_2$  are components of  $M \setminus F$  and that  $\gamma_i \subset M_i$ ,  $i = 1, 2$  are oriented loops freely homotopic in  $M$  but not in  $M \setminus F$ . Then each  $\gamma_i$  is freely homotopic in  $M_i$  to a curve  $\gamma'_i$  in a JSJ-torus  $F_i \subseteq \overline{M_i}$  and either*

- (1)  $\gamma'_1 = \gamma'_2$  or
- (2)  $F_1$  and  $F_2$  both meet the closure of a Seifert-fibered piece  $M_3$ , and the  $\gamma'_i$  are homotopic in  $M_3$  to a multiple of a general fiber curve of  $M_3$ .

**Remark B.4.** Note that any curve lying on  $F$  can be pushed into  $M \setminus F$ . We do not assume that  $M_1, M_2$  and  $M_3$  are necessarily distinct.

*Proof.* Since  $\gamma_1$  is freely homotopic to  $\gamma_2$ , there is a map of an annulus  $A : S^1 \times [1, 2] \rightarrow M$  so that  $A(-, j) = \gamma_j$  for  $j = 1, 2$ . Perturb  $A$  to be transverse to  $F$ . Then  $A^{-1}(F)$  is an embedded 1-submanifold of  $S^1 \times [1, 2]$  which does not meet the boundary of  $A$ , hence is a disjoint union of circles. Since  $\pi_1(M)$  is torsion-free, both  $A$  and  $F$  are  $\pi_1$ -injective. Thus, for each such circle  $C$ , there are two possibilities:

- $C$  is nullhomotopic in  $S^1 \times [1, 2]$  and  $A(C)$  is nullhomotopic in  $F$ .

- $C$  is not nullhomotopic in  $S^1 \times [1, 2]$  and  $A(C)$  is not nullhomotopic in  $F$ .

In the former case, we use the irreducibility of  $M$  to homotope  $C$  away. Thus, we can assume that only the second type of circle occurs. Thus, we have that  $C = C_1 \cup \dots \cup C_r$  is a union of essential embedded loops in  $S^1 \times [1, 2]$ . Putting these in order of proximity to  $S^1 \times \{1\}$  and cutting along them, we see subannuli  $X_0, X_1, \dots, X_r$  of  $S^1 \times [1, 2]$  with disjoint interiors so that that  $S^1 \times \{1\}$  and  $C_1$  cobound  $X_0$ ,  $C_i$  and  $C_{i+1}$  cobound  $X_i$  for  $i = 1, \dots, r-1$ , and  $C_r$  and  $S^1 \times \{2\}$  cobound  $X_r$ . For any  $i$ , let  $\alpha_i = A(C_i)$ ,  $S_i$  be the component of  $F$  containing  $A(C_i)$ , and  $N_i$  be the component of  $M - F$  whose closure contains  $A(X_i)$ . Notice that  $N_1 = M_1$  and the restriction  $A|_{X_1}$  gives a homotopy in  $M_1$  from  $\gamma_1$  to  $\alpha_1 \subseteq S_1$ . Similarly,  $N_r = M_2$  and  $A|_{X_{r+1}}$  gives a homotopy from  $\gamma_2$  to  $\alpha_r \subseteq S_r$ . Setting  $\gamma'_1 = \alpha_1$ ,  $F_1 = S_1$ ,  $\gamma'_2 = \alpha_r$ , and  $F_2 = S_r$  completes the proof of the first part of the claim.

If  $r = 1$ , then we are in case (1). Suppose then  $r \geq 2$ , then  $\alpha_1, \alpha_2$  both lie in peripheral tori of  $N_2$ , and moreover, they are freely homotopic in  $N_2$ . If  $\alpha_1$  and  $\alpha_2$  are freely homotopic in  $\partial N_2$ , we eliminate this part of the homotopy from  $A$  and reduce  $r$  by one. Otherwise, by Lemma B.2,  $N_2$  is Seifert-fibered  $\alpha_1$  and  $\alpha_2$  lie in distinct peripheral tori of  $N_2$ , and both  $\alpha_1$  and  $\alpha_2$  are homotopic to a multiple of the fiber curve of  $N_2$ . If  $r > 2$ , then repeating this argument, we see that  $N_3$  is also Seifert-fibered, and that  $\alpha_3 = \alpha_2$  is a multiple of the fiber curve. Thus the gluing map identifies multiples of the fiber curve on  $N_2$  and  $N_3$ , and since it is a homeomorphism, it must identify the fiber curves themselves. But this implies  $N_2 \cup_{F_2} N_3$  Seifert fibered, contradicting the fact that  $F_2$  is a nontrivial JSJ-torus. This contradiction implies that  $r = 2$  and we are in case (2), as desired.  $\square$

If some component  $M_0$  of  $M \setminus F$  fibers over an annulus, then  $M$  is obtained from  $M_0$  by gluing the two boundary components by an Anosov homeomorphism and as a consequence  $M_0$  is the only piece of the JSJ-decomposition. We will refer to this type of manifold as an *Anosov bundle*. Anosov bundles are distinguished from other prime 3-manifolds by the following fact, since naturally any curve in  $T^2 \times I$  is homotopic into the boundary.

**Lemma B.5.** *Let  $M_0$  be a JSJ-component of  $M$  which is not homeomorphic to  $T^2 \times I$ . Then*

- (1)  $M_0$  contains a curve which is not homotopic into the boundary.
- (2) If  $M_0$  is not the twisted  $I$ -bundle over the Klein bottle, there is at most one isotopy class of curves which can be the regular fiber of a Seifert fibering.

*Proof.* Let  $M_0$  be a component of the JSJ-decomposition of  $M$ . First assume  $M_0$  is Seifert-fibered. Since  $M_0 \neq T^2 \times I$ , we can take the base orbifold  $B_0$  to be either the Möbius strip or a 2-orbifold with negative orbifold Euler characteristic. In either case,  $M_0$  clearly contains a curve which is not boundary parallel, since  $B_0$  does.

If  $M_0$  admits a finite volume hyperbolic metric, then  $\pi_1(M_0) \cong \Gamma \leq \mathrm{PSL}_2(\mathbb{C})$ . Assume for contradiction that every element of  $\Gamma$  is represented by a curve homotopic into the boundary. This occurs if and only if every element of  $\Gamma$  is parabolic. In particular,  $\Gamma$  must be elementary by Theorem 5.1.3 of [Bea83] and by the classification of elementary subgroups, every element fixes the same point at infinity. But then by discreteness,  $\Gamma \cong \mathbb{Z}^2$  and  $M_0$  cannot have finite volume, a contradiction. The second statement can be found in Theorem 3.9 of [Sco83].  $\square$



We are now able to prove Property A in the non-prime case.

**Theorem 1.4.** *Let  $M$  be a closed, prime, orientable 3-manifold. Then  $\pi_1(M)$  has Property A.*

*Proof.* By Propositions B.1 and 2.10, we may assume that  $M$  has a non-trivial JSJ-decomposition and is not an Anosov bundle. The only prime, reducible, orientable 3-manifold is  $S^1 \times S^2$ , which has fundamental group  $\mathbb{Z}$ , which trivially enjoys Property A. Thus, we further assume that  $M$  is irreducible. Indeed, since  $M$  has nontrivial JSJ-decomposition, it is aspherical and Haken. As  $M$  is aspherical, every element of  $\text{Aut}(\pi_1(M))$  can be represented by a (pointed) self-homotopy equivalence (see, for example, [Hat02, Theorem 1B.9]), and since  $M$  is Haken, any (pointed) self-homotopy equivalence is homotopic to a (pointed) self-homeomorphism [Wal68].

Let  $F = F_1 \cup \dots \cup F_n$  be the union of JSJ tori for  $M$ . Suppose  $\phi : \pi_1(M) \rightarrow \pi_1(M)$  is a class preserving automorphism, and represent  $\phi$  by a homeomorphism  $f : M \rightarrow M$ . Observe that the image  $f(F)$  is a maximal embedded, mutually disjoint union of incompressible 2-sided tori, and hence by the uniqueness statement of the JSJ-decomposition,  $f(F)$  is isotopic to  $F$ . Modifying  $f$  by the isotopy extension theorem, we assume that  $f(F) = F$ . Our initial goal is to show that  $f|_F$  is the identity.

The set  $F$  defines a connected dual graph  $\Delta$  whose vertices are the connected components of  $M \setminus F$ , and whose edges correspond to the tori  $F_i \subset F$ . Since  $f(F) = F$ ,  $f$  induces an automorphism  $\psi$  of this graph.

**Claim B.6.**  *$\psi$  is the identity map.*

*Proof.* By Lemma B.3, if a loop in some component  $M \setminus F$  is freely homotopic to another loop in  $M$  but not in  $M \setminus F$ , then it must be freely homotopic into a JSJ torus. By Lemma B.5(1), each component of  $M \setminus F$  contains at least one loop which is not boundary parallel. Hence,  $\psi$  must fix every vertex. In particular, if two vertices in  $\Delta$  share a unique edge, this must be fixed by  $\psi$ . On the other hand, every loop and bigon of  $\Delta$  defines a nontrivial free summand of  $H_1(M; \mathbb{Z})$ . The fact that  $\phi$  is class preserving implies that it must induce the identity on  $H_1(M; \mathbb{Z})$ , hence these must also be fixed and  $\psi = \text{Id}$ .  $\square$

By the previous lemma, we can isotope  $f$  so that  $f(F_i) = F_i$  for every component  $F_i \subseteq F$ . Let  $N(F)$  be a tubular neighborhood of  $F$  in  $M$ .

**Claim B.7.** *After an isotopy,  $f|_{N(F)}$  is the identity.*

*Proof.* Let  $F_0$  be a component of  $F$ . Since  $F_0$  is a torus, it suffices to show that  $f_* : H_1(F_0; \mathbb{Z}) \rightarrow H_1(F_0; \mathbb{Z})$  is the identity. Choose a component  $M_0 \subset M \setminus F$  such that  $F_0 \subset \overline{M_0}$ . Let  $\gamma \subset F_0$  be a simple closed curve representing an element of a basis for  $H_1(F_0; \mathbb{Z})$ . We can isotope  $\gamma$  to a curve  $\alpha \subset M_0$  by pushing into the collar  $N(F_0)$ . Then  $f(\gamma) \subseteq F_0$ , and  $f(\gamma)$  is isotopic to a curve  $\beta$  in  $N(F_0)$  on the same side of  $F_0$  as  $\alpha$ . Now as  $f_*$  is class preserving  $\alpha$  is freely homotopic to  $\beta$  in  $M$ . We claim that  $\alpha$  is freely homotopic to  $\beta$  in  $N(F_0)$ .

Let  $A$  be an annulus connecting  $\alpha$  and  $\beta$  in  $M$ . Since  $\alpha$  and  $\beta$  lie in the same component of  $M \setminus F$ , by Lemma B.3 there are six possibilities as indicated in Figure 16. In every case, the annulus connects two curves in distinct boundary tori of  $M_0$  and  $M_1$ . In particular,  $M_0, M_1$  both have at least two boundary components, so neither one is the twisted  $I$ -bundle over the Klein bottle. It follows from Lemma B.2 that

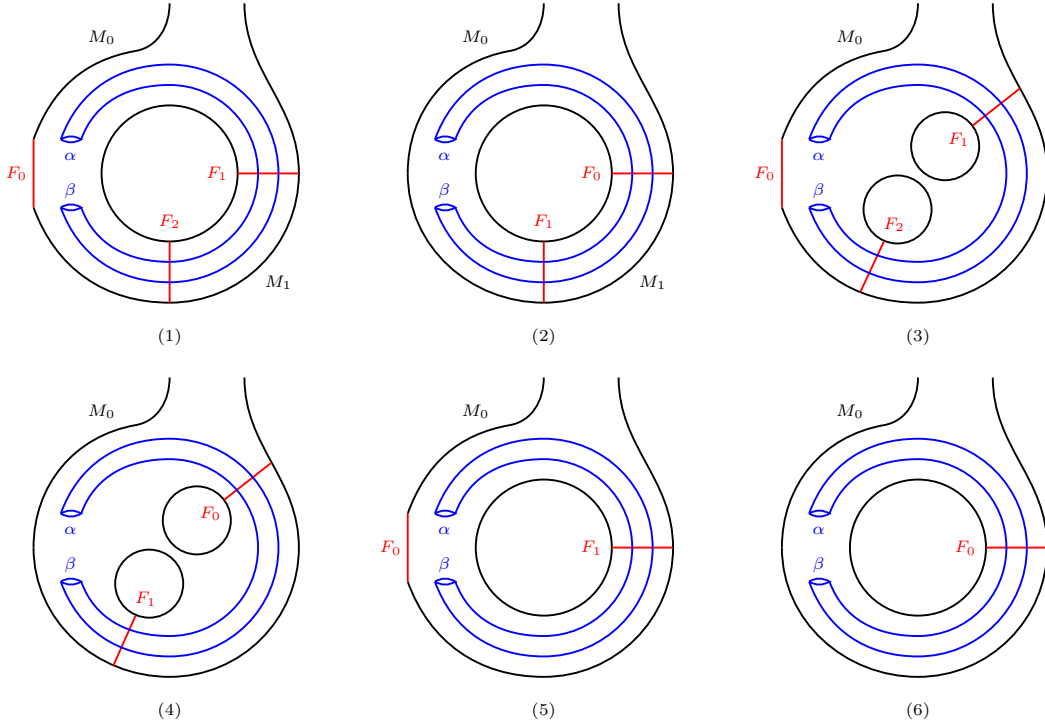

FIGURE 16. The six possible configurations of the annulus  $A$  connecting  $\alpha$  and  $\beta$  in Claim B.7. Note that  $\alpha, \beta$  are push offs of  $\gamma, f(\gamma)$  respectively, lying on the same side of  $F_0$ .

both  $M_0$  and  $M_1$  are Seifert-fibered, and from Lemma B.5(2) that  $\beta$  is homotopic to the general fiber of the unique Seifert fibering of  $M_0, M_1$ . This implies that in cases (1) and (2), the result of gluing together  $M_0$  and  $M_1$  along the tori which meet  $A$  is still Seifert-fibered. In cases (3)–(5), the result of gluing  $M_0$  to itself along the tori meeting  $A$  is again Seifert-fibered. This contradicts the defining property of the JSJ-decomposition.

Finally in case (6), let  $\delta$  be any primitive element of  $H_1(F_0)$  distinct from  $\gamma$  and  $f(\gamma)$ . Since there is only one isotopy class which can be the general fiber of a Seifert fibration of  $M_0$ ,<sup>1</sup> we must have that  $f(\delta)$  is isotopic to  $\delta$  in  $F_0$ . But we can find a basis  $\{\delta_1, \delta_2\}$  for  $H_1(F_0)$  disjoint from  $\{\gamma, f(\gamma)\}$ . Hence  $f|_{F_0}$  is isotopic to the identity. Since  $F_0$  was arbitrary, this proves that  $f|_F$  is isotopic to the identity, and on a neighborhood  $N(F) \cong F \times [0, 1]$  we can isotope  $f$  to be the identity as well.  $\square$

It follows from Claim B.7 that for each component  $M_0 \subset M \setminus \text{int}(N(F))$ ,  $f$  restricts to a homeomorphism  $f_0 : M_0 \rightarrow M_0$  such that  $f_0|_{\partial M_0} = \text{Id}$ . Isotope  $f_0$  rel  $\partial M_0$  so that it fixes a basepoint  $x_0 \in M_0$ .

**Claim B.8.**  $f_0$  induces a class preserving automorphism  $\phi_0$  of  $\pi_1(M_0, x_0)$ .

*Proof.* Let  $\gamma \subset M_0$  be any curve and consider  $f(\gamma) = f_0(\gamma)$ . By assumption  $f(\gamma)$  is freely homotopic in  $M$  to  $\gamma$ . If  $\gamma$  and  $f(\gamma)$  were homotopic in  $M - F$ , then they

<sup>1</sup>This is exactly where the proof fails when  $M$  is an Anosov bundle.

would be homotopic in  $M_0$ . Otherwise by Lemma B.3  $\gamma$  is freely homotopic in  $M_0$  to some  $\gamma' \subseteq F$ . As a consequence,  $f(\gamma)$  is freely homotopic in  $M_0$  to  $f(\gamma')$ . By Lemma B.7  $\gamma' = f(\gamma')$ . Therefore, by transitivity,  $\gamma$  and  $f(\gamma)$  are freely homotopic in  $M_0$ , and we conclude that  $f_0$  is class preserving.  $\square$

We will now show that  $f$  is isotopic to the identity. Recall that each component of  $M \setminus \text{int}(N(F))$  satisfies the hypotheses of Proposition B.1. We have also fixed a component  $M_0$  of  $M \setminus \text{int}(N(F))$ , and a basepoint  $x_0 \in M_0$ , and performed an isotopy so that  $f(x_0) = x_0$ . We know that  $f_0 = f|_{M_0}$  induces a class preserving automorphism  $\phi_0$  of  $\pi_1(M_0, x_0)$  by Claim B.8. By Proposition B.1,  $\phi_0$  is inner. After isotoping  $f_0$  relative to the boundary, we assume that  $\phi_0$  is the identity. Since  $M_0$  is Haken, we can in fact isotope  $f$  so that  $f_0$  is the identity by [Wal68] (see also Theorem 3.1). Choose a maximal tree in  $T \subseteq \Delta$  for the graph  $\Delta$  from Claim B.6. For each neighboring vertex  $M_1, \dots, M_r$  of  $M_0$  in  $T$ , choose basepoints  $x_1, \dots, x_r$  in their common torus boundary, and embed a copy of the star of the vertex  $M_0$  in  $T$  into  $M$ . This gives a canonical identification of  $\pi_1(M_i, x_i)$  with a subgroup of  $\pi_1(M, x_0)$  that is invariant under  $f$ .

We now induct on the distance in  $T$  to  $M_0$ , where by definition each edge in  $T$  has length one. Suppose that we have isotoped  $f$  to be the identity on all  $M_i$  at distance at most  $d$  from  $M_0$ , and that  $M_K$  has distance  $d + 1$ . We have chosen a basepoint  $x_K$  in a boundary torus  $F_K$  of  $M_K$ . Then  $f|_{M_K}$  induces a class preserving automorphism  $\phi_K$  of  $\pi_1(M_K, x_K)$  by Claim B.8, which is inner by Proposition B.1. Thus, after isotopy,  $\phi_K = \text{Id}$ , and the fact that  $M_K$  is Haken implies that we can isotope  $f|_{F_K}$  to the identity relative to the boundary. This completes the induction step and the proof.  $\square$

## REFERENCES

- [AFW15] Matthias Aschenbrenner, Stefan Friedl, and Henry Wilton. *3-manifold groups*. EMS Series of Lectures in Mathematics. European Mathematical Society (EMS), Zürich, 2015.
- [AKT03] R. B. J. T. Allenby, Goansu Kim, and C. Y. Tang. On the residual finiteness of  $\text{Out}(\pi_1(M))$  of certain Seifert manifolds. *Algebra Colloq.*, 10(2):121–126, 2003.
- [AKT09] R. B. J. T. Allenby, Goansu Kim, and C. Y. Tang. Outer automorphism groups of Seifert 3-manifold groups over non-orientable surfaces. *J. Algebra*, 322(4):957–968, 2009.
- [AMS16] Yago Antolín, Ashot Minasyan, and Alessandro Sisto. Commensurating endomorphisms of acylindrically hyperbolic groups and applications. *Groups Geom. Dyn.*, 10(4):1149–1210, 2016.
- [Bea83] Alan F. Beardon. *The geometry of discrete groups*, volume 91 of *Graduate Texts in Mathematics*. Springer-Verlag, New York, 1983.
- [Bin59] R. H. Bing. An alternative proof that 3-manifolds can be triangulated. *Ann. of Math. (2)*, 69:37–65, 1959.
- [BL14] M. Borodzik and C. Livingston. Heegaard Floer homology and rational cuspidal curves. *Forum Math. Sigma*, 2:e28, 2014.
- [BO91] Michel Boileau and Jean-Pierre Otal. Scindements de Heegaard et groupe des homéotopies des petites variétés de Seifert. *Invent. Math.*, 106(1):85–107, 1991.
- [Bon83] Francis Bonahon. Difféotopies des espaces lenticulaires. *Topology*, 22(3):305–314, 1983.
- [BZH14] Gerhard Burde, Heiner Zieschang, and Michael Heusener. *Knots*, volume 5 of *De Gruyter Studies in Mathematics*. De Gruyter, Berlin, extended edition, 2014.
- [CDGW] Marc Culler, Nathan M. Dunfield, Matthias Goerner, and Jeffrey R. Weeks. SnapPy, a computer program for studying the geometry and topology of 3-manifolds. Available at <http://snappy.computop.org>

- [Cer68] Jean Cerf. *Sur les difféomorphismes de la sphère de dimension trois* ( $\Gamma_4 = 0$ ). Lecture Notes in Mathematics, No. 53. Springer-Verlag, Berlin-New York, 1968.
- [CH15] Tim D. Cochran and Peter D. Horn. Structure in the bipolar filtration of topologically slice knots. *Algebr. Geom. Topol.*, 15(1):415–428, 2015.
- [DNPR18] Christopher W. Davis, Matthias Nagel, JungHwan Park, and Arunima Ray. Concordance of knots in  $S^1 \times S^2$ . *J. Lond. Math. Soc. (2)*, 98(1):59–84, 2018.
- [EK71] Robert D. Edwards and Robion C. Kirby. Deformations of spaces of imbeddings. *Ann. Math. (2)*, 93:63–88, 1971.
- [Fis60] Gordon M. Fisher. On the group of all homeomorphisms of a manifold. *Trans. Amer. Math. Soc.*, 97:193–212, 1960.
- [Glu62] Herman Gluck. The embedding of two-spheres in the four-sphere. *Trans. Amer. Math. Soc.*, 104:308–333, 1962.
- [GMT03] David Gabai, G. Robert Meyerhoff, and Nathaniel Thurston. Homotopy hyperbolic 3-manifolds are hyperbolic. *Ann. of Math. (2)*, 157(2):335–431, 2003.
- [Gro75] Edna K. Grossman. On the residual finiteness of certain mapping class groups. *J. London Math. Soc. (2)*, 9:160–164, 1974/75.
- [GS99] Robert E. Gompf and András I. Stipsicz. *4-manifolds and Kirby calculus*, volume 20 of *Graduate Studies in Mathematics*. American Mathematical Society, Providence, RI, 1999.
- [GS20] Mark Grant and Agata Sienicka. Isotopy and homeomorphism of closed surface braids. *Glasgow Mathematical Journal*, pages 1–10, May 2020. to appear, *Glasgow Math. Journal*.
- [Hat83] Allen E. Hatcher. A proof of the Smale conjecture,  $\text{Diff}(S^3) \simeq O(4)$ . *Ann. of Math. (2)*, 117(3):553–607, 1983.
- [Hat02] A Hatcher. *Algebraic Topology*. Cambridge Univ. Press, Cambridge, 2002.
- [HM13] Sungbok Hong and Darryl McCullough. Mapping class groups of 3-manifolds, then and now. In *Geometry and topology down under*, volume 597 of *Contemp. Math.*, pages 53–63. Amer. Math. Soc., Providence, RI, 2013.
- [HP95] Jim Hoste and Józef H. Przytycki. The Kauffman bracket skein module of  $S^1 \times S^2$ . *Math. Z.*, 220(1):65–73, 1995.
- [HWZ13] Emily Hamilton, Henry Wilton, and Pavel A. Zalesskii. Separability of double cosets and conjugacy classes in 3-manifold groups. *J. Lond. Math. Soc. (2)*, 87(1):269–288, 2013.
- [JN16] Stanislav Jabuka and Swatee Naik. Periodic knots and Heegaard Floer correction terms. *J. Eur. Math. Soc. (JEMS)*, 18(8):1651–1674, 2016.
- [Kau90] Louis H. Kauffman. An invariant of regular isotopy. *Trans. Amer. Math. Soc.*, 318(2):417–471, 1990.
- [Mag74] Wilhelm Magnus. *Noneuclidean tessellations and their groups*. Academic Press [A subsidiary of Harcourt Brace Jovanovich, Publishers], New York-London, 1974. Pure and Applied Mathematics, Vol. 61.
- [McC02] Darryl McCullough. Isometries of elliptic 3-manifolds. *J. London Math. Soc. (2)*, 65(1):167–182, 2002.
- [McC06] Darryl McCullough. Homeomorphisms which are Dehn twists on the boundary. *Algebr. Geom. Topol.*, 6:1331–1340, 2006.
- [MO10] A. Minasyan and D. Osin. Normal automorphisms of relatively hyperbolic groups. *Trans. Amer. Math. Soc.*, 362(11):6079–6103, 2010.
- [MO15] Ashot Minasyan and Denis Osin. Acylindrical hyperbolicity of groups acting on trees. *Math. Ann.*, 362(3-4):1055–1105, 2015.
- [Moi52] Edwin E. Moise. Affine structures in 3-manifolds. V. The triangulation theorem and Hauptvermutung. *Ann. of Math. (2)*, 56:96–114, 1952.
- [Moi77] Edwin E. Moise. *Geometric topology in dimensions 2 and 3*. Springer-Verlag, New York-Heidelberg, 1977. Graduate Texts in Mathematics, Vol. 47.
- [Mun59] James Munkres. Obstructions to the smoothing of piecewise-differentiable homeomorphisms. *Bull. Amer. Math. Soc.*, 65:332–334, 1959.

- [Mun60] James Munkres. Obstructions to the smoothing of piecewise-differentiable homeomorphisms. *Ann. of Math. (2)*, 72:521–554, 1960.
- [Nes96] M. V. Neshchadim. Free products of groups that do not have outer normal automorphisms. *Algebra i Logika*, 35(5):562–566, 625, 1996.
- [NR78] Walter D. Neumann and Frank Raymond. Seifert manifolds, plumbing,  $\mu$ -invariant and orientation reversing maps. In *Algebraic and geometric topology (Proc. Sympos., Univ. California, Santa Barbara, Calif., 1977)*, volume 664 of *Lecture Notes in Math.*, pages 163–196. Springer, Berlin, 1978.
- [NW15] Y. Ni and Z. Wu. Cosmetic surgeries on knots in  $S^3$ . *J. Reine Angew. Math.*, 706:1–17, 2015.
- [OS03] P. Ozsváth and Z. Szabó. Absolutely graded Floer homologies and intersection forms for four-manifolds with boundary. *Adv. Math.*, 173(2):179–261, 2003.
- [OS11] P. Ozsváth and Z. Szabó. Knot Floer homology and rational surgeries. *Algebr. Geom. Topol.*, 11(1):1–68, 2011.
- [Per02] G. Perelman. The entropy formula for the Ricci flow and its geometric applications. arXiv:0211159, 2002.
- [Per03a] G. Perelman. Finite extinction time for the solutions to the Ricci flow on certain three-manifolds. arXiv:0307245, 2003.
- [Per03b] G. Perelman. Ricci flow with surgery on three-manifolds. arXiv:0303109, 2003.
- [Prz91] Józef H. Przytycki. Skein modules of 3-manifolds. *Bull. Polish Acad. Sci. Math.*, 39(1-2):91–100, 1991.
- [Ras03] J. A. Rasmussen. *Floer homology and knot complements*. ProQuest LLC, Ann Arbor, MI, 2003. Thesis (Ph.D.)—Harvard University.
- [Sco83] Peter Scott. The geometries of 3-manifolds. *Bull. London Math. Soc.*, 15(5):401–487, 1983.
- [Sco85] Peter Scott. Homotopy implies isotopy for some Seifert fibre spaces. *Topology*, 24(3):341–351, 1985.
- [Wal68] F. Waldhausen. On irreducible 3-manifolds which are sufficiently large. *Ann. of Math. (2)*, 87:56–88, 1968.
- [Whi61] J. H. C. Whitehead. Manifolds with transverse fields in Euclidean space. *Ann. of Math. (2)*, 73:154–212, 1961.

MATHEMATICAL INSTITUTE UNIVERSITY OF OXFORD, OXFORD, UNITED KINGDOM  
*E-mail address:* [paoloaceto@gmail.com](mailto:paoloaceto@gmail.com)  
*URL:* <http://www.maths.ox.ac.uk/people/paolo.aceto>

DEPARTMENT OF MATHEMATICS, BRANDEIS UNIVERSITY, WALTHAM, MA, USA  
*E-mail address:* [cbregman@brandeis.edu](mailto:cbregman@brandeis.edu)  
*URL:* <http://people.brandeis.edu/~cbregman/>

DEPARTMENT OF MATHEMATICS, UNIVERSITY OF WISCONSIN—EAU CLAIRE, WI, USA  
*E-mail address:* [daviscw@uwec.edu](mailto:daviscw@uwec.edu)  
*URL:* <http://people.uwec.edu/daviscw>

SCHOOL OF MATHEMATICS, GEORGIA INSTITUTE OF TECHNOLOGY, ATLANTA, GA, USA  
*E-mail address:* [junghwan.park@math.gatech.edu](mailto:junghwan.park@math.gatech.edu)  
*URL:* <http://people.math.gatech.edu/~jpark929/>

MAX-PLANCK-INSTITUT FÜR MATHEMATIK, VIVATSGASSE 7, 53111 BONN, GERMANY  
*E-mail address:* [aruray@mpim-bonn.mpg.de](mailto:aruray@mpim-bonn.mpg.de)  
*URL:* <http://people.mpim-bonn.mpg.de/aruray>