

Cohomological invariants of representations of 3-manifold groups

Haimiao Chen *

Mathematics, Beijing Technology and Business University, Beijing, China

Abstract

Suppose Γ is a discrete group, and $\alpha \in Z^3(B\Gamma; A)$, with A an abelian group. Given a representation $\rho : \pi_1(M) \rightarrow \Gamma$, with M a closed 3-manifold, put $F(M, \rho) = \langle (B\rho)^*[\alpha], [M] \rangle$, where $B\rho : M \rightarrow B\Gamma$ is a continuous map inducing ρ which is unique up to homotopy, and $\langle -, - \rangle : H^3(M; A) \times H_3(M; \mathbb{Z}) \rightarrow A$ is the pairing. We extend the definition of $F(M, \rho)$ to manifolds with corners, and establish a gluing law. Based on these, we present a practical method for computing $F(M, \rho)$ when M is given by a surgery along a link $L \subset S^3$. In particular, the Chern-Simons invariant can be computed this way.

Keywords: cohomological invariant, 3-manifold, fundamental group, representation, Chern-Simons invariant

MSC 2020: 57K31

1 Introduction

Suppose Γ is a discrete group, and $\alpha \in Z^3(B\Gamma; A)$, with A an abelian group. Given a representation $\rho : \pi_1(M) \rightarrow \Gamma$, with M a closed 3-manifold, put

$$F(M, \rho) = \langle (B\rho)^*[\alpha], [M] \rangle \in A, \quad (1)$$

where $B\rho : M \rightarrow B\Gamma$ is a continuous map inducing ρ which is unique up to homotopy, and $\langle -, - \rangle : H^3(M; A) \times H_3(M; \mathbb{Z}) \rightarrow A$ is the pairing. It is a subtle problem to define $F(M, \rho)$ when $\partial M \neq \emptyset$, and will be handled in this paper.

There are at least two reasons for us to care about this cohomological invariant. First, if Γ is a finite group and $A = \mathbb{R}/\mathbb{Z}$, then

$$\frac{1}{\#\Gamma} \sum_{\rho: \pi_1(M) \rightarrow \Gamma} \exp(\sqrt{-1}F(M, \rho)) \in \mathbb{C}$$

is by definition the *Dijkgraaf-Witten invariant* of M associated to $[\alpha]$. Second, if $A = \mathbb{C}/\mathbb{Z}$ and $\Gamma = \mathrm{SL}(n, \mathbb{C})^\delta$ viewed as a discrete group, then for a certain α representing the *Cheeger-Chern-Simons class* $\hat{C}_2 \in H^3(B\Gamma; \mathbb{C}/\mathbb{Z})$, one has that $F(M, \rho)$ equals the *Chern-Simons invariant* (CSI for short) $\mathrm{CS}(\rho)$ which is meant to be that of the flat connection corresponding to ρ .

*Email: chenhm@math.pku.edu.cn

The importance of CSI is manifested in several aspects of geometry and topology; see [5, 6, 8, 9, 20] and the references therein. There have been many works in the literature on computing CSI. Zickert [21] gave a formula for boundary-parabolic $\mathrm{SL}(2, \mathbb{C})$ -representations, for M with tori boundary. Hatakenaka and Nosaka [13], Inoue and Kabaya [14] used quandle to derive a new formula for $G = \mathrm{SL}(2, \mathbb{C})$. Marché [17] filled all tetrahedra with a connection as explicit as possible, and computed the contribution of each tetrahedron. Garoufalidis, Thurston and Zickert [10] gave a formula for any M and $G = \mathrm{SL}(n, \mathbb{C})$. Besides, computations for concrete manifolds are seen in: Kirk and Klassen [15]; Cho, Murakami and Yokota [3]; Ham and Lee [12].

We aim to present a convenient method for computing general cohomological invariants. It is more flexible in that there needs to be no restriction on boundary.

In Section 2, we set up a general framework for $F(M, \rho)$, and reveal some fine structures around; in particular, we define $F(M, \rho)$ when M is a 3-manifold with boundary. This is largely based on [2] Section 2, which in turn was an exposition using algebraic notions of the construction given by Freed [7].

In Section 3, we propose a method for computing $F(M, \rho)$ when M is the complement of a link in S^3 . An efficient procedure is designed, starting from a link diagram. After that, if a closed 3-manifold M is given as a surgery along a link, then $F(M, \rho)$ can be written down. All these are in accord with the spirit of Turaev's *homotopy quantum field theory* [19].

Acknowledgement

The author is supported by NSFC-11771042.

2 General framework

2.1 Preparation

Convention 2.1. In this paper, all manifolds are oriented. For a manifold M , let $-M$ denote the one obtained by reversing the orientation of M .

For a topological space X , let $\Pi_1(X)$ denote the fundamental groupoid of X , i.e. the category whose objects are points of X and whose morphisms are homotopy classes of paths. Let $\mathfrak{B}(X) = \mathcal{F}un(\Pi_1(X), \Gamma)$, the set of functors $\Pi_1(X) \rightarrow \Gamma$, where Γ is viewed as a groupoid with a single object.

Suppose S is a finite subset of X such that each connected component of X contains at least one point from S . Let $\Pi_1^S(X)$ be the full subgroupoid of $\Pi_1(X)$ with S as the set of objects, then $\Pi_1^S(X)$ is equivalent to $\Pi_1(X)$ through the inclusion $S \subset X$. There is a restriction

$$\mathfrak{B}(X) \rightarrow \mathfrak{B}^S(X) := \mathcal{F}un(\Pi_1^S(X), \Gamma).$$

For $\rho \in \mathfrak{B}(X)$, abusing the notation, we denote its image in $\mathfrak{B}^S(X)$ also by ρ . In most situations in this paper, it is sufficient to consider $\mathfrak{B}^S(X)$ for some S .

Let $\Delta^k = [v_0, \dots, v_k]$ denote the standard k -simplex. For each singular k -simplex $\sigma : \Delta^k \rightarrow X$, let $\sigma_i = \sigma(v_i)$ and let $\sigma_{ij} = \sigma|_{[v_i, v_j]} : [v_i, v_j] \rightarrow X$. Abbreviate $C_k(X; \mathbb{Z})$ to $C_k(X)$.

Let $\phi \in \mathfrak{B}(X)$. Given a singular k -chain $\xi = \sum_i n_i \sigma^i \in C_k(X)$, put

$$\xi \langle \phi \rangle = \sum_i n_i \sigma^i \langle \phi \rangle \in C_k(B\Gamma), \quad (2)$$

where for each singular k -simplex $\sigma \in C_k(B\Gamma)$, we set $\sigma \langle \phi \rangle = [\phi(\sigma_{01}) | \cdots | \phi(\sigma_{k-1,k})]$.

Let A be an abelian group, for which additive notations are used, and let Γ be a discrete group. A 3-cocycle $\alpha \in Z^3(B\Gamma; A) = Z^3(\Gamma; A)$ is a function $\Gamma \times \Gamma \times \Gamma \rightarrow A$ satisfying

$$\alpha(x, y, z) - \alpha(xy, z, w) + \alpha(x, yz, w) - \alpha(x, y, zw) + \alpha(y, z, w) = 0$$

for all $x, y, z, w \in \Gamma$. Recall that (see [11] Page 89) $B\Gamma$ has a simplicial model, in which k -simplices are ordered k -tuples $[x_1 | \cdots | x_k]$ with $x_i \in \Gamma$. The boundary map $\partial_k : C_k(B\Gamma) \rightarrow C_{k-1}(B\Gamma)$ is given by

$$\partial[x_1 | \cdots | x_k] = [x_2 | \cdots | x_k] + \sum_{i=1}^{k-1} (-1)^i [x_1 | \cdots | x_i x_{i+1} | \cdots | x_k] + (-1)^k [x_1 | \cdots | x_{k-1}].$$

The value of α taking at $[x|y|z]$ is $\alpha(x, y, z)$.

2.2 Extending to manifolds with boundary

Definition 2.2. For an n -manifold M , call a singular chain $\zeta \in C_n(M)$ an *s-triangulation* if ζ represents the fundamental class $[M, \partial M]$. Let $[M]$ denote the set of s-triangulations. This is consistent with the notion of the fundamental class of M when M is closed.

Viewing \emptyset as an n -manifold, put $[\emptyset] = \{0\}$.

Given $\zeta_i \in [M_i], i = 1, \dots, r$, the meaning of $\zeta_1 \sqcup \dots \sqcup \zeta_r \in [M_1 \sqcup \dots \sqcup M_r]$ is self-evident.

Let Y be a closed surface. For $\tau \in \mathfrak{B}(Y)$, define $F(Y, \tau)$ to be the set of the functions $f : [Y] \rightarrow A$ such that $f(\xi_1) - f(\xi_2) = \alpha(\zeta \langle \tau \rangle)$ for any $\xi_1, \xi_2 \in [Y]$ and $\zeta \in C_3(Y)$ with $\partial \zeta = \xi_1 - \xi_2$. Notice two facts: (i) for any $\xi_1, \xi_2 \in [Y]$, since $\partial(\xi_1 - \xi_2) = 0$ and $H_3(Y; \mathbb{Z}) = 0$, one can find ζ such that $\partial \zeta = \xi_1 - \xi_2$; (ii) if $\partial \zeta_1 = \partial \zeta_2 = \xi_1 - \xi_2$, then $\alpha(\zeta_1 \langle \tau \rangle) = \alpha(\zeta_2 \langle \tau \rangle)$, as $\partial(\zeta_1 \langle \tau \rangle - \zeta_2 \langle \tau \rangle) = 0$ and α is a cocycle. Hence the action $A \times F(Y, \tau) \rightarrow F(Y, \tau)$ given by

$$(a, f) \mapsto a.f, \quad \text{with} \quad (a.f)(\xi) = a + f(\xi)$$

is free and transitive, so $F(Y, \tau)$ is an A -torsor, as is called in the literature.

For a closed 3-manifold X , take an arbitrary $\zeta \in [X]$, and put $F(X, \rho) = \alpha(\zeta \langle \rho \rangle)$ for any $\rho \in \mathfrak{B}(X)$. Clearly, this is in consistence with (1).

Now consider a general 3-manifold X . Write $X = X^{\text{cl}} \sqcup X'$, where X^{cl} is closed, and each connected component of X' has nonempty boundary. Then $\partial X = \partial X'$. Given $\rho \in \mathfrak{B}(X)$, let $\rho^{\text{cl}} = \rho|_{X^{\text{cl}}}$ and $\rho' = \rho|_{X'}$. For each $\xi \in [\partial X']$, define $F(X', \rho')(\xi)$ to be $\alpha(\zeta \langle \rho' \rangle) \in A$ for any $\zeta \in [X']$ (so that $\partial \zeta = \xi$). This is well-defined, thanks to the following: (i) such a ζ always exists; (ii) if $\partial \zeta_1 = \partial \zeta_2 = \xi$, then $\partial(\zeta_1 - \zeta_2) = 0$, and since $H_3(X'; \mathbb{Z}) = 0$, we may find

$\eta \in C_4(X')$ with $\partial\eta = \zeta_1 - \zeta_2$, so $\alpha(\zeta_1\langle\rho'\rangle) = \alpha(\zeta_2\langle\rho'\rangle)$. Moreover, if $\xi_1 - \xi_2 = \partial\zeta$, then taking ζ_2 with $\partial\zeta_2 = \xi_2$ and putting $\zeta_1 = \zeta + \zeta_2$, we have

$$F(X', \rho')(\xi_1) - F(X', \rho')(\xi_2) = \alpha(\zeta_1\langle\rho'\rangle) - \alpha(\zeta_2\langle\rho'\rangle) = \alpha(\zeta\langle\rho'\rangle).$$

Hence indeed $F(X', \rho') \in F(\partial X', \partial\rho')$, with $\partial\rho' = \rho'|_{\partial X'}$. Define

$$F(X, \rho) = F(X^{\text{cl}}, \rho^{\text{cl}}).F(X', \rho') \in F(\partial X', \partial\rho') = F(\partial X, \partial\rho).$$

Remark 2.3. We highlight that to determine $F(X, \rho)$, it suffices to take an arbitrary $\xi_0 \in [\partial X]$ and specify the value $F(X, \rho)(\xi_0) \in A$. Then the value of $F(X, \rho) : [\partial X] \rightarrow A$ at any ξ is given by $F(X, \rho)(\xi) = \alpha(\zeta) + F(X, \rho)(\xi_0)$, for an arbitrary ζ with $\partial\zeta = \xi - \xi_0$.

Lemma 2.4 (Gluing law). *Suppose $\partial X = Y' \sqcup Y_1 \sqcup -Y_2$, and $\varphi : Y_1 \xrightarrow{\sim} Y_2$ is an orientation-preserving homeomorphism. Let $X^\varphi = X/\{y \sim \varphi(y), y \in Y_1\}$, i.e. the manifold obtained from gluing X along φ , so that $\partial X^\varphi = Y'$; let $\text{gl}_\varphi : X \rightarrow X^\varphi$ denote the quotient map. Given $\rho \in \mathfrak{B}(X^\varphi)$, let $\tilde{\rho} = (\text{gl}_\varphi)^*(\rho)$, then for any $\xi \in [Y_1]$ and $\xi' \in [Y']$, one has*

$$F(X^\varphi, \rho)(\xi') = F(X, \tilde{\rho})(\xi' \sqcup \xi \sqcup -\varphi_\#(\xi)).$$

Proof. Take $\zeta \in C_3(X)$ with $\partial\zeta = \xi' \sqcup \xi \sqcup -\varphi_\#(\xi)$, then $(\text{gl}_\varphi)_\#(\zeta) \in [X^\varphi]$, so

$$F(X^\varphi, \rho)(\xi') = \alpha(\zeta\langle\rho\rangle) = F(X, \tilde{\rho})(\xi' \sqcup \xi \sqcup -\varphi_\#(\xi)).$$

□

We must also allow manifolds to have corners. In this paper, 3-manifolds with corners X are viewed as ordinary 3-manifolds together with a piece of information encoding how to decompose ∂X into subsurfaces along circles. For $\rho \in \mathfrak{B}(X)$, we simply define $F(X, \rho) \in F(\partial X, \partial\rho)$ as above, temporarily forgetting that X has corners. A gluing rule in this more general context can be established. But it is such an easy task that we choose not to explicitly write down.

2.3 Fundamental cycle

Motivated by [16, 18, 21], we introduce a universal notion.

Given a topological space X , define an equivalence relation on $C_k(X)$ by declaring that two singular k -simplices σ, σ' are equivalent if $\sigma_{ij} = \sigma'_{ij}$ in $\Pi_1(X)$ for all i, j , and extending linearly. Let $\overline{C}_k(X)$ denote the set of equivalence classes. Clearly $\partial_k : C_k(X) \rightarrow C_{k-1}(X)$ descends to a map $\overline{\partial}_k : \overline{C}_k(X) \rightarrow \overline{C}_{k-1}(X)$. Let \mathcal{Y}_X denote the composite

$$\mathcal{Y}_X : C_3(X) \twoheadrightarrow \overline{C}_3(X) \twoheadrightarrow \overline{C}_3(X)/\text{Im}(\overline{\partial}_4) =: \dot{C}(X).$$

For a 3-manifold X , define $F_X : [\partial X] \rightarrow \dot{C}(X)$ by sending $\xi \in [\partial X]$ to $\mathcal{Y}_X(\eta)$, for any $\eta \in [X]$ with $\partial\eta = \xi$. This is well-defined: such an η always exists; if also $\partial\eta' = \xi$, then $\eta' - \eta$ represents $0 \in H_3(X)$, so that $\eta' - \eta = \partial\mu$ for some $\mu \in C_4(X)$, hence $\mathcal{Y}_X(\eta) = \mathcal{Y}_X(\eta')$. Call the map F_X the *fundamental cycle* of X .

Remark 2.5. Let $\iota : \partial X \hookrightarrow X$ be the inclusion. Straightforward is the property that $F_X(\xi') - F_X(\xi) = \mathcal{Y}(\iota_{\#}(\zeta))$ for any $\xi, \xi' \in [\partial X]$ and $\zeta \in C_3(\partial X)$ with $\partial\zeta = \xi' - \xi$.

For any $\rho \in \mathfrak{B}(X)$ and any $\alpha \in Z^3(B\Gamma; A)$, abusing the notation, there is an induced map $(B\rho)_{\#} : \dot{C}(X) \rightarrow C_3(B\Gamma)/\text{Im}(\partial_4)$ such that the composite

$$[\partial X] \xrightarrow{F_X} \dot{C}(X) \xrightarrow{(B\rho)_{\#}} C_3(B\Gamma)/\text{Im}\partial_4 \xrightarrow{\alpha} A$$

equals $F(X, \rho)$ defined in the previous subsection.

2.4 Cycle-cocycle calculus

The name was given in [2], to mean the following procedure: given $\tau \in \mathfrak{B}(Y)$ and $\xi, \xi' \in [Y]$, to find $\zeta \in C_3(Y)$ with $\partial\zeta = \xi - \xi'$ and compute $\omega^\tau(\xi; \xi') := \alpha(\zeta(\tau))$, which is independent of the choice of ζ . We abbreviate $\omega^\tau(\xi; \xi')$ to $\omega(\xi; \xi')$ when τ is clear.

Convention 2.6. From now on, we assume that α is *strongly normalized*, meaning $\alpha(x, y, z) = 0$ whenever $1 \in \{x, y, z, xy, yz\}$, as defined in [13] Section 6.1.

Remark 2.7. Such an α can be found at least for the Chern-Simons invariant over $\text{SL}(2, \mathbb{C})$ (see [13] Lemma 6.4), and we expect similar results for more Lie groups.

If α is not strongly normalized, then the formulas below still exist, but will be more complicated. We may develop these in future work.

Notation 2.8. For $\mu, \mu' \in C_2(Y)$, suppose there exists $\zeta \in C_3(Y)$ with $\partial\zeta = \mu - \mu'$. Denote $\mu \doteq \mu'$ (resp. $\mu \equiv \mu'$) if $\alpha(\zeta(\tau)) = 0$ for all $\tau \in \mathfrak{B}(Y)$ and all normalized (resp. strongly normalized) α .

Convention 2.9. From now on, for each manifold X , write $\mathfrak{B}^0(X)$ instead of $\mathfrak{B}^S(X)$, after a finite set S is chosen.

For a planar surface, let S consist of one vertex from each component of ∂Y . For torus $\mathbb{T}^2 = S^1 \times S^1$, let $S = \{1 \times 1\}$.

In Fig. 1 we introduce some pictorial notations which are used throughout this paper.

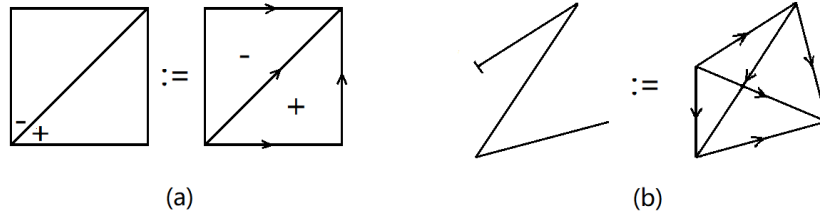

Figure 1: (a) An s-triangulation for a square; (b) a 3-simplex

Since $\partial[ABBB] = [BBB] - [ABB]$, we have $[ABB] \doteq [BBB]$; similarly, $[BAB] \doteq [BBA] \doteq [BBB]$. It then follows from $\partial[ABCB] = [BCB] - [ACB] + [ABB] - [ABC]$ that

$$[ACB] \equiv -[ABC]. \quad (3)$$

Consequently,

$$([ABC] - [ADC]) - ([DAB] - [DCB]) \equiv \partial[DABC], \quad (4)$$

as illustrated by Fig. 2.

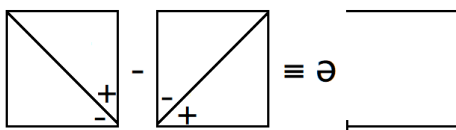

Figure 2: The identity (4)

The assumption that α is strongly normalized implies the following:

$$\alpha(x, y, (xy)^{-1}) = 0; \quad (5)$$

$$\alpha(x, y, z) = \alpha((xyz)^{-1}, x, y) = \alpha(xyz, (yz)^{-1}, z) = \alpha(x, y, z, (yz)^{-1}) = -\alpha(x, yz, z^{-1}); \quad (6)$$

the second line is illustrated in Fig. 3. These are easy to deduce and will be used implicitly from now on.

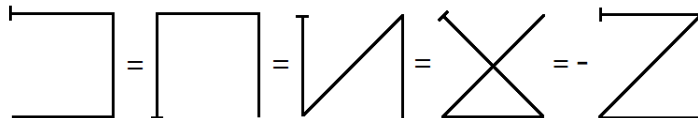

Figure 3: The reason for (6)

2.4.1 Pair of pants $P = \Sigma_{0,3}$

Let $[1\curvearrowright]$ (resp. $[2\curvearrowright]$) denote the clockwise loop from 1 (resp. 2) to itself. The other notations in the following lines deserve no explanation. Let

$$\xi_P^{\text{st}} = [0 \overset{q_1}{\curvearrowright} 1\curvearrowright] - [0 \overset{a}{\curvearrowright} 0 \overset{q_1}{\curvearrowright} 1] + [0 \overset{q_2}{\curvearrowright} 2\curvearrowright] - [0 \overset{b}{\curvearrowright} 0 \overset{q_2}{\curvearrowright} 2] + [0 \overset{a}{\curvearrowright} 0 \overset{b}{\curvearrowright} 0]. \quad (7)$$

Let $\varphi : P \rightarrow P$ denote the clockwise twist, under which the two holes are interchanged. The transformed s-triangulation is found to be

$$\varphi_{\#} \xi_P^{\text{st}} = [0 \overset{q}{\curvearrowright} 2\curvearrowright] - [0 \overset{a'}{\curvearrowright} 0 \overset{q}{\curvearrowright} 2] + [0 \overset{a'}{\curvearrowright} 0 \overset{a}{\curvearrowright} 0] + [0 \overset{q_1}{\curvearrowright} 1\curvearrowright] - [0 \overset{a}{\curvearrowright} 0 \overset{q_1}{\curvearrowright} 1],$$

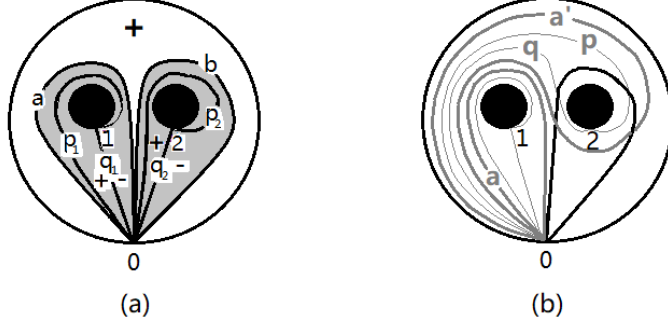

Figure 4: (a) The standard s-triangulation ξ_P^{st} of the pair of pants; (b) depicted in gray is the image of ξ_P^{st} under the twist φ

as shown in Fig. 4 (b). Then

$$\begin{aligned} \varphi\#\xi_P^{\text{st}} - \xi_P^{\text{st}} &= \partial([0 \overset{q}{\curvearrowright} 2 \overset{q_2}{\curvearrowright} 0 \overset{p_2}{\curvearrowright} 2] - [0 \overset{a}{\curvearrowright} 0 \overset{p_2}{\curvearrowright} 2 \overset{q_2}{\curvearrowright} 0] + [0 \overset{a'}{\curvearrowright} 0 \overset{q}{\curvearrowright} 2 \overset{q_2}{\curvearrowright} 0] \\ &\quad - [0 \overset{p_2}{\curvearrowright} 2 \overset{q_2}{\curvearrowright} 0 \overset{q_2}{\curvearrowright} 2] - [0 \overset{q_2}{\curvearrowright} 2 \overset{q_2}{\curvearrowright} 0 \overset{p_2}{\curvearrowright} 2] + [0 \overset{q_2}{\curvearrowright} 2 \overset{q_2}{\curvearrowright} 0 \overset{q_2}{\curvearrowright} 2]) \\ &\equiv \partial([0 \overset{q}{\curvearrowright} 2 \overset{q_2}{\curvearrowright} 0 \overset{p_2}{\curvearrowright} 2] - [0 \overset{a}{\curvearrowright} 0 \overset{p_2}{\curvearrowright} 2 \overset{q_2}{\curvearrowright} 0] + [0 \overset{a'}{\curvearrowright} 0 \overset{q}{\curvearrowright} 2 \overset{q_2}{\curvearrowright} 0]). \end{aligned}$$

Let $\tau_{y_1, y_2} \in \mathfrak{B}^0(P)$ be the one given by $[1 \overset{q_1}{\curvearrowright} 0] \mapsto 1$, $[2 \overset{q_2}{\curvearrowright} 0] \mapsto y_1$ and $[j \curvearrowright] \mapsto y_j$ for $j = 1, 2$, then

$$\omega^{\tau_{y_1, y_2}}(\varphi\#\xi_P^{\text{st}}; \xi_P^{\text{st}}) = -\alpha(y_1, y_1^{-1}y_2, y_1). \quad (8)$$

2.4.2 Disk with at least 3 holes removed

Let ξ_1, ξ_2 be the two s-triangulations shown in Fig. 5 (a), where the inner parts in light gray are similar as those in Fig. 4 (a).

For $x_1, x_2, x_3 \in \Gamma$, let $\tau_{x_1, x_2, x_3} \in \mathfrak{B}^0(\Sigma_{0,4})$ send $[j \curvearrowright]$ to x_j and $[j \curvearrowleft 0]$ to 1 for $j = 1, 2, 3$. Since

$$\xi_2 - \xi_1 = [0 \overset{a}{\curvearrowright} 0 \overset{d_2}{\curvearrowright} 0] + [0 \overset{b}{\curvearrowright} 0 \overset{c}{\curvearrowright} 0] - [0 \overset{d_1}{\curvearrowright} 0 \overset{c}{\curvearrowright} 0] - [0 \overset{a}{\curvearrowright} 0 \overset{b}{\curvearrowright} 0] = \partial[0 \overset{a}{\curvearrowright} 0 \overset{b}{\curvearrowright} 0 \overset{c}{\curvearrowright} 0],$$

we have

$$\omega^{\tau_{x_1, x_2, x_3}}(\xi_2; \xi_1) = \alpha(x_1, x_2, x_3). \quad (9)$$

In this manner, if $r \geq 3$, then an s-triangulation of $\Sigma_{0, r+1}$ corresponds to a vertex in the associahedron K_r (c.f. [1]), and given two such s-triangulations ξ, ξ' , we may find $\zeta \in C_3(\Sigma_{0, r+1})$ with $\partial\zeta = \xi - \xi'$, which corresponds to a path in K_r . Then, letting $\tau_{x_1, \dots, x_r} \in \mathfrak{B}^0(\Sigma_{0, r+1})$ send $[j \curvearrowright]$ to x_j and $[j \curvearrowleft 0]$ to 1 for $j = 1, \dots, r$, we can compute $\omega^{\tau_{x_1, \dots, x_r}}(\xi; \xi')$ by successively using (9). Call this value an *associator*; it is independent of the choice of ζ .

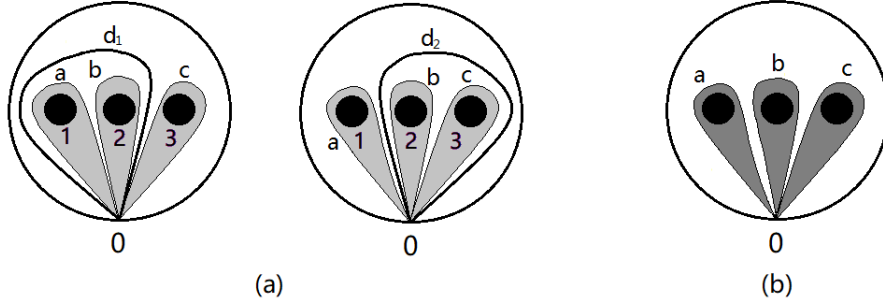

Figure 5: (a) $\xi_1, \xi_2 \in [\Sigma_{0,4}]$; (b) the white part is $[0 \overset{a}{\frown} 0 \overset{b}{\frown} 0 \overset{c}{\frown} 0]$

2.4.3 Cylinder C

We often draw a cylinder as a rectangle with a pair of opposite edges in double lines, to indicate that they are to be identified.

Let $\tilde{\xi}_C^n, \xi_C^n, \tilde{\xi}_C^{\text{st}}, \xi_C^{\text{st}}$ respectively denote the four s-triangulations in Fig. 6 from left to right. As an immediate consequence of (3), we have equivalences

$$\tilde{\xi}_C^n \equiv \xi_C^n, \quad \tilde{\xi}_C^{\text{st}} \equiv \xi_C^{\text{st}}. \quad (10)$$



Figure 6: (a) $\tilde{\xi}_C^n \equiv \xi_C^n$; (b) $\tilde{\xi}_C^{\text{st}} \equiv \xi_C^{\text{st}}$

Two cylinders can be glued into a new one: $C_1 \cup C_2 = C$, and a 3-chain $\zeta(C_1, C_2)$ whose boundary is $\xi_{C_1}^{\text{st}} + \xi_{C_2}^{\text{st}} - \xi_C^{\text{st}}$ can be found via Rule (I) shown in Fig. 7.

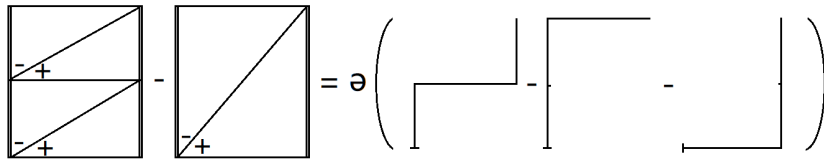

Figure 7: Rule (I): $\xi_{C_1}^{\text{st}} + \xi_{C_2}^{\text{st}} - \xi_C^{\text{st}} = \partial\zeta(C_1, C_2)$

2.4.4 Torus \mathbb{T}^2

Let $\pi : \mathbb{R}^2 \rightarrow S^1 \times S^1 = \mathbb{T}^2$ be the universal covering. For $A_i \in \mathbb{Z}^2 \subset \mathbb{R}^2$, $i = 0, 1, 2$, use $[A_0 A_1 A_2]$ to denote the singular 2-simplex $\Delta^2 \xrightarrow{\kappa} \mathbb{R}^2 \xrightarrow{\pi} \mathbb{T}^2$, where κ is the map extending

$v_i \mapsto A_i$ linearly. Similarly for singular 3-simplices in \mathbb{T}^2 .

Write elements of \mathbb{R}^2 as column vectors. Let

$$\xi_{\mathbb{T}^2}^{\text{st}} = [OW_1W_3] - [OW_2W_3] \in [\mathbb{T}^2], \quad (11)$$

$$\text{with } O = \begin{pmatrix} 0 \\ 0 \end{pmatrix}, \quad W_1 = \begin{pmatrix} 1 \\ 0 \end{pmatrix}, \quad W_2 = \begin{pmatrix} 0 \\ 1 \end{pmatrix}, \quad W_3 = \begin{pmatrix} 1 \\ 1 \end{pmatrix}. \quad (12)$$

Recall the well-known fact that the mapping class group \mathcal{M}_1 of \mathbb{T}^2 is isomorphic to $\text{SL}(2, \mathbb{Z})$, which is generated by

$$\mathbf{s} = \begin{pmatrix} 0 & 1 \\ -1 & 0 \end{pmatrix}, \quad \mathbf{t} = \begin{pmatrix} 1 & 1 \\ 0 & 1 \end{pmatrix}.$$

For $\mathbf{a} \in \text{SL}(2, \mathbb{Z})$, let $\hat{\mathbf{a}} : \mathbb{T}^2 \rightarrow \mathbb{T}^2$ denote the homeomorphism induced by the left multiplication $\mathbf{a} : \mathbb{R}^2 \rightarrow \mathbb{R}^2$. Then $\mathbf{a} \mapsto \hat{\mathbf{a}}$ sets up an isomorphism of $\text{SL}(2, \mathbb{Z})$ onto \mathcal{M}_1 .

For each $z \in \Gamma$, the map $\mathbb{Z}^3 \rightarrow A$, $(a, b, c) \mapsto \alpha(z^a, z^b, z^c)$ is a 3-cocycle of \mathbb{Z} , so, due to $H^3(\mathbb{Z}; A) = 0$, there exists $f_z : \mathbb{Z}^2 \rightarrow A$ such that

$$\alpha(z^a, z^b, z^c) = f_z(b, c) - f_z(a + b, c) + f_z(a, b + c) - f_z(a, b) \quad (13)$$

for all $a, b, c \in \mathbb{Z}$. Put

$$\epsilon(z; a, b) = f_z(a, b) - f_z(b, a); \quad (14)$$

clearly, it is independent of the choice of f_z .

Setting $c = a$ in (13), we obtain

$$\alpha(z^a, z^b, z^a) = \epsilon(z; a, a + b) - \epsilon(z; a, b). \quad (15)$$

Furthermore, in (13), the case $b = 0$ implies $f_z(a, 0) = f_z(0, c)$, the case $c = -b = a$ implies $f_z(a, -a) = f_z(-a, a)$, and

$$\begin{aligned} a = u, \quad b = -v, \quad c = v &\Rightarrow f_z(-v, v) - f_z(u - v, v) + f_z(u, 0) - f_z(u, -v) = 0, \\ a = v, \quad b = -v, \quad c = u &\Rightarrow f_z(-v, u) - f_z(0, u) + f_z(v, u - v) - f_z(v, -v) = 0. \end{aligned}$$

so that $\epsilon(z; u - v, v) = \epsilon(z; -v, u)$. Hence

$$\epsilon(z; a, b) = \epsilon(z; a + b, -a) = \epsilon(z; b, -a - b) = \epsilon(z; -a, -b). \quad (16)$$

Lemma 2.10. *Let $\phi_z \in \mathfrak{B}^0(\mathbb{T}^2)$ be determined by $S^1 \times 1 \rightarrow 1$ and $1 \times S^1 \rightarrow z$. Then*

$$\omega^{\phi_z}(\hat{\mathbf{a}}_{\#} \xi_{\mathbb{T}^2}^{\text{st}}; \xi_{\mathbb{T}^2}^{\text{st}}) = \epsilon(z; c, d) \quad \text{if } \mathbf{a} = \begin{pmatrix} a & b \\ c & d \end{pmatrix}. \quad (17)$$

Proof. The result is trivial when \mathbf{a} is the identity matrix. The proof proceeds as showing: if (17) is true for $\mathbf{a} = \mathbf{b}$, then it is also true for

$$\mathbf{a}\mathbf{s} = \begin{pmatrix} -b & a \\ -d & c \end{pmatrix}, \quad \mathbf{a}\mathbf{s}^{-1} = \begin{pmatrix} b & -a \\ d & -c \end{pmatrix}, \quad \mathbf{a}\mathbf{t} = \begin{pmatrix} a & a + b \\ c & c + d \end{pmatrix}, \quad \mathbf{a}\mathbf{t}^{-1} = \begin{pmatrix} a & b - a \\ c & d - c \end{pmatrix}.$$

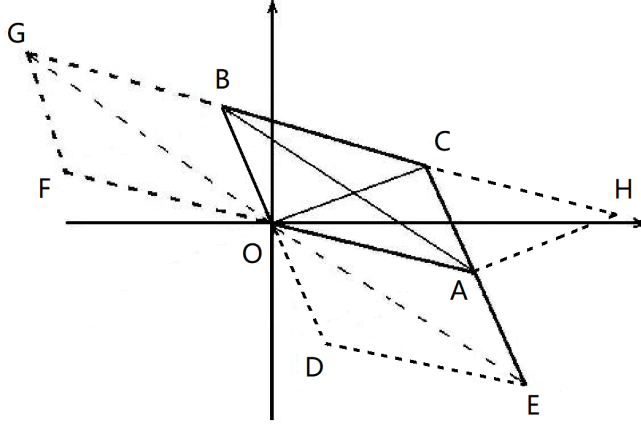

Figure 8: Cycle-cocycle calculus in genus 1

Let $A = (a, c)$, $B = (b, d)$, $C = (a + b, c + d)$. Assuming (17), we have (as in Fig. 8)

$$\begin{aligned}
\hat{\mathbf{a}}_{\#} \xi_{\mathbb{T}^2}^{\text{st}} &= [OAC] - [OBC] = [OAC] - [ACH], \\
(\hat{\mathbf{a}}\hat{\mathbf{s}})_{\#} \xi_{\mathbb{T}^2}^{\text{st}} &= [ODE] - [OAE] = [BOA] - [BCA], \\
(\hat{\mathbf{a}}\hat{\mathbf{s}}^{-1})_{\#} \xi_{\mathbb{T}^2}^{\text{st}} &= [OBG] - [OFG] = [ACB] - [AOB], \\
(\hat{\mathbf{a}}\hat{\mathbf{t}})_{\#} \xi_{\mathbb{T}^2}^{\text{st}} &= [OAH] - [OCH], \\
(\hat{\mathbf{a}}\hat{\mathbf{t}}^{-1})_{\#} \xi_{\mathbb{T}^2}^{\text{st}} &= [OAB] - [OGB] = [OAB] - [ABC].
\end{aligned}$$

Computing directly, one obtains

$$(\hat{\mathbf{a}}\hat{\mathbf{s}})_{\#} \xi_{\mathbb{T}^2}^{\text{st}} - \hat{\mathbf{a}}_{\#} \xi_{\mathbb{T}^2}^{\text{st}} = [BOA] - [BCA] - [OAC] + [OBC] \doteq \partial[OBAC],$$

hence $\omega^{\phi_z}((\hat{\mathbf{a}}\hat{\mathbf{s}})_{\#} \xi_{\mathbb{T}^2}^{\text{st}}; \hat{\mathbf{a}}_{\#} \xi_{\mathbb{T}^2}^{\text{st}}) = \alpha(z^d, z^{c-d}, z^d)$, which together with the assumption implies

$$\begin{aligned}
\omega^{\phi_z}((\hat{\mathbf{a}}\hat{\mathbf{s}})_{\#} \xi_{\mathbb{T}^2}^{\text{st}}; \xi_{\mathbb{T}^2}^{\text{st}}) &= \omega^{\phi_z}((\hat{\mathbf{a}}\hat{\mathbf{s}})_{\#} \xi_{\mathbb{T}^2}^{\text{st}}; \hat{\mathbf{a}}_{\#} \xi_{\mathbb{T}^2}^{\text{st}}) + \omega^{\phi_z}(\hat{\mathbf{a}}_{\#} \xi_{\mathbb{T}^2}^{\text{st}}; \xi_{\mathbb{T}^2}^{\text{st}}) \\
&= \alpha(z^d, z^{c-d}, z^d) + \epsilon(z; c, d) \stackrel{(15)}{=} \epsilon(z; d, c) - \epsilon(z; d, c-d) + \epsilon(z; c, d) \stackrel{(16)}{=} \epsilon(z; -d, c).
\end{aligned}$$

So (17) holds for \mathbf{as} .

Similarly, we can also prove (17) for \mathbf{as}^{-1} , $\mathbf{at}^{\pm 1}$. The reader may consult the proof of Lemma 3.4 in [2]. \square

3 A practical method for computations

The main results are Algorithm 3.2 for computing $F(M, \rho)$ when M is a link complement, and the formula (25) for $F(M, \rho)$ when M is presented as a surgery along a link.

3.1 Link complements

Let $L = \sqcup_{i=1}^n L_i \subset S^3$ be a link, where the L_i 's are connected components. Take a sufficiently large solid cylinder $SC = D^2 \times [0, 1]$ containing the tubular neighborhood $\mathcal{N}(L)$, and let $E_L = S^3 - \mathcal{N}(L)$, $E'_L = SC - \mathcal{N}(L)$, then $E_L = E'_L \cup D^3$, where $D^3 \cong S^3 - SC$ does not affect anything below. Suppose L is presented as a diagram $\mathcal{L} = \sqcup_{i=1}^n \mathcal{L}_i$, with \mathcal{L}_i corresponding to L_i , and suppose a representation $\rho_c : \pi_1(E_L) \rightarrow \Gamma$ is given via a *coloring* $c : \mathfrak{D}_{\mathcal{L}} \rightarrow \Gamma$ (where $\mathfrak{D}_{\mathcal{L}}$ is the set of directed arcs) fitting the Wirtinger presentation for $\pi_1(E_L)$.

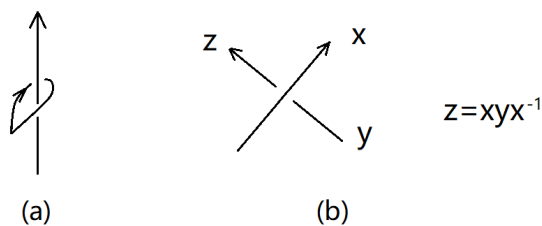

Figure 9: (a) each directed arc corresponds to an element of $\pi_1(E_L)$; (b) each crossing gives a relation

Convention 3.1. We adopt the “over presentation” for $\pi_1(E_L)$ (see [4] Chapter VI), as in Fig. 9.

Fix an orientation for E_L . For each i , fix a homeomorphism from \mathbb{T}^2 to the $\partial\mathcal{N}(L_i)$, and let $-\mathbb{T}_i^2$ stand for the i -th component of ∂E_L ; denote the image of $S^1 \times 1$ by \mathfrak{m}_i (the meridian), and denote that of $1 \times S^1$ by \mathfrak{l}_i (the longitude); label $\mathfrak{m}_i \cap \mathfrak{l}_i$ via a big dot on some arc of \mathcal{L}_i and call it *basepoint*.

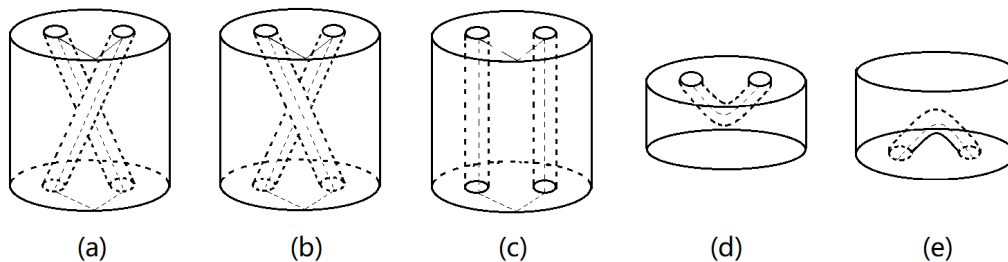

Figure 10: Basic pieces: (a) $Q(+)$; (b) $Q(-)$; (c) $Q(\parallel) = P \times [0, 1]$; (d) $Q(\cup)$; (e) $Q(\cap)$

Use horizontal lines to cut \mathcal{L} into simple pieces. The corresponding 3-dimensional picture is to use horizontal planes to decompose E'_L into layers, each of which can be chopped into “basic pieces” exhibited in Fig. 10; note that $\Sigma_{0,k} \times [0, 1]$ for $k \geq 4$ can be obtained by successively gluing $k - 2$ copies of $Q(\parallel)$. Recalling Convention 2.9, choose for E'_L the finite set consisting of the vertices, one for each circle. From c we can construct a representation (abusing the notation) $\rho_c \in \mathfrak{B}^0(E'_L)$ in a self-evident way, so that when restricted to $Q(+), Q(-)$ it is respectively in the form shown in Fig. 11 (a),(c).

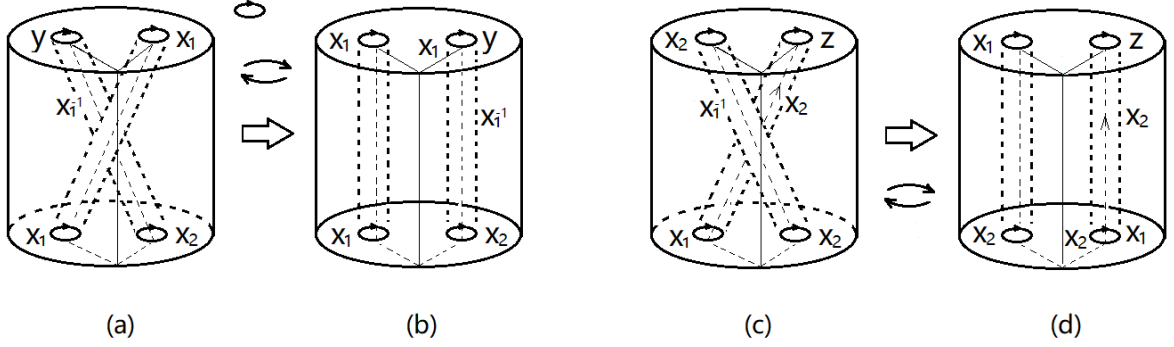

Figure 11: (a) $\rho_{x_1, x_2}^+ \in \mathfrak{B}^0(Q(+))$, with $y = x_1 x_2 x_1^{-1}$; (b) $Q(+)$ can be transformed into $Q(\parallel)$ by a twist whose restriction on the upper boundary is φ ; (c) $\rho_{x_1, x_2}^- \in \mathfrak{B}^0(Q(-))$, with $z = x_2^{-1} x_1 x_2$; (d) $Q(-)$ can be transformed into $Q(\parallel)$ by a twist whose restriction on the lower boundary is φ

For $Q(\pm)$, as parts of its boundary, let P_u, P_l respectively denote the upper and lower pair of pants, let C_o denote the outer cylinder, and $C_{i,1}, C_{i,2}$ the inner cylinders.

Let $\kappa_{x_1, x_2}^+ \in \mathfrak{B}^0(Q(+))$ and $\varrho^+ \in \mathfrak{B}^0(Q(\parallel))$ be determined by the assignments shown in Fig. 11 (a), (b), respectively. Then

$$\begin{aligned}
& F(Q(+), \kappa_{x_1, x_2}^+) (\xi_{C_o}^{\text{st}} + \xi_{P_u}^{\text{st}} - \xi_{P_l}^{\text{st}} - \xi_{C_{i,1}}^{\text{st}} - \xi_{C_{i,2}}^{\text{st}}) \\
&= F(Q(\parallel), \varrho^+) (\xi_{C_o}^{\text{st}} + \varphi_{\#} \xi_{P_u}^{\text{st}} - \xi_{P_l}^{\text{st}} - \xi_{C_{i,1}}^{\text{st}} - \xi_{C_{i,2}}^{\text{st}}) \\
&= F(Q(\parallel), \varrho^+) (\xi_{C_o}^{\text{st}} + \xi_{P_u}^{\text{st}} - \xi_{P_l}^{\text{st}} - \xi_{C_{i,1}}^{\text{st}} - \xi_{C_{i,2}}^{\text{st}}) + \omega^{\tau_{x_1, y}} (\varphi_{\#} \xi_{P_u}^{\text{st}}; \xi_{P_u}^{\text{st}}) = -\alpha(x_1, x_2 x_1^{-1}, x_1);
\end{aligned}$$

in the last equality we use $\omega^{\tau_{x_1, y}} (\varphi_{\#} \xi_{P_u}^{\text{st}}; \xi_{P_u}^{\text{st}}) = -\alpha(x_1, x_2 x_1^{-1}, x_1)$ by (8), and the equality

$$F(Q(\parallel), \varrho^+) (\xi_{C_o}^{\text{st}} + \xi_{P_u}^{\text{st}} - \xi_{P_l}^{\text{st}} - \xi_{C_{i,1}}^{\text{st}} - \xi_{C_{i,2}}^{\text{st}}) = 0$$

which is shown as follows: applying the ‘‘prism operator’’ \mathcal{P} (defined in [11] Page 112) to the homeomorphism $P_l \times I \rightarrow Q(\parallel)$, we get $\partial \mathcal{P}(\xi_{P_l}^{\text{st}}) = \xi_{C_o}^{\text{st}} + \xi_{P_u}^{\text{st}} - \xi_{P_l}^{\text{st}} - \xi_{C_{i,1}}^{\text{st}} - \xi_{C_{i,2}}^{\text{st}}$, and then

$$F(Q(\parallel), \varrho^+) (\xi_{C_o}^{\text{st}} + \xi_{P_u}^{\text{st}} - \xi_{P_l}^{\text{st}} - \xi_{C_{i,1}}^{\text{st}} - \xi_{C_{i,2}}^{\text{st}}) = \alpha(\mathcal{P}(\xi_{P_l}^{\text{st}}) \langle \varrho^+ \rangle) = 0.$$

Hence

$$\begin{aligned}
& F(Q(+), \kappa_{x_1, x_2}^+) (\xi_{C_o}^{\text{st}} + \xi_{P_u}^{\text{st}} - \xi_{P_l}^{\text{st}} - \xi_{C_{i,1}}^{\text{st}} - \xi_{C_{i,2}}^{\text{st}}) \\
&= F(Q(+), \kappa_{x_1, x_2}^+) (\xi_{C_o}^{\text{st}} + \xi_{P_u}^{\text{st}} - \xi_{P_l}^{\text{st}} - \xi_{C_{i,1}}^{\text{st}} - \xi_{C_{i,2}}^{\text{st}}) + \omega(\xi_{C_{i,2}}^{\text{st}}; \xi_{C_{i,2}}^{\text{st}}) \\
&\stackrel{(4)}{=} -\alpha(x_1, x_2 x_1^{-1}, x_1) + \alpha(x_1, x_2 x_1^{-1}, x_1) = 0.
\end{aligned} \tag{18}$$

Let $\kappa_{x_1, x_2}^- \in \mathfrak{B}^0(Q(-))$ and $\varrho^- \in \mathfrak{B}^0(Q(\parallel))$ be determined by the assignments shown in

Fig. 11 (c), (d), respectively. Then

$$\begin{aligned}
& F(Q(-), \kappa_{x_1, x_2}^-)(\xi_{C_o}^{\text{st}} + \xi_{P_u}^{\text{st}} - \xi_{P_1}^{\text{st}} - \xi_{C_{i,1}}^{\text{st}} - \xi_{C_{i,2}}^{\text{st}}) \\
&= F(Q(\parallel), \varrho^-)(\xi_{C_o}^{\text{st}} + \xi_{P_u}^{\text{st}} - \varphi_{\#}\xi_{P_1}^{\text{st}} - \xi_{C_{i,1}}^{\text{st}} - \xi_{C_{i,2}}^{\text{st}}) \\
&= F(Q(\parallel), \varrho^-)(\xi_{C_o}^{\text{st}} + \xi_{P_u}^{\text{st}} - \xi_{P_1}^{\text{st}} - \xi_{C_{i,1}}^{\text{st}} - \xi_{C_{i,2}}^{\text{st}}) - \omega^{\tau_{x_2, x_1}}(\varphi_{\#}\xi_{P_1}^{\text{st}}; \xi_{P_1}^{\text{st}}) \\
&= \alpha(x_2^{-1}, x_1, x_2) + \alpha(x_2, x_2^{-1}x_1, x_2) = 0;
\end{aligned} \tag{19}$$

we have used $\omega^{\tau_{x_2, x_1}}(\varphi_{\#}\xi_{P_1}^{\text{st}}; \xi_{P_1}^{\text{st}}) = -\alpha(x_2, x_2^{-1}x_1, x_2)$ by (8), and the equality

$$F(Q(\parallel), \varrho^-)(\xi_{C_o}^{\text{st}} + \xi_{P_u}^{\text{st}} - \xi_{P_1}^{\text{st}} - \xi_{C_{i,1}}^{\text{st}} - \xi_{C_{i,2}}^{\text{st}}) = \alpha(x_2^{-1}, x_1, x_2)$$

which is obtained similarly as above, noting that the 3rd term in (7) contributes $\alpha(x_2^{-1}, x_1, x_2)$.

Furthermore, we can easily show that $Q(\cup)$ and $Q(\cap)$ contribute nothing; the details are omitted.

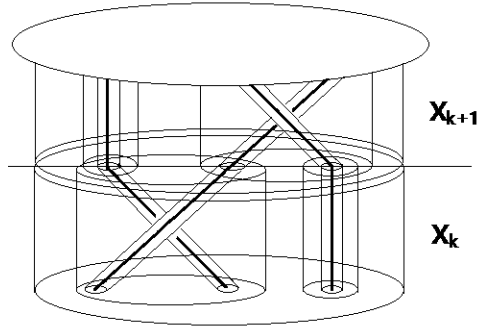

Figure 12:

Now $-\mathbb{T}_i^2$ appears to be glued from small cylinders, two for each crossing. However, the one arising from the overcrossing arc can be “absorbed”, due to Rule (I). Moreover, thanks to (10), we are able to freely turn a square in a half-circle. Consequently, remembering (18), (19), we may find $\xi_{\mathcal{L}, i} \in [-\mathbb{T}_i^2]$ by gluing small cylinders, one for each crossing according to Rule (II) (as presented in Fig. 13). Then Rule (I) can be applied to compute $\omega(\xi_{\mathcal{L}, i}; \xi_{\mathbb{T}_i^2}^{\text{st}})$.



Figure 13: Rule (II), for crossings

Finally remained is another issue. When decomposing E'_L into basic pieces, the two planar surfaces belonging to adjacent layers are usually triangulated differently, as illustrated in Fig. 12. These account for associators. To be precise, for the layers to be correctly glued, we must

re-triangulate one of these two surfaces. Let X_k denote the k -th layer, numbered from below to up, and let $\xi_k^u, \xi_k^l, \xi_k^i, \xi_k^o$ be the s -triangulations of the upper, lower, inner, outer boundary, respectively. We have computed $F(X_k, \rho_k)(\xi_k^o + \xi_k^u - \xi_k^l - \xi_k^i) = 0$, so

$$F(X_k, \rho_k)(\xi_k^o + \xi_{k+1}^l - \xi_k^l - \xi_k^i) = \omega(\xi_{k+1}^l; \xi_k^u).$$

All these are summarized to give

Algorithm 3.2. For each i , go ahead guided by the orientation of L_i , and draw a small triangulated cylinder according to Rule (II) whenever passing a crossing underneath. The result when back to the basepoint is an s -triangulation $\xi_{\mathcal{L},i}$ of $-\mathbb{T}_i^2$.

Use horizontal planes to decompose E_L^l into layers. Let μ_k^u, μ_k^l ($1 \leq k \leq m$) denote the s -triangulations of the k -th interface induced from the upper, lower layers, respectively.

Then $F(E_L, \rho_c)(\sqcup_{i=1}^n -\xi_{\mathbb{T}_i^2}^{\text{st}}) = \delta_{\mathcal{L},c} + \theta_{\mathcal{L},c}$, with

$$\delta_{\mathcal{L},c} = \sum_{i=1}^n \omega(\xi_{\mathcal{L},i}; \xi_{\mathbb{T}_i^2}^{\text{st}}); \quad \theta_{\mathcal{L},c} = \sum_{k=1}^m \theta_k, \quad \theta_k = \omega(\mu_k^u; \mu_k^l). \quad (20)$$

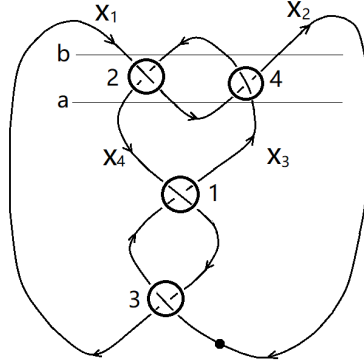

Figure 14: The diagram \mathcal{K} for 4_1 , with a basepoint chosen and crossings numbered

Example 3.3. Let K be the figure eight knot, for which a diagram \mathcal{K} together with a coloring c is given in Fig. 14.

Referring to Fig. 15 and successively applying Rule (I), we get

$$\begin{aligned} \delta_{\mathcal{K},c} &= \alpha(x_4^{-1}, x_3, x_1) - \alpha(x_4^{-1}, x_1, x_4) - \alpha(x_2, x_4^{-1}, x_1) \\ &\quad + \alpha(x_2^{-1}, x_1, x_3) - \alpha(x_2^{-1}, x_3, x_2) - \alpha(x_4, x_2^{-1}, x_3) \\ &\quad + \alpha(x_4^{-1}x_1, x_4, x_2^{-1}x_3) - \alpha(x_4^{-1}x_1, x_2^{-1}x_3, x_2) - \alpha(x_2, x_4^{-1}x_1, x_2^{-1}x_3). \end{aligned} \quad (21)$$

From Fig. 16, using (9) twice, we see that the associator at level a is

$$\theta_a = -\alpha(x_4^{-1}, x_1^{-1}, x_1) + \alpha(x_4^{-1}x_1^{-1}, x_1, x_3) = \alpha(x_4^{-1}x_1^{-1}, x_1, x_3).$$

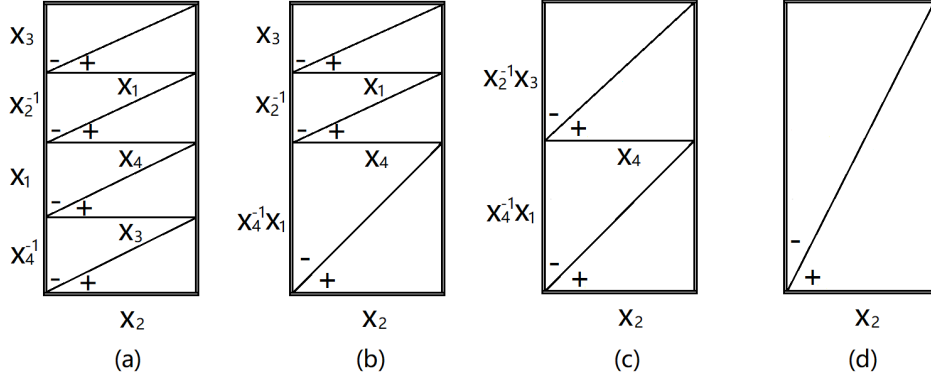

Figure 15: (a) $\xi_{\mathcal{K}}$; (d) $\xi_{\mathbb{T}^2}^{\text{st}}$; (b), (c): intermediate s-triangulations

Similarly, $\theta_b = -\alpha(x_1^{-1}x_3^{-1}, x_3, x_2)$. The associators at the other levels all vanish. Hence

$$\theta_{\mathcal{K},c} = \alpha(x_4^{-1}x_1^{-1}, x_1, x_3) - \alpha(x_1^{-1}x_3^{-1}, x_3, x_2). \quad (22)$$

Thus $F(E_{\mathcal{K}}, \rho_c)(-\xi_{\mathbb{T}^2}^{\text{st}})$ equals the sum of the right-hand-sides of (21) and (22).

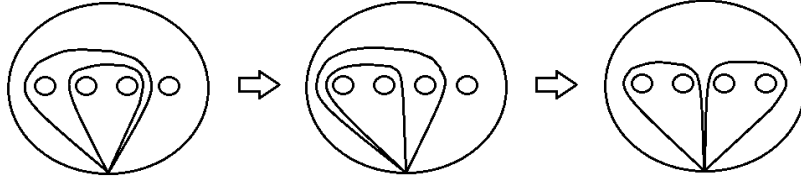

Figure 16: At level a , the transformation from μ_a^l to μ_a^u , where the representation is given by $[1^\frown] \mapsto x_4^{-1}$, $[2^\frown] \mapsto x_1^{-1}$, $[3^\frown] \mapsto x_1$, $[4^\frown] \mapsto x_3$, and $[j \frown 0] \mapsto 1$ for $j = 1, \dots, 4$

Example 3.4. Let L be the 3-chain link, which is also the $(2, 2, 2)$ -pretzel link. A diagram \mathcal{L} together with a coloring c is given in Fig. 17 (b).

Referring to Fig. 18 and applying Rule (I), we obtain

$$\begin{aligned} \delta_{\mathcal{L},c} &= \alpha(x_2, y_1, y_3) - \alpha(x_2, y_3, x_1) - \alpha(x_1, x_2, y_3) \\ &\quad + \alpha(y_1, y_2, x_3^{-1}) - \alpha(y_1, x_3^{-1}, x_2) - \alpha(x_2, y_1, x_3^{-1}) \\ &\quad + \alpha(y_2^{-1}, y_3, x_1) - \alpha(y_2^{-1}, x_1, x_3) - \alpha(x_3, y_2^{-1}, x_1). \end{aligned} \quad (23)$$

Referring to Fig. 19, we have

$$\begin{aligned} \theta_a &= (\alpha(x_3, x_3^{-1}, x_1^{-1}) - \alpha(x_1, x_2, x_2^{-1})) - \alpha(x_1, x_3, x_3^{-1}x_1^{-1}) + \alpha(x_1x_2, x_2^{-1}, x_3) \\ &= \alpha(x_1x_2, x_2^{-1}, x_3). \end{aligned}$$

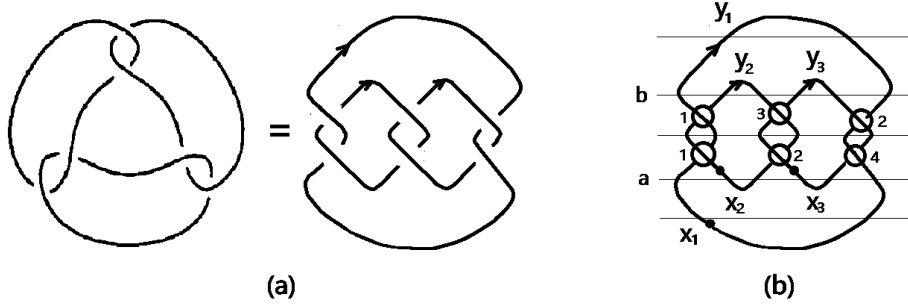

Figure 17: (a) The 3-chain link; (b) the second diagram \mathcal{L} is used for computation

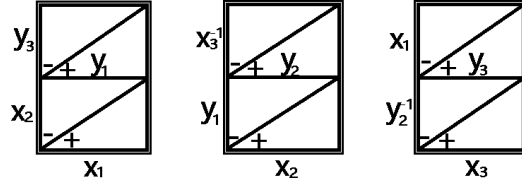

Figure 18: $\xi_{\mathcal{L},i}$, $i = 1, 2, 3$

Similarly, $\theta_b = -\alpha(y_1 y_2, y_2^{-1}, y_3)$. The associators at the other levels all vanish. So

$$\theta_{\mathcal{L},c} = \alpha(y_1 y_2, y_2^{-1}, y_3) - \alpha(x_1 x_2, x_2^{-1}, x_3). \quad (24)$$

Now $F(E_L, \rho_c)(\sqcup_{i=1}^3 -\xi_{\mathbb{T}_i^2}^{\text{st}})$ equals the sum of the right-hand-sides of (23) and (24).

3.2 Closed 3-manifolds with a surgery presentation

Consider the closed 3-manifold resulting from a surgery along a link L :

$$M = M(L; p_1/q_1, \dots, p_n/q_n) := E_L \cup_{\sqcup_{i=1}^n [p_i/q_i]} (\sqcup_{i=1}^n \text{ST}_i), \quad \text{ST}_i = D^2 \times S^1,$$

where $[p_i/q_i] = \widehat{\mathbf{a}}_i : \mathbb{T}^2 \rightarrow \mathbb{T}^2$, with $\mathbf{a}_i = \begin{pmatrix} p_i & p'_i \\ q_i & q'_i \end{pmatrix} \in \text{SL}(2, \mathbb{Z})$ for some integers p'_i, q'_i that are irrelevant; the i -th solid torus ST_i is glued onto E_L so that $[p_i/q_i](S^1 \times 1) = \mathbf{m}_i^{p'_i} \mathbf{l}_i^{q'_i}$.

Given $\rho \in \mathfrak{B}(M)$, let $\rho_L = \rho|_{E_L}$, and $\rho_i = \rho|_{\text{ST}_i}$. Applying Lemma 2.4 to $X = E_L \sqcup (\sqcup_{i=1}^n \text{ST}_i)$, $Y_1 = \sqcup_{i=1}^n -\mathbb{T}_i^2$ and $Y_2 = \partial E_L$, we deduce

$$\begin{aligned} F(M, \rho) &= F(E_L, \rho_L)(\sqcup_{i=1}^n -\xi_{\mathbb{T}_i^2}^{\text{st}}) + \sum_{i=1}^n F(\text{ST}_i, \rho_i)([p_i/q_i]_{\#}^{-1} \xi_{\mathbb{T}_i^2}^{\text{st}}) \\ &= F(E_L, \rho_L)(\sqcup_{i=1}^n -\xi_{\mathbb{T}_i^2}^{\text{st}}) + \sum_{i=1}^n \left(F(\text{ST}_i, \rho_i)(\xi_{\mathbb{T}_i^2}^{\text{st}}) + \omega^{\phi_{z^i}}([p_i/q_i]_{\#}^{-1} \xi_{\mathbb{T}_i^2}^{\text{st}}; \xi_{\mathbb{T}_i^2}^{\text{st}}) \right), \end{aligned}$$

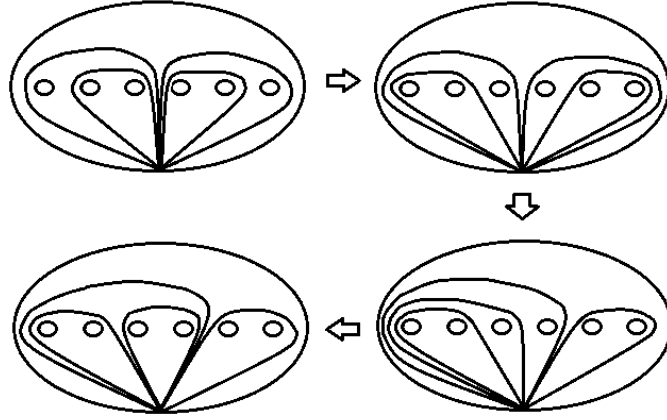

Figure 19: At level a , the transformation from μ_a^l to μ_a^u , where the representation is given by $[1\curvearrowright] \mapsto x_1$, $[2\curvearrowright] \mapsto x_2$, $[3\curvearrowright] \mapsto x_2^{-1}$, $[4\curvearrowright] \mapsto x_3$, $[5\curvearrowright] \mapsto x_3^{-1}$, $[6\curvearrowright] \mapsto x_1^{-1}$, and $[j \curvearrowleft 0] \mapsto 1$ for $j = 1, \dots, 6$

where $z_i = \rho(\mathfrak{m}_i^{p_i'} \mathfrak{l}_i^{q_i'})$, which can be characterized by $z_i^{p_i} = \rho(\mathfrak{l}_i)$ and $z_i^{-q_i} = \rho(\mathfrak{m}_i)$. Thus, using (17), we obtain

$$F(M, \rho) = F(E_L, \rho_L) \left(\sqcup_{i=1}^n -\xi_{\mathbb{T}_i^2}^{\text{st}} \right) + \sum_{i=1}^n \epsilon(z_i; -q_i, p_i). \quad (25)$$

References

- [1] C. Ceballos, F. Santos, G.M. Ziegler. *Many non-equivalent realizations of the associahedron*, *Combinatorica* 35 (2015), no. 5, 513–551.
- [2] H-M. Chen, *The Dijkgraaf-Witten invariants of Seifert 3-manifolds with orientable bases*. *J. Geom. Phys.* 108 (2016), 38–48.
- [3] J. Cho, J. Murakami, Y. Yokota, *The complex volumes of twist knots*. *Proc. AMS.* 137 (2009), no. 10, 3533-3541.
- [4] R.H. Crowell, R. Fox, *Introduction to knot theory*. Graduate Texts in Mathematics, Vol. 57, Springer-Verlage, New York, Heidelberg, Berlin, 1977.
- [5] T. Dimofte, S. Gukov, *Quantum Field Theory and the Volume Conjecture*. In: *Interactions Between Hyperbolic Geometry Quantum Topology & Number Theory*, *Contemp. Math.*, Vol. 541, Amer. Math. Soc., Providence, RI, 2011. 41-67.
- [6] P. Derbez, Y. Liu, S-C. Wang, *Chern-Simons theory, surface separability, and volumes of 3-manifolds*. *J. Topol.* 8 (2015), no. 4, 933–974.
- [7] D.S. Freed, *Higher algebraic structures and quantization*. *Commun. Math. Phys.* 159 (1994), no. 2, 343–398.

- [8] D.S. Freed, *Classical Chern-Simons Theory, 1*. Adv. Math. 113 (1995), no. 2, 237–303.
- [9] D.S. Freed, *Remarks on Chern-Simons theory*. Bull. AMS. 46 (2009), no. 2, 221–254.
- [10] S. Garoufalidis, D.P. Thurston, C.K. Zickert, *The complex volume of $SL(n, \mathbb{C})$ -representations of 3-manifolds*. Duke Math. J. 164 (2015), no. 11, 2099–2160.
- [11] A. Hatcher, *Algebraic topology*. Cambridge University Press, Cambridge, 2002.
- [12] J.Y. Ham, J. Lee, *Explicit formulae for Chern-Simons invariants of the hyperbolic orbifolds of the knot with Conway’s notation $C(2n, 3)$* . Lett. Math. Phys. 107 (2017), no. 3, 427–437.
- [13] E. Hatakenaka, T. Nosaka, *Some topological aspects of 4-fold symmetric quandle invariants of 3-manifolds*. Int. J. Math. 23 (2012), no. 7, 1250064 (30 pages).
- [14] A. Inoue, Y. Kabaya, *Quandle homology and complex volume*. Geom. Dedi. 171 (2014), no. 1, 265–292.
- [15] P.A. Kirk, E.P. Klassen, *Chern-Simons invariants of 3-manifolds and representation spaces of knot groups*. Math. Ann. 287 (1990), 343–367.
- [16] T. Kuessner, *Fundamental classes of 3-manifold group representations in $SL(4, \mathbb{R})$* . J. Knot Theor. Ramif. 26 (2017), no. 7, 1750036 (48 pages).
- [17] J. Marché, *Geometric interpretation of simplicial formulas for the Chern-Simons invariant*. Algebr. Geom. Topol. 2012 (12), no. 2, 805–827.
- [18] T. Nosaka, *On the fundamental 3-classes of knot group representations*. Geom. Dedicata 204 (2020), 1–24.
- [19] V. Turaev, *Homotopy quantum field theory*. EMS Tracts in Mathematics, Vol. 10, European Mathematical Society, 2010.
- [20] E. Witten, *Quantum field theory and the Jones polynomial*. Comm. Math. Phys. 121 (1989), no. 3, 351–399.
- [21] C.K. Zickert, *The volume and Chern-Simons invariant of a representation*. Duke Math. J. 150 (2009), 489–532.