

This is an author-created, un-copyedited version of an article accepted for publication in JINST. IOP Publishing Ltd is not responsible for any errors or omissions in this version of the manuscript or any version derived from it. The Version of Record is available online at <https://doi.org/10.1088/1748-0221/13/03/C03004>.

arXiv:1803.10642v1 [physics.ins-det] 28 Mar 2018

The PANDA Barrel DIRC

J. Schwiening^{*a}, A. Ali^{a,b}, A. Belias^a, R. Dzhygadlo^a, A. Gerhardt^a, K. Götzen^a, G. Kalicy^{†a,2},
M. Krebs^{a,b}, D. Lehmann^a, F. Nerling^{a,b}, M. Patsyuk^{‡a,3}, K. Peters^{a,b}, G. Schepers^a,
L. Schmitt^{a,c}, C. Schwarz^a, M. Traxler^a, M. Böhm^d, W. Eyrich^d, A. Lehmann^d,
M. Pfaffinger^d, F. Uhlig^d, M. Düren^e, E. Etzelmüller^e, K. Föhl^e, A. Hayrapetyan^e,
K. Kreutzfeld^e, O. Merle^e, J. Rieke^e, M. Schmidt^e, T. Wasem^e, P. Achenbach^f, M. Cardinali^f,
M. Hoek^f, W. Lauth^f, S. Schlimme^f, C. Sfiendif, and M. Thiel.^f

^aGSI Helmholtzzentrum für Schwerionenforschung GmbH, Darmstadt, Germany

^bGoethe University, Frankfurt a.M., Germany

^cFAIR, Facility for Antiproton and Ion Research in Europe, Darmstadt, Germany

^dFriedrich Alexander-University of Erlangen-Nuremberg, Erlangen, Germany

^eII. Physikalisches Institut, Justus Liebig-University of Giessen, Giessen, Germany

^fInstitut für Kernphysik, Johannes Gutenberg-University of Mainz, Mainz, Germany

March 29, 2018

Abstract

The PANDA experiment at the international accelerator Facility for Antiproton and Ion Research in Europe (FAIR) near GSI, Darmstadt, Germany will address fundamental questions of hadron physics. Excellent Particle Identification (PID) over a large range of solid angles and particle momenta will be essential to meet the objectives of the rich physics program. Charged PID for the barrel region of the PANDA target spectrometer will be provided by a DIRC (Detection of Internally Reflected Cherenkov light) detector.

The Barrel DIRC will cover the polar angle range of 22° – 140° and cleanly separate charged pions from kaons for momenta between $0.5 \text{ GeV}/c$ and $3.5 \text{ GeV}/c$ with a separation power of at least 3 standard deviations. The design is based on the successful BABAR DIRC and the SuperB FDIRC R&D with several important improvements to optimize the performance for PANDA, such as a focusing lens system, fast timing, a compact fused silica prism as expansion region, and lifetime-enhanced Microchannel-Plate PMTs for photon detection.

This article describes the technical design of the PANDA Barrel DIRC and the result of the design validation using a “vertical slice” prototype in hadronic particle beams at the CERN PS.

Keywords— Particle identification methods; Cherenkov detectors; Performance of high energy physics detectors.

*Corresponding author, J.Schwiening@gsi.de

†present address: The Catholic University of America, Washington, USA

‡present address: Massachusetts Institute of Technology, Cambridge, USA

1 Introduction

The PANDA experiment [1] will be one of the four flagship experiments at the new international accelerator complex FAIR (Facility for Antiproton and Ion Research) in Darmstadt, Germany. PANDA will address fundamental questions of hadron physics and QCD using high-intensity cooled antiproton beams with momenta between 1.5 and 15 GeV/c and a design luminosity of up to $2 \times 10^{32} \text{cm}^{-2} \text{s}^{-1}$ [2]. Excellent Particle Identification (PID) is crucial to the success of the PANDA physics program and hadronic PID in the barrel region of the target spectrometer will be performed by a DIRC (Detection of Internally Reflected Cherenkov light) counter, see Fig. 1. It is designed to cover the polar angle range from 22° to 140° and provide at least 3 standard deviations (s.d.) π/K separation up to 3.5 GeV/c, matching the expected upper limit of the final state kaon momentum distribution from simulation, see Fig. 2.

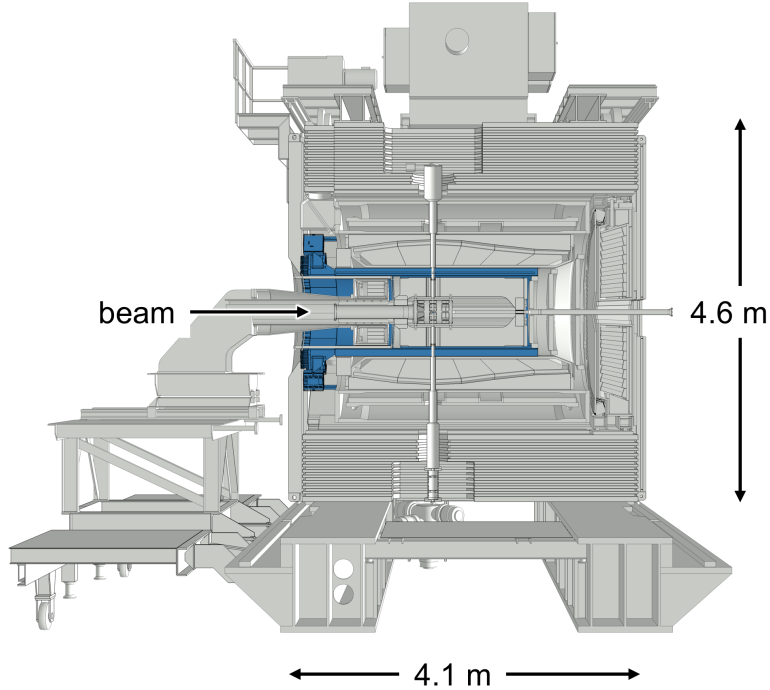

Figure 1: Cross section of the PANDA target spectrometer with the Barrel DIRC marked in blue.

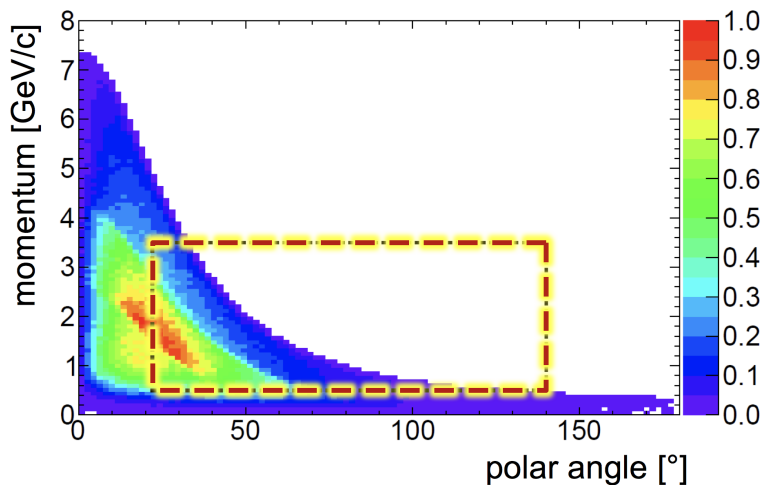

Figure 2: Simulated phase space distribution of kaons from eight benchmark physics channels at $p_{\bar{p}} = 7 \text{ GeV}/c$. The Barrel DIRC coverage is marked with the dashed rectangle.

2 Barrel DIRC Design

The baseline design of the PANDA Barrel DIRC is shown in Fig. 3 (left) and described in more detail in the Technical Design Report [3]. It is based on the successful BaBar DIRC counter [4] and key results from the R&D for the SuperB FDIRC [5] with several important improvements, such as fast photon timing and a compact imaging region. The Barrel DIRC consists of sixteen optically isolated sectors, each comprising a bar box and a synthetic fused silica (“quartz”) prism, surrounding the beam line in a 16-sided polygonal barrel with a radius of 476 mm. Each bar box contains three synthetic fused silica bars of 17 mm thickness, 53 mm width, and 2400 mm length (produced by gluing two 1200 mm-long pieces end-to-end), placed side-by-side, separated by a small air gap. A flat mirror is attached to the forward end of each bar to reflect photons towards the read-out end, where they are focused by a 3-layer spherical lens on the back of a 300 mm-deep solid prism, made of synthetic fused silica, serving as expansion volume (EV). An array of lifetime-enhanced Microchannel Plate Photomultiplier Tubes (MCP-PMTs) [6], each with 8×8 pixels of about $6.5 \times 6.5 \text{ mm}^2$ size, is placed at the back surface of the prisms to detect the photons and measure their arrival time on a total of about 11,300 pixels with a precision of 100 ps or better in the magnetic field of approximately 1 T.

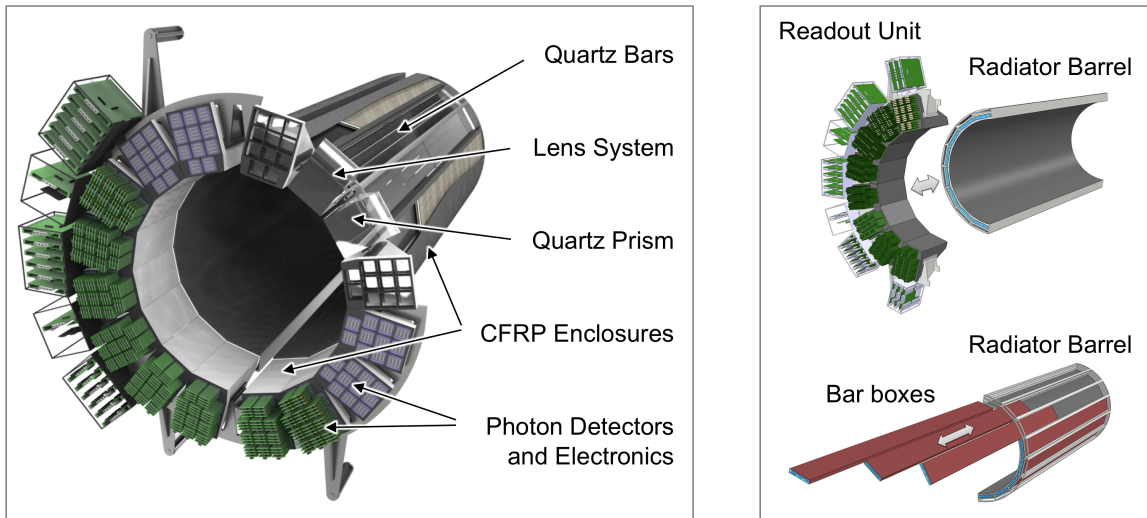

Figure 3: Left: Schematic of the PANDA Barrel DIRC baseline design. Right: Mechanical design of the PANDA Barrel DIRC in half-section views, highlighting the modular approach.

The MCP-PMTs are read out by an updated version of the HADES trigger and readout board (TRB) [7] in combination with a front-end amplification and discrimination card (DiRICH) [8] mounted directly on the MCP-PMTs. This compact FPGA-based system provides measurements of both the photon arrival time and Time-over-Threshold (TOT), which is related to the pulse height of the analog signal and can be used to monitor the sensor performance and to perform time-walk corrections to improve the precision of the photon timing.

The focusing optics has to produce a flat image to match the shape of the back surface of the fused silica prism. This is achieved by a combination of focusing and defocusing elements in a spherical triplet lens made from one layer of lanthanum crown glass (NLaK33, refractive index $n=1.786$ for $\lambda=380 \text{ nm}$) between two layers of synthetic fused silica ($n=1.473$ for $\lambda=380 \text{ nm}$). Such a 3-layer lens works without any air gaps, minimizing the photon loss that would otherwise occur at the transition from the lens to the expansion volume.

The mechanical design divides the Barrel DIRC (Fig. 3 (right)) into two main parts: The radiator barrel, which contains the radiator bars inside the bar boxes, and the readout unit, which includes the prism expansion volumes, photon sensors, and Front-End-Electronics (FEE). All major mechanical components are expected to be built from aluminum alloy and Carbon-Fiber-Reinforced Polymer (CFRP) to minimize the material budget and weight and to maximize the stiffness. The containers for the fused silica bars and prisms are kept under a constant purge from boil-off dry nitrogen to maintain a clean and dry environment and avoid possible contamination from outgassing of the glue and other materials used in the construction. The design is modular and allows the installation or removal of each individual sealed container holding the optical components. The readout unit detaches from the radiator barrel for access to the inner PANDA detectors during scheduled shutdowns.

This design differs in several key aspects from the version presented at the DIRC2015 workshop [9]. The

width of the fused silica bars was increased from 32 mm to 53 mm, reducing the number of bars per sector from 5 to 3. The opening angle of the prism was decreased from 38° to 33° , which reduced the total number of MCP-PMTs required from 282 to 176. These two changes lower the estimated fabrication cost of the PANDA Barrel DIRC components by about 20% without any significant impact on the performance [3].

3 Simulation and Reconstruction

A detailed physical simulation of the PANDA Barrel DIRC was developed in the PANDARoot framework [10, 11], which uses the Virtual Monte Carlo (VMC) approach to easily switch between Geant3 and Geant4 [12] for systematic studies. The simulation is tuned to the experimentally measured values for the quantum and collection efficiency, gain uniformity, and timing resolution of the MCP-PMTs [13]. Other features include the coefficient of total internal reflection of DIRC radiator bars as a function of photon energy [14], the bulk transmission of bars, glue, and lenses, the wavelength-dependent refractive indices of fused silica, NLaK33, and the photocathode, as well as the reflectivity of the forward mirrors. Figure 4 shows the Geant representation of the PANDA Barrel DIRC baseline design together with an example of the accumulated hit pattern produced by Cherenkov photons from 1000 π^+ tracks (red line).

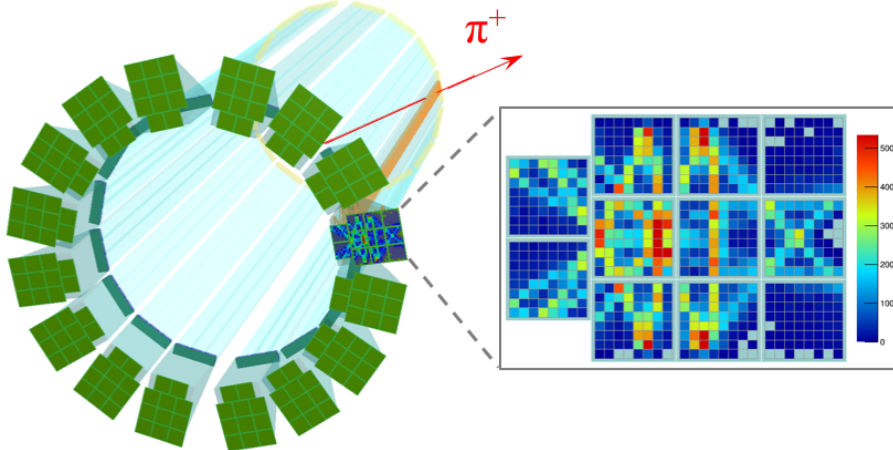

Figure 4: Geant simulation of the PANDA Barrel DIRC baseline design. The path of the Cherenkov photons is shown as orange lines. The colored histogram shows the accumulated hit pattern from 1000 π^+ at 3.5 GeV/c and 25° polar angle.

Two reconstruction approaches have been developed to evaluate the detector performance [15]. The *geometrical reconstruction*, which is based on the approach used by the BaBar DIRC [4], performs PID by reconstructing the value of the Cherenkov angle for each detected photon and using it in a track-by-track maximum likelihood test. Furthermore, this algorithm can be used to determine the Cherenkov angle per particle and the photon yield, as well as the single photon Cherenkov angle resolution. While the geometrical method relies mostly on the position of the detected photons in the reconstruction, the *time-based imaging* approach, based on the method used by the Belle II TOP [16], utilizes both the position and time information with comparable precision, and directly performs the maximum likelihood test based on the photon arrival time per pixel.

The results of the time-based imaging reconstruction of the Geant4 simulation are shown in Fig. 5. The π/K separation power is shown as a function of the particle momentum and polar angle for a timing precision per photon of 100 ps. With a separation power of 4–16 s.d., the design exceeds the PANDA PID requirement for the entire charged kaon phase space, indicated by the area below the black line.

4 Prototype Performance in Particle Beams

A series of increasingly complex PANDA Barrel DIRC system prototypes were tested in particle beams at GSI and CERN from 2011–2017 to determine the PID performance of various designs and to validate the simulation results.

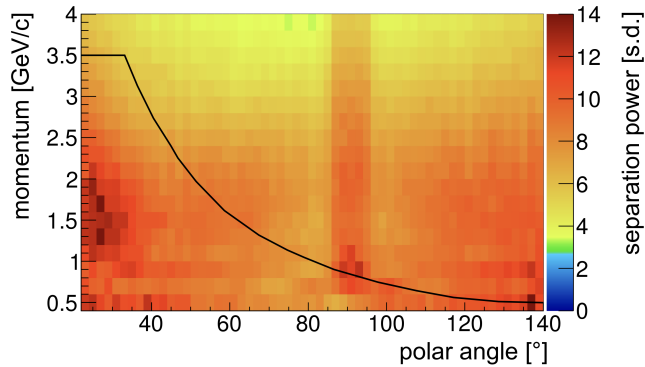

Figure 5: π/K separation power as a function of particle momentum and polar angle in Geant simulation, determined by the time-based imaging method for the baseline design. The area below the black line corresponds to the final-state phase space for charged kaons from various benchmark channels.

The most relevant system prototype test for the validation of the baseline design took place in 2015 in the T9 beamline at the CERN PS. The prototype, shown in Fig. 6, comprised the essential elements of a “vertical slice” Barrel DIRC prototype: A narrow fused silica bar ($17.1 \times 35.9 \times 1200.0 \text{ mm}^3$) coupled on one end to a flat mirror, on the other end to a 3-layer spherical focusing lens, a fused silica prism as expansion volume (with a depth of 300 mm and a top angle of 45°), an array of 3×5 MCP-PMTs, and 1500 readout electronics channels using the TRBs in combination with FPGA-based amplification and discrimination cards (PADIWA) [17], mounted directly on the MCP-PMTs.

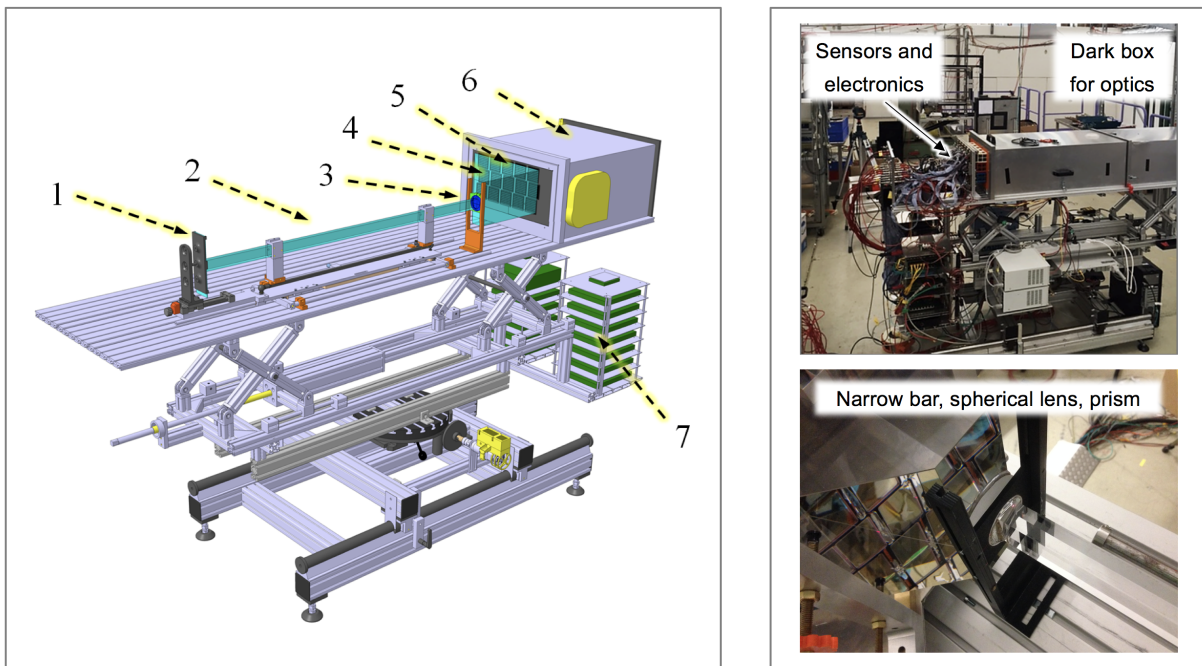

Figure 6: Left: Schematic of the prototype used at CERN in 2015, with 1: flat mirror, 2: quartz bar, 3: spherical lens, 4: quartz prism, 5: array of 5×3 MCP-PMTs, 6: readout unit, and 7: TRB stack. Right: Photograph of the 2015 prototype in the CERN T9 beam line (top), close-up of the 3-layer spherical lens between the narrow bar and the prism (bottom).

A wide range of data measurements were taken using the mixed hadron beam at different polar angles and momenta. The time difference measured by two time-of-flight stations was used to tag an event as pion or as proton. The experimental data showed good agreement of the Cherenkov hit patterns with simulation, both in the pixel space and in the photon hit time space.

Examples of the performance of the PANDA Barrel DIRC prototype with a narrow bar and a 3-layer spherical

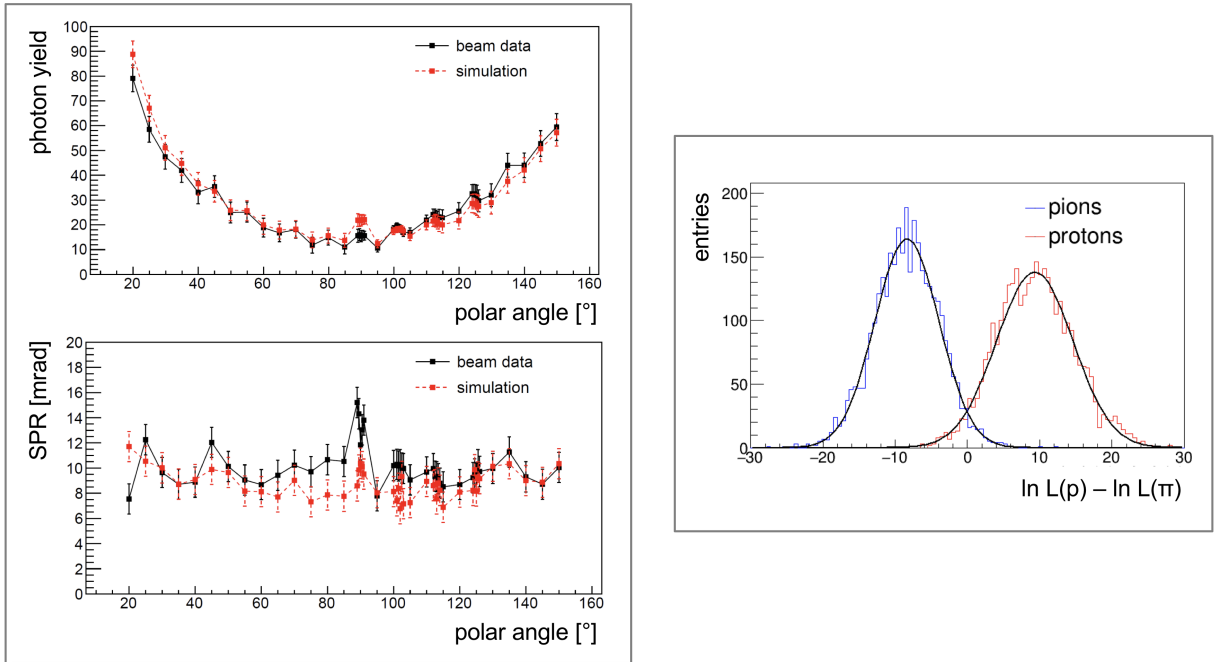

Figure 7: Performance of the PANDA Barrel DIRC prototype with a narrow bar and a 3-layer spherical lens at the CERN PS in 2015. Left: Photon yield (top) and single photon Cherenkov angle resolution (SPR) (bottom) as a function of the track polar angle for tagged protons with a momentum of 7 GeV/c. The error bars correspond to the RMS of the distribution in each bin. Right: Proton-pion log-likelihood difference distributions for proton-tagged (red) and pion-tagged (blue) beam events as result of the time-based imaging reconstruction for a beam with 7 GeV/c momentum and 25° polar angle. The π/p separation power from the Gaussian fits is 3.6 standard deviations.

lens at the CERN PS in 2015 are shown in Fig. 7. The number of Cherenkov photons from the beam data (black) ranges from 12 to 80 for tagged protons at 7 GeV/c momentum and is generally in good agreement with simulations (red). The single photon Cherenkov angle resolution (SPR) for the same data set varies between 9–14 mrad and the beam data and simulation are consistent within the RMS of the distributions. The agreement is noticeably worse for both the photon yield and the SPR at around 90° polar angle, primarily due to older and lower-gain MCP-PMTs affecting this particular angular range.

An example of the log-likelihood difference distributions obtained using time-based imaging reconstruction for a polar angle of 25° and a momentum of 7 GeV/c is shown in Fig. 7 (right). Simulation can be used to extrapolate the observed π/p performance of 3.6 ± 0.1 s.d. to the expected π/K separation power of the fully equipped PANDA Barrel DIRC. Provided that the expected technical characteristics of the MCP-PMTs, lenses, and readout electronics, in particular the photon detection efficiency and timing precision, are achieved, the result extrapolates to a π/K separation power of about 7.7 s.d. at 25° and 3.5 GeV/c in PANDA.

5 Conclusion and Outlook

The technical design of the PANDA Barrel DIRC was completed in 2017 using detailed Geant simulations and complex prototypes in particle beams at GSI and CERN. The key elements are long and narrow bars made from synthetic fused silica as radiators, spherical focusing lenses, compact fused silica prisms as expansion volumes, lifetime-enhanced MCP-PMTs as sensors, and a modular mechanical design. The performance of this design was validated with hadronic particle beams and found to meet or exceed the PANDA PID requirements for the entire kaon phase space.

The PANDA Barrel DIRC project has now progressed to the construction phase. The schedule foresees the production of the major components, in particular the fused silica bars and the MCP-PMTs, to start in 2018 and to be completed in 2021. After the assembly of the bar boxes and prism boxes, the installation of the Barrel DIRC into PANDA is expected to take place in 2023, followed by commissioning with cosmic rays and proton beams starting in late 2023, leading up to the first PANDA physics run with antiprotons in late 2024.

Acknowledgments

This work was supported by HGS-HIRe, HIC for FAIR, and by the EIC detector R&D (eRD14) fund, managed by Brookhaven National Lab. We thank GSI and CERN staff for the opportunity to use the beam facilities and for their on-site support.

References

- [1] PANDA Collaboration, *Technical Progress Report*, FAIR-ESAC/Pbar, (2005).
- [2] PANDA Collaboration, *Physics Performance Report for PANDA: Strong Interaction Studies with Antiprotons*, arXiv:0903.3905.
- [3] PANDA Collaboration, *Technical Design Report for the PANDA Barrel DIRC Detector*, arXiv:1710.00684 [physics.ins-det].
- [4] I. Adam et al., *The DIRC particle identification system for the BaBar experiment*, *Nucl. Instr. and Meth. Res. Sect. A* **538** (2005) 281.
- [5] D. A. Roberts et al., *Results from the FDIRC prototype*, *Nucl. Instr. and Meth. Res. Sect. A* **766** (2014) 114.
- [6] A. Lehmann et al., *Recent Developments with Microchannel-Plate PMTs*, *Nucl. Instr. and Meth. Res. Sect. A* **876** (2017) 42.
- [7] C. Ugur et al., *264 Channel TDC Platform applying 65 channel high precision (7.2 psRMS) FPGA based TDCs*, 2013 IEEE Nordic-Mediterranean Workshop on Time-to-Digital Converters (NoMe TDC) (2013), doi:10.1109/NoMeTDC.2013.6658234.
- [8] J. Michel et al., *Electronics for the RICH detectors of the HADES and CBM experiments*, *JINST* **12** (2017) C01072.
- [9] C. Schwarz et al., *The PANDA Barrel DIRC*, *JINST* **11** (2016) C05013.
- [10] S. Spataro, *Simulation and event reconstruction inside the PandaRoot framework*, *J. Phys. Conf. Ser.*, **119** (2008) 032035.
- [11] M. Al-Turany and F. Uhlig, *FairRoot Framework*, *Proceedings of Science (ACAT08)* (2008) 048.
- [12] S. Agostinelli et al., *Geant4 - a simulation toolkit*, *Nucl. Instr. and Meth. Res. Sect. A* **506** (2003) 250.
- [13] F. Uhlig et al., *Breakthrough in the lifetime of microchannel plate photomultipliers*, *Nucl. Instr. and Meth. Res. Sect. A* **787** (2015) 105.
- [14] J. Cohen-Tanugi et al., *Optical Properties of the DIRC Fused Silica Cherenkov Radiator*, *Nucl. Instr. and Meth. Res. Sect. A* **515** (2003) 680.
- [15] R. Dzhygadlo et al., *Simulation and reconstruction of the PANDA Barrel DIRC*, *Nucl. Instr. and Meth. Res. Sect. A* **766** (2014) 263.
- [16] M. Staric et al., *Pattern recognition for the time-of-propagation counter*, *Nucl. Instr. and Meth. Res. Sect. A* **639** (2011) 252.
- [17] M. Cardinali et al., *Frontend electronics for high-precision single photo-electron timing using FPGA-TDCs*, *Nucl. Instr. and Meth. Res. Sect. A* **766** (2014) 231.