

# Simulating the Difference between a DES and a Simple Railgun using SPICE

S. Hundertmark

French-German Research Institute of Saint-Louis, France

**Abstract**—A DES railgun increases the launch efficiency when compared to a simple railgun setup. In a NGSPICE-Simulation a DES and a simple railgun setup connected to an existing 10-MJ capacitor based power supply are compared. Important parameters like velocity, power and efficiency are used to quantify the performance gain, when using the mechanically more complex DES setup. The results of this study were used to select the simple railgun setup as the design for a new barrel to the 10-MJ power supply.

## I. INTRODUCTION

The French-German Research Institute of Saint-Louis (ISL) has an extensive experimental railgun research program. The PEGASUS railgun installation consists out of a 10 MJ capacitor based power supply and a 6m long distributed energy supply (DES) railgun barrel. One focus of research with this installation is the application of different armature concepts to improve the armature/rail contact behavior [1]. A possible, military application for powerful railguns is as artillery system. The availability of a sufficient amount of electrical power on modern ships makes the installation of electric guns on these ships an attractive possibility [2]. A military, fieldable gun system has to be as simple and robust as possible. For a DES barrel, as currently being used in the PEGASUS installation, current has to be routed to current injection points being distributed along the barrel. This makes these barrels mechanically complex and adds more weight to the front part, increasing the time needed for pointing movements. On the other hand, these barrels are more efficient than comparable simple railgun barrels. In this paper a simple railgun is compared to the DES railgun in order to be able to assess how much better the DES railgun performs. For this a setup closely resembling the current PEGASUS barrel was compared to a simple railgun of the same size and connected to the same power supply. The outcome of this study is used as a guide when deciding on the architecture of a new barrel for the PEGASUS installation.

## II. SIMPLE AND DES RAILGUN

Electromagnetic railguns do exist in a wide variety of different technical implementations [3]. The simple or breech fed railgun is a straight forward implementation of the railgun principle. It consists out of a housing, two massive electrical conductors (the rails) and a current injection bar being connected to the rails. A drawing of such a machine is shown in figure 1(top). The current injection is located at the breech and the armature is propelled by the electrical force towards the

muzzle. Seeing the simple railgun as an electrical circuit, the rails can be described by a variable resistance and a variable inductance. The actual value of the inductance  $L$  and the resistance  $R$  is calculated by:

$$L = L'x \text{ and } R = R'x \quad (1)$$

with  $x$  being the position of the armature and  $L'$  and  $R'$  are the inductance and resistance gradients, respectively. The equation 1 show, that the resistance and the inductance of the railgun grows with the progress of the armature through the barrel. The energy lost resistively is not available for accelerating the armature. The same is true for the magnetic energy being stored in the inductance of the rails after the projectile has left the launcher. Without further circuitry, this energy is dissipated into heat by the muzzle flash. But, as demonstrated experimentally in [4], it is possible to recover the magnetic energy and make it available for the next shot, thus allowing to increase the overall energy efficiency. To reduce the resistive losses from the current running through the length of the rails to the armature, the distributed energy supply (DES) railgun places energy injection points along the barrel. A 10-stage DES railgun is shown in figure 1(bottom). The breech is to the right, the muzzle to the left. The injections 1 to 10 are marked by arrows. In this figure the cables connecting the energy storage with the railgun are not visible, as they are not mounted. In a system with  $n$  stages, the stored electrical energy is split into  $n$  units which can be triggered individually. When the armature passes an injection point, it triggers the connected energy supply unit. This reduces the path length the current has to travel from the injection point to the armature.

## III. SIMULATIONS WITH NGSPICE

Using NGSPICE (version 23) [5] the electrical circuit for both railgun types were simulated. The breech voltage of a railgun can be written as [3]

$$u_{breech} = L'x \frac{dI}{dt} + IL'v + IR'x + u_{muzzle} \quad (2)$$

The first term on the right side describes the back electromotive force of the inductance of the railgun. The second term is the so called "speed voltage", the third is the voltage drop over the rail resistance and the fourth the voltage drop over the armature including the contact resistances. The individual components can be interpreted as resistances by dividing by the current  $I$ . From this operation, the electrical circuit shown in figure 2 is implemented into NGSPICE. The back electromotive force is implicitly simulated and is not

represented by a circuit element. The element  $R_{arm}$  includes the resistance from the armature and the contact resistance from the armature to the rails. The dynamical variables of the armature are derived by following the recipe as outlined in [7]. The acceleration is computed from the current using the railgun force law  $F = 1/2 L I^2$ . The velocity and position of the armature are calculated by integration. To make the simulation more realistic, mechanical friction was introduced by reducing the force acting on the projectile by 10%. The circuit shown in figure 2 represents the DES railgun. The values of the  $x_n$  variables run from 0 to the length of the stage n. As long as the armature has not yet entered a stage, the value is 0 and when the armature leaves a stage the value stays at the stage length. The more stages a DES setup has, the more the rail resistance seen by the current and therefore the energy lost by ohmic heating of the rails is reduced. Another important consequence follows from the electrical connection of the stages through the continuous rail. The magnetic energy stored in a stage the armature has left can discharge in the remaining part of the railgun. This reduces the amount of magnetic energy being stored in the railgun when the armature leaves the barrel and increases the efficiency. The electrical circuit of the simple railgun is gained by reducing the circuit in figure 2 to the rightmost stage ("Stage n").

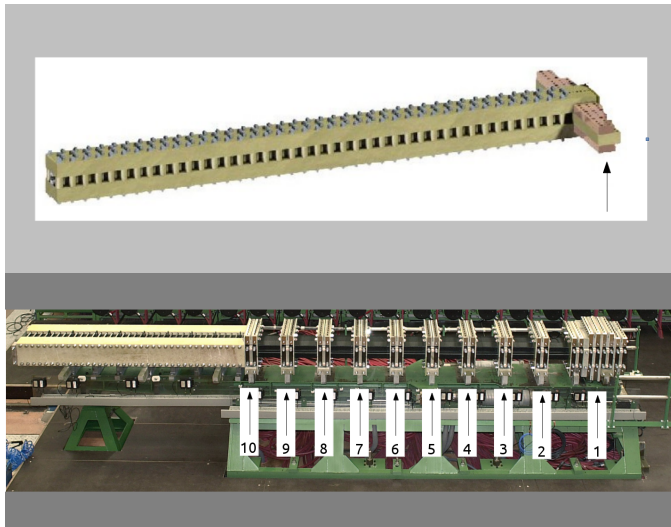

Fig. 1. Top: Simple railgun, the current injection bar is marked by an arrow. Bottom: DES railgun with 10 current injection points.

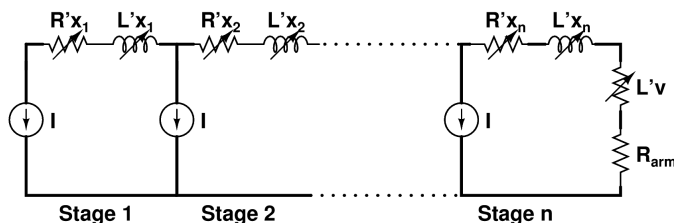

Fig. 2. Electrical circuit as implemented in NGSPICE for simulating the railgun.

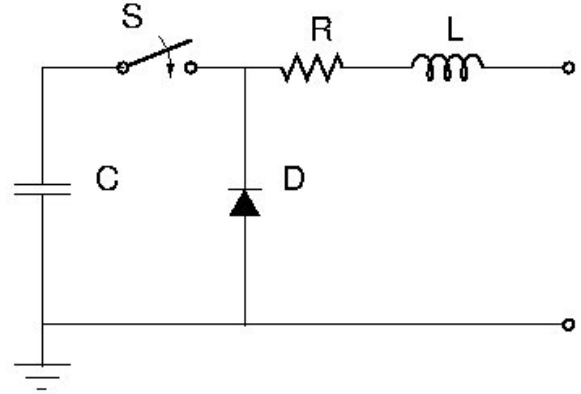
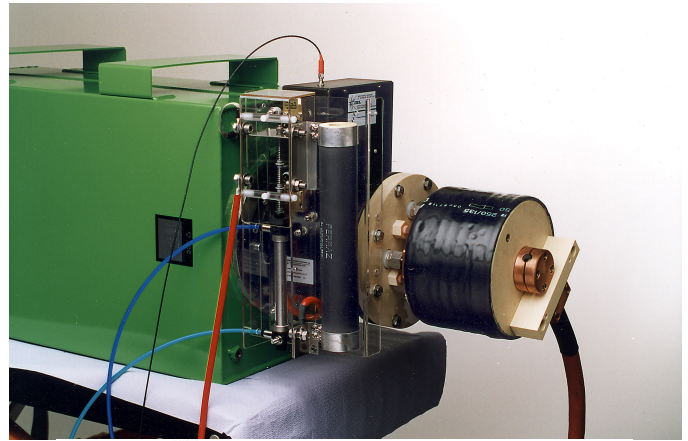

Fig. 3. Top: Capacitor module with 50 kJ storage capacity. Bottom: Electrical circuit for 50 kJ module.

### A. Simulating the Pulsed Power Supply

For comparison of the two setups a 10 MJ capacitor bank consisting out of 200 capacitor modules as shown in figure 3(top) were simulated. Each module consists out of a 50 kJ-capacitor, a thyristor switch, a crowbar diode and a pulse forming coil. A detailed description of the module and its performance is found in [8]. The figure 3(bottom) shows the electrical diagram as implemented into NGSPICE to simulate the module. To allow for better convergence of the Spice algorithm, the electrical circuit was simplified. Instead of implementing the individual resistances and inductances of all the elements, only one resistor  $R$  and one coil  $L$  was used. This is not fully describing the experimental situation, as the switching to the crowbar circuit path reduces the resistance by approx.  $0.6 \text{ m}\Omega$  and the inductance by  $0.2 \mu\text{H}$ . But simulations comparing a fully implemented 50 kJ module and the simplified circuit from above showed only minor differences in the resulting pulse height and shape. To successfully describe the experimental short-circuit data over the range of the capacitor charging voltage from 4 kV to 10 kV, the following values for the circuit were chosen:  $C=0.86 \text{ mF}$ ,  $R=11 \text{ m}\Omega$ ,  $L=30.8 \mu\text{H}$ . As shown in figure 4 the simulation does describe the experimental data in the charging voltage range from 5 kV to 10 kV quite well.

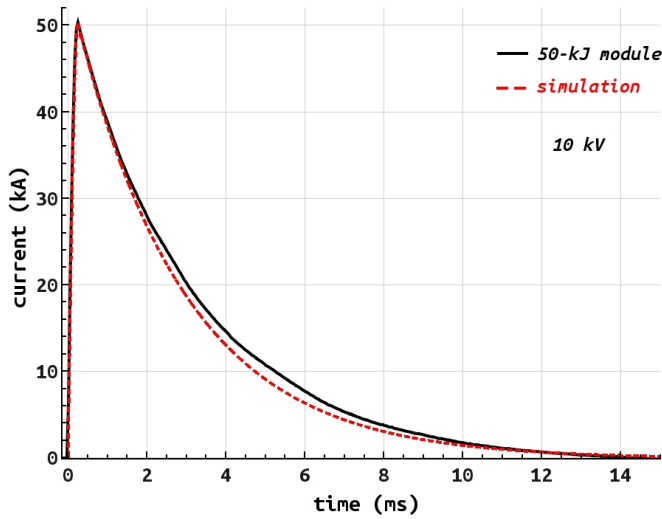
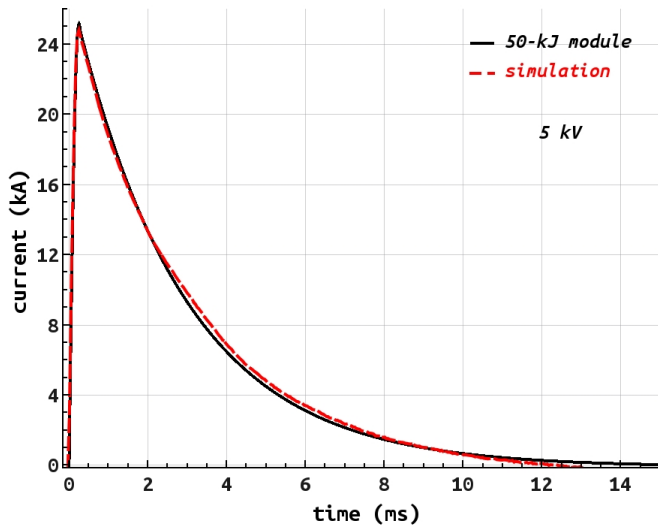

Fig. 4. Comparison of experimental short-circuit data and simulation for a 50 kJ capacitor module at a charging voltage of 5 kV (top) and 10 kV (bottom).

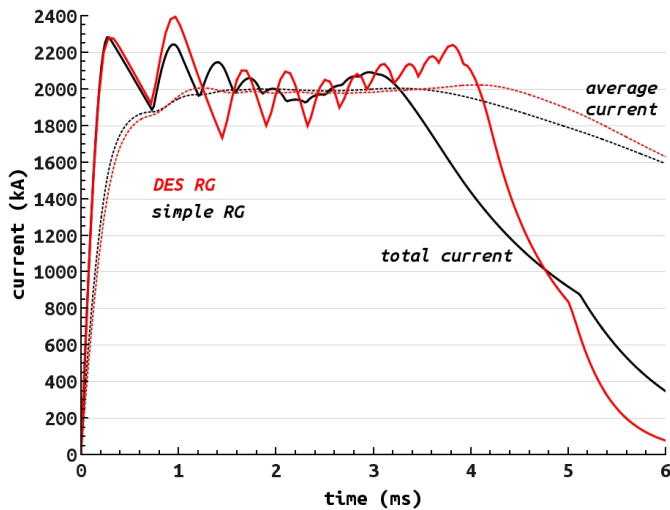

Fig. 5. Total current (solid lines) and average current (dotted line) distributions for the DES and simple railgun setup.

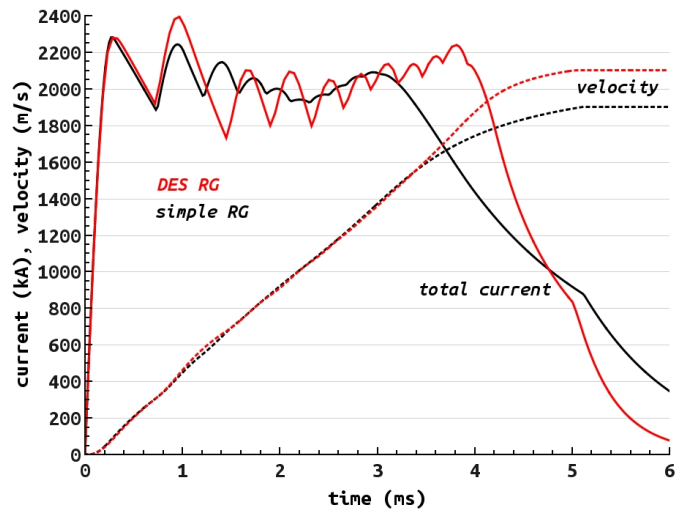

Fig. 6. Current and velocity distributions for DES and simple railgun setups.

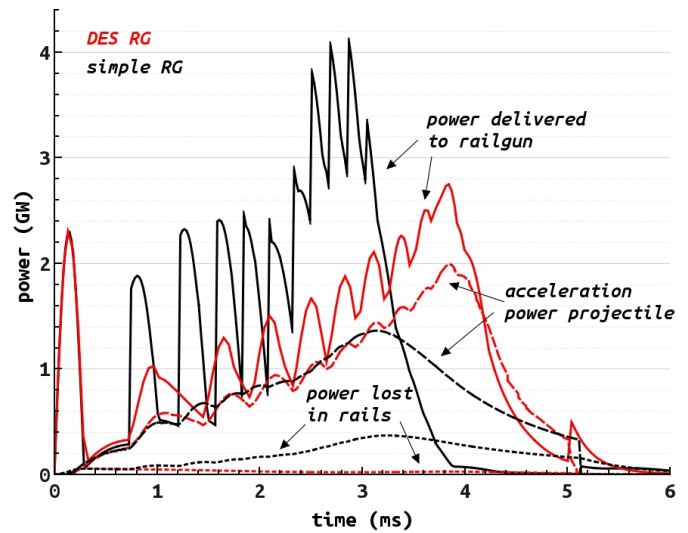

Fig. 7. Delivered electrical power to railgun, acceleration power for the projectile and power lost in rails.

## B. Simulation and Results

The energy being stored in the capacitors is dependent on the charging voltage of the capacitors. For the simulations described here, a voltage of 10.5 kV, corresponding to an electrical energy of 9.45 MJ was used. The 200 capacitor modules are arranged into 13 banks, each consisting out of 16 modules (with exception of the last bank, which has only 8 modules). Each of the bank can be triggered individually. The end-velocity of the projectile is proportional to the action integral. Therefore one strategy to optimize the velocity potential of a railgun is to arrange the discharge sequence of the capacitor banks with respect to maximizing the action integral. But, there are two important constraints for a real railgun. The housing material has to withstand the repulsion forces from the rails and the rail current carrying capacity is limited. Therefore, to obtain optimal performance a gun has to be driven close to its mechanical and current amplitude limit. A flat current profile at maximum current makes optimal

use of the available acceleration length. In a DES system, an approximate flat current profile is achieved by using equally spatial spaced current injections. As the instantaneous current distribution shows peaks whenever a bank is triggered, the average current was calculated using

$$I_{av} = \frac{1}{t} \int_0^t I dt \quad (3)$$

The distance in between the current injection points was varied to obtain a flat shape of the  $I_{av}$  trace. As a result for the DES setup, the 10 current injection points were distributed with equal distance to each other over the first 3.8 m of the acceleration length. An average current level of 2 MA was adjusted by selecting the capacitor charging voltage to 10.5 kV. For the simple, breech fed railgun setup the trigger instances of the capacitor banks were adjusted for the same level of average current for as long as possible during the acceleration. A good fit could be achieved by triggering the banks when the projectile passes equally spaced positions along the first 2.8 m of the 6 m long barrel. Figure 5 shows the current and average current distributions for the simple and the DES railgun setups. The average current distributions are quite the same up until 3.3 ms, when the simple railgun average current falls off, while for the DES railgun the current plateau level is kept until 4.2 ms. Inspecting the total current traces, both show initially (until approx. 1.2 ms) the same amplitude and behavior. Afterwards, one can see the effect of the growing inductance and resistance of the simple railgun versus the DES setup. The L-R combination acts as a variable low-pass filter with a lower cut-off frequency for the simple railgun. As a result the current trace becomes smoother with progressing acceleration time. The, on average larger resistance in the simple setup results in higher ohmic losses in the rails, but more importantly, the larger inductance translates in more energy being stored in the magnetic field generated by the rails. Both effects lead to an earlier depletion of the energy supply for the simple railgun. Shot-out of the projectile is at 5 ms for the DES and at 5.2 ms for the simple railgun setup. The projectile velocity is shown in figure 6. As the average current is the same up to 3.6 ms, the velocity is the same for both setups until this time, as well. Only afterwards, the DES system is performing better. While the DES railgun projectile reaches 2100 m/s, the simple railgun accelerates the projectile to 1900 m/s. It is interesting to note that in the case of the simple railgun a significant part of the acceleration is driven by the magnetic field stored in the railgun itself. At 4.2 ms the current starts to drop and the magnetic energy stored in the rails of the simple railgun is at its maximum. At that point in time, the projectile has reached a velocity of 1500 m/s and has passed about half of the barrel length. During the remaining barrel length the decaying magnetic field further accelerates the projectile to 1900 m/s.

### C. Delivered Power

Even so the energy being stored in the capacitor banks is the same for both setups, the required power to drive the projectile through the different setups is very different,

as shown in figure 7. For the simple railgun, the release of the energy from one bank leads to a strong peak and the width of the peaks narrows with increasing velocity. At maximum, the capacitor banks deliver close to 4.2 GW. To sustain the current level of approx. 2 MA, the banks need to be fired in close proximity in time. For the DES setup the maximum power for the banks stay below 2.8 GW. Mainly two effects drive the voltage which the power supply must overcome: The back electromotive force and the speed voltage (the first and second term in equation 2). The speed voltage is dependent on the velocity and the inductance gradient. For both setups, the acceleration is nearly constant, therefore this voltage simply grows linearly with the acceleration time. For the back electromotive force one needs to take into account the different inductance seen by the banks, which are triggered in succession. For one bank with 16 capacitor modules in parallel, the inductance including the cables is  $1.9 \mu H$ . For the DES setup the contribution to the inductance due to the rails increases with the projectile distance from the injection points. As the banks are triggered when an injection point is passed by the projectile, this inductance contribution is limited to approximately the distance in between the injection points (corresponding to about  $0.2 \mu H$ ). For the simple railgun, the additional inductance from the rails increases up to the point when the last bank has fired at half of the acceleration length. This adds  $1.5 \mu H$ , thus nearly doubling the inductance seen by a capacitor bank. Therefore, in the simple railgun case, the back electromotive force term grows to about twice its value at projectile start. This results in an earlier depletion of the energy supply for the simple railgun. In addition to the power delivered from the capacitor banks to the railgun, the power being converted into kinetic energy of the 2 kg projectiles and the power lost across the rail resistance is shown the same figure. In the case of the simple railgun, the acceleration power, reaches a maximum of 1.4 GW. After the power supply is depleted, the acceleration power is fed from the decay of the magnetic energy being stored in the railgun. This effect compensates to a large extend the drastic increase in power being delivered to the railgun between 2.5 ms and 3.4 ms. For the DES railgun the acceleration power is a large fraction of the delivered power for the whole time period. As it is the intention, when implementing a DES system, the power lost in the rail resistance is negligible for the DES setup when compared to the acceleration power. For the simple railgun the power lost in rail heating is about 400 MW, or 30% of the acceleration power. This contribution is still small, when compared to the total power delivered to the railgun.

### D. Efficiency

The efficiency of the railgun including the power supply is an important design parameter. One can define the system efficiency as:

$$\eta = \frac{E_{kin}}{E_{cap}} \quad (4)$$

Here  $E_{kin}$  is the kinetic energy of the projectile and  $E_{cap}$  is the energy initially stored in the capacitor banks. For the simple railgun setup with a muzzle velocity of 1900 m/s, the

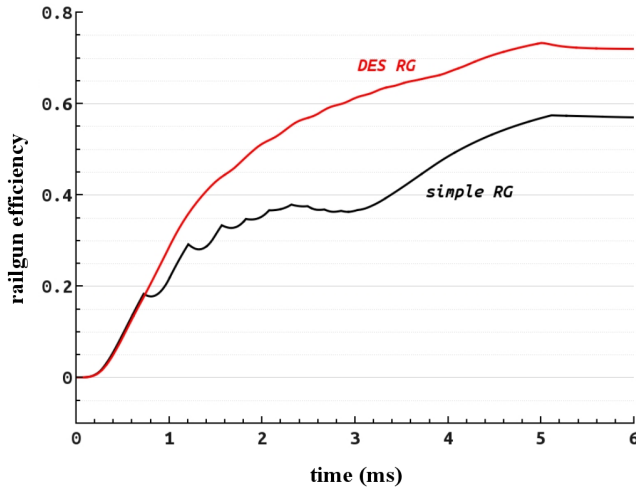

Fig. 8. Railgun efficiency for the DES and simple railgun setup.

system efficiency is  $\eta = 38\%$ , while the DES system reaches an efficiency  $\eta = 46\%$ . It is common use to rate electrical generators or engines by a efficiency that relates only to the machine, not taking into account auxiliary systems. Therefore we define here a railgun efficiency  $\eta^*$ , that replaces the energy stored in the capacitor by the energy delivered to the current injection points  $E_{delivered}$

$$\eta^* = \frac{E_{kin}}{E_{delivered}} \quad (5)$$

For the two types of railguns figure 8 shows the traces of the railgun efficiency. During the first phase of the acceleration, the power supply keeps the current at the plateau level. For the simple setup, this is until 3.3ms, for the DES setup until 4.2ms. Afterwards the current through the armature is supported by the decaying magnetic field energy in the railgun rails. This increases the efficiency, as it converts intermediately stored magnetic energy into kinetic energy. The inductance of the simple railgun system being used when the power supply units are exhausted is much larger than for the DES setup. This effect increase the efficiency from 40% at the time when the power supply is depleted to 57% at shot-out. For the DES setup this increase is smaller, from 67% to 73%. Using the system efficiency and the railgun efficiency one can calculate the efficiency for the power supply bank including the cables to 64% for the DES and 67% for the simple railgun setup. The efficiency for the simple railgun setup is higher, because the active time of the power supply is shorter, slightly reducing the ohmic losses.

#### IV. SUMMARY

Using an existing 10MJ power supply two different railgun setups were simulated using a SPICE algorithm. The performance of both were investigated and compared. The main results of this study are summarized in table I. For a given electrical energy the DES setup is superior in all aspects concerning the electrical and dynamical performance. It accelerates a 2kg mass to 2100 m/s, this is 11% faster then

|                 | Simple   | DES      |
|-----------------|----------|----------|
| $E_{cap}$       | 9.45 MJ  | 9.45 MJ  |
| $E_{delivered}$ | 6.33 MJ  | 6.1 MJ   |
| velocity        | 1900 m/s | 2100 m/s |
| $\eta$          | 38%      | 46%      |
| $\eta^*$        | 57%      | 73%      |

TABLE I  
SUMMARY OF THE RESULTS FOR THE SIMULATIONS OF A SIMPLE SETUP AND DES RAILGUN SETUP.

the 1900 m/s of the simple railgun. For the railgun efficiency the difference is even larger, the DES setup reaches 73% which can be compared to 57% for the simple railgun. But the details of the acceleration process and the differences in power requirement let this large difference shrink, when the overall system efficiency is looked at: 38% for the simple railgun and 46% for the DES system. This means that the efficiency difference is halved from a difference of 16% to "only" 8%. This surprising effect comes from the fact, that the power supply losses (including cables) are larger for the DES setup than for the simple setup. As a conclusion, the simplicity of the simple railgun setup, when connected to the existing power supply does comes at a cost of velocity (-11%) and efficiency (-8%). These differences are not large. Apart from these performance factors, there are others, like cost of manufacture for the launcher and rails, serviceability, possibility to modify the launcher caliber or rail dimensions and accessibility of the acceleration volume. In the case where a new lab-launcher needed to be designed, these factors tipped the balance in favor of the simple railgun setup.

#### REFERENCES

- [1] S. Hundertmark, D. Simicic, G. Vincent, *Acceleration of Aluminum Booster Projectiles With PEGASUS*, IEEE Transactions on Plasma Science, Vol. 43, No. 5, May 2015.
- [2] S. Hundertmark, D. Lancelle, *A Scenario for a Future European Shipboard Railgun*, IEEE Transactions on Plasma Science, Vol. 43, No. 5, May 2015.
- [3] W. Ying, R. A. Marshall, C. Shukang, *Physics of Electric Launch*, Science Press, Beijing, 2004, ISBN 7-03-012821-4.
- [4] O. Liebfried and V. Brommer, *A Four-Stage XRAM Generator as Inductive Pulsed Power Supply for a Small-Caliber Railgun*, IEEE Transactions on Plasma Science, Vol. 41, No. 10, October 2013.
- [5] NGSPICE is a Spice simulation program under the BSD license. <http://ngspice.sourceforge.net/index.html>.
- [6] E. Spahn, M. Lichtenberger, F. Hatterer, Pulse forming network for the 10 MJ-railgun PEGASUS, *5<sup>th</sup> European Symposium on Electromagnetic Launch Technology*, Toulouse, France, 10–13 April 1995.
- [7] R. A. Marshall, W. Ying, *Railguns: their Science and Technology*, China Machine Press, Beijing, 2004, ISBN 7-111-14013-3.
- [8] E. Spahn, G. Buderer, A flexible pulse power supply for EM- and ETC-launchers, *12<sup>th</sup> IEEE International Pulsed Power Conference*, 1999. *Digest of Technical Papers*, Vol. 2, 27-30 June 1999.