

Alternating Optimization Techniques for Power Allocation and Receiver Design in Multihop Wireless Sensor Networks

Tong Wang, Rodrigo C. de Lamare, *Senior Member, IEEE*, and Anke Schmeink, *Member, IEEE*

Abstract—In this paper, we consider a multihop wireless sensor network with multiple relay nodes for each hop where the amplify-and-forward scheme is employed. We present algorithmic strategies to jointly design linear receivers and the power allocation parameters via an alternating optimization approach subject to different power constraints which include global, local and individual ones. Two design criteria are considered: the first one minimizes the mean-square error and the second one maximizes the sum-rate of the wireless sensor network. We derive constrained minimum mean-square error and constrained maximum sum-rate expressions for the linear receivers and the power allocation parameters that contain the optimal complex amplification coefficients for each relay node. An analysis of the computational complexity and the convergence of the algorithms is also presented. Computer simulations show good performance of our proposed methods in terms of bit error rate and sum-rate compared to the method with equal power allocation and an existing power allocation scheme.

Index Terms—Minimum mean-square error (MMSE) criterion, maximum sum-rate (MSR) criterion, power allocation, multihop transmission, wireless sensor networks (WSNs), relays

I. INTRODUCTION

Recently, wireless sensor networks (WSNs) have attracted a great deal of research interest because of their unique features that allow a wide range of applications in the areas of defence, environment, health and home [1]. WSNs are usually composed of a large number of densely deployed sensing devices which can transmit their data to the desired destination through multihop relays [2]. Considering the traditional wireless networks such as cellular systems, the primary goal in such systems is to provide high QoS and bandwidth efficiency. The base stations have easy access to the power supply and the mobile user can replace or recharge exhausted batteries in the handset [1]. However, power conservation is getting more important, especially for WSNs. One of the most important constraints on WSNs is the low power consumption requirement as sensor nodes carry limited, generally irreplaceable, power sources. Therefore, low complexity and high energy efficiency are the most important design characteristics for

WSNs. In a cooperative WSN, nodes relay signals to each other in order to propagate redundant copies of the same signals to the destination nodes. Among the existing relaying schemes, the amplify-and-forward (AF) and the decode-and-forward (DF) are the most popular approaches [3], [4]. In the AF scheme, the relay nodes amplify the received signal and rebroadcast the amplified signals toward the destination nodes. In the DF scheme, the relay nodes first decode the received signals and then regenerate new signals to the destination nodes subsequently.

Some power allocation methods have been proposed for WSNs to obtain the best possible signal-to-noise ratio (SNR) or best possible quality of service (QoS) [5], [6] at the destinations. By adjusting appropriately the power levels used for the links between the sources, the relays and the destinations, significant performance gains can be obtained for a given power budget. Most of the research on power allocation for WSNs are based on the assumption of perfect synchronization and available channel state information (CSI) at each node. A WSN is said to have full CSI when all of its nodes have access to accurate and up-to-date CSI. When full CSI is available to all the nodes, the power of each node can be optimally allocated to improve the system efficiency and lower the outage probability [7] or bit error rate (BER) [8], [9].

In WSNs, some power allocation problems can be formulated as centralized or distributed optimization problems subject to power constraints on certain groups of signals. For the centralized schemes [10], [11], a network controller is required which is responsible for monitoring the information of the whole network such as the CSI and SNR, calculating the optimum power allocation parameters of each link and sending them to all nodes via feedback channels. This scheme considers all the available links but it has two major drawbacks. The first one is the high computational burden and storage demand at the network controller. The second one is that it requires a significant amount of control information provided by feedback channels which leads to a loss in bandwidth efficiency. For the distributed schemes [12], each node only needs to have the knowledge of its 'partner' information and calculate its own power allocation parameter. Therefore, a distributed scheme requires less control information and is ideally suited to WSNs. However, the performance of distributed schemes is inferior to centralized schemes [13].

Due to the inherent limitations in the sensor node size, power and cost [1], they are only able to communicate in a short range. Therefore, multihop communication [14]

Copyright (c) 2013 IEEE. Personal use of this material is permitted. However, permission to use this material for any other purposes must be obtained from the IEEE by sending a request to pubs-permissions@ieee.org.

T. Wang and A. Schmeink are with the Institute for Theoretical Information Technology, RWTH Aachen University, Germany.

R. C. de Lamare is with CETUC / PUC-Rio, Brazil and Department of Electronics, University of York, U.K.

The work was originally funded by the UK MoD, the University of York and was supported by DFG grant SCHM 2643/4-1 and the Alexander von Humboldt Foundation

is employed to enhance the coverage of WSNs. By using multihop transmissions, the rapid decay of the received signal which is caused by the increased transmission distance can be overcome. Moreover, pathways around the obstacles between the source and destination can be provided to avoid the signal shadowing [15]. Several works about power allocation of multihop transmission systems have been proposed in [16]-[20]. The work reported in [16] develops a cross-layer model for multihop communication and analyzes the energy consumption of multihop topologies with equal distance and optimal node spacing. Centralized and Distributed schemes for power allocation are presented to minimize the total transmission power under a constraint on the BER at the destination in [17] and [18]. In [19], two optimal power allocation schemes are proposed to maximize the instantaneous received SNR under short-term and long-term power constraints. In [20], the outage probability is considered as the optimization criterion to derive the optimal power allocation schemes under a given power budget for both regenerative and non-regenerative systems.

In this paper, we consider a general multihop WSN where the AF relaying scheme is employed. The proposed strategy is to jointly design the linear receivers and the power allocation parameters that contain the optimal complex amplification coefficients for each relay node via an alternating optimization approach [21], [22]. Two kinds of linear receivers are designed, the minimum mean-square error (MMSE) receiver and the maximum sum-rate (MSR) receiver. They can be considered as solutions to constrained optimization problems where the objective function is the mean-square error (MSE) cost function or the sum-rate (SR) and the constraint is a bound on the power levels among the relay nodes. Then, the constrained MMSE or MSR expressions for the linear receiver and the power allocation parameter can be derived. The major novelty in these strategies presented here is that they are applicable to general multihop WSNs with multi source nodes and destination nodes, as opposed to the simple two-hop WSNs with one pair of source-destination nodes [5], [23], [24]. Unlike the previous works on the power allocation for multihop systems in [16]-[20], in our work, the power allocation and receiver coefficients are jointly optimized. The joint strategies were proposed for a two-hop WSN with multiple relay nodes in our previous work [25]. In order to increase the applicability of our investigation, in this paper, we develop joint strategies for general multihop WSNs. They can be considered as an extension of the strategies proposed for the two-hop WSNs and more complex mathematical derivations are presented. Moreover, different kinds of power constraints can be considered and compared. For the MMSE receiver, we present three strategies where the allocation of power level across the relay nodes is subject to global, local and individual power constraints. Another fundamental contribution of this work is the derivation of a closed-form solution for the Lagrangian multiplier (λ) that arises in the expressions of the power allocation parameters. For the MSR receiver, the local power constraints are considered. We propose a strategy that employs iterations with the Generalized Rayleigh Quotient [27] to solve the optimization problem in an alternating fashion. Some preliminary results of these work have been reported in [26].

The main contributions of this paper can be summarized as:

- 1) Constrained MMSE expressions for the design of linear receivers and power allocation parameters for multihop WSNs. The constraints include the global, local and individual power constraints.
- 2) Constrained MSR expressions for the design of linear receivers and power allocation parameters for multihop WSNs subject to local power constraints.
- 3) Alternating optimization algorithms that compute the linear receivers and power allocation parameters in 1) and 2) to minimize the mean-square error or maximize the sum-rate of the WSN.
- 4) Analysis of the computational complexity and the convergence of the proposed optimization algorithms.

The rest of this paper is organized as follows. Section II describes the general multihop WSN system model. Section III develops three joint MMSE receiver design and power allocation strategies subject to three different power constraints. Section IV develops the joint MSR receiver design and power allocation strategy subject to local power constraints. Section V contains an analysis of the computational complexity and the convergence. Section VI presents and discusses the simulation results, while Section VII provides some concluding remarks.

II. MULTIHOP WSN SYSTEM MODEL

Consider a general m -hop wireless sensor network (WSN) with multiple parallel relay nodes for each hop, as shown in Fig. 1. The WSN consists of N_0 source nodes, N_m destination nodes and N_r relay nodes which are separated into $m - 1$ groups: N_1, N_2, \dots, N_{m-1} . The index refers to the number of nodes after a given phase of transmission starting with 0 and going up to $m - 1$. The proposed optimization algorithms in this paper refer to a particular instance, for which the roles of the nodes acted as sources, relays and destinations have been pre-determined. In subsequent time slots these roles can be swapped so that all nodes can actually work as potential sources. We concentrate on a time division scheme with perfect synchronization, for which all signals are transmitted and received in separate time slots. The sources first broadcast the $N_0 \times 1$ signal vector \mathbf{s} which contains N_0 signals in parallel to the first group of relay nodes. We consider an amplify-and-forward (AF) cooperation protocol in this paper. An extension to other cooperation protocols is straightforward. Each group of relay nodes receives the signals, amplifies and rebroadcasts them to the next group of relay nodes (or the destination nodes). In practice, we need to consider the constraints on the transmission policy. For example, each transmitting node would transmit during only one phase. In our WSN system, we assume that each group of relay nodes transmits the signal to the nearest group of relay nodes (or the destination nodes) directly. We can use a block diagram to indicate the multihop WSN system as shown in Fig. 2. Let \mathbf{H}_s denote the $N_1 \times N_0$ channel matrix between the source nodes and the first group of relay nodes, \mathbf{H}_d denote the $N_m \times N_{m-1}$ channel matrix between the $(m - 1)$ th group of relay nodes and destination

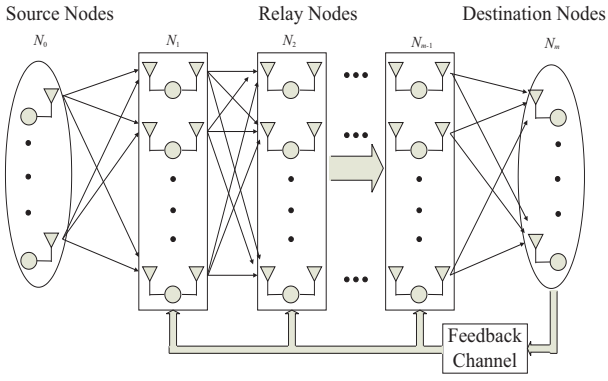

Fig. 1. An m -hop WSN with N_0 source nodes, N_m destination nodes and N_r relay nodes.

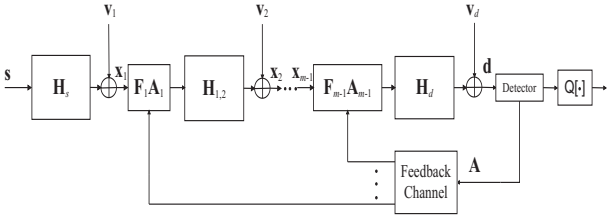

Fig. 2. Block diagram of the multihop WSN system.

nodes, and $\mathbf{H}_{i-1,i}$ denote the $N_i \times N_{i-1}$ channel matrix between two groups of relay nodes as described by

$$\mathbf{H}_s = \begin{bmatrix} \mathbf{h}_{s,1} \\ \mathbf{h}_{s,2} \\ \vdots \\ \mathbf{h}_{s,N_1} \end{bmatrix}, \quad \mathbf{H}_d = \begin{bmatrix} \mathbf{h}_{m-1,1} \\ \mathbf{h}_{m-1,2} \\ \vdots \\ \mathbf{h}_{m-1,N_m} \end{bmatrix}, \quad \mathbf{H}_{i-1,i} = \begin{bmatrix} \mathbf{h}_{i-1,1} \\ \mathbf{h}_{i-1,2} \\ \vdots \\ \mathbf{h}_{i-1,N_i} \end{bmatrix}, \quad (1)$$

where $\mathbf{h}_{s,j} = [h_{s,j,1}, h_{s,j,2}, \dots, h_{s,j,N_0}]$ for $j = 1, 2, \dots, N_1$ denote the channel coefficients between the source nodes and the j th relay of the first group of relay nodes, $\mathbf{h}_{m-1,j} = [h_{m-1,j,1}, h_{m-1,j,2}, \dots, h_{m-1,j,N_{m-1}}]$ for $j = 1, 2, \dots, N_m$ denote the channel coefficients between the $(m-1)$ th group of relay nodes and the j th destination node. Further, $\mathbf{h}_{i-1,j} = [h_{i-1,j,1}, h_{i-1,j,2}, \dots, h_{i-1,j,N_{i-1}}]$ for $j = 1, 2, \dots, N_i$ denotes the channel coefficients between the $(i-1)$ th group of relay nodes and the j th relay of the i th group of relay nodes. The received signal at the i th group of relay nodes (\mathbf{x}_i) for each phase can be expressed as:

Phase 1:

$$\mathbf{x}_1 = \mathbf{H}_s \mathbf{s} + \mathbf{v}_1, \quad (2)$$

$$\mathbf{y}_1 = \mathbf{F}_1 \mathbf{x}_1, \quad (3)$$

Phase 2:

$$\mathbf{x}_2 = \mathbf{H}_{1,2} \mathbf{A}_1 \mathbf{y}_1 + \mathbf{v}_2, \quad (4)$$

$$\mathbf{y}_2 = \mathbf{F}_2 \mathbf{x}_2, \quad (5)$$

⋮

Phase i : ($i = 3, 4, \dots, m-1$)

$$\mathbf{x}_i = \mathbf{H}_{i-1,i} \mathbf{A}_{i-1} \mathbf{y}_{i-1} + \mathbf{v}_i, \quad (6)$$

$$\mathbf{y}_i = \mathbf{F}_i \mathbf{x}_i, \quad (7)$$

At the destination nodes, the received signal can be expressed as

$$\mathbf{d} = \mathbf{H}_d \mathbf{A}_{m-1} \mathbf{y}_{m-1} + \mathbf{v}_d, \quad (8)$$

where \mathbf{v} is a zero-mean circularly symmetric complex additive white Gaussian noise (AWGN) vector with covariance matrix $\sigma^2 \mathbf{I}$. The matrix $\mathbf{A}_i = \text{diag}\{a_{i,1}, a_{i,2}, \dots, a_{i,N_i}\}$ is a diagonal matrix whose elements represent the amplification coefficient of each relay of the i th group. The matrix $\mathbf{F}_i = \text{diag}\{E(|x_{i,1}|^2), E(|x_{i,2}|^2), \dots, E(|x_{i,N_i}|^2)\}^{-\frac{1}{2}}$ denotes the normalization matrix which can normalize the power of the received signal for each relay of the i th group of relays. Please note that the property of the matrix vector multiplication $\mathbf{A}\mathbf{y} = \mathbf{Y}\mathbf{a}$ will be used in the next section, where \mathbf{Y} is the diagonal matrix form of the vector \mathbf{y} and \mathbf{a} is the vector form of the diagonal matrix \mathbf{A} . At the receiver, a linear detector is considered where the optimal filter and optimal amplification coefficients are calculated. The optimal amplification coefficients are transmitted to the relays through the feedback channel. The block marked with a $\mathbf{Q}[\cdot]$ represents a decision device. In our proposed designs, the full CSI of the system is assumed to be known at all the destination nodes. In practice, a fusion center [28] which contains the destination nodes is responsible for gathering the CSI, computing the optimal linear filters and the optimal amplification coefficients. The fusion center also recovers the transmitted signal of the source nodes and transmits the optimal amplification coefficients to the relay nodes via a feedback channel.

III. PROPOSED JOINT MMSE DESIGN OF THE RECEIVER AND POWER ALLOCATION

In this section, three constrained optimization problems are proposed to describe the joint design of the linear receiver (\mathbf{W}) and the power allocation parameter (\mathbf{a}) subject to a global, local and individual power constraints. Extensions to nonlinear receiver and advanced parameter estimation techniques are also possible [29]-[36]. They impose different power limitations on all the relay nodes, each group of relay nodes and each relay node, respectively. The assumptions of these power constraints could determine the degrees of freedom for allocating the power among the relay nodes which will affect the performance and the lifetime of the networks.

A. MMSE Design with a Global Power Constraint

We first consider the case where the total power of all the relay nodes is limited to P_T . The proposed design can be formulated as the following optimization problem

$$\begin{aligned} [\mathbf{W}_{\text{opt}}, \mathbf{a}_{1,\text{opt}}, \dots, \mathbf{a}_{m-1,\text{opt}}] &= \arg \min_{\mathbf{W}, \mathbf{a}_1, \dots, \mathbf{a}_{m-1}} E[\|\mathbf{s} - \mathbf{W}^H \mathbf{d}\|^2], \\ \text{subject to } &\sum_{i=1}^{m-1} P_i = P_T \end{aligned} \quad (9)$$

where $(\cdot)^H$ denotes the complex-conjugate (Hermitian) transpose, P_i is the transmitted power of the i th group of relay

nodes, and $P_i = N_{i+1} \mathbf{a}_i^H \mathbf{a}_i$. In (9), we employ the equality as the constraint other than the inequality because it is obvious that the more available total power can be used the better performance can be achieved, which means that even if we set the constraint to be an inequality, the best performance will be achieved when the power is set to be the maximum bound (i.e. P_T). In addition, for such optimization problems it is easier to derive algorithmic solutions for equality constraints rather than inequality constraints.

To solve this constrained optimization problem, we adopt an alternating optimization approach whose global convergence has been established in [21] and [22] so that the global minimum value can be achieved. We modify the MSE cost function using the method of Lagrange multipliers [37] which yields the following Lagrangian function

$$\begin{aligned} \mathcal{L} &= E[\|\mathbf{s} - \mathbf{W}^H \mathbf{d}\|^2] + \lambda \left(\sum_{i=1}^{m-1} N_{i+1} \mathbf{a}_i^H \mathbf{a}_i - P_T \right) \\ &= E(\mathbf{s}^H \mathbf{s}) - E(\mathbf{d}^H \mathbf{W} \mathbf{s}) - E(\mathbf{s}^H \mathbf{W}^H \mathbf{d}) + E(\mathbf{d}^H \mathbf{W} \mathbf{W}^H \mathbf{d}) \\ &\quad + \lambda \left(\sum_{i=1}^{m-1} N_{i+1} \mathbf{a}_i^H \mathbf{a}_i - P_T \right). \end{aligned} \quad (10)$$

By fixing $\mathbf{a}_1, \dots, \mathbf{a}_{m-1}$ and setting the gradient of \mathcal{L} in (10) with respect to the conjugate of the filter \mathbf{W} equal to zero, where $(\cdot)^*$ denotes the complex-conjugate, we get

$$\begin{aligned} \mathbf{W}_{\text{opt}} &= [E(\mathbf{d} \mathbf{d}^H)]^{-1} E(\mathbf{d} \mathbf{s}^H) \\ &= \left[\mathbf{H}_d \mathbf{A}_{m-1} E(\mathbf{y}_{m-1} \mathbf{y}_{m-1}^H) \mathbf{A}_{m-1}^H \mathbf{H}_d^H + \sigma_n^2 \mathbf{I} \right]^{-1} \\ &\quad \times \mathbf{H}_d \mathbf{A}_{m-1} E(\mathbf{y}_{m-1} \mathbf{s}^H). \end{aligned} \quad (11)$$

The optimal expression for \mathbf{a}_{m-1} is obtained by equating the partial derivative of \mathcal{L} with respect to \mathbf{a}_{m-1}^* to zero

$$\begin{aligned} \frac{\partial \mathcal{L}}{\partial \mathbf{a}_{m-1}^*} &= -E\left(\frac{\partial \mathbf{d}^H}{\partial \mathbf{a}_{m-1}^*} \mathbf{W} \mathbf{s}\right) + E\left(\frac{\partial \mathbf{d}^H}{\partial \mathbf{a}_{m-1}^*} \mathbf{W} \mathbf{W}^H \mathbf{d}\right) \\ &\quad + N_m \lambda \mathbf{a}_{m-1} \\ &= -E(\mathbf{Y}_{m-1}^H \mathbf{H}_d^H \mathbf{W} \mathbf{s}) \\ &\quad + E[\mathbf{Y}_{m-1}^H \mathbf{H}_d^H \mathbf{W} \mathbf{W}^H (\mathbf{H}_d \mathbf{Y}_{m-1} \mathbf{a}_{m-1} + \mathbf{v}_d)] \\ &\quad + N_m \lambda \mathbf{a}_{m-1} \\ &= \mathbf{0}. \end{aligned} \quad (12)$$

Therefore, we obtain

$$\begin{aligned} \mathbf{a}_{m-1, \text{opt}} &= [E(\mathbf{Y}_{m-1}^H \mathbf{H}_d^H \mathbf{W} \mathbf{W}^H \mathbf{H}_d \mathbf{Y}_{m-1}) + N_m \lambda \mathbf{I}]^{-1} \\ &\quad \times E(\mathbf{Y}_{m-1}^H \mathbf{H}_d^H \mathbf{W} \mathbf{s}) \\ &= [\mathbf{H}_d^H \mathbf{W} \mathbf{W}^H \mathbf{H}_d \circ E(\mathbf{y}_{m-1} \mathbf{y}_{m-1}^H) + N_m \lambda \mathbf{I}]^{-1} \\ &\quad \times [\mathbf{H}_d^H \mathbf{W} \circ E(\mathbf{y}_{m-1} \mathbf{s}^H) \mathbf{u}] \end{aligned} \quad (13)$$

where \circ denotes the Hadamard (element-wise) product and $\mathbf{u} = [1, 1, \dots, 1]^T$.

Similarly, for $i = 2, 3, \dots, m-1$, we have

$$\begin{aligned} \frac{\partial \mathcal{L}}{\partial \mathbf{a}_{i-1}^*} &= -E\left(\frac{\partial \mathbf{d}^H}{\partial \mathbf{a}_{i-1}^*} \mathbf{W} \mathbf{s}\right) + \left(\frac{\partial \mathbf{d}^H}{\partial \mathbf{a}_{i-1}^*} \mathbf{W} \mathbf{W}^H \mathbf{d}\right) + N_i \lambda \mathbf{a}_{i-1} \\ &= \mathbf{0} \end{aligned} \quad (14)$$

where

$$\frac{\partial \mathbf{d}^H}{\partial \mathbf{a}_{i-1}^*} = \mathbf{Y}_{i-1}^H \left(\prod_{k=i}^{m-1} \mathbf{H}_{k-1, k}^H \mathbf{F}_k^H \mathbf{A}_k^H \right) \mathbf{H}_d^H. \quad (15)$$

Let

$$\mathbf{B}_{i-1} = \prod_{k=i}^{m-1} \mathbf{H}_{k-1, k}^H \mathbf{F}_k^H \mathbf{A}_k^H. \quad (16)$$

Then, we get

$$\begin{aligned} \mathbf{a}_{i-1, \text{opt}} &= [E(\mathbf{Y}_{i-1}^H \mathbf{B}_{i-1} \mathbf{H}_d^H \mathbf{W} \mathbf{W}^H \mathbf{H}_d \mathbf{B}_{i-1} \mathbf{Y}_{i-1}) + N_i \lambda \mathbf{I}]^{-1} \\ &\quad \times E(\mathbf{Y}_{i-1}^H \mathbf{B}_{i-1} \mathbf{H}_d^H \mathbf{W} \mathbf{s}) \\ &= [\mathbf{B}_{i-1} \mathbf{H}_d^H \mathbf{W} \mathbf{W}^H \mathbf{H}_d \mathbf{B}_{i-1} \circ E(\mathbf{y}_{i-1} \mathbf{y}_{i-1}^H) + N_i \lambda \mathbf{I}]^{-1} \\ &\quad \times [\mathbf{B}_{i-1} \mathbf{H}_d^H \mathbf{W} \circ E(\mathbf{y}_{i-1} \mathbf{s}^H) \mathbf{u}]. \end{aligned} \quad (17)$$

From (13) and (17), we conclude that

$$\begin{aligned} \mathbf{a}_{i, \text{opt}} &= [E(\mathbf{Y}_i^H \mathbf{B}_i \mathbf{H}_d^H \mathbf{W} \mathbf{W}^H \mathbf{H}_d \mathbf{B}_i \mathbf{Y}_i) + N_{i+1} \lambda \mathbf{I}]^{-1} \\ &\quad \times E(\mathbf{Y}_i^H \mathbf{B}_i \mathbf{H}_d^H \mathbf{W} \mathbf{s}) \\ &= [\mathbf{B}_i \mathbf{H}_d^H \mathbf{W} \mathbf{W}^H \mathbf{H}_d \mathbf{B}_i \circ E(\mathbf{y}_i \mathbf{y}_i^H) + N_{i+1} \lambda \mathbf{I}]^{-1} \\ &\quad \times [\mathbf{B}_i \mathbf{H}_d^H \mathbf{W} \circ E(\mathbf{y}_i \mathbf{s}^H) \mathbf{u}] \end{aligned} \quad (18)$$

where

$$\mathbf{B}_i = \begin{cases} \prod_{k=i+1}^{m-1} \mathbf{H}_{k-1, k}^H \mathbf{F}_k^H \mathbf{A}_k^H, & \text{for } i = 1, 2, \dots, m-2, \\ \mathbf{I}, & \text{for } i = m-1. \end{cases} \quad (19)$$

Please see the Appendix to find the expressions of \mathbf{F}_i , $E(\mathbf{y}_i \mathbf{y}_i^H)$, and $E(\mathbf{y}_i \mathbf{s}^H)$. The expressions in (11) and (18) depend on each other. Thus, it is necessary to iterate them with an initial value of \mathbf{a}_i ($i = 1, 2, \dots, m-1$) to obtain the solutions.

The Lagrange multiplier λ can be determined by solving

$$\sum_{i=1}^{m-1} N_{i+1} \mathbf{a}_{i, \text{opt}}^H \mathbf{a}_{i, \text{opt}} = P_T. \quad (20)$$

Let

$$\phi_i = E(\mathbf{Y}_i^H \mathbf{B}_i \mathbf{H}_d^H \mathbf{W} \mathbf{W}^H \mathbf{H}_d \mathbf{B}_i \mathbf{Y}_i) \quad (21)$$

and

$$\mathbf{z}_i = E(\mathbf{Y}_i^H \mathbf{B}_i \mathbf{H}_d^H \mathbf{W} \mathbf{s}). \quad (22)$$

Then, we get

$$\mathbf{a}_i = (\phi_i + N_{i+1} \lambda \mathbf{I})^{-1} \mathbf{z}_i. \quad (23)$$

When λ is a real value, we have

$$[(\phi_i + N_{i+1} \lambda \mathbf{I})^{-1}]^H = [(\phi_i + N_{i+1} \lambda \mathbf{I})^H]^{-1} = (\phi_i + N_{i+1} \lambda \mathbf{I})^{-1}. \quad (24)$$

Equation (20) becomes

$$\sum_{i=1}^{m-1} N_{i+1} \mathbf{z}_i^H (\boldsymbol{\phi}_i + N_{i+1} \lambda \mathbf{I})^{-1} (\boldsymbol{\phi}_i + N_{i+1} \lambda \mathbf{I})^{-1} \mathbf{z}_i = P_T. \quad (25)$$

Using an eigenvalue decomposition (EVD), we have

$$\boldsymbol{\phi}_i = \mathbf{Q}_i \boldsymbol{\Lambda}_i \mathbf{Q}_i^{-1} \quad (26)$$

where $\boldsymbol{\Lambda}_i = \text{diag}\{\alpha_{i,1}, \alpha_{i,2}, \dots, \alpha_{i,M_i}, 0, \dots, 0\}$ consists of eigenvalues of $\boldsymbol{\phi}_i$ and $M_i = \min\{N_0, N_i, N_m\}$. Then, we get

$$\boldsymbol{\phi}_i + N_{i+1} \lambda \mathbf{I} = \mathbf{Q}_i (\boldsymbol{\Lambda}_i + N_{i+1} \lambda \mathbf{I}) \mathbf{Q}_i^{-1}. \quad (27)$$

Therefore, (25) can be expressed as

$$\sum_{i=1}^{m-1} N_{i+1} \mathbf{z}_i^H \mathbf{Q}_i (\boldsymbol{\Lambda}_i + N_{i+1} \lambda \mathbf{I})^{-2} \mathbf{Q}_i^{-1} \mathbf{z}_i = P_T. \quad (28)$$

Using the properties of the trace operation, (28) can be written as

$$\sum_{i=1}^{m-1} N_{i+1} \text{tr} \left((\boldsymbol{\Lambda}_i + N_{i+1} \lambda \mathbf{I})^{-2} \mathbf{Q}_i^{-1} \mathbf{z}_i \mathbf{z}_i^H \mathbf{Q}_i \right) = P_T. \quad (29)$$

Defining $\mathbf{C}_i = \mathbf{Q}_i^{-1} \mathbf{z}_i \mathbf{z}_i^H \mathbf{Q}_i$, (11) becomes

$$\sum_{i=1}^{m-1} \sum_{j=1}^{M_i} N_{i+1} (\alpha_{i,j} + N_{i+1} \lambda)^{-2} \mathbf{C}_i(j, j) = P_T. \quad (30)$$

Since $\boldsymbol{\phi}_i$ is a matrix with at most rank M_i , only the first M_i columns of \mathbf{Q}_i span the column space of $E(\mathbf{Y}_i^H \mathbf{B}_i \mathbf{H}_d^H \mathbf{W} \mathbf{s})^H$ which causes the last $(N_i - M_i)$ columns of $\mathbf{z}_i^H \mathbf{Q}_i$ to become zero vectors and the last $(N_i - M_i)$ diagonal elements of \mathbf{C}_i are zero. Therefore, we obtain the $\{\sum_{i=1}^{m-1} 2M_i\}$ -th-order polynomial in λ

$$\sum_{i=1}^{m-1} \sum_{j=1}^{M_i} N_{i+1} (\alpha_{i,j} + N_{i+1} \lambda)^{-2} \mathbf{C}_i(j, j) = P_T. \quad (31)$$

B. MMSE Design with Local Power Constraints

Secondly, we consider the case where the total power of the relay nodes in each group is limited to some value $P_{T,i}$. The proposed method can be considered as the following optimization problem

$$\begin{aligned} & [\mathbf{W}_{\text{opt}}, \mathbf{a}_{1,\text{opt}}, \dots, \mathbf{a}_{m-1,\text{opt}}] = \arg \min_{\mathbf{W}, \mathbf{a}_1, \dots, \mathbf{a}_{m-1}} E[\|\mathbf{s} - \mathbf{W}^H \mathbf{d}\|^2], \\ & \text{subject to } P_i = P_{T,i}, \quad i = 1, 2, \dots, m-1, \end{aligned} \quad (32)$$

where P_i as defined above is the transmitted power of the i th group of relays, and $P_i = N_{i+1} \mathbf{a}_i^H \mathbf{a}_i$. Using the method of Lagrange multipliers again, we obtain the following Lagrangian function

$$\mathcal{L} = E[\|\mathbf{s} - \mathbf{W}^H \mathbf{d}\|^2] + \sum_{i=1}^{m-1} \lambda_i (N_{i+1} \mathbf{a}_i^H \mathbf{a}_i - P_{T,i}). \quad (33)$$

Following the same steps as described in Section III.A, we get the same optimal expression for \mathbf{W} as in (11). The optimal expression for the power allocation vector \mathbf{a}_i is different from

(18) and is given by

$$\begin{aligned} \mathbf{a}_{i,\text{opt}} = & [\mathbf{B}_i \mathbf{H}_d^H \mathbf{W} \mathbf{W}^H \mathbf{H}_d \mathbf{B}_i^H \circ E(\mathbf{y}_i \mathbf{y}_i^H)^* + N_{i+1} \lambda_i \mathbf{I}]^{-1} \\ & \times [\mathbf{B}_i \mathbf{H}_d^H \mathbf{W} \circ E(\mathbf{y}_i \mathbf{s}^H)^* \mathbf{u}], \end{aligned} \quad (34)$$

where

$$\mathbf{B}_i = \begin{cases} \prod_{k=i+1}^{m-1} \mathbf{H}_{k-1,k}^H \mathbf{F}_k^H \mathbf{A}_k^H, & \text{for } i = 1, 2, \dots, m-2, \\ \mathbf{I}, & \text{for } i = m-1. \end{cases} \quad (35)$$

The Lagrange multiplier λ_i can be determined by solving

$$N_{i+1} \mathbf{a}_{i,\text{opt}}^H \mathbf{a}_{i,\text{opt}} = P_{T,i} \quad i = 1, 2, \dots, m-1. \quad (36)$$

Following the same steps as in Section III.A, we obtain $(m-1)\{2M_i\}$ -th-order polynomials in λ_i

$$\sum_{j=1}^{M_i} N_{i+1} (\alpha_{i,j} + N_{i+1} \lambda_i)^{-2} \mathbf{C}_i(j, j) = P_{T,i}, \quad i = 1, 2, \dots, m-1. \quad (37)$$

C. MMSE Design with Individual Power Constraints

Thirdly, we consider the case where the power of each relay node is limited to some value $P_{T,i,j}$. The proposed method can be considered as the following optimization problem

$$\begin{aligned} & [\mathbf{W}_{\text{opt}}, \mathbf{a}_{1,\text{opt}}, \dots, \mathbf{a}_{m-1,\text{opt}}] = \arg \min_{\mathbf{W}, \mathbf{a}_1, \dots, \mathbf{a}_{m-1}} E[\|\mathbf{s} - \mathbf{W}^H \mathbf{d}\|^2], \\ & \text{subject to } P_{i,j} = P_{T,i,j}, \quad i = 1, 2, \dots, m-1, \quad j = 1, 2, \dots, N_i, \end{aligned} \quad (38)$$

where $P_{i,j}$ is the transmitted power of the j th relay node in the i th group, and $P_{i,j} = N_{i+1} a_{i,j}^* a_{i,j}$. Using the method of Lagrange multipliers once again, we have the following Lagrangian function

$$\mathcal{L} = E[\|\mathbf{s} - \mathbf{W}^H \mathbf{d}\|^2] + \sum_{i=1}^{m-1} \sum_{j=1}^{N_i} \lambda_{i,j} (N_{i+1} a_{i,j}^* a_{i,j} - P_{T,i,j}). \quad (39)$$

Following the same steps as described in Section III.A, we get the same optimal expression for \mathbf{W} as in (11), and the optimal expression for the amplification coefficient

$$a_{i,j,\text{opt}} = [\phi_i(j, j) + N_{i+1} \lambda_{i,j}]^{-1} [\mathbf{z}_i(j) - \sum_{l \in I, l \neq j} \phi_i(j, l) a_{i,l}], \quad (40)$$

where $I = \{1, 2, \dots, N_i\}$, ϕ_i and \mathbf{z}_i have the same expression as in (21) and (22). The Lagrange multiplier $\lambda_{i,j}$ can be determined by solving

$$N_{i+1} a_{i,j,\text{opt}}^* a_{i,j,\text{opt}} = P_{T,i,j} \quad i = 1, 2, \dots, m-1, \quad j = 1, 2, \dots, N_i. \quad (41)$$

Table I shows a summary of our proposed MMSE designs with global, local and individual power constraints which will be used for the simulations. If the quasi-static fading channel (block fading) is considered in the simulations, we only need two iterations. Alternatively, low-complexity adaptive algorithms can be used to compute the linear receiver \mathbf{W}_{opt} and the power allocation parameter vector $\mathbf{a}_{i,\text{opt}}$.

TABLE I
SUMMARY OF THE PROPOSED MMSE DESIGN WITH GLOBAL, LOCAL AND INDIVIDUAL POWER CONSTRAINTS

Global Power Constraint	Local Power Constraints	Individual Power Constraint
Initialize the algorithm by setting: $\mathbf{A} = \sqrt{\frac{P_T}{\sum_{i=1}^{m-1} N_i N_{i+1}}} \mathbf{I}$ For each iteration: 1. Compute \mathbf{W}_{opt} in (11). 2. For $i = 1, 2, \dots, m-1$ a) Compute ϕ_i and \mathbf{z}_i in (21) and (22). b) Calculate the EVD of ϕ_i in (26). c) Solve λ in (31). d) Compute $\mathbf{a}_{i,\text{opt}}$ in (18).	Initialize the algorithm by setting: $\mathbf{A}_i = \sqrt{\frac{P_{T,i}}{N_i N_{i+1}}} \mathbf{I}$ for $i = 1, 2, \dots, m-1$ For each iteration: 1. Compute \mathbf{W}_{opt} in (11). 2. For $i = 1, 2, \dots, m-1$ a) Compute ϕ_i and \mathbf{z}_i in (21) and (22). b) Calculate the EVD of ϕ_i in (26). c) Solve λ_i in (37). d) Compute $\mathbf{a}_{i,\text{opt}}$ in (34).	Initialize the algorithm by setting: $a_{i,j} = \sqrt{\frac{P_{T,i,j}}{N_{i+1}}}$ for $i = 1, 2, \dots, m-1$, $j = 1, 2, \dots, N_i$ For each iteration: 1. Compute \mathbf{W}_{opt} in (11). 2. For $i = 1, 2, \dots, m-1$ a) Compute ϕ_i and \mathbf{z}_i in (21) and (22). b) For $j = 1, 2, \dots, N_i$ i) Solve $\lambda_{i,j}$ in (41). ii) Compute $a_{i,j,\text{opt}}$ in (40).

IV. PROPOSED JOINT MAXIMUM SUM-RATE DESIGN OF THE RECEIVER AND THE POWER ALLOCATION

In this section, we analyse the proposed joint MSR design of the receiver and the power allocation. By the MSR designs, the best possible SNR and QoS can be obtained at the destinations. They will improve the spectrum efficiency which is desirable for the WSNs with the limitation in the sensor node computational capacity. Only the local constraints are considered here, because of the MSR receiver we make use of the Generalized Rayleigh Quotient which is only suitable to solve optimization problems with vectors. It limits the types of power constraints. By substituting (2)-(7) into (8), we get

$$\begin{aligned} \mathbf{d} &= \mathbf{C}_{0,m-1} \mathbf{s} + \mathbf{C}_{1,m-1} \mathbf{v}_1 + \mathbf{C}_{2,m-1} \mathbf{v}_2 \\ &\quad + \dots + \mathbf{C}_{m-1,m-1} \mathbf{v}_{m-1} + \mathbf{v}_d \\ &= \mathbf{C}_{0,m-1} \mathbf{s} + \sum_{i=1}^{m-1} \mathbf{C}_{i,m-1} \mathbf{v}_i + \mathbf{v}_d, \end{aligned} \quad (42)$$

where

$$\mathbf{C}_{i,j} = \begin{cases} \prod_{k=i}^j \mathbf{B}_k, & \text{if } i \leq j, \\ \mathbf{I}, & \text{if } i > j, \end{cases} \quad (43)$$

and

$$\mathbf{B}_0 = \mathbf{H}_s, \quad (44)$$

$$\mathbf{B}_i = \mathbf{H}_{i,i+1} \mathbf{A}_i \mathbf{F}_i \quad \text{for } i = 1, 2, \dots, m-2, \quad (45)$$

$$\mathbf{B}_{m-1} = \mathbf{H}_d \mathbf{A}_{m-1} \mathbf{F}_{m-1}. \quad (46)$$

We focus on a system with one source node for simplicity. The generalization to multiple sources amounts to performing the optimization of the additional filters. Therefore, the expression of the sum-rate (SR) in terms of bps/Hz for our m -hop WSN is expressed as

$$\text{SR} = \frac{1}{m} \log_2 \left[1 + \frac{\sigma_s^2}{\sigma_n^2} \frac{\mathbf{w}^H \mathbf{C}_{0,m-1} \mathbf{C}_{0,m-1}^H \mathbf{w}}{\mathbf{w}^H (\sum_{i=1}^m \mathbf{C}_{i,m-1} \mathbf{C}_{i,m-1}^H) \mathbf{w}} \right] \quad (\text{bps/Hz}), \quad (47)$$

where \mathbf{w} is the linear receiver, and $(\cdot)^H$ denotes the complex-conjugate (Hermitian) transpose. Let

$$\phi = \mathbf{C}_{0,m-1} \mathbf{C}_{0,m-1}^H \quad (48)$$

and

$$\mathbf{Z} = \sum_{i=1}^m \mathbf{C}_{i,m-1} \mathbf{C}_{i,m-1}^H. \quad (49)$$

The expression for the sum-rate can be written as

$$\text{SR} = \frac{1}{m} \log_2 \left(1 + \frac{\sigma_s^2}{\sigma_n^2} \frac{\mathbf{w}^H \phi \mathbf{w}}{\mathbf{w}^H \mathbf{Z} \mathbf{w}} \right) = \frac{1}{m} \log_2(1 + ax), \quad (50)$$

where

$$a = \frac{\sigma_s^2}{\sigma_n^2} \quad (51)$$

and

$$x = \frac{\mathbf{w}^H \phi \mathbf{w}}{\mathbf{w}^H \mathbf{Z} \mathbf{w}}. \quad (52)$$

Since $\frac{1}{m} \log_2(1 + ax)$ is a monotonically increasing function of x ($a > 0$), the problem of maximizing the sum-rate is equivalent to maximizing x . In this section, we consider the case where the total power of the relay nodes in each group is limited to some value $P_{T,i}$ (local constraints). The proposed method can be considered as the following optimization problem:

$$\begin{aligned} [\mathbf{w}_{\text{opt}}, \mathbf{a}_{1,\text{opt}}, \dots, \mathbf{a}_{m-1,\text{opt}}] &= \arg \max_{\mathbf{w}, \mathbf{a}_1, \dots, \mathbf{a}_{m-1}} \frac{\mathbf{w}^H \phi \mathbf{w}}{\mathbf{w}^H \mathbf{Z} \mathbf{w}}, \quad (53) \\ \text{subject to } P_i &= P_{T,i}, \quad i = 1, 2, \dots, m-1 \end{aligned}$$

where P_i as defined above is the transmitted power of the i th group of relays, and $P_i = N_{i+1} \mathbf{a}_i^H \mathbf{a}_i$. We note that the expression $\frac{\mathbf{w}^H \phi \mathbf{w}}{\mathbf{w}^H \mathbf{Z} \mathbf{w}}$ in (53) is the Generalized Rayleigh Quotient. Thus, the optimal solution of our maximization problem can be obtained: \mathbf{w}_{opt} is any eigenvector corresponding to the dominant eigenvalue of $\mathbf{Z}^{-1} \phi$.

In order to obtain the optimal power allocation vector \mathbf{a}_{opt} , we rewrite $\frac{\mathbf{w}^H \phi \mathbf{w}}{\mathbf{w}^H \mathbf{Z} \mathbf{w}}$ and the expression is given by

$$\frac{\mathbf{w}^H \phi \mathbf{w}}{\mathbf{w}^H \mathbf{Z} \mathbf{w}} = \frac{\mathbf{a}_i^H \mathbf{M}_i \mathbf{a}_i}{\mathbf{a}_i^H \mathbf{P}_i \mathbf{a}_i + \mathbf{w}_i^H \mathbf{T}_i \mathbf{w}_i}, \quad \text{for } i = 1, 2, \dots, m-1, \quad (54)$$

where

$$\begin{aligned} \mathbf{M}_i &= \text{diag}\{\mathbf{w}_i^H \mathbf{C}_{i+1,m-1} \mathbf{H}_{i,i+1} \mathbf{F}_i\} \mathbf{C}_{0,i-1} \mathbf{C}_{0,i-1}^H \\ &\quad \times \text{diag}\{\mathbf{F}_i^H \mathbf{H}_{i,i+1}^H \mathbf{C}_{i+1,m-1}^H \mathbf{w}_i\}, \end{aligned} \quad (55)$$

$$\mathbf{P}_i = \text{diag}\{\mathbf{w}_i^H \mathbf{C}_{i+1,m-1} \mathbf{H}_{i,i+1} \mathbf{F}_i\} \left(\sum_{k=1}^i \mathbf{C}_{k,i-1} \mathbf{C}_{k,i-1}^H \right) \quad (56)$$

$$\times \text{diag}\{\mathbf{F}_i^H \mathbf{H}_{i,i+1}^H \mathbf{C}_{i+1,m-1}^H \mathbf{w}_i\},$$

and

$$\mathbf{T}_i = \sum_{k=i+1}^m \mathbf{C}_{k,m-1} \mathbf{C}_{k,m-1}^H. \quad (57)$$

Since the multiplication of any constant value and an eigenvector is still an eigenvector of the matrix, we express the receive filter as

$$\mathbf{w}_i = \frac{\mathbf{w}_{\text{opt}}}{\sqrt{\mathbf{w}_{\text{opt}}^H \mathbf{T}_i \mathbf{w}_{\text{opt}}}}. \quad (58)$$

Hence, we obtain

$$\mathbf{w}_i^H \mathbf{T}_i \mathbf{w}_i = 1 = \frac{N_{i+1} \mathbf{a}_i^H \mathbf{a}_i}{P_{T,i}}. \quad (59)$$

By substituting (59) into (54), we get

$$\frac{\mathbf{w}^H \phi \mathbf{w}}{\mathbf{w}^H \mathbf{Z} \mathbf{w}} = \frac{\mathbf{a}_i^H \mathbf{M}_i \mathbf{a}_i}{\mathbf{a}_i^H \mathbf{N}_i \mathbf{a}_i} \quad \text{for } i = 1, 2, \dots, m-1, \quad (60)$$

where

$$\mathbf{N}_i = \mathbf{P}_i + \frac{N_{i+1}}{P_{T,i}} \mathbf{I}. \quad (61)$$

Likewise, we note that the expression $\frac{\mathbf{a}_i^H \mathbf{M}_i \mathbf{a}_i}{\mathbf{a}_i^H \mathbf{N}_i \mathbf{a}_i}$ in (60) is the Generalized Rayleigh Quotient. Thus, the optimal solution of our maximization problem can be obtained: $\mathbf{a}_{i,\text{opt}}$ is any eigenvector corresponding to the dominant eigenvalue of $\mathbf{N}_i^{-1} \mathbf{M}_i$ that satisfies $\mathbf{a}_{i,\text{opt}}^H \mathbf{a}_{i,\text{opt}} = \frac{P_{T,i}}{N_{i+1}}$. Here, the local power constraints can be satisfied by employing a normalization. When considering the global power constraint P_T , there is no unique solution of $\mathbf{a}_{i,\text{opt}}$ ($i = 1, 2, \dots, m-1$) that satisfy $\sum_{i=1}^{m-1} N_{i+1} \mathbf{a}_{i,\text{opt}}^H \mathbf{a}_{i,\text{opt}} = P_T$. Thus, for this reason, we do not consider the global power constraint. The solutions of \mathbf{w}_{opt} and $\mathbf{a}_{i,\text{opt}}$ depend on each other. Therefore it is necessary to iterate them with an initial value of \mathbf{a}_i ($i = 1, 2, \dots, m-1$) to obtain the optimum solutions.

In this section, two methods are employed to calculate the dominant eigenvectors. The first one is the QR algorithm [38] which calculates all the eigenvalues and eigenvectors of a matrix. We can choose the dominant eigenvector among them. The second one is the power method [38] which only calculates the dominant eigenvector of a matrix. Hence, the computational complexity can be reduced. Table II shows a summary of our proposed MSR design with a local power constraint which will be used for the simulations. If the quasi-static fading channel (block fading) is considered in the simulations, we only need two iterations.

V. ANALYSIS OF THE PROPOSED ALGORITHMS

In this section, an analysis of the computational complexity and the convergence of the algorithms is developed. We first illustrate the computational complexity requirements of the proposed MMSE and MSR designs. We quantify the computational complexity of the algorithms, which require a given number of arithmetic operations per iteration. The lower

TABLE II
SUMMARY OF THE PROPOSED MSR DESIGN WITH LOCAL POWER CONSTRAINTS

Initialize the algorithm by setting

$$\mathbf{A}_i = \sqrt{\frac{P_{T,i}}{N_i N_{i+1}}} \mathbf{I} \quad \text{for } i = 1, 2, \dots, m-1$$

For each iteration:

1. Compute ϕ and \mathbf{Z} in (48) and (49).
2. Using the QR algorithm or the power method to compute the dominant eigenvector of $\mathbf{Z}^{-1} \phi$, denoted as \mathbf{w}_{opt} .
3. For $i = 1, 2, \dots, m-1$
 - a) Compute \mathbf{M}_i and \mathbf{N}_i in (55) and (61).
 - b) Using the QR algorithm or the power method to compute the dominant eigenvector of $\mathbf{N}_i^{-1} \mathbf{M}_i$, denoted as \mathbf{a}_i .
 - c) To ensure the local power constraint

$$\mathbf{a}_{i,\text{opt}}^H \mathbf{a}_{i,\text{opt}} = \frac{P_{T,i}}{N_{i+1}}, \text{ compute } \mathbf{a}_{i,\text{opt}} = \sqrt{\frac{P_{T,i}}{N_{i+1} \mathbf{a}_i^H \mathbf{a}_i}} \mathbf{a}_i.$$

the number of operations the lower the power consumption will be. Then, we make use of the convergence results for the alternating optimization algorithms in [21], [22] and present a set of sufficient conditions under which our proposed algorithms will converge to the optimal solutions.

A. Computational Complexity Analysis

Table III and Table IV list the computational complexity per iteration in terms of the number of multiplications, additions and divisions for our proposed joint linear receiver design (MMSE and MSR) and power allocation strategies. For the joint MMSE designs, we use the QR algorithm to perform the eigendecomposition of the matrix. Please note that in this paper the QR decomposition employs the Householder transformation [38], [39]. The quantities n_Q and n_P denote the number of iterations of the QR algorithm and the power method, respectively. For the computational complexity of λ in Table III, it does not include the processing of solving the equation in (31), (37) and (41), because the method with a global power constraint, equation (31) is a higher order polynomial whose complexity is difficult to be quantified. As the multiplication dominates the computational complexity, in order to compare the computational complexity of our proposed joint MMSE and MSR designs, the number of multiplications versus the number of relay nodes in each group for each iteration are displayed in Fig. 3 and Fig 4. For the purpose of illustration, we set $m = 3$, $N_0 = 1$, $N_3 = 2$ and $n_Q = n_P = 10$. For the MMSE design, it can be seen that our proposed receiver with a global constraint has the same complexity as the receiver with local constraints. In practice, when considering the processing of solving the equation in (31), (37), the method with a global constraint will require a higher computational complexity than the local constraints and the difference will become larger along with the increase of the number of hops (m). When the individual power constraints are considered, the computational complexity is lower than other constraints because there is no need to compute the

eigendecomposition for it. For the MSR design, employing the power method to calculate the dominant eigenvectors has a lower computational complexity than employing the QR algorithm.

VI. ANALYSIS OF THE PROPOSED ALGORITHMS

In this section, an analysis of the computational complexity and the convergence of the algorithms is developed. We first illustrate the computational complexity requirements of the proposed MMSE and MSR designs. Then, we make use of the convergence results for the alternating optimization algorithms in [21], [22] and present a set of sufficient conditions under which our proposed algorithms will converge to the optimal solutions.

A. Computational Complexity Analysis

Table III and Table IV list the computational complexity per iteration in terms of the number of multiplications, additions and divisions for our proposed joint linear receiver design (MMSE and MSR) and power allocation strategies. For the joint MMSE designs, we use the QR algorithm to perform the eigendecomposition of the matrix. Please note that in this paper the QR decomposition by the Householder transformation [38], [39] is employed by the QR algorithms. The quantities n_Q and n_P denote the number of iterations of the QR algorithm and the power method, respectively. For the computational complexity of λ in Table III, it does not include the processing of solving the equation in (31), (37) and (41), because of the method with a global power constraint, equation (31) is a higher order polynomial whose complexity is difficult to be summarized. As the multiplication dominates the computational complexity, in order to compare the computational complexity of our proposed joint MMSE and MSR designs, the number of multiplications versus the number of relay nodes in each group for each iteration are displayed in Fig. 3 and Fig 4. For the purpose of illustration, we set $m = 3$, $N_0 = 1$, $N_3 = 2$ and $n_Q = n_P = 10$. For the MMSE design, it can be seen that our proposed receiver with a global constraint has the same complexity as the receiver with local constraints. In practice, when considering the processing of solving the equation in (31), (37), the method with a global constraint will require a higher computational complexity than the local constraints and the difference will become larger along with the increase of the number of hops (m). When the individual power constraints are considered, the computational complexity is lower than other constraints because there is no need to compute the eigendecomposition for it. For the MSR design, employing the power method to calculate the dominant eigenvectors has a lower computational complexity than employing the QR algorithm.

B. Sufficient Conditions for Convergence

To obtain convergence conditions, we need to define a metric space and the Hausdorff distance that will extensively be used. A metric space is an ordered pair (\mathcal{M}, d) , where \mathcal{M} is a nonempty set, and d is a metric on \mathcal{M} , i.e., a function

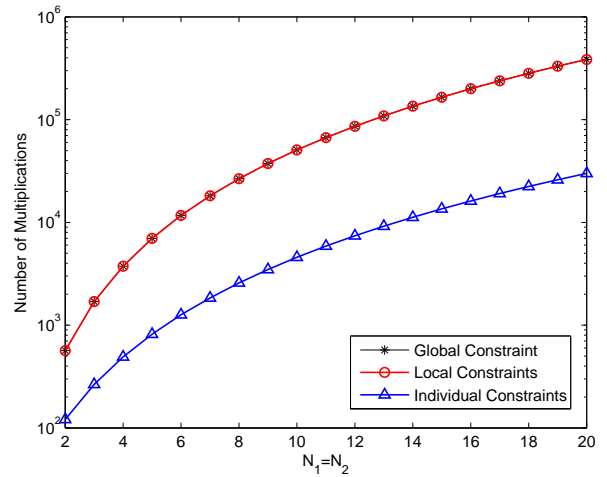

Fig. 3. Number of multiplications versus the number of relay nodes of our proposed joint MMSE design of the receiver and the power allocation strategies.

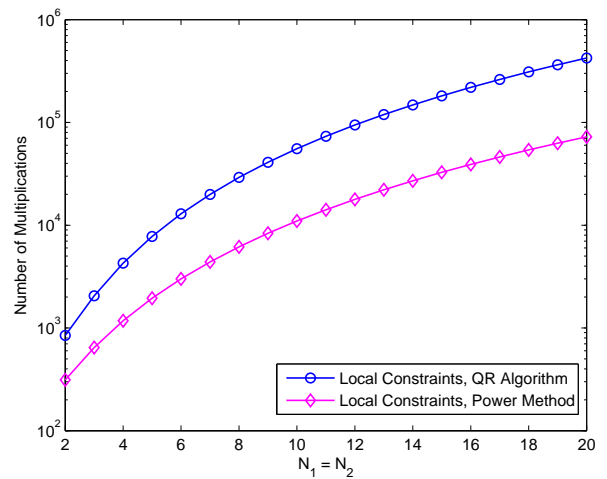

Fig. 4. Number of multiplications versus the number of relay nodes of our proposed joint MSR design of the receiver and the power allocation strategies.

$d : \mathcal{M} \times \mathcal{M} \rightarrow \mathbb{R}$ such that for any $x, y, z \in \mathcal{M}$, the following conditions hold:

- 1) $d(x, y) \geq 0$.
- 2) $d(x, y) = 0$ iff $x = y$.
- 3) $d(x, y) = d(y, x)$.
- 4) $d(x, y) \leq d(x, z) + d(z, y)$.

The Hausdorff distance measures how far two subsets of a metric space are from each other and is defined by

$$d_H(X, Y) = \max \left\{ \sup_{x \in X} \inf_{y \in Y} d(x, y), \sup_{y \in Y} \inf_{x \in X} d(x, y) \right\}. \quad (62)$$

The proposed joint MMSE designs can be stated as an alternating minimization strategy based on the MSE defined in (9) and expressed as

$$\mathbf{W}_n \in \arg \min_{\mathbf{W} \in \underline{\mathbf{W}}_n} \text{MSE}(\mathbf{W}, \mathbf{a}_{i,n-1}), \quad (63)$$

TABLE III
COMPUTATIONAL COMPLEXITY PER ITERATION OF THE JOINT MMSE DESIGNS

Power Constraint		Multiplications	Additions	Divisions
W	All	$N_m(N_m - 1)(4N_m + 1)/6$ $+(N_0 + N_{m-1})N_d^2 + N_{m-1}^2 N_m$ $+N_0 N_{m-1} N_m + N_{m-1} N_m$ $+\sum_{i=2}^{m-1} \{2N_{i-1}^2 N_i + N_{i-1} N_i^2\}$ $+N_0 N_{i-1} N_i + 4N_{i-1} N_i + 2N_i\}$	$N_m(N_m - 1)(4N_m + 1)/6$ $+(N_0 + N_{m-1})N_m^2 + N_{m-1}^2 N_m$ $+N_0 N_{m-1} N_m - N_m^2 + 2N_0 N_m$ $+N_{m-1} N_m + N_m + \sum_{i=2}^{m-1} \{2N_{i-1} N_i^2\}$ $+N_0(N_{i-1} - 1)N_i - N_i^2 + N_i\}$	$N_m(3N_m - 1)/2$
	Global	$\sum_{i=1}^{m-1} \{n_Q(\frac{13}{6}N_i^3 + \frac{3}{2}N_i^2 + \frac{1}{3}N_i - 2)$ $-N_i^3 + 3N_0 N_i^2 + N_0 N_i N_{i+1} + N_i^2\}$ $+\sum_{i=1}^{m-2} \{N_i N_{i+1} + N_{i+1}\}$	$\sum_{i=1}^{m-1} \{n_Q(\frac{13}{6}N_i^3 - N_i^2 - \frac{1}{6}N_i + 1)$ $-N_i^3 + 3N_0 N_i^2 + N_0 N_i N_{i+1}$ $-N_i^2 - N_0 N_i - N_i\}$	$\sum_{i=1}^{m-1} \{n_Q(N_i - 1)\}$
	λ Local	$\sum_{i=1}^{m-1} \{n_Q(\frac{13}{6}N_i^3 + \frac{3}{2}N_i^2 + \frac{1}{3}N_i - 2)$ $-N_i^3 + 3N_0 N_i^2 + N_0 N_i N_{i+1} + N_i^2\}$ $+\sum_{i=1}^{m-2} \{N_i N_{i+1} + N_{i+1}\}$	$\sum_{i=1}^{m-1} \{n_Q(\frac{13}{6}N_i^3 - N_i^2 - \frac{1}{6}N_i + 1)$ $-N_i^3 + 3N_0 N_i^2 + N_0 N_i N_{i+1}$ $-N_i^2 - N_0 N_i - N_i\}$	$\sum_{i=1}^{m-1} \{n_Q(N_i - 1)\}$
Individual	$\sum_{i=1}^{m-1} \{N_0 N_i^2 + N_0 N_i N_{i+1} + N_i^2 + N_0 N_i\}$ $+\sum_{i=1}^{m-2} \{N_i N_{i+1} + N_{i+1}\}$	$\sum_{i=1}^{m-1} \{N_0 N_i^2 + N_0 N_i N_{i+1} - N_i^2 - N_i\}$		
a	Global	$\sum_{i=1}^{m-1} \{N_i(N_i - 1)(4N_i + 1)/6 + N_i^2 + 1\}$	$\sum_{i=1}^{m-1} \{N_i(N_i - 1)(4N_i + 1)/6 + N_i^2\}$	$\sum_{i=1}^{m-1} \{N_i(3N_i - 1)/2\}$
	Local	$\sum_{i=1}^{m-1} \{N_i(N_i - 1)(4N_i + 1)/6 + N_i^2 + 1\}$	$\sum_{i=1}^{m-1} \{N_i(N_i - 1)(4N_i + 1)/6 + N_i^2\}$	$\sum_{i=1}^{m-1} \{N_i(3N_i - 1)/2\}$
	Individual	$2\sum_{i=1}^{m-1} N_i$	$\sum_{i=1}^{m-1} N_i$	$\sum_{i=1}^{m-1} N_i$

TABLE IV
COMPUTATIONAL COMPLEXITY PER ITERATION OF THE JOINT MSR DESIGNS

Power Constraint		Multiplications	Additions	Divisions
w	Local QR Algorithm	$n_Q(\frac{13}{6}N_m^3 + \frac{3}{2}N_m^2 + \frac{1}{3}N_m - 2)$ $+N_m(N_m - 1)(4N_m + 1)/6 + N_m^2 + N_1 N_m$ $+\sum_{i=1}^{m-1} \{N_i N_m^2 + N_i N_{i+1} + N_i\}$ $+\sum_{i=2}^{m-1} \{2N_{i-1}^2 N_i + N_{i-1} N_i^2\}$ $+N_{i-1} N_i N_m + 4N_{i-1} N_i + 2N_i\}$	$n_Q(\frac{13}{6}N_d^3 - N_d^2 - \frac{1}{6}N_d + 1)$ $+N_m(N_m - 1)(4N_m + 1)/6$ $-N_m^2 + N_1 N_m + \sum_{i=1}^{m-1} N_i N_m^2$ $+\sum_{i=2}^{m-1} \{2N_{i-1} N_i^2\}$ $+N_{i-1}(N_i - 1)N_m - N_i^2 + N_i\}$	$n_Q(N_m - 1)$ $+N_m(3N_m - 1)/2$
	Local Power Method	$n_P N_m^2 + N_m(N_m - 1)(4N_m + 1)/6$ $+N_m^3 + N_m^2 + N_1 N_m$ $+\sum_{i=1}^{m-1} \{N_i N_m^2 + N_i N_{i+1} + N_i\}$ $+\sum_{i=2}^{m-1} \{2N_{i-1}^2 N_i + N_{i-1} N_i^2\}$ $+N_{i-1} N_i N_m + 4N_{i-1} N_i + 2N_i\}$	$n_P N_m(N_m - 1)$ $+N_m(N_m - 1)(4N_m + 1)/6 + N_m^3$ $-2N_m^2 + N_1 N_m + \sum_{i=1}^{m-1} N_i N_m^2$ $+\sum_{i=2}^{m-1} \{2N_{i-1} N_i^2\}$ $+N_{i-1}(N_i - 1)N_m - N_i^2 + N_i\}$	$N_m(3N_m - 1)/2$
a	Local QR Algorithm	$\sum_{i=1}^{m-1} \{n_Q(\frac{13}{6}N_i^3 + \frac{3}{2}N_i^2 + \frac{1}{3}N_i - 2)$ $+N_i(N_i - 1)(4N_i + 1)/6$ $+\sum_{k=1}^i N_k N_i^2 + 3N_i^2 + 2N_i N_{i+1}$ $+N_{i+1} N_m + 3N_i + 2\} + 2N_m^2$	$\sum_{i=1}^{m-1} \{n_Q(\frac{13}{6}N_i^3 - N_i^2 - \frac{1}{6}N_i + 1)$ $+N_i(N_i - 1)(4N_i + 1)/6 + N_i N_{i+1}$ $+N_{i+1} N_m - N_{i+1} + N_i - 1\}$ $+\sum_{i=2}^{m-1} \{\sum_{k=1}^{i-1} (N_k - 1)N_i^2\}$ $+N_i^2(i - 2) + N_i\} + 2N_m^2 - 2N_m$	$\sum_{i=1}^{m-1} \{n_Q(N_i - 1)$ $+N_i(3N_i - 1)/2\}$ $+N_m + m - 1$
	Local Power Method	$\sum_{i=1}^{m-1} \{n_P N_i^2$ $+N_i(N_i - 1)(4N_i + 1)/6$ $+\sum_{k=1}^i N_k N_i^2 + N_i^3 + 3N_i^2 + 2N_i N_{i+1}$ $+N_{i+1} N_m + 3N_i + 2\} + 2N_m^2$	$\sum_{i=1}^{m-1} \{n_P N_i(N_i - 1)$ $+N_i(N_i - 1)(4N_i + 1)/6 + N_i^3$ $-N_i^2 + N_i N_{i+1} + N_{i+1} N_m - N_{i+1}$ $+N_i - 1\} + \sum_{i=2}^{m-1} \{\sum_{k=1}^{i-1} (N_k - 1)N_i^2\}$ $+N_i^2(i - 2) + N_i\} + 2N_m^2 - 2N_m$	$\sum_{i=1}^{m-1} \{N_i(3N_i - 1)/2\}$ $+N_m + m - 1$

$$\mathbf{a}_{i,n} \in \arg \min_{\mathbf{a} \in \mathbf{a}_{i,n}} \text{MSE}(\mathbf{W}_n, \mathbf{a}_i) \quad \text{for } i = 1, 2, \dots, m-1 \quad (64)$$

where the sets $\mathbf{W}_n, \mathbf{a}_i \subset \mathcal{M}$, and the sequences of compact sets $\{\mathbf{W}_n\}_{n \geq 0}$ and $\{\mathbf{a}_{i,n}\}_{n \geq 0}$ converge to the sets \mathbf{W} and \mathbf{a}_i , respectively.

Although we are not given the sets \mathbf{W} and \mathbf{a}_i directly, we have the sequence of compact sets $\{\mathbf{W}_n\}_{n \geq 0}$ and $\{\mathbf{a}_{i,n}\}_{n \geq 0}$.

The aim of our proposed joint MMSE designs is to find a sequence of \mathbf{W}_n and $\mathbf{a}_{i,n}$ ($i = 1, 2, \dots, m-1$) such that

$$\lim_{n \rightarrow \infty} \text{MSE}(\mathbf{W}_n, \mathbf{a}_{1,n}, \mathbf{a}_{2,n}, \dots, \mathbf{a}_{m-1,n}) = \text{MSE}(\mathbf{W}_{opt}, \mathbf{a}_{1,opt}, \mathbf{a}_{2,opt}, \dots, \mathbf{a}_{m-1,opt}) \quad (65)$$

where \mathbf{W}_{opt} and $\mathbf{a}_{i,opt}$ correspond to the optimal values of

\mathbf{W}_n and $\mathbf{a}_{i,n}$, respectively. Equation (65) can be considered as the necessary condition of the following equations

$$\lim_{n \rightarrow \infty} \text{MSE}(\mathbf{W}_n, \mathbf{a}_{i,n}) = \text{MSE}(\mathbf{W}_{opt}, \mathbf{a}_{i,opt}) \quad (66)$$

for $i = 1, 2, \dots, m-1$

if the other power allocation parameters $\mathbf{a}_{j,n} (j \neq i)$ are kept constant when computing $\mathbf{a}_{i,n}$ during the iterations. To present a set of sufficient conditions under which the proposed algorithms converge, we need the so-called three-point and four-point properties [21], [22]. Let us assume that there is a function $f: \mathcal{M} \times \mathcal{M} \rightarrow \mathbb{R}$ such that the following conditions are satisfied:

- 1) *Three-point property* ($\mathbf{W}, \tilde{\mathbf{W}}, \mathbf{a}_i$):
For all $n \geq 1$, $\mathbf{W} \in \underline{\mathbf{W}}_n$, $\mathbf{a}_i \in \underline{\mathbf{a}}_{i,n-1}$, and $\tilde{\mathbf{W}} \in \arg \min_{\mathbf{W} \in \underline{\mathbf{W}}_n} \text{MSE}(\mathbf{W}, \mathbf{a}_i)$, we have
$$f(\mathbf{W}, \tilde{\mathbf{W}}) + \text{MSE}(\tilde{\mathbf{W}}, \mathbf{a}_i) \leq \text{MSE}(\mathbf{W}, \mathbf{a}_i). \quad (67)$$
- 2) *Four-point property* ($\mathbf{W}, \mathbf{a}_i, \tilde{\mathbf{W}}, \tilde{\mathbf{a}}_i$):
For all $n \geq 1$, $\mathbf{W}, \tilde{\mathbf{W}} \in \underline{\mathbf{W}}_n$, $\mathbf{a}_i \in \underline{\mathbf{a}}_{i,n}$, and $\tilde{\mathbf{a}}_i \in \arg \min_{\mathbf{a}_i \in \underline{\mathbf{a}}_{i,n}} \text{MSE}(\tilde{\mathbf{W}}, \mathbf{a}_i)$, we have
$$\text{MSE}(\mathbf{W}, \tilde{\mathbf{a}}_i) \leq \text{MSE}(\mathbf{W}, \mathbf{a}_i) + f(\mathbf{W}, \tilde{\mathbf{W}}). \quad (68)$$

These two properties are the mathematical expressions of the sufficient conditions for the convergence of the alternating minimization algorithms which are stated in [21] and [22]. It means that if there exists a function $f(\mathbf{W}, \tilde{\mathbf{W}})$ with the parameter \mathbf{W} during two iterations that satisfies the two inequalities for the MSE in (67) and (68), the convergence of our proposed MMSE designs that make use of the alternating minimization algorithm can be proved by the theorem below.

Theorem: Let $\{(\underline{\mathbf{W}}_n, \underline{\mathbf{a}}_{i,n})\}_{n \geq 0}$, \mathbf{W}, \mathbf{a}_i be compact subsets of the compact metric space (\mathcal{M}, d) such that

$$\underline{\mathbf{W}}_n \xrightarrow{d_H} \mathbf{W} \quad \underline{\mathbf{a}}_{i,n} \xrightarrow{d_H} \mathbf{a}_i \quad (69)$$

and let $\text{MSE}: \mathcal{M} \times \mathcal{M} \rightarrow \mathbb{R}$ be a continuous function. Let conditions 1) and 2) hold. Then, for the proposed algorithms, we have

$$\lim_{n \rightarrow \infty} \text{MSE}(\mathbf{W}_n, \mathbf{a}_{i,n}) = \text{MSE}(\mathbf{W}_{opt}, \mathbf{a}_{i,opt}) \quad (70)$$

for $i = 1, 2, \dots, m-1$.

Thus, equation (65) can be satisfied. A general proof of this theorem is detailed in [21] and [22]. The proposed joint MSR designs can be stated as an alternating maximization strategy based on the SR defined in (47) that follows a similar procedure to the one above.

VII. SIMULATIONS

In this section, we assess the performance of our proposed joint designs of the linear receiver and power allocation methods and compare them with the equal power allocation method which allocates the same transmitting power level equally for all links from the relay nodes. For the purpose of fairness, we assume that the total transmitting power for all relay nodes in the network is the same which can be indicated as $\sum_{i=1}^{m-1} P_{T,i} = \sum_{i=1}^{m-1} \sum_{j=1}^{N_i} P_{T,i,j} = P_T$. We

consider a 3-hop ($m=3$) wireless sensor network as an example even though the algorithms can be used with any number of hops. The number of source nodes (N_0), two groups of relay nodes (N_1, N_2) and destination nodes (N_3) are 1, 4, 4 and 2, respectively. We consider an AF cooperation protocol. The quasi-static fading channel (block fading channel) is considered in our simulations whose elements are Rayleigh random variables (with zero mean and unit variance) and assumed to be invariant during the transmission of each packet. In our simulations, the channel is assumed to be known at the destination nodes. For channel estimation algorithms for WSNs and other low-complexity parameter estimation algorithms, one refers to [40] and [41]. During each phase, the sources transmit the QPSK modulated packets with 1500 symbols. The noise at the destination nodes is modeled as circularly symmetric complex Gaussian random variables with zero mean. A perfect (error free) feedback channel between destination nodes and relay nodes is assumed to transmit the amplification coefficients.

For the MMSE design, it can be seen from Fig. 5 that our three proposed methods achieve a better performance than the equal power allocation method. Among them, the method with a global constraint has the best performance whereas the method with individual constraints has the worst performance. This result is what we expect because a global constraint provides the largest degrees of freedom for allocating the power among the relay nodes whereas an individual constraint provides the least. For the MSR design, it can be seen from Fig. 6 that our proposed method achieves a better sum-rate performance than the equal power allocation method. Using the power method to calculate the dominant eigenvector yields a very similar result to the QR algorithm but requires a lower complexity.

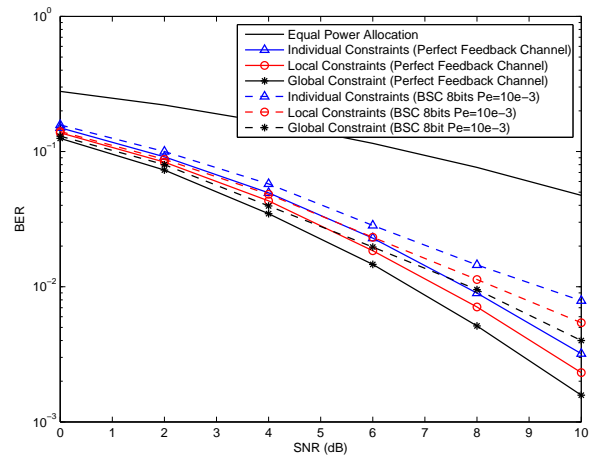

Fig. 5. BER performance versus SNR of our proposed joint MMSE design of the receiver and power allocation strategies, compared to the equal power allocation method.

Besides the equal power allocation scheme, a MMSE power allocation scheme reported in [42] where only the local power constraints are considered has also been used for comparison. It can be seen from Fig. 7 that our proposed MMSE and

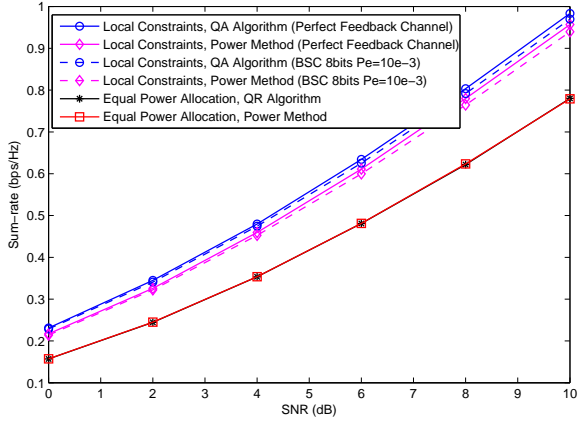

Fig. 6. Sum-rate performance versus SNR of our proposed joint MSR design of the receiver and power allocation strategies with local constraints, compared to the equal power allocation method.

MSR designs can achieve a very similar or better performance. Further advantage is that our proposed schemes only optimize the relay amplifying vectors (or diagonal matrices) whereas in [42] the optimal relay amplifying matrices are needed which requires more feedback transmissions as well as information exchanges among relay nodes in each group. Note that in order to have a fair comparison, we only employ power allocation schemes for the relay nodes and assume every source node has unit transmitting power in the simulations.

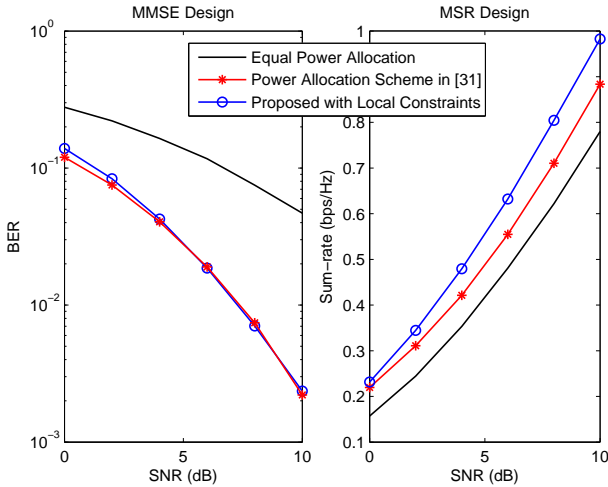

Fig. 7. (a) BER performance versus SNR of our proposed MMSE design (b) Sum-rate performance versus SNR of our proposed MSR design with local power constraints and compare with the power allocation scheme in [31] and equal power allocation scheme.

In practice, the feedback channel cannot be error free. In order to study the impact of feedback channel errors on the performance, we employ the binary symmetric channel (BSC) as the model for the feedback channel and quantize each complex amplification coefficient to an 8-bit binary value (4 bits for the real part, 4 bits for the imaginary part). The error probability (P_e) of the BSC is fixed at 10^{-3} . The dashed curves in Fig. 5 and Fig. 6 show the performance degradation

compared to the performance when using a perfect feedback channel. To show the performance tendency of the BSC for other values of P_e , we fix the SNR at 10 dB and choose P_e ranging from 0 to 10^{-2} . The performance curves are shown in Fig. 8 and Fig. 9, which illustrate the BER and the sum-rate performance versus P_e of our two proposed joint designs of the receivers. It can be seen that along with the increase in P_e , their performance becomes worse.

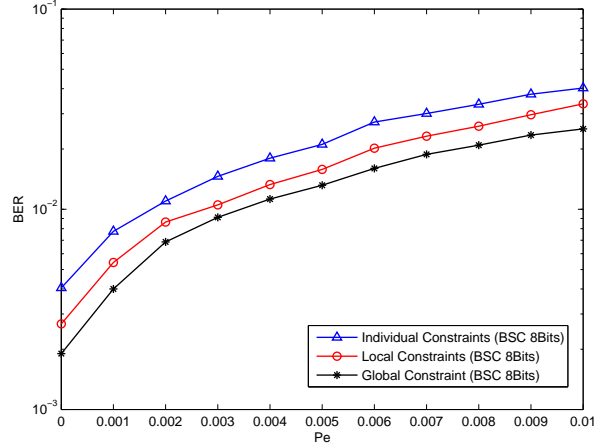

Fig. 8. BER performance versus P_e of our proposed MMSE designs when employing the BSC as the model for the feedback channel.

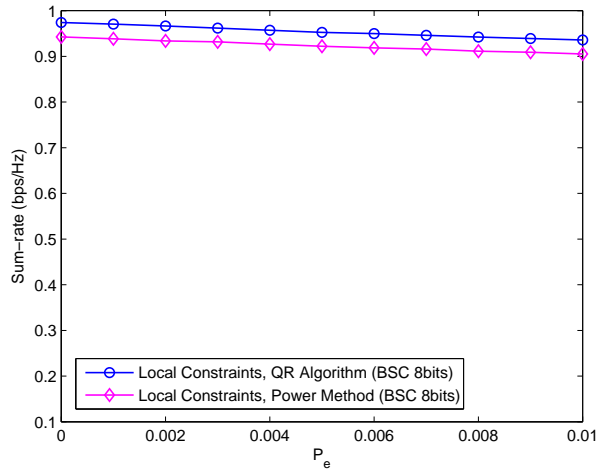

Fig. 9. Sum-rate performance versus P_e of our proposed MSR design when employing the BSC as the model for the feedback channel.

Finally, we replace the perfect CSI with the estimated channel coefficients to compute the receive filters and power allocation parameters at the destinations. We employ the BEACON channel estimation which was proposed in [40]. Fig. 10 illustrates the impact of the channel estimation on the performance of our proposed MMSE and SMR design with local constraints by comparing it to the performance of perfect CSI. The quantity n_t denotes the number of training sequence symbols per data packet. Please note that in these simulations perfect feedback channel is considered and the QR

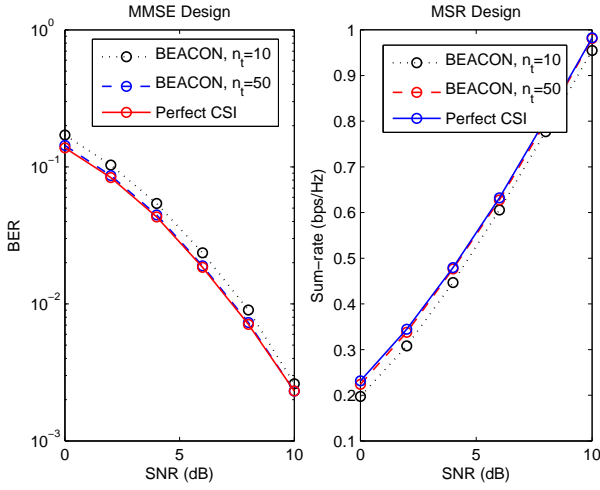

Fig. 10. (a) BER performance versus SNR of our proposed MMSE design (b) Sum-rate performance versus SNR our proposed MSR design with local power constraints when employing the BEACON channel estimation, compared to the performance of perfect CSI

algorithm is used in the MSR design. For both the MMSE and MSR designs, it can be seen that when n_t is set to 10, the BEACON channel estimation leads to an obvious performance degradation compared to the perfect CSI. However, when n_t is increased to 50, the BEACON channel estimation can achieve a similar performance to the perfect CSI. Other scenarios and network topologies have been investigated and the results show that the proposed algorithms work very well with channel estimation algorithms and a small number of training symbols.

VIII. CONCLUSIONS

In this paper, we have presented alternating optimization algorithms for receive filter design and power adjustment which can be applied to general multihop WSNs. MMSE and MSR criteria have been considered in the development of the algorithmic solutions. Simulations have shown that our proposed algorithms achieve a significant better performance than the equal power allocation and power allocation scheme in [42]. A possible extension of this work is employing low-complexity adaptive algorithms to compute the linear receiver and power allocation parameters. The algorithms can also be employed in other multihop wireless networks along with non-linear receivers.

APPENDIX

Here, we derive the the expressions of \mathbf{F}_i , $E(\mathbf{y}_i \mathbf{y}_i^H)$, and $E(\mathbf{y}_i \mathbf{s}^H)$ that are used in Section II, III and VI. It holds that

$$\mathbf{F}_i = \text{diag}\{E(|x_{i,1}|^2), E(|x_{i,2}|^2), \dots, E(|x_{i,N_i}|^2)\}^{-\frac{1}{2}} \quad (71)$$

where

$$E(|x_{i,j}|^2) = \begin{cases} \sigma_s^2 |\mathbf{h}_{s,j}|^2 + \sigma_n^2, & \text{for } i = 1, \\ \mathbf{h}_{i-1,j} \mathbf{A}_{i-1} E(\mathbf{y}_{i-1} \mathbf{y}_{i-1}^H) \mathbf{A}_{i-1}^H \mathbf{h}_{i-1,j}^H + \sigma_n^2, & \text{for } i = 2, 3, \dots, m, \end{cases} \quad (72)$$

$$E(\mathbf{y}_i \mathbf{y}_i^H) = \begin{cases} \mathbf{F}_i (\sigma_s^2 \mathbf{H}_s \mathbf{H}_s^H + \sigma_n^2 \mathbf{I}) \mathbf{F}_i^H, & \text{for } i = 1, \\ \mathbf{F}_i [\mathbf{H}_{i-1,i} \mathbf{A}_{i-1} E(\mathbf{y}_{i-1} \mathbf{y}_{i-1}^H) \mathbf{A}_{i-1}^H \mathbf{H}_{i-1,i}^H + \sigma_n^2 \mathbf{I}] \mathbf{F}_i^H & \text{for } i = 2, 3, \dots, m, \end{cases} \quad (73)$$

$$E(\mathbf{y}_i \mathbf{s}^H) = \begin{cases} \sigma_s^2 \mathbf{F}_i \mathbf{H}_s, & \text{for } i = 1, \\ \mathbf{F}_i \mathbf{H}_{i-1,i} \mathbf{A}_{i-1} E(\mathbf{y}_{i-1} \mathbf{s}^H), & \text{for } i = 2, 3, \dots, m. \end{cases} \quad (74)$$

REFERENCES

- [1] I. F. Akyildiz, W. Su, Y. Sankarasubramaniam, and E. Cayirci, "A Survey on Sensor Networks," *IEEE Commun. Mag.*, vol. 40, pp. 102-114, Aug. 2002.
- [2] J. N. Laneman, D. N. C. Tse and G. W. Wornell, "Cooperative diversity in wireless networks: Efficient protocols and outage behavior," *IEEE Trans. Inf. Theory*, vol. 50, no. 12, pp. 3062-3080, Dec. 2004.
- [3] Y. W. Hong, W. J. Huang, F. H. Chiu, and C. C. J. Kuo, "Cooperative Communications in Resource-Constrained Wireless Networks," *IEEE Signal Process. Mag.*, vol. 24, pp. 47-57, May 2007.
- [4] T. Peng, R. C. de Lamare and A. Schmeink, "Adaptive Distributed Space-Time Coding Based on Adjustable Code Matrices for Cooperative MIMO Relaying Systems", *IEEE Trans. on Communications*, vol. 61, no.7, July 2013.
- [5] T. Q. S. Quek, H. Shin, and M. Z. Win, "Robust Wireless Relay Networks: Slow Power Allocation With Guaranteed QoS," *IEEE J. Sel. Topics Signal Process.*, vol. 1, no. 4, pp. 700-713, Dec. 2007.
- [6] K. Vardhe, D. Reynolds, and B. D. Woerner, "Joint Power Allocation and Relay Selection for Multiuser Cooperative Communication" *IEEE Trans. Wireless Commun.*, vol. 9, no. 4, pp. 1255-1260, Apr. 2010.
- [7] Y. Li, B. Vucetic, Z. Zhou, and M. Dohler, "Distributed Adaptive Power Allocation for Wireless Relay Networks," *IEEE Trans. on Wireless Commun.*, vol. 6, no. 3, pp. 948-958, March 2007.
- [8] R. C. de Lamare and S. Li, "Joint Iterative Power Allocation and Linear Interference Suppression Algorithms for Cooperative DS-CDMA Networks" in *Proc. IEEE VTC*, May 2010.
- [9] R. C. de Lamare, "Joint iterative power allocation and linear interference suppression algorithms for cooperative DS-CDMA networks", *IET Communications*, vol. 6, no. 13, September 2012.
- [10] M. Dohler, A. Gkelias, and H. Aghvami, "Resource Allocation for FDMA-Based Regenerative Multihop Links," *IEEE Trans. on Wireless Commun.*, vol. 3, no. 6, Nov. 2004.
- [11] J. Adeane, M. R. D. Rodrigues, and I. J. Wassell, "Centralised and distributed power allocation algorithms in cooperative networks" *IEEE 6th Workshop on Signal Processing Advances in Wireless Communications*, 2005.
- [12] M. Chen, S. Serbetli, and A. Yener, "Distributed Power Allocation Strategies for Parallel Relay Networks," *IEEE Trans. on Wireless Commun.*, vol. 7, no. 2, Feb. 2008.
- [13] P. Clarke and R. C. de Lamare, "Transmit Diversity and Relay Selection Algorithms for Multirelay Cooperative MIMO Systems", *IEEE Trans. on Vehicular Technology*, vol. 61, no. 3, March 2012.
- [14] J. Boyer, D. D. Falconer, and H. Yanikomeroglu, "Multihop Diversity in Wireless Relaying Channels," *IEEE Trans. on Commun.*, vol. 52, no. 10, pp. 1820-1830, Oct. 2004.
- [15] H. Gharavi and K. Ban, "Multihop sensor network design for wide-band communications," *Proceedings of the IEEE*, vol. 91, no. 8, pp. 1221-1234, Aug. 2003.
- [16] Z. Shelby, C. Pomalaza-Raez, and J. Haapola, "Energy Optimization in Multihop Wireless Embedded and Sensor Networks," in *Proc. IEEE PIMRC*, Sep. 2004.
- [17] B. Maham and A. Hjørungnes, "Near-Optimum Power Allocation for BER Restricted Multihop Cooperative Networks," in *Proc. IEEE ICC*, May 2010.
- [18] A. P. T. Lau and S. Cui, "Joint Power Minimization in Wireless Relay Channels," *IEEE Trans. on Wireless Commun.*, vol. 6, no. 8, pp. 2820-2824, Aug. 2007.
- [19] G. Farhadi and N. C. Beaulieu, "Power-Optimized Amplify-and-Forward Multi-Hop Relaying Systems," *IEEE Trans. on Wireless Commun.*, vol. 8, no. 9, pp. 4634-4643, Sep. 2009.
- [20] M. O. Hasna and M. Alouini, "Optimal Power Allocation for Relayed Transmissions Over Rayleigh-Fading Channels," *IEEE Trans. on Wireless Commun.*, vol. 3, no. 6, pp. 1999-2004, Nov. 2004.

- [21] I. Csiszar and G. Tusnady, "Information geometry and alternating minimization procedure," *Statist. Decis.-Supplement Issue*, no. 1, pp. 205-237, 1984.
- [22] U. Niesen, D. Shah, and G. W. Wornell, "Adaptive alternating minimization algorithms," *IEEE Trans. Inf. Theory*, vol. 55, no. 3, pp. 1423-1429, Mar. 2009.
- [23] X. Deng and A. Haimovich, "Power allocation for cooperative relaying in wireless networks," *IEEE Trans. Commun.*, vol. 50, no. 12, pp. 3062-3080, Jul. 2005.
- [24] J. Huang, Z. Han, M. Chiang, and H. V. Poor, "Auction-Based Resource Allocation for Cooperative Communications," *IEEE J. Sel. Areas Commun.*, vol. 26, no. 7, pp. 1226-1237, Sep. 2008.
- [25] T. Wang, R. C. de Lamare, and A. Schmeink, "Joint Linear Receiver Design and Power Allocation Using Alternating Optimization Algorithms for Wireless Sensor Networks," *IEEE Trans. Veh. Technol.*, vol. 61, no. 9, Nov. 2012.
- [26] T. Wang, R. C. de Lamare and A. Schmeink, "Joint Maximum Sum-rate Receiver Design and Power Allocation Strategies for Multihop Wireless Sensor Networks," in *Proc. IEEE ICASSP*, Mar. 2012.
- [27] R. D. Juday, "Generalized Rayleigh quotient approach to filter optimization" *J. Opt. Soc.*, vol. 15, no. 4, pp. 777-790, Apr. 1998.
- [28] P. K. Varshney, *Distributed Detection and Data Fusion*, Springer-Verlag, 1997.
- [29] R.C. de Lamare, R. Sampaio-Neto, "Minimum mean-squared error iterative successive parallel arbitrated decision feedback detectors for DS-CDMA systems", *IEEE Trans. Commun.*, vol. 56, no. 5, May 2008, pp. 778-789.
- [30] P. Li and R. D. Murch, "Multiple Output Selection-LAS Algorithm in Large MIMO Systems", *IEEE Commun. Lett.*, vol. 14, no. 5, pp. 399-401, May 2010.
- [31] R. C. de Lamare, "Adaptive and Iterative Multi-Branch MMSE Decision Feedback Detection Algorithms for Multi-Antenna Systems", *IEEE Transactions on Wireless Communications*, vol. 14, no. 2, February 2013.
- [32] R. C. de Lamare and R. Sampaio-Neto, "Adaptive reduced-rank processing based on joint and iterative interpolation, decimation, and filtering," *IEEE Trans. Signal Process.*, vol. 57, no. 7, July 2009, pp. 2503-2514.
- [33] R.C. de Lamare and R. Sampaio-Neto, "Adaptive reduced-rank equalization algorithms based on alternating optimization design techniques for MIMO systems," *IEEE Trans. Veh. Technol.*, vol. 60, no. 6, pp. 2482-2494, July 2011.
- [34] J. W. Choi, A. C. Singer, J Lee, N. I. Cho, "Improved linear soft-input soft-output detection via soft feedback successive interference cancellation," *IEEE Trans. Commun.*, vol.58, no.3, pp.986-996, March 2010.
- [35] P. Li, R. C. de Lamare and R. Fa, "Multiple Feedback Successive Interference Cancellation Detection for Multiuser MIMO Systems," *IEEE Transactions on Wireless Communications*, vol. 10, no. 8, pp. 2434-2439, August 2011.
- [36] P. Li and R. C. de Lamare, "Adaptive Decision-Feedback Detection With Constellation Constraints for MIMO Systems", *IEEE Transactions on Vehicular Technology*, vol. 61, no. 2, 853-859, 2012.
- [37] S. Haykin, *Adaptive Filter Theory*, 4th ed. Englewood Cliffs, NJ: Prentice-Hall, 2002.
- [38] D. S. Watkins, *Fundamentals of Matrix Computations*, 2nd ed. John Wiley & Sons, New York, 2002.
- [39] G. H. Golub and C. F. V. Loan, *Matrix Computations*, 3rd ed. Baltimore, MD: Johns Hopkins Univ. Press, 1996.
- [40] T. Wang, R. C. de Lamare, and P. D. Mitchell, "Low-Complexity Set-Membership Channel Estimation for Cooperative Wireless Sensor Networks," *IEEE Trans. Veh. Technol.*, vol. 60, no. 6, May, 2011.
- [41] R. C. de Lamare and P. S. R. Diniz, "Set-Membership Adaptive Algorithms based on Time-Varying Error Bounds for CDMA Interference Suppression," *IEEE Trans. Veh. Technol.*, vol. 58, no. 2, Feb. 2009.
- [42] Y. Rong and Y. Hua, "Optimality of diagonalization of multi-hop MIMO relays," *IEEE Trans. on Wireless Commun.*, vol. 8, no. 12, pp. 6068-6077, Dec. 2009.