

Electromagnetic waves in an axion-active relativistic plasma non-minimally coupled to gravity

Alexander B. Balakin,^{1,*} Ruslan K. Muharlyamov,^{1,†} and Alexei E. Zayats^{1,‡}

¹*Department of General Relativity and Gravitation, Institute of Physics,
Kazan Federal University, Kremlevskaya str. 18, Kazan 420008, Russia*

We consider cosmological applications of a new self-consistent system of equations, accounting for a nonminimal coupling of the gravitational, electromagnetic and pseudoscalar (axion) fields in a relativistic plasma. We focus on dispersion relations for electromagnetic perturbations in an initially isotropic ultrarelativistic plasma coupled to the gravitational and axion fields in the framework of isotropic homogeneous cosmological model of the de Sitter type. We classify the longitudinal and transversal electromagnetic modes in an axionically active plasma and distinguish between waves (damping, instable or running), and nonharmonic perturbations (damping or instable). We show that for the special choice of the guiding model parameters the transversal electromagnetic waves in the axionically active plasma, nonminimally coupled to gravity, can propagate with the phase velocity less than speed of light in vacuum, thus displaying a possibility for a new type of resonant particle-wave interactions.

PACS numbers: 04.40.-b, 52.35.-g, 14.80.Va

Keywords: Axion field, relativistic plasma, Vlasov model, nonminimal coupling, dispersion relations

I. INTRODUCTION

Electromagnetic radiation provides the most important channel of information about our Universe. Valuable information about cosmic sources of photons, and about cosmic events accompanying the light propagation, is encoded in the intensity, polarization, phase and spectral characteristics of the electromagnetic radiation. In this sense, reconstruction of the phase and group velocities of observed electromagnetic waves, which travel through plasma and gas in the dark matter environment, gives us the basis for theoretical modeling of the properties of these cosmic substrates. When we deal with plasma, the phase and group velocities are given by $V_{\text{ph}} = \frac{\omega}{k}$ and $V_{\text{gr}} = \frac{\partial \omega}{\partial k}$, respectively, where ω is the frequency and k is the wave three-vector modulus. Thus, the dependence $\omega = \omega(k)$ obtained from the so-called *dispersion relations* for the longitudinal and transversal electromagnetic waves in plasma plays an important role in the information decryption. The theory of dispersion relations is well-elaborated for various plasma configurations (see, e.g., [1–4] for details, review and references). To obtain novel results in this scientific sphere we intend to use a new nonminimal Einstein-Maxwell-Vlasov-axion model [5], which deals with the self-consistent theory of tidal-type interactions between gravitational, electromagnetic, pseudoscalar (axion) fields and a relativistic multi-component plasma.

Cosmological applications of this model seem to be the most interesting, since the study of the interaction of four key players of the nonminimal Einstein-

Maxwell-Vlasov-axion model (gravitons, photons, electrically charged plasma particles and axions) is important for the description of the history of our Universe. There are at least three motives, which could explain this interest. First, in the early Universe the nonminimal coupling of a matter and fields to gravity was important on the stage of inflation, when the space-time curvature was varying catastrophically fast. Late-time accelerated expansion discovered recently [6–8] has revived an interest to inertial, tidal and rip’s effects [9–12], for which the curvature coupling could be also important. Second, the cold dark matter, which now is considered to be one of two key elements of the dark fluid, guiding the late-time Universe evolution [13–15], contains (hypothetically) an axion subsystem. In the early Universe the axions (light pseudo-Goldstone bosons) could be created due to the phase transition associated with the Peccei-Quinn symmetry breakdown [16–24]. In the late-time Universe these pseudo-bosons, probably, exist as relic axions, forming various cold dark matter configurations. Third, electrically charged plasma and photons are ubiquitous: one can find plasma configurations and an ocean of photons in every epoch in the cosmic history and in many objects, which form our Universe. Of course, studying the nonminimal Einstein-Maxwell-Vlasov-axion theory, we are restricted to theoretical modeling of the dispersion relations for relativistic homogeneous axionically active plasma. For instance, plasma can be treated as relativistic substratum in the early Universe; however, as was shown in the papers [25–27], the Peccei-Quinn phase transition is accompanied by the creation of strongly inhomogeneous axionic primordial configurations, which were indicated (see, e.g., [24, 25]) as “archioles”. The inhomogeneity of archioles type is frozen at the radiation domination stage and should be inherited in the large scale structure of the modern Universe. Additional problem in the theoretical modeling is con-

*Electronic address: Alexander.Balakin@kpfu.ru

†Electronic address: Ruslan.Muharlyamov@kpfu.ru

‡Electronic address: Alexei.Zayats@kpfu.ru

nected with instabilities generated in plasma due to its inhomogeneity (see, e.g., [28]). Self-gravitation of the pseudoscalar (axion) field produces gravitational instability similarly to the instability of scalar fields described in [29], thus making the studying of the electromagnetic waves propagation much more sophisticated. In such situation we need of some toy-model, which provides a balance between complexity of the problem as a whole and mathematical clarity of the simplified model. For the first step we have chosen the approximation, which is standard for homogeneous cosmological model: the spacetime metric and the axionic dark matter distribution are considered to depend on time only. In this case the standard approach to the analysis of waves propagation in relativistic plasma is based on the study of dispersion relations in terms of frequency ω and wave three-vector \vec{k} . When we consider homogeneous cosmological models, we can use the standard Fourier transformations with respect to spatial coordinates and can naturally introduce the analog of \vec{k} . The Fourier-Laplace transformation with respect to time is, generally, non-effective, since the coefficients in the master equations for the electromagnetic field depend on cosmological time. However, we have found one specific very illustrative model (the plasma is ultrarelativistic, the spacetime is of a constant curvature, the axion field has a constant time derivative), for which the master equations can be effectively transformed into a set of differential equations with constant coefficients. This simplified the analysis of the dispersion relations essentially, and allowed us to interpret the results in the standard terms. As a next step, we plan to consider homogeneous but anisotropic models, and then models with inhomogeneous distribution of the axionic dark matter.

In this work we obtain and analyze the dispersion relations for perturbations in the axionically active plasma, non-minimally coupled to gravity, classify these perturbations and distinguish the transversal waves, which can propagate with the phase velocity less than the speed of light in vacuum. The work is organized as follows. In Section II we describe the appropriate background state of the system as a whole, and discuss the exact solutions of non-perturbed master equations for the plasma in the gravitational and axionic fields, which were derived in [5]. In Section III we consider the equations for the electromagnetic perturbations in the (t, \vec{x}) form and then the equations for the corresponding Fourier-Laplace images in the (Ω, \vec{k}) form. We analyze in detail the dispersion relations for longitudinal waves in Section IV, and for transversal waves in Section V. We summarize the results in Section VI (Discussion).

II. ON THE BACKGROUND SOLUTIONS TO THE NONMINIMAL MASTER EQUATIONS

Let us consider the *background* solutions for the non-minimal Einstein-Maxwell-Vlasov-axion model, which satisfy the following four conditions. *First*, we assume

that the spacetime is isotropic, spatially homogeneous and is described by the metric

$$ds^2 = a^2(\tau)[d\tau^2 - (dx^2 + dy^2 + dz^2)]. \quad (1)$$

Second, we suppose that the pseudoscalar field inherits the spacetime symmetry and depends on time only, $\phi(\tau)$. *Third*, we assume, that both the background macroscopic (external) and cooperative (internal) electromagnetic fields are absent, i.e., the total Maxwell tensor is equal to zero $F_{ik} = 0$. *Fourth*, we consider the plasma to be the test ingredient of the cosmological model; this means that the contribution of the plasma particles into the total stress-energy tensor is negligible in comparison with the dark energy contribution, presented in our model by the Λ term, and with the dark matter one, described by the axion field $\Psi_0\phi$ (ϕ is dimensionless pseudoscalar field). These four requirements provide the master equations obtained in [5] to be reduced to the following system.

A. Background nonminimal equations for the gravity field

In the absence of the electromagnetic field the nonminimally extended Einstein equations take the form (see Subsection III E in [5])

$$R_{ik} - \frac{1}{2}Rg_{ik} - \Lambda g_{ik} = \kappa\Psi_0^2 \left[T_{ik}^{(A)} + \eta_2\mathcal{T}_{ik}^{(5)} + \eta_3\mathcal{T}_{ik}^{(6)} + \eta_{(A)}\mathcal{T}_{ik}^{(7)} \right], \quad (2)$$

where the term

$$T_{ik}^{(A)} = \left\{ \nabla_i\phi\nabla_k\phi - \frac{1}{2}g_{ik} \left[\nabla^m\phi\nabla_m\phi - m_{(A)}^2\phi^2 \right] \right\} \quad (3)$$

is the stress-energy tensor of the pseudoscalar field. The terms

$$\mathcal{T}_{ik}^{(5)} = R\nabla_i\phi\nabla_k\phi + (g_{ik}\nabla_n\nabla^n - \nabla_i\nabla_k) [\nabla_m\phi\nabla^m\phi] + \nabla_m\phi\nabla^m\phi \left(R_{ik} - \frac{1}{2}Rg_{ik} \right), \quad (4)$$

$$\begin{aligned} \mathcal{T}_{ik}^{(6)} = & \nabla_m\phi [R_i^m\nabla_k\phi + R_k^m\nabla_i\phi] + \\ & + \frac{1}{2}g_{ik} (\nabla_m\nabla_n - R_{mn}) [\nabla^m\phi\nabla^n\phi] - \\ & - \nabla^m [\nabla_m\phi \nabla_i\nabla_k\phi]. \end{aligned} \quad (5)$$

$$\mathcal{T}_{ik}^{(7)} = (\nabla_i\nabla_k - g_{ik}\nabla_m\nabla^m)\phi^2 - \left(R_{ik} - \frac{1}{2}Rg_{ik} \right)\phi^2 \quad (6)$$

describe the nonminimal contributions associated with coupling constants η_2 , η_3 , and $\eta_{(A)}$, respectively.

We are interested to analyze the specific solution to these equations, which is characterized by the de Sitter metric

$$ds^2 = \frac{1}{H^2\tau^2} [d\tau^2 - (dx^2 + dy^2 + dz^2)] \quad (7)$$

with

$$a(\tau) = -\frac{1}{H\tau}, \quad (8)$$

where H is a constant. With the transformation of time

$$\tau = -\frac{1}{Ha(t_0)} e^{-H(t-t_0)}, \quad (9)$$

which gives the correspondence: $\tau \rightarrow 0$, when $t \rightarrow \infty$; $\tau \rightarrow -\infty$, when $t \rightarrow -\infty$; $\tau \rightarrow -\frac{1}{Ha(t_0)} \equiv \tau_0$, when $t \rightarrow t_0$, one can obtain the well-known form of the de Sitter metric

$$ds^2 = dt^2 - e^{2H(t-t_0)} a^2(t_0) (dx^2 + dy^2 + dz^2). \quad (10)$$

The de Sitter metric (7) describes the spacetime of constant curvature, for which the basic geometric quantities of the Riemann tensor, the Ricci tensor and Ricci scalar take the form

$$\begin{aligned} R_{ikmn} &= -H^2(g_{im}g_{kn} - g_{in}g_{km}), \\ R_{im} &= -3H^2g_{im}, \quad R = -12H^2, \end{aligned} \quad (11)$$

and the nonminimal susceptibility tensors

$$\begin{aligned} \mathcal{R}^{ikmn} &\equiv \frac{q_1}{2} R(g^{im}g^{kn} - g^{in}g^{km}) + \\ &+ \frac{q_2}{2} (R^{im}g^{kn} - R^{in}g^{km} + R^{kn}g^{im} - R^{km}g^{in}) + \\ &+ q_3 R^{ikmn}, \end{aligned} \quad (12)$$

$$\begin{aligned} \chi_{(A)}^{ikmn} &\equiv \frac{Q_1}{2} R(g^{im}g^{kn} - g^{in}g^{km}) + \\ &+ \frac{Q_2}{2} (R^{im}g^{kn} - R^{in}g^{km} + R^{kn}g^{im} - R^{km}g^{in}) + \\ &+ Q_3 R^{ikmn}, \end{aligned} \quad (13)$$

$$\mathfrak{R}_{(A)}^{mn} \equiv \frac{1}{2}\eta_1 (F^{ml}R_l^n + F^{nl}R_l^m) + \eta_2 Rg^{mn} + \eta_3 R^{mn} \quad (14)$$

introduced in [5] transform into

$$\mathcal{R}^{ikmn} = -H^2(6q_1 + 3q_2 + q_3) (g^{im}g^{kn} - g^{in}g^{km}), \quad (15)$$

$$\chi_{(A)}^{ikmn} = -H^2(6Q_1 + 3Q_2 + Q_3) (g^{im}g^{kn} - g^{in}g^{km}), \quad (16)$$

$$\mathfrak{R}_{(A)}^{mn} = -3H^2(4\eta_2 + \eta_3)g^{mn}. \quad (17)$$

One can check directly that the de Sitter-type metric (1) with the scale factor (8) is the exact solution of the equations (2)-(6) with the pseudoscalar field linear in time, i.e., $\phi(\tau) = \nu\tau$, when the following three relationships are satisfied:

$$\Lambda = 3H^2, \quad m_{(A)}^2 = \frac{2}{9}\Lambda^2(6\eta_2 + \eta_3), \quad (18)$$

$$\eta_{(A)} = -\frac{1}{6} + \frac{1}{9}\Lambda(9\eta_2 + 2\eta_3). \quad (19)$$

These relations contain neither ν , nor Ψ_0 . In addition, when $\eta_2 = \eta_3 = 0$, we obtain the result

$$\Lambda = 3H^2, \quad m_{(A)} = 0, \quad \eta_{(A)} = -\frac{1}{6}, \quad (20)$$

which is well-known for the massless scalar field conformally coupled to gravity [30]. When the constants of nonminimal coupling η_2 and η_3 are nonvanishing, we can consider the axions to be massive, and the mass $m_{(A)}$ itself is connected not only with these coupling constants, but with the cosmological constant Λ as well. In order to minimize the number of unknown coupling parameters, one can put, for instance,

$$\eta_3 = -\frac{9}{2}\eta_2, \quad \eta_{(A)} = -\frac{1}{6}, \quad \eta_2 = \frac{3m_{(A)}^2}{\Lambda^2}, \quad (21)$$

satisfying (18) and (19).

B. Nonminimal equations for the background pseudoscalar (axion) field

In the absence of the background electromagnetic field the nonminimally extended master equation (see Eq.(88) in [5]) for the pseudoscalar ϕ takes the form

$$\begin{aligned} \nabla_m \left[(g^{mn} + \mathfrak{R}_{(A)}^{mn}) \nabla_n \phi \right] + [m_{(A)}^2 + \eta_{(A)} R] \phi &= \\ = -\frac{1}{\Psi_0^2} \sum_{(a)} \int dP f_{(a)} \mathcal{G}_{(a)}. \end{aligned} \quad (22)$$

Let us take into account the relations (15)-(17) for $\mathfrak{R}_{(A)}^{mn}$ and $\chi_{(A)}^{ikmn}$, and suppose that for the background distribution function its zero-order moment in the right-side hand of (22) vanishes, then we obtain the equation

$$[1 - 3H^2(4\eta_2 + \eta_3)] \nabla^m \nabla_m \phi + (m_A^2 - 12H^2\eta_{(A)}) \phi = 0. \quad (23)$$

The function $\phi = \nu\tau$ satisfies (23), if the following relation is valid

$$-2H^2[1 - 3H^2(4\eta_2 + \eta_3)] + m_A^2 - 12H^2\eta_{(A)} = 0. \quad (24)$$

We used here the relation

$$\nabla^m \nabla_m \phi = \frac{1}{a^4} \frac{d}{d\tau} (a^2 \dot{\phi}) = -2H^2 \nu \tau. \quad (25)$$

Clearly, the relation (24) is identically satisfied, when the equations (18), (19) are valid. In other words, we have shown that the master equation for the background pseudoscalar (axion) field admits the existence of the exact solution $\phi(\tau) = \nu\tau$ linear in time, when the spacetime is of the de Sitter type with the metric (7).

C. Consistency of the background electrodynamic equations

We assume that the Maxwell tensor describing the background cooperative electromagnetic field in plasma is equal to zero, $F_{ik} = 0$. It is possible, when the tensor of spontaneous polarization-magnetization \mathcal{H}^{ik} vanishes, and when the four-vector of electric current in plasma, I^i , is equal to zero. Since $\phi = \phi(\tau)$ and $R^{\alpha 0} = 0$ ($\alpha = 1, 2, 3$) the formula (see (87) in [5])

$$\mathcal{H}^{ik} \equiv -\frac{1}{2}\eta_1\Psi_0^2 [(R^{km}\nabla^i\phi - R^{im}\nabla^k\phi)\nabla_m\phi], \quad (26)$$

gives $\mathcal{H}^{ik} = 0$. The condition $I^i = 0$ provides the restrictions for the background distribution function $f_{(a)}$, which we will discuss in the next subsection.

D. Background solution to the Vlasov equation

In the context of the Vlasov theory we search for a 8-dimensional one-particle distribution function $f_{(a)}(x^i, p_k)$ which describes particles of a sort (a) with the rest mass $m_{(a)}$, electric charge $e_{(a)}$. This function of the coordinates x^i and of the momentum four-covector p_k satisfies the relativistic kinetic equation, which can be presented now in the form

$$p^i \left(\frac{\partial}{\partial x^i} + \Gamma_{ik}^l p_l \frac{\partial}{\partial p_k} \right) f_{(a)} = 0. \quad (27)$$

We assume here that the background macroscopic cooperative electromagnetic field in plasma is absent, and there are no contact interactions between axions and plasma particles, so that the force $\mathcal{F}_{(a)}^i$ (see Eq.(29) in [5]) disappears from this equation. In the cosmological context we consider the distribution function depending on the covariant components of the particle four-momentum, p_k in order to simplify the analysis. Here Γ_{ik}^m are the Christoffel symbols associated with the spacetime metric g_{ik} . The characteristic equations associated with the kinetic equation (27)

$$\frac{dp_k}{ds} - \Gamma_{ik}^l p_l \frac{dx^i}{ds} = 0, \quad \frac{dx^i}{ds} = \frac{1}{m_{(a)}} g^{ij} p_j, \quad (28)$$

are known to be directly solved for the metric (1). For the cases $i = \alpha = 1, 2, 3$ one obtains immediately that

$$p_\alpha = q_\alpha, \quad (29)$$

where $q_\alpha = \text{const}$ are the integrals of motion. The component p_0 of the particle momentum four-vector can be found from the quadratic integral of motion $g^{ij} p_i p_j = m_{(a)}^2 = \text{const}$:

$$p_0 = \sqrt{m_{(a)}^2 a^2(\tau) + q^2}, \quad q^2 \equiv q_1^2 + q_2^2 + q_3^2 = \text{const}. \quad (30)$$

Other three integrals of motion are

$$X^\alpha = x^\alpha(\tau) + \frac{q_\alpha}{q^2} \sqrt{\frac{m_{(a)}^2}{H^2} + q^2 \tau^2}. \quad (31)$$

Generally, the distribution function, which satisfies kinetic equation (27) can be reconstructed as an arbitrary function of seven integrals of motion $q_\alpha, X^\alpha, \sqrt{g^{ij} p_i p_j}$, nevertheless, taking into account that the spacetime is isotropic and homogeneous, we require that the distribution function inherits this symmetry and thus it has the form

$$f_{(a)}(x^l, p_k) = f_{(a)}^{(0)}(q^2) \delta(\sqrt{g^{sn} p_s p_n} - m_{(a)}), \quad (32)$$

where $f_{(a)}^{(0)}(q^2)$ is arbitrary function of one argument, namely, q^2 . We are interested now to calculate the first moment of the distribution function

$$N_{(a)}^i \equiv \frac{1}{m_{(a)}} \int \frac{d_4 P}{\sqrt{-g}} g^{ij} p_j f_{(a)}(x^l, p_k) \times \delta(\sqrt{g^{sn} p_s p_n} - m_{(a)}) \Theta(V^h p_h), \quad (33)$$

where $d_4 P = dp_0 dp_1 dp_2 dp_3$ symbolizes the volume in the four-dimensional momentum space; the delta function guarantees the normalization property of the particle momentum, the Heaviside function $\Theta(V^h p_h)$ rejects negative values of energy, V^h is the velocity four-vector of the system as a whole. In the de Sitter spacetime with $V^h = \delta_0^h \frac{1}{a(\tau)}$ the quantities $N_{(a)}^i$ can be reduced to

$$N_{(a)}^i(\tau) = \int \frac{dq_1 dq_2 dq_3}{a^2 p_0} g^{ij} p_j f_{(a)}^{(0)}(q^2), \quad (34)$$

therefore, the spatial components $N_{(a)}^\alpha$ vanish. The component $N_{(a)}^0$ reads

$$N_{(a)}^0(\tau) = \frac{4\pi}{a^4} \int_0^\infty q^2 dq f_{(a)}^{(0)}(q^2) \equiv \frac{\mathcal{N}_{(a)}}{a^4(\tau)}, \quad (35)$$

where $\mathcal{N}_{(a)}$ does not depend on time. This means that the four-vector of the electric current in the electro-neutral plasma

$$I^i(\tau) = \sum_{(a)} e_{(a)} N_{(a)}^i = \frac{1}{a^4(\tau)} \delta_0^i \sum_{(a)} e_{(a)} \mathcal{N}_{(a)} = 0, \quad (36)$$

is equal to zero at arbitrary time moment τ , if it was equal to zero at the initial time moment. This guarantees that the Maxwell equations are self-consistent.

III. ELECTROMAGNETIC PERTURBATIONS IN AN AXIONICALLY ACTIVE ULTRARELATIVISTIC PLASMA NONMINIMALLY COUPLED TO GRAVITY

A. Evolutionary equations

Let us consider now the state of plasma perturbed by a local variation of electric charge. As usual, we assume, first, that the distribution function takes the form $f_{(a)} \rightarrow f_{(a)}^{(0)}(q^2) + \delta f_{(a)}(\tau, x^\alpha, p_k)$, second, that the tensor F_{ik} describing the variation of the cooperative electromagnetic field in plasma is not equal to zero. Let us stress that the electromagnetic source in the right-hand side of the master equation for the pseudoscalar field (see Eq.(88) in [5]) is quadratic in the Maxwell tensor, and thus, in the linear approximation the background axion field $\phi(\tau) = \nu\tau$ remains unperturbed. Similarly, the non-minimally extended equations for the gravity field (see Eqs.(89)-(100) in [5]) are considered to be unperturbed. This is possible, when the term $\eta_1 \mathcal{T}_{ik}^{(4)}$, which is in fact the exclusive term linear in the Maxwell tensor, is vanishing. Below we assume, that $\eta_1 = 0$, thus guaranteeing that the background de Sitter spacetime is not perturbed in the linear approximation. For the perturbed quantities F_{ik} and $\delta f_{(a)}$ we obtain the following coupled system of equations:

$$\begin{aligned} & [1 - 2H^2(6q_1 + 3q_2 + q_3)] \nabla_k F^{ik} + \\ & + [1 - 4H^2(3Q_1 - Q_3)] \bar{F}^{*ik} \nabla_k \phi = \\ & = -4\pi \sum_{(a)} e_{(a)} \int dP \delta f_{(a)} g^{ik} p_k, \end{aligned} \quad (37)$$

$$\nabla_k \bar{F}^{*ik} = 0, \quad (38)$$

$$g^{ij} p_j \left(\frac{\partial}{\partial x^i} + \Gamma_{ik}^m p_m \frac{\partial}{\partial p_k} \right) \delta f_{(a)} = e_{(a)} p_i F_k^i \frac{\partial}{\partial p_k} f_{(a)}^{(0)}. \quad (39)$$

Below we analyze this system for the case, when the plasma particles are ultrarelativistic. The procedure of derivation of the dispersion relations for the case of the ultrarelativistic plasma is very illustrative in our model. Below we assume that in average $q^2 \gg m_{(a)}^2 a^2(\tau)$, so that p_0 can be replaced by $p_0 \rightarrow q$ in the integrals. Keeping in mind that in the linear approximation $\phi = \nu\tau = \frac{\nu}{H a(\tau)}$, one can check directly that the scale factor $a(\tau)$ disappears from the reduced electrodynamic equations, which

take the following form:

$$(1 + 2K_1) \eta^{\alpha\beta} \partial_\alpha F_{\beta 0} = 4\pi \sum_{(a)} e_{(a)} \int d_3 q \delta f_{(a)}, \quad (40)$$

$$\begin{aligned} & (1 + 2K_1) [\partial_0 F_{\alpha 0} + \eta^{\beta\gamma} \partial_\beta F_{\alpha\gamma}] - \\ & - \frac{1}{2} \nu \epsilon_\alpha^{\beta\gamma} F_{\beta\gamma} (1 + 2K_2) = \\ & = -4\pi \sum_{(a)} e_{(a)} \int \frac{d_3 q}{q} q_\alpha \delta f_{(a)}, \end{aligned} \quad (41)$$

$$\partial_0 F_{\alpha\beta} + \partial_\alpha F_{\beta 0} - \partial_\beta F_{\alpha 0} = 0, \quad (42)$$

$$\partial_\alpha F_{\beta\gamma} + \partial_\beta F_{\gamma\alpha} + \partial_\gamma F_{\alpha\beta} = 0. \quad (43)$$

Here we used the following notations:

$$\begin{aligned} K_1 & \equiv -H^2(6q_1 + 3q_2 + q_3), \\ K_2 & \equiv -2H^2(3Q_1 - Q_3), \end{aligned} \quad (44)$$

and introduced the three-dimensional Levi-Civita symbol

$$\epsilon^{\alpha\beta\gamma} \equiv E^{0\alpha\beta\gamma}, \quad (45)$$

with $\epsilon^{123} = 1$. Here and below for the operation with the indices we use the Minkowski tensor $\eta_{ik} = \text{diag}(1, -1, -1, -1)$.

The kinetic equation (39) for the ultrarelativistic plasma in the linear approximation can be written in the form

$$q \partial_0 \delta f_{(a)} + \eta^{\alpha\beta} q_\alpha \partial_\beta \delta f_{(a)} = e_{(a)} \eta^{\alpha\beta} F_{\beta 0} q_\alpha \frac{df_{(a)}^{(0)}}{dq}. \quad (46)$$

Surprisingly, in the given representation all the electrodynamic equations (40)-(43) and the kinetic equation (46) look like the set of integro-differential equations with the coefficients, which do not depend on time. This fact allows us to apply the method of Fourier transformations, which is widely used in case, when we deal with the Minkowski spacetime [1-4].

B. Equations for Fourier-Laplace images

In order to study in detail perturbations arising in plasma we consider the Fourier-Laplace transformations (the Fourier transformation with respect to the spatial coordinates x^α and the Laplace transformation for τ) in the following form:

$$\delta f_{(a)} = \int \frac{d\Omega d_3 k}{(2\pi)^4} \delta \varphi_{(a)}(\Omega, k_\gamma, q_\beta) e^{i(k_\alpha x^\alpha - \Omega\tau)}, \quad (47)$$

$$F_{lk} = \int \frac{d\Omega d_3 k}{(2\pi)^4} \mathcal{F}_{lk}(\Omega, k_\gamma) e^{i(k_\alpha x^\alpha - \Omega\tau)}. \quad (48)$$

As usual, we assume that k_1, k_2, k_3 are pure real quantities in order to guarantee that both exponential functions, $e^{ik_\alpha x^\alpha}$ and $e^{-ik_\alpha x^\alpha}$, are finite everywhere. The

quantity Ω is in general case the complex one, $\Omega = \omega + i\gamma$, and, as usual, we assume that perturbations are absent at $\tau < \tau_0$, where $\tau_0 = -\frac{1}{Ha(t_0)}$ relates to the moment $t = t_0$ according to (9). Our choice of the sign minus in the expression for the phase $\Theta \equiv k_\alpha x^\alpha - \Omega\tau$ in the exponentials in (47), (48) can be motivated as follows. When the value $t - t_0$ is small, the cosmological time τ (see (9)) can be estimated as $\tau \rightarrow -\frac{1}{Ha(t_0)}[1 - H(t - t_0)]$, and thus the phase Θ reads

$$\Theta = \Theta_0 + k_\alpha x^\alpha - \frac{\Omega}{a(t_0)}(t - t_0), \quad \Theta_0 = -\frac{\Omega}{Ha(t_0)}. \quad (49)$$

Using the notation $k_0 = -\frac{\Omega}{a(t_0)}$ we obtain from (49) the expression for the phase $\Theta = \Theta_0 + k_m x^m$, which is standard for the case of Minkowski spacetime. Finally, the term $e^{i\Theta}$ has the multiplier $e^{-i\Omega\tau}$ which contains $e^{\gamma\tau} \rightarrow e^{\frac{\gamma}{a(t_0)}(t-t_0)}$. In other words, both in terms of t and τ the quantity γ has the same sense: when $\gamma < 0$ we deal with the plasma-wave damping and $|\gamma|$ is the decrement of damping; when $\gamma > 0$ we deal with increasing of the perturbation in plasma and this positive γ is the increment of instability.

We should introduce an initial value of the perturbed distribution function at the moment $\tau = \tau_0$, indicated as $\delta f_{(a)}(0, k_\alpha, q_\gamma)$; as for initial data for the electromagnetic field, we can put without loss of generality that $F_{\alpha 0}(\tau=0, k_\beta) = 0$. Using (40)-(43) and (46) the equations for the Fourier images $\delta\varphi_{(a)}(\Omega, k_\gamma, q_\beta)$ and $\mathcal{F}_{lk}(\Omega, k_\gamma)$ can be written as follows:

$$\begin{aligned} & \left(\Omega - \frac{k_\alpha q^\alpha}{q} \right) \delta\varphi_{(a)} = \\ & = i e_{(a)} \mathcal{F}_{\alpha 0} \frac{q^\alpha}{q} \cdot \frac{df_{(a)}^{(0)}}{dq} + i \delta f_{(a)}(0, k_\alpha, q_\gamma), \end{aligned} \quad (50)$$

$$(1 + 2K_1) k^\alpha \mathcal{F}_{\alpha 0} = -4\pi i \sum_{(a)} e_{(a)} \int d_3 q \delta\varphi_{(a)}, \quad (51)$$

$$\begin{aligned} (1 + 2K_1) (\Omega \mathcal{F}_{\alpha 0} - k^\gamma \mathcal{F}_{\alpha\gamma}) - \frac{i}{2} \nu \epsilon_\alpha^{\beta\gamma} \mathcal{F}_{\beta\gamma} (1 + 2K_2) = \\ = -4\pi i \sum_{(a)} e_{(a)} \int d_3 q \delta\varphi_{(a)} \frac{q_\alpha}{q}, \end{aligned} \quad (52)$$

$$\mathcal{F}_{\alpha\beta} = \Omega^{-1} (k_\alpha \mathcal{F}_{\beta 0} - k_\beta \mathcal{F}_{\alpha 0}), \quad (53)$$

$$k_\alpha \mathcal{F}_{\beta\gamma} + k_\beta \mathcal{F}_{\gamma\alpha} + k_\gamma \mathcal{F}_{\alpha\beta} = 0. \quad (54)$$

Here and below we use the notation $q^\alpha \equiv \eta^{\alpha\beta} q_\beta$ for the sake of simplicity. Clearly, the equation (54) is satisfied identically, if we put $\mathcal{F}_{\alpha\beta}$ from (53). Then we use the standard method: we take $\delta\varphi_{(a)}$ from (50), put it into (51) and (52), use (53) and obtain, finally, the equations for the Fourier images of the components $\mathcal{F}_{\beta 0}$ of

the Maxwell tensor:

$$\left[k^\alpha (1 + 2K_1) - 4\pi \sum_{(a)} e_{(a)}^2 \int \frac{d_3 q q^\alpha}{(q\Omega - k_\beta q^\beta)} \cdot \frac{df_{(a)}^{(0)}}{dq} \right] \mathcal{F}_{\alpha 0} = \mathcal{J}_0, \quad (55)$$

$$\begin{aligned} & \left\{ (1 + 2K_1) [\Omega^2 \delta_\alpha^\gamma - k^2 \Pi_\alpha^\gamma] - i \nu \epsilon_\alpha^{\beta\gamma} k_\beta (1 + 2K_2) - \right. \\ & \left. - 4\pi \sum_{(a)} \Omega e_{(a)}^2 \int \frac{d_3 q q_\alpha q^\gamma}{q(q\Omega - k_\beta q^\beta)} \cdot \frac{df_{(a)}^{(0)}}{dq} \right\} \mathcal{F}_{\gamma 0} = \Omega \mathcal{J}_\alpha. \end{aligned} \quad (56)$$

The Fourier images of the initial perturbations of the electric current \mathcal{J}_0 and \mathcal{J}_α are defined as follows:

$$\mathcal{J}_0 \equiv 4\pi \sum_{(a)} e_{(a)} \int \frac{d_3 q q \delta f_{(a)}(0, k_\beta, q_\gamma)}{q\Omega - k_\mu q^\mu}, \quad (57)$$

$$\mathcal{J}_\alpha \equiv 4\pi \sum_{(a)} e_{(a)} \int \frac{d_3 q q_\alpha \delta f_{(a)}(0, k_\beta, q_\gamma)}{q\Omega - k_\mu q^\mu}. \quad (58)$$

The compatibility condition for the current four-vector $\nabla_k \mathcal{J}^k = 0$, written in terms of Fourier images

$$\Omega \mathcal{J}_0 - k^\alpha \mathcal{J}_\alpha = 4\pi \sum_{(a)} e_{(a)} \int d_3 q \delta f_{(a)}(0, k_\beta, q_\gamma) = 0, \quad (59)$$

requires in fact that the perturbation in the plasma state does not change the particle number. The term Π_α^γ is a projector:

$$\Pi_\alpha^\gamma = \delta_\alpha^\gamma + \frac{k_\alpha k^\gamma}{k^2}, \quad \Pi_\alpha^\gamma \Pi_\gamma^\mu = \Pi_\alpha^\mu, \quad (60)$$

it is orthogonal to k_α , i.e.,

$$\Pi_\alpha^\gamma k^\alpha = 0 = \Pi_\alpha^\gamma k_\gamma. \quad (61)$$

The quantity k^2 is defined as $k^2 = -k_\beta k^\beta$; it is real and positive.

C. Permittivity tensors

As usual, we introduce the standard permittivity tensor for the spatially isotropic relativistic plasma [1]

$$\epsilon_\alpha^\gamma = \delta_\alpha^\gamma - \frac{4\pi}{\Omega} \sum_{(a)} e_{(a)}^2 \int \frac{d_3 q q_\alpha q^\gamma}{q(q\Omega - k_\beta q^\beta)} \cdot \frac{df_{(a)}^{(0)}}{dq}, \quad (62)$$

and obtain the decomposition

$$\varepsilon_\alpha^\gamma = \varepsilon_\perp \left(\delta_\alpha^\gamma + \frac{k_\alpha k^\gamma}{k^2} \right) - \varepsilon_\parallel \cdot \frac{k_\alpha k^\gamma}{k^2}, \quad (63)$$

where ε_\perp and ε_\parallel are the scalar transversal and longitudinal permittivities, respectively:

$$\varepsilon_\perp \equiv \frac{1}{2} (\varepsilon_\alpha^\alpha - \varepsilon_\parallel), \quad (64)$$

$$\varepsilon_\parallel \equiv 1 + \frac{4\pi}{k^2} \sum_{(a)} e_{(a)}^2 \int \frac{d_3 q k_\alpha q^\alpha}{(q\Omega - k_\beta q^\beta)} \cdot \frac{df_{(a)}^{(0)}}{dq}. \quad (65)$$

Finally, we decompose the Fourier image of the electric field $\mathcal{F}_{\gamma 0}$ into the longitudinal and transversal components with respect to the wave three-vector

$$\mathcal{F}_{\gamma 0} = \frac{k_\gamma}{k} \mathcal{E}^\parallel + \mathcal{E}_\gamma^\perp, \quad (66)$$

where

$$\mathcal{E}^\parallel \equiv -\mathcal{F}_{\gamma 0} \frac{k^\gamma}{k}, \quad \mathcal{E}_\gamma^\perp \equiv \mathcal{F}_{\beta 0} \Pi_\gamma^\beta, \quad (67)$$

and obtain the split equations for the Fourier images of the longitudinal and transversal electric field components, respectively:

$$\mathcal{E}^\parallel = -\frac{\mathcal{J}_0}{k (\varepsilon_\parallel + 2K_1)}, \quad (68)$$

$$\left[\left(\varepsilon_\perp + 2K_1 - \frac{(1+2K_1)k^2}{\Omega^2} \right) \delta_\alpha^\gamma + \frac{i\nu}{\Omega^2} \varepsilon_\alpha^{\gamma\beta} k_\beta (1+2K_2) \right] \mathcal{E}_\gamma^\perp = \frac{1}{\Omega} \Pi_\alpha^\gamma \mathcal{J}_\gamma. \quad (69)$$

The second term in the brackets (linear in the wave three-vector k_β) describes the well-known effect of optical activity: two transversal components of the field \mathcal{E}_γ^\perp are coupled, so that linearly polarized waves do not exist, when $\nu(1+2K_2) \neq 0$. Since the so-called gyration tensor $\frac{\nu}{\Omega^2} \varepsilon_\alpha^{\gamma\beta} (1+2K_2)$ is proportional to the Levi-Civita symbol $\varepsilon_\alpha^{\gamma\beta}$, we deal with *natural optical activity* according to the terminology used in [31], which can be described by one (pseudo) scalar quantity. Thus, we can speak about axionically induced optical activity in plasma, and about axionically active plasma itself.

D. Dispersion relations

The inverse Fourier-Laplace transformation (48) of the electromagnetic field is associated with the calculation of the residues in the singular points of two principal types. First, one should analyze the poles of the functions \mathcal{J}_0

and \mathcal{J}_α (see (57) and 58)) describing initial perturbations; the most known among them are the Van Kampen poles $\Omega = \frac{k_\alpha q^\alpha}{q}$. The poles of the second type appear as the roots of the equations

$$\varepsilon_\parallel + 2K_1 = 0, \quad (70)$$

and

$$\det \left[\left(\varepsilon_\perp + 2K_1 - \frac{(1+2K_1)k^2}{\Omega^2} \right) \delta_\alpha^\gamma - \frac{i\nu}{\Omega^2} \varepsilon_\alpha^{\beta\gamma} k_\beta (1+2K_2) \right] = 0. \quad (71)$$

The equation (70) is the nonminimal generalization of the dispersion relations for the longitudinal plasma waves; it includes the spacetime curvature and the constants of nonminimal coupling (via the term K_1 , see (44)), nevertheless, it does not contain any information about the axion field. The equation (71) describes transversal electromagnetic waves in axionically active plasma nonminimally coupled to gravity; it can be transformed into

$$\left[\varepsilon_\perp + 2K_1 - \frac{(1+2K_1)k^2}{\Omega^2} \right] \left[\left(\varepsilon_\perp + 2K_1 - \frac{(1+2K_1)k^2}{\Omega^2} \right)^2 - \frac{\nu^2 (1+2K_2)^2 k^2}{\Omega^4} \right] = 0. \quad (72)$$

This dispersion equation generalizes the one obtained in [32, 33] for a minimal axionic vacuum. Clearly, one should consider two important cases.

1. Special case $1+2K_2 = 0$

The condition $1+2K_2 = 0$ rewritten as $3Q_1 - Q_3 = \frac{1}{4H^2}$, provides the dispersion relations to be of the form

$$\left[\varepsilon_\perp + 2K_1 - \frac{(1+2K_1)k^2}{\Omega^2} \right] = 0, \quad (73)$$

includes the curvature terms and does not contain the information about the axion field.

2. General case $1+2K_2 \neq 0$

In this case the dispersion relations for the transversal electromagnetic perturbations read

$$\varepsilon_\perp = -2K_1 + \frac{(1+2K_1)k^2 \pm \nu(1+2K_2)k}{\Omega^2}, \quad (74)$$

displaying explicitly the dependence on the axion field strength ν . Two signs, plus and minus, symbolize the difference in the dispersion relations for waves with left-hand and right-hand polarization rotation. In this sense, when $1+2K_2 \neq 0$, we deal with an axionically active plasma.

E. Analytical properties of the permittivity tensor and the inverse Laplace transformation

Let us remind three important features concerning the Laplace transformation in the context of relativistic plasma theory. First, as usual, we treat this transformation as a limiting procedure

$$f(\tau) = \frac{1}{2\pi} \lim_{A \rightarrow +\infty} \int_{-A+i\sigma}^{+A+i\sigma} F(\Omega) e^{-i\Omega\tau} d\Omega, \quad (75)$$

where a real positive parameter σ exceeds the so-called growth index $\sigma_0 > 0$ of the original function $f(\tau)$. The Laplace image $F(\Omega)$, as a function of the complex variable $\Omega = \omega + i\gamma$, is defined and analytic in the domain $\text{Im } \Omega = \gamma > \sigma$ of the plane $\omega O\gamma$. Second, in many interesting cases, two points $\Omega = \pm k$ happen to be branchpoints of the function $F(\Omega)$ (see, e.g., [1, 2] for details); as we will show below, in our case this rule remains valid. Third, in order to use the theorem about residues, we should prolong the integration contour into the domain $\text{Im } \Omega < \sigma$, harboring all the poles of the function $F(\Omega)$ and keeping in mind that the branchpoints have to remain the external ones. We use the contour presented on Fig. 1, the radius of the arc being $R = \sqrt{A^2 + \sigma^2}$.

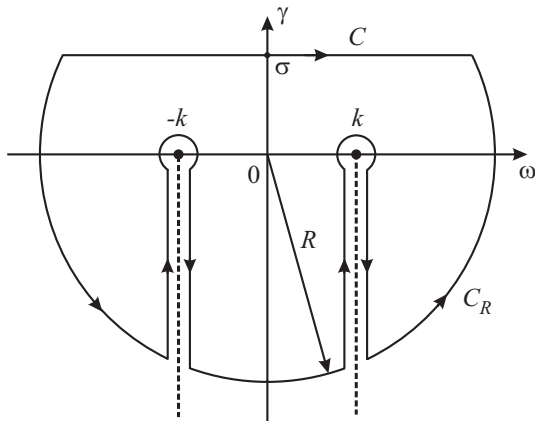

FIG. 1: Integration contour C_R for the inverse Laplace transformation of the electromagnetic field strength. The radius $R = \sqrt{A^2 + \sigma^2}$ tends to infinity, providing that all the poles of the function $\mathcal{F}_{ik}(\Omega, k_\gamma)$ are inside. The branchpoints $\Omega = \pm k$ are excluded by using cuts along the lines $\omega = \pm k$, $\gamma = ky$, $-\infty < y < 0$, and infinitely small circles harboring the branchpoints.

In order to apply the residues theorem to the calculation of the function $F_{ik}(\tau, x^\alpha)$ we should fix one of the analytic continuations of the function $\mathcal{F}_{ik}(\Omega, k_\alpha)$ into the domain $\text{Im } \Omega < \sigma$. Thus, the function $\mathcal{F}_{ik}(\tau, x^\alpha)$ contains contributions of two types: first, the residues in the poles of the function $\mathcal{F}_{ik}(\Omega, k_\gamma)$; second, the integrals along the cuts $\omega = \pm k$, $\gamma = ky$, $-\infty < y \leq 0$. The contribution of the second type displays the dependence on time in the form $\exp(ik\tau)$, and looks like the packet

of waves propagating with the phase velocity $V_{\text{ph}} = c = 1$. In order to describe the contributions of the first type, below we study in detail the solutions to the dispersion relations for the longitudinal and transversal waves in plasma. Providing the mentioned analytic continuation of the function $\mathcal{F}_{ik}(\Omega, k_\gamma)$ into the domain $\text{Im } \Omega < \sigma$, we need to take special attention to the analytic properties of the permittivity scalar ε_{\parallel} (see (65)), which is one of the structural elements of the longitudinal electric field. The discussion of this problem started in [34] and led to the appearance in the scientific lexicon of the term Landau damping [1–4], based on the prediction made in [35]. The results of this discussion briefly can be formulated as follows (we assume here that the growth index vanishes, i.e., $\sigma = 0$). The most important part of the integral (65) is the integration with respect to the longitudinal velocity $v_{\parallel} = \frac{k_\alpha q^\alpha}{kq}$, which can be written as $\int_{-1}^{+1} \frac{dv_{\parallel} Z(v_{\parallel})}{(v_{\parallel} - \frac{\Omega}{k})}$. When $\text{Im } \Omega = \gamma = 0$, this real integral diverges at $\omega < k$, and the function ε_{\parallel} is not defined. When $\gamma \neq 0$, this integral can be rewritten as a contour integral with respect to complex velocity $v_{\parallel} = x + iy$. Since in the domain $\gamma > 0$ the function should be analytic, and the pole $v_{\parallel} = \frac{\Omega}{k}$ can appear in the lower semi-plane $\gamma < 0$ only, we recover (in our terminology) the classical Landau's statement about resonant damping of the longitudinal waves in plasma, which can take place if the plasma particles co-move with the plasma wave and extract the energy from the plasma wave [35].

IV. ANALYSIS OF THE DISPERSION RELATIONS. I. LONGITUDINAL WAVES

A. Dispersion equation for the ultrarelativistic plasma

Below we consider the background state of the ultrarelativistic plasma to be described by the distribution functions

$$f_{(a)}^{(0)}(q) = \frac{N_{(a)}}{8\pi T_{(a)}^3} e^{-\frac{q}{T_{(a)}}}, \quad (76)$$

where the temperatures for all sorts of particles should coincide if the background state was the equilibrium one. We are interested in the analysis of the solutions $\Omega(k_\alpha, \nu) = \omega + i\gamma$ of the dispersion relations for longitudinal (70) and transversal (74) waves. More precisely, we focus on the classification of the roots of (70) and (74) and search for nonstandard solutions which appear just due to nonminimal interactions and axion-photon couplings. A number of facts, which we discuss below, are well-known in the context of relativistic plasma-wave theory; nevertheless, we prefer to restate them in order to explain properly new results, which appear in the axionically active plasma nonminimally coupled to gravity. We have to stress that in the model under consideration the results of integration are presented in an explicit form,

and the analytic continuation of all the necessary functions also is made explicitly.

Since the background state of plasma is spatially isotropic, one can choose the OZ axis along the wave vector, i.e., without loss of generality one can put

$$k_\alpha = (0, 0, -k), \quad q_\alpha = q (\cos \varphi \sin \theta, \sin \varphi \sin \theta, \cos \theta). \quad (77)$$

Then the longitudinal permittivity scalar (65) can be reduced to the following term:

$$\varepsilon_{||} = 1 - \frac{3W^2}{k^2} Q_1(z), \quad (78)$$

where $t = \cos \theta$, $z \equiv \Omega/k$, the term

$$W^2 = \frac{4\pi}{3} \sum_{(a)} \frac{e_{(a)}^2 N_{(a)}}{T_{(a)}} \quad (79)$$

is usually associated with the square of the plasma frequency in the ultrarelativistic approximation [1], and, finally, the Legendre function of the second kind $Q_1(z)$ is given by the integral (see, e.g., [36, 37])

$$Q_1(z) = \frac{1}{2} \int_{-1}^1 \frac{t dt}{z-t} = \operatorname{Re} Q_1(z) + i \operatorname{Im} Q_1(z), \quad (80)$$

with

$$\begin{aligned} \operatorname{Re} Q_1(z) &= -1 + \frac{x}{4} \log \left[\frac{(x+1)^2 + y^2}{(x-1)^2 + y^2} \right] - \\ &\quad - \frac{y}{2} \left[\arctan \frac{x-1}{y} - \arctan \frac{x+1}{y} \right], \end{aligned} \quad (81)$$

$$\begin{aligned} \operatorname{Im} Q_1(z) &= \frac{y}{4} \log \left[\frac{(x+1)^2 + y^2}{(x-1)^2 + y^2} \right] + \\ &\quad + \frac{x}{2} \left[\arctan \frac{x-1}{y} - \arctan \frac{x+1}{y} \right]. \end{aligned} \quad (82)$$

We treat the quantity $z = \frac{\Omega}{k}$ as a new complex variable $z = x + iy$, where $x = \frac{\omega}{k}$ and $y = \frac{\gamma}{k}$. In terms of the complex variable z this function looks more attractive

$$Q_1(z) = \frac{1}{2} z \ln \left(\frac{z+1}{z-1} \right) - 1, \quad Q_1(0) = -1, \quad (83)$$

nevertheless, one should, as usual, clarify analytical properties of this function. Clearly, the points $z = \pm 1$ are the logarithmic branchpoints of the function $Q_1(z)$; in these two points the real part of the Legendre function does not exist. When we cross the line $\operatorname{Im} z = 0$ on the fragment $|\operatorname{Re} z| < 1$ of the real axis, the function $\operatorname{Im} Q_1(z)$ experiences the jump, since

$$\begin{aligned} \lim_{y \rightarrow 0+0} \{\operatorname{Im} Q_1\} &= -x \frac{\pi}{2}, \\ \lim_{y \rightarrow 0-0} \{\operatorname{Im} Q_1\} &= +x \frac{\pi}{2}, \quad |x| < 1. \end{aligned} \quad (84)$$

When $|x| > 1$, the function $\operatorname{Im} Q_1(z)$ is continuous. In order to obtain analytical function $\varepsilon_{||}(z)$ we consider the function $Q_1(z)$ to be defined in the domain $\operatorname{Im} z > 0$ and make the analytical extension to the domain $\operatorname{Im} z < 0$ as follows:

$$\begin{aligned} Q_1(z) \rightarrow G_{||}(z) &\equiv \frac{1}{2} \int_{-1}^1 \frac{t dt}{z-t} - \\ &\quad - i\pi z \Theta(-\operatorname{Im} z) \Theta(1 - |\operatorname{Re} z|). \end{aligned} \quad (85)$$

Here Θ denotes the Heaviside step function. Let us mention that the function $G_{||}(z)$ is analytic everywhere except the lines $z = \pm 1 + iy$ with $-\infty < y \leq 0$. In fact, to obtain the analytic continuation, we added the residue $(-i\pi z)$ in the singular point $t=z$ into the Legendre function. The same result can be obtained if one deforms the integration contour in (80) so that this contour lies below the singular point $t = z$ and harbors it; in the last case we would repeat the method applied by Landau in [35].

Let us note that the function $G_{||}(z)$ possesses the symmetry

$$\overline{G_{||}(z)} = G_{||}(-\bar{z}), \quad (86)$$

i.e., it keeps the form with the transformation $z \rightarrow -\bar{z}$, which is equivalent to $\omega \rightarrow -\omega$. Keeping in mind this fact, below we consider ω to be nonnegative without loss of generality.

Now the function

$$\varepsilon_{||} = 1 - \frac{3W^2}{k^2} G_{||}(z) \quad (87)$$

is defined and is analytical on the complex plane z everywhere except the branchpoints $z = \pm 1$. The corresponding dispersion relation for longitudinal plasma waves can be written as follows:

$$\frac{k^2(1 + 2K_1)}{3W^2} = G_{||}(z). \quad (88)$$

When $K_1=0$, this equation gives the well-known results (see, e.g., [1]). When $K_1 \neq 0$, the results are obtained in [38] for three different cases: $1 + 2K_1 > 0$, $1 + 2K_1 < 0$ and $1 + 2K_1 = 0$. We recover these results only to demonstrate the method, which we use below for the dispersion equations containing the axionic factor $\nu \neq 0$. Since the left-hand side of Eq.(88) is real, we require that

$$\frac{k^2(1 + 2K_1)}{3W^2} = \operatorname{Re}\{G_{||}(z)\}, \quad \operatorname{Im}\{G_{||}(z)\}=0, \quad (89)$$

or in more detail

$$\frac{x}{4} \log \left[\frac{(x+1)^2 + y^2}{(x-1)^2 + y^2} \right] - \frac{y}{2} \left[\arctan \frac{x-1}{y} - \arctan \frac{x+1}{y} \right] + \pi y \Theta(-y) \Theta(1-|x|) = \mu, \quad (90)$$

$$\frac{y}{4} \log \left[\frac{(x+1)^2 + y^2}{(x-1)^2 + y^2} \right] + \frac{x}{2} \left[\arctan \frac{x-1}{y} - \arctan \frac{x+1}{y} \right] - \pi x \Theta(-y) \Theta(1-|x|) = 0, \quad (91)$$

where we introduced the auxiliary parameter μ

$$\mu \equiv 1 + \frac{k^2(1+2K_1)}{3W^2}, \quad (92)$$

which is the function of k . There are two explicit solutions to these equations.

B. Solutions with $x = 0$

When $x = \frac{\omega}{k} = 0$, the equation (91) is satisfied identically, and we can assume that either the frequency vanishes $\omega = 0$, or the wavelength becomes infinitely small, $k = \infty$. The equation (90) can be written now as

$$\mu = y \left(\arctan \frac{1}{y} + \pi \Theta(-y) \right) \Leftrightarrow \operatorname{arccot} y = \frac{\mu}{y}. \quad (93)$$

Clearly, when $\mu > 1$ (or equivalently, $1+2K_1 > 0$) there are no solutions to this equation. When $1+2K_1 < 0$, i.e., $\mu < 1$, one solution $y = y^*$ to the equation (93) appears: it is positive if $k^2 < \frac{3W^2}{|1+2K_1|}$ and negative for $k^2 > \frac{3W^2}{|1+2K_1|}$. In the intermediate case $\mu = 1$, i.e., when $1+2K_1 = 0$, we obtain formally the solution $y = \infty$, which we omit as nonphysical.

C. Solutions with $y = 0$ and $|x| > 1$

When $y = 0$, we deal with waves propagating without damping/increasing, since $\gamma = 0$. The frequency ω can be now found from the equation

$$\mu = \frac{\omega}{2k} \log \left(\frac{\omega + k}{\omega - k} \right). \quad (94)$$

In terms of x and μ introduced in (92) this equation can be rewritten as $\frac{1}{x} = \tanh \frac{\mu}{x}$, thus we obtain the following results.

First, there are no solutions, when $\mu \leq 1$, i.e., when $1+2K_1 \leq 0$. Second, there are one positive and one negative roots ($x = \pm x^*$), when $\mu > 1$, i.e., when $1+2K_1$ is positive.

To estimate the interval of frequencies, which are allowed by the equation (94), one can use two decompositions for the Legendre function in the case, when $y = 0$

and $x > 1$:

$$\begin{aligned} Q_1(x) &= -1 + \frac{x}{2} \log \left(\frac{x+1}{x-1} \right) = \sum_{n=1}^{\infty} \frac{x^{-2n}}{2n+1} = \\ &= \frac{1}{3x^2} + \frac{1}{5x^4} + \dots, \end{aligned} \quad (95)$$

$$(x^2 - 1)Q_1(x) = \frac{1}{3} - 2 \sum_{n=1}^{\infty} \frac{x^{-2n}}{(2n+1)(2n+3)}. \quad (96)$$

This means that $\frac{1}{3x^2} < Q_1(x) < \frac{1}{3(x^2-1)}$ and thus, taking into account that $Q_1(x) = \frac{k^2}{3W_{\text{NM}}^2}$ (see (88)), we obtain the inequality $W_{\text{NM}} < \omega < \sqrt{W_{\text{NM}}^2 + k^2}$. In particular, when $k \ll \omega$, one obtains from (94)

$$\omega^2 \simeq W_{\text{NM}}^2 + \frac{3}{5}k^2, \quad (97)$$

and this result is well-known at $K_1 = 0$ (see, e.g., [1, 3]). Here and below we use the convenient parameter $W_{\text{NM}} \equiv \frac{W}{\sqrt{|1+2K_1|}}$. The plots of the functions $\omega(k)$, $V_{\text{ph}}(k)$ and $V_{\text{gr}}(k)$ are presented on Fig. 2.

Let us remark, that depending on the value of the wave parameter k two types of longitudinal waves in the relativistic plasma can exist (see, e.g., [1]). The waves of the first type propagate without damping ($\gamma = 0$) and with the phase velocity exceeding speed of light in vacuum $V_{\text{ph}}(k) > 1$; for instance, the well-known Langmuir waves are described by the dispersion relation $\omega^2 = \omega_{(p)}^2 + k^2 V_{(s)}^2$, thus, $V_{\text{ph}}(k) > 1$, when $k < \frac{\omega_{(p)}}{\sqrt{1-V_{(s)}^2}}$ (here $\omega_{(p)}$ is

the Langmuir plasma frequency, and $V_{(s)}$ is the reduced sound velocity). The longitudinal plasma waves of the second type are characterized by $\gamma < 0$ and $V_{\text{ph}} < 1$, thus displaying the well-known Landau damping phenomenon. However, in the ultrarelativistic limit, as it was shown in [1], the plasma waves of the second type are suppressed, and only the waves of the first type exist. In fact, we have shown here that the account for a non-minimal coupling of the electromagnetic field to gravity does not change this result for ultrarelativistic case, if $1+2K_1 > 0$. In the case, when $1+2K_1 \leq 0$, i.e., when the curvature induced effects are not negligible, the longitudinal waves of the first type in the ultrarelativistic plasma are also suppressed, i.e., no longitudinal waves in the ultrarelativistic plasma can be generated, whatever the value of k is chosen, if $1+2K_1 \leq 0$.

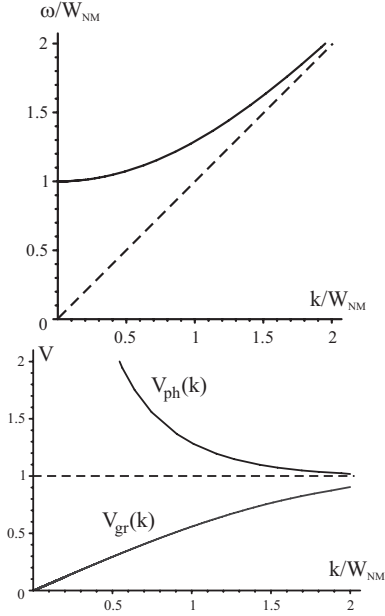

FIG. 2: The plots of functions $\omega(k)$, $V_{\text{ph}}(k)$ and $V_{\text{gr}}(k)$ for running longitudinal waves in the ultrarelativistic plasma in the case, when $1+2K_1 > 0$. The phase velocity exceeds the speed of light in vacuum, $V_{\text{ph}}(k) > 1$, while the group velocity is less than one, $V_{\text{gr}}(k) < 1$ for arbitrary k .

D. About solutions with $y \neq 0$ and $x \neq 0$

The question arises, whether the longitudinal wave exists for which both x and y are nonvanishing? In order to answer this question let us transform the pair of equations (90), (91) into

$$\mu = \frac{(x^2 + y^2)}{4x} \log \left[\frac{(x+1)^2 + y^2}{(x-1)^2 + y^2} \right], \quad (98)$$

$$\frac{2\mu y}{(x^2 + y^2)} + \left[\arctan \frac{x-1}{y} - \arctan \frac{x+1}{y} \right] - 2\pi\Theta(-y)\Theta(1-|x|) = 0, \quad (99)$$

assuming that $y \neq 0$ and $x \neq 0$. Since the expression in the right-hand side of (98) is positive, we should consider the situations with $\mu > 0$ only. We have to distinguish two important cases.

1. $y < 0$ and $x^2 < 1$

In this case the equation (99) takes the form

$$\frac{2\mu|y|}{x^2 + y^2} + \left[2\pi + \arctan \frac{x-1}{|y|} - \arctan \frac{x+1}{|y|} \right] = 0. \quad (100)$$

Since the function $\arctan U$ satisfies the condition $|\arctan U| \leq \frac{\pi}{2}$, both the first term and the term in brackets are positive, thus guaranteeing that this equation has no roots in this case.

2. $y > 0$ or/and $x^2 > 1$

In this case we return to the Legendre function and transform its imaginary part as follows

$$\begin{aligned} \text{Im } Q_1(z) &= \frac{1}{2i} (Q_1(z) - Q_1(\bar{z})) = \\ &= \frac{1}{4i} \int_{-1}^1 \frac{(\bar{z} - z) t dt}{|z - t|^2} = -\frac{1}{2} y \int_{-1}^1 \frac{t dt}{|z - t|^2} = \\ &= -\frac{1}{4} y \int_{-1}^1 t dt \left(\frac{1}{|z - t|^2} - \frac{1}{|z + t|^2} \right) = \\ &= -xy \int_{-1}^1 \frac{t^2 dt}{|z^2 - t^2|^2}. \end{aligned} \quad (101)$$

Clearly, the integral in (101) is a positive quantity, thus, $\text{Im } Q_1(z) = 0$ if and only if $x \cdot y = 0$. In other words, there are no solutions of the dispersion relation under discussion, when both x and y are nonvanishing.

V. ANALYSIS OF THE DISPERSION RELATIONS. II. TRANSVERSAL WAVES

A. Dispersion equation

In analogy with the longitudinal permittivity scalar, the transversal one can be written in terms of reduced frequency $z = \frac{(\omega + i\gamma)}{k}$, of the wave three-vector modulus k and the quantity W (see (79)) only:

$$\varepsilon_{\perp} = -\frac{3W^2}{2z^2 k^2} G_{\perp}(z), \quad (102)$$

where

$$G_{\perp}(z) = [1 - (z^2 - 1)G_{\parallel}(z)], \quad G_{\perp}(0) = 0. \quad (103)$$

Here we used the definition (64) of the scalar ε_{\perp} and the formulas (62)-(65). The function $G_{\perp}(z)$ also possesses the property

$$\overline{G_{\perp}(z)} = G_{\perp}(-\bar{z}), \quad (104)$$

and is analytic with respect to complex variable z anywhere except the lines $z = \pm 1 + iy$ with $-\infty < y \leq 0$. In these terms the dispersion relation for transversal waves in ultrarelativistic plasma takes the form

$$k^2(z^2 - 1) + kp - \frac{3}{2}W_{\text{NM}}^2 G_{\perp}(z) \text{sgn}(1 + 2K_1) = 0, \quad (105)$$

where the real parameter

$$p = \mp \nu \frac{(1 + 2K_2)}{(1 + 2K_1)} \quad (106)$$

appears if and only if the axion field is nonstationary. Since $G_{\perp}(0)=0$, the solution $z=0$ exists, when $k=p \geq 0$. Depending on the value of the parameter $(1+2K_1)$ one obtains three particular cases.

B. The first case: $1 + 2K_1 > 0$ and $x^2 > 1$ or/and $y > 0$

First, we consider the imaginary part of the equality (105) along the line the analysis for the longitudinal case. When $\mathbf{G}_{\parallel}(z) = \mathbf{Q}_1(z)$, i.e. when either $\Theta(-y) = 0$ or $\Theta(1 - |x|) = 0$, we can show explicitly that

$$\begin{aligned} & \text{Im}\{k^2(z^2 - 1) + kp - \frac{3}{2}W_{\text{NM}}^2\mathbf{G}_{\perp}(z)\} = \\ & = x \cdot y \left\{ 2k^2 + \frac{3W_{\text{NM}}^2}{2} \int_{-1}^1 \frac{t^2(1-t^2) dt}{|z^2 - t^2|^2} \right\}. \end{aligned} \quad (107)$$

Clearly, this expression can be equal to zero if and only if $x = 0$ or $y = 0$.

1. *On the solutions with $y = 0$ and $x > 1$*

When $y = 0$ the dispersion relation gives

$$k = \frac{-p \pm \sqrt{p^2 + 6W_{\text{NM}}^2(x^2 - 1)\mathbf{G}_{\perp}(x)}}{2(x^2 - 1)}, \quad (108)$$

where the function $\mathbf{G}_{\perp}(x)$ can be written as

$$\mathbf{G}_{\perp}(x) = x^2 \left[1 - \frac{(x^2 - 1)}{2x} \log \left(\frac{x+1}{x-1} \right) \right]. \quad (109)$$

For this function the following decompositions can be found:

$$\mathbf{G}_{\perp}(x) = 1 - (x^2 - 1)\mathbf{Q}_1(x) = 2 \sum_{n=0}^{\infty} \frac{x^{-2n}}{(2n+1)(2n+3)}, \quad (110)$$

$$(x^2 - 1)\mathbf{G}_{\perp}(x) = \frac{2x^2}{3} - 8 \sum_{n=0}^{\infty} \frac{x^{-2n}}{(2n+1)(2n+3)(2n+5)}, \quad (111)$$

from which one can see that $\mathbf{G}_{\perp}(1) = 1$ and $\mathbf{G}_{\perp}(\infty) = \frac{2}{3}$. Being monotonic, the function $\mathbf{G}_{\perp}(x)$ is restricted by the inequalities $\frac{2}{3} < \mathbf{G}_{\perp}(x) < 1$, when $x > 1$. This means that the square roots in equations (108) is real, the right-hand side is positive for arbitrary p , if we use only the root with plus sign in front of the square root. Thus, the equation (108) (with the plus sign in front of the square root) has real solutions $\Omega = \omega(k)$, which describe transversal oscillations without damping/increasing and phase velocity exceeding the speed of light in vacuum. When p is nonpositive, these oscillations have arbitrary wavelength $0 < \frac{1}{k} < \infty$. When p is positive, k cannot exceed some critical value $k_{\text{crit}} \equiv \frac{3W_{\text{NM}}^2}{2p}$, which can be obtained from the following estimation:

$$\begin{aligned} k & = \frac{3W_{\text{NM}}^2\mathbf{G}_{\perp}(x)}{p + \sqrt{p^2 + 6W_{\text{NM}}^2(x^2 - 1)\mathbf{G}_{\perp}(x)}} \\ & < \frac{3W_{\text{NM}}^2\mathbf{G}_{\perp}(x)}{2p} < \frac{3W_{\text{NM}}^2}{2p}. \end{aligned} \quad (112)$$

In the approximation of long waves, i.e., when $k \rightarrow 0$, we obtain

$$\omega^2(k) \simeq W_{\text{NM}}^2 - pk + \frac{6}{5}k^2 + \frac{p}{5W_{\text{NM}}^2}k^3. \quad (113)$$

For short waves ($k \rightarrow \infty$) and $p \leq 0$ the square of the frequency reads

$$\omega^2(k) \simeq k^2 - pk + \frac{3}{2}W_{\text{NM}}^2. \quad (114)$$

In Fig. 3 and Fig. 4 we presented the results of numerical calculations: we have chosen four values of the parameter p for illustration of the dependence $\omega(k)$, and eight values of p for illustration of the behavior of the functions $V_{\text{ph}}(k)$ and $V_{\text{gr}}(k)$.

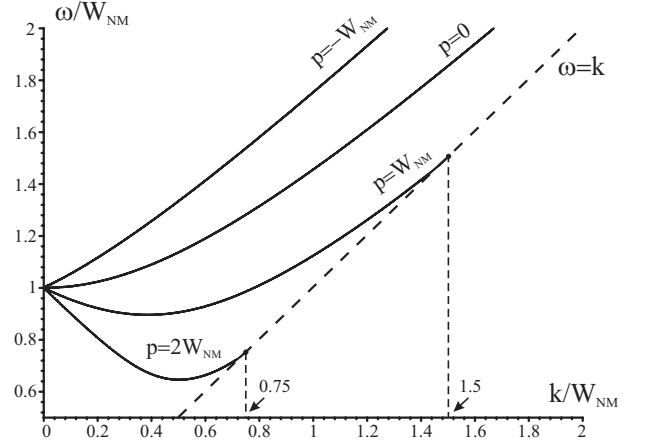

FIG. 3: Plots of the dispersion function $\omega(k)$ for running transversal waves with $\gamma=0$ and $\omega > k$ at $1+2K_1 > 0$. When $p > 0$ the lines $\omega=\omega(k)$ stop on the bisector line $\omega=k$ at $k = k_{\text{crit}} = \frac{3W_{\text{NM}}^2}{2p}$, and cannot be prolonged for $k > k_{\text{crit}}$. For negative values of p the curves do not cross and do not touch the bisector $\omega=k$ at $k \rightarrow \infty$; when $p=0$, the bisector is the asymptote for the corresponding curve.

Let us remark that, when the parameter p is negative, there exists some critical value of its modulus $|p| = p_{\text{crit}}$, which distinguishes two principally different situations: when $|p| < p_{\text{crit}}$, the group velocity does not exceed the speed of light in vacuum $V_{\text{gr}} < 1$; when $|p| > p_{\text{crit}}$, we obtain $V_{\text{gr}} > 1$ for arbitrary k . This critical behavior of the function $V_{\text{gr}}(k)$ can be easily illustrated for the case of short waves (see (114)). Indeed, in this case we obtain

$$V_{\text{gr}} = \frac{d\omega}{dk} \simeq \left[1 + \frac{(6W_{\text{NM}}^2 - |p|^2)}{(2k + |p|)^2} \right]^{-\frac{1}{2}}, \quad (115)$$

and, clearly, $p_{\text{crit}} = \sqrt{6}W_{\text{NM}}$. Another interesting feature is that the function $V_{\text{gr}}(k)$ can take negative values for some values of the parameter p . When we think about both results: first, that $V_{\text{gr}}(k)$ is negative for some p , and that $V_{\text{gr}}(k)$ can exceed the speed of light in vacuum, $V_{\text{gr}} > 1$, we recall the theory of magneto-active plasma, which

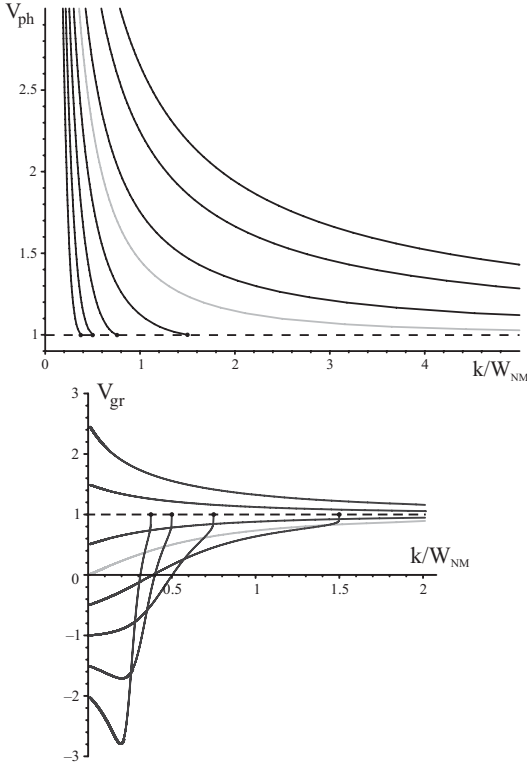

FIG. 4: Plots of the phase and group velocities for running transversal waves with $\gamma=0$ and $\omega > k$ at $1+2K_1 > 0$. When $p > 0$, both V_{ph} and V_{gr} become equal to the speed of light in vacuum at $k = k_{crit} = \frac{3W_{NM}^2}{2p}$; the solutions of the dispersion equation do not exist for $k > k_{crit}$. When $p=0$ (light grey curves), the straight line $V=1$ is the horizontal asymptote for curves describing both phase and group velocities at $k \rightarrow \infty$. When p is negative, and $|p| < p_{crit}$, one sees that $V_{gr}(k) < 1$ for arbitrary k ; when $p < 0$ and $|p| > p_{crit}$, the group velocity exceeds the speed of light in vacuum $V_{gr} > 1$.

demonstrates such behavior for the waves of special type (see, e.g., [39]). It can be considered as a supplementary motif to use the term axionically active plasma by the analogy with the term magneto-active plasma.

2. On the solutions with $x = 0$ and $y > 0$

When $x = 0$ and $y > 0$, the solution to the dispersion equation is

$$k = \frac{p \pm \sqrt{p^2 - 6W_{NM}^2(y^2 + 1)G_{\perp}(iy)}}{2(y^2 + 1)}, \quad (116)$$

where

$$G_{\perp}(iy) = y^2 \left[\frac{(y^2 + 1)}{y} \arctan \frac{1}{y} - 1 \right]. \quad (117)$$

For positive values of the variable y the function $G_{\perp}(iy)$ is nonnegative ($G_{\perp}(0_{+0}) = 0$, $G_{\perp}(+i\infty) = 2/3$). This means that, first, at $p = 0$ there are no solutions to (116);

second, at $p \neq 0$ the corresponding solutions exist, for which $p^2 \geq 6W_{NM}^2(y^2 + 1)G_{\perp}(iy)$; third, when $p > 0$ one can use both signs, plus and minus, in (116); fourth, when $p < 0$, there are no solutions, since k should be positive. Let us stress the following feature: since $G_{\perp}(iy) > 0$ we obtain from (116) the inequality $k < p$ for solutions with $x = 0$ and $y > 0$. To conclude, the nonharmonically increasing perturbations exist ($\Omega = i\gamma$ with $\gamma > 0$) only in case, when $p > k$.

C. The second case: $1 + 2K_1 > 0$ and $x^2 < 1$, $y < 0$

When $y < 0$ and $|x| < 1$, we divide the equation (105) by the quantity $(z^2 - 1)$ and transform the imaginary part of obtained relation into

$$\left(kp - \frac{3W_{NM}^2}{2} \right) \frac{2x|y|}{|z^2 - 1|^2} + \frac{3W_{NM}^2}{2} [\text{Im } Q_1(z) - \pi x] = 0. \quad (118)$$

Keeping in mind the properties of the function $\text{Im } Q_1(z)$, which we studied for the case of longitudinal waves, one can state that, when $p \leq \frac{3W_{NM}^2}{2k}$, the left-hand side of the equation (118) is nonpositive, and thus there is only one root of this equation, namely, $x = 0$. This case can be considered qualitatively. When $p > \frac{3W_{NM}^2}{2k}$, we will study solutions numerically.

1. The case $x = 0$ and $y < 0$

Now the dispersion equation yields

$$k = \frac{p \pm \sqrt{p^2 + 6W_{NM}^2(|y|^2 + 1) [-G_{\perp}(-i|y|)]}}{2(|y|^2 + 1)}, \quad (119)$$

where the function

$$[-G_{\perp}(-i|y|)] = |y|^2 \left[1 + \frac{(|y|^2 + 1)}{|y|} \left(\pi - \arctan \frac{1}{|y|} \right) \right] \quad (120)$$

is positively defined. Again, we should eliminate the sign minus in front of the square root in (119) since $k > 0$. Thus, for arbitrary p and $k > 0$ there are solutions $\Omega = i\gamma$ with negative γ , which describe damping transversal nonharmonic perturbations in plasma.

Two asymptotic decompositions attract an attention

$$\gamma(k) = \frac{4p}{3\pi W_{NM}^2} k^2 + \dots, \quad k \ll W_{NM}, \quad (121)$$

and

$$\gamma(k) = -\frac{2}{3\pi W_{NM}^2} k^3 + \dots, \quad k \gg W_{NM}. \quad (122)$$

In Fig. 5 we illustrate the dependence $\gamma(k)$ for ten values of the parameter p ; we put together the plots illustrating the solutions discussed in two paragraphs: for $x=0$, $y > 0$ and for $x=0$, $y < 0$.

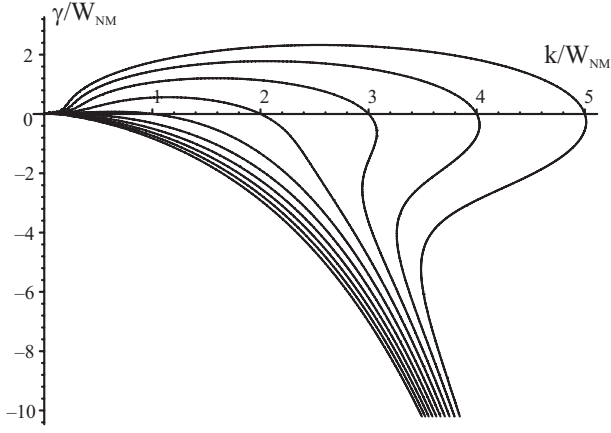

FIG. 5: Plots of the function $\gamma(k)$ for various values of the parameter p . Ten curves (indicated from the left to the right) correspond to the values $-4, -3, \dots, 4, 5$ of the reduced parameter $\frac{p}{W_{NM}}$. Depending on the chosen value of the parameter $k=k_0$, one can find one, two or three solutions $\gamma(k_0)$.

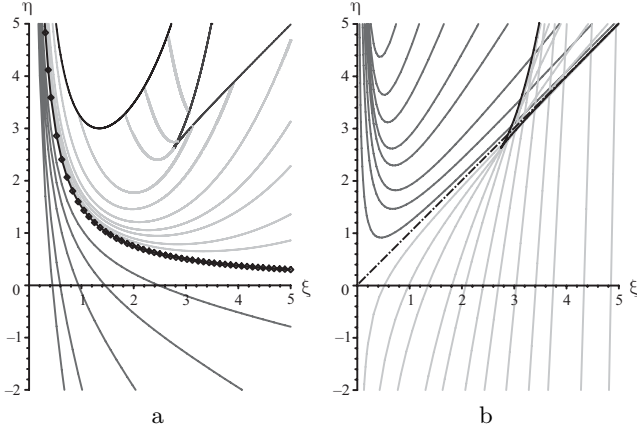

FIG. 6: The curves $p = p(k)$ reconstructed using parametric equations (123) and (124). On the left panel we illustrate solutions of the dispersion equation for the transversal waves with $\text{Re } z > 1$ and $\text{Im } z = 0$ (dark grey infinite lines), and the solutions with $0 < \text{Re } z < 1$ and $\text{Im } z < 0$ (light grey finite lines). On the right panel we display the family of lines related to the solutions with $\text{Re } z = 0$ and $\text{Im } z > 0$ (dark grey), and to the solutions with $\text{Re } z = 0$ and $\text{Im } z < 0$ (light grey). The curves on the left panel visualize three separatrices; the curves on the right panel add one new separatrix; all these distinguished curves divide the plane $p0k$ into seven domains, as it is shown on Fig. 7.

2. The case $x \neq 0$ and $y \neq 0$

We indicate the solutions of the dispersion equations, for which neither $\text{Re } z$, nor $\text{Im } z$ vanishes, as nontrivial solutions, and study them numerically. For this purpose we introduce the dimensionless real quantities $\xi = \frac{k}{W_{NM}}$,

$\eta = \frac{p}{W_{NM}}$ and link them by two parametric equations

$$\xi^2 = \frac{3}{2} \frac{\text{Im } G_{\perp}(z)}{\text{Im } z^2}, \quad (123)$$

$$\xi \eta = \frac{3}{2} \frac{\text{Im} [G_{\perp}(z)(z^2 - 1)^{-1}]}{\text{Im} [(z^2 - 1)^{-1}]}. \quad (124)$$

We use the following scheme of analysis. We are interested, finally, in the determination of the functions $\omega = \omega(k, p)$ and $\gamma = \gamma(k, p)$; however, we start with the numerical and qualitative analysis of the inverse functions $k = k(x, y)$ and $p = p(x, y)$. In other words, first of all, we find the domains on the plane of the parameters ξ and η , in which the corresponding solutions exist.

In order to illustrate this scheme let us consider auxiliary plots on Fig. 6. On Fig. 6a one can find the lines of two types: first, infinite lines, which relate to solutions with $\text{Re } z > 1$ and $\text{Im } z = 0$; second, finite lines, which correspond to the solutions with $0 < \text{Re } z < 1$ and $\text{Im } z < 0$. The family of infinite lines visualizes the separatrix in the form of hyperbola. The family of finite lines visualizes two curves on which these lines start or finish. In Fig. 6b one can find infinite lines of two types. First, we see the family of lines, for which $\text{Re } z = 0$ and $\text{Im } z > 0$; they visualize the separatrix in the form of straight line. The second family of lines relates to the solutions with $\text{Re } z = 0$ and $\text{Im } z < 0$; they visualize an envelope line with extreme point.

We collected the results of numerical analysis on Fig. 7. There are seven domains on the plane $\eta0\xi$, the corresponding separatrices appeared as follows.

(c1) The line indicated as (a) is the bisector $\xi = \eta$, and the appearance of this formula can be explained as follows. On the one hand, it relates to the straight-line separatrix found by numerical calculations; on the other hand, it corresponds to the special solution $z = 0$, which appears if $k = p > 0$. In addition to the static solution $\omega = \gamma = 0$, in the points belonging to the bisector $p = k$ we obtain the running waves with $\omega > k$, $\gamma = 0$, when the wave number k satisfies the inequality $k < \sqrt{\frac{3}{2}} W_{NM}$.

(c2) The line (b) is described by the formula $\xi \eta = \frac{3}{2}$. On the one hand, it relates to the hyperbolic separatrix found numerically; on the other hand it corresponds to the critical case $k = k_{\text{crit}} = \frac{3W_{NM}^2}{2p}$, found analytically. For the points along this separatrix, the solutions $x = 1$ exist, or equivalently, $\omega = k$, $\gamma = 0$; the solutions with $x^2 > 1$ do not exist.

(c3) Keeping in mind that the nontrivial solutions to the dispersion equations with $x \neq 0$ and $y \neq 0$ exist only for $y < 0$ and $|x| < 1$, we associated the numerically found curves, on which the finite lines start or finish, with two limiting lines found analytically (for $x \geq 0$). The first curve of this type, the curve (c), corresponds to the limit

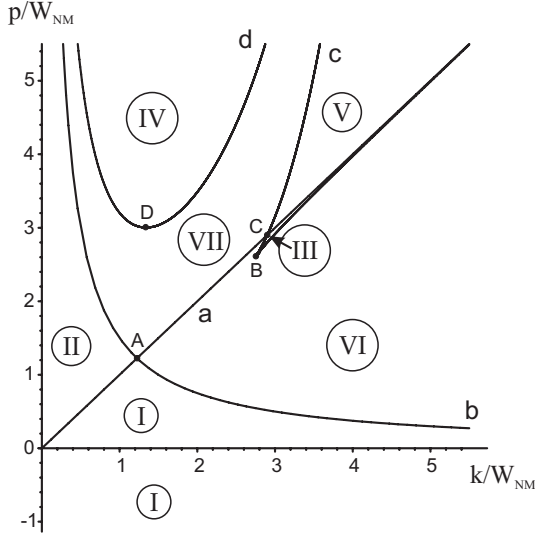

FIG. 7: Arrangement of domains on the plane $p0k$ with specific types of solutions to the dispersion equation (105) at $1 + 2K_1 > 0$. When the axion field is stationary ($\nu=0$), the parameter $p = \mp \nu \frac{(1+2K_2)}{(1+2K_1)}$ is equal to zero. In the domain I the solutions with $\gamma = 0$, $\omega > k$ (running transversal waves), and the solutions with $\omega = 0$, $\gamma < 0$ (damping nonharmonic perturbations) exist. In the domain II there are running waves with $\gamma = 0$, $\omega > k$, and instable perturbations with $\omega = 0$, $\gamma > 0$. In the domains III, IV and V there are nonharmonic perturbations only: in III they are damping ($\gamma < 0$), in IV they are instable ($\gamma > 0$), in V both perturbations can be generated. In the domains VI and VII damping waves with $\omega < k$ and $\gamma < 0$ exist; in addition, there are damping perturbations in VI ($\gamma < 0$) and instable ones in VII ($\gamma > 0$).

$x \rightarrow 0$ and is described parametrically as

$$\begin{aligned} \xi^2 &= \frac{3}{2} \lim_{x \rightarrow 0} \frac{\text{Im } G_{\perp}(z)}{\text{Im } z^2} = \frac{9}{4} \left(1 + \frac{3|y|^2 + 1}{3|y|} \text{arccot}(-|y|) \right), \\ \xi\eta &= \frac{3}{2} \lim_{x \rightarrow 0} \frac{\text{Im} [G_{\perp}(z)(z^2 - 1)^{-1}]}{\text{Im} [(z^2 - 1)^{-1}]} = \\ &= \frac{3}{4} \left(|y|^2 + 3 + \frac{(|y|^2 + 1)^2}{|y|} \text{arccot}(-|y|) \right). \end{aligned} \quad (125)$$

The second curve, the curve (d), relates to the limit $x \rightarrow 1$ and has the following parametric representation:

$$\begin{aligned} \xi^2 &= \frac{3}{2} \lim_{x \rightarrow 1-0} \frac{\text{Im } G_{\perp}(z)}{\text{Im } z^2}, \\ \xi\eta &= \frac{3}{2} \lim_{x \rightarrow 1-0} \frac{\text{Im} [G_{\perp}(z)(z^2 - 1)^{-1}]}{\text{Im} [(z^2 - 1)^{-1}]} \end{aligned} \quad (126)$$

Clearly, in the points of the curve (c) the solutions to the dispersion relations have the form $\omega = 0$, $\gamma < 0$; as for the curve (d), one obtains that $\omega = k$, $\gamma < 0$.

In the cross-points the solutions inherit the properties, which characterize both separatrices.

(p1) The lines (a) and (b) cross in the point A with the coordinates $\eta = \xi = \sqrt{\frac{3}{2}} \simeq 1.225$; in this point $\omega = \gamma = 0$

or $\omega = k = \sqrt{\frac{3}{2}} W_{\text{NM}}$, $\gamma = 0$.

(p2) The lines (a) and (c) cross in the point C with the coordinates $\eta = \xi \simeq 2.899$; in this points there are two solutions: $\omega = \gamma = 0$ and $\omega = 0$, $\gamma = -2.32 W_{\text{NM}}$.

(p3) The extreme point B has the coordinates $\xi \simeq 2.754$, $\eta \simeq 2.613$; for this point there exists a solution with $\omega = 0$, $\gamma = -1.31 W_{\text{NM}}$.

(p4) Finally, the point D, which marks the minimum of the curve (d) has the coordinates $\xi \simeq 1.342$, $\eta \simeq 3.003$; in this point the special solution $\omega = k$, $\gamma = -0.303 W_{\text{NM}}$ exists.

Let us summarize the properties of solutions, which relate to the domains I, II, ..., VII in Fig. 7, using the analysis of the formulas presented above.

- The domain I is characterized by the inequalities $\eta < \xi$ and $\eta < \frac{3}{2\xi}$, or in other terms $p < k$ and $k < k_{\text{crit}} = \frac{3W_{\text{NM}}^2}{2p}$; this domain includes the region $p \leq 0$. In this domain, first, the nontrivial solutions with $x \cdot y \neq 0$ do not exist; second, there are running waves without damping/increasing ($\gamma=0$), which are characterized by the phase velocity exceeding the speed of light in vacuum ($\omega > k$); third, the damping nonharmonic perturbations exist with $\omega=0$ and $\gamma < 0$. The line $\eta=0$, which belongs to this domain, relates to the model without axions ($\nu=0$ and thus $p=0$), and in this sense our results recover the well-known ones.
- The domain II ($\eta > \xi$ and $\eta < \frac{3}{2\xi}$) accumulates solutions with $p > k$ and $k < k_{\text{crit}}$; the corresponding solutions differ from the ones in the domain I by one detail only: the nonharmonic perturbations with $\omega=0$ are instable, since now $\gamma > 0$ (see the discussion below the formula (117)).
- In the domains III, IV and V only nonharmonic perturbations exist: the nontrivial solutions with $x \neq 0$, $y \neq 0$ are absent, the solutions with $x \neq 0$, $y=0$ are not admissible since $k > k_{\text{crit}}$ here. The damping nonharmonic solutions with $\omega=0$ and $\gamma < 0$ are admissible in III and V, the instable solutions with $\gamma > 0$ exist in IV and V.
- Non-trivial solutions with $x \neq 0$, $y \neq 0$ are admissible in the domains VI and VII; here the damping waves exist with $\omega < k$ and $\gamma < 0$. In addition nonharmonic perturbations are admissible, which are damping ($\gamma < 0$) in VI, and increasing ($\gamma > 0$) in VII.

These results are presented shortly in Table I.

Let us attract the attention to the number of symbols + in the corresponding boxes. For instance, there are three symbols + in the box for the domain III with negative γ , two symbols in the domain V, and one plus in the domains I and VI. This means that for one value of the quantity k we obtain one, two or three values of

the decrement of damping $\gamma(k)$. This feature can be explained using Fig. 5: depending on the value of the parameter p the vertical straight line $k=\text{const}$ can cross the curve $\gamma=\gamma(k, p)$ one, two or three times, respectively.

TABLE I: $1 + 2K_1 > 0$

Domain	$\Omega = \omega$ ($\omega > k$)	$\Omega = -i \gamma $	$\Omega = i \gamma $	$\Omega = \omega - i \gamma $ ($\omega < k$)
I	+	+	—	—
II	+	—	+	—
III	—	+++	—	—
IV	—	—	+	—
V	—	++	+	—
VI	—	+	—	+
VII	—	—	+	+

D. The third case: $1 + 2K_1 < 0$

This case can be obtained if we make the formal replacement $W_{\text{NM}}^2 \rightarrow -W_{\text{NM}}^2$ in all formulas obtained in the previous subsection. In particular, the dispersion relation for the transversal waves in plasma has now the form

$$\xi^2(z^2 - 1) + \xi\eta + \frac{3}{2}G_{\perp}(z) = 0. \quad (127)$$

We do not discuss similar details of the corresponding analysis, and present below the results only. Similarly to the case $1+2K_1 > 0$, numerical modeling of the lines $k=k(p)$ displays three separatrices on the plane $\eta O\xi$; they are shown in Fig. 8. The line (a), again, is the bisector $\xi=\eta$. The parametric representation of the line (b') is

$$\begin{aligned} \xi^2 &= \frac{9}{4} \left[\frac{3y^2 + 1}{3y} \operatorname{arccot}(y) - 1 \right], \\ \xi\eta &= \frac{3}{4} \left[\frac{(y^2 + 1)^2}{y} \operatorname{arccot}(y) - y^2 - 3 \right]. \end{aligned} \quad (128)$$

It is obtained using the conditions $x=0$ and $y > 0$ (see (125)). The line (c') is described by the parametric equations

$$\begin{aligned} \xi^2 &= \frac{9}{4} \left[\frac{3x^2 - 1}{6x} \ln \left(\frac{x+1}{x-1} \right) - 1 \right], \\ \xi\eta &= \frac{3}{4} \left[x^2 - 3 - \frac{(x^2 - 1)^2}{2x} \ln \left(\frac{x+1}{x-1} \right) \right], \end{aligned} \quad (129)$$

and is the envelope of the family of curves $p = p(x, y=0)$, $k = k(x, y=0)$, when $x > 1$. The last line (d') is obtained using the conditions $x=1$ and $y > 0$. Contrary to the previous case, the separatrices have neither cross-points,

TABLE II: $1 + 2K_1 < 0$

Domain	$\Omega = \omega$ ($\omega > k$)	$\Omega = -i\gamma$ ($\gamma > 0$)	$\Omega = i\gamma$ ($\gamma > 0$)	$\Omega = \omega + i\gamma$ ($\gamma > 0$)	$\Omega = \omega + i\gamma$ ($\omega > k, \gamma < 0$)
I'	—	+	—	—	—
II'	—	—	+	—	—
III'	—	—	—	+	—
IV'	—	—	—	—	+
V'	+	—	—	—	—

nor extreme points. Thus, in the case of negative constant $1+2K_1$, the plane $\xi O\eta$ is divided into five domains. In the domain I' the solutions to the dispersion equation have vanishing real parts $\omega=0$ and negative imaginary parts $\gamma < 0$; the domain II' is characterized by $\omega=0$ and $\gamma > 0$. In the domain III' there exist instable waves with $\omega < k$ and $\gamma > 0$; the domain IV' contains waves with $\omega > k$ of two types: increasing ($\gamma > 0$) and damping ($\gamma < 0$). The domain V' describes running waves without damping/increasing, $\omega > k, \gamma=0$. We summarize these features in Table II.

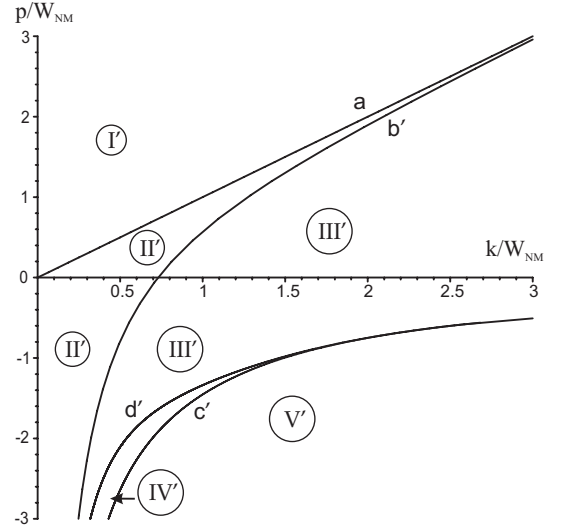

FIG. 8: Arrangement of domains with specific types of solutions to the dispersion equation (105) at $1 + 2K_1 < 0$. In the domains I' and II' all the solutions belong to the class of nonharmonic perturbations with $\omega = 0$; in I' these perturbations are damping ($\gamma < 0$), while in II' they are instable ($\gamma > 0$). The domain III' contains instable waves with $\omega < k$ and $\gamma > 0$; in the domain IV' there exist both damping and instable waves with $\omega > k$. The domain V' contains the solutions for running waves with $\gamma = 0, \omega > k$.

Concerning the principally new result, let us stress, that after the replacement $W_{\text{NM}}^2 \rightarrow -W_{\text{NM}}^2$ in (107) we can see that indeed, in addition to $x=0$ and $y=0$, new solutions can exist with $x \neq 0$ and $y \neq 0$. This means that, when $1+2K_1 < 0$, transversal waves in axionically active plasma can be, first, damping waves with $\omega > k$,

TABLE III: $1 + 2K_1 = 0$

Domain	$\Omega = \omega$ ($\omega > k$)	$\Omega = -i\gamma$ ($\gamma > 0$)	$\Omega = i\gamma$ ($\gamma > 0$)	$\Omega = \omega + i\gamma$ ($\omega < k, \gamma < 0$)
I ₀	—	+	—	—
II ₀	—	—	+	—
III ₀	+	—	—	—
IV ₀	—	—	—	+
V ₀	—	—	—	—

$\gamma < 0$, second, can be unstable ($\gamma > 0$) both for $\omega > k$ and $\omega < k$.

E. The intermediate case $1 + 2K_1 = 0$

To complete our study, let us consider the case $K_1 = -\frac{1}{2}$, for which the dispersion relation reduces to the equation

$$kp_* = \frac{3}{2}W^2 G_{\perp}(z), \quad (130)$$

where $p_* = \mp\nu(1 + 2K_2)$ and W is given by (79). In analogy with the case $1 + 2K_1 > 0$, four separatrices appear on the plane $\xi\eta$ (here $\xi = \frac{k}{W}$, $\eta = \frac{p_*}{W}$). The first separatrix is the hyperbola $\xi\eta = 1$; it corresponds to $G_{\perp}(\infty) = \frac{2}{3}$ (minimal value of the function $G_{\perp}(x)$). The second separatrix $\xi\eta = \frac{2}{3}$ corresponds to $G_{\perp}(1) = 1$ (maximal value of $G_{\perp}(x)$). The third separatrix has the following representation:

$$\xi\eta = 2.3904, \quad (131)$$

where the number 2.3904 is the maximum of the function $\frac{3}{2} \text{Re}\{G_{\perp}(z)\}$ at the condition that $\text{Im}\{G_{\perp}(z)\} = 0$.

Finally, we visualize the straight line $p_* = 0$ as an abscissa on the plane p_*k and the last separatrix. Thus, we obtain five domains on the plane $\xi\eta$ (see Fig. 9). The domain I₀ ($\eta < 0$) is characterized by $\omega = 0$ and $\gamma < 0$; in the domain II₀ ($\xi\eta < 1, p_* > 0$) the solutions of the dispersion equations give $\omega = 0$ and $\gamma > 0$. In the domain III₀ with $1 < \xi\eta < \frac{3}{2}$ we obtain that $\gamma = 0$ and $\omega > k$. The solutions with $\omega < k$ and $\gamma < 0$ can appear in the domain IV₀; in the domain V₀ there are no solutions to the dispersion equation.

These results are summarized in Table III.

VI. DISCUSSION

In the framework of nonminimal Einstein-Maxwell-Vlasov-axion model we analyzed the dispersion relations for the perturbations in an initially isotropic and homogeneous axionically active plasma, which expands in the de Sitter-type cosmological background. In this model

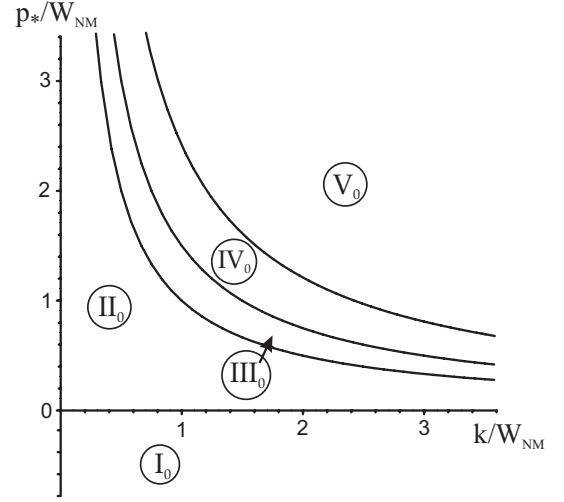

FIG. 9: Arrangement of domains with specific types of solutions to the dispersion equation (105) at $1 + 2K_1 = 0$. Here $p_* = \mp\nu(1 + 2K_2)$ is the modified axionic guiding parameter. In the domain I₀ only solutions with $\gamma < 0$ exist; in the domain II₀ the solutions with $\omega = 0, \gamma > 0$ exist; in the domain III₀ there are running waves with $\omega > k$. The domain IV₀ is characterized by the damping waves with $\omega < k$ and $\gamma < 0$. In the domain V₀ there are no solutions.

we take into account, first, the nonminimal interaction of the electromagnetic field with curvature, second, the nonminimal coupling of the axion field to gravity, and axion-photon coupling in the relativistic plasma. The specific choice of the nonstationary background solution to the total system of equations (de Sitter spacetime with constant curvature, axion field linear in time, vanishing initial macroscopic collective electromagnetic field in the electro-neutral ultrarelativistic plasma) allowed us to obtain and study the dispersion relations in the standard (Ω, \vec{k}) form. We consider these dispersion relations as nonminimal axionic extension of the well-known dispersion relations obtained earlier in the framework of the relativistic Maxwell-Vlasov plasma model.

The presence of the pseudoscalar (axion) field provides the plasma to become a gyrotropic medium, which displays the phenomenon of optical activity. When the plasma in the axionic environment is initially spatially isotropic, its three-dimensional gyration tensor, $\mathcal{G}_{\alpha\beta\gamma}$ is proportional to the three-dimensional Levi-Civita tensor, $\epsilon_{\alpha\beta\gamma}$, thus providing the optical activity to be of the natural type [31]. The proportionality coefficient is the pseudoscalar quantity $p = \mp\nu \frac{(1+2K_2)}{(1+2K_1)}$. The upper sign of this coefficient relates to the circularly polarized wave with left-hand rotation; formally speaking, the sign of p depends on the sign of $\nu = \dot{\phi}$, and on the sign of nonminimal coefficient $\frac{(1+2K_2)}{(1+2K_1)}$. Since $\nu = \dot{\phi}$, this type of optical activity is induced by the pseudoscalar (axion) field; if the axions form the dark matter, the quantity ν is proportional to the square root of the dark matter energy density (see, e.g., [40, 41] for details). When $K_1 \neq 0$ and

$K_2 \neq 0$ (see their definitions in (44), the gyration coefficient p contains the square of the Hubble function (i.e., the spacetime curvature scalar in the case of the de Sitter model). Thus, we deal with combined axionic-tidal gyration effect. The frequencies of transversal electromagnetic waves are shown to depend not only on the wavelength, but also on the gyration coefficient p (see, e.g., (113)), and this dependence has a critical character. To be more precise, when $p \neq 0$, the dispersion equations admit some new branches of solutions $\omega = \omega(k, p)$, $\gamma = \gamma(k, p)$ in addition to the standard ones. If to consider the transversal electromagnetic wave propagation in terms of left- and right-hand rotating components, one can state, that one of the waves (say, with left-hand rotation) can have arbitrary wavelength, while the second wave can possess the wave number less than critical one (see, e.g., (112)); in this sense we deal with some kind of mode suppression caused by the axion-photon interactions.

In order to simplify the classification of the electromagnetic modes in an axionically active plasma, we use the following terminology: *damping wave*, when $\omega \neq 0$, $\gamma < 0$; *instable wave*, when $\omega \neq 0$, $\gamma > 0$; *running wave*, when $\omega \geq k$, $\gamma = 0$; *damping nonharmonic perturbation*, when $\omega = 0$, $\gamma < 0$; *instable nonharmonic perturbation*, when $\omega = 0$, $\gamma > 0$. The results of analytic, qualitative and numerical study are presented on Figs. 7-9 and in Tables I-III. Based on these results, we can illustrate the evolution of types of the transversal electromagnetic perturbations depending on the value of the gyration parameter p for small, medium and large k . For this purpose we draw, first, the horizontal straight line on Fig. 7, and move it from the bottom to upwards.

- When $p \leq 0$, the horizontal straight line does not cross any separatrices; in this case for arbitrary k there exist solutions of two types: first, running waves with $\omega > k$, $\gamma = 0$, or in other words $V_{\text{ph}} > 1$; second, damping nonharmonic perturbations.
- When $0 < p < \sqrt{\frac{3}{2}}W_{\text{NM}}$ (below the cross-point A), the horizontal straight line crosses the separatrices (a) and (b), thus displaying three zones. In the zone of medium k ($p < k < \frac{3W_{\text{NM}}^2}{2p}$) the running waves with $V_{\text{ph}} > 1$ and damping nonharmonic perturbations happen to be inherited from the zone $p \leq 0$; in the zone of small k ($k < p$) the running waves with $V_{\text{ph}} > 1$ are inherited, but damping nonharmonic perturbations convert into the instable ones; in the zone of large k ($k > \frac{3W_{\text{NM}}^2}{2p}$) the running waves convert into damping waves, but damping nonharmonic perturbations are inherited.
- When $1.225 < \frac{p}{W_{\text{NM}}} < 2.613$ (between cross-point A and extreme point B), there are also three zones. When $k < \frac{3W_{\text{NM}}^2}{2p}$, there exist running waves and instable nonharmonic perturbations; when $\frac{3W_{\text{NM}}^2}{2p} <$

$k < p$, running waves convert into damping waves and instable nonharmonic perturbations are inherited; when $k > p$, damping waves and damping perturbations are inherited.

- Next interval $2.613 < \frac{p}{W_{\text{NM}}} < 2.899$ can be describe similarly; new zone indicated as III appears, in which damping waves convert into damping nonharmonic perturbations.
- When $2.899 < \frac{p}{W_{\text{NM}}} < 3.003$, the following new detail appears: the zone of medium k breaks up into three subzones, and in one of them damping waves appear instead of running waves (in the domain VII).
- When $p > 3.003W_{\text{NM}}$, the description is similar, but the new subzone appears (see domain IV), in which waves do not exist.

Similarly, we can illustrate the evolution of the modes for the case $1 + 2K_1 < 0$ and $1 + 2K_1 = 0$. Such analysis reveals two interesting features. First, when the gyration parameter p and the nonminimal parameter $1 + 2K_1$ are fixed, we can find explicitly the range for the wave parameter k , for which the running waves, i.e., non-damping transversal electromagnetic waves, can propagate in the Universe in the axionic dark matter environment and bring us a true information about the Universe structure and history. For instance, when $1 + 2K_1 > 0$ according to the Table I it is possible in the domains I and II only; thus, if the gyration parameter exceeds, say, the value $p = \sqrt{\frac{3}{2}}W_{\text{NM}}$ (see the point A on Fig. 7), the running waves can propagate only in the narrow interval of small k (the interval of long waves). When $1 + 2K_1 < 0$, according to Table II the running waves can propagate in the domain V' only; thus, if the parameter p is positive, the running transversal waves are suppressed for any k . Second, we can focus on the problem of existence of transversal electromagnetic waves of a new type, i.e., transversal waves with the phase velocity less than the speed of light in vacuum, $\omega < k$, which can interact in a resonant manner with particles co-moving with them. It is well-known that in the minimal theory ($K_1 = 0$) at the absence of axion field $\nu = 0$ the dispersion equations do not admit the transversal waves of this type. Our consideration shows that the damping waves with $V_{\text{ph}} < 1$ exist in the domains VI and VII (see Fig. 7 for the case $1 + 2K_1 > 0$), and the instable waves with $V_{\text{ph}} < 1$ can be generated for the case $1 + 2K_1 < 0$. Since the phase velocity of the transversal electromagnetic wave is less than speed of light in vacuum, we can make the following remark. There are plasma particles, which co-move with this transversal electromagnetic wave, thus providing a resonant interaction; in the case $1 + 2K_1 > 0$ this resonant interaction leads to the Landau-type damping, since the wave transfers the energy to the resonant particles; in the case $1 + 2K_1 < 0$ this resonant interaction provides the Landau-type instability, since now resonant

particles transfer their energy to the transversal plasma wave.

In the next paper we plan to study the dispersion relations for the axionically active plasma nonminimally coupled to gravity in the framework of cosmological Bianchi-I model with initial magnetic field and electric field axionically induced.

Acknowledgments

The work was partially supported by the Russian Foundation for Basic Research (Grants Nos. 11-

02-01162 and 11-05-97518), by the Federal Targeted Program N14.T37.21.0668 and the State Assignment N5.2971.2011.

-
- [1] V.P. Silin and A.A. Rukhadze, *Electromagnetic Properties of Plasma and Plasma-like Media* (Moscow, Gosatomizdat, 1961).
- [2] A.I. Akhiezer *et al.*, *Electrodynamics of Plasma* (Moscow, Nauka, 1974).
- [3] L.P. Pitaevskii and E.M. Lifshitz, *Physical Kinetics* (Oxford, Butterworth-Heinemann, 1981).
- [4] A. Piel, *Plasma Physics. An Introduction to Laboratory, Space and Fusion Plasmas* (Berlin, Springer Verlag, 2010).
- [5] A.B. Balakin, R.K. Muharlyamov, and A.E. Zayats, Non-minimal Einstein-Maxwell-Vlasov-axion model. arXiv: 1309.3889 [gr-qc].
- [6] S.J. Perlmutter *et al.*, *Nature* **391**, 51 (1998).
- [7] A.G. Riess *et al.*, *Astron. J.* **116**, 1009 (1998).
- [8] B.P. Schmidt *et al.*, *Astrophys. J.* **507**, 46 (1998).
- [9] A.A. Starobinsky, *Gravit. Cosmol.* **6**, 157 (2000).
- [10] R.R. Caldwell, M. Kamionkowski, and N.N. Weinberg, *Phys. Rev. Lett.* **91**, 071301 (2003).
- [11] S. Nojiri, S.D. Odintsov, and S. Tsujikawa, *Phys. Rev. D* **71**, 063004 (2005).
- [12] A.B. Balakin and V.V. Bochkarev, *Phys. Rev. D* **87**, 024006 (2013).
- [13] A. Del Popolo, *Astron. Rep.* **51**, 169 (2007).
- [14] G. Lazarides, *Lect. Notes Phys.* **720**, 3 (2007).
- [15] J. Silk, *Lect. Notes Phys.* **720**, 101 (2007).
- [16] R.D. Peccei and H.R. Quinn, *Phys. Rev. Lett.* **38**, 1440 (1977).
- [17] W.-T. Ni, *Phys. Rev. Lett.* **38**, 301 (1977).
- [18] S. Weinberg, *Phys. Rev. Lett.* **40**, 223 (1978).
- [19] F. Wilczek, *Phys. Rev. Lett.* **40**, 279 (1978).
- [20] R.D. Peccei, *Lect. Notes Phys.* **741**, 3 (2008).
- [21] R. Battesti *et al.*, *Lect. Notes Phys.* **741**, 199 (2008).
- [22] G.G. Raffelt, *Phys. Rep.* **198**, 1 (1990).
- [23] M.S. Turner, *Phys. Rep.* **197**, 67 (1990).
- [24] M. Khlopov, *Fundamentals of cosmic particle physics* (Cambridge, International Science Publishing, 2012).
- [25] A.S. Sakharov and M.Yu. Khlopov, *Phys. Atom. Nucl.* **57**, 485 (1994).
- [26] A.S. Sakharov, D.D. Sokoloff, and M.Yu. Khlopov, *Phys. Atom. Nucl.* **59**, 1005 (1996).
- [27] M.Yu. Khlopov, A.S. Sakharov, and D.D. Sokoloff, *Nucl. Phys. B (Proc. Suppl.)* **72**, 105 (1999).
- [28] A.B. Mikhailovskii, *Theory of plasma instabilities. Instabilities of an inhomogeneous plasma* (New York, Springer, 1974).
- [29] M.Yu. Khlopov, B.A. Malomed, and Ya.B. Zeldovich, *Mon. Not. Roy. Astr. Soc.* **215**, 575 (1985).
- [30] R. Penrose, *Conformal treatment of infinity*, in *Relativity, Groups and Topology*, edited by C. DeWitt and B. DeWitt (Gordon and Breach, New York, 1964), p. 565.
- [31] L.D. Landau, E.M. Lifshitz, and L.P. Pitaevskii, *Electrodynamics of continuous media* (Oxford, Butterworth-Heinemann, 1996).
- [32] Y. Itin, *Phys. Rev. D* **76**, 087505 (2007).
- [33] Y. Itin, *Gen. Rel. Grav.* **40**, 1219 (2008).
- [34] A.A. Vlasov, *JETP* **8**, 291 (1938).
- [35] L.D. Landau, *JETP* **16**, 574 (1946).
- [36] E.W. Hobson, *The Theory of Spherical and Ellipsoidal Harmonics* (Cambridge, University Press, 1931).
- [37] H. Bateman, A. Erdelyi, *Higher transcendental functions. Vol. 1* (New York, McGraw-Hill, 1953).
- [38] A. B. Balakin and R. K. Muharlyamov, *Gravit. Cosmol.* **15**, 16 (2009).
- [39] V.L. Ginzburg and A.A. Rukhadze, *Waves in Magnetoactive Plasma* (Moscow, Nauka, 1975).
- [40] S. Nojiri and S.D. Odintsov, *Phys. Rept.* **505**, 59 (2011).
- [41] A.B. Balakin, V.V. Bochkarev and N.O. Tarasova, *Eur. Phys. J. C* **72**, 1895 (2012).