

The 1, 2, 3-Conjecture and 1, 2-Conjecture for Sparse Graphs

Daniel W. Cranston*, Sogol Jahanbekam†, and Douglas B. West‡

October 9, 2018

Abstract

We apply the Discharging Method to prove the 1, 2, 3-Conjecture and the 1, 2-Conjecture for graphs with maximum average degree less than $8/3$. Stronger results on these conjectures have been proved, but this is the first application of discharging to them, and the structure theorems and reducibility results are of independent interest.

Keywords: 1, 2, 3-Conjecture, 1, 2-Conjecture, discharging method.

Mathematics Subject Classification: 05C15, 05C22, 05C78.

1 Introduction

Variations on coloring problems in graph theory have involved many ways of generating vertex colorings. Without restrictions, the minimum number of distinct colors needed to label the vertices of G so that adjacent vertices have different colors is the *chromatic number* $\chi(G)$. We consider restricted colorings produced from weights on the edges and vertices.

Let $V(G)$ and $E(G)$ denote the vertex set and edge set of a graph G , and let $\Gamma_G(v)$ denote the set of edges incident to a vertex v . An *S -weighting* of a graph G is a map $w: E(G) \rightarrow S$. A *total S -weighting* is a map $w: E(G) \cup V(G) \rightarrow S$. More specifically, a k -weighting is an S -weighting with $S = \{1, \dots, k\}$. For a weighting w , let $\phi_w(v) = \sum_{e \in \Gamma_G(v)} w(e)$. For a total weighting w , let $\phi_w(v) = w(v) + \sum_{e \in \Gamma_G(v)} w(e)$; that is, each vertex is assigned the total of the weights it “sees”. A weighting or total weighting w is *proper* if ϕ_w is a proper coloring of G . We seek proper k -weightings or proper total k -weightings for small k .

Conjecture 1.1 (1, 2, 3-Conjecture; Karónski–Łuczak–Thomason [7]). *Every graph without isolated edges has a proper 3-weighting.*

*dcranston@vcu.edu; Virginia Commonwealth University, Richmond, VA.

†jahanbe1@illinois.edu; University of Illinois, Urbana, IL. Research supported in part by National Science Foundation grant DMS 09-01276.

‡west@math.uiuc.edu; Zhejiang Normal University, Jinhua, China, and University of Illinois, Urbana, IL. Research supported in part by National Security Agency grant H98230-10-1-0363.

Conjecture 1.2 (1, 2-Conjecture; Przybyło–Woźniak [8]). *Every graph has a proper total 2-weighting.*

Toward the 1, 2, 3-Conjecture, the original paper proved it for graphs with chromatic number at most 3. Addario-Berry et al. [1] showed that every graph without isolated edges has a proper k -weighting when $k = 30$. After improvements to $k = 15$ in [2] and $k = 13$ in [10], Kalkowski, Karóński, and Pfender [6] showed that every graph without isolated edges has a proper 5-weighting. Toward the 1, 2-Conjecture, Przybyło and Woźniak [8] proved it for complete graphs and for graphs with chromatic number at most 3. Kalkowski [5] showed that every graph has a proper total 3-weighting; furthermore, there is such a weighting with the edge weights in one spanning tree fixed arbitrarily and the vertex weights chosen from $\{1, 2\}$. Seamone [9] surveyed progress on these and related problems.

List versions of the conjectures have been proposed. A graph is *k -weight-choosable* if whenever each edge is given a list of k available integers, a proper weighting can be chosen from the lists. A graph is *(k, k') -weight-choosable* if whenever each vertex has a list of size k and each edge has a list of size k' , a proper total weighting can be chosen from the lists.

Conjecture 1.3 (Bartnicki–Grytczuk–Niwczyk [4]). *Every graph without isolated edges is 3-weight-choosable.*

Conjecture 1.4 (Wong–Zhu [12]). *Every graph is $(2, 2)$ -weight-choosable. Every graph without isolated edges is $(1, 3)$ -weight-choosable.*

These conjectures are stronger than the original conjectures, which concern the special case where the lists consist of the smallest positive integers.

Wong, Yang, and Zhu [11] proved that the complete multipartite graph $K_{n,m,1,1,\dots,1}$ is $(2, 2)$ -weight-choosable and that complete bipartite graphs other than K_2 are $(1, 2)$ -weight-choosable. Bartnicki, Grytczuk, and Niwczyk [4] applied the Combinatorial Nullstellensatz [3] to prove Conjecture 1.3 for complete graphs, complete bipartite graphs, and trees. Wong and Zhu [12] applied the Combinatorial Nullstellensatz to prove Conjecture 1.4 for complements of linear forests; this includes complete graphs. They also proved that every tree with an even number of edges is $(1, 2)$ -weight-choosable. Wong, Yang, and Zhu [11] continued this approach, proving Conjecture 1.4 for graphs with maximum degree 3. Finally, Wong and Zhu [13] proved that every graph is $(2, 3)$ -weight-choosable.

Our results use the “Discharging Method” and apply to sparse graphs. Sparseness is imposed by bounding the *maximum average degree* of G , denoted $\text{Mad}(G)$, which is the largest average degree among the subgraphs of G : $\text{Mad}(G) = \max_{H \subseteq G} \frac{2|E(H)|}{|V(H)|}$. A consequence of our results is that Conjectures 1.1 and 1.2 hold for every graph G such that $\text{Mad}(G) < 8/3$. However, that consequence is already known, since every subgraph of a graph G with $\text{Mad}(G) < 8/3$ has a vertex with degree at most 2, and therefore by induction is 3-colorable. The original papers proved the conjectures for 3-colorable graphs.

The novelty of our results is thus in the structure theorems proved by discharging (which may be of use in solving other problems) and in the reducibility theorems showing that various configurations cannot occur in minimal counterexamples to the conjecture.

We note that proofs via the Combinatorial Nullstellensatz are nonconstructive, in that the parameter space to be searched for the guaranteed weighting is exponentially large. Inductive proofs via discharging, such as ours, yield polynomial-time algorithms to produce the solution, though implementation may be complicated. The original proofs of these conjectures for 3-colorable graphs are also constructive.

Because our proofs for $\text{Mad}(G) < 8/3$ are fairly long, we first present in Section 2 short proofs of the weaker results that the claims hold when $\text{Mad}(G) < 5/2$. The reducibility arguments in these proofs are used in the stronger results.

To discuss both problems together, let *j-weighting* mean a 3-weighting when $j = 3$ and a total 2-weighting when $j = 2$. A graph is *j-bad* if it has no proper *j-weighting* (and no isolated edge if $j = 3$). Configurations forbidden from minimal *j-bad* graphs are *j-reducible*.

Our proofs of *j-reducibility* use the restriction of weights to values at most j , so they do not extend to the list versions. Also, unlike in most coloring problems, vertices of degree 1 do not immediately yield reducible configurations, since the weight on a pendant edge affects whether its incident edges are properly colored.

In Section 2 we first obtain some 3-reducible configurations. We next use discharging to show that every graph with average degree less than $5/2$ contains a 3-reducible configuration. We assign each vertex initial charge equal to its degree and then shift charge so that if no specified configuration occurs, then every vertex has final charge at least c . Since $\text{Mad}(G) < c$ and $G' \subseteq G$ imply $\text{Mad}(G') < c$ (by definition), this proves that G has a proper 3-weighting when $\text{Mad}(G) < 5/2$. In Section 2 we also use this method to prove that G has a proper (total) 2-weighting when $\text{Mad}(G) < 5/2$. Both results use the same discharging argument, although the sets of reducible configurations are different.

When $\text{Mad}(G) \geq 5/2$, no longer must G have a configuration among those in Section 2. We need additional reducible configurations to complete an unavoidable set when $\text{Mad}(G) < 8/3$. In Section 3 and Section 4, respectively, we complete the proofs of the 1, 2-Conjecture and the 1, 2, 3-Conjecture for graphs G such that $\text{Mad}(G) < 8/3$.

2 Reducible Configurations and $\text{Mad}(G) < 5/2$

In discharging arguments for sparse graphs, it is convenient to have concise terminology for vertices satisfying degree constraints.

Definition 2.1. A vertex with degree k , at least k , or at most k is a *k-vertex*, a k^+ -vertex, or a k^- -vertex, respectively. A *j-neighbor* of v is a *j-vertex* that is a neighbor of v .

Write $N_G(v)$ for the neighborhood of v in G and $d_G(v)$ for its degree. For $v \in V(G)$ and $U \subseteq N_G(v)$, let $[v, U]$ denote the set of edges joining v to U .

A weighting or total weighting w satisfies an edge uv if $\phi_w(u) \neq \phi_w(v)$, or equivalently if $\rho_w(u, v) \neq \rho_w(v, u)$, where we define $\rho_w(x, y) = \phi_w(x) - w(xy)$ when x and y are adjacent.

A *configuration* in a graph G is a subgraph C together with specified degrees in G for $V(C)$. The *core* of the configuration is $E(C)$, and the resulting *derived graph* is $G - E(C)$.

Our simplest configurations consist of a vertex with specified degree and the edges from it to certain neighbors of specified degrees. We begin with a lemma that reduces the length of reducibility proofs: 1-neighbors are “easier” to handle than 2-neighbors, so when we claim that a configuration is reducible when a particular vertex has degree 1 or 2, in the proof we may assume that it has degree 2.

Lemma 2.2. *If a vertex z in a 2- or 3-reducible configuration C has degree 1 in C and is specified as a 2-vertex of the full graph, then the configuration C' obtained from C by instead specifying z as a 1-vertex (with neighbor v) is also reducible.*

Proof. Let H be a graph containing C' , and let H' be the derived graph; z is isolated in H' . Form G by adding vertices a and b and edges ab and bz to H . Now C arises in G , and its derived graph G' arises from H' in the same way that G arises from H .

If H is a minimal j -bad graph, then H' has a desired weighting. Since also the path P_3 has such a weighting, G' has such a weighting. Since C is j -reducible, G therefore also has such a weighting. To obtain the desired weighting of H , note that all edges are satisfied when a and b are deleted from the weighting of G , except possibly zv .

For $j = 2$, the weight on z is needed only to satisfy zv in H and can be respecified so that zv is satisfied. For $j = 3$, the edge zv is satisfied automatically since $d_H(v) > 1$. \square

Reducibility proofs may use some types of inferences many times. The next lemma enables us to express statements concisely and reduce repetitive language. It can be stated in more generality, but for clarity we list just typical situations in which we will use it.

Lemma 2.3. *Let w be a partial j -weighting of a graph G (w is not specified everywhere). In the situations below, the weights on a set S can be chosen to satisfy the edges in a set F if the weights on all the edges (or vertices) incident to F and not in S are already known:*

- 1) *The edges of F have a common endpoint v , incident to all edges of S (possibly also $v \in S$ when $j = 2$), and $|F| \leq (j - 1)|S|$.*
- 2) *F consists of two edges, with S a single edge joining them and $j = 3$.*

Proof. Let $k = |S|$. Since weights are chosen from $\{1, \dots, j\}$, the sum of k weights has $1 + (j - 1)k$ possible values. Each edge in F uses that sum in determining whether the values of ϕ differ at its endpoints. Each edge in F thus forbids at most one value of the sum in a

proper j -weighting. There are at least $k(j - 1)$ possible augmentations above the least value of the sum, so when $k(j - 1) \geq |F|$ the labels can be chosen to satisfy all of F .

Note that in (2) the weights on F may be unspecified; the weight on an edge does not affect whether it is satisfied. Similarly, if $F = \{uv\}$, and S is a single edge incident to v or is v itself, and the weights of all other items incident to uv are known, then the weight on S can be chosen in $j - 1$ ways to satisfy F . \square

Remark 2.4. We use Lemma 2.3 frequently in reducibility arguments, invoked without mention in 2-reducibility when we write “choose $w(vz)$ to satisfy vx ” or “choose $w(v)$ and $w(vz)$ to satisfy vx and vv ”. In 3-reducibility, a choice can satisfy more. In 2-reducibility we can choose one weight to avoid one value, but in 3-reducibility it can avoid two values.

Another method of satisfying an edge uv is to create sufficient imbalance between the contributions at u and v to guarantee that $\phi(u) \neq \phi(v)$ when the weighting is completed. When we write “Set $w(uv) = 3$ to ensure satisfying vz ”, we mean that no way of choosing weights on the remaining edges can produce $\phi(u) = \phi(v)$. Saying that an edge is “automatically satisfied” has a similar meaning. For example, any edge joining a 1-vertex to a 3-vertex is automatically satisfied for (total) 2-weightings, while putting weight 1 at the 1-vertex ensures satisfying the edge even when the neighbor has degree 2.

The figures for configurations show the core in bold; the derived graph G' is obtained by deleting the core. Also, with w' assumed to be a proper j -weighting of G' , the label on an edge e is $w'(e)$, and the label in a circle at a vertex x with one neighbor u is $\rho_{w'}(x, u)$. To satisfy xu , the sum of the contributions at u other than $w'(xu)$ must differ from $\rho_{w'}(x, u)$.

The figures do not show cases where some of the specified vertices may be equal. For instances where such equalities do not affect the validity of the written argument, we make no comment about possible changes in the illustration.

The task of proving reducibility for a configuration C is the task of modifying or extending a proper j -weighting w' of the derived graph G' to obtain a j -weighting w of G such that the edges in or incident to the core of C become satisfied, while the other edges of G' remain satisfied. If we do not change the weights on edges of G' incident to the core, then we do not change the fact that all edges of G' not incident to the core are satisfied.

With these preparations, we begin the reducibility arguments. The first lemma eliminates many degenerate cases of later configurations in which specified vertices may be identical.

Lemma 2.5. *The following configurations are both 2-reducible and 3-reducible:*

- (1) *A 3-cycle through two 2-vertices and one 4^- -vertex.*
- (2) *A 3-cycle through one 2-vertex z and two vertices that each may be a 3-vertex, a 4-vertex with a 1-neighbor, or a 5-vertex with a 1-neighbor. In addition, one neighbor of z is allowed to be a 4-vertex with a 2-neighbor other than z (and no 1-neighbor).*

Proof. When G is a 3-cycle, the weights can be chosen to produce colors $\{3, 4, 5\}$ at the vertices, for either value of j . Suppose $G \neq C_3$. In each case, we extend a proper j -weighting w' of a subgraph G' obtain by deleting the edges of the cycle. The cases appear in Figure 1.

For (1), let v be the 3^+ -vertex on the cycle, and let z and z' be the 2-vertices. To extend w' to w , first set $w(zz') = 1$, and also set $w(v) = 2$ if $j = 2$. This ensures satisfying vz and vz' . If $j = 2$, then fix $w(z) = 1$, choose $w(vz)$ and $w(vz')$ to satisfy $\Gamma_{G'}(v)$, and choose $w(z')$ to satisfy zz' . If $j = 3$, then require $w(vz) \neq w(vz')$ with $w(vz) \in \{1, 2\}$ and $w(vz') \in \{2, 3\}$ to satisfy zz' . There are three choices for $w(vz) + w(vz')$, so we can choose them also to satisfy $\Gamma_{G'}(v)$, since $d_{G'}(v) \leq 2$.

For (2), let v and v' be the other vertices of the triangle. If $d_G(v) \geq 4$, then let u be a vertex of smallest degree in $N(v) - \{z\}$; similarly define $u' \in N(v')$. Form G' from G by deleting $\{vz, v'z, vv'\}$ and the edges vu and $v'u'$ (if they exist). Figure 1 shows one of the possibilities at each of v and v' .

We first ensure that vz and $v'z$ will be satisfied by setting $w(vv') = j$ (and $w(z) = 1$ if $j = 2$); this will yield $\rho_w(z, v) \leq 3 < 4 \leq \rho_w(v, z)$, since $d_G(v) \geq 3$.

For $d_G(v) = 3$, choose $w(vz)$ (and $w(v)$ if $j = 2$) to satisfy the one edge in $\Gamma_{G'}(v)$. For $d_G(v) \in \{4, 5\}$ and $d_G(u) = 1$, choose $w(vz)$ and $w(vu)$ (and $w(v)$ if $j = 2$) to satisfy $\Gamma_{G'}(v)$. These cases have extra flexibility, so that if all contributions to $\phi_w(v')$ are already known, then vv' can also be satisfied.

For $d_G(v) = 4$ and $d_G(u) = 2$, choose $w(vu)$ (and $w(u)$ if $j = 2$) to satisfy $\Gamma_{G'}(u)$, and then choose $w(vz)$ (and $w(v)$ if $j = 2$) to satisfy vu and $\Gamma_{G'}(v)$. In this case we do not satisfy vv' using edges at v . Instead, we satisfy vv' using one of the earlier cases at v' after $\phi_w(v)$ is known; this case is only allowed to occur at one of $\{v, v'\}$. \square

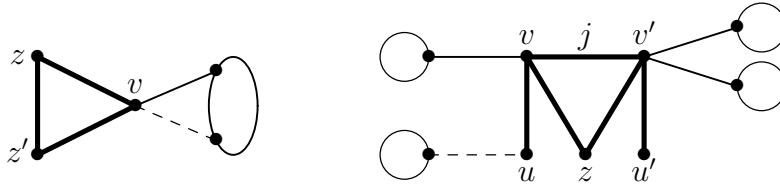

Figure 1: Cases (1) and (2) for Lemma 2.5

Lemma 2.6. *The following configurations are 3-reducible.*

- A. A 2-vertex or 3-vertex having a 1-neighbor.
- B. A 4^- -vertex whose neighbors all have degree 2.
- C. A 3-vertex having two 2-neighbors, one of which has a 2-neighbor.
- D. A 4-vertex having a 1-neighbor and a 2^- -neighbor.
- E. A 5^+ -vertex v with $3p_1 + 2p_2 \geq d_G(v)$, where p_i is the number of i -neighbors of v .

Proof. Let v be such a vertex in a graph G . Let U_i be the set of i -neighbors of v . Form the derived graph G' as specified in Definition 2.1 (deleting the bold core), except that in addition any resulting isolated edges are also deleted. We show that a proper 3-weighting w' of G' can be used to obtain a proper 3-weighting w of G .

Case A: $d_G(v) \leq 3$ and v has a 1-neighbor u . As in Lemma 2.3, we can choose $w(uv)$ to satisfy the other edges at v . With $d_G(v) \geq 2$, the edge uv is automatically satisfied.

By Case **A**, deleting the core in Cases **B,C,D** leaves no isolated edges.

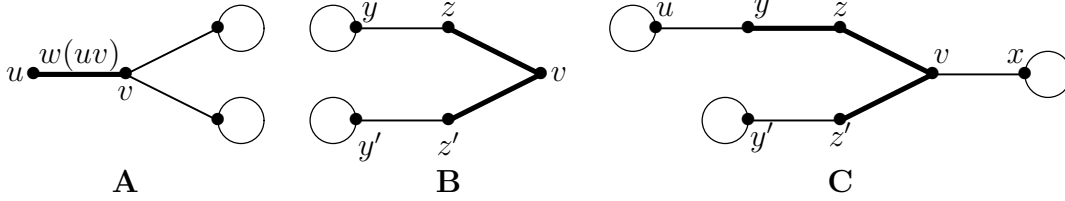

Figure 2: Cases **A**, **B**, **C** for Lemma 2.6

Case B: $d_G(v) \leq 4$ and $U_2 = N_G(v)$. Let z and z' be 2-neighbors of v , with $N_G(z) = \{v, y'\}$ and $N_G(z') = \{v, y\}$. By Lemma 2.5, $\{y, y'\} \cap \{z, z'\} = \emptyset$ (see Figure 2B). Let $G' = G - \{vz, vz'\}$. If $d_G(v) = 2$, then choose $w(vz)$ to satisfy yz and vz' , and choose $w(vz')$ to satisfy $y'z'$ and vz . If $d_G(v) \in \{3, 4\}$, then for $z \in N_G(v)$ with $zy \in E(G')$, choose $w(vz) \in \{2, 3\} - \{\rho_{w'}(y, z)\}$ to satisfy yz . Since $d(v) \geq 3 \geq w'(zy)$, such choices on all of $\Gamma_G(v)$ also satisfy zv .

Case C: $d_G(v) = 3$ and $U_2 = \{z, z'\}$, with z having a 2-neighbor y . By Lemma 2.5, we may assume $y \neq z'$. Let $G' = G - \{vz, vz', zy\}$, leaving $vx, z'y', yu \in E(G')$ (see Figure 2C). Choose $w(vz)$ to satisfy zy and vz' , then $w(vz')$ to satisfy $z'y'$ and vx , and finally $w(zy)$ to satisfy yu and vz .

Case D: $d_G(v) = 4$ and $N_G(v) = \{u, z, x, x'\}$ with $d_G(u) = 1$ and $d_G(z) \leq 2$. By Lemma 2.2, we may assume $d_G(z) = 2$. Let $G' = G - \{vu, vz\}$, leaving $zy \in E(G')$ (see Figure 3D, where y may be in $N_G(v)$). When choosing $w(vz)$ to satisfy zy and choosing $w(vu)$ to satisfy vz , each has at least two possible values. Hence they can be chosen with three possible values for $w(vz) + w(vu)$, yielding a choice that also satisfies vx and vx' .

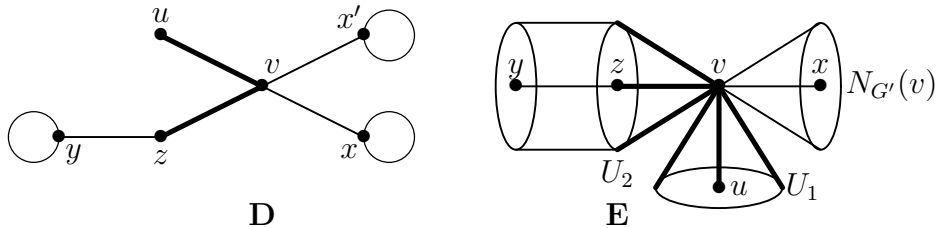

Figure 3: Cases **D** and **E** for Lemma 2.6

Case E: $d_G(v) \geq 5$ and $3p_1 + 2p_2 \geq d_G(v)$. For $z \in U_2$, let y be the neighbor of z in G' . To satisfy yz when $y \notin U_2$ (see Figure 3E), we need $w(vz) \neq \rho_{w'}(y, z)$; there are at least two such choices for $w(vz)$. (If $y \in U_2$, then yz is deleted in G' ; let $w(yz) = 1$. Now $w(vy) \neq w(vz)$ is needed to satisfy yz , leaving three choices for $w(vy) + v(vz)$.)

Edges to U_1 are automatically satisfied, since $d_G(v) \geq 2$. For $z \in U_2$, the edge zv will be satisfied, since $d_G(v) \geq 5$ yields $\rho_w(v, z) \geq 4 > 3 \geq w(zv)$.

It remains to satisfy $\Gamma_{G'}(v)$. Let $\sigma = \sum_{e \in E(G) - E(G')} w(e)$. We need $\sigma \neq \phi_{w'}(x) - \phi_{w'}(v)$ when $x \in N_{G'}(v)$, so σ must avoid $d_G(v) - p_1 - p_2$ values. It suffices to show that there are $1 + 2p_1 + p_2$ choices for σ , since we are given $2p_1 + p_2 \geq d_G(v) - p_1 - p_2$.

Weights on edges from v to U_1 have three choices. Those to U_2 have at least two choices, except that two such edges incident to neighboring 2-vertices instead have three choices for the sum of their two weights. Starting with the smallest choices, we can make $2p_1 + p_2$ augmentations to the sum, always using choices that satisfy the constraints discussed earlier. Hence there are enough choices for σ to satisfy the final constraints. \square

We now present a discharging argument to obtain an unavoidable set of configurations.

Lemma 2.7. *If a graph G without isolated edges has average degree less than $5/2$, then G contains one of the following configurations.*

- A.** A 2-vertex or 3-vertex having a 1-neighbor.
- B.** A 4^- -vertex whose neighbors all have degree 2.
- C.** A 3-vertex having two 2-neighbors, one of which has a 2-neighbor.
- D.** A 4-vertex having a 1-neighbor and a 2^- -neighbor.
- E.** A 5^+ -vertex v with $3p_1 + p_2 \geq 2d_G(v) - 4$, where p_i is the number of i -neighbors of v .

Proof. We prove that a graph G containing none of **A-E** has average degree at least $5/2$. Give every vertex v in G initial charge $d_G(v)$. Move charge via the following rules:

- (1) Each 4^+ -vertex gives $\frac{3}{2}$ to each 1-neighbor and $\frac{1}{2}$ to each 2-neighbor.
- (2) Each 3-vertex with a 2-neighbor gives total $\frac{1}{2}$ to its 2-neighbors, split equally if it has two 2-neighbors.

Let $\mu(v)$ denote the resulting charge at v ; it suffices to check that $\mu(v) \geq \frac{5}{2}$ for all v . For $\mathbf{Z} \in \{\mathbf{A}, \mathbf{B}, \mathbf{C}, \mathbf{D}, \mathbf{E}\}$, let $\overline{\mathbf{Z}}$ mean ‘‘configuration \mathbf{Z} does not occur in G ’’.

Case $d(v) = 1$: By $\overline{\mathbf{A}}$, the neighbor of a 1-vertex v has degree at least 4, so $\mu(v) = \frac{5}{2}$.

Case $d(v) = 2$: By $\overline{\mathbf{A}}$ and $\overline{\mathbf{B}}$, v has a 3^+ -neighbor and receives from it $\frac{1}{4}$ or $\frac{1}{2}$. If only $\frac{1}{4}$, then $\overline{\mathbf{C}}$ implies that v also receives at least $\frac{1}{4}$ from its other neighbor, so $\mu(v) \geq \frac{5}{2}$.

Case $d(v) = 3$: By $\overline{\mathbf{A}}$ and $\overline{\mathbf{B}}$, v has no 1-neighbor and at most two 2-neighbors. Hence v gives away 0 or $\frac{1}{2}$, and $\mu(v) \geq \frac{5}{2}$.

Case $d(v) = 4$: By $\overline{\mathbf{D}}$ and $\overline{\mathbf{B}}$, v has at most one 1-neighbor, has a 2-neighbor only if it has no 1-neighbor, and has at most three 2-neighbors. It loses at most $\frac{3}{2}$, and $\mu(v) \geq \frac{5}{2}$.

Case $d(v) \geq 5$: v gives $\frac{3}{2}$ to each 1-neighbor and $\frac{1}{2}$ to each 2-neighbor. By $\overline{\mathbf{E}}$, $\mu(v) = d_G(v) - \frac{1}{2}(3p_1 + p_2) \geq d_G(v) - \frac{1}{2}(2d_G(v) - 5) = \frac{5}{2}$. \square

Theorem 2.8. *If G has no isolated edge, and $\text{Mad}(G) < \frac{5}{2}$, then G has a proper 3-weighting.*

Proof. A minimal counterexample contains none of the configurations **A-E** in Lemma 2.6. However, it has average degree less than $5/2$, and hence it contains a configuration listed in Lemma 2.7. The lists are the same except for **E**. Since a 5^+ -vertex v satisfying $3p_1 + p_2 \geq 2d_G(v) - 4$ also satisfies $3p_1 + 2p_2 \geq d_G(v)$, every graph with $\text{Mad}(G) < 5/2$ contains a reducible configuration. \square

For the 1,2-Conjecture, we again begin with reducible configurations. Isolated edges are now allowed, which eliminates some technicalities. We will be able to use the unavoidable set obtained in Lemma 2.7, but the list of 2-reducible configurations is different. The new technique here is that in obtaining the proper total 2-weighting of G from such a weighting of a subgraph G' , we may erase weights from some vertices and recolor them.

Configuration **B** in the next lemma is more general than is needed for the 1,2-Conjecture when $\text{Mad}(G) < 5/2$, but we will need its full generality in the proof for $\text{Mad}(G) < 8/3$.

Lemma 2.9. *A minimal 2-bad graph contains none of the following configurations.*

- A.** *A 3^- -vertex having a 1-neighbor.*
- B.** *A 4^- -vertex having two 2^- -neighbors.*
- C.** *A 5^+ -vertex v whose number of 2^- -neighbors is at least $(d(v) - 1)/2$.*

Proof. In each case, we obtain a proper total 2-weighting of G from such a weighting w' of the derived graph G' . Let v be the specified vertex. Since isolated edges have proper total 2-weightings, we may assume that any 1-vertex in G has a 2^+ -neighbor. In the extension arguments, we use Lemma 2.3 frequently to choose labels.

Case A: $d(v) \leq 3$, and v has a 1-neighbor u . For $d(v) = 3$, let $N_{G'}(v) = \{x, x'\}$ (see Figure 4A). Uncolor v , and then choose $w(v), w(uv) \in \{1, 2\}$ to satisfy vx and vx' . Now choose $w(u)$ to satisfy uv . When $d(v) = 2$, we only need $w(v) + w(uv)$ to avoid one value.

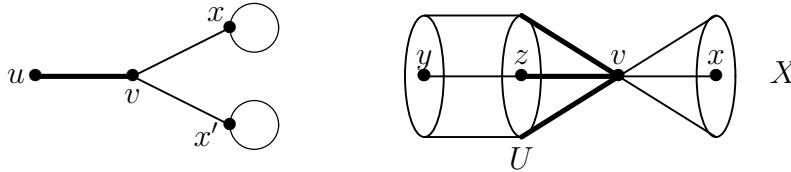

Figure 4: Cases **A** and **C** for Lemma 2.9

Case C: $d(v) \geq 5$ and v has at least $\frac{d(v)-1}{2}$ 2^- -neighbors. Let U be a set of p such neighbors, where $p = \left\lceil \frac{d(v)-1}{2} \right\rceil$, and let $G' = G - [v, U]$ and $X = N_{G'}(v)$. By Lemma 2.2, for $z \in U$ we may assume $d_G(z) = 2$ and let $\{y\} = N_{G'}(z)$ (see Figure 4C). Uncolor z .

By Lemma 2.3, we can choose the $p+1$ weights on $\{v\} \cup \{vz: z \in U\}$ to satisfy $[v, X]$ in G , since $p+1 \geq d(v) - p$. Now choose $w(z)$ for $z \in U$ to satisfy zy . Finally, since $d(v) \geq 5$, we have $\rho_w(v, z) \geq 5 > 4 \geq w(z) + w(zy)$, so zv is automatically satisfied.

Case B: v has two 2^- -neighbors z and z' . By Lemma 2.2, we may assume $d_G(z) = d_G(z') = 2$. By Lemma 2.5, we may assume $zz' \notin E(G)$. Let $G' = G - \{vz, vz'\}$. Since the edges of G' incident to the core must be satisfied in the extension to G , uncolor v, z , and z' .

Subcase 1: $d_G(v) \in \{3, 4\}$. Let $X = N_G(v) - \{z, z'\}$ (see Figure 5). Let $a = \sum_{x \in X} w'(vx)$. If $a \geq 2$, then setting $w(v) = 2$ ensures satisfying vz and vz' . Using $|X| \leq 2$, choose $w(vz)$ and $w(vz')$ to satisfy $\Gamma_{G'}(v)$. Now choose $w(z)$ and $w(z')$ to satisfy yz and $y'z'$, respectively.

Hence we may assume $a = 1$, which requires $d_G(v) = 3$. If $w'(yz) = 1$, then set $w(vz') = 2$ to ensure satisfying vz . Next choose $w(z')$ to satisfy $z'y'$, and then choose $w(v)$ and $w(vz)$ to satisfy vz' and vx . Finally, choose $w(z)$ to satisfy yz .

By symmetry, we may now assume $a = 1$ and $w'(yz) = w'(y'z') = 2$, as in the middle in Figure 5. If $w'(y) = 1$, then we can exchange $w'(y)$ and $w'(yz)$ with no effect on the satisfaction of any edge in $\Gamma_{G'}(y)$ except yz , thereby reaching the case in the preceding paragraph. Hence by symmetry we may also assume $w'(y) = w'(y') = 2$.

Let $b = \rho_w(x, v)$. If $b = 4$, then set $w(zv) = w(v) = w(vz') = 2$ to satisfy vx and ensure satisfying vz and vz' ; then choose $w(z)$ and $w(z')$ to satisfy zy and $z'y'$, respectively. If $b \neq 4$, then set $w(v) = 2$ and $w(z) = w(zv) = w(vz') = w(z') = 1$. By $\overline{\mathbf{A}}$, we have $d_G(y) \geq 2$ and hence $\rho_w(y, z) > 2$, so yz is satisfied (similarly for $y'z'$). These values also satisfy $\Gamma_G(v)$.

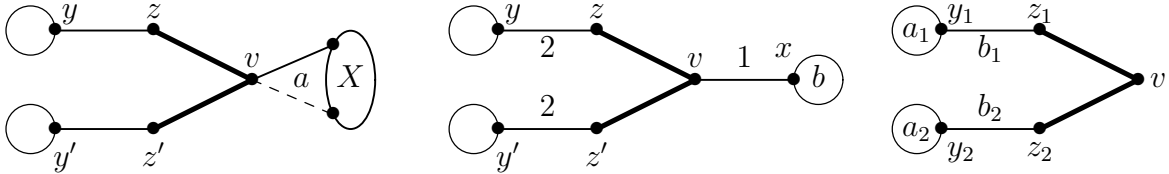

Figure 5: Case **B** for Lemma 3.4

Subcase 2: $d_G(v) = 2$. For this subcase, let $z_1 = z$ and $z_2 = z'$. For $i \in \{1, 2\}$, let $\{y_i\} = N_{G'}(z_i)$, let $b_i = w'(y_i z_i)$, and let $a_i = \rho_w(y_i, z_i)$, as on the right in Figure 2.9. To satisfy $y_i z_i$, fix $w(vz_i) = 3 - w(z_i)$ when a_i is even and $w(vz_i) = w(z_i)$ when a_i is odd. We then must choose $w(z_1)$ and $w(z_2)$ (and hence $w(vz_1)$ and $w(vz_2)$) to satisfy vz_2 and vz_1 . We need $b_1 + w(z_1) \neq w(v) + w(vz_2)$ and $b_2 + w(z_2) \neq w(v) + w(vz_1)$.

When $a_1 - a_2$ is even, set $w(v) = 1$. When a_1 and a_2 are both even, using $w(vz_i) = 3 - w(z_i)$ converts the requirements to $b_1 + w(z_1) \neq 4 - w(z_2)$ and $b_2 + w(z_2) \neq 4 - w(z_1)$. With two choices for both $w(z_1)$ and $w(z_2)$, we can pick them so that $w(z_1) + w(z_2) \notin \{4 - b_1, 4 - b_2\}$. When a_1 and a_2 are both odd, using $w(vz_i) = w(z_i)$ it suffices to choose $w(z_1), w(z_2) \in \{1, 2\}$

so that $w(z_1) - w(z_2) \notin \{1 - b_1, b_2 - 1\}$. Since the difference can be any of the three values in $\{1, 0, -1\}$, this also can be done.

When a_1 and a_2 have opposite parity, we may assume that a_1 is even. Now set $w(v) = 3 - b_1$ and $w(z_1) = w(z_2) = b_1$. Using $w(vz_1) = 3 - w(z_1)$ and $w(vz_2) = w(z_2)$, we have satisfied vz_1 because $b_1 + w(z_1) = 2b_1 \neq 3 = w(v) + w(z_2)$, and we have satisfied vz_2 because $b_2 + w(z_2) = b_2 + b_1 \neq 6 - 2b_1 = w(v) + 3 - w(z_1)$. \square

Theorem 2.10. *If $\text{Mad}(G) < 5/2$, then G has a proper total 2-weighting.*

Proof. By Lemma 2.9, a minimal counterexample contains no configuration listed there. Since it has average degree less than $5/2$, it contains a configuration listed in Lemma 2.7. Configurations **A–D** are all 2-reducible, by **A** and **B** of Lemma 2.9. Hence to show that every graph with $\text{Mad}(G) < 5/2$ contains a 2-reducible configuration, it suffices to show that a 5^+ -vertex v satisfying $3p_1 + p_2 \geq 2d_G(v) - 4$ also satisfies $2p_1 + 2p_2 \geq d_G(v) - 1$. If the desired inequality fails, then subtracting $2p_1 + 2p_2 \leq d_G(v) - 2$ from the given inequality yields $p_1 \geq d_G(v) - 2$. Since $d_G(v) - 2 \geq (d_G(v) - 1)/2$, the desired inequality follows. \square

3 Proper Total 2-weighting when $\text{Mad}(G) < 8/3$

A graph formed by adding a pendant edge at each vertex of a 3-regular graph has average degree $\frac{5}{2}$. It has no configuration in Lemma 2.9, since each 4-vertex has one 1-neighbor and three 4-neighbors. Further 2-reducible configurations will require multiple “almost-reducible” vertices. We introduce two types.

Definition 3.1. A β -vertex is a 3-vertex having exactly one 2-neighbor and no 1-neighbor. A β' -vertex is a $2k$ -vertex, where $k \geq 2$, having exactly $k - 1$ neighbors of degree 1 and no 2-neighbor. For $\gamma \in \{\beta, \beta'\}$, a γ -neighbor of v is a γ -vertex in $N(v)$.

We will show in Lemma 3.4 that various configurations involving such vertices are 2-reducible. Theorem 3.5 shows that these plus the configurations in Lemma 2.9 form an unavoidable set when $\text{Mad}(G) < 8/3$. The argument would be shorter if adjacent β' -vertices of degree 4 formed a reducible configuration, but our usual method fails there.

Example 3.2. Let v and v' be adjacent β' -vertices of degree 4 in G , having 1-neighbors u and u' , respectively. As in Section 2, the core F is $\{uv, vv', v'u'\}$, and $G' = G - F$. A total 2-weighting w' of G' may assign labels as indicated in Figure 6. To extend w' , we need $w(uv) + w(v) + w(vv') \in \{3, 6\}$; hence these three weights must be equal. Similarly, $w(u'v') + w(v') + w(vv') \in \{3, 6\}$. Since $w(vv')$ can take only one value, we have forced $\phi_w(v) = \phi_w(v')$. Hence no extension to a proper total 2-weighting is possible.

Another would-be-useful but non-reducible configuration consists of a β -vertex v whose 2-neighbor z has a 2-neighbor y . A total 2-weighting w' of G' may assign labels as indicated

in Figure 6. The values of ϕ'_w at the neighbors of v other than z force $w(v) = w(vz) = 1$. Now satisfying vz requires $w(z) = w(zv)$. Similarly, satisfying xy requires $w(y) = w(yz)$. We conclude $w(z) = w(y)$, but now yz cannot be satisfied, since also $w(yx) = w(zv)$. \square

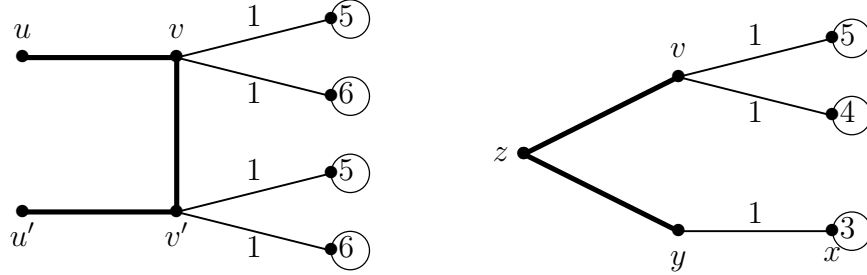

Figure 6: Non-reducible: adjacent β' -vertices, or β -vertex near extra 2-vertex

Graphs formed by adding a pendant edge at each vertex of a 3-regular graph contain only configuration **F** among those in Lemma 3.4. Although its reducibility proof does not require the full flexibility of choosing weights in it, Example 3.2 shows that the local argument cannot be completed when a β' -vertex has only one β' -neighbor (of degree 4).

Example 3.2 also shows that a β -vertex is not reducible, even when its 2-neighbor has another 2-neighbor. Nevertheless, when a β -vertex appears in a minimal 2-bad graph we can guarantee satisfying all but one specified edge at that vertex. This is useful when we can ensure satisfying that edge, such as when its other endpoint has high degree.

Lemma 3.3. *Let v be a β -vertex with 2-neighbor z in a minimal 2-bad graph G . Name vertices so that $N_G(v) = \{z, x, u\}$ and $N_G(z) = \{v, y\}$ (see Figure 7). If $G - vz$ has a proper partial 2-weighting w' that satisfies $\Gamma_G(x)$ and $\Gamma_G(y)$, then G has a partial 2-weighting w that satisfies the same edges other than vu , plus vz , without changing any weights on $G - \{v, z\}$ except possibly on yz and y .*

Proof. Let $G' = G - vz$. By Lemma 2.9A, $d(y) \geq 2$. We want to choose $w(v)$, $w(z)$, and $w(vz)$ to satisfy $\{xv, vz, zy\}$, leaving edges other than vu satisfied.

Let $a = \rho_{w'}(y, z)$. If $a \geq 4$, then setting $w(zv) = 1$ ensures satisfying yz , after which we choose $w(v)$ to satisfy vx and $w(z)$ to satisfy vz .

If $a = 3$ and $d_G(y) = 3$, then $w'(y) = 1$ ($y = u$ is allowed). If $w'(yz) = 2$, then we can exchange the weights on y and yz and apply the previous case. If $w'(yz) = 1$, then setting $w(z) = w(zv) = 1$ satisfies both yz and zv , after which we choose $w(v)$ to satisfy vx .

The remaining case is $d_G(y) = 2$; let $N_G(y) = \{z, u'\}$ ($u' = u$ is allowed). Uncolor y and yz . Setting $w(yz) = 1$ and $w(v) = 2$ ensures satisfying zv . Now choose $w(vz)$ to satisfy vx , $w(y)$ to satisfy yu' , and $w(z)$ to satisfy yz . \square

Lemma 3.4. *The configurations below are 2-reducible.*

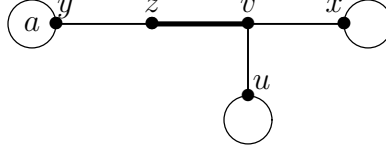

Figure 7: Configuration for Lemma 3.3

- A. A 3^- -vertex having a 1-neighbor.
- B. A 4^- -vertex having two 2^- -neighbors.
- C. A 5^+ -vertex v whose number of 2^- -neighbors is at least $(d_G(v) - 1)/2$.
- D. Two adjacent β -vertices.
- E. A β -vertex with a β' -neighbor.
- F. A β' -vertex of degree 4 having two β' -neighbors of degree 4.
- G. A 3-vertex such that each neighbor is a β -vertex or is a β' -vertex of degree 4.

Proof. Configurations **A–C** were shown to be 2-reducible in Lemma 2.9. For **D–G**, as usual we consider a minimal 2-bad graph G containing the specified configuration, and the derived graph G' is obtained by deleting the core, shown in bold in Figures 8–10. In each case we have a proper total 2-weighting w' of G' and produce a proper total 2-weighting w of G by choosing weights on the deleted edges and on their endpoints, leaving all other weights as in w' , with the possible exception of applying Lemma 3.3. For each successive configuration, we know that the earlier configurations do not occur in G .

Case D: v and v' are adjacent β -vertices. As shown in Figure 8D, v and v' have degree 3, with 2-neighbors z and z' , respectively. Let $N_G(v) = \{z, v', x\}$ and $N_G(v') = \{z', v, x'\}$, also $N_G(z) = \{v, y\}$ and $N_G(z') = \{v, y'\}$ ($y = y'$ and/or $x = x'$ are allowed in the argument). By Lemma 2.5, we may assume $z \neq z'$, $y \neq x$, and $y' \neq x'$. Let $G' = G - \{zv, vv', v'z'\}$.

Consider first the degenerate case $zz' \in E(G)$, so $y = z'$ and $y' = z$. This also handles the case $y = x'$ or $y' = x$ under appropriate relabeling. Set $w(zz') = 1$ and $w(vv') = 2$ to ensure satisfying zv and $z'v'$. Set $w(z) = w(zv) = 2$. Now choose $w(v)$ to satisfy zv , choose $w(v')$ and $w(v'z')$ to satisfy vv' and $v'x'$, and choose $w(z')$ to satisfy zz' .

Hence we may assume that the vertices are distinct as on the left in Figure 8D. Let $a = w'(zy)$, $b = \rho_{w'}(y, z)$, $c = w'(vx)$, and $d = \rho_{w'}(x, v)$. Define a', b', c', d' analogously using y', z', v', x' . In all subcases, set $w(vv') = 2$.

Subcase 1: $d_G(y) = 2$ (or $d_G(y') = 2$). Let $N_G(y) = \{z, u\}$. Uncolor u and yu . Treat $y = z'$ (which implies $u = v'$) as a special case. When $y = z'$, set $w(zz') = w(z') = 1$; in general, set $w(z) = w(z') = 1$. In both cases, this ensures satisfying vz and $v'z'$ (since $w(vv') = 2$). Now set $w(v'z') = 1$ when $y = z'$; otherwise choose $w(v'z')$ to satisfy $y'z'$. In both cases, next choose $w(v')$ to satisfy $v'x'$, then $w(v)$ and $w(vz)$ to satisfy vv' and vx . Finally, choose $w(z)$ to satisfy zz' when $y = z'$; otherwise, choose $w(u)$ to satisfy yu and

then $w(yu)$ to satisfy the other edge at u .

Subcase 2: $d_G(y) \neq 2$. By \bar{A} , we may assume $d(y) \geq 3$. If $c = 2$ or $a = 1$, then $w(vv') = 2$ ensures satisfying zv . Set $w(v') = 2$ to guarantee satisfying $z'v'$. Now choose $w(z'v')$ to satisfy $v'x'$, and choose $w(z')$ to satisfy $z'y'$. Next choose $w(zv)$ and $w(v)$ to satisfy vx and vv' . Finally, choose $w(z)$ to satisfy zy .

We may therefore assume $c = 1$ and $a = 2$, and by symmetry $c' = 1$ and $a' = 2$. We may also assume $w'(y) = w'(y') = 2$, since otherwise we can switch weights on y and yz (or on y' and $y'z'$), which leaves the other edges at y or y' satisfied and yields the subcase above.

With $d_G(y) \geq 3$, we have $b \geq 4$ (since $w'(y) = 2$). By symmetry, $d_G(y') \geq 3$ and $b' \geq 4$. Now setting $w(z) = w(z') = 1$ ensures satisfying $\Gamma_G(z)$ and $\Gamma_G(z')$ (since $w(vv') = 2$). Finally, choose $w(zv) + w(v)$ to avoid $d - 2$ and $w(z'v') + w(v')$ to avoid $d' - 2$ (allowing two choices for each sum) so that the sums are different. This satisfies vx , $v'x'$, and vv' .

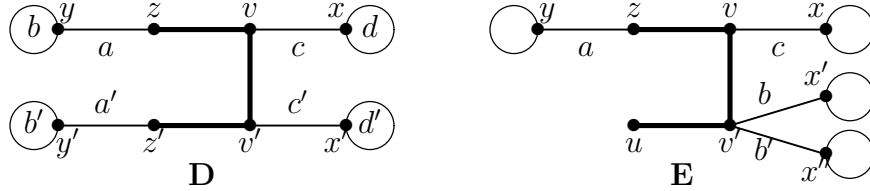

Figure 8: Cases **D** and **E** for Lemma 3.4

Case E: v is a β -vertex with a β' -neighbor v' . Let z be the 2-neighbor of v , with $N_G(v) = \{x, z, v'\}$ and $N_G(z) = \{y, v\}$.

If $d_G(v') \geq 6$, then let U be the set of 1-neighbors of v' . Set $w(v') = 2$ to guarantee satisfying vv' (since now $\rho_w(v', v) \geq 7 > 6 \geq \rho_w(v, v')$). Including vv' , the number of remaining edges incident to v' with unchosen weights equals the number of edges from v' to $N_G(v') - U$; by Lemma 2.3, we can choose these weights to satisfy these edges. The edges of $[v, U]$ are automatically satisfied, regardless of the weights on U . Finally, now that $w(vv')$ is chosen, Lemma 3.3 allows us to complete w to a proper 2-weighting of G .

We may therefore assume $d_G(v') = 4$, as in Figure 8E. Let u be the 1-neighbor of v' . Let $G' = G - \{zv, vv', v'u\}$, leaving $v'x', v'x'' \in E(G')$. Let $a = w'(zy)$, $b = w'(v'x')$, $b' = w'(v'x'')$, and $c = w'(vx)$. The argument allows $y \in \{x', x''\}$. Fix $w(u) = 1$.

If $b + b' - c \geq 2$, then requiring $w(v) + w(zv) = 3$ guarantees satisfying $v'v$. Next choose $w(v'v)$ to satisfy vx , and choose $w(v')$ and $w(v'u)$ to satisfy $v'x'$ and $v'x''$. With $w(v) = 3 - w(zv)$, there are three choices for $w(zv) + w(z)$, so we can choose $w(zv)$ and $w(z)$ with $w(z) + w(zv) \neq \rho_w(y, z)$ to satisfy yz and $w(z) + a \neq 3 - w(zv) + c + w(vv')$ to satisfy zv . We may therefore assume $b + b' - c \leq 1$.

If $c = 2$ or $a = 1$, then requiring $w(v) + w(vv') = 3$ guarantees satisfying zv . Now choose $w(zv)$ to satisfy vx and then $w(z)$ to satisfy zy . Finally, tentatively set $w(vv') = 2$ and $w(v) = 1$, and then choose $w(v')$ and $w(v'u)$ to satisfy $v'x'$ and $v'x''$. If vv' is not now

satisfied, then $w(v') + w(v'u) < 4$. Now exchange weights on vv' and v while increasing $w(v')$ or $w(v'u)$ to satisfy vv' and preserve the satisfaction of $v'x'$ and $v'x''$.

Hence we may assume $c = 1$ and $a = 2$. Since also $b + b' - c \leq 1$, we have $b = b' = 1$. Tentatively set $w(v'u) = 2$, and choose $w(v')$ and $w(vv')$ to satisfy $v'x'$ and $v'x''$, with $w(v') \geq w(vv')$. If $w(v') = 2$, then vv' is automatically satisfied (since $c = 1$), and Lemma 3.3 completes the extension to w . If $w(v') = 1$ and the application of Lemma 3.3 produces $w(zv) = w(v) = 2$, then vv' is not satisfied. In this case, $\rho_{w'}(x', v'), \rho_{w'}(x'', v') = \{6, 7\}$, and changing $w(v'u)$ to 1 satisfies vv' while still satisfying $v'x'$ and $v'x''$.

Case F: v is a β' -vertex of degree 4 with β' -neighbors z and z' of degree 4. Let $N_G(v) = \{x, u, z, z'\}$. Let u, y, y' be the 1-neighbors of v, z, z' , respectively. (see Figure 9).

Subcase 1: $zz' \in E(G)$. In this case, we have a triangle of β' -vertices having degree 4. Let $G' = G - \{vz, vz', zz', vu, zy, z'y'\}$. Let t and t' be the remaining neighbors of z and z' , respectively. By symmetry, we need only consider two cases: $w'(zt) \neq w'(z't')$, and the case $w'(zt) = w'(z't') = w'(vx) = c$.

If $w'(zt) \neq w'(z't')$, then by symmetry we may assume $w'(zt) = 1$ and $w'(z't') = 2$. Set $w(zz') = w(z') = w(z'v) = 2$ and $w(zv) = w(v) = 1$ to ensure satisfying zz' and $z'v$. Now choose $w(vu)$ to satisfy $\Gamma_{G'}(v)$ and choose $w(z'y')$ to satisfy $\Gamma_{G'}(z')$. Finally, choose $w(z)$ and $w(zy)$ to satisfy zv and $\Gamma_{G'}(z)$.

In the other case, let $w(vu) = w(v) = w(vz) = w(vz') = a$. Choose a to satisfy vx . Let $w(zz') = 3 - a$; this ensures satisfying vz and vz' . With $w(z')$ arbitrary, choose $w(z'y')$ to satisfy $z't'$, and finally choose $w(z)$ and $w(zy)$ to satisfy zz' and zt .

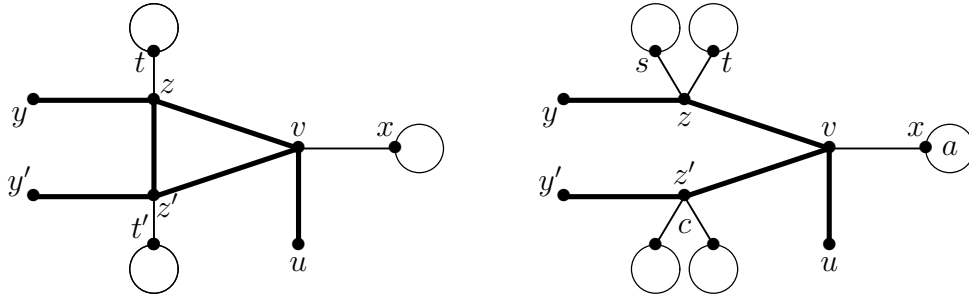

Figure 9: Cases **F1** and **F2** for Lemma 3.4

Subcase 2: $zz' \notin E(G)$. Let $G' = G - \{yz, zv, vu, vz', z'y'\}$. Let $a = \rho_{w'}(x, v)$. If $a \neq 6$, then requiring $w(v) + w(vz') = 3$ and $w(vz) + w(vu) = 3$ satisfies xv , with $w(vz')$ and $w(vz)$ still choosable freely. Choose $w(zy)$, $w(z)$, and $w(vz)$ so that their sum avoids $\{\rho_{w'}(s, z), \rho_{w'}(t, z)\}$, where $\{s, t\} = N_{G'}(z)$, and so that $w(zy) + w(z) + w'(sz) + w'(tz) \neq 3 - w(vz) + w(v) + w(vz') + w'(vx)$ (to satisfy vz). Since $w(v) + w(vz') = 3$, there are three constants for $w(zy) + w(z) + w(vz)$ to avoid, so such a choice exists. Finally, choose $w(vz')$, $w(z')$, and $w(z'y')$ to satisfy vz and $\Gamma_{G'}(z)$, again making their sum avoid three known values.

Hence we may assume $a = 6$. Now choosing $w(v) = w(vu) = w(vz)$ guarantees satisfying vx ; let b denote the value to be chosen for them. Let c be the total weight assigned by w' to $\Gamma_{G'}(z')$. If $c = 2$, or if $c = 3$ and $w(vx) = 2$, then let $b = 2$. Otherwise, let $b = 1$. In either case, vz' is guaranteed to be satisfied. Finally, choose $w(z)$ and $w(zy)$ to satisfy zs and zt , choose $w(vz')$ to satisfy vz , and choose $w(z')$ and $w(z'y')$ to satisfy $\Gamma_{G'}(z')$.

Case G: v is a 3-vertex with neighbors z_1, z_2, z_3 (where $d_G(z_1) \geq d_G(z_2) \geq d_G(z_3)$) such that each is a β -vertex or is a β' -vertex of degree 4. For $i \in \{1, 2, 3\}$, let y_i be the neighbor of z_i with degree $5 - d_G(z_i)$. When $d_G(z_i) = 3$, let x_i be the other neighbor of z_i and let y'_i be the other neighbor of y_i . When $d_G(z_i) = 4$, let $\{x_i, x'_i\} = N_G(z_i) - \{v, y_i\}$.

We first reduce to the case where $N_G(v)$ is independent. Adjacent β -vertices are forbidden by $\overline{\mathbf{D}}$. Adjacent β - and β' -vertices are forbidden by $\overline{\mathbf{E}}$.

The third possibility is that z and z' are adjacent β' -vertices having a common 3-neighbor v . The situation is illustrated by deleting u from the left graph in Figure 9. Label the vertices as described there, with $G' = G - \{vz, vz', zz', zy, z'y'\}$. If $w'(zt) = 2$ or $w'(vx) = 1$, then set $w(vz) = w(vz') = 1$ and $w(z') = w(zz') = 2$ to ensure satisfying vz and vz' . Choose $w(v)$ to satisfy vx , choose $w(z'y')$ to satisfy $z't'$, and choose $w(z)$ and $w(zy)$ to satisfy zt and zz' .

By symmetry, we may now assume $w'(zt) = w'(z't') = 1$ and $w'(vx) = 2$. Also, $w'(x) = 2$, or we can switch the weights on x and vx to reach the case just discussed. Now, using $d(x) \geq 3$ (since x is a β - or β' -neighbor of v), we have $\rho_{w'}(x, v) \geq 4$. Now set $w(zv) = w(v) = w(vz') = 1$ and $w(zz') = 2$ to satisfy vx and ensure satisfying vz and vz' . Finally, set $w(z') = 1$, choose $w(z'y')$ to satisfy $z't'$, and choose $w(z)$ and $w(zy)$ to satisfy zt and zz' .

Hence we may assume that $N_G(v)$ is independent. If two β -vertices in $N_G(v)$ have a common 2-neighbor, say z_1 and z_2 with common 2-neighbor y , then let $G' = G - \{vz_1, vz_2, z_1y, z_2y\}$. Set $w(vz_1) = w(vz_2) = 2$ and $w(y) = 1$ to ensure satisfying z_1y and z_2y . Now choose $w(v)$ to satisfy vz_3 , choose $w(z_1)$ and $w(z_1y)$ to satisfy vz_1 and $\Gamma_{G'}(z_1)$, and choose $w(z_2)$ and $w(z_2y)$ to satisfy vz_2 and $\Gamma_{G'}(z_2)$.

Now $N_G(v)$ independent and the 2-neighbors of β -neighbors of v are distinct. The remaining cases are shown in Figure 10. The argument does not require the vertices on circles to be distinct. Let Subcase j be the situation where j neighbors of v are β' -vertices. In each subcase, the deleted core consists of $\Gamma_G(v)$ and $\{z_1y_1, z_2y_2, z_3y_3\}$. To obtain w from w' , we must satisfy these six edges and six additional edges incident to them. We have the freedom to choose weights on the six deleted edges and their seven incident vertices.

We define operation S_i to satisfy the edges in the i th ‘‘branch’’ when $w(vz_i)$ has been specified. If $d_G(z_i) = 3$, then S_i uses Lemma 3.3 to choose $w(z_i)$, $w(z_iy_i)$, and $w(y_i)$ (plus possible changes to weights on $y_iy'_i$ and y'_i but not on z_ix_i or z_iv) so that z_ix_i , z_iy_i , and $y_iy'_i$ become satisfied. If $d_G(z_i) = 4$, then S_i chooses $w(z_i)$ and $w(z_iy_i)$ to satisfy z_ix_i and $z_ix'_i$. (When $d_G(z_i) = 4$, automatically z_iy_i is satisfied, and $w(y_i)$ is irrelevant.)

Subcase 0: Set $w(v) = w(vz_1) = w(vz_2) = w(vz_3) = 2$, and consider $i \in \{1, 2, 3\}$.

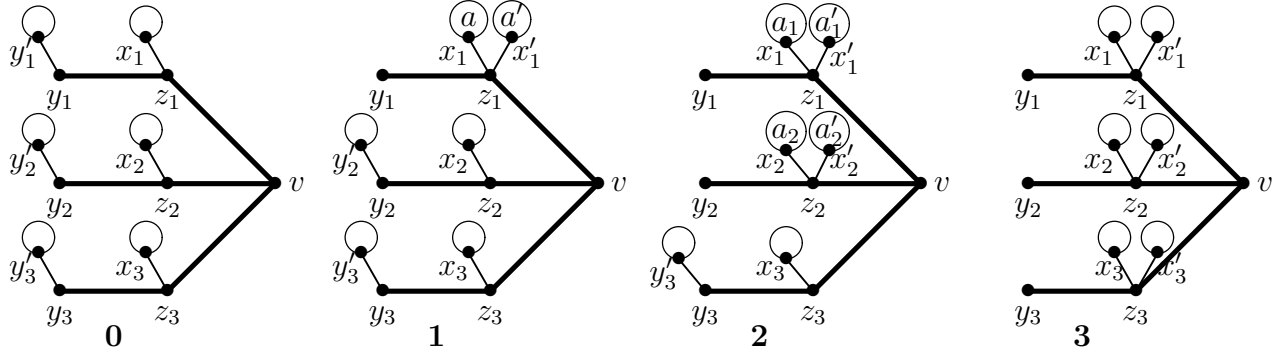

Figure 10: Case G for Lemma 3.4

If $w'(x_i z_i) = 1$, then $z_i v$ is automatically satisfied; apply S_i . If $w'(x_i z_i) = 2$, then $z_i y_i$ is automatically satisfied. Set $w(z_i) = 1$ to satisfy $z_i v$. Choose $w(z_i y_i)$ to satisfy $z_i x_i$, and choose $w(y_i)$ to satisfy $y_i y_i'$.

Subcase 1: Let $a = \rho_{w'}(x_1, z_1)$ and $a' = \rho_{w'}(x_1', z_1)$. When $w'(z_1 x_1) = w'(z_1 x_1') = 1$ and $\{a, a'\} = \{6, 7\}$, set $w(z_3 v) = w(z_2 v) = 2$. Otherwise, set $w(z_3 v) = w(z_2 v) = 1$. With $w(z_3 v)$ and $w(z_2 v)$ fixed, apply S_2 and S_3 . Now choose $w(v)$ and $w(v z_1)$ to satisfy $v z_2$ and $v z_3$, with $w(v) \leq w(v z_1)$.

If we have set $w(z_3 v) = w(z_2 v) = 2$, then $w'(z_1 x_1) = w'(z_1 x_1') = 1$; satisfy $v z_1$ by setting $w(z_1) = w(z_1 y_1) = 1$. Since $\{a, a'\} = \{6, 7\}$, this also satisfies $\Gamma_{G'}(z_1)$.

If we have set $w(z_3 v) = w(z_2 v) = 1$, then $w'(z_1 x_1) + w'(z_1 x_1') \geq 3$ or $\{a, a'\} \neq \{6, 7\}$. In the first case, $v z_1$ is automatically satisfied; apply S_1 . In the second, $w(z_3 v) = w(z_2 v) = w'(z_1 x_1) = w'(z_1 x_1') = 1$ and $\{a, a'\} \neq \{6, 7\}$; choose $b \in \{6, 7\} - \{a, a'\}$. If $w(v) = 1$, then $v z_1$ is automatically satisfied; apply S_1 . Otherwise, $w(v) = w(v z_1) = 2$, since we chose $w(v) \leq w(v z_1)$. Now choose $w(z_1)$ and $w(z_1 y_1)$ with sum $b - 3$. This satisfies $v z_1$ and $\Gamma_{G'}(z_1)$.

Subcase 2: Set $w(z_3 v) = 1$. With $w(z_3 v)$ fixed, apply S_3 . If $w'(z_1 x_1) = 2$, then setting $w(z_1 v) = w(v) = 1$ ensures satisfying $z_1 v$ and $z_2 v$; choose $w(z_2 v)$ to satisfy $v z_3$ and apply S_1 and S_2 . By symmetry, we may thus assume $w'(z_i x_i) = w'(z_i x_i') = 1$ for $i \in \{1, 2\}$.

If $w(z_3) + w'(z_3 x_3) + w(z_3 y_3) > 3$, then setting $w(v) = w(v z_2) = w(v z_1) = 1$ satisfies $v z_3$ and ensures satisfying $v z_2$ and $v z_1$; apply S_2 and S_1 . Hence we may also assume $w(z_3) + w'(z_3 x_3) + w(z_3 y_3) = 3$. Let $a_i = \rho_{w'}(x_i, z_i)$ and $a_i' = \rho_{w'}(x_i', z_i)$, for $i \in \{1, 2\}$.

If $\{a_1, a_1'\} \neq \{5, 6\}$, then set $w(v z_1) = w(v) = 1$ and $w(v z_2) = 2$. Now $v z_3$ is satisfied and $v z_2$ is automatically satisfied; apply S_2 . Choose $b \in \{5, 6\} - \{a_1, a_1'\}$. Choose $w(z_1)$ and $w(z_1 y_1)$ summing to $b - 2$. This satisfies $v z_1$ and $\Gamma_{G'}(z_1)$.

By symmetry, we may thus assume $\{a_1, a_1'\} = \{a_2, a_2'\} = \{5, 6\}$. Let $w(v) = 2$ and $w(v z_i) = w(z_i) = w(z_i y_i) = 2$ for $i \in \{1, 2\}$ to satisfy all remaining edges.

Subcase 3: Set $w(v) = w(v z_1) = w(v z_2) = w(v z_3) = 1$ to guarantee satisfying each $v z_i$. Now for each i choose $w(y_i z_i)$ and $w(z_i)$ to satisfy $z_i x_i$ and $z_i x_i'$. \square

Case **F** and Case **G** in Lemma 3.4 can be generalized. If v in the former case or z_i in the latter is a β' -vertex of any even degree, then the configuration remains 2-reducible. We omit this since it is not needed to prove the 1,2-Conjecture for $\text{Mad}(G) < 8/3$; the more restrictive configurations in the lemma complete an unavoidable set.

Lemma 3.5. *If G has average degree less than $8/3$, then G contains one of the following:*

- A.** *A 3^- -vertex having a 1-neighbor.*
- B.** *A 4^- -vertex having two 2^- -neighbors.*
- C.** *A 5^+ -vertex v whose number of 2^- -neighbors is at least $(d_G(v) - 1)/2$.*
- D.** *Two adjacent β -vertices.*
- E.** *A β -vertex with a β' -neighbor.*
- F.** *A β' -vertex of degree 4 having two β' -neighbors of degree 4.*
- G.** *A 3-vertex such that each neighbor is a β -vertex or is a β' -vertex of degree 4.*

Proof. We prove that a graph G containing none of **A-G** has average degree at least $8/3$. Give every vertex v in G initial charge $d_G(v)$. Move charge via the following rules:

- (1) Each 1-vertex takes $\frac{5}{3}$ from its neighbor.
- (2) Each 2-vertex takes $\frac{2}{3}$ from one 3^+ -neighbor.
- (3) Each 3-vertex with a 2-neighbor takes $\frac{1}{6}$ from each other neighbor.
- (4) Each 4-vertex with a 1-neighbor takes $\frac{1}{6}$ from each other neighbor not a β' -vertex.

Let $\mu(v)$ denote the resulting charge at v ; it suffices to check that $\mu(v) \geq \frac{8}{3}$ for all v . For $\mathbf{Z} \in \{\mathbf{A}, \dots, \mathbf{G}\}$, let $\overline{\mathbf{Z}}$ mean “configuration \mathbf{Z} does not occur in G ”. Note that by $\overline{\mathbf{B}}$, the vertex taking charge in Rule 3 or Rule 4 is a β -vertex or a β' -vertex, respectively.

Case $d(v) = 1$: By Rule 1, v receives $\frac{5}{3}$ and has final charge $\frac{8}{3}$.

Case $d(v) = 2$: By $\overline{\mathbf{A}}$ and $\overline{\mathbf{B}}$, v gives no charge and receives $\frac{2}{3}$ from a 3^+ -neighbor.

Case $d(v) = 3$: By $\overline{\mathbf{A}}$, v has no 1-neighbor. If v also has no 2-neighbor, then by $\overline{\mathbf{G}}$ at most two neighbors take charge $\frac{1}{6}$ from it, so $\mu(v) \geq \frac{8}{3}$. If v has a 2-neighbor, then by $\overline{\mathbf{B}}$ it is a β -vertex, has only one 2-neighbor, and may give $\frac{2}{3}$ to that 2-neighbor. By $\overline{\mathbf{D}}$ and $\overline{\mathbf{E}}$, v loses no other charge. If v does loses $\frac{2}{3}$, then v needs to regain $\frac{1}{3}$ and does so via Rule 3.

Case $d(v) = 4$: By $\overline{\mathbf{B}}$, v has at most one 2^- -neighbor. If v has no 1-neighbor, then v loses at most $\frac{2}{3} + \frac{3}{6}$. Hence in this case $\mu(v) > \frac{8}{3}$. If v has a 1-neighbor, then v loses $\frac{5}{3}$ to it and is a β' -vertex. By $\overline{\mathbf{E}}$ and $\overline{\mathbf{F}}$, v has no β -neighbor and at most one β' -neighbor. Hence it gives away no other charge and receives at least $\frac{2}{6}$ to reach $\mu(v) \geq \frac{8}{3}$.

Case $d(v) \geq 5$: By $\overline{\mathbf{C}}$, v has at most $\frac{d(v)-2}{2}$ 2^- -neighbors. If the inequality is strict, then v gives at most $\frac{5}{3} \frac{d(v)-3}{2}$ to those vertices and at most $\frac{1}{6}$ to each other neighbor, yielding

$$\mu(v) \geq d(v) - \frac{5}{3} \frac{d(v) - 3}{2} - \frac{1}{6} \frac{d(v) + 3}{2} = \frac{d(v)}{12} + \frac{9}{4} \geq \frac{32}{12} = \frac{8}{3}.$$

If v has exactly $\frac{d(v)-2}{2}$ 2^- -neighbors and at least one of them is a 2-vertex, then $d(v) \geq 6$ and

$$\mu(v) \geq d(v) - \frac{5}{3} \frac{d(v) - 4}{2} - \frac{2}{3} - \frac{1}{6} \frac{d(v) + 2}{2} = \frac{d(v)}{12} + \frac{8}{3} - \frac{1}{6} > \frac{8}{3}.$$

In the remaining case, v is a β' -vertex with degree at least 6. By definition, v has $\frac{d(v)-2}{2}$ 1-neighbors and no 2-neighbor. By $\overline{\mathbf{E}}$, v has no β -neighbor. By Rules 3 and 4, v gives charge only to its 1-neighbors. Hence

$$\mu(v) \geq d(v) - \frac{5}{3} \frac{d(v) - 2}{2} = \frac{d(v)}{6} + \frac{5}{3} \geq \frac{8}{3}. \quad \square$$

Since every configuration in Lemma 3.5 is listed in Lemma 3.4, the following is proved.

Theorem 3.6. *The 1,2-Conjecture holds for each graph G such that $\text{Mad}(G) < 8/3$.*

4 Proper 3-weighting when $\text{Mad}(G) < 8/3$

For the discussion of proper 3-weightings, again it will be helpful to have notation for special types of vertices. The definition of β -vertex is the same as before, but instead of β' -vertices we introduce α -vertices and γ -vertices.

Definition 4.1. An α -vertex is a 2 vertex with a 2-neighbor. A β -vertex is a 3-vertex with a 2-neighbor. A γ -vertex is a 4-vertex with a 1-neighbor or is a 3-vertex with an α -neighbor or two 2-neighbors.

Lemma 4.2. *If G has average degree less than $8/3$, then G contains one of the following:*

- A. A 2-vertex or 3-vertex having a 1-neighbor.
- B. A 4^- -vertex whose neighbors all have degree 2.
- C. A 3-vertex having an α -neighbor and another 2-neighbor.
- D. A 4-vertex having a 1-neighbor and a 2^- -neighbor.
- E. A 5^+ -vertex v with $3p_1 + 2p_2 \geq d(v)$, where p_i is the number of i -neighbors of v .
- F. Two adjacent γ -vertices.
- G. A 3-vertex with two γ -neighbors.
- H. A 6-vertex or 7-vertex having a 1-neighbor and four γ -neighbors.
- I. A 5-vertex having a 1-neighbor and three γ -neighbors.
- J. A 4-vertex with $p+q+r \geq 5$, where p, q, r are its numbers of 2-neighbors, γ -neighbors, and α -neighbors, respectively.
- K. A γ -vertex whose 3^+ -neighbors are all β -vertices.

Proof. We prove that a graph G containing none of **A-K** has average degree at least $8/3$. Give every vertex v in G initial charge $d(v)$. Move charge via the following rules:

- (1) Each 1-vertex takes $\frac{5}{3}$ from its neighbor.
- (2) Each α -vertex takes $\frac{2}{3}$ from its 3^+ -neighbor.
- (3) Each 2-vertex that is not an α -vertex takes $\frac{1}{3}$ from each neighbor.
- (4) Each γ -vertex takes $\frac{1}{3}$ from each 3^+ -neighbor that is not a β -vertex.

Let $\mu(v)$ denote the resulting charge at v ; it suffices to check that $\mu(v) \geq \frac{8}{3}$ for all v . For $\mathbf{Z} \in \{\mathbf{A}, \dots, \mathbf{K}\}$, let $\overline{\mathbf{Z}}$ mean ‘‘configuration \mathbf{Z} does not occur in G ’’. Fix a vertex v and let p_i , q , and r count its i -neighbors, γ -neighbors, and α -neighbors, respectively.

Case $d(v) = 1$: By Rule 1, v receives $\frac{5}{3}$ and has final charge $\frac{8}{3}$.

Case $d(v) = 2$: By $\overline{\mathbf{A}}$, v gives no charge; via Rule 2 or Rule 3, v receives $\frac{2}{3}$.

Case $d(v) = 3$: By $\overline{\mathbf{A}}$ and $\overline{\mathbf{B}}$, v has no 1-neighbor and at most two 2-neighbors.

If v has no 2-neighbor, then v is not a γ -vertex or a β -vertex. It loses nothing via Rule 2 or 3, and via Rule 4 it gives $\frac{1}{3}$ to each γ -neighbor. By $\overline{\mathbf{G}}$, v loses at most $\frac{1}{3}$, and $\mu(v) \geq \frac{8}{3}$.

If v has a 2-neighbor, then v is a β -vertex and loses nothing via Rule 4. By $\overline{\mathbf{B}}$ and $\overline{\mathbf{C}}$, v gives at most $\frac{2}{3}$ to its 2-neighbors, with equality only if it is a γ -vertex. In this case, by $\overline{\mathbf{A}}$ and $\overline{\mathbf{B}}$, v has a 3^+ -neighbor u . By $\overline{\mathbf{F}}$, u is not a γ -vertex, and by $\overline{\mathbf{K}}$ not all choices of u are β -vertices. Hence from some 3^+ -neighbor v receives $\frac{1}{3}$, and $\mu(v) \geq \frac{8}{3}$.

Case $d(v) = 4$: If v has a 1-neighbor, then v is a γ -vertex. By $\overline{\mathbf{D}}$ it has no other 2^- -neighbor and loses at most $\frac{5}{3}$. Its other neighbors are 3^+ -vertices. By $\overline{\mathbf{F}}$, none is a γ -vertex, and by $\overline{\mathbf{K}}$ they are not all β -vertices. Hence v receives at least $\frac{1}{3}$ via Rule 4, and $\mu(v) \geq \frac{8}{3}$.

If v has no 1-neighbor, then v is not a γ -vertex. By $\overline{\mathbf{J}}$, $p + q + r \leq 4$. An α -neighbor contributes to both p and r . Hence v loses exactly $(p + q + r)/3$, yielding $\mu(v) \geq \frac{8}{3}$.

Case $d(v) \geq 5$: The charge lost by v is $\frac{1}{3}(5p_1 + p_2 + q + r)$. Hence v is happy if $5p_1 + p_2 + q + r \leq 3d(v) - 8$. Also, configurations with $3p_1 + 2p_2 \geq d(v)$ are forbidden, by $\overline{\mathbf{E}}$. Hence if v is not happy and is not in a configuration forbidden by $\overline{\mathbf{E}}$, then

$$5p_1 + p_2 + q + r \geq 3d(v) - 7 \quad \text{and} \quad 3p_1 + 2p_2 \leq d(v) - 1. \quad (1)$$

Since $r \leq p_2$ and $q \leq d(v) - p_1$, the first inequality above yields $4p_1 + 2p_2 \geq 2d(v) - 7$. Eliminating $2p_2$ from the two inequalities then yields $2d(v) - 7 - 4p_1 \leq d(v) - 1 - 3p_1$, which simplifies to $d(v) - 6 \leq p_1$. Since also $p_1 \leq \lfloor (d(v) - 1)/3 \rfloor$, we obtain $d(v) \leq 8$.

If $p_1 = 0$, then substituting $q + r \leq d(v)$ in (1) yields $(d(v) - 1)/2 \geq 2d(v) - 7$, which simplifies to $d(v) \leq 13/3$. Hence we may assume $p_1 \geq 1$. We consider below the remaining unexcluded possibilities for (p_1, p_2, r, q) . In each case these are the choices allowed by (1).

For $d(v) = 5$, the remaining case is $(1, 0, 0, q)$ with $q \in \{3, 4\}$, forbidden by $\overline{\mathbf{I}}$.

For $d(v) = 6$, the remaining case is $(1, 1, 1, 4)$, forbidden by $\overline{\mathbf{H}}$.

For $d(v) = 7$, the case $(1, p_2, r, q)$ requires $p_2 \leq 1$, which yields $5p_1 + 2p_2 + q \leq 12 < 14$, so v remains happy. Hence the remaining case is $(2, 0, 0, q)$ with $q \in \{4, 5\}$, forbidden by $\overline{\mathbf{H}}$.

For $d(v) = 8$, with $p_1 \leq 2$ and $3p_1 + 2p_2 \leq 7$, we have $5p_1 + 2p_2 \leq 10$. At most $16/3$ is lost, and hence $\mu(v) \geq \frac{8}{3}$. \square

The next lemma explains the role of γ -vertices.

Lemma 4.3. *Let v be a γ -vertex having a 3^+ -neighbor x . Define $F \subseteq E(G)$ as follows:*

$F = \{vu\}$ if v is a 4-vertex with 1-neighbor u ,

$F = \{vz, vz'\}$ if v is a 3-vertex with 2-neighbors z and z' ,

$F = \Gamma_G(z)$ if v is a 3-vertex with α -neighbor z .

Given any weighting of $G - F$, weights in $\{1, 2, 3\}$ can be chosen on F to satisfy all edges in F or incident to edges of F except vx , without changing the weights on edges not in F .

Proof. Figure 11 shows F in bold; the weight on vx is fixed. When v is a 4-vertex, choose $w(vu)$ to satisfy the two edges from v to $N_G(v) - \{x, u\}$. When v is a 3-vertex with 2-neighbors z and z' having neighbors y and y' other than v , choose $w(vz)$ to satisfy vz' and zy , and choose $w(vz')$ to satisfy vz and $z'y'$. When v is a 3-vertex with α -neighbor z having neighbor y other than v , let x' and y' be the remaining neighbors of v and y . Choose $w(vz)$ to satisfy vx' and zy , and choose $w(zy)$ to satisfy vz and yy' . \square

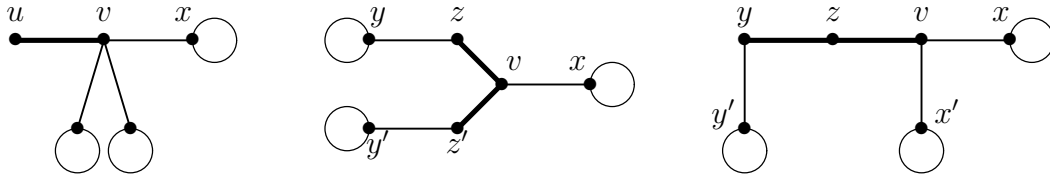

Figure 11: Three cases for Lemma 4.3, with F in bold

In employing Lemma 4.3, the difficulty is ensuring that the edge vx will be satisfied. Generally, we will need to ensure that some edge is satisfied regardless of the choice of weight on some incident edge. When v is a γ -vertex, let F_v denote the set of one or two edges designated as F in Lemma 4.3 (bold in Figure 11).

Like Lemma 2.5, the next lemma excludes degenerate cases for the reducibility proofs.

Lemma 4.4. *Let z and z' be β -vertices having respective 2-neighbors y and y' that are equal or adjacent. The following cases lead to 3-reducible configurations:*

(1) $zz' \in E(G)$.

(2) z and z' have a common neighbor v with a 1-neighbor u , such that $d_G(v) \in \{4, 5\}$.

Proof. See Figure 12 for these cases.

(1) Suppose $zz' \in E(G)$. If $y = y'$, then Lemma 2.5 applies. If $yy' \in E(G)$, then let $G' = G - \{zz', zy, yy', z'y'\}$. Set $w(yy') = 1$ to ensure satisfying zy and $z'y'$. Set $w(zy) = 1$.

Now choose $w(z'y')$ to satisfy yy' and zz' , and choose $w(zz')$ to satisfy zx and $z'x'$, where $N_G(z) = \{z', y, x\}$ and $N_G(z') = \{z, y', x'\}$ ($x = x'$ is allowed).

(2) By Case (1), we may assume $zz' \notin E(G)$, so $x \neq z'$ and $x' \neq z$.

(2a) If $y = y'$, then let $G' = G - \{vz, vz', zy, z'y', vu\}$. Set $w(zy) = w(z'y') = 1$ to ensure satisfying zy and $z'y'$. Next choose $w(zv) \in \{2, 3\}$ to satisfy zx and choose $w(z'v) \in \{2, 3\}$ to satisfy $z'x'$. To ensure satisfying vz and vz' , we now choose $w(vu)$ to satisfy $\Gamma_{G'}(v)$ (if $d_G(v) = 5$) or $w(vu) \in \{2, 3\}$ to satisfy $\Gamma_{G'}(v)$ (if $d_G(v) = 4$).

(2b) If $yy' \in E(G)$, then let $G' = G - \{vz, vz', zy, z'y', yy', vu\}$. Set $w(yy') = 1$ to ensure satisfying zy and $z'y'$. Set $w(zy) = 1$ and $w(vz') = 3$ to ensure satisfying zv . Next choose $w(z'y')$ to satisfy yy' and $z'x'$. Two choices of $w(vz)$ will satisfy zx . Along with the three choices available for $w(vu)$ these choices can be made to satisfy vz' and $\Gamma_{G'}(v)$. \square

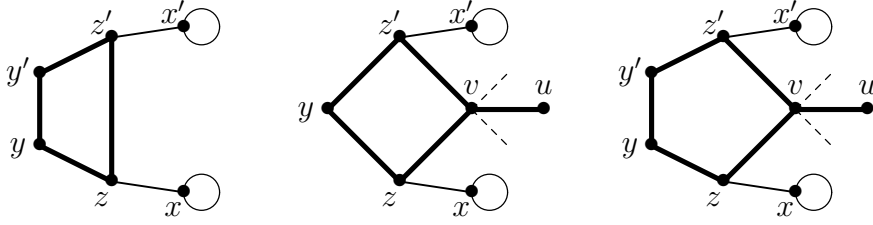

Figure 12: Three cases for Lemma 4.4

Lemma 4.5. *The following configurations are 3-reducible.*

- A. A 2-vertex or 3-vertex having a 1-neighbor.
- B. A 4⁻-vertex whose neighbors all have degree 2.
- C. A 3-vertex having an α -neighbor and another 2-neighbor.
- D. A 4-vertex having a 1-neighbor and a 2⁻-neighbor.
- E. A 5⁺-vertex v with $3p_1 + 2p_2 \geq d(v)$, where p_i is the number of i -neighbors of v .
- F. Two adjacent γ -vertices.
- G. A 3-vertex with two γ -neighbors.
- H. A vertex v such that $p_1 + 2q \geq d(v)$ and $p_1 + q > 4$, where p_1 is the number of 1-neighbors and q is the number of γ -neighbors of v .
- I. A 5-vertex having a 1-neighbor and three γ -neighbors.
- J. A 4-vertex with (1) two α -neighbors, (2) an α -neighbor, another 2-neighbor, and a γ -neighbor, or (3) a 2-neighbor and three γ -neighbors.
- K. A γ -vertex whose 3⁺-neighbors are all β -vertices.

Proof. Lemma 2.6 shows that **A-E** are 3-reducible. Let G be a minimal 3-bad graph containing one of **F-K**. When z is a γ -vertex with a 3⁺-neighbor v and $w(zv)$ has been chosen, the phrase “apply Lemma 4.3 to z ” means “apply Lemma 4.3 to choose weights on F_z to

satisfy F_z and the edges incident to them other than zv ". In each case, we extend a proper 3-weighting w' of a proper subgraph G' of G to a proper 3-weighting w of G .

The phrase "Figure n is accurate" means that the vertices in the illustration are known to be distinct, except possibly for non- γ -vertices on circles, to which no edges of the core are adjacent. There are three types of γ -vertices. Let those of degree 4 be γ_4 -vertices, those of degree 3 with an α -neighbor be γ_{3a} -vertices, and those of degree 3 with two 2-neighbors be γ_{3b} -vertices.

Case F: v and v' are adjacent γ -vertices. Let $G' = G - vv' - F_v - F_{v'}$. By symmetry, the first subcase covers when v or v' is a γ_{3b} -vertex. By Lemma 2.5, v and v' do not have a common 2-neighbor.

Subcase 1: v is a γ_{3b} -vertex. Let $N_G(v) = \{v', z, z'\}$. By Lemma 2.5, we may assume $zz', zv', z'v' \notin E(G)$, so Figure 13 is accurate. Set $w(vv') = 3$ to ensure satisfying vz and vz' . Apply Lemma 4.3 to v' . Choose $w(vz)$ to satisfy $\Gamma_{G'}(z)$. Choose $w(vz')$ to satisfy vv' and $\Gamma_{G'}(z')$.

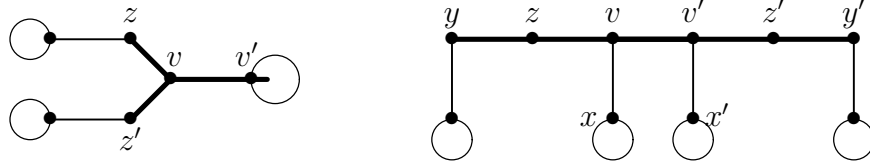

Figure 13: Cases **F1** and **F2** for Lemma 4.5

Subcase 2: v and v' are both γ_{3a} -vertices. Let z and z' be the α -neighbors of v and v' , and let y and y' be the 2-neighbors of z and z' . By Lemma 4.4, Lemma 2.5, and **B**, Figure 13 is accurate. Let x and x' be the remaining neighbors of v and v' , respectively.

Choose $w(vz)$ to satisfy zy . Now choose $w(v'z')$ to satisfy vv' and $z'y'$. Next choose $w(vv')$ to satisfy vx and $v'x'$. Finally, choose $w(zy)$ to satisfy vz and $\Gamma_{G'}(y)$, and choose $w(z'y')$ to satisfy $v'z'$ and $\Gamma_{G'}(y')$.

Subcase 3: v and v' are both γ_4 -vertices. Let $N(v) = \{v', z_1, z_2, u\}$ and $N(v') = \{v, z'_1, z'_2, u'\}$, with $d_G(u) = d_G(u') = 1$. For $i \in \{1, 2\}$, let $a_i = w'(vz_i)$ and $b_i = \rho_{w'}(z_i, v)$; similarly define a'_i and b'_i using $\{v', z'_1, z'_2\}$. Since $d_G(u), d_G(u') = 1$, Figure 14 is accurate.

If $a_1 + a_2 > a'_1 + a'_2$, then set $w(uv) = 3$ to ensure satisfying vv' . Next choose $w(vv')$ to satisfy vz_1 and vz_2 , and choose $w(v'u')$ to satisfy $v'z'_1$ and $v'z'_2$.

By symmetry, we may thus assume $a_1 + a_2 = a'_1 + a'_2$. If $b_1 \neq a_2 + 4$, then choose $w(vv') \in \{1, 3\}$ to ensure satisfying vz_1 . Now choose $w(v'u')$ to satisfy $v'z'_1$ and $v'z'_2$, and then choose $w(vu)$ to satisfy vz_2 and vv' . Hence by symmetry we may assume that each entry of (b_1, b_2, b'_1, b'_2) exceeds the corresponding entry of (a_2, a_1, a'_2, a'_1) by exactly 4. Now setting $w(uv) = w(vv') = 3$ and $w(v'u') = 2$ completes the extension.

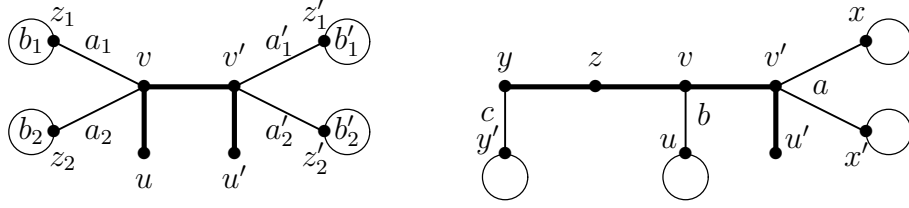

Figure 14: Cases **F3** and **F4** for Lemma 4.5

Subcase 4: v is a γ_{3a} -vertex and v' is a γ_4 -vertex. Let $N_G(v) = \{v', z, u\}$, with z being the α -vertex. Let y be the 2-neighbor of z , with $N_G(y) = \{z, y'\}$. Let $N_G(v') = \{v, x, x', u'\}$, with $d_G(u') = 1$. By Lemma 2.5 and **D**, Figure 14 is accurate. Let $a = w'(v'x) + w'(v'x')$, $b = w'(vu)$, and $c = w'(yy')$.

If $a \neq b$, then choose $w(u'v') \in \{1, 3\}$ to ensure satisfying vv' . Now choose $w(vv')$ to satisfy $v'x$ and $v'x'$, choose $w(vz)$ to satisfy vu and yz , and choose $w(zy)$ to satisfy vz and the other edge at y .

If $a = b$, then set $w(u'v') = c$. Now choose $w(vv')$ to satisfy $v'x$ and $v'x'$. Next choose $w(vz)$ to satisfy vv' , yz , and uv , which succeeds because vv' and yz both are satisfied if and only if $w(vz) \neq c$. Finally choose $w(zy)$ to satisfy vz and the other edge at y .

Case G: v is a 3-vertex having two γ -neighbors z and z' . Let $N_G(v) = \{z, z', x\}$. In each case, we will let $G' = G - \{vz, vz'\} - F_z - F_{z'}$ (and w' is a proper 3-weighting of G'). By **F**, $zz' \notin E(G)$. By Lemma 2.5, neither z nor z' shares a 2-neighbor with v or has a 2-neighbor adjacent to a 2-neighbor of v . Hence Figures 15 and 16 are accurate.

Subcase 1: z is a γ_{3a} -vertex. Let $N_G(z) = \{v, y, u\}$, with y the α -neighbor of z . Let y' be the 2-neighbor of y , with $N_G(y') = \{y, y''\}$. Let $a = w'(vx)$, $b = w'(zu)$, and $c = w'(y'y'')$, as shown on the left in Figure 15.

If $b \neq a$, then choose $w(vz') \in \{1, 3\}$ to ensure satisfying vz . With $w(vz')$ known, apply Lemma 4.3 to z' . Next choose $w(vz)$ to satisfy vx and vz' . With vz automatically satisfied and $w(vz)$ chosen, it now suffices to apply Lemma 4.3 to z .

Hence we may assume $b = a$. In this case, set $w(vz') = c$ and apply Lemma 4.3 to z' . Choose $w(vz)$ to satisfy vx and vz' . Now choose $w(zy)$ to satisfy vz , zu , and yy' ; this succeeds because yy' and vz both forbid $w(zy) = c$, so at most two choices for $w(zy)$ are forbidden. Finally, choose $w(yy')$ to satisfy zy and $y'y''$.

Subcase 2: z is a γ_{3b} -vertex. Let $N_G(z) = \{v, y_1, y_2\}$, with $N_G(y_1) = \{z, y'_1\}$ and $N_G(y_2) = \{z, y'_2\}$. By Subcase 1, we may assume that z' is not a γ_{3a} -vertex.

Suppose that z' is a γ_4 -vertex, with 1-neighbor u , as in Figure 15 in the middle. Set $w(vz) = 3$ to ensure satisfying zy_1 and zy_2 . Now $w(uz')$ has two choices that satisfy vz' , and $w(vz')$ has two choices that satisfy vx . With at least three choices for the sum $w(uz') + w(vz')$, the two edges in $\Gamma_{G'}(z')$ can also be satisfied. Now choose $w(zy_1)$ to satisfy $\Gamma_{G'}(y_1)$ and $w(zy_2)$

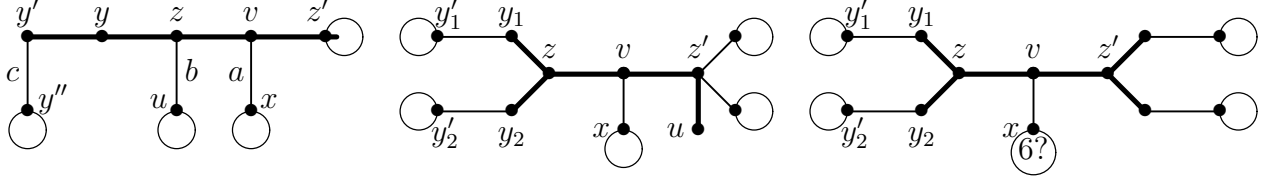

Figure 15: Cases **G1** and **G2** for Lemma 4.5

to satisfy zv and $\Gamma_{G'}(y_2)$.

Hence we may assume that z' is also a γ_{3b} -vertex, as on the right in Figure 15. If $\rho_{w'}(x, v) \neq 6$, then set $w(vz) = w(vz') = 3$. This satisfies vx and also ensures satisfying F_z and $F_{z'}$. Choose $w(zy_1)$ to satisfy y_1y_1' , and choose $w(zy_2)$ to satisfy y_2y_2' and zv . Choose weights on $F_{z'}$ by the same method.

If $\rho_{w'}(x, v) = 6$ and $w'(y_1y_1') \neq 3$, then set $w(vz) = 2$ and $w(vz') = 3$ to satisfy vx and ensure satisfying zy_1 . Choose $w(zy_1) \in \{2, 3\}$ to satisfy y_1y_1' and ensure satisfying zy_2 . Now choose $w(zy_2)$ to satisfy y_2y_2' and zv . Since setting $w(vz') = 3$ ensures satisfying $F_{z'}$, we can choose weights on $F_{z'}$ to finish as in the preceding paragraph.

Hence we may assume that $\rho_{w'}(x, v) = 6$ and (by symmetry) that all the edges of G' incident to the 2-neighbors of z and z' have weight 3 under w' . Since we may assume by Subcase 1 that neither z nor z' is a γ_{3a} -vertex, we can complete the extension by giving all the missing edges weight 1, unless $w'(vx) = 1$. In that case, just change $w(vz)$ to 3 and choose $w(zy_i) \in \{2, 3\}$ to satisfy y_iy_i' , for $i \in \{1, 2\}$.

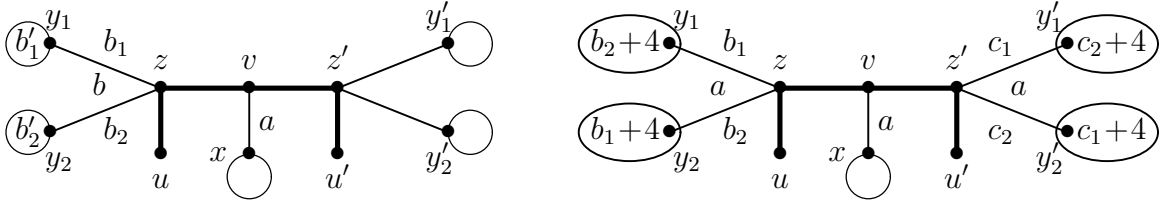

Figure 16: Case **G3** for Lemma 4.5

Subcase 3: z and z' are both γ_4 -vertices. Let $N_G(z) = \{v, y_1, y_2, u\}$ and $N_G(z') = \{v, y_1', y_2', u'\}$, with $d_G(u) = d_G(u') = 1$. Let $a = w'(vx)$. For $i \in \{1, 2\}$, let $b_i = w'(zy_i)$ and $b'_i = \rho_{w'}(y_i, z)$, as on the left in Figure 16.

Let $b = b_1 + b_2$. If $b \neq a$, then choose $w(vz') \in \{1, 3\}$ to ensure satisfying zv . With $w(vz')$ fixed, choose $w(z'u')$ to satisfy $\Gamma_{G'}(z')$. Now choose $w(vz)$ to satisfy vx and zv , and then choose $w(zu)$ to satisfy $\Gamma_{G'}(z)$ and complete the extension.

If $b'_1 \neq b_2 + 4$, then choose $w(vz) \in \{1, 3\}$ to ensure satisfying zy_1 . Now restrict $w(u'z')$ to two choices that satisfy zv , and restrict $w(vz')$ to two choices that satisfy vx . Having at least three choices for the sum $w(u'z') + w(vz')$ allows also satisfying the edges of $\Gamma_{G'}(z')$.

Finally, choose $w(uz)$ to satisfy zy_2 and zv and complete the extension.

By symmetry, the only remaining case is $b = a$, $b'_1 = b_2 + 4$, and $b'_2 = b_1 + 4$, and similarly for $\Gamma_{G'}(z')$, as on the right in Figure 16. Now $w(vz) + w(zu) < 4$ satisfies zy_1 and zy_2 , and $w(uz) \neq w(vz')$ satisfies vx . Similarly, $w(vz') + w(z'u') > 4$ satisfies $z'y'_1$ and $z'y'_2$, and $w(u'z') \neq w(vz)$ satisfies vx' . Set $w(vz) = w(zu) = 1$ and $w(z'u') = 3$, and choose $w(vz') \in \{2, 3\}$ to satisfy vx .

Case H: A vertex v such that $p_1 + 2q \geq d(v)$ and $p_1 + q > 4$. Let Z be the set of γ -neighbors of v . Let R be the set of edges from v to 1-neighbors and to Z , shown bold in Figure 17. By **F**, the set Z is independent. Form G' from G by deleting R and F_z for each $z \in Z$. Here v and a γ -neighbor of v play the roles of x and v in Figure 11, respectively.

Let R' be a set of $d(v) - p_1 - q$ edges from v to Z . Assign weight 3 to all of $R - R'$. Choose weights on R' from $\{2, 3\}$ to satisfy the $d(v) - p_1 - q$ edges in $\Gamma_{G'}(v)$.

Consider vz with $z \in Z$. Including the weights on $\Gamma_{G'}(v)$, the sum of the weights on $\Gamma_G(v) - \{vz\}$ is now at least $3(q - 1) + 3p_1$, which by hypothesis exceeds 9. At most three edges are incident to vz at z , so vz is automatically satisfied, as are the edges from v to 1-neighbors. Now the weights on R are fixed; apply Lemma 4.3 to the vertices of Z .

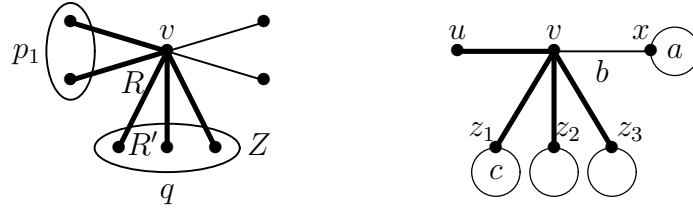

Figure 17: Cases **H** and **I** for Lemma 4.5

Case I: A 5-vertex v having a 1-neighbor and three γ -neighbors. The argument of Case **H** does not suffice here, since $p_1 + q = 4$. Let u be the 1-neighbor of v , and let z_1, z_2, z_3 be its γ -neighbors. As in **H**, let $R = \{vu, vz_1, vz_2, vz_3\}$ (bold on the right in Figure 17), and let $G' = G - R - \bigcup_i F_{z_i}$. Let $a = \rho_{w'}(x, v)$, and let $b = w'(vx)$. By Lemma 4.4, we may assume that no two of the γ -neighbors are 3-vertices with a common 2-neighbor, and by **F** they form an independent set. Hence Figure 17 is accurate.

If $a \neq 12$, then put weight 3 on all edges of R to satisfy vx and ensure satisfying $\{vz_1, vz_2, vz_3\}$. Finally, apply Lemma 4.3 to each z_i .

If $a = 12$, then set $w(vz_1) = 2$ so that vx is automatically satisfied. Having specified $w(vz_1)$, apply Lemma 4.3 to z_1 . Now let $c = \rho_w(z_1, v)$. If $c \leq 7$, or if $c = 8$ and $b \geq 2$, then set $w(vz_2) = w(vz_3) = 3$ to ensure satisfying vz_1 . If $c = 9$, or if $c = 8$ and $b = 1$, then set $w(vz_2) = w(vz_3) = 1$ to ensure satisfying vz_1 . Next apply Lemma 4.3 to z_2 and z_3 . Finally, choose $w(vu)$ to satisfy vz_2 and vz_3 .

Case J: A 4-vertex with specified neighbors. As usual, by the prior lemmas and reducible configurations, Figure 18 is accurate.

Subcase 1: A 4-vertex v with α -neighbors z and z' . Let $N_G(z) = \{v, y\}$ and $N_G(z') = \{v, y'\}$, as in Figure 18. By Lemma 2.5, we may assume $\{y, y'\} \cap \{z, z'\} = \emptyset$. By **B**, we have $y \neq y'$ and $yy' \notin E(G)$. Let $G' = G - \{vz, vz', zy, z'y'\}$. At least two choices for $w(vz)$ satisfy zy , and similarly two choices for $w(vz')$ satisfy $z'y'$. This yields at least three choices for $w(vz) + w(vz')$, which is enough to satisfy $\Gamma_{G'}(v)$. Finally, choose $w(zy)$ to satisfy its two incident edges and $w(z'y')$ to satisfy its two incident edges.

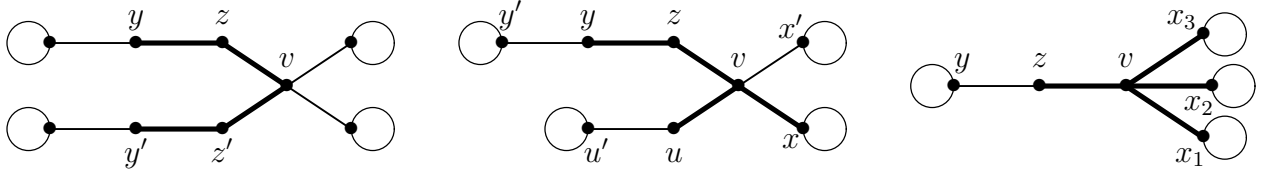

Figure 18: Cases **J1, J2, J3** for Lemma 4.5

Subcase 2: A 4-vertex v with an α -neighbor z , another 2-neighbor u (that is not an α -vertex), and a γ -neighbor x . Name the vertices (uniquely) so that y', y, z, v, u, u' form a path in order, and let x' be the remaining neighbor of v , as in Figure 18. Let $G' = G - \{yz, zv, vu, vx\} - F_x$. Set $w(vx) = 2$ to ensure satisfying vu . Apply Lemma 4.3 to x . At least two choices for $w(vu)$ satisfy uu' , and at least two choices for $w(vz)$ satisfy yz . With at least three choices for $w(vu) + w(vz)$, at least one satisfies vx and vx' . Finally, choose $w(yz)$ to satisfy vz and yy' .

Subcase 3: A 4-vertex v with a 2-neighbor z and three γ -neighbors x_1, x_2, x_3 . Let $N(z) = \{v, y\}$, as in Figure 18. Let $G' = G - \Gamma_G(v) - \bigcup_i F_{x_i}$.

If $d(x_1) = 3$, or if $d(x_1) = 4$ and $\phi_{w'}(x_1) \leq 4$, then the value of $\rho_w(x_1, v)$ will be at most 7, since when $d(x_1) = 4$ there is only one edge in F_{x_1} (the edge incident to the 1-neighbor of x_1). Hence setting $w(vx_2) = w(vx_3) = 3$ and restricting $w(zv)$ to $\{2, 3\}$ ensures satisfying vx_1 and vz . Apply Lemma 4.3 to x_2 and x_3 . Now choose $w(zv)$ (in $\{2, 3\}$) to satisfy yz , and then choose $w(vx_1)$ to satisfy vx_2 and vx_3 . Finally, apply Lemma 4.3 to x_1 .

By symmetry, we may now assume $d(x_i) = 4$ and $\phi_{w'}(x_i) \geq 5$ for all i . Choose $w(vz) \in \{1, 2\}$ to satisfy zy . Set $w(vx_1) = 2$ and $w(vx_2) = w(vx_3) = 1$ to ensure satisfying all edges incident to v . Finally, apply Lemma 4.3 to each x_i .

Case K: v is a γ -vertex whose 3^+ -neighbors are all β -vertices. See Figure 19. Let S be the set of neighbors of v whose degrees are not specified by the definition of v being a γ -vertex. By **{B,C,D}**, all vertices of S are 3^+ -vertices. By **F**, they cannot be γ -vertices, so by the hypothesis of this case, each vertex of S has degree 3, with one 2-neighbor and one 3^+ -neighbor other than v (by **A**). By Lemmas 2.5 and 4.4 and Cases **B** and **F**, Figure 19 is accurate in each subcase.

Subcase 1: v is a γ_{3b} -vertex. Let $N_G(v) = \{z, z', u\}$, where $d_G(u) = 3$. Let y be the 2-neighbor of u . Let $G' = G - \Gamma_G(v) - uy$. Set $w(vu) = 3$ to ensure satisfying all of $\{vz, vz', uy\}$. Choose $w(uy)$ to satisfy its two incident edges other than vu . Choose $w(vz)$ to satisfy the other edge at z , and choose $w(vz')$ to satisfy vu and the other edge at z' .

Subcase 2: v is a γ_4 -vertex. Let $N_G(v) = \{z_1, z_2, z_3, u\}$, with $d_G(u) = 1$. Let y_i be the 2-neighbor of z_i . Let $G' = G - \Gamma_G(v) - \{z_1y_1, z_2y_2, z_3y_3\}$. For each i , set $w(vz_i) = 3$ to ensure satisfying z_iy_i , and choose $w(z_iy_i)$ to satisfy its two incident edges other than z_iy_i . Also vz_1, vz_2, vz_3 are satisfied.

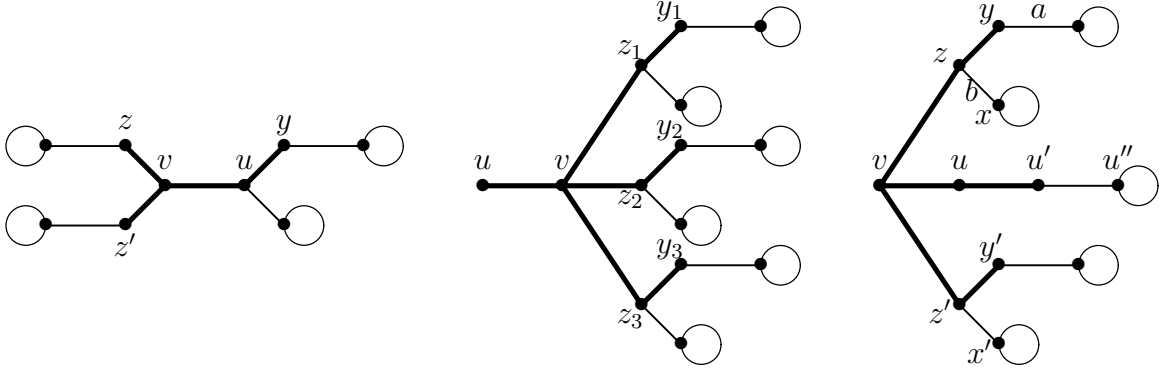

Figure 19: Cases **K1,K2,K3** for Lemma 4.5

Subcase 3: v is a γ_{3a} -vertex. Let u be the α -neighbor of v (with $N_G(u) = \{v, u'\}$). By **C**, v does not have another 2-neighbor. Let $N_G(z) = \{v, x, y\}$ and $N_G(z') = \{v, x', y'\}$, with $d_G(y) = d_G(y') = 2$. By **J**, each β -neighbor of v is not a γ -vertex, which means that the other neighbors of y and y' are 3^+ -vertices.

Let $G' = G - \Gamma_G(v) - \{uu', zy, z'y'\}$. Let a and b be the weights under w' of the edges incident to y and z in G' , respectively. Set $w(vz') = 3$ to ensure satisfying $z'y'$, and choose $w(z'y')$ to satisfy the edges incident to $z'y'$ other than vz' .

If $a \leq b$, then zy is automatically satisfied. Choose $w(zy)$ to satisfy $\Gamma_{G'}(y)$. Now choose $w(vu)$ to satisfy vz and uu' , and then choose $w(vz)$ to satisfy vz' and zx . Finally, choose uu' to satisfy vu and $u'u''$.

If $a > b$, then setting $w(zy) = 1$ ensures satisfying the other edge at y (since its other endpoint has degree at least 3). With $b \leq 2$ and $w(vz') = 3$, the edge vz is automatically satisfied. Now choose $w(vz)$ to satisfy the other edges at z , choose $w(vu)$ to satisfy vz' and uu' , and choose $w(uu')$ to satisfy its incident edges. \square

Theorem 4.6. *Every graph G with $\text{Mad}(G) < \frac{8}{3}$ has a proper 3-weighting.*

Proof. It suffices to show that every configuration in the unavoidable set in Lemma 4.2 is shown to be 3-reducible in Lemma 4.5. The configurations are the same in the two lemmas except for **H** and **J**.

For **H**, if $d(v) \in \{6, 7\}$ and v has a 1-neighbor and four γ -neighbors, then $p_1 + 2q \geq d(v)$ and $p_1 + q > 4$. For **J**, a 4-vertex v with $p + q + r \geq 5$ must have an α -neighbor. If v has another α -neighbor, then **J1** applies. If v has a γ -neighbor and another 2-neighbor, then **J2** applies. Otherwise, all other neighbors are γ -neighbors (reducible by **J3**) or all are 2-neighbors (reducible by **B**). \square

Some of the 3-reducible configurations in Lemma 4.5 are more general than the configurations forced in Lemma 4.2. Also, there are other 3-reducible configuration we have not used, such as (1) a 4-vertex having two 2-neighbors and one γ -neighbor and (2) a more general version of configuration **H**. This suggests that with more work this approach could be pushed to prove the conclusion under a weaker restriction on $\text{Mad}(G)$.

References

- [1] L. Addario-Berry, K. Dalal, C. McDiarmid, B. A. Reed, and A. Thomason, Vertex-colouring edge-weightings, *Combinatorica* 27 (2007), 1–12.
- [2] L. Addario-Berry, K. Dalal, and B. A. Reed, Degree constrained subgraphs. *Discrete Appl. Math.* 156 (2008), 1168–1174.
- [3] N. Alon, Combinatorial Nullstellensatz. *Combin. Probab. Comput.* 8 (1999), 7–29.
- [4] T. Bartnicki, J. Grytczuk, S. Niwczyk, Weight choosability of graphs, *Journal of Graph Theory* 60 (2009), 242–256.
- [5] M. Kalkowski, A note on the 1,2-conjecture, submitted (also in Ph.D. Thesis, 2009).
- [6] M. Kalkowski, M. Karónski, and F. Pfender, Vertex-coloring edge-weightings: towards the 1-2-3-conjecture. *J. Combin. Theory Ser. B* 100 (2010), 347–349.
- [7] M. Karónski, T. Łuczak, and A. Thomason, Edge weights and vertex colours, *J. Combin. Theory Ser. B* 91 (2004), 151–157.
- [8] J. Przybyło and M. Woźniak, On a 1,2-conjecture, *Discrete Math. Theor. Comput. Sci.* 12 (2010), 101–108.
- [9] B. Seamone, The 1-2-3 Conjecture and related problems: a survey, submitted (<http://arxiv.org/abs/1211.5122>).
- [10] T. Wang and Q. Yu, On vertex-coloring 13-edge-weighting. *Front. Math. China* 3 (2008), 581–587.
- [11] T.-L. Wong, D. Yang, and X. Zhu, List total weighting of graphs, *Bolyai Soc. Math. Stud.* 20, (János Bolyai Math. Soc., 2010), 337–353.
- [12] T.-L. Wong and X. Zhu, Total weight choosability of graphs, *Journal of Graph Theory* 66 (2011), 198–212.
- [13] T.-L. Wong and X. Zhu, Every graph is (2, 3)-choosable, submitted.