

SURGERY HQFT

VLADIMIR TURAEV AND ALEXIS VIRELIZIER

ABSTRACT. Homotopy Quantum Field Theories (HQFTs) generalize more familiar Topological Quantum Field Theories (TQFTs). In generalization of the surgery construction of 3-dimensional TQFTs from modular categories, we use surgery to derive 3-dimensional HQFTs from G -modular categories.

CONTENTS

1. Introduction	1
2. Preliminaries on categories	3
3. G -graded categories	6
4. G -braided and G -ribbon categories	10
5. Colored G -graphs	16
6. The category \mathcal{G}_C	22
7. Colored diagrams	24
8. Colored Reidemeister moves	27
9. The functor F_C	34
10. Conjugation of colorings	38
11. Invariants of special G -graphs	41
12. G -modular categories	46
13. The surgery HQFT	48
References	53

1. INTRODUCTION

Homotopy Quantum Field Theories (HQFTs) were introduced in [Tu2] as generalizations of Topological Quantum Field Theories (TQFTs). An HQFT produces “quantum” invariants of manifolds endowed with homotopy classes of maps to a fixed space. Such homotopy classes represent additional structures on manifolds whose nature depends on the choice of the target space. We shall focus on HQFTs whose target space is an Eilenberg-MacLane space $K(G, 1)$ where G is a discrete group. The maps to $K(G, 1)$ encode flat principal G -bundles over manifolds. When $G = 1$, we recover the usual TQFTs.

The study of TQFTs is primarily motivated by their interest for theoretical physics, and their main applications outside of pure mathematics lie in physics and in the theory of quantum computations, see, for example, [Ca, Wa]. The study of TQFTs has also found applications in knot theory, low dimensional topology,

Date: October 29, 2018.

2010 Mathematics Subject Classification. 57M27, 18D10, 57R56.

and in the theory of Hopf algebras and monoidal categories. One expects similar applications for HQFTs.

The construction of Reshetikhin and Turaev [RT2] derives a 3-dimensional TQFT from a modular category. The principal aim of the present paper is to extend this construction to HQFTs. Specifically, we show that every G -modular category in the sense of [TV3] gives rise to a 3-dimensional HQFT with target $K(G, 1)$. The construction is based on surgery presentations of 3-manifolds by links in Euclidean 3-space \mathbb{R}^3 , and the resulting HQFT is called the *surgery HQFT*.

The definition of a G -modular category will be fully recalled in the body of the paper. Note here that such a category is G -graded and G -ribbon. A G -graded category is a monoidal category whose objects have a multiplicative G -grading. Such a category is G -ribbon if it carries additional structures: a G -braiding, a G -twist, and an action of G called the crossing. For $G = 1$, we recover the standard notions of braided/ribbon/modular categories.

An alternative approach to 3-dimensional HQFTs based on the technique of state sums starts with so-called spherical G -graded categories, see [TV2]. In a sequel to this paper, we will relate these approaches via the following theorem: the state sum HQFT associated with a spherical G -graded category is isomorphic to the surgery HQFT associated with the G -center of that category. This theorem is highly non-trivial already for $G = 1$ (that is, for TQFTs); in this case it was first established in [TV1] and slightly later - but independently - in [BK, Ba1, Ba2]. For the notion of the G -center of a G -graded category, we refer the reader to [TV3]; we will not use G -centers here.

A surgery construction for HQFTs was first suggested in [Tu2]. However, the class of G -modular categories studied in [Tu2] is very narrow. For example, the G -centers of spherical G -graded categories only rarely belong to this class which makes it inadequate for the above-mentioned theorem. The notion of a G -modular category used here is considerably more general and does include the G -centers. Working in this generality requires us to introduce quite a number of new algebraic and geometric techniques essential for this work.

The key ingredient in the definition of the surgery TQFT associated with a modular category \mathcal{C} is a certain functor from the category of \mathcal{C} -colored ribbon graphs in $\mathbb{R}^2 \times [0, 1]$ to \mathcal{C} , see [RT1, RT2, Sh, Tu1]. A \mathcal{C} -coloring of a ribbon graph labels the edges of the graph with objects of \mathcal{C} and labels the vertices of the graph with morphisms in \mathcal{C} . Note that the vertices of a ribbon graph are rectangles called “coupons”. We need to define a version of the functor above for ribbon graphs whose exteriors are equipped with homotopy classes of maps to $K(G, 1)$. Such a homotopy class is determined by a homomorphism from the fundamental group of the graph exterior to G , and we rather work with homomorphisms. In the role of the base point of the graph exterior we take any point with big second coordinate. In the role of \mathcal{C} we take a G -ribbon G -graded category. A \mathcal{C} -coloring attributes an object of \mathcal{C} to each path in the graph exterior leading from the base point to an edge of the graph. This object must be preserved under homotopies of the path and must behave in a “controlled” way under changes of the path. In particular, under multiplication of the path by a loop at the base point, the object should be modified via the crossing automorphism of \mathcal{C} determined by the element of G represented by the loop. Furthermore, a \mathcal{C} -coloring attributes morphisms in \mathcal{C} to paths from the base point to the coupons. Again, a “controlled behavior” is required.

We define a monoidal category $\mathcal{G}_{\mathcal{C}}$ of \mathcal{C} -colored ribbon graphs. The objects of $\mathcal{G}_{\mathcal{C}}$ are finite sequences of pairs (an object of \mathcal{C} , a sign \pm). These objects encode the colors and the orientations of \mathcal{C} -colored ribbon graphs near the inputs and the outputs. The morphisms of $\mathcal{G}_{\mathcal{C}}$ are appropriate equivalence classes of \mathcal{C} -colored ribbon graphs in $\mathbb{R}^2 \times [0, 1]$ having no circle components. It should be stressed that the category $\mathcal{G}_{\mathcal{C}}$ does not include knots or links. It does include \mathcal{C} -colored string links (and in particular, \mathcal{C} -colored braids) which are viewed as ribbon graphs without coupons.

For any G -ribbon G -graded category \mathcal{C} , we define a monoidal functor $F_{\mathcal{C}}: \mathcal{G}_{\mathcal{C}} \rightarrow \mathcal{C}$. As in the classical case, the construction of $F_{\mathcal{C}}$ uses graph diagrams and Reidemeister moves though, in our setting, the correspondence between graphs and diagrams becomes quite delicate. For $G = 1$, the functor $F_{\mathcal{C}}$ is the restriction of the functor of [RT1, Sh, Tu1] to ribbon graphs without circle components.

We then show how to transform links in \mathbb{R}^3 into \mathcal{C} -colored ribbon graphs. This transformation, called “insertion of coupons”, allows us to apply $F_{\mathcal{C}}$ to links and leads to the surgery HQFT associated with \mathcal{C} .

The paper consists of 13 sections. Sections 2–4 are devoted to an algebraic discussion of G -graded categories, G -braidings, twists, etc. In Sections 5–11 we define and study the functor $F_{\mathcal{C}}$. In Sections 12 and 13 we define G -graded modular categories and construct the associated HQFTs.

Throughout the paper, we fix a (discrete) group G .

Acknowledgements. The work of V. Turaev was partially supported by the NSF grant DMS-1202335. A. Virelizier gratefully acknowledges the support and hospitality of the Max Planck Institute for Mathematics in Bonn where a part of this work was carried out.

2. PRELIMINARIES ON CATEGORIES

We recall the basic definitions of the theory of monoidal categories.

2.1. Conventions. The symbol \mathcal{C} will denote a monoidal category with unit object $\mathbb{1} = \mathbb{1}_{\mathcal{C}}$. Notation $X \in \mathcal{C}$ means that X is an object of \mathcal{C} . To simplify the formulas, we will always pretend that \mathcal{C} is strict. Consequently, we omit brackets in the monoidal products and suppress the associativity constraints $(X \otimes Y) \otimes Z \cong X \otimes (Y \otimes Z)$ and the unitality constraints $X \otimes \mathbb{1} \cong X \cong \mathbb{1} \otimes X$. By the monoidal product $X_1 \otimes X_2 \otimes \cdots \otimes X_n$ of $n \geq 2$ objects $X_1, \dots, X_n \in \mathcal{C}$ we mean $(\dots((X_1 \otimes X_2) \otimes X_3) \otimes \cdots \otimes X_{n-1}) \otimes X_n$.

2.2. Pivotal categories. A monoidal category $\mathcal{C} = (\mathcal{C}, \otimes, \mathbb{1})$ is *pivotal* (see [Mal]) if for each object X of \mathcal{C} , we have a *dual object* $X^* \in \mathcal{C}$ and four morphisms

$$\begin{aligned} \text{ev}_X: X^* \otimes X &\rightarrow \mathbb{1}, & \text{coev}_X: \mathbb{1} &\rightarrow X \otimes X^*, \\ \tilde{\text{ev}}_X: X \otimes X^* &\rightarrow \mathbb{1}, & \widetilde{\text{coev}}_X: \mathbb{1} &\rightarrow X^* \otimes X, \end{aligned}$$

such that

$$\begin{aligned} \text{(a) for any object } X \in \mathcal{C}, \\ (\text{id}_X \otimes \text{ev}_X)(\text{coev}_X \otimes \text{id}_X) &= \text{id}_X & \text{and} & & (\text{ev}_X \otimes \text{id}_{X^*})(\text{id}_{X^*} \otimes \text{coev}_X) &= \text{id}_{X^*}, \\ (\tilde{\text{ev}}_X \otimes \text{id}_X)(\text{id}_X \otimes \widetilde{\text{coev}}_X) &= \text{id}_X & \text{and} & & (\text{id}_{X^*} \otimes \tilde{\text{ev}}_X)(\widetilde{\text{coev}}_X \otimes \text{id}_{X^*}) &= \text{id}_{X^*}; \end{aligned}$$

(b) for every morphism $f: X \rightarrow Y$ in \mathcal{C} , the *left dual*

$$f^* = (\text{ev}_Y \otimes \text{id}_{X^*})(\text{id}_{Y^*} \otimes f \otimes \text{id}_{X^*})(\text{id}_{Y^*} \otimes \text{coev}_X): Y^* \rightarrow X^*$$

is equal to the *right dual*

$$f^* = (\text{id}_{X^*} \otimes \tilde{\text{ev}}_Y)(\text{id}_{X^*} \otimes f \otimes \text{id}_{Y^*})(\widetilde{\text{coev}}_X \otimes \text{id}_{Y^*}): Y^* \rightarrow X^*;$$

(c) for all $X, Y \in \mathcal{C}$, the *left monoidal constraint*

$$(\text{ev}_X \otimes \text{id}_{(Y \otimes X)^*})(\text{id}_{X^*} \otimes \text{ev}_Y \otimes \text{id}_{X \otimes (Y \otimes X)^*})(\text{id}_{X^* \otimes Y^*} \otimes \text{coev}_{Y \otimes X}): X^* \otimes Y^* \rightarrow (Y \otimes X)^*$$

is equal to the *right monoidal constraint*

$$(\text{id}_{(Y \otimes X)^*} \otimes \tilde{\text{ev}}_Y)(\text{id}_{(Y \otimes X)^*} \otimes Y \otimes \tilde{\text{ev}}_X \otimes \text{id}_{Y^*})(\widetilde{\text{coev}}_{Y \otimes X} \otimes \text{id}_{X^* \otimes Y^*}): X^* \otimes Y^* \rightarrow (Y \otimes X)^*;$$

(d) $\text{ev}_{\mathbb{1}} = \tilde{\text{ev}}_{\mathbb{1}}: \mathbb{1}^* \rightarrow \mathbb{1}$ (or, equivalently, $\text{coev}_{\mathbb{1}} = \widetilde{\text{coev}}_{\mathbb{1}}: \mathbb{1} \rightarrow \mathbb{1}^*$).

In what follows, for a pivotal category \mathcal{C} , we will suppress the duality constraints $\mathbb{1}^* \cong \mathbb{1}$ and $X^* \otimes Y^* \cong (Y \otimes X)^*$. For example, we will write $(f \otimes g)^* = g^* \otimes f^*$ for morphisms f, g in \mathcal{C} .

2.3. Traces and dimensions. Let \mathcal{C} be a pivotal category. For any endomorphism f of an object $X \in \mathcal{C}$, one defines the *left* and *right traces*

$$\text{tr}_l(f) = \text{ev}_X(\text{id}_{X^*} \otimes f)\widetilde{\text{coev}}_X \quad \text{and} \quad \text{tr}_r(f) = \tilde{\text{ev}}_X(f \otimes \text{id}_{X^*})\text{coev}_X.$$

Both traces take values in the commutative monoid $\text{End}_{\mathcal{C}}(\mathbb{1})$ and are symmetric: $\text{tr}_l(gh) = \text{tr}_l(hg)$ for any morphisms $g: X \rightarrow Y$, $h: Y \rightarrow X$ in \mathcal{C} and similarly for tr_r . Also $\text{tr}_{l/r}(f) = \text{tr}_{r/l}(f^*)$ for any endomorphism f of an object. The *left* and *right* dimensions of an object $X \in \mathcal{C}$ are defined by $\dim_{l/r}(X) = \text{tr}_{l/r}(\text{id}_X)$. Clearly, $\dim_{l/r}(X) = \dim_{r/l}(X^*)$ for all X .

2.4. Monoidal functors. Let \mathcal{C} and \mathcal{D} be monoidal categories. A *monoidal functor* from \mathcal{C} to \mathcal{D} is a triple (F, F_2, F_0) , where $F: \mathcal{C} \rightarrow \mathcal{D}$ is a functor,

$$F_2 = \{F_2(X, Y): F(X) \otimes F(Y) \rightarrow F(X \otimes Y)\}_{X, Y \in \mathcal{C}}$$

is a natural transformation from $F \otimes F$ to $F \otimes$, and $F_0: \mathbb{1}_{\mathcal{D}} \rightarrow F(\mathbb{1}_{\mathcal{C}})$ is a morphism in \mathcal{D} , such that the diagrams

$$(1) \quad \begin{array}{ccc} F(X) \otimes F(Y) \otimes F(Z) & \xrightarrow{\text{id}_{F(X)} \otimes F_2(Y, Z)} & F(X) \otimes F(Y \otimes Z) \\ \downarrow F_2(X, Y) \otimes \text{id}_{F(Z)} & & \downarrow F_2(X, Y \otimes Z) \\ F(X \otimes Y) \otimes F(Z) & \xrightarrow{F_2(X \otimes Y, Z)} & F(X \otimes Y \otimes Z), \end{array}$$

$$(2) \quad \begin{array}{ccc} F(X) & \xrightarrow{\text{id}_{F(X)} \otimes F_0} & F(X) \otimes F(\mathbb{1}_{\mathcal{C}}) \\ \downarrow F_0 \otimes \text{id}_{F(X)} & \searrow \text{id}_{F(X)} & \downarrow F_2(X, \mathbb{1}_{\mathcal{C}}) \\ F(\mathbb{1}_{\mathcal{C}}) \otimes F(X) & \xrightarrow{F_2(\mathbb{1}_{\mathcal{C}}, X)} & F(X) \end{array}$$

commute for all objects $X, Y, Z \in \mathcal{C}$ (see [Mac]). Composing monoidal products of $F_1 = \text{id}_F$, and F_2 , we can define for every integer $n \geq 3$, a natural transformation

$$F_n = \{F_n(X_1, \dots, X_n): F(X_1) \otimes \dots \otimes F(X_n) \rightarrow F(X_1 \otimes \dots \otimes X_n)\}_{X_1, \dots, X_n \in \mathcal{C}}.$$

For instance, $F_3(X, Y, Z) = F_2(X, Y \otimes Z)(F_1(X) \otimes F_2(Y, Z))$. The commutativity of the diagrams (1) and (2) ensures that F_n does not depend on the way it is built from F_1 and F_2 .

A monoidal functor (F, F_2, F_0) is *strong* if F_2 and F_0 are isomorphisms. A monoidal functor (F, F_2, F_0) is *strict* if F_2 and F_0 are identity morphisms.

If $F: \mathcal{C} \rightarrow \mathcal{D}$ and $G: \mathcal{D} \rightarrow \mathcal{E}$ are two monoidal functors between monoidal categories, then their composition $GF: \mathcal{C} \rightarrow \mathcal{E}$ is a monoidal functor with

$$(GF)_0 = G(F_0)G_0 \quad \text{and} \quad (GF)_2 = \{G(F_2(X, Y))G_2(F(X), F(Y))\}_{X, Y \in \mathcal{C}}.$$

Let $F: \mathcal{C} \rightarrow \mathcal{D}$ and $G: \mathcal{C} \rightarrow \mathcal{D}$ be two monoidal functors. A natural transformation $\varphi = \{\varphi_X: F(X) \rightarrow G(X)\}_{X \in \mathcal{C}}$ from F to G is *monoidal* if it satisfies

$$(3) \quad G_0 = \varphi_{\mathbb{1}}F_0 \quad \text{and} \quad \varphi_{X \otimes Y}F_2(X, Y) = G_2(X, Y)(\varphi_X \otimes \varphi_Y)$$

for all objects X, Y of \mathcal{C} . A *monoidal natural isomorphism* between F and G is a monoidal natural transformation φ from F to G which is an isomorphism in the sense that each φ_X is an isomorphism. The inverse $\varphi^{-1} = \{\varphi_X^{-1}: G(X) \rightarrow F(X)\}_{X \in \mathcal{C}}$ is then a monoidal natural transformation from G to F .

2.5. Pivotal functors. Given a strong monoidal functor $F: \mathcal{C} \rightarrow \mathcal{D}$ between pivotal categories, we define for each $X \in \mathcal{C}$ a morphism $F^l(X): F(X^*) \rightarrow F(X)^*$ by

$$F^l(X) = (F_0^{-1}F(\text{ev}_X)F_2(X^*, X) \otimes \text{id}_{F(X)^*})(\text{id}_{F(X^*)} \otimes \text{coev}_{F(X)}).$$

It is well-known that $F^l = \{F^l(X): F(X^*) \rightarrow F(X)^*\}_{X \in \mathcal{C}}$ is a monoidal natural isomorphism which preserves the left duality in the sense that for all $X \in \mathcal{C}$,

$$(4) \quad F(\text{ev}_X) = F_0 \text{ev}_{F(X)}(F^l(X) \otimes \text{id}_{F(X)})F_2(X^*, X)^{-1},$$

$$(5) \quad F(\text{coev}_X) = F_2(X, X^*)(\text{id}_{F(X)} \otimes F^l(X)^{-1})\text{coev}_{F(X)}F_0^{-1}.$$

The monoidality of F^l means that $(F_0^{-1})^* = F^l(\mathbb{1})F_0$ and for all $X, Y \in \mathcal{C}$,

$$F^l(X \otimes Y)F_2(Y^*, X^*) = (F_2(X, Y)^{-1})^*(F^l(Y) \otimes F^l(X)).$$

Likewise, the morphisms $\{F^r(X): F(X^*) \rightarrow F(X)^*\}_{X \in \mathcal{C}}$, defined by

$$F^r(X) = (\text{id}_{F(X)^*} \otimes F_0^{-1}F(\tilde{\text{ev}}_X)F_2(X, X^*))(\widetilde{\text{coev}}_{F(X)} \otimes \text{id}_{F(X^*)}),$$

form a monoidal natural isomorphism F^r preserving the right duality: for all $X \in \mathcal{C}$,

$$(6) \quad F(\tilde{\text{ev}}_X) = F_0 \tilde{\text{ev}}_{F(X)}(\text{id}_{F(X)} \otimes F^r(X))F_2(X, X^*)^{-1},$$

$$(7) \quad F(\widetilde{\text{coev}}_X) = F_2(X^*, X)(F^r(X)^{-1} \otimes \text{id}_{F(X)})\widetilde{\text{coev}}_{F(X)}F_0^{-1}.$$

One can check that F^l and F^r are related by

$$(8) \quad F^l(X^*)F(\phi_X) = F^r(X)^*\phi_{F(X)}$$

for all $X \in \mathcal{C}$ where $\{\phi_X: X \rightarrow X^{**}\}_{X \in \mathcal{C}}$ is the *pivotal structure* in \mathcal{C} defined by

$$(9) \quad \phi_X = (\tilde{\text{ev}}_X \otimes \text{id}_{X^{**}})(\text{id}_X \otimes \text{coev}_{X^*}): X \rightarrow X^{**}.$$

The functor $F: \mathcal{C} \rightarrow \mathcal{D}$ is said to be *pivotal* if $F^l(X) = F^r(X)$ for any $X \in \mathcal{C}$. In this case, $F^l = F^r$ is denoted by F^1 .

2.6. Penrose graphical calculus. We will represent morphisms in a category \mathcal{C} by plane diagrams to be read from the bottom to the top. The diagrams are made of oriented arcs colored by objects of \mathcal{C} and of boxes colored by morphisms of \mathcal{C} . The arcs connect the boxes and have no intersections or self-intersections. The identity id_X of $X \in \mathcal{C}$, a morphism $f: X \rightarrow Y$, and the composition of two morphisms $f: X \rightarrow Y$ and $g: Y \rightarrow Z$ are represented as follows:

$$\text{id}_X = \begin{array}{c} \downarrow \\ | \\ \downarrow \\ X \end{array}, \quad f = \begin{array}{c} \downarrow Y \\ \boxed{f} \\ \downarrow X \end{array}, \quad \text{and} \quad gf = \begin{array}{c} \downarrow Z \\ \boxed{g} \\ \downarrow Y \\ \boxed{f} \\ \downarrow X \end{array}.$$

If \mathcal{C} is monoidal, then the monoidal product of two morphisms $f: X \rightarrow Y$ and $g: U \rightarrow V$ is represented by juxtaposition:

$$f \otimes g = \begin{array}{c} \downarrow Y \quad \downarrow V \\ \boxed{f} \quad \boxed{g} \\ \downarrow X \quad \downarrow U \end{array}.$$

If \mathcal{C} is pivotal, then we allow arcs directed upwards. Such an arc, colored with $X \in \mathcal{C}$, contributes X^* to the source/target of the associated morphism. For example, id_{X^*} and a morphism $f: X^* \otimes Y \rightarrow U \otimes V^* \otimes W$ may be depicted as:

$$\text{id}_{X^*} = \begin{array}{c} \downarrow \\ | \\ \downarrow \\ X \end{array} = \begin{array}{c} \downarrow \\ | \\ \downarrow \\ X^* \end{array} \quad \text{and} \quad f = \begin{array}{c} \downarrow U \quad \downarrow V \quad \downarrow W \\ \boxed{f} \\ \downarrow X \quad \downarrow Y \end{array}.$$

The duality morphisms are depicted as follows:

$$\text{ev}_X = \begin{array}{c} \curvearrowright \\ X \end{array}, \quad \text{coev}_X = \begin{array}{c} \curvearrowleft \\ X \end{array}, \quad \widetilde{\text{ev}}_X = \begin{array}{c} \curvearrowleft \\ X \end{array}, \quad \widetilde{\text{coev}}_X = \begin{array}{c} \curvearrowright \\ X \end{array}.$$

The dual of a morphism $f: X \rightarrow Y$ and the traces of a morphism $g: X \rightarrow X$ can be depicted as follows:

$$f^* = \begin{array}{c} \curvearrowright \\ \boxed{f} \\ \downarrow Y \end{array} \begin{array}{c} \downarrow X \\ \curvearrowleft \\ \boxed{f} \\ \downarrow Y \end{array} = \begin{array}{c} \downarrow X \\ \boxed{f} \\ \downarrow Y \end{array} \begin{array}{c} \curvearrowright \\ \boxed{f} \\ \downarrow Y \end{array} \quad \text{and} \quad \text{tr}_l(g) = \begin{array}{c} \downarrow X \\ \boxed{g} \\ \downarrow X \end{array}, \quad \text{tr}_r(g) = \begin{array}{c} \boxed{g} \\ \downarrow X \end{array}.$$

If \mathcal{C} is pivotal, then the morphism represented by a plane diagram is invariant under isotopies of the diagram in the plane keeping the bottom and top endpoints.

3. G -GRADED CATEGORIES

3.1. G -graded categories. A G -graded category is a monoidal category $(\mathcal{C}, \otimes, \mathbb{1})$ endowed with a system of pairwise disjoint full subcategories $\{\mathcal{C}_\alpha\}_{\alpha \in G}$ such that

- (a) all Hom -sets in \mathcal{C} are modules over a (fixed) commutative ring \mathbb{k} and the composition and the monoidal product of morphisms are \mathbb{k} -bilinear;
- (b) $\mathbb{1} \in \mathcal{C}_1$ and if $U \in \mathcal{C}_\alpha$ and $V \in \mathcal{C}_\beta$, then $U \otimes V \in \mathcal{C}_{\alpha\beta}$;
- (c) if $U \in \mathcal{C}_\alpha$ and $V \in \mathcal{C}_\beta$ with $\alpha \neq \beta$, then $\text{Hom}_{\mathcal{C}}(U, V) = 0$.

The monoidal category \mathcal{C}_1 corresponding to the neutral element $1 \in G$ is called the *neutral component* of \mathcal{C} .

An object X of a G -graded category \mathcal{C} is *homogeneous* if $X \in \mathcal{C}_\alpha \subset \mathcal{C}$ for some $\alpha \in G$. Such an α is then uniquely determined by X and denoted $|X|$. It is allowed for objects $X \in \mathcal{C}_\alpha, Y \in \mathcal{C}_\beta$ with $\alpha \neq \beta$ to be isomorphic. However, in this case, X and Y are *zero objects* in the sense that $\text{End}_{\mathcal{C}}(X) = \text{End}_{\mathcal{C}}(Y) = 0$.

The definition of G -graded categories given above is more general than the corresponding definition in [TV2] where we additionally require the existence of direct sums and the splitting of arbitrary objects into direct sums of homogeneous objects. These conditions will not be needed in the present paper.

3.2. G -crossed categories. Given a monoidal category \mathcal{C} , denote by $\text{Aut}(\mathcal{C})$ the category of strong monoidal auto-equivalences of \mathcal{C} . Its objects are strong monoidal functors $\mathcal{C} \rightarrow \mathcal{C}$ that are \mathbb{k} -linear on the Hom-sets and are equivalences of categories. The morphisms in $\text{Aut}(\mathcal{C})$ are monoidal natural isomorphisms. The category $\text{Aut}(\mathcal{C})$ has a canonical structure of a strict monoidal category, in which the monoidal product is the composition of monoidal functors and the monoidal unit is the identity endofunctor $1_{\mathcal{C}}$ of \mathcal{C} .

Denote by \overline{G} the category whose objects are elements of the group G and morphisms are identities. We view \overline{G} as a strict monoidal category with monoidal product $\alpha \otimes \beta = \beta\alpha$ for all $\alpha, \beta \in G$.

By a G -crossed category we mean a G -graded category \mathcal{C} endowed with a *crossing*, that is, a strong monoidal functor $\varphi: \overline{G} \rightarrow \text{Aut}(\mathcal{C})$ such that $\varphi_{\alpha}(\mathcal{C}_{\beta}) \subset \mathcal{C}_{\alpha^{-1}\beta\alpha}$ for all $\alpha, \beta \in G$. For each $\alpha \in G$, the crossing φ provides a strong monoidal equivalence $\varphi_{\alpha}: \mathcal{C} \rightarrow \mathcal{C}$. By definition, φ comes equipped with isomorphisms $(\varphi_{\alpha})_0: \mathbb{1} \xrightarrow{\sim} \varphi_{\alpha}(\mathbb{1})$ in \mathcal{C} and with natural isomorphisms

$$\begin{aligned} (\varphi_{\alpha})_2 &= \{(\varphi_{\alpha})_2(X, Y): \varphi_{\alpha}(X) \otimes \varphi_{\alpha}(Y) \xrightarrow{\sim} \varphi_{\alpha}(X \otimes Y)\}_{X, Y \in \mathcal{C}}, \\ \varphi_2 &= \{\varphi_2(\alpha, \beta) = \{\varphi_2(\alpha, \beta)_X: \varphi_{\alpha}\varphi_{\beta}(X) \xrightarrow{\sim} \varphi_{\beta\alpha}(X)\}_{X \in \mathcal{C}}\}_{\alpha, \beta \in G}, \\ \varphi_0 &= \{(\varphi_0)_X: X \xrightarrow{\sim} \varphi_1(X)\}_{X \in \mathcal{C}}, \end{aligned}$$

such that $(\varphi_0)_{\mathbb{1}} = (\varphi_1)_0$ and, for all $\alpha, \beta, \gamma \in G$ and $X, Y, Z \in \mathcal{C}$, the following diagrams commute:

$$(10) \quad \begin{array}{ccc} \varphi_{\alpha}(X) \otimes \varphi_{\alpha}(Y) \otimes \varphi_{\alpha}(Z) & \xrightarrow{\text{id}_{\varphi_{\alpha}(X)} \otimes (\varphi_{\alpha})_2(Y, Z)} & \varphi_{\alpha}(X) \otimes \varphi_{\alpha}(Y \otimes Z) \\ \downarrow (\varphi_{\alpha})_2(X, Y) \otimes \text{id}_{\varphi_{\alpha}(Z)} & & \downarrow (\varphi_{\alpha})_2(X, Y \otimes Z) \\ \varphi_{\alpha}(X \otimes Y) \otimes \varphi_{\alpha}(Z) & \xrightarrow{(\varphi_{\alpha})_2(X \otimes Y, Z)} & \varphi_{\alpha}(X \otimes Y \otimes Z) \end{array}$$

$$(11) \quad \begin{array}{ccc} \varphi_{\alpha}(X) & \xrightarrow{\text{id}_{\varphi_{\alpha}(X)} \otimes (\varphi_{\alpha})_0} & \varphi_{\alpha}(X) \otimes \varphi_{\alpha}(\mathbb{1}) \\ (\varphi_{\alpha})_0 \otimes \text{id}_{\varphi_{\alpha}(X)} \downarrow & \searrow \text{id}_{\varphi_{\alpha}(X)} & \downarrow (\varphi_{\alpha})_2(X, \mathbb{1}) \\ \varphi_{\alpha}(\mathbb{1}) \otimes \varphi_{\alpha}(X) & \xrightarrow{(\varphi_{\alpha})_2(\mathbb{1}, X)} & \varphi_{\alpha}(X) \end{array}$$

$$(12) \quad \begin{array}{ccc} & \varphi_{\beta\alpha}(X) \otimes \varphi_{\beta\alpha}(Y) & \\ \varphi_{\alpha}\varphi_{\beta}(X) \otimes \varphi_{\alpha}\varphi_{\beta}(Y) & \xrightarrow{\varphi_2(\alpha, \beta)_X \otimes \varphi_2(\alpha, \beta)_Y} & \varphi_{\beta\alpha}(X \otimes Y) \\ \downarrow (\varphi_{\alpha})_2(\varphi_{\beta}(X), \varphi_{\beta}(Y)) & & \uparrow \varphi_2(\alpha, \beta)_{X \otimes Y} \\ \varphi_{\alpha}(\varphi_{\beta}(X) \otimes \varphi_{\beta}(Y)) & \xrightarrow{\varphi_{\alpha}((\varphi_{\beta})_2(X, Y))} & \varphi_{\alpha}\varphi_{\beta}(X \otimes Y) \end{array}$$

$$(13) \quad \begin{array}{ccc} \mathbb{1} & \xrightarrow{(\varphi_{\beta\alpha})_0} & \varphi_{\beta\alpha}(\mathbb{1}) \\ (\varphi_\alpha)_0 \downarrow & & \uparrow \varphi_2(\alpha, \beta)_\mathbb{1} \\ \varphi_\alpha(\mathbb{1}) & \xrightarrow{\varphi_\alpha((\varphi_\beta)_0)} & \varphi_\alpha\varphi_\beta(\mathbb{1}) \end{array}$$

$$(14) \quad \begin{array}{ccc} X \otimes Y & \xrightarrow{(\varphi_0)_{X \otimes Y}} & \varphi_1(X \otimes Y) \\ & \searrow (\varphi_0)_X \otimes (\varphi_0)_Y & \nearrow (\varphi_1)_2(X, Y) \\ & & \varphi_1(X) \otimes \varphi_1(Y) \end{array}$$

$$(15) \quad \begin{array}{ccc} \varphi_\alpha\varphi_\beta\varphi_\gamma(X) & \xrightarrow{\varphi_\alpha(\varphi_2(\beta, \gamma)_X)} & \varphi_\alpha\varphi_{\gamma\beta}(X) \\ \varphi_2(\alpha, \beta)_{\varphi_\gamma(X)} \downarrow & & \downarrow \varphi_2(\alpha, \gamma\beta)_X \\ \varphi_{\beta\alpha}\varphi_\gamma(X) & \xrightarrow{\varphi_2(\beta\alpha, \gamma)_X} & \varphi_{\gamma\beta\alpha}(X) \end{array}$$

$$(16) \quad \begin{array}{ccc} \varphi_\alpha(X) & \xrightarrow{\varphi_\alpha((\varphi_0)_X)} & \varphi_\alpha\varphi_1(X) \\ (\varphi_0)_{\varphi_\alpha(X)} \downarrow & \searrow \text{id}_{\varphi_\alpha(X)} & \downarrow \varphi_2(\alpha, 1)_X \\ \varphi_1\varphi_\alpha(X) & \xrightarrow{\varphi_2(1, \alpha)_X} & \varphi_\alpha(X) \end{array}$$

The commutativity of the diagrams (10) and (11) means that $(\varphi_\alpha, (\varphi_\alpha)_2, (\varphi_\alpha)_0)$ is a monoidal endofunctor of \mathcal{C} . The diagrams (12) and (13) indicate that the natural transformation $\varphi_2(\alpha, \beta)$ is monoidal. The diagram (14) and the equality $(\varphi_0)_\mathbb{1} = (\varphi_1)_0$ indicate that the natural transformation φ_0 is monoidal. The diagrams (15) and (16) indicate that $(\varphi, \varphi_2, \varphi_0)$ is a monoidal functor.

Crossings in G -graded categories were introduced in [Tu2] in the special case where φ and all φ_α 's are strict monoidal functors, that is, all the morphisms $\varphi_2(\alpha, \beta)_X$, $(\varphi_0)_X$, $(\varphi_\alpha)_2(X, Y)$, and $(\varphi_\alpha)_0$ are identity morphisms.

3.3. Pivotality. A G -graded category \mathcal{C} is *pivotal* if the underlying monoidal category of \mathcal{C} is pivotal and for all $\alpha \in G$ and $X \in \mathcal{C}_\alpha$ we have $X^* \in \mathcal{C}_{\alpha^{-1}}$. A crossing φ in a pivotal G -graded category \mathcal{C} is *pivotal* if all the functors $\{\varphi_\alpha: \mathcal{C} \rightarrow \mathcal{C}\}_{\alpha \in G}$ are pivotal (see Section 2.5). Then we have for each $\alpha \in G$ a monoidal natural isomorphism

$$\varphi_\alpha^1 = \{\varphi_\alpha^1(X): \varphi_\alpha(X^*) \xrightarrow{\sim} \varphi_\alpha(X)^*\}_{X \in \mathcal{C}}$$

which preserves both left and right duality.

We shall use the crossing φ to define the following transformations of morphisms in \mathcal{C} . Given an isomorphism $\psi: X \rightarrow \varphi_\alpha(Y)$ with $X, Y \in \mathcal{C}$ and $\alpha \in G$, we let $\overline{\psi}: Y \rightarrow \varphi_{\alpha^{-1}}(X)$ be the following composition of isomorphisms:

$$Y \xrightarrow{(\varphi_0)_Y} \varphi_1(Y) \xrightarrow{\varphi_2(\alpha^{-1}, \alpha)_Y^{-1}} \varphi_{\alpha^{-1}}\varphi_\alpha(Y) \xrightarrow{\varphi_{\alpha^{-1}}(\psi^{-1})} \varphi_{\alpha^{-1}}(X).$$

If \mathcal{C} and φ are pivotal, we let $\psi^- : X^* \rightarrow \varphi_\alpha(Y^*)$ be the following composition of isomorphisms:

$$X^* \xrightarrow{(\psi^-)^*} \varphi_\alpha(Y)^* \xrightarrow{\varphi_\alpha^1(Y)^{-1}} \varphi_\alpha(Y^*).$$

We also sometimes write ψ^+ for ψ itself.

Lemma 3.1. *In the above notation, $\overline{\psi^-} = (\overline{\psi})^- : Y^* \rightarrow \varphi_{\alpha^{-1}}(X^*)$.*

Proof. We begin with three observations which are direct consequences of the definitions given in Section 2.5. Firstly, if $F : \mathcal{C} \rightarrow \mathcal{D}$ is a pivotal functor between pivotal categories and $f : X \rightarrow Y$ is a morphism in \mathcal{C} , then

$$(17) \quad F(f)^* = F^1(X)F(f^*)F^1(Y)^{-1}.$$

Secondly, if $F : \mathcal{C} \rightarrow \mathcal{D}$ and $G : \mathcal{D} \rightarrow \mathcal{E}$ are pivotal functors between pivotal categories, then for any $X \in \mathcal{C}$,

$$(18) \quad (GF)^1(X) = G^1(F(X))G(F^1(X)).$$

Thirdly, if $F, G : \mathcal{C} \rightarrow \mathcal{D}$ are pivotal functors between pivotal categories, then any monoidal natural transformation $\lambda = \{\lambda_X : F(X) \rightarrow G(X)\}_{X \in \mathcal{C}}$ is invertible and

$$(19) \quad \lambda_X^* G^1(X) = F^1(X) \lambda_{X^*}^{-1}$$

for all $X \in \mathcal{C}$. Now,

$$\begin{aligned} \overline{\psi^-} &\stackrel{(i)}{=} \varphi_{\alpha^{-1}}(\psi^*)\varphi_{\alpha^{-1}}(\varphi_\alpha^1(Y))\varphi_2(\alpha^{-1}, \alpha)_{Y^*}^{-1}(\varphi_0)_{Y^*} \\ &\stackrel{(ii)}{=} \varphi_{\alpha^{-1}}^1(X)^{-1}\varphi_{\alpha^{-1}}(\psi)^*\varphi_{\alpha^{-1}}^1(\varphi_\alpha(Y))\varphi_{\alpha^{-1}}(\varphi_\alpha^1(Y))\varphi_2(\alpha^{-1}, \alpha)_{Y^*}^{-1}(\varphi_0)_{Y^*} \\ &\stackrel{(iii)}{=} \varphi_{\alpha^{-1}}^1(X)^{-1}\varphi_{\alpha^{-1}}(\psi)^*(\varphi_{\alpha^{-1}}\varphi_\alpha)^1(Y)\varphi_2(\alpha^{-1}, \alpha)_{Y^*}^{-1}(\varphi_0)_{Y^*} \\ &\stackrel{(iv)}{=} \varphi_{\alpha^{-1}}^1(X)^{-1}\varphi_{\alpha^{-1}}(\psi)^*\varphi_2(\alpha^{-1}, \alpha)_{Y^*}^*\varphi_1^1(Y)(\varphi_0)_{Y^*} \\ &\stackrel{(v)}{=} \varphi_{\alpha^{-1}}^1(X)^{-1}\varphi_{\alpha^{-1}}(\psi)^*\varphi_2(\alpha^{-1}, \alpha)_{Y^*}^*((\varphi_0)_{Y^*}^{-1})^* \stackrel{(vi)}{=} (\overline{\psi})^-. \end{aligned}$$

Here, the equalities (i) – (vi) follow respectively from the definition of $\overline{\psi^-}$, (17), (18), (19) with $\lambda = \varphi_2(\alpha^{-1}, \alpha)$, (19) with $\lambda = \varphi_0^{-1}$, the definition of $(\overline{\psi})^-$. \square

3.4. The fusion algebra. With every G -graded category \mathcal{C} over \mathbb{k} , one associates a G -graded \mathbb{k} -algebra $L(\mathcal{C})$ called the *fusion algebra* or the *Verlinde algebra* of \mathcal{C} . Specifically, for each $\alpha \in G$, set $\tilde{L}_\alpha = \bigoplus_X \text{End}_{\mathcal{C}}(X)$ where X runs over all objects of \mathcal{C}_α . The element of the \mathbb{k} -module \tilde{L}_α represented by $f \in \text{End}_{\mathcal{C}}(X)$ is denoted $\langle X, f \rangle$ or briefly $\langle f \rangle$. Let L_α be the quotient of \tilde{L}_α by all relations of type $\langle X, fg \rangle = \langle Y, gf \rangle$ for morphisms $f : Y \rightarrow X$ and $g : X \rightarrow Y$ in \mathcal{C}_α . We provide the \mathbb{k} -module $L = \bigoplus_{\alpha \in G} L_\alpha$ with multiplication $\langle f \rangle \langle f' \rangle = \langle f \otimes f' \rangle$. This turns $L = L(\mathcal{C})$ into an associative G -graded \mathbb{k} -algebra with unit $\langle \text{id}_1 \rangle$. Every homogeneous object $X \in \mathcal{C}$ determines a vector $\langle X \rangle = \langle \text{id}_X \rangle \in L$.

If \mathcal{C} is crossed, then its crossing φ induces a group homomorphism $\varphi : G \rightarrow \text{Aut}(L)$, where $\text{Aut}(L)$ denotes the group of algebra automorphisms of L . For $\alpha \in G$, φ_α carries any generator $\langle f \rangle$ to $\langle \varphi_\alpha(f) \rangle$. Clearly, $\varphi_\alpha(L_\beta) \subset L_{\alpha^{-1}\beta\alpha}$.

If \mathcal{C} is pivotal, then L is endowed with a canonical \mathbb{k} -linear endomorphism $*$: $L \rightarrow L$ defined by sending a generator $\langle X, f \rangle$ to the generator $\langle X^*, f^* \rangle$. One can prove that $*$ is an involutive algebra anti-automorphism of L carrying each L_α onto $L_{\alpha^{-1}}$.

If \mathcal{C} is crossed and pivotal, and its crossing φ is pivotal, then (17) implies that $*$: $L \rightarrow L$ commutes with the crossing: $\varphi_\alpha * = * \varphi_\alpha$ for all $\alpha \in G$.

4. G -BRAIDED AND G -RIBBON CATEGORIES

Given a G -graded category \mathcal{C} , we let $\mathcal{C}_{\text{hom}} = \coprod_{\alpha \in G} \mathcal{C}_\alpha$ be the full subcategory of homogeneous objects of \mathcal{C} , cf. Section 3.1. Note that \mathcal{C}_{hom} is itself a G -graded category in the sense of Section 3.1 such that $(\mathcal{C}_{\text{hom}})_{\text{hom}} = \mathcal{C}_{\text{hom}}$.

4.1. G -braided categories. A G -braided category is a G -crossed category (\mathcal{C}, φ) endowed with a G -braiding, that is, a family of isomorphisms

$$\tau = \{\tau_{X,Y}: X \otimes Y \rightarrow Y \otimes \varphi_{|Y|}(X)\}_{X \in \mathcal{C}, Y \in \mathcal{C}_{\text{hom}}}$$

natural in X, Y and such that:

(a) for all $X \in \mathcal{C}$ and $Y, Z \in \mathcal{C}_{\text{hom}}$, the following diagram commutes:

$$(20) \quad \begin{array}{ccc} X \otimes Y \otimes Z & \xrightarrow{\tau_{X,Y \otimes Z}} & Y \otimes Z \otimes \varphi_{|Y \otimes Z|}(X) \\ \tau_{X,Y} \otimes \text{id}_Z \downarrow & & \uparrow \text{id}_Y \otimes \varphi_2(|Z|, |Y|)_X \\ Y \otimes \varphi_{|Y|}(X) \otimes Z & \xrightarrow{\text{id}_Y \otimes \tau_{\varphi_{|Y|}(X), Z}} & Y \otimes Z \otimes \varphi_{|Z|} \varphi_{|Y|}(X); \end{array}$$

(b) for all $X, Y \in \mathcal{C}$ and $Z \in \mathcal{C}_{\text{hom}}$, the following diagram commutes:

$$(21) \quad \begin{array}{ccc} X \otimes Y \otimes Z & \xrightarrow{\tau_{X \otimes Y, Z}} & Z \otimes \varphi_{|Z|}(X \otimes Y) \\ \text{id}_X \otimes \tau_{Y, Z} \downarrow & & \uparrow \text{id}_Z \otimes (\varphi_{|Z|})_2(X, Y) \\ X \otimes Z \otimes \varphi_{|Z|}(Y) & \xrightarrow{\tau_{X, Z} \otimes \text{id}_{\varphi_{|Z|}(Y)}} & Z \otimes \varphi_{|Z|}(X) \otimes \varphi_{|Z|}(Y); \end{array}$$

(c) for all $\alpha \in G$, $X \in \mathcal{C}$, and $Y \in \mathcal{C}_{\text{hom}}$, the following diagram commutes:

$$(22) \quad \begin{array}{ccc} \varphi_\alpha(X) \otimes \varphi_\alpha(Y) & \xrightarrow{(\varphi_\alpha)_2(X, Y)} & \varphi_\alpha(X \otimes Y) \\ \tau_{\varphi_\alpha(X), \varphi_\alpha(Y)} \downarrow & & \downarrow \varphi_\alpha(\tau_{X, Y}) \\ \varphi_\alpha(Y) \otimes \varphi_{\alpha^{-1}|Y|} \varphi_\alpha(X) & & \varphi_\alpha(Y \otimes \varphi_{|Y|}(X)) \\ \downarrow \text{id}_{\varphi_\alpha(Y)} \otimes \varphi_2(\alpha^{-1}|Y|, \alpha)_X & & \uparrow (\varphi_\alpha)_2(Y, \varphi_{|Y|}(X)) \\ \varphi_\alpha(Y) \otimes \varphi_{|Y|} \varphi_\alpha(X) & \xrightarrow{\text{id}_{\varphi_\alpha(Y)} \otimes \varphi_2(\alpha, |Y|)_X^{-1}} & \varphi_\alpha(Y) \otimes \varphi_\alpha \varphi_{|Y|}(X). \end{array}$$

The diagrams (20) and (21) are the analogues of the usual braiding relations in braided categories while (22) expresses the ‘‘invariance’’ of τ under φ . We will depict the G -braiding τ and its inverse as follows

$$\tau_{X,Y} = \begin{array}{c} Y \swarrow \quad \searrow \varphi_{|Y|}(X) \\ \bullet \\ X \swarrow \quad \searrow Y \end{array} \quad \text{and} \quad \tau_{Y,X}^{-1} = \begin{array}{c} X \swarrow \quad \searrow Y \\ \bullet \\ Y \swarrow \quad \searrow \varphi_{|Y|}(X) \end{array}$$

Lemma 4.1. *Let $(\mathcal{C}, \varphi, \tau)$ be a G -braided category. Then:*

(a) $\tau_{X, \mathbb{1}} = (\varphi_0)_X$ for all $X \in \mathcal{C}$;

- (b) $\tau_{\mathbb{1}, X} = \text{id}_X \otimes (\varphi_{|X|})_0$ for all $X \in \mathcal{C}_{\text{hom}}$;
 (c) The G -braiding τ satisfies the following quantum Yang-Baxter equation: for all $X \in \mathcal{C}$, $Y \in \mathcal{C}_\beta$, $Z \in \mathcal{C}_\gamma$ with $\beta, \gamma \in G$,

The diagram shows two braiding configurations separated by an equals sign. On the left, three strands labeled Z , X , and Y enter from the top. The Z and X strands cross, then the X and Y strands cross, and finally the Z and Y strands cross. A box labeled $\varphi_2(\gamma, \beta)_X$ is placed between the X and Y strands. On the right, the strands enter from the top in the same order, but the crossings are rearranged: first X and Y cross, then Z and Y cross, and finally Z and X cross. A box labeled $\varphi_2(\gamma^{-1}\beta\gamma, \gamma)_X$ is placed between the X and Y strands.

- (d) If \mathcal{C} is pivotal, then for all $X \in \mathcal{C}$ and $Y \in \mathcal{C}_\beta$ with $\beta \in G$,

The diagram shows an equality between two braiding configurations. On the left, a box labeled $(\varphi_0)_X^{-1} \varphi_2(\beta^{-1}, \beta)_X$ is placed between two strands labeled X and Y . The X strand goes down and then right, crossing over the Y strand, which goes down and then right. On the right, a box labeled $\varphi'_\beta(X)$ is placed between two strands labeled X and Y . The X strand goes down and then right, crossing under the Y strand, which goes down and then right.

Proof. By the naturality of τ and φ_0 , if (a) holds for some $X \in \mathcal{C}$, then it holds for all objects of \mathcal{C} isomorphic to X . Since φ_1 is an auto-equivalence of \mathcal{C} , it is enough to check (a) for the objects of type $\varphi_1(X)$ where $X \in \mathcal{C}$. Setting $Y = Z = \mathbb{1}$ in (20) we obtain $\tau_{X, \mathbb{1}} = \varphi_2(1, 1)_X \tau_{\varphi_1(X), \mathbb{1}} \tau_{X, \mathbb{1}}$. Multiplying by $\tau_{X, \mathbb{1}}^{-1}$ and using (16), we obtain that $\tau_{\varphi_1(X), \mathbb{1}} = (\varphi_2(1, 1)_X)^{-1} = (\varphi_0)_{\varphi_1(X)}$.

Let us prove (b). Since $\tau_{\mathbb{1}, Z}$ is an isomorphism, putting $X = Y = \mathbb{1}$ in (21) gives $\text{id}_{Z \otimes \varphi_{|Z|}(\mathbb{1})} = (\text{id}_Z \otimes (\varphi_{|Z|})_2(\mathbb{1}, \mathbb{1}))(\tau_{\mathbb{1}, Z} \otimes \text{id}_{\varphi_{|Z|}(\mathbb{1})})$. We conclude by composing on the right with $\text{id}_Z \otimes (\varphi_{|Z|})_0$, since $(\varphi_{|Z|})_2(\mathbb{1}, \mathbb{1})(\text{id}_{\varphi_{|Z|}(\mathbb{1})} \otimes (\varphi_{|Z|})_0) = \text{id}_{\varphi_{|Z|}(\mathbb{1})}$ by (11).

Let us prove (c). The naturality of the G -braiding gives

$$\tau_{Y \otimes \varphi_{|Y|}(X), Z}(\tau_{X, Y} \otimes \text{id}_Z) = (\text{id}_Z \otimes \varphi_{|Z|}(\tau_{X, Y}))\tau_{X \otimes Y, Z}.$$

We use (21) to expand $\tau_{X \otimes Y, Z}$ on the right and $\tau_{Y \otimes \varphi_{|Y|}(X), Z}$ on the left. Then we use (22) to replace on the right $\varphi_{|Z|}(\tau_{X, Y})(\varphi_{|Z|})_2(X, Y)$ by a composition of 4 arrows. This gives a formula equivalent to (c).

We now prove (d). Depicting $\text{id}_{\mathbb{1}}$ by a dotted line, we obtain

The diagram shows a sequence of three braiding configurations connected by equals signs and labeled (i), (ii), and (iii). In (i), a vertical strand labeled X is on the left. A strand labeled Y enters from the bottom, goes up, crosses over the X strand, and then goes down. A dotted line represents $\text{id}_{\mathbb{1}}$ between the X and Y strands. A box labeled $(\varphi_0)_X^{-1}$ is placed between the X and Y strands. In (ii), the X strand is now on the right. The Y strand enters from the bottom, goes up, crosses over the X strand, and then goes down. A box labeled $\text{id}_{Y \otimes Y^*}$ is placed between the X and Y strands. In (iii), the X strand is on the right. The Y strand enters from the bottom, goes up, crosses over the X strand, and then goes down. A box labeled $(\varphi_0)_X^{-1} \varphi_2(\beta^{-1}, \beta)_X$ is placed between the X and Y strands.

where the equality (i) is obtained by applying (a), (ii) follows from the naturality of τ , and (iii) is obtained by applying (20) to $Z = Y^*$. Substituting the resulting

equality in the dotted box below, we obtain

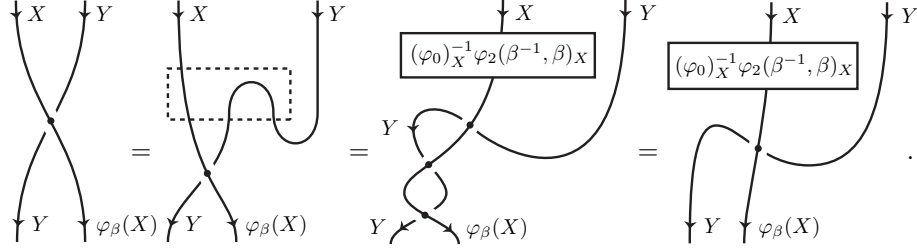

Similarly,

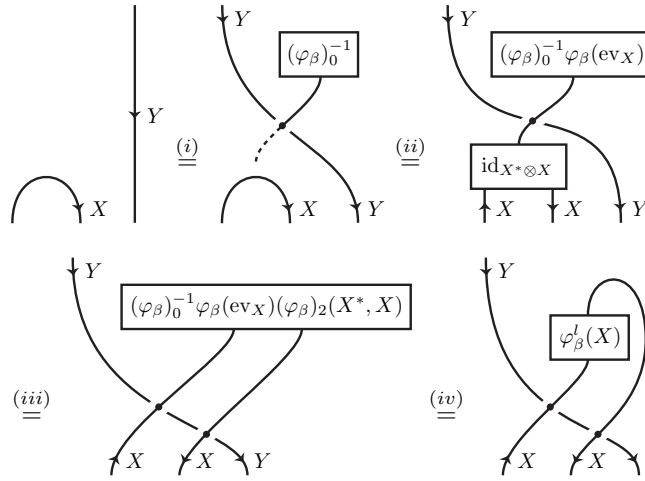

where (i) is obtained by applying (a), (ii) follows from the naturality of τ , (iii) follows from (21), and (iv) is obtained by applying (4) to $F = \varphi_\beta$. Finally, substituting the resulting equality in the dotted box below, we obtain

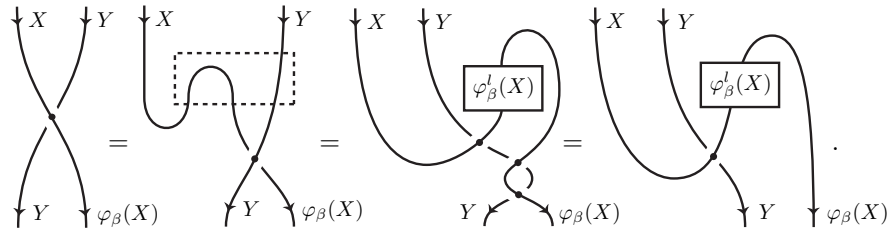

This concludes the proof of the lemma. \square

4.2. Twists. Consider a pivotal G -braided category $(\mathcal{C}, \varphi, \tau)$. The *twist* of \mathcal{C} is the family of morphisms $\theta = \{\theta_X : X \rightarrow \varphi_{|X|}(X)\}_{X \in \mathcal{C}_{\text{hom}}}$ defined by

$$(23) \quad \theta_X = (\text{ev}_X \otimes \text{id}_{\varphi_{|X|}(X)})(\text{id}_{X^*} \otimes \tau_{X,X})(\widetilde{\text{coev}}_X \otimes \text{id}_X) = \text{Diagram}.$$

The naturality of τ implies that θ_X is natural in X . Lemma 4.1(a) implies that $\theta_{\mathbf{1}} = (\varphi_0)_{\mathbf{1}} = (\varphi_1)_0$.

Lemma 4.2. For any $X \in \mathcal{C}_\alpha$ with $\alpha \in G$, the twist θ_X is invertible and

$$\theta_X^{-1} = (\text{id}_X \otimes \tilde{\text{ev}}_{\varphi_\alpha(X)}) (\tau_{X, \varphi_\alpha(X)}^{-1} \otimes \text{id}_{\varphi_\alpha(X)^*}) (\text{id}_{\varphi_\alpha(X)} \otimes \text{coev}_{\varphi_\alpha(X)}) = \text{diagram}.$$

Proof. Denote the right-hand side by ϑ_X . Firstly,

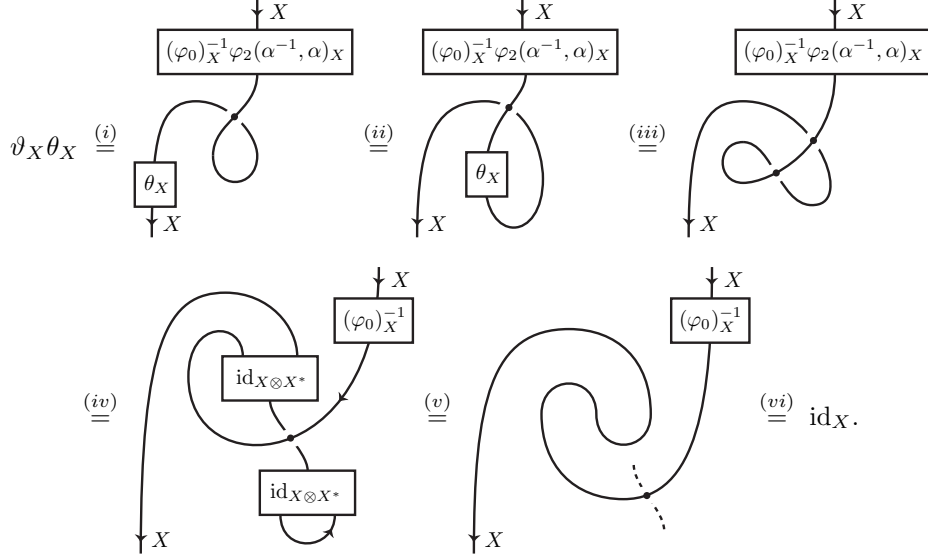

Here, (i) is obtained from the definition of ϑ_X by applying the first expression for τ^{-1} in Lemma 4.1(d), (ii) and (v) follow from the naturality of τ and (iii) from the definition of θ_X , (iv) is obtained by applying (20), and (vi) follows from Lemma 4.1(a). Secondly,

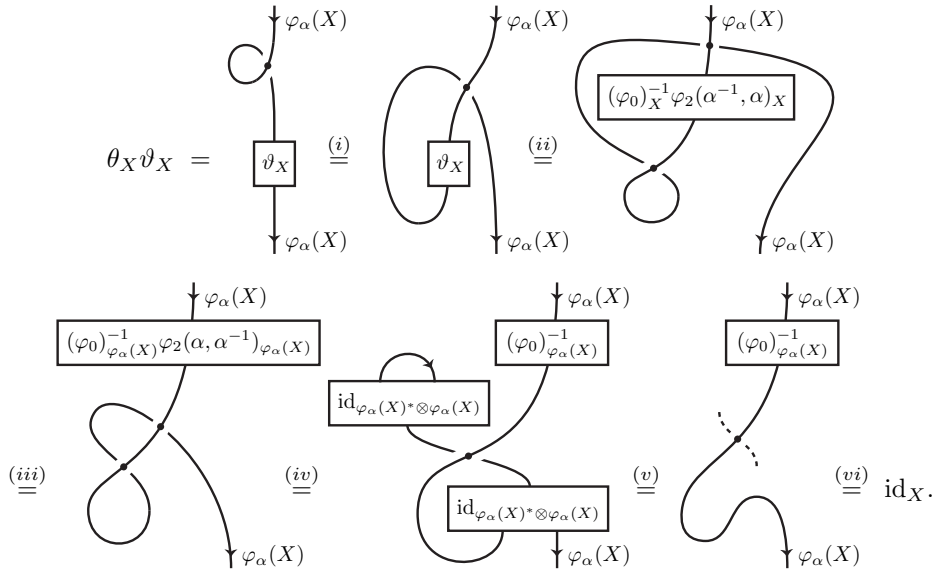

Here, (i) and (v) follow from the naturality of τ , (ii) is obtained from the definition of ϑ_X by applying the first expression for τ^{-1} in Lemma 4.1(d), (iii) follows from the naturality of τ and the equality

$$(24) \quad \varphi_\alpha((\varphi_0)_X^{-1} \varphi_2(\alpha^{-1}, \alpha)_X) = (\varphi_0)_{\varphi_\alpha(X)}^{-1} \varphi_2(\alpha, \alpha^{-1})_{\varphi_\alpha(X)}$$

which is a consequence of (15) and (16), (iv) is obtained by applying (20), and (vi) follows from Lemma 4.1(a). Thus θ_X is invertible and $\theta_X^{-1} = \vartheta_X$. \square

Lemma 4.3. For any $X \in \mathcal{C}_\alpha$, $Y \in \mathcal{C}_\beta$ with $\alpha, \beta \in G$,

$$\theta_{X \otimes Y} = \begin{array}{c} \downarrow \varphi_{\alpha\beta}(X \otimes Y) \\ \boxed{(\varphi_{\alpha\beta})_2(X, Y)} \\ \swarrow \quad \searrow \\ \boxed{\varphi_2(\beta, \alpha)_X} \quad \boxed{\varphi_2(\beta^{-1}\alpha\beta, \beta)_Y} \\ \swarrow \quad \searrow \\ \theta_X \quad \theta_Y \\ \downarrow \quad \downarrow \\ X \quad Y \end{array} .$$

Proof. We have

$$\theta_{X \otimes Y} \stackrel{(i)}{=} \begin{array}{c} \downarrow \varphi_{\alpha\beta}(X \otimes Y) \\ \text{loop} \\ \downarrow X \otimes Y \end{array} \stackrel{(ii)}{=} \begin{array}{c} \downarrow \varphi_{\alpha\beta}(X \otimes Y) \\ \boxed{(\varphi_{\alpha\beta})_2(X, Y)} \\ \swarrow \quad \searrow \\ \text{loop} \quad \downarrow \\ \boxed{\text{id}_{X \otimes Y}} \\ \downarrow X \otimes Y \end{array}$$

$$\stackrel{(iii)}{=} \begin{array}{c} \downarrow \varphi_{\alpha\beta}(X \otimes Y) \\ \boxed{(\varphi_{\alpha\beta})_2(X, Y)} \\ \swarrow \quad \searrow \\ \boxed{\varphi_2(\beta, \alpha)_X} \quad \boxed{\varphi_2(\beta, \alpha)_Y} \\ \swarrow \quad \searrow \\ \text{loop} \quad \downarrow \\ X \quad Y \end{array} \stackrel{(iv)}{=} \begin{array}{c} \downarrow \varphi_{\alpha\beta}(X \otimes Y) \\ \boxed{(\varphi_{\alpha\beta})_2(X, Y)} \\ \swarrow \quad \searrow \\ \boxed{\varphi_2(\beta, \alpha)_X} \quad \boxed{\varphi_2(\beta, \alpha)_Y} \\ \swarrow \quad \searrow \\ \text{loop} \quad \downarrow \\ \boxed{\theta_X} \\ \downarrow X \quad \downarrow Y \end{array}$$

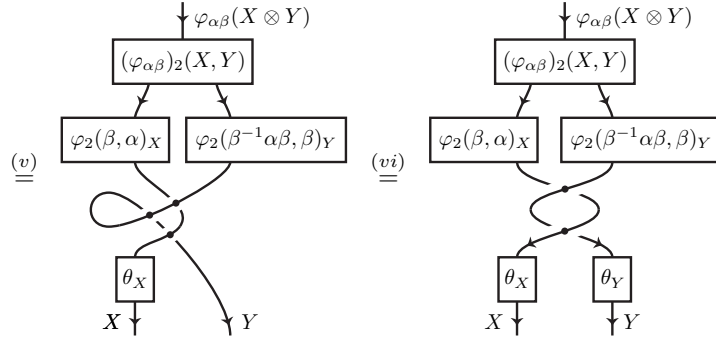

Here, (i) follows from the definition of $\theta_{X \otimes Y}$, (ii) is obtained from (21), (iii) is obtained by applying (20) twice, (iv) follows from the definition of θ_X and the naturality of τ , (v) is obtained by Lemma 4.1(c), and (vi) follows from the definition of θ_Y and the naturality of τ . \square

Lemma 4.4. *If the crossing φ in \mathcal{C} is pivotal, then for all $\alpha, \beta \in G$ and $X \in \mathcal{C}_\alpha$,*

$$\varphi_\beta(\theta_X) = \varphi_2(\beta, \alpha)_X^{-1} \varphi_2(\beta^{-1}\alpha\beta, \beta)_X \theta_{\varphi_\beta(X)}.$$

Proof. Set $\psi = \varphi_2(\beta, \alpha)_X^{-1} \varphi_2(\beta^{-1}\alpha\beta, \beta)_X$. Then

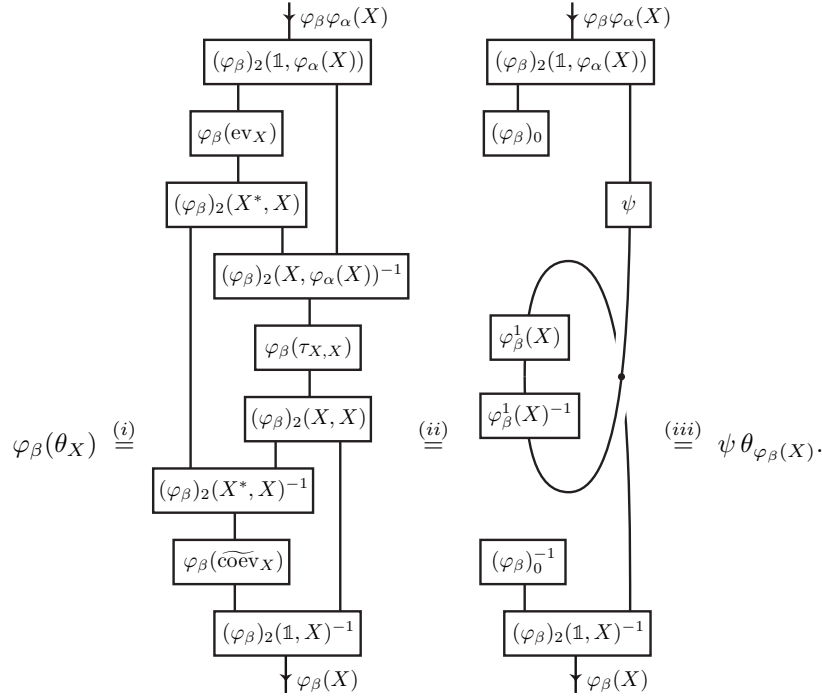

Here, (i) is obtained by writing

$$\theta_X = (\text{ev}_X \otimes \text{id}_{\varphi_\alpha(X)})(\text{id}_{X^*} \otimes \tau_{X,X})(\widetilde{\text{coev}}_X \otimes \text{id}_X)$$

and applying the monoidality of φ_β , (ii) is obtained by applying (22), (4), and (7), and (iii) follows from (11). \square

4.3. G -ribbon categories. A G -ribbon category is a pivotal G -braided category \mathcal{C} such that its crossing φ is pivotal and its twist θ is *self-dual* in the sense that for all $\alpha \in G$ and all $X \in \mathcal{C}_\alpha$,

$$(25) \quad (\theta_X)^* = (\varphi_0)_X^* (\varphi_2(\alpha^{-1}, \alpha)_X^{-1})^* \varphi_{\alpha^{-1}}^1(\varphi_\alpha(X)) \theta_{\varphi_\alpha(X)}^*.$$

For examples of G -ribbon categories, see [Tu2], [TV3]. The following lemmas yield a useful consequence of self-duality for twists.

Lemma 4.5. *If the twist θ in a pivotal G -braided category \mathcal{C} is self-dual, then for all $\alpha \in G$ and $X \in \mathcal{C}_\alpha$,*

$$\theta_X = \begin{array}{c} \downarrow \varphi_\alpha(X) \\ \circlearrowleft \\ \downarrow X \end{array} \quad \text{and} \quad \theta_X^{-1} = \begin{array}{c} \downarrow X \\ \circlearrowright \\ \downarrow \varphi_\alpha(X) \end{array}.$$

Proof. We have

$$\begin{array}{ccc} \theta_X & \stackrel{(i)}{=} & \begin{array}{c} \downarrow \varphi_\alpha(X) \\ \circlearrowleft \\ \downarrow X \end{array} \\ & & \begin{array}{c} \downarrow \varphi_\alpha(X) \\ \circlearrowright \\ \downarrow X \end{array} \\ & & \begin{array}{c} \downarrow \varphi_\alpha(X) \\ \text{[}\varphi_{\alpha^{-1}}^1(\varphi_\alpha(X))\text{]} \\ \circlearrowleft \\ \text{[}\varphi_2(\alpha^{-1}, \alpha)_X^{-1}(\varphi_0)_X\text{]} \\ \downarrow X \end{array} \\ & & \begin{array}{c} \downarrow \varphi_\alpha(X) \\ \text{[}\varphi_0^{-1}_{\varphi_\alpha(X)}\varphi_2(\alpha, \alpha^{-1})_{\varphi_\alpha(X)}\text{]} \\ \downarrow \\ \text{[}\varphi_2(\alpha^{-1}, \alpha)_X^{-1}(\varphi_0)_X\text{]} \\ \downarrow X \end{array} \\ & & \begin{array}{c} \downarrow \varphi_\alpha(X) \\ \circlearrowright \\ \downarrow X \end{array} \\ & & \stackrel{(iv)}{=} \end{array}$$

Here, (i) follows from the pivotality of \mathcal{C} , (ii) is obtained from (25) and the definition of $\theta_{\varphi_\alpha(X)}$, (iii) is obtained by applying the second equality of Lemma 4.1(d), and (iv) follows from the naturality of τ and (24).

The proof of the second equality of the lemma uses the first equality and is similar to the proof of Lemma 4.2. \square

4.4. The category \mathcal{C}_1 . Given a G -ribbon category $(\mathcal{C}, \varphi, \tau)$ with twist θ , the category \mathcal{C}_1 is a ribbon category in the usual sense of the word with braiding

$$\{c_{X,Y} = (\text{id}_Y \otimes (\varphi_0)_X^{-1}) \tau_{X,Y} : X \otimes Y \rightarrow Y \otimes X\}_{X,Y \in \mathcal{C}}$$

and twist $\{v_X = (\varphi_0)_X^{-1} \theta_X : X \rightarrow X\}_{X \in \mathcal{C}}$.

For $G = 1$, the definitions of G -braided/ G -ribbon categories are equivalent to the standard definitions of braided/ribbon categories.

5. COLORED G -GRAPHS

From now on, unless explicitly stated to the contrary, the symbol \mathcal{C} denotes a pivotal G -crossed category with pivotal crossing φ .

In this section, we introduce ribbon graphs in \mathbb{R}^3 and their colorings over \mathcal{C} .

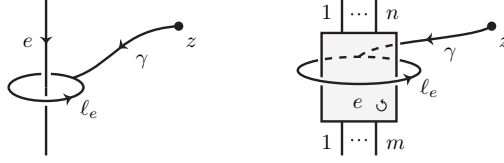

FIGURE 1. Meridian $\mu_\gamma = \gamma l_e \gamma^{-1}$ of an edge/coupon e

5.1. Ribbon graphs. We recall the notion of a ribbon graph following [Tu1]. A *coupon* is an oriented rectangle with a distinguished side called the bottom base; the opposite side is called the top base. A *ribbon graph* Ω with $k \geq 0$ *inputs* $((r, 0, 0))_{r=1}^k$ and $l \geq 0$ *outputs* $((s, 0, 1))_{s=1}^l$ consists of a finite family of coupons, oriented circles, and oriented segments embedded in $\mathbb{R} \times (-\infty, 1] \times [0, 1]$. The circles and the segments in question are called the *circle components* and the *edges* of Ω , respectively. The inputs and outputs of Ω should be among the endpoints of the edges, all the other endpoints of the edges should lie on the bases of the coupons. Otherwise, the edges, the circle components, and the coupons of Ω are disjoint. They are also supposed to carry a framing, i.e., a continuous nonsingular vector field on Ω transversal to Ω . It is required that near the inputs and outputs of Ω , the edges are straight segments parallel to the axis $\{(0, 0)\} \times \mathbb{R}$ and the framing is given by the vector $(0, \delta, 0)$ with small $\delta > 0$. The orientation of each coupon together with the framing should yield the negative (left-handed) orientation of \mathbb{R}^3 .

In the pictures we will use the following conventions: the first axis in $\mathbb{R}^2 \times [0, 1]$ is a horizontal line on the page of the picture directed to the right, the second axis is orthogonal to the plane of the picture and is directed from the eye of the reader towards this plane, the third axis is a vertical line on the plane of the picture directed from the bottom to the top. Note that points with positive second coordinate lie behind the plane of the picture. The distinguished bases of the coupons in the pictures are the bottom horizontal sides.

5.2. Tracks and meridians. Fix a base point $z \in \mathbb{R} \times [2, \infty) \times [0, 1]$. Given a ribbon graph Ω , we consider its complement $C_\Omega = (\mathbb{R}^2 \times [0, 1]) \setminus \Omega$ in $\mathbb{R}^2 \times [0, 1]$ and observe that $z \in C_\Omega$. We shall write $\pi_1(C_\Omega)$ for $\pi_1(C_\Omega, z)$. Pushing Ω along the framing we obtain a disjoint copy $\tilde{\Omega}$ of Ω . Pushing an edge/coupon e of Ω along the framing we obtain an edge/coupon \tilde{e} of $\tilde{\Omega}$. A path $\gamma: [0, 1] \rightarrow C_\Omega$ from the base point $z = \gamma(0)$ to a point of \tilde{e} is called a z -path for e . By a *homotopy* of a z -path γ we mean a deformation of γ in the class of z -paths in C_Ω fixing $\gamma(0) = z$ and keeping $\gamma(1)$ on \tilde{e} . The homotopy classes of z -paths for e are called *tracks* of e (with respect to z). Multiplication of loops based at z with z -paths defines a left action of $\pi_1(C_\Omega)$ on the set of tracks of e . Since \tilde{e} is contractible, this action is transitive and faithful. The tracks of edges (resp. coupons) of Ω are called *edge-tracks* (resp. *coupon-tracks*) of Ω . We do not define tracks for circle components of Ω .

For a z -path γ of an edge/coupon e , denote by $\mu_\gamma \in \pi_1(C_\Omega)$ the (negative) meridian of e represented by the loop $\gamma l_e \gamma^{-1}$, where l_e is a small loop in C_Ω encircling e with linking number -1 , see Figure 1. The meridian μ_γ depends only on the track represented by γ . Clearly, $\mu_{\beta\gamma} = \beta\mu_\gamma\beta^{-1}$ for any $\beta \in \pi_1(C_\Omega)$.

5.3. Colorings of graphs. By a G -graph we mean a ribbon graph Ω endowed with a group homomorphism $g: \pi_1(C_\Omega) \rightarrow G$. For brevity, we shall sometimes write Ω for the pair (Ω, g) . A \mathcal{C} -pre-coloring or shorter a pre-coloring u of a G -graph (Ω, g) comprises two functions. The first function assigns to every edge-track γ of Ω a non-zero object $u_\gamma \in \mathcal{C}_{g(\mu_\gamma)}$ called the *color* of γ . The second function assigns to every edge-track γ of Ω and to every $\beta \in \pi_1(C_\Omega)$ an isomorphism

$$u_{\beta, \gamma}: u_{\beta\gamma} \rightarrow \varphi_{g(\beta^{-1})}(u_\gamma)$$

so that for all γ , we have $u_{1, \gamma} = (\varphi_0)_{u_\gamma}: u_\gamma \rightarrow \varphi_1(u_\gamma)$ and for all $\beta, \delta \in \pi_1(C_\Omega)$, the following diagram commutes:

$$(26) \quad \begin{array}{ccc} u_{\beta\delta\gamma} & \xrightarrow{u_{\beta\delta, \gamma}} & \varphi_{g(\delta^{-1}\beta^{-1})}(u_\gamma) \\ u_{\beta, \delta\gamma} \downarrow & & \uparrow \varphi_{2(g(\beta^{-1}), g(\delta^{-1}))} u_\gamma \\ \varphi_{g(\beta^{-1})}(u_{\delta\gamma}) & \xrightarrow{\varphi_{g(\beta^{-1})}(u_{\delta, \gamma})} & \varphi_{g(\beta^{-1})}\varphi_{g(\delta^{-1})}(u_\gamma). \end{array}$$

One can extend this definition by allowing zero objects for colors of tracks. This however does not lead to interesting invariants of graphs, and we shall not do it.

A \mathcal{C} -coloring or shorter a coloring of a G -graph (Ω, g) consists of a pre-coloring u and a function v assigning to every coupon-track γ of Ω a morphism v_γ in $\mathcal{C}_{g(\mu_\gamma)}$. To state our requirements on v_γ , we need more terminology. By *entries* (resp. *exits*) of a coupon Q of Ω , we mean the endpoints of edges of Ω lying on the bottom (resp. top) side of Q . Let m be the number of entries of Q ; the direction of the bottom side induced by the orientation of Q determines an order in the set of the entries. Let e_i be the edge of Ω incident to the i -th entry where $i = 1, \dots, m$. Set $\varepsilon_i = +$ if e_i is directed out of Q near the i -th entry and set $\varepsilon_i = -$ otherwise. Composing a z -path representing γ with a path in \tilde{Q} leading to the i -th entry, we obtain a track γ_i of e_i depending only on γ and i . Similarly, let n be the number of exits of Q ; the direction of the top side of Q induced by the opposite orientation of Q determines an order in the set of the exits. Let e^j be the edge of Ω incident to the j -th exit where $j = 1, \dots, n$. Set $\varepsilon^j = -$ if e^j is directed out of Q and $\varepsilon^j = +$ otherwise. Composing a z -path representing γ with a path in \tilde{Q} leading to the j -th exit we obtain a well-defined track γ^j of e^j . Clearly,

$$\mu_\gamma = \mu_{\gamma_1}^{\varepsilon_1} \cdots \mu_{\gamma_m}^{\varepsilon_m} = \mu_{\gamma^1}^{\varepsilon^1} \cdots \mu_{\gamma^n}^{\varepsilon^n} \in \pi_1(C_\Omega).$$

We require that

- (i) for any coupon-track γ of Ω , we have (in the notation above)

$$(27) \quad v_\gamma \in \text{Hom}_{\mathcal{C}}(\otimes_{i=1}^m u_{\gamma_i}^{\varepsilon_i}, \otimes_{j=1}^n u_{\gamma^j}^{\varepsilon^j})$$

where for an object U of \mathcal{C} , we set $U^+ = U$ and $U^- = U^*$;

- (ii) for any γ as in (i) and any $\beta \in \pi_1(C_\Omega)$, the following diagram commutes:

$$(28) \quad \begin{array}{ccccc} \otimes_{i=1}^m u_{\beta\gamma_i}^{\varepsilon_i} & \xrightarrow{\otimes_{i=1}^m u_{\beta, \gamma_i}^{\varepsilon_i}} & \otimes_{i=1}^m \varphi_{g(\beta^{-1})}(u_{\gamma_i}^{\varepsilon_i}) & \xrightarrow{(\varphi_{g(\beta^{-1})})_m} & \varphi_{g(\beta^{-1})}(\otimes_{i=1}^m u_{\gamma_i}^{\varepsilon_i}) \\ v_{\beta\gamma} \downarrow & & & & \downarrow \varphi_{g(\beta^{-1})}(v_\gamma) \\ \otimes_{j=1}^n u_{\beta\gamma^j}^{\varepsilon^j} & \xrightarrow{\otimes_{j=1}^n u_{\beta, \gamma^j}^{\varepsilon^j}} & \otimes_{j=1}^n \varphi_{g(\beta^{-1})}(u_{\gamma^j}^{\varepsilon^j}) & \xrightarrow{(\varphi_{g(\beta^{-1})})_n} & \varphi_{g(\beta^{-1})}(\otimes_{j=1}^n u_{\gamma^j}^{\varepsilon^j}) \end{array}$$

where $u_{\beta,\gamma}^+ = u_{\beta,\gamma}$, $u_{\beta,\gamma}^- : u_{\beta\gamma}^* \rightarrow \varphi_{g(\beta-1)}(u_\gamma^*)$ is defined in Section 3.3, and the notation $(\varphi_\alpha)_n$ is defined in Section 2.4. In the case where $m = n = 1$ and $\varepsilon_1 = \varepsilon^1 = +$, the diagram (28) simplifies to

$$(29) \quad \begin{array}{ccc} u_{\beta\gamma_1} & \xrightarrow{u_{\beta,\gamma_1}} & \varphi_{g(\beta-1)}(u_{\gamma_1}) \\ v_{\beta\gamma} \downarrow & & \downarrow \varphi_{g(\beta-1)}(v_\gamma) \\ u_{\beta\gamma^1} & \xrightarrow{u_{\beta,\gamma^1}} & \varphi_{g(\beta-1)}(u_{\gamma^1}). \end{array}$$

When $m = 0$ and/or $n = 0$, we use in (27) and in similar formulas below the convention that an empty monoidal product of objects is the unit object.

Any pre-coloring u of a G -graph Ω can be extended to a coloring of Ω as follows: for each coupon Q of Ω pick a track γ of Q and a morphism v_γ as in (27). For all $\beta \in \pi_1(C_\Omega) \setminus \{1\}$, the morphism $v_{\beta\gamma}$ is determined uniquely from the diagram (28). One may check that this gives a coloring (u, v) of Ω .

5.4. The source and the target. Consider a G -graph $\Omega = (\Omega, g)$ with $k \geq 0$ inputs and $l \geq 0$ outputs. For $r = 1, \dots, k$ consider the path in C_Ω obtained as the product of the linear paths from the base point $z = (z_1, z_2, z_3)$ to $(r, z_2, 0)$ and from $(r, z_2, 0)$ to $(r, \delta, 0)$, where δ is a small positive real number. This product is a z -path of the edge of Ω incident to the r -th input. The corresponding track is denoted γ_r and called the r -th input track of Ω . Also we define a sign ε_r to be $+$ if the edge of Ω incident to the r -th input is directed down (into $\mathbb{R}^2 \times (-\infty, 0]$) and to be $-$ otherwise. Similarly, for $s = 1, \dots, l$, the product of the linear paths from z to $(s, z_2, 1)$ and from $(s, z_2, 1)$ to $(s, \delta, 1)$ is a z -path of the edge of Ω incident to the s -th output. The corresponding track is denoted γ^s and called the s -th output track of Ω . Set $\varepsilon^s = +$ if the edge of Ω incident to the s -th output is directed down (into $\mathbb{R}^2 \times [0, 1]$) and set $\varepsilon^s = -$ otherwise. Given a pre-coloring u of Ω , the sequences $(u_{\gamma_1}, \varepsilon_1), \dots, (u_{\gamma_k}, \varepsilon_k)$ and $(u_{\gamma^1}, \varepsilon^1), \dots, (u_{\gamma^l}, \varepsilon^l)$ are called respectively the *source* and the *target* of the pre-colored G -graph (Ω, u) . Here $u_{\gamma_r} \in \mathcal{C}_{g(\mu_{\gamma_r})}$ and $u_{\gamma^s} \in \mathcal{C}_{g(\mu_{\gamma^s})}$ for all r, s . Clearly,

$$\mu_{\gamma_1}^{\varepsilon_1} \cdots \mu_{\gamma_k}^{\varepsilon_k} = \mu_{\gamma^1}^{\varepsilon^1} \cdots \mu_{\gamma^l}^{\varepsilon^l}.$$

5.5. Isomorphisms of colorings. Let $\Omega = (\Omega, g)$ be a G -graph. An *isomorphism* $u \approx u'$ of pre-colorings of Ω is a system of isomorphisms $f = \{f_\gamma : u_\gamma \rightarrow u'_\gamma\}_\gamma$, where γ runs over all edge-tracks of Ω , such that for any γ and any $\beta \in \pi_1(C_\Omega)$, the following diagram commutes:

$$(30) \quad \begin{array}{ccc} u_{\beta\gamma} & \xrightarrow{u_{\beta,\gamma}} & \varphi_{g(\beta-1)}(u_\gamma) \\ f_{\beta\gamma} \downarrow & & \downarrow \varphi_{g(\beta-1)}(f_\gamma) \\ u'_{\beta\gamma} & \xrightarrow{u'_{\beta,\gamma}} & \varphi_{g(\beta-1)}(u'_\gamma). \end{array}$$

Note that for $\beta = 1$ the commutativity of (30) follows from the definition of pre-colorings and the naturality of φ_0 .

Isomorphisms of pre-colorings may be used to replace the colors of edges with isomorphic objects. Specifically, suppose that u is a pre-coloring of Ω and that for each edge-track γ of Ω we have an object $u'_\gamma \in \mathcal{C}_{g(\mu_\gamma)}$ and an isomorphism

$f_\gamma: u_\gamma \rightarrow u'_\gamma$. Then the system $\{u'_\gamma\}_\gamma$ extends uniquely to a pre-coloring u' of Ω such that $f = \{f_\gamma\}_\gamma: u \rightarrow u'$ is an isomorphism of pre-colorings. Indeed, the morphisms $u'_{\beta,\gamma}$ can be uniquely recovered from (30). For example, given u , we can replace the color of any edge-track γ_0 via any isomorphism $f_0: u_{\gamma_0} \rightarrow V \in \mathcal{C}_{g(\mu_{\gamma_0})}$ keeping the colors of all the other edge-tracks. This is achieved by applying the procedure above to the system $u'_{\gamma_0} = V$, $f_{\gamma_0} = f_0$ and $u'_\gamma = u_\gamma$, $f_\gamma = \text{id}$ for $\gamma \neq \gamma_0$.

The following lemma shows that to specify a pre-coloring it is essentially enough to color one track for every edge.

Lemma 5.1. *Let E be the set of edges of Ω . Pick a track γ_e of e for all $e \in E$.*

- (i) *For any family of non-zero objects $\{u_e \in \mathcal{C}_{g(\mu_{\gamma_e})}\}_{e \in E}$, there is a pre-coloring u of Ω such that $u_{\gamma_e} = u_e$ for all $e \in E$.*
- (ii) *Given pre-colorings u, u' of Ω , any system of isomorphisms $\{u_{\gamma_e} \rightarrow u'_{\gamma_e}\}_{e \in E}$ extends uniquely to an isomorphism $u \approx u'$.*

Proof. Let us prove (i). For any track γ of $e \in E$, there is a unique element of $\pi_1(C_\Omega)$ denoted $\gamma_e \gamma^{-1}$ such that $(\gamma_e \gamma^{-1})\gamma = \gamma_e$. Set $u_\gamma = \varphi_{g(\gamma_e \gamma^{-1})}(u_e)$. For any $\beta \in \pi_1(C_\Omega)$, consider the isomorphism

$$\varphi_2(g(\beta^{-1}), g(\gamma_e \gamma^{-1}))_{u_e}: \varphi_{g(\beta^{-1})}\varphi_{g(\gamma_e \gamma^{-1})}(u_e) \rightarrow \varphi_{g(\gamma_e \gamma^{-1} \beta^{-1})}(u_e).$$

The source and the target of this isomorphism are the objects $\varphi_{g(\beta^{-1})}(u_\gamma)$ and $u_{\beta,\gamma}$, respectively. Let $u_{\beta,\gamma}$ be the inverse isomorphism $u_{\beta,\gamma} \rightarrow \varphi_{g(\beta^{-1})}(u_\gamma)$. The commutativity of the diagrams (15) and (16) implies that the functions $\gamma \mapsto u_\gamma$ and $(\gamma, \beta) \mapsto u_{\beta,\gamma}$ form a pre-coloring of Ω .

Clearly, $u_{\gamma_e} = \varphi_1(u_e)$ is isomorphic to u_e for all $e \in E$. Replacing the colors inductively as described before the lemma, we can ensure that $u_{\gamma_e} = u_e$ for all e .

Let us prove (ii). Fix a system of isomorphisms $\{f_e: u_{\gamma_e} \rightarrow u'_{\gamma_e}\}_{e \in E}$. Consider an isomorphism $f: u \rightarrow u'$ such that $f_{\gamma_e} = f_e$ for all $e \in E$. Replacing γ and β in (30) by γ_e and $\gamma \gamma_e^{-1}$, respectively, we obtain that for any track γ of an edge $e \in E$,

$$(31) \quad f_\gamma = (u'_{\gamma \gamma_e^{-1}, \gamma_e})^{-1} \varphi_{g(\gamma_e \gamma^{-1})}(f_e) u_{\gamma \gamma_e^{-1}, \gamma_e}: u_\gamma \rightarrow u'_\gamma.$$

This proves the uniqueness of $f = \{f_\gamma\}_\gamma$. To prove the existence of f , we define each f_γ by (31). The naturality of φ_0 implies that $f_{\gamma_e} = f_e$ for all $e \in E$. It remains to verify the commutativity of the diagram (30) for all β, γ . For $\gamma = \gamma_e$, the commutativity of (30) follows from the definition of f_γ . Any track γ of $e \in E$ expands as $\delta \gamma_e$ with $\delta \in \pi_1(C_\Omega)$ and the commutativity of (30) follows from the commutativity of the cubic diagram in which two horizontal squares are the diagram (26) with γ replaced by γ_e and a similar diagram with u replaced by u' , while the vertical isomorphisms relating these two squares are induced by f . \square

Consider two colorings (u, v) and (u', v') of Ω with the same source and target so that $u_\gamma = u'_\gamma$ for all input/output tracks γ of Ω . By an *isomorphism* $(u, v) \approx (u', v')$, we mean an isomorphism of pre-colorings $f: u \rightarrow u'$ such that for any input/output track γ of Ω , we have $f_\gamma = \text{id}: u_\gamma \rightarrow u'_\gamma$ and for any coupon Q of Ω and any track

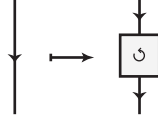

FIGURE 2. Stabilization

γ of Q , the following diagram commutes:

$$(32) \quad \begin{array}{ccc} \otimes_{i=1}^m u_{\gamma_i}^{\varepsilon_i} & \xrightarrow{v_\gamma} & \otimes_{j=1}^n u_{\gamma_j}^{\varepsilon_j} \\ \otimes_{i=1}^m f_{\gamma_i}^{\varepsilon_i} \downarrow & & \downarrow \otimes_{j=1}^n f_{\gamma_j}^{\varepsilon_j} \\ \otimes_{i=1}^m (u'_{\gamma_i})^{\varepsilon_i} & \xrightarrow{v'_\gamma} & \otimes_{j=1}^n (u'_{\gamma_j})^{\varepsilon_j} \end{array}$$

Here we use the notation of Section 5.3 and set

$$f_\gamma^+ = f_\gamma: u_\gamma \rightarrow u'_\gamma \quad \text{and} \quad f_\gamma^- = (f_\gamma^*)^{-1}: u_\gamma^* \rightarrow (u'_\gamma)^*.$$

Note that if the diagram (32) commutes for one track γ of Q , then it commutes for all tracks of Q . This follows from the commutativity of (28).

5.6. Color-equivalence. By a *self-homeomorphism* of $\mathbb{R}^2 \times [0, 1]$ we mean a homeomorphism $\mathbb{R}^2 \times [0, 1] \rightarrow \mathbb{R}^2 \times [0, 1]$ which is the identity outside a compact subset of $\mathbb{R} \times (-\infty, 1] \times (0, 1)$. Self-homeomorphisms of $\mathbb{R}^2 \times [0, 1]$ fix the base point z (for any choice of z as in Section 5.2) and act on colored G -graphs in the obvious way. Two colored G -graphs related by a self-homeomorphism of $\mathbb{R}^2 \times [0, 1]$ are *isotopic*. It is clear that colored G -graphs are isotopic if and only if there is a color-preserving deformation of one into the other in the class of colored G -graphs.

Two colored G -graphs are *color-equivalent* if they can be obtained from each other through isotopy and isomorphism of colorings. Color-equivalent colored G -graphs necessarily have the same source and the same target.

We define a “stable” version of the color-equivalence using the following transformation of colored G -graphs. Pick an edge of a colored G -graph (Ω, g, u, v) and insert in this edge a new coupon Q with one entry and one exit, see Figure 2 where the framing is orthogonal to the plane of the picture and is directed behind the picture. This gives a ribbon graph Ω' containing Ω as a subset. The inclusion of the graph complements $i: C_{\Omega'} \hookrightarrow C_\Omega$ is a homotopy equivalence. We now derive from the coloring (u, v) of (Ω, g) a coloring (u', v') of the G -graph $\Omega' = (\Omega', g_{i_*}: \pi_1(C_{\Omega'}) \rightarrow G)$. Composition with i transforms any edge-track γ of Ω' into an edge-track $i\gamma$ of Ω , and we set $u'_\gamma = u_{i\gamma}$. Similarly, set $u'_{\beta, \gamma} = u_{i_*(\beta), i\gamma}$ for $\beta \in \pi_1(C_{\Omega'})$. For any track γ of a coupon of Ω' distinct from Q , set $v'_\gamma = v_{i\gamma}$. For any track γ of Q , we have $i\gamma^1 = i\gamma_1$ so that $u'_{\gamma^1} = u'_{\gamma_1}$ and we set $v'_\gamma = \text{id}: u'_{\gamma^1} \rightarrow u'_{\gamma_1}$. We obtain in this way a colored G -graph Ω' with the same source and target as Ω . We call this construction *stabilization*. Two colored G -graphs are *stably color-equivalent* if stabilizing them several times we can obtain color-equivalent colored G -graphs.

5.7. Base points re-examined. The structure of a pre-colored G -graph on a ribbon graph Ω depends on the choice of a base point z in $Z = \mathbb{R} \times [2, \infty) \times [0, 1]$. We can transfer this structure along any path ρ in Z from z to $z' \in Z$. Given a homomorphism $g: \pi_1(C_\Omega, z) \rightarrow G$ and a pre-coloring u of (Ω, g) , we define a

homomorphism $g': \pi_1(C_\Omega, z') \rightarrow G$ and a pre-coloring u' of (Ω, g') by $g'(\beta) = g(\rho\beta\rho^{-1})$, $u'_\gamma = u_{\rho\gamma}$, and $u'_{\beta,\gamma} = u_{\rho\beta\rho^{-1},\rho\gamma}$ for any $\beta \in \pi_1(C_\Omega, z')$ and any edge-track γ of Ω with respect to z' . This gives a pre-colored G -graph (Ω, g', u') , the *transfer* of (Ω, g, u) along ρ . Clearly, transfers along homotopic paths are equal. Since Z is contractible, we can thus move between base points in a canonical way. Alternatively, we can consider Z as a “big base point”. As a consequence, we shall suppress the base point from the notation for pre-colored G -graphs. Similar remarks apply to colored G -graphs.

6. THE CATEGORY \mathcal{G}_C

In this section, we organize \mathcal{C} -colored G -graphs into a monoidal category $\mathcal{G} = \mathcal{G}_C$.

6.1. The category \mathcal{G} . The objects of \mathcal{G} are finite sequences $((U_r, \varepsilon_r))_{r=1}^k$ where $k \geq 0$, $\varepsilon_r = \pm$, and U_r is a non-zero homogeneous object of \mathcal{C} for $r = 1, \dots, k$. A morphism $((U_r, \varepsilon_r))_{r=1}^k \rightarrow ((U^s, \varepsilon^s))_{s=1}^l$ in \mathcal{G} is the stable color-equivalence class of a colored G -graph having no circle components and having the target $((U_r, \varepsilon_r))_{r=1}^k$ and the source $((U^s, \varepsilon^s))_{s=1}^l$. We now define composition of morphisms in \mathcal{G} . Consider two colored G -graphs $(\Omega^t = (\Omega^t, g^t, u^t, v^t))_{t=1,2}$ such that $\text{source}(\Omega^1) = \text{target}(\Omega^2) = ((U_r, \varepsilon_r))_{r=1}^k$. Stabilizing if necessary these graphs, we can assume that they have no edges with both endpoints lying in the set of inputs and outputs. Let ι^t be the embedding of the strip $\mathbb{R}^2 \times [0, 1]$ into itself carrying any point (x_1, x_2, x_3) to $(x_1, x_2, (x_3 + 4 - 2t)/3)$. Then $\iota^1(\Omega^1)$ (resp. $\iota^2(\Omega^2)$) lies in the upper (resp. lower) third of the strip. In the middle third $\mathbb{R}^2 \times [1/3, 2/3]$ we insert a row of k copies of the graph shown on the right picture in Figure 2 (with the orientation of the two edges in the r -th copy reversed to the upward direction whenever $\varepsilon_r = -$). The union, Ω , of these k copies with $\iota^1(\Omega^1) \cup \iota^2(\Omega^2)$ is a ribbon graph without circle components. The van Kampen theorem implies that there is a unique homomorphism $g: \pi_1(C_\Omega) \rightarrow G$ such that $g\iota_*^t = g^t: \pi_1(C_{\Omega^t}) \rightarrow G$ for $t = 1, 2$. Observe that any coloring (u, v) of the G -graph $\Omega = (\Omega, g)$ induces a coloring (u^t, v^t) of the G -graph $\Omega^t = (\Omega^t, g^t)$ for $t = 1, 2$. We show now that the given colorings of Ω^1 and Ω^2 determine a coloring of Ω .

Lemma 6.1. *Let $\gamma(r)$ be the linear path in C_Ω leading from the base point to the r -th coupon in $\mathbb{R}^2 \times [1/3, 2/3]$, where $r = 1, \dots, k$. There is a coloring (u, v) of the G -graph Ω such that*

$$(33) \quad u_{\gamma(r)_1} = u_{\gamma(r)_1} = U_r, \quad v_{\gamma(r)} = \text{id}: U_r^{\varepsilon_r} \rightarrow U_r^{\varepsilon_r} \quad \text{for } r = 1, \dots, k,$$

and $(u^t, v^t) \approx (u^t, v^t)$ for $t = 1, 2$. Such a coloring of Ω is unique up to isomorphism and for this coloring, $\text{source}(\Omega) = \text{source}(\Omega^2)$, $\text{target}(\Omega) = \text{target}(\Omega^1)$.

Proof. For $t = 1, 2$, denote by E^t the set of edges of Ω^t . For every edge $e \in E^t$ fix a track γ_e of e . We assume that if e is incident to an input (resp. output) of Ω^t , then γ_e is the corresponding input (resp. output) track of Ω^t . (Here we use the assumption that no edge of Ω^t has both endpoints among inputs and outputs.) Note that the set of edges of Ω can be identified with $E^1 \amalg E^2$.

We first prove the existence of (u, v) . For $e \in E^t$, the composition $\iota^t \gamma_e$ is a track of the edge of Ω containing $\iota^t(e)$. Clearly, $g(\mu_{\iota^t \gamma_e}) = g^t(\mu_{\gamma_e})$. Lemma 5.1(i) implies that there is a pre-coloring u of (Ω, g) such that $u_{\iota^t \gamma_e} = u_{\gamma_e}^t$ for all $e \in E^t$ and $t = 1, 2$. The choice of $\{\gamma_e\}_e$ ensures that if $e \in E^1$ is incident to the r -th input of Ω^1 , then $u_{\iota^1 \gamma_e} = u_{\gamma_e}^1 = U_r$, and if $e \in E^2$ is incident to the r -th output

of Ω^2 , then $u_{i^2\gamma_e} = u_{\gamma_e}^2 = U_r$. For $t = 1, 2$, consider the pre-coloring u^t of Ω^t . By definition, $(u^t)_{\gamma_e} = u_{i^t\gamma_e} = u_{\gamma_e}^t$ for all $e \in E^t$. By Lemma 5.1(ii), there is an isomorphism of pre-colorings $f^t: u^t \rightarrow u^t$ extending the identity morphisms $\{\text{id}: (u^t)_{\gamma_e} \rightarrow u_{\gamma_e}^t\}_{e \in E^t}$. Next, we extend u to a coloring (u, v) of Ω as follows. Fix a track γ_Q for every coupon Q of Ω^t with $t = 1, 2$. The morphism $v_{i^t\gamma_Q}$ is uniquely determined by the condition that the isomorphism of pre-colorings f^t carries $v_{i^t\gamma_Q}$ to $v_{\gamma_Q}^t$, i.e., we have the commutative diagram (32) where u, u', v', f are replaced by $u^t, u^t, v_{\gamma_Q}^t, f^t$, respectively. This and (33) yields a value of v on one track for each coupon of Ω . The last remark of Section 5.3 shows that these values extend to a coloring (u, v) of Ω . Since $f^t: u^t \rightarrow u^t$ carries $v_{i^t\gamma_Q}$ to $v_{\gamma_Q}^t$, the last remark of Section 5.5 implies that f^t carries u^t to u^t . Thus, the coloring (u, v) satisfies all the requirements of the lemma. The equalities $\text{source}(\Omega) = \text{source}(\Omega^2)$ and $\text{target}(\Omega) = \text{target}(\Omega^1)$ follow from the definition of (u, v) .

Let us prove the uniqueness of (u, v) . Suppose that (u, v) and (\bar{u}, \bar{v}) are two colorings of Ω satisfying the conditions of the lemma. Pick isomorphisms $h^t: (u^t, v^t) \rightarrow (\bar{u}^t, \bar{v}^t)$ and $\bar{h}^t: (\bar{u}^t, \bar{v}^t) \rightarrow (u^t, v^t)$ for $t = 1, 2$. For $e \in E^t$ consider the induced isomorphisms

$$h_{i^t\gamma_e}^t: u_{i^t\gamma_e} = (u^t)_{\gamma_e} \rightarrow u_{\gamma_e}^t \quad \text{and} \quad \bar{h}_{i^t\gamma_e}^t: \bar{u}_{i^t\gamma_e} = (\bar{u}^t)_{\gamma_e} \rightarrow u_{\gamma_e}^t.$$

Consider the composed isomorphisms

$$\{H_e = (h_{i^t\gamma_e}^t)^{-1} \bar{h}_{i^t\gamma_e}^t: \bar{u}_{i^t\gamma_e} \rightarrow u_{i^t\gamma_e}\}_{e \in E^t, t=1,2}.$$

By Lemma 5.1(ii), this system of isomorphisms extends to an isomorphism of pre-colorings $H: \bar{u} \rightarrow u$. We claim that H is an isomorphism $(\bar{u}, \bar{v}) \approx (u, v)$. Note that all the input/output tracks of Ω belong to the system $\{\gamma_e\}_e$, and the values of h^t and \bar{h}^t on these tracks are the identity morphisms of the corresponding objects of \mathcal{C} . Therefore the same is true for H . A similar argument involving the inputs of Ω^1 , the outputs of Ω^2 , and the assumption $\bar{v}_{\gamma(r)} = v_{\gamma(r)} = \text{id}$ implies that the values of H on the coupon-tracks $\{\gamma(r)\}_{r=1}^k$ carry \bar{v} to v . By the last remark of Section 5.5, the same is true for all coupon-tracks of the k coupons of Ω lying in $\mathbb{R}^2 \times [1/3, 2/3]$. Finally, the assumption that h^1 carries v^1 to v^1 and \bar{h}^1 carries \bar{v}^1 to v^1 implies that the values of H on all coupon-tracks of Ω entirely lying in $\mathbb{R}^2 \times [2/3, 1]$ carry \bar{v} to v . Using again the last remark of Section 5.5, we deduce the same for all coupon-tracks of the coupons of Ω lying in $\mathbb{R}^2 \times [2/3, 1]$. The coupons lying in $\mathbb{R}^2 \times [0, 1/3]$ are treated similarly. This proves our claim. \square

We define composition of the morphisms in \mathcal{G} represented by Ω^1, Ω^2 to be the stable color-equivalence class of (Ω, g, u, v) . This composition is well-defined and associative. The identity morphisms are represented by colored G -graphs formed by oriented vertical segments with constant framing (and no coupons).

6.2. Monoidal product in \mathcal{G} . We define a monoidal product in \mathcal{G} . The monoidal product of the objects of \mathcal{G} is the juxtaposition of sequences. The unit object is the empty sequence. To define the monoidal product of morphisms represented by colored G -graphs $(\Omega^t = (\Omega^t, g^t, u^t, v^t))_{t=1,2}$ we proceed as follows. Positioning a copy of Ω^1 to the left of a vertical band $\{*\} \times \mathbb{R} \times [0, 1]$ (with $*$ $\in \mathbb{R}$) and a copy of Ω^2 to the right of this band, and taking the union, we obtain a ribbon graph, Ω . The complement C_Ω of Ω deformation retracts onto the wedge $C_{\Omega^1} \vee C_{\Omega^2}$. The

van Kampen theorem yields a homomorphism $g: \pi_1(C_\Omega) \rightarrow G$ whose restriction to $\pi_1(C_{\Omega^t})$ is equal to g^t for $t = 1, 2$. An analogue of Lemma 6.1 says that there is a unique (up to isomorphism) coloring (u, v) of Ω whose restriction to C_{Ω^t} gives a coloring of Ω^t isomorphic to (u^t, v^t) for $t = 1, 2$. The stable color-equivalence class of (Ω, g, u, v) is the monoidal product of the morphisms represented by Ω^1 and Ω^2 . This monoidal product is well defined and turns \mathcal{G} into a strict monoidal category.

6.3. Remarks. 1. The coloring of Ω provided by Lemma 6.1 is defined only up to isomorphism. Using the replacement technique of Section 5.5, we can find a representative (u, v) in this isomorphism class such that $(u^t, v^t) = (u^t, v^t)$ for $t = 1, 2$. The values of (u, v) on the tracks and loops lying in the upper (resp. lower) third of $\mathbb{R}^2 \times [0, 1]$ are given directly by $(u^t, v^t)_{t=1,2}$. A similar remark applies to the construction of monoidal product in Section 6.2.

2. A useful class of ribbon graphs without circle components is formed by string links (which generalize braids). By a k -string link with $k \geq 1$ we mean a system of k framed oriented segments embedded in $\mathbb{R}^2 \times [0, 1]$ and meeting the boundary planes at the points $\{(r, 0, 0), (r, 0, 1)\}_{r=1, \dots, k}$. The framing should be given by the vector $(0, \delta, 0)$ at the endpoints where δ is a small positive real number. Such a string link is a ribbon graph without coupons. All the definitions given above for ribbon graphs apply to string links. To turn a string link L (equipped with a principal G -bundle on the exterior) into a \mathcal{C} -colored ribbon graph it is enough to color the input tracks of L with objects of \mathcal{C} . This determines a \mathcal{C} -coloring of L uniquely up to color-preserving isomorphism.

7. COLORED DIAGRAMS

We introduce colored diagrams which will be used in the next sections to represent colored ribbon graphs.

7.1. Graph diagrams. A *graph diagram* is a finite family of embedded coupons, immersed segments, and immersed circles in $\mathbb{R} \times [0, 1]$. The segments and circles are called the *1-strata* of the diagram. We require that

- (i) the coupons are oriented counterclockwise, disjoint, and lie in $\mathbb{R} \times (0, 1)$;
- (ii) the 1-strata are oriented and have only double transversal crossings in $\mathbb{R} \times (0, 1)$ with over/under-data at all crossings;
- (iii) the set of the endpoints of the 1-strata consists of the points $((r, 0))_{r=1}^k$ (the inputs) and $((s, 1))_{s=1}^l$ (the outputs) for some $k, l \geq 0$ together with certain points lying on the distinguished (bottom) sides of the coupons and the opposite (top) sides. The 1-strata do not meet the coupons other than at the endpoints and meet $\mathbb{R} \times \{0, 1\}$ orthogonally at the inputs and outputs.

We do not require the sides of the coupons in the diagrams to be parallel to the horizontal and vertical axes in \mathbb{R}^2 . However, in the pictures below, we will have only such coupons. By convention, the distinguished sides of the coupons in our pictures are their bottom horizontal sides.

Each crossing c of a graph diagram D gives rise to two points on the 1-strata of D : the undercrossing c_{un} and the overcrossing c_{ov} . The overcrossings lying on a 1-stratum d of D split d into consecutive segments called *underpasses*. If d contains no overcrossings (i.e., d is embedded and lies below all the other 1-strata), then by definition, d has one underpass equal to d .

 FIGURE 3. The underpasses associated with a crossing c

A crossing c of D determines three underpasses of (1-strata of) D : the underpass \underline{c} containing the point c_{un} and two underpasses c^-, c^+ separated by the point c_{ov} . One of the underpasses c^-, c^+ is directed towards c_{ov} and the other one is directed away from c_{ov} . We choose notation so that c^+ is directed towards c_{ov} if the crossing c is positive and away from c_{ov} if c is negative, see Figure 3.

7.2. Colorings of diagrams. A \mathcal{C} -pre-coloring or shorter a pre-coloring U of a graph diagram D comprises two functions. The first function assigns to every underpass p of (a 1-stratum of) D a non-zero homogeneous object U_p of \mathcal{C} called the *color* of p . The second function assigns to every crossing c of D an isomorphism

$$(34) \quad U_c: U_{c^+} \rightarrow \varphi_{|U_{\underline{c}}|}(U_{c^-})$$

called the *color* of c . The existence of such an isomorphism together with the fact that the colors are non-zero objects implies that $|U_{c^+}| = |U_{\underline{c}}|^{-1}|U_{c^-}|$ for all c . A pre-colored diagram D has a source/target defined similarly to the source/target of a pre-colored ribbon graph but using the orientations and the colors of the underpasses of D adjacent to the inputs/outputs.

A \mathcal{C} -coloring or shorter a coloring of D consists of a pre-coloring U and a function V assigning to every coupon Q of D a morphism V_Q in \mathcal{C} satisfying the following conditions. Let p_1, \dots, p_m be the underpasses of D incident to the bottom side of Q enumerated from the left to the right (i.e., in the order determined by the direction on ∂Q induced by the orientation of Q). Set $\varepsilon_i = +$ if p_i is directed out of Q and $\varepsilon_i = -$ otherwise. Let p^1, \dots, p^n be the underpasses of D incident to the top side of Q enumerated from the left to the right (i.e., in the order determined by the direction on ∂Q opposite to the one induced by the orientation of Q). Set $\varepsilon^j = -$ if p^j is directed out of Q and $\varepsilon^j = +$ otherwise. We require that

$$\prod_{i=1}^m |U_{p_i}|^{\varepsilon_i} = \prod_{j=1}^n |U_{p^j}|^{\varepsilon^j} \quad \text{and} \quad V_Q \in \text{Hom}_{\mathcal{C}}(\otimes_{i=1}^m U_{p_i}^{\varepsilon_i}, \otimes_{j=1}^n U_{p^j}^{\varepsilon^j}).$$

As above, $X^+ = X$ and $X^- = X^*$ for any $X \in \mathcal{C}$. By a \mathcal{C} -colored diagram or shorter a colored diagram, we mean a graph diagram endowed with a \mathcal{C} -coloring.

Examples of colored diagrams (and notation for them) are given in Figure 4. Here we mark the overcrossings by dots and indicate the colors of the underpasses and of the crossings. In the first six diagrams, X, Y, X', Y' are any homogeneous objects of \mathcal{C} and ψ is any isomorphism. The seventh diagram is formed by a coupon colored by a morphism $v \in \text{Hom}_{\mathcal{C}}(\otimes_{i=1}^m U_i^{\varepsilon_i}, \otimes_{j=1}^n (U^j)^{\varepsilon^j})$ and $m+n$ vertical segments. The diagrams in Figure 4 are called *elementary diagrams*. The elementary diagrams σ_+ and σ_- should not be confused with the pictures used in Section 4 to represent the G -braiding and its inverse. In the latter, the crossings are not decorated with isomorphisms.

An *isomorphism* $U \approx U'$ of pre-colorings of D is a system of isomorphisms $f = \{f_p: U_p \rightarrow U'_p\}_p$, where p runs over all underpasses of D , such that for any

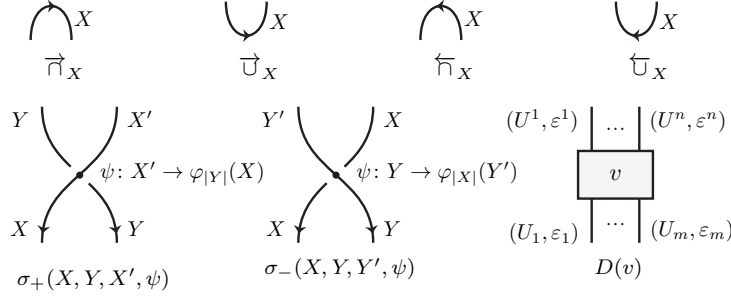

FIGURE 4. Elementary colored diagrams

crossing c , the following diagram commutes

$$(35) \quad \begin{array}{ccc} U_{c+} & \xrightarrow{U_c} & \varphi_{|U_{\underline{c}}|}(U_{c-}) \\ f_{c+} \downarrow & & \downarrow \varphi_{|U_{\underline{c}}|}(f_{c-}) \\ U'_{c+} & \xrightarrow{U'_c} & \varphi_{|U'_{\underline{c}}|}(U'_{c-}). \end{array}$$

Here $|U_{\underline{c}}| = |U'_{\underline{c}}|$ because isomorphic non-zero homogeneous objects of \mathcal{C} have the same grading.

Let (U, V) and (U', V') be colorings of D with the same source and target. Thus, $U_p = U'_p$ for any underpass p of D adjacent to an input or an output of D . An *isomorphism* $(U, V) \rightarrow (U', V')$ is an isomorphism of pre-colorings $f: U \rightarrow U'$ such that for any underpass p adjacent to an input or an output of D , we have $f_p = \text{id}: U_p \rightarrow U'_p$ and for any coupon Q of D , the following diagram (in the notation above) commutes:

$$(36) \quad \begin{array}{ccc} \otimes_{i=1}^m U_{p_i}^{\varepsilon_i} & \xrightarrow{V_Q} & \otimes_{j=1}^n U_{p_j}^{\varepsilon_j} \\ \otimes_{i=1}^m f_{p_i}^{\varepsilon_i} \downarrow & & \downarrow \otimes_{j=1}^n f_{p_j}^{\varepsilon_j} \\ \otimes_{i=1}^m (U'_{p_i})^{\varepsilon_i} & \xrightarrow{V'_Q} & \otimes_{j=1}^n (U'_{p_j})^{\varepsilon_j}. \end{array}$$

By *isotopy* of a colored diagram, we mean an ambient isotopy of the diagram in $\mathbb{R} \times [0, 1]$ keeping the inputs, the outputs, the orientations of 1-strata, the over/under-data in the crossings, and all the colors. We call two colored diagrams *color-equivalent* if they may be obtained from each other through isotopy and isomorphism of colorings. Color-equivalent colored diagrams necessarily have the same source and the same target.

7.3. The category $\mathcal{D}_{\mathcal{C}}$. We define a strict monoidal category $\mathcal{D} = \mathcal{D}_{\mathcal{C}}$ of \mathcal{C} -colored diagrams. This category has the same objects as the category $\mathcal{G}_{\mathcal{C}}$ from Section 6.1. The monoidal product of objects and the unit object in \mathcal{D} are the same as in $\mathcal{G}_{\mathcal{C}}$. A morphism $((U_r, \varepsilon_r))_{r=1}^k \rightarrow ((U^s, \varepsilon^s))_{s=1}^l$ in \mathcal{D} is a color-equivalence class of \mathcal{C} -colored diagrams with source $((U_r, \varepsilon_r))_{r=1}^k$ and target $((U^s, \varepsilon^s))_{s=1}^l$. The identity morphism of an object $((U_r, \varepsilon_r))_{r=1}^k$ is represented by the colored diagram formed by k disjoint vertical segments with source and target $((U_r, \varepsilon_r))_{r=1}^k$. The composition

of morphisms represented by colored diagrams D, D' is obtained by gluing D on top of D' . The monoidal product of the morphisms represented by D, D' is obtained by placing D' to the right of D . All axioms of a strict monoidal category are straightforward. By abuse of language, we shall make no difference between a colored diagram and the corresponding morphism in \mathcal{D} .

Lemma 7.1. *If $(\mathcal{C}, \varphi, \tau)$ is a pivotal G -braided category, then there is a unique strong monoidal functor $\mathcal{F} = (\mathcal{F}, \mathcal{F}_2, \mathcal{F}_0): \mathcal{D}_{\mathcal{C}} \rightarrow \mathcal{C}$ such that:*

- \mathcal{F} carries any object $((U_r, \varepsilon_r))_{r=1}^k$ of $\mathcal{D}_{\mathcal{C}}$ to $\otimes_{r=1}^k U_r^{\varepsilon_r}$;
- $\mathcal{F}_0: \mathbb{1} \rightarrow \mathcal{F}(\emptyset) = \mathbb{1}$ is the identity morphism;
- for any objects $X = ((U_r, \varepsilon_r))_{r=1}^k$ and $Y = ((V_s, \mu_s))_{s=1}^l$ of \mathcal{D} , the morphism $\mathcal{F}_2(X, Y): \mathcal{F}(X) \otimes \mathcal{F}(Y) \rightarrow \mathcal{F}(X \otimes Y)$ is the canonical isomorphism

$$(U_1^{\varepsilon_1} \otimes \cdots \otimes U_k^{\varepsilon_k}) \otimes (V_1^{\mu_1} \otimes \cdots \otimes V_l^{\mu_l}) \cong U_1^{\varepsilon_1} \otimes \cdots \otimes U_k^{\varepsilon_k} \otimes V_1^{\mu_1} \otimes \cdots \otimes V_l^{\mu_l}$$

determined by the associativity constraints in \mathcal{C} ;

- \mathcal{F} carries elementary diagrams to the following morphisms:

$$\mathcal{F}(\vec{\cap}_X) = \text{ev}_X, \mathcal{F}(\overleftarrow{\cap}_X) = \tilde{\text{ev}}_X, \mathcal{F}(\vec{\cup}_X) = \text{coev}_X, \mathcal{F}(\overleftarrow{\cup}_X) = \widetilde{\text{coev}}_X, \mathcal{F}(D_v) = v,$$

$$(37) \quad \mathcal{F}(\sigma_+(X, Y, X', \psi)) = (\text{id}_Y \otimes \psi^{-1})\tau_{X, Y}: X \otimes Y \rightarrow Y \otimes X',$$

$$(38) \quad \mathcal{F}(\sigma_-(X, Y, Y', \psi)) = \tau_{Y', X}^{-1}(\text{id}_X \otimes \psi): X \otimes Y \rightarrow Y' \otimes X.$$

Proof. The uniqueness of \mathcal{F} is obvious because all morphisms in $\mathcal{D}_{\mathcal{C}}$ can be obtained from the elementary diagrams using composition and monoidal product. The existence of \mathcal{F} is a direct consequence of the axioms of a pivotal category, cf. Sections 2.2 and 3.3. \square

8. COLORED REIDEMEISTER MOVES

8.1. The moves. We define local transformations of colored diagrams called *colored Reidemeister moves*. These moves preserve a diagram outside a 2-disk and modify the diagram in the disk as shown in Figures 5–9. There are four moves of type 1, four moves of type 2, one move of type 3, and four moves of type 4. We now specify the behavior of colorings under the moves.

Each type 1 or type 2 move creates two new crossings and a new underpass with endpoints in these crossings. The color of this underpass may be an arbitrary object of \mathcal{C} such that there is an isomorphism ψ as in Figures 5 and 6. Both new crossings are colored with the same ψ . Note that under the type 1 moves, $|X| = |X'|$.

The morphisms A, B, C, A', B' in the type 3 move are any isomorphisms in \mathcal{C} as indicated such that the following diagram commutes:

$$(39) \quad \begin{array}{ccc} \varphi_{|Y'|}(\tilde{X}) & \xleftarrow{B'} & X'' & \xrightarrow{B} & \varphi_{|Z|}(X') \\ \downarrow \varphi_{|Y'|}(A') & & & & \downarrow \varphi_{|Z|}(A) \\ \varphi_{|Y'|}\varphi_{|Z|}(X) & \xrightarrow{\varphi_2(|Y'|, |Z|)_X} & \varphi_{|Z||Y'|}(X) = \varphi_{|Y||Z|}(X) & \xleftarrow{\varphi_2(|Z|, |Y|)_X} & \varphi_{|Z|}\varphi_{|Y|}(X). \end{array}$$

The equality $|Z||Y'| = |Y||Z|$ follows from the existence of the isomorphism C and the fact that the objects Y, Y' are non-zero.

To describe the type 4 moves, we use notation $\bar{\psi}$ and ψ^- introduced in Section 3.3. Let Q be a coupon of a colored diagram with m entries and n exits. The

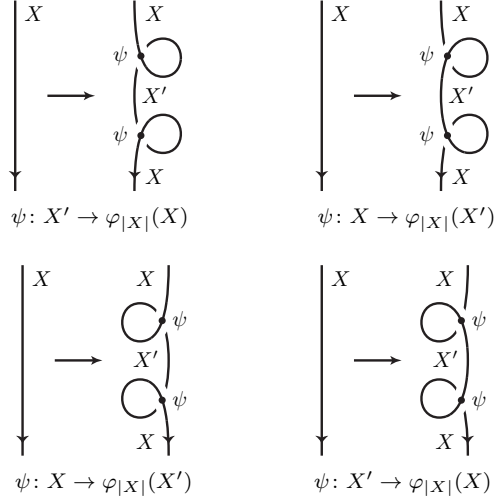

FIGURE 5. Type 1 moves

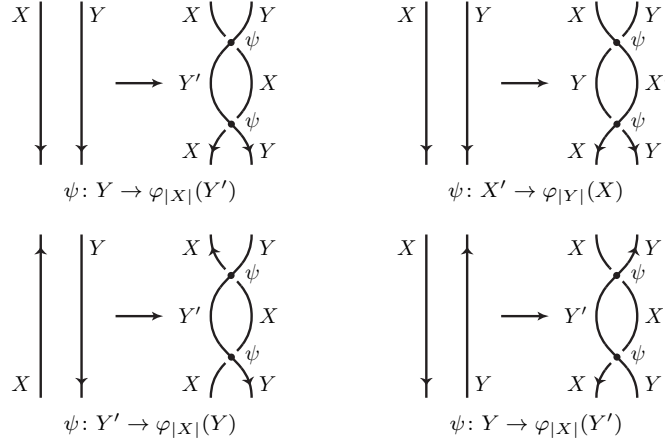

FIGURE 6. Type 2 moves

first type 4 move pushes a Z -colored underpass behind Q , see Figure 8. The color v_0 of Q is transformed into v_1 . There is only one requirement on v_0 , v_1 and the isomorphisms ψ_i, ψ^j . Namely, the following diagram should commute:

$$(40) \quad \begin{array}{ccccc} \otimes_{i=1}^m X_i^{\varepsilon_i} & \xrightarrow{\otimes_{i=1}^m \psi_i^{\varepsilon_i}} & \otimes_{i=1}^m \varphi_\mu(Y_i^{\varepsilon_i}) & \xrightarrow{(\varphi_\mu)^m} & \varphi_\mu(\otimes_{i=1}^m Y_i^{\varepsilon_i}) \\ \downarrow v_0 & & & & \downarrow \varphi_\mu(v_1) \\ \otimes_{j=1}^n (Y^j)^{\varepsilon_j} & \xrightarrow{\otimes_{j=1}^n (\psi^j)^{\varepsilon_j}} & \otimes_{j=1}^n \varphi_\mu((X^j)^{\varepsilon_j}) & \xrightarrow{(\varphi_\mu)^n} & \varphi_\mu(\otimes_{j=1}^n (X^j)^{\varepsilon_j}). \end{array}$$

Here $\mu = |Z| \in G$ and $\varepsilon_i, \varepsilon^j = \pm$ are the signs determined by the i -th entry and j -th exit of Q as in Section 5.3. The second type 4 move is obtained from the

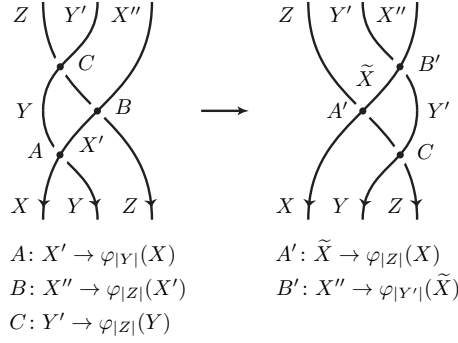

FIGURE 7. Type 3 move

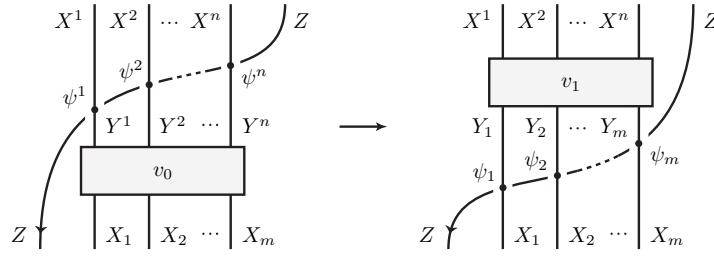

FIGURE 8. The first move of type 4

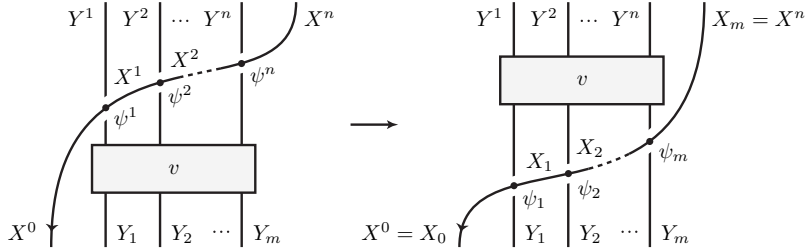

FIGURE 9. The third move of type 4

previous one by inverting orientation on the Z -colored underpass (before and after the move) and replacing μ, ψ_i, ψ^j in (40) by $\mu^{-1} = |Z|^{-1}, \overline{\psi_i}, \overline{\psi^j}$, respectively.

The third type 4 move pushes a branch of the diagram in front of Q keeping the color v of Q , see Figure 9. There is only one requirement on the isomorphisms ψ_i, ψ^j . Set $y_i = |Y_i|^{\varepsilon_i} \in G$ and $y^j = |Y^j|^{\varepsilon^j} \in G$ for all i, j . Suppose first that $\varepsilon_i = \varepsilon^j = +$ for all i, j , i.e., that all the segments adjacent to Q are directed downwards. We require that the composition

$$(41) \quad \begin{array}{ccccccc} X^n & \xrightarrow{\psi^n} & \varphi_{y^n}(X^{n-1}) & \xrightarrow{\varphi_{y^n}(\psi^{n-1})} & \varphi_{y^n} \varphi_{y^{n-1}}(X^{n-2}) & \xrightarrow{\varphi_{y^n} \varphi_{y^{n-1}}(\psi^{n-2})} & \\ & & \dots & \xrightarrow{\varphi_{y^n} \dots \varphi_{y^2}(\psi^1)} & \varphi_{y^n} \dots \varphi_{y^1}(X^0) & \xrightarrow{\varphi_n} & \varphi_{y^1 \dots y^n}(X^0) \end{array}$$

is equal to the composition

$$(42) \quad \begin{array}{c} X_m \xrightarrow{\psi_m} \varphi_{y_m}(X_{m-1}) \xrightarrow{\varphi_{y_m}(\psi_{m-1})} \varphi_{y_m} \varphi_{y_{m-1}}(X_{m-2}) \xrightarrow{\varphi_{y_m} \varphi_{y_{m-1}}(\psi_{m-2})} \\ \dots \xrightarrow{\varphi_{y_m} \dots \varphi_{y_2}(\psi_1)} \varphi_{y_m} \dots \varphi_{y_1}(X_0) \xrightarrow{\varphi_m} \varphi_{y_1 \dots y_m}(X_0). \end{array}$$

In the general case, whenever $\varepsilon^j = -$ (resp. $\varepsilon_i = -$), one should replace here ψ^j by $\overline{\psi^j}$ (resp. replace ψ_i by $\overline{\psi_i}$). Note that $X^n = X_m$, $X^0 = X_0$, and $y^1 \dots y^n = y_1 \dots y_m$ so that the source and target objects of both compositions are the same.

The fourth type 4 move is obtained from the previous one by inverting orientation on the long branch (before and after the move). The rest of the notation and the condition on the ψ 's are the same.

The moves inverse to the colored Reidemeister moves above are also called colored Reidemeister moves.

We shall need one more move on colored diagrams shown in Figure 2 and called *stabilization*. This move inserts a coupon inside a downward-oriented branch of an underpass. If this underpass is colored with X , then both underpasses adjoint to the new coupon are colored with X , and the coupon is colored with id_X . The rest of the diagram is preserved including the coloring.

Theorem 8.1. *For any G -ribbon category \mathcal{C} , the functor $\mathcal{F}: \mathcal{D}_{\mathcal{C}} \rightarrow \mathcal{C}$ of Lemma 7.1 is invariant under the colored Reidemeister moves and under stabilization.*

The proof of this theorem is based on the following lemma:

Lemma 8.2. *For any G -ribbon category \mathcal{C} , the images under $\mathcal{F}: \mathcal{D}_{\mathcal{C}} \rightarrow \mathcal{C}$ of the \mathcal{C} -colored diagrams in Figure 10 are:*

$$(43) \quad \mathcal{F}(T_+(X, X', \psi)) = \mathcal{F}(T'_+(X, X', \psi)) = \psi^{-1} \theta_X \quad (\text{here } |X| = |X'|),$$

$$(44) \quad \mathcal{F}(T_-(X, X', \psi)) = \mathcal{F}(T'_-(X, X', \psi)) = \theta_{X'}^{-1} \psi \quad (\text{here } |X| = |X'|),$$

$$(45) \quad \mathcal{F}(\sigma'_+(X, Y, Y', \psi)) = \tau_{Y', X^*}^{-1}(\text{id}_{X^*} \otimes \overline{\psi}),$$

$$(46) \quad \mathcal{F}(\sigma'_-(X, Y, X', \psi)) = (\text{id}_{Y^*} \otimes \overline{\psi}^{-1}) \tau_{X, Y^*},$$

$$(47) \quad \mathcal{F}(\sigma''_+(X, Y, Y', \psi)) = \tau_{Y^*, X}^{-1}(\text{id}_X \otimes \psi^-),$$

$$(48) \quad \mathcal{F}(\sigma''_-(X, Y, X', \psi)) = (\text{id}_Y \otimes (\psi^-)^{-1}) \tau_{X^*, Y},$$

$$(49) \quad \mathcal{F}(\sigma'''_+(X, Y, X', \psi)) = (\text{id}_{Y^*} \otimes (\overline{\psi^-})^{-1}) \tau_{X^*, Y^*},$$

$$(50) \quad \mathcal{F}(\sigma'''_-(X, Y, Y', \psi)) = \tau_{Y^*, X^*}^{-1}(\text{id}_{X^*} \otimes \overline{\psi^-}).$$

Proof. Equalities (43) and (44) follow from the expressions for the twist and its inverse given in (23), Lemma 4.2, and Lemma 4.5. Since $\sigma'_+(X, Y, Y', \psi)$ is color-equivalent to

we obtain from the definition of \mathcal{F} that

$$\mathcal{F}(\sigma'_+(X, Y, Y', \psi)) = (\text{ev}_X \otimes \psi^{-1} \otimes \text{id}_{X^*})(\text{id}_{X^*} \otimes \tau_{Y, X} \otimes \text{id}_X)(\text{id}_{X^* \otimes Y} \otimes \text{coev}_X).$$

$$\begin{aligned}
 T_+(X, X', \psi) &= \begin{array}{c} |X' \\ \psi \circlearrowleft \\ \downarrow X \\ \psi: X' \rightarrow \varphi_{|X|}(X) \end{array}, & T_-(X, X', \psi) &= \begin{array}{c} |X' \\ \psi \circlearrowright \\ \downarrow X \\ \psi: X \rightarrow \varphi_{|X|}(X') \end{array}, \\
 T'_+(X, X', \psi) &= \begin{array}{c} X' \\ \circlearrowleft \psi \\ \downarrow X \\ \psi: X' \rightarrow \varphi_{|X|}(X) \end{array}, & T'_-(X, X', \psi) &= \begin{array}{c} X' \\ \circlearrowright \psi \\ \downarrow X \\ \psi: X \rightarrow \varphi_{|X|}(X') \end{array}, \\
 \sigma'_+(X, Y, Y', \psi) &= \begin{array}{c} Y' \swarrow \searrow X \\ \psi \\ X \swarrow \searrow Y \\ \psi: Y' \rightarrow \varphi_{|X|}(Y) \end{array}, & \sigma'_-(X, Y, X', \psi) &= \begin{array}{c} Y \swarrow \searrow X' \\ \psi \\ X \swarrow \searrow Y \\ \psi: X \rightarrow \varphi_{|Y|}(X') \end{array}, \\
 \sigma''_+(X, Y, Y', \psi) &= \begin{array}{c} Y' \swarrow \searrow X \\ \psi \\ X \swarrow \searrow Y \\ \psi: Y \rightarrow \varphi_{|X|}(Y') \end{array}, & \sigma''_-(X, Y, X', \psi) &= \begin{array}{c} Y \swarrow \searrow X' \\ \psi \\ X \swarrow \searrow Y \\ \psi: X' \rightarrow \varphi_{|Y|}(X) \end{array}, \\
 \sigma'''_+(X, Y, X', \psi) &= \begin{array}{c} Y \swarrow \searrow X' \\ \psi \\ X \swarrow \searrow Y \\ \psi: X \rightarrow \varphi_{|Y|}(X') \end{array}, & \sigma'''_-(X, Y, Y', \psi) &= \begin{array}{c} Y' \swarrow \searrow X \\ \psi \\ X \swarrow \searrow Y \\ \psi: Y' \rightarrow \varphi_{|X|}(Y) \end{array}.
 \end{aligned}$$

 FIGURE 10. \mathcal{C} -colored diagrams

Note that $(\varphi_0)_{Y'}^{-1} \varphi_2(|X|, |X|^{-1})_{Y', \varphi_{|X|}(\bar{\psi})} = \psi^{-1}$ by (15) and (16). Now, by the first equality of Lemma 4.1(d),

$$\begin{aligned}
 \tau_{Y', X^*}^{-1} &= (\text{ev}_X \otimes (\varphi_0)_{Y'}^{-1} \varphi_2(|X|, |X|^{-1})_{Y', \varphi_{|X|}(\bar{\psi})} \otimes \text{id}_{X^*}) \circ \\
 &\quad \circ (\text{id}_{X^*} \otimes \tau_{\varphi_{|X|^{-1}}(Y'), X} \otimes \text{id}_{X^*}) (\text{id}_{X^* \otimes \varphi_{|X|^{-1}}(Y')} \otimes \text{coev}_X).
 \end{aligned}$$

Therefore we obtain (45). Equality (46) is proved similarly. Since $\sigma''_+(X, Y, Y', \psi)$ is color-equivalent to

$$\begin{array}{c} Y' \uparrow X \\ \psi \\ \downarrow X \downarrow Y \end{array},$$

we obtain from the definition of \mathcal{F} that

$$\begin{aligned}
 \mathcal{F}(\sigma''_+(X, Y, Y', \psi)) &= (\text{id}_{Y'^* \otimes X} \otimes \widetilde{\text{coev}}_Y) (\text{id}_{X^*} \otimes (\text{id}_X \otimes \psi^{-1}) \tau_{Y, X} \otimes \text{id}_{X^*}) (\text{ev}_X \otimes \psi^{-1} \otimes \text{id}_{X^*}).
 \end{aligned}$$

Note that $\phi_Y^{-1}(\psi^-)^* \varphi_{|X|}^1(Y'^*) \varphi_{|X|}(\phi_{Y'}) = \psi^{-1}$ by (8), where ϕ is the pivotal structure (9) of \mathcal{C} . Now, by the second equality of Lemma 4.1(d),

$$\begin{aligned} \tau_{Y'^*, X}^{-1} &= (\text{id}_{Y'^* \otimes X} \otimes \text{ev}_{\varphi_{|X|}(Y'^*)}(\varphi_{|X|}^1(Y'^*) \otimes \text{id}_{\varphi_{|X|}(Y'^*)})) \circ \\ &\quad \circ (\text{id}_{Y'^*} \otimes \tau_{Y'^*, X} \otimes \text{id}_{\varphi_{|X|}(Y'^*)})(\text{coev}_{Y'^*} \otimes \text{id}_{X \otimes \varphi_{|X|}(Y'^*)}) \\ &= (\text{id}_{Y'^* \otimes X} \otimes \text{ev}_{\varphi_{|X|}(Y'^*)}(\varphi_{|X|}^1(Y'^*) \varphi_{|X|}(\phi_{Y'}) \otimes \text{id}_{\varphi_{|X|}(Y'^*)})) \circ \\ &\quad \circ (\text{id}_{Y'^*} \otimes \tau_{Y', X} \otimes \text{id}_{\varphi_{|X|}(Y'^*)})(\widetilde{\text{coev}}_{Y'} \otimes \text{id}_{X \otimes \varphi_{|X|}(Y'^*)}). \end{aligned}$$

Therefore we obtain (47). Equality (48) is proved similarly.

Since $\sigma_+'''(X, Y, X', \psi)$, viewed as a morphism in $\mathcal{D}_{\mathcal{C}}$, is dual to $\sigma_+(X', Y, X, \psi)$,

$$\mathcal{F}(\sigma_+'''(X, Y, X', \psi)) = (\tau_{X', Y})^*((\psi^{-1})^* \otimes \text{id}_{Y^*}).$$

Using (8) and two expressions of $(\tau_{X', Y})^{-1}$ given by Lemma 4.1(d), we obtain

$$(\tau_{X', Y})^* = (\text{id}_{Y^*} \otimes (\varphi_0)_{X'^*}^{-1} \varphi_2(|Y|^{-1}, |Y|)_{X'^*}) \tau_{\varphi_{|Y|}(X'^*), Y^*}(\varphi_{|Y|}^1(X')^{-1} \otimes \text{id}_{Y^*}).$$

Therefore

$$\begin{aligned} \mathcal{F}(\sigma_+'''(X, Y, X', \psi)) &= (\text{id}_{Y^*} \otimes (\varphi_0)_{X'^*}^{-1} \varphi_2(|Y|^{-1}, |Y|)_{X'^*}) \tau_{\varphi_{|Y|}(X'^*), Y^*}(\varphi_{|Y|}^1(X')^{-1} (\psi^{-1})^* \otimes \text{id}_{Y^*}) \\ &= (\text{id}_{Y^*} \otimes (\varphi_0)_{X'^*}^{-1} \varphi_2(|Y|^{-1}, |Y|)_{X'^*}) \tau_{\varphi_{|Y|}(X'^*), Y^*}(\psi^- \otimes \text{id}_{Y^*}) \\ &= (\text{id}_{Y^*} \otimes (\varphi_0)_{X'^*}^{-1} \varphi_2(|Y|^{-1}, |Y|)_{X'^*} \varphi_{|Y|^{-1}}(\psi^-)) \tau_{X^*, Y^*} \\ &= (\text{id}_{Y^*} \otimes (\overline{\psi^-})^{-1}) \tau_{X^*, Y^*}. \end{aligned}$$

This gives (49). Equality (50) is proved similarly. \square

Proof of Theorem 8.1. We must prove that if two colored diagrams D_1, D_2 are related by a (colored) Reidemeister move or a stabilization move, then $\mathcal{F}(D_1) = \mathcal{F}(D_2)$. Invariance under stabilization is obvious. Invariance under the Reidemeister moves of types 1 and 2 is a direct consequence of Lemma 8.2. For example, the colored diagram $T_-(X', X, \psi) T_+(X, X', \psi)$ on the right-hand side of Figure 5(a) is carried by \mathcal{F} to $\theta_X^{-1} \psi \psi^{-1} \theta_X = \text{id}_X$; hence the invariance.

Let us prove the invariance of \mathcal{F} under the Reidemeister moves of type 3. The left-hand side of Figure 7 is carried by \mathcal{F} to

$$\begin{aligned} &((\text{id}_Z \otimes C^{-1}) \tau_{Y, Z} \otimes \text{id}_Z) (\text{id}_Y \otimes (\text{id}_Z \otimes B^{-1}) \tau_{X', Z}) ((\text{id}_Y \otimes A^{-1}) \tau_{X, Y} \otimes \text{id}_Z) = \\ &(\text{id}_Z \otimes C^{-1} \otimes B^{-1} \varphi_{|Z|}(A^{-1})) (\tau_{Y, Z} \otimes \varphi_{|Z|} \varphi_{|Y|}(X)) (\text{id}_Y \otimes \tau_{\varphi_{|Y|}(X), Z}) (\tau_{X, Y} \otimes \text{id}_Z). \end{aligned}$$

The right-hand side of Figure 7 is carried by \mathcal{F} to

$$\begin{aligned} &(\text{id}_Z \otimes (\text{id}_{Y'} \otimes B'^{-1}) \tau_{\tilde{X}, Y'}) ((\text{id}_Z \otimes A'^{-1}) \tau_{X, Z} \otimes \text{id}_{Y'}) (\text{id}_Y \otimes (\text{id}_X \otimes C^{-1}) \tau_{Y, Z}) = \\ &(\text{id}_Z \otimes C^{-1} \otimes B'^{-1} \varphi_{|Y'}(A'^{-1})) (\text{id}_Z \otimes \tau_{\varphi_{|Z|}(X), \varphi_{|Z|}(Y)}) (\tau_{X, Z} \otimes \text{id}_{\varphi_{|Z|}(Y)}) (\text{id}_X \otimes \tau_{Y, Z}). \end{aligned}$$

We conclude using (39) and the quantum Yang-Baxter equality of Lemma 4.1(c).

Consider the first Reidemeister move of type 4 shown in Figure 8. Using (38) and (47), we obtain that \mathcal{F} carries the colored diagram on the left to

$$f = (\text{id}_{\otimes_{j=1}^{n-1} (X^j)^{\varepsilon^j}} \otimes \tau_{(X^n)^{\varepsilon^n}, Z}^{-1}) \cdots (\tau_{(X^1)^{\varepsilon^1}, Z}^{-1} \otimes \text{id}_{\otimes_{j=2}^n (Y^j)^{\varepsilon^j}}) (\text{id}_Z \otimes (\otimes_{i=1}^n (\psi^i)^{\varepsilon^i}) v_0).$$

Now, setting $\mu = |Z|$ and using (21), we obtain that

$$\begin{aligned} & (\text{id}_{\otimes_{j=1}^{n-1}(X^j)^{\varepsilon_j}} \otimes \tau_{(X^n)^{\varepsilon_n}, Z}^{-1}) \circ \cdots \circ (\tau_{(X^1)^{\varepsilon_1}, Z}^{-1} \otimes \text{id}_{\otimes_{j=2}^n(Y^j)^{\varepsilon_j}}) \\ &= \tau_{\otimes_{j=1}^n(X^j)^{\varepsilon_j}, Z}^{-1} (\text{id}_Z \otimes (\varphi_\mu)_n((X^1)^{\varepsilon_1}, \dots, (X^n)^{\varepsilon_n})). \end{aligned}$$

Therefore, using (40), we obtain that

$$\begin{aligned} f &= \tau_{\otimes_{j=1}^n(X^j)^{\varepsilon_j}, Z}^{-1} (\text{id}_Z \otimes (\varphi_\mu)_n((X^1)^{\varepsilon_1}, \dots, (X^n)^{\varepsilon_n})(\otimes_{j=1}^n(\psi^j)^{\varepsilon_j})v_0) \\ &= \tau_{\otimes_{j=1}^n(X^j)^{\varepsilon_j}, Z}^{-1} (\text{id}_Z \otimes \varphi_\mu(v_1)(\varphi_\mu)_m(X_1^{\varepsilon_1}, \dots, X_m^{\varepsilon_m})(\otimes_{i=1}^m \psi_i^{\varepsilon_i})) \\ &= (v_1 \otimes \text{id}_Z) \tau_{\otimes_{i=1}^m Y_i^{\varepsilon_i}, Z}^{-1} (\text{id}_Z \otimes (\varphi_\mu)_m(X_1^{\varepsilon_1}, \dots, X_m^{\varepsilon_m})(\otimes_{i=1}^m \psi_i^{\varepsilon_i})) \\ &= (v_1 \otimes \text{id}_Z) (\text{id}_{\otimes_{i=1}^{m-1} Y_i^{\varepsilon_i}} \otimes \tau_{X_m^{\varepsilon_m}, Z}^{-1}) \cdots (\tau_{Y_1^{\varepsilon_1}, Z}^{-1} \otimes \text{id}_{\otimes_{i=2}^m X_i^{\varepsilon_i}}) (\text{id}_Z \otimes (\otimes_{i=1}^m \psi_i^{\varepsilon_i})). \end{aligned}$$

The latter morphism is the image under \mathcal{F} of the colored diagram obtained by the move. This proves the invariance of \mathcal{F} under the first move of type 4. The second move of type 4 is treated similarly using (45) and (50).

Consider now the third move of type 4 shown in Figure 9. Using (37) and (46), we obtain that \mathcal{F} carries the diagram on the left to

$$\begin{aligned} g &= (\text{id}_{\otimes_{j=1}^{n-1}(Y^j)^{\varepsilon_j}} \otimes (\text{id}_{(Y^n)^{\varepsilon_n}} \otimes (\xi^n)^{-1}) \tau_{X^{n-1}, (Y^n)^{\varepsilon_n}}) \circ \cdots \\ &\quad \cdots \circ ((\text{id}_{(Y^1)^{\varepsilon_1}} \otimes (\xi^1)^{-1}) \tau_{X^0, (Y^1)^{\varepsilon_1}} \otimes \text{id}_{\otimes_{j=2}^n(Y^j)^{\varepsilon_j}}) (\text{id}_{X^0} \otimes v). \end{aligned}$$

where $\xi^i = \psi^i$ if $\varepsilon^i = +$ and $\xi^i = \overline{\psi^i}$ otherwise. Set $y_i = |Y_i|^{\varepsilon_i} \in G$ and $y^j = |Y^j|^{\varepsilon_j} \in G$ for all i, j and

$$\rho = (\varphi_{y^n} \cdots \varphi_{y^2}(\xi^1)) \circ \cdots \circ (\varphi_{y^n}(\xi^{n-1})) \circ \xi^n.$$

Then using (20), we obtain

$$\begin{aligned} g &= (\text{id}_{\otimes_{j=1}^n(Y^j)^{\varepsilon_j}} \otimes \rho^{-1}) (\text{id}_{\otimes_{j=1}^{n-1}(Y^j)^{\varepsilon_j}} \otimes \tau_{\varphi_{y^{n-1}} \cdots \varphi_{y^1}(X^0), (Y^n)^{\varepsilon_n}}) \circ \cdots \\ &\quad \cdots \circ (\tau_{X^0, (Y^1)^{\varepsilon_1}} \otimes \text{id}_{\otimes_{j=2}^n(Y^j)^{\varepsilon_j}}) (\text{id}_{X^0} \otimes v) \\ &= (\text{id}_{\otimes_{j=1}^n(Y^j)^{\varepsilon_j}} \otimes \rho^{-1} \varphi_n^{-1}) \tau_{X^0, \otimes_{j=1}^n(Y^j)^{\varepsilon_j}} (\text{id}_{X^0} \otimes v) \\ &= (v \otimes \rho^{-1} \varphi_n^{-1}) \tau_{X^0, \otimes_{i=1}^m Y_i^{\varepsilon_i}}. \end{aligned}$$

Set

$$\varrho = (\varphi_{y_m} \cdots \varphi_{y_2}(\xi_1)) \circ \cdots \circ (\varphi_{y_m}(\xi_{m-1})) \circ \xi_m$$

where $\xi_i = \psi_i$ if $\varepsilon_i = +$ and $\xi_i = \overline{\psi_i}$ otherwise. Using the hypothesis $\varphi_n \rho = \varphi_m \varrho$ and (20), we obtain

$$\begin{aligned} g &= (v \otimes \varrho^{-1} \varphi_m^{-1}) \tau_{X^0, \otimes_{i=1}^m Y_i^{\varepsilon_i}} \\ &= (v \otimes \varrho^{-1}) (\text{id}_{\otimes_{i=1}^{m-1} Y_i^{\varepsilon_i}} \otimes \tau_{\varphi_{y_{m-1}} \cdots \varphi_{y_1}(X_0), (Y_m)^{\varepsilon_m}}) \cdots (\tau_{X_0, Y_1^{\varepsilon_1}} \otimes \text{id}_{\otimes_{i=2}^m Y_i^{\varepsilon_i}}) \\ &= (v \otimes \text{id}_{X_m}) (\text{id}_{\otimes_{i=1}^{m-1} Y_i^{\varepsilon_i}} \otimes (\text{id}_{Y_m^{\varepsilon_m}} \otimes \xi_m^{-1}) \tau_{X_{m-1}, Y_m^{\varepsilon_m}}) \circ \cdots \\ &\quad \cdots \circ ((\text{id}_{Y_1^{\varepsilon_1}} \otimes \xi_1^{-1}) \tau_{X_0, Y_1^{\varepsilon_1}} \otimes \text{id}_{\otimes_{i=2}^m Y_i^{\varepsilon_i}}). \end{aligned}$$

The latter morphism is the image under \mathcal{F} of the diagram obtained by the move. This proves the invariance of \mathcal{F} under the third move of type 4. The fourth move of type 4 is treated similarly using (48) and (49). \square

9. THE FUNCTOR $F_{\mathcal{C}}$

In this section, we construct a canonical monoidal functor $\mathcal{G}_{\mathcal{C}} \rightarrow \mathcal{C}$. We begin by discussing relations between colored ribbon graphs and colored diagrams.

9.1. Presentation of graphs by diagrams. Any graph diagram D represents a ribbon graph Ω_D in the obvious way. Namely, we identify $\mathbb{R} \times [0, 1]$ with $\mathbb{R} \times \{0\} \times [0, 1] \subset \mathbb{R}^2 \times [0, 1]$ and slightly push the interiors of the underpasses of D along the second axis into $\mathbb{R} \times [0, 1] \times [0, 1]$ keeping the rest of D . This transforms the segments, circles, and coupons of D into the edges, circle components, and coupons of Ω_D , respectively. The framing of Ω_D is given by the constant vector field $(0, \delta, 0)$ with small $\delta > 0$.

Each underpass p of a segment d of D determines a *diagrammatic track* γ_p of the edge of $\Omega = \Omega_D$ represented by d . The track γ_p is represented by the linear path from the base point $z \in C_{\Omega}$ to the point of $\tilde{d} \subset \tilde{\Omega}$ obtained from an interior point of p by shifting along the framing vector. By Section 5.1, the track γ_p determines a (negative) meridian $\mu_{\gamma_p} \in \pi_1(C_{\Omega})$ which we call the *diagrammatic meridian* of p and denote by μ_p . If the underpass p is adjacent to an input/output of D , then γ_p is the corresponding input/output track of Ω . In a similar way, a coupon Q of D determines the *diagrammatic track* γ_Q of the corresponding coupon of Ω and the associated *diagrammatic meridian* $\mu_Q = \mu_{\gamma_Q} \in \pi_1(C_{\Omega})$.

If D has no circle 1-strata, then there is a direct relationship between the colorings of D and $\Omega = \Omega_D$. Pick a homomorphism $g: \pi_1(C_{\Omega}) \rightarrow G$. Each pre-coloring u of (Ω, g) induces a pre-coloring $U = U(u)$ of D as follows: for every underpass p of D , set $U_p = u_{\gamma_p} \in C_{g(\mu_p)}$ and for every crossing c of D , set

$$U_c = u_{\mu_{\underline{c}}^{-1}, \gamma_{c^-}} : U_{c^+} = u_{\gamma_{c^+}} = u_{\mu_{\underline{c}}^{-1}, \gamma_{c^-}} \rightarrow \varphi_{g(\mu_{\underline{c}})}(u_{\gamma_{c^-}}) = \varphi_{|U_{\underline{c}}|}(U_{c^-}).$$

Here we use the obvious equality $\gamma_{c^+} = \mu_{\underline{c}}^{-1} \gamma_{c^-}$. Similarly, a coloring (u, v) of (Ω, g) induces a coloring $(U = U(u), V)$ of D by $V_Q = v_{\gamma_Q}$ for any coupon Q of D . We say that the colored diagram (D, U, V) *represents* the colored G -graph (Ω, g, u, v) .

To sum up, the structure (Ω, g) of a G -graph on $\Omega = \Omega_D$ together with a coloring (u, v) of this G -graph induce a coloring (U, V) of D . The homomorphism $g: \pi_1(C_{\Omega}) \rightarrow G$ can be recovered from U by $g(\mu_p) = |U_p|$ for any underpass p of D . Though we shall not need it, note that the coloring (u, v) can be recovered from (U, V) uniquely up to isomorphism. Thus, the colored G -graph (Ω, g, u, v) can be reconstructed from the colored diagram (D, U, V) uniquely up to isomorphism. Generally speaking, there are colorings of D that do not arise in this way from colorings of Ω . We emphasize that these constructions apply only to diagrams and ribbon graphs without circle components.

Lemma 9.1. *Let Ω_r be a colored G -graph having no circle components and represented by a colored diagram D_r for $r = 1, 2$.*

- (i) *If Ω_1, Ω_2 are color-equivalent, then there is a finite sequence of colored Reidemeister moves, isotopies, and isomorphisms of colorings which transforms D_1 into D_2 .*
- (ii) *If Ω_1, Ω_2 are stably color-equivalent, then there is a finite sequence of colored Reidemeister moves, isotopies, isomorphisms of colorings, stabilizations, and moves inverse to stabilizations which transforms D_1 into D_2 .*

Proof. Claim (ii) directly follows from Claim (i) and we focus on the latter. Recall that the color-equivalence of colored G -graphs is generated by isomorphisms of colorings and isotopies. It is clear that isomorphisms of colorings of graphs induce isomorphisms of the induced colorings of diagrams. It remains to handle isotopies of graphs.

The existence of a color-preserving isotopy of Ω_1 into Ω_2 implies the existence of a color-preserving isotopy of Ω_1 into Ω_2 which keeps all the coupons parallel to the strip $\mathbb{R} \times \{0\} \times [0, 1]$ (this follows from the surjectivity of the inclusion homomorphism $\pi_1(SO(2)) \rightarrow \pi_1(SO(3))$). Projecting such an isotopy into $\mathbb{R} \times [0, 1]$, we obtain a finite sequence of colored Reidemeister moves and isotopies transforming D_1 into D_2 . Note that the type 3 moves determined by various orientations of the branches may be expanded as compositions of the type 3 move of Figure 7 and the type 2 moves, see for instance [Po]. Therefore it is enough to consider only the type 3 move shown in Figure 7. We need to prove that the colorings of the diagrams are transformed as in the definition of the colored Reidemeister moves. This is a consequence of the following statement.

Claim. A Reidemeister move $D \mapsto \tilde{D}$ on (uncolored) graph diagrams without circle 1-strata determines a self-homeomorphism f of $\mathbb{R}^2 \times [0, 1]$ carrying $\Omega = \Omega_D$ to $\tilde{\Omega} = \Omega_{\tilde{D}}$. Given a homomorphism $g: \pi_1(C_\Omega) \rightarrow G$ and a coloring (u, v) of (Ω, g) , we transfer this data along f to obtain a homomorphism $\tilde{g}: \pi_1(C_{\tilde{\Omega}}) \rightarrow G$ and a coloring (\tilde{u}, \tilde{v}) of $(\tilde{\Omega}, \tilde{g})$. Then the diagrams D and \tilde{D} with the colorings (U, V) and (\tilde{U}, \tilde{V}) induced from (u, v) and (\tilde{u}, \tilde{v}) respectively, are related by the corresponding colored Reidemeister move.

In the proof we will use the action of f^{-1} on the tracks: for a track γ of an edge/coupon of $\tilde{\Omega}$, its pre-image $f^{-1}(\gamma)$ is a track of the corresponding edge/coupon of Ω . The isomorphism $\pi_1(C_{\tilde{\Omega}}) \rightarrow \pi_1(C_\Omega)$ induced by f^{-1} will be also denoted by f^{-1} . In this notation $\tilde{g} = g f^{-1}$ and $\tilde{u}_\gamma = u_{f^{-1}(\gamma)}$ for any edge-track γ of $\tilde{\Omega}$.

Consider the first type 1 move $D \mapsto \tilde{D}$ in Figure 5. Let p be the underpass of D modified by the move. The corresponding piece of \tilde{D} contains two new crossings c , e and splits into 3 underpasses c^- , e^- , and $\underline{c} = \underline{e} = c^+ = e^+$. Since $f^{-1}(\gamma_{c^-}) = \gamma_p$,

$$\tilde{U}_{c^-} = \tilde{u}_{\gamma_{c^-}} = u_{f^{-1}(\gamma_{c^-})} = u_{\gamma_p} = U_p.$$

Similarly, $f^{-1}(\gamma_{e^-}) = \gamma_p$ and $\tilde{U}_{e^-} = U_p$. Also,

$$\tilde{U}_c = \tilde{u}_{\mu_{\underline{c}}^{-1}, \gamma_{c^-}} = u_{f^{-1}(\mu_{\underline{c}}^{-1}), f^{-1}(\gamma_{c^-})} = u_{f^{-1}(\mu_{\underline{c}}^{-1}), f^{-1}(\gamma_{e^-})} = \tilde{u}_{\mu_{\underline{c}}^{-1}, \gamma_{e^-}} = \tilde{U}_e.$$

Thus, the move $(D, U, V) \mapsto (\tilde{D}, \tilde{U}, \tilde{V})$ is as shown in Figure 5, where $X = U_p$, $X' = \tilde{U}_{\underline{c}} = \tilde{U}_{\underline{e}}$, and $\psi = \tilde{U}_c = \tilde{U}_e$. The other type 1 moves are treated similarly.

A type 2 move $D \mapsto \tilde{D}$ creates two new crossings c , e such that $\underline{c} = \underline{e}$. The \tilde{U} -colors in the top and bottom of \tilde{D} coincide because $\tilde{U} = U \circ f^{-1}$, $f = \text{id}$ near the top/bottom, and the U -colors in the top and bottom of D coincide. The equality $\tilde{U}_c = \tilde{U}_e$ follows from the formulas $\mu_{\underline{c}} = \mu_{\underline{e}}$ and $f^{-1}(\gamma_{c^-}) = f^{-1}(\gamma_{e^-})$. The latter holds because either $c^- = e^-$ or both tracks $f^{-1}(\gamma_{c^-})$ and $f^{-1}(\gamma_{e^-})$ are equal to the diagrammatic track of one and the same underpass of D .

Consider a type 3 move $D \mapsto \tilde{D}$. Denote by c the crossing of D colored with C and by c' the crossing of \tilde{D} colored with C' . It is clear that f carries γ_{c^-} and $\mu_{\gamma_{\underline{c}}}$

to $\gamma_{(c')^-}$ and $\mu_{\gamma_{\underline{c}'}}$, respectively. Therefore

$$C' = \tilde{U}_{c'} = \tilde{u}_{\mu_{\gamma_{\underline{c}'}}^{-1}, \gamma_{(c')^-}} = u_{f^{-1}(\mu_{\gamma_{\underline{c}'}}^{-1}), f^{-1}(\gamma_{(c')^-})} = u_{\mu_{\gamma_{\underline{c}'}}^{-1}, \gamma_{c^-}} = U_c = C.$$

Let p, q, r be the underpasses of D colored with X, Y, Z , respectively. Thus, $X = u_{\gamma_p}$, $Y = u_{\gamma_q}$, and $Z = u_{\gamma_r}$. Set $\gamma = \gamma_p$, $\delta = \mu_{\gamma_q}^{-1}$, and $\beta = \mu_{\gamma_r}^{-1}$. Then

$$\varphi_2(|Z|, |Y|)_X \varphi_{|Z|}(A)B = \varphi_2(g(\beta^{-1}), g(\delta^{-1}))_{u_\gamma} \varphi_{g(\beta^{-1})}(u_{\delta, \gamma}) u_{\beta, \delta \gamma} = u_{\beta \delta, \gamma}$$

where the last equality follows from the commutativity of the diagram (26) and we use the formulas $|Z| = g(\beta^{-1})$, $|Y| = g(\delta^{-1})$. Let p', q', r' be the underpasses of \tilde{D} colored with X, Y', Z , respectively. A similar computation gives

$$\varphi_2(|Y'|, |Z|)_X \varphi_{|Y'|}(A')B' = \tilde{u}_{\beta' \delta', \gamma'},$$

where $\beta' = \mu_{\gamma_{q'}}^{-1}$, $\delta' = \mu_{\gamma_{r'}}^{-1}$, and $\gamma' = \gamma_{p'}$. Clearly, $f^{-1}(\beta' \delta') = \beta \delta$ and $f^{-1}(\gamma') = \gamma$. Hence $\tilde{u}_{\beta' \delta', \gamma'} = u_{\beta \delta, \gamma}$ which proves the commutativity of the diagram (39).

Consider now a type 4 move $D \mapsto \tilde{D}$. Denote by Q the coupon of D subject to the move and by \tilde{Q} the corresponding coupon of \tilde{D} . We begin with the first type 4 move. We must prove that the morphisms v_0, v_1, ψ_i, ψ^j determined by the colorings (u, v) and (\tilde{u}, \tilde{v}) turn (40) into a commutative diagram. Let $\beta \in \pi_1(C_{\tilde{\Omega}})$ be the inverse of the diagrammatic (negative) meridian of the Z -colored underpass of \tilde{D} . Clearly, $\tilde{g}(\beta^{-1}) = |Z| = \mu \in G$. Let γ be the diagrammatic track of \tilde{Q} . We shall identify the diagram (40) with the diagram (28) associated with these β, γ and the coloring (\tilde{u}, \tilde{v}) of \tilde{D} . For $i = 1, \dots, m$, the track γ_i derived from γ as in Section 5.3 is the diagrammatic track of the Y_i -colored underpass of \tilde{D} and $\beta \gamma_i$ is the diagrammatic track of the X_i -colored underpass of \tilde{D} . Therefore $\tilde{u}_{\beta \gamma_i} = Y_i$ and $\tilde{u}_{\beta \gamma_i} = X_i$ for all i . For $j = 1, \dots, n$, the track γ^j derived from γ as in Section 5.3 is the diagrammatic track of the X^j -colored underpass of \tilde{D} and so $\tilde{u}_{\gamma^j} = X^j$ for all j . To compute $\tilde{u}_{\beta \gamma^j} = u_{f^{-1}(\beta \gamma^j)}$, note that $f^{-1}(\beta \gamma^j)$ is the diagrammatic track of the Y^j -colored underpass of D . Hence $\tilde{u}_{\beta \gamma^j} = Y^j$ for all j . Thus, the diagrams (28) and (40) have the same objects. It follows directly from the definitions that the morphisms are also the same. Now, the commutativity of (28) implies the commutativity of (40). The second type 4 move is treated similarly using in the role of $\beta \in \pi_1(C_{\tilde{\Omega}})$ the diagrammatic meridian of the Z -colored underpass (rather than its inverse as above). One should also use the identity $\overline{u_{\delta^{-1}, \delta \gamma}} = u_{\delta, \gamma}$ which holds for any $\delta \in \pi_1(C_\Omega)$ and any edge-track γ of Ω . This identity is a consequence of the definition of a coloring of Ω .

Consider the third type 4 move $D \mapsto \tilde{D}$. We need to prove the equality of the compositions (41) and (42). Let γ^j be the diagrammatic track of the X^j -colored underpass of D for $j = 0, 1, \dots, n$. By the definition of the induced coloring, $X^j = u_{\gamma^j}$ for all j . Note that $\gamma^n = \beta^{-1} \gamma^0$ where $\beta \in \pi_1(C_\Omega)$ is the diagrammatic meridian of Q . We claim that the composition (41) is equal to $u_{\beta^{-1}, \gamma^0}: X^n \rightarrow \varphi_{g(\beta)}(X^0)$. Suppose first that $\varepsilon^j = +$ for all $j = 1, \dots, n$. For $n = 1$ our claim follows from the definition of ψ^1 . For $n \geq 2$ the claim is deduced by induction from the commutativity of the diagram (26). The case $\varepsilon^j = -$ can be reduced to the case $\varepsilon^j = +$ by inverting the orientation of the Y^j -colored underpath and changing its color to $(Y^j)^*$. Indeed, under this transformation the color of the j -th crossing $\psi^j = u_{y^{-1}, \gamma^j}: X^{j-1} \rightarrow \varphi_y(X^j)$ (where $y = |Y^j| \in G$) changes to

$u_{y,\gamma^{j-1}}: X^j \rightarrow \varphi_{y^{-1}}(X^{j-1})$ and we need only to observe that

$$u_{y,\gamma^{j-1}} = u_{y,y^{-1}\gamma^j} = \overline{u_{y^{-1},\gamma^j}} = \overline{\psi^j}.$$

A similar computation shows that the composition (42) is equal to $\tilde{u}_{\mu^{-1},\gamma_0}: X_m \rightarrow \varphi_{g(\mu)}(X_0)$ where $\mu \in \pi_1(C_{\tilde{Q}})$ is the diagrammatic meridian of \tilde{Q} and γ_0 is the diagrammatic track of the X_0 -colored underpass of \tilde{D} . It remains to observe that $X_m = X^n$, $X_0 = X^0$, and

$$\tilde{u}_{\mu^{-1},\gamma_0} = u_{f^{-1}(\mu^{-1}),f^{-1}(\gamma_0)} = u_{\beta^{-1},\gamma^0}.$$

The fourth type 4 move is treated similarly. □

9.2. Functor $F_{\mathcal{C}}$. For any G -ribbon category \mathcal{C} , we define a functor $F_{\mathcal{C}}: \mathcal{G}_{\mathcal{C}} \rightarrow \mathcal{C}$ as follows. Consider the category of colored diagrams $\mathcal{D} = \mathcal{D}_{\mathcal{C}}$ and let $\overline{\mathcal{D}}$ be its quotient by the equivalence relation on the set of morphisms generated by the colored Reidemeister moves and stabilization. The category $\overline{\mathcal{D}}$ has the same objects as \mathcal{D} , and the structure of a strict monoidal category in \mathcal{D} induces a structure of a strict monoidal category in $\overline{\mathcal{D}}$. Theorem 8.1 implies that the strong monoidal functor $\mathcal{F}: \mathcal{D} \rightarrow \mathcal{C}$ of Lemma 7.1 is invariant under the colored Reidemeister moves and stabilization. Therefore \mathcal{F} induces a strong monoidal functor $\overline{\mathcal{F}}: \overline{\mathcal{D}} \rightarrow \mathcal{C}$.

Consider the strict monoidal functor $P: \mathcal{G}_{\mathcal{C}} \rightarrow \overline{\mathcal{D}}$ that carries each object to itself and carries a morphism represented by a colored G -graph into the morphism represented by a diagram of this graph with induced coloring. Lemma 9.1 implies that P is well defined. Set

$$F_{\mathcal{C}} = \overline{\mathcal{F}}P: \mathcal{G}_{\mathcal{C}} \rightarrow \mathcal{C}.$$

Since P is strict monoidal and $\overline{\mathcal{F}}$ is strong monoidal, their composition $F_{\mathcal{C}}$ is strong monoidal. We summarize the relationships between these functors in the following commutative diagram:

$$\begin{array}{ccc} & \mathcal{D}_{\mathcal{C}} & \\ & \downarrow & \searrow \mathcal{F}_{\mathcal{C}} \\ \mathcal{G}_{\mathcal{C}} & \xrightarrow{P} \overline{\mathcal{D}}_{\mathcal{C}} & \xrightarrow{\overline{\mathcal{F}}_{\mathcal{C}}} \mathcal{C} \\ & \searrow F_{\mathcal{C}} & \end{array}$$

9.3. Remarks. 1. The category $\mathcal{D}_{\mathcal{C}}$ becomes a pivotal G -graded category by setting

$$|U| = \prod_{r=1}^k |U_r|^{\varepsilon_r} \quad \text{and} \quad U^* = ((U_k, -\varepsilon_k), \dots, (U_1, -\varepsilon_1))$$

for any object $U = ((U_1, \varepsilon_1), \dots, (U_k, \varepsilon_k))$ of \mathcal{D} , and

$$\begin{array}{cc} \text{ev}_U = \begin{array}{c} \vdots \\ \text{---} \text{---} \text{---} \\ \text{---} \text{---} \text{---} \\ (U_k, -\varepsilon_k) \quad (U_1, -\varepsilon_1) \quad (U_1, \varepsilon_1) \quad (U_k, \varepsilon_k) \end{array}, & \text{coev}_U = \begin{array}{c} (U_1, \varepsilon_1) \quad (U_k, \varepsilon_k) \quad (U_k, -\varepsilon_k) \quad (U_1, -\varepsilon_1) \\ \text{---} \text{---} \text{---} \\ \text{---} \text{---} \text{---} \\ \vdots \end{array}, \\ \text{\tilde{e}v}_U = \begin{array}{c} \vdots \\ \text{---} \text{---} \text{---} \\ \text{---} \text{---} \text{---} \\ (U_1, \varepsilon_1) \quad (U_k, \varepsilon_k) \quad (U_k, -\varepsilon_k) \quad (U_1, -\varepsilon_1) \end{array}, & \text{\tilde{c}o\tilde{e}v}_U = \begin{array}{c} (U_k, -\varepsilon_k) \quad (U_1, -\varepsilon_1) \quad (U_1, \varepsilon_1) \quad (U_k, \varepsilon_k) \\ \text{---} \text{---} \text{---} \\ \text{---} \text{---} \text{---} \\ \vdots \end{array}, \end{array}$$

where the orientation of the arcs is uniquely determined by the signs ε_i .

It is easy to check that the functor $\mathcal{F} = \mathcal{F}_{\mathcal{C}}: \mathcal{D}_{\mathcal{C}} \rightarrow \mathcal{C}$ is grading preserving and pivotal. We have

$$\mathcal{F}^1((U_1, \varepsilon_1), \dots, (U_n, \varepsilon_n)) = \mathcal{F}^1(U_n, \varepsilon_n) \otimes \cdots \otimes \mathcal{F}^1(U_1, \varepsilon_1)$$

where

$$\mathcal{F}^1(U_i, \varepsilon_i) = \begin{cases} \text{id}_{U_i^*}: U_i^* \rightarrow U_i^* & \text{if } \varepsilon_i = +, \\ (\tilde{\text{ev}}_{U_i} \otimes \text{id}_{U_i^{**}})(\text{id}_{U_i} \otimes \text{coev}_{U_i^*}): U_i \rightarrow U_i^{**} & \text{if } \varepsilon_i = -. \end{cases}$$

Similarly, using colored G -graphs represented by the diagrams above, one can turn $\mathcal{G}_{\mathcal{C}}$ into a pivotal G -graded category, and then the functor $F_{\mathcal{C}}: \mathcal{G}_{\mathcal{C}} \rightarrow \mathcal{C}$ is grading preserving and pivotal.

2. Using appropriate colored braids, one can define a G -braiding in $\mathcal{G}_{\mathcal{C}}$ turning $\mathcal{G}_{\mathcal{C}}$ into a G -ribbon category so that the functor $F_{\mathcal{C}}$ preserves both the G -braiding and the G -twist. We shall not use this G -braiding.

10. CONJUGATION OF COLORINGS

In this section, we define conjugation of colorings and describe the behavior of the functor $F_{\mathcal{C}}: \mathcal{G}_{\mathcal{C}} \rightarrow \mathcal{C}$ under conjugation.

10.1. Conjugation of colorings. We can conjugate G -graphs and their colorings by any $\eta \in G$. For a G -graph (Ω, g) , its η -conjugate $\Omega^\eta = (\Omega, g^\eta)$ is the same ribbon graph Ω endowed with the homomorphism $g^\eta = \eta^{-1}g\eta: \pi_1(C_\Omega) \rightarrow G$. Given a pre-coloring u of (Ω, g) , we define the η -conjugate pre-coloring u^η of (Ω, g^η) by $u_\gamma^\eta = \varphi_\eta(u_\gamma) \in \mathcal{C}_{g^\eta(\mu_\gamma)}$ for any edge-track γ of Ω . For $\beta \in \pi_1(C_\Omega)$, we define the isomorphism $u_{\beta, \gamma}^\eta: u_{\beta\gamma}^\eta \rightarrow \varphi_{g^\eta(\beta^{-1})}(u_\gamma^\eta)$ as the composition of the isomorphisms

$$\begin{aligned} u_{\beta\gamma}^\eta = \varphi_\eta(u_{\beta\gamma}) &\xrightarrow{\varphi_\eta(u_{\beta, \gamma})} \varphi_\eta \varphi_{g(\beta^{-1})}(u_\gamma) \xrightarrow{\varphi_2(\eta, g(\beta^{-1}))_{u_\gamma}} \varphi_{g(\beta^{-1})\eta}(u_\gamma) \\ &= \varphi_{\eta g^\eta(\beta^{-1})}(u_\gamma) \xrightarrow{(\varphi_2(g^\eta(\beta^{-1}), \eta)_{u_\gamma})^{-1}} \varphi_{g^\eta(\beta^{-1})} \varphi_\eta(u_\gamma) = \varphi_{g^\eta(\beta^{-1})}(u_\gamma^\eta). \end{aligned}$$

Lemma 10.1. u^η is a pre-coloring of Ω^η .

Proof. Consider the commutative diagram obtained by setting $\alpha = \eta$ and $X = u_\gamma$ in (16). Since $(\varphi_0)_{u_\gamma} = u_{1, \gamma}$, we deduce that $u_{1, \gamma}^\eta = (\varphi_0)_{\varphi_\eta(u_\gamma)} = (\varphi_0)_{u_\gamma}^\eta$.

We now check the commutativity of the diagram (26) where g and u are replaced by g^η and u^η respectively. It follows from the definitions that

$$\begin{aligned} \varphi_{g^\eta(\beta^{-1})}(u_{\delta, \gamma}^\eta) u_{\beta, \delta\gamma}^\eta &= \varphi_{g^\eta(\beta^{-1})}((\varphi_2(g^\eta(\delta^{-1}), \eta)_{u_\gamma})^{-1}) \circ \varphi_{g^\eta(\beta^{-1})}(\varphi_2(\eta, g(\delta^{-1}))_{u_\gamma}) \\ &\circ \varphi_{g^\eta(\beta^{-1})} \varphi_\eta(u_{\delta, \gamma}) \circ (\varphi_2(g^\eta(\beta^{-1}), \eta)_{u_{\delta\gamma}})^{-1} \circ \varphi_2(\eta, g(\beta^{-1}))_{u_{\delta\gamma}} \circ \varphi_\eta(u_{\beta, \delta\gamma}). \end{aligned}$$

We rewrite the composition of the three leftmost morphisms in the last row using twice the naturality of φ . This gives

$$\begin{aligned} \varphi_{g^\eta(\beta^{-1})}(u_{\delta, \gamma}^\eta) \circ u_{\beta, \delta\gamma}^\eta &= \varphi_{g^\eta(\beta^{-1})}((\varphi_2(g^\eta(\delta^{-1}), \eta)_{u_\gamma})^{-1}) \circ \varphi_{g^\eta(\beta^{-1})}(\varphi_2(\eta, g(\delta^{-1}))_{u_\gamma}) \\ &\circ (\varphi_2(g^\eta(\beta^{-1}), \eta)_{\varphi_{g(\delta^{-1})}(u_\gamma)})^{-1} \circ \varphi_{g(\beta^{-1})\eta}(u_{\delta, \gamma}) \circ \varphi_2(\eta, g(\beta^{-1}))_{u_{\delta\gamma}} \circ \varphi_\eta(u_{\beta, \delta\gamma}) \\ &= \varphi_{g^\eta(\beta^{-1})}((\varphi_2(g^\eta(\delta^{-1}), \eta)_{u_\gamma})^{-1}) \circ \varphi_{g^\eta(\beta^{-1})}(\varphi_2(\eta, g(\delta^{-1}))_{u_\gamma}) \\ &(\varphi_2(g^\eta(\beta^{-1}), \eta)_{\varphi_{g(\delta^{-1})}(u_\gamma)})^{-1} \circ \varphi_2(\eta, g(\beta^{-1}))_{\varphi_{g(\delta^{-1})}(u_\gamma)} \circ \varphi_\eta \varphi_{g(\beta^{-1})}(u_{\delta, \gamma}) \circ \varphi_\eta(u_{\beta, \delta\gamma}). \end{aligned}$$

Using the commutativity of (26) for g, u , we replace the composition of the two rightmost morphisms with $\varphi_\eta(\varphi_2(g(\beta^{-1}), g(\delta^{-1}))_{u_\gamma})^{-1} \circ \varphi_\eta(u_{\beta\delta, \gamma})$. At each of the next three steps we use (15). First, we replace

$$\varphi_2(\eta, g(\beta^{-1}))_{\varphi_{g(\delta^{-1})}(u_\gamma)} \circ \varphi_\eta(\varphi_2(g(\beta^{-1}), g(\delta^{-1}))_{u_\gamma})^{-1}$$

with

$$(\varphi_2(g(\beta^{-1})\eta, g(\delta^{-1}))_{u_\gamma})^{-1} \circ \varphi_2(\eta, g(\delta^{-1}\beta^{-1}))_{u_\gamma}.$$

Next, we replace

$$\varphi_{g^\eta(\beta^{-1})}(\varphi_2(\eta, g(\beta^{-1}))_{u_\gamma}) \circ (\varphi_2(g^\eta(\beta^{-1}), \eta)_{\varphi_{g(\delta^{-1})}(u_\gamma)})^{-1} \circ (\varphi_2(g(\beta^{-1})\eta, g(\delta^{-1}))_{u_\gamma})^{-1}$$

with $(\varphi_2(g^\eta(\beta^{-1}), g(\delta^{-1})\eta)_{u_\gamma})^{-1}$. Finally, we replace

$$\varphi_{g^\eta(\beta^{-1})}((\varphi_2(g^\eta(\delta^{-1}), \eta)_{u_\gamma})^{-1} \circ (\varphi_2(g^\eta(\beta^{-1}), g(\delta^{-1})\eta)_{u_\gamma})^{-1})$$

with

$$(\varphi_2(g^\eta(\beta^{-1}), g^\eta(\delta^{-1}))_{u_\gamma})^{-1} \circ (\varphi_2(g^\eta(\delta^{-1}\beta^{-1}), \eta)_{u_\gamma})^{-1}.$$

The resulting expression is nothing but $(\varphi_2(g^\eta(\beta^{-1}), g^\eta(\delta^{-1}))_{u_\gamma})^{-1} u_{\beta\delta, \gamma}^\eta$. \square

It is clear that the source and the target of Ω^η can be computed from the source and the target of Ω by applying φ_η to the objects of \mathcal{C} while keeping the signs.

For a coloring (u, v) of (Ω, g) , we define the η -conjugate coloring (u^η, v^η) of (Ω, g^η) . Here u^η is the pre-coloring defined above, and for any coupon-track γ of Ω , the morphism v_γ^η is defined as the composition of morphisms

$$\begin{aligned} \otimes_{i=1}^m (\varphi_\eta(u_{\gamma_i}))^{\varepsilon_i} &\xrightarrow{\otimes_i \rho_i^{-1}} \otimes_{i=1}^m \varphi_\eta(u_{\gamma_i}^{\varepsilon_i}) \xrightarrow{(\varphi_\eta)_m} \varphi_\eta(\otimes_{i=1}^m u_{\gamma_i}^{\varepsilon_i}) \xrightarrow{\varphi_\eta(v_\gamma)} \\ \varphi_\eta(\otimes_{j=1}^n u_{\gamma_j}^{\varepsilon_j}) &\xrightarrow{(\varphi_\eta)_n^{-1}} \otimes_{j=1}^n \varphi_\eta(u_{\gamma_j}^{\varepsilon_j}) \xrightarrow{\otimes_j \rho^j} \otimes_{j=1}^n (\varphi_\eta(u_{\gamma_j}))^{\varepsilon_j}. \end{aligned}$$

Here we use notation of Section 5.3 and set

$$\rho_i = \begin{cases} \text{id}_{\varphi_\eta(u_{\gamma_i})}: \varphi_\eta(u_{\gamma_i}) \rightarrow \varphi_\eta(u_{\gamma_i}) & \text{if } \varepsilon_i = +, \\ \varphi_\eta^1(u_{\gamma_i}): \varphi_\eta(u_{\gamma_i}^*) \rightarrow (\varphi_\eta(u_{\gamma_i}))^* & \text{if } \varepsilon_i = -. \end{cases}$$

and similarly

$$\rho^j = \begin{cases} \text{id}_{\varphi_\eta(u_{\gamma_j})}: \varphi_\eta(u_{\gamma_j}) \rightarrow \varphi_\eta(u_{\gamma_j}) & \text{if } \varepsilon^j = +, \\ \varphi_\eta^1(u_{\gamma_j}): \varphi_\eta(u_{\gamma_j}^*) \rightarrow (\varphi_\eta(u_{\gamma_j}))^* & \text{if } \varepsilon^j = -. \end{cases}$$

In the case where $m = n = 1$ and $\varepsilon_1 = \varepsilon^1 = +$, the definition of v_γ^η simplifies to $v_\gamma^\eta = \varphi_\eta(v_\gamma)$.

Lemma 10.2. (u^η, v^η) is a coloring of Ω^η .

Proof. We need to prove the commutativity of the diagram (28) for all γ, β . For simplicity, we restrict ourselves to coupon-tracks γ with $m = n = 1$ and $\varepsilon_1 = \varepsilon^1 = +$. Then the commutativity of (28) follows from the commutativity of the diagram

$$\begin{array}{ccccccc} \varphi_\eta(u_{\beta\gamma_1}) & \xrightarrow{\varphi_\eta(u_{\beta, \gamma_1})} & \varphi_\eta\varphi_{g(\beta^{-1})}(u_{\gamma_1}) & \xrightarrow{\varphi_2} & \varphi_{g(\beta^{-1})\eta}(u_{\gamma_1}) & \xrightarrow{(\varphi_2)^{-1}} & \varphi_{g^\eta(\beta^{-1})}\varphi_\eta(u_{\gamma_1}) \\ v_{\beta\gamma}^\eta \downarrow & & \varphi_\eta\varphi_{g(\beta^{-1})}(v_\gamma) \downarrow & & \varphi_{g(\beta^{-1})\eta}(v_\gamma) \downarrow & & \varphi_{g^\eta(\beta^{-1})}(v_\gamma^\eta) \downarrow \\ \varphi_\eta(u_{\beta\gamma^1}) & \xrightarrow{\varphi_\eta(u_{\beta, \gamma^1})} & \varphi_\eta\varphi_{g(\beta^{-1})}(u_{\gamma^1}) & \xrightarrow{\varphi_2} & \varphi_{g(\beta^{-1})\eta}(u_{\gamma^1}) & \xrightarrow{(\varphi_2)^{-1}} & \varphi_{g^\eta(\beta^{-1})}\varphi_\eta(u_{\gamma^1}). \end{array}$$

□

Isomorphisms of colorings can also be conjugated in the obvious way and yield isomorphisms of the conjugate colorings.

10.2. Behavior of $F = F_C$ under conjugation of colorings.

Theorem 10.3. *Let \mathcal{C} be a G -ribbon category, and let Ω be a colored G -graph with source $(u_1, \varepsilon_1), \dots, (u_k, \varepsilon_k)$ and target $(u^1, \varepsilon^1), \dots, (u^l, \varepsilon^l)$. Let Ω^η be the colored G -graph obtained from Ω through conjugation by $\eta \in G$. Then the morphism $F(\Omega^\eta)$ is equal to the following composition*

$$\begin{aligned} \otimes_{r=1}^k (\varphi_\eta(u_r))^{\varepsilon_r} &\xrightarrow{\otimes_r \rho_r^{-1}} \otimes_{r=1}^k \varphi_\eta(u_r^{\varepsilon_r}) \xrightarrow{(\varphi_\eta)_k} \varphi_\eta(\otimes_{r=1}^k u_r^{\varepsilon_r}) \xrightarrow{\varphi_\eta(F(\Omega))} \\ \varphi_\eta(\otimes_{j=1}^l (u^s)^{\varepsilon^s}) &\xrightarrow{(\varphi_\eta)_l^{-1}} \otimes_{s=1}^l \varphi_\eta((u^s)^{\varepsilon^s}) \xrightarrow{\otimes_s \rho^s} \otimes_{s=1}^l (\varphi_\eta(u^s))^{\varepsilon^s}, \end{aligned}$$

where $\rho_r = \text{id}_{\varphi_\eta(u_r)}$ if $\varepsilon_r = +$, $\rho_r = \varphi_\eta^1(u_r)$ if $\varepsilon_r = -$ and similarly $\rho^s = \text{id}_{\varphi_\eta(u^s)}$ if $\varepsilon^s = +$, $\rho^s = \varphi_\eta^1(u^s)$ if $\varepsilon^s = -$.

For $m = n = 0$, we obtain $F(\Omega^\eta) = (\varphi_\eta)_0^{-1} \varphi_\eta(F(\Omega)) (\varphi_\eta)_0$. In particular, if the morphism $F(\Omega) \in \text{End}_{\mathcal{C}}(\mathbb{1})$ is a scalar multiple of $\text{id}_{\mathbb{1}}$, then $F(\Omega^\eta) = F(\Omega)$.

Proof. We give the main lines of the proof leaving the details to the reader. First of all, a coloring (U, V) of an arbitrary graph diagram D determines an η -conjugate coloring (U^η, V^η) of D as follows. For an underpass p of D , set $U_p^\eta = \varphi_\eta(U_p)$. For a crossing c of D , let U_c^η be the composition

$$\begin{aligned} U_{c^+}^\eta = \varphi_\eta(U_{c^+}) &\xrightarrow{\varphi_\eta(U_c)} \varphi_\eta \varphi_{|U_{\underline{c}}|} (U_{c^-}) \xrightarrow{\varphi_2(\eta, |U_{\underline{c}}|)_{U_{c^-}}} \varphi_{|U_{\underline{c}}|\eta} (U_{c^-}) \\ &= \varphi_{\eta|U_{\underline{c}}|} (U_{c^-}) \xrightarrow{(\varphi_2(|U_{\underline{c}}|\eta)_{U_{c^-}})^{-1}} \varphi_{|U_{\underline{c}}|\eta} \varphi_\eta (U_{c^-}) = \varphi_{|U_{\underline{c}}|\eta} (U_{c^-}^\eta). \end{aligned}$$

The coloring V^η of the coupons of D is defined similarly to v^η in Section 10.1. The colored diagram (D, U^η, V^η) is denoted by D^η .

We next define the conjugation endofunctor Φ_η of the category $\mathcal{D}_{\mathcal{C}}$. It transforms an object $((U_r, \varepsilon_r))_{r=1}^k$ of $\mathcal{D}_{\mathcal{C}}$ into the object $((\varphi_\eta(U_r), \varepsilon_r))_{r=1}^k$. A morphism of $\mathcal{D}_{\mathcal{C}}$ represented by a colored diagram D is transformed into the morphism represented by D^η . It is easy to see that Φ_η is a strict monoidal functor. Comparing the values on the elementary diagrams, one easily observes that for any morphism $f: ((U_r, \varepsilon_r))_{r=1}^k \rightarrow ((U^s, \varepsilon^s))_{s=1}^l$ in $\mathcal{D}_{\mathcal{C}}$, the following diagram commutes:

$$\begin{array}{ccccc} \otimes_{r=1}^k (\varphi_\eta(U_r))^{\varepsilon_r} & \xrightarrow{\otimes_r \rho_r^{-1}} & \otimes_{r=1}^k \varphi_\eta(U_r^{\varepsilon_r}) & \xrightarrow{(\varphi_\eta)_k} & \varphi_\eta(\otimes_{r=1}^k U_r^{\varepsilon_r}) \\ \downarrow F\Phi_\eta(f) & & & & \downarrow \varphi_\eta(F(f)) \\ \otimes_{s=1}^l (\varphi_\eta(U^s))^{\varepsilon^s} & \xrightarrow{\otimes_s (\rho^s)^{-1}} & \otimes_{s=1}^l \varphi_\eta((U^s)^{\varepsilon^s}) & \xrightarrow{(\varphi_\eta)_l} & \varphi_\eta(\otimes_{s=1}^l (U^s)^{\varepsilon^s}). \end{array}$$

Here $\rho_r = \text{id}_{\varphi_\eta(U_r)}$ if $\varepsilon_r = +$, $\rho_r = \varphi_\eta^1(U_r)$ if $\varepsilon_r = -$ and similarly $\rho^s = \text{id}_{\varphi_\eta(U^s)}$ if $\varepsilon^s = +$, $\rho^s = \varphi_\eta^1(U^s)$ if $\varepsilon^s = -$.

Observe finally that if a colored G -graph Ω is represented by a colored diagram D , then Ω^η is represented by D^η . Now, the claim of the theorem directly follows from the commutativity of the previous diagram. □

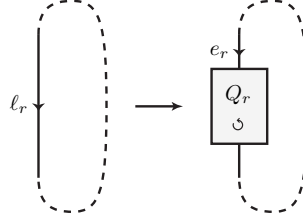

FIGURE 11. Insertion of a coupon

11. INVARIANTS OF SPECIAL G -GRAPHS

In this section, we derive from a G -ribbon category \mathcal{C} an invariant of so-called special colored G -graphs (such graphs possibly have circle components). This construction will be crucial in the definition of the surgery HQFT.

11.1. Insertion of coupons. The functor \mathcal{F} of Lemma 7.1 does not apply to colored G -graphs having circle components. In particular, this functor does not apply to knots and links. We show how to transform circle components into graphs with coupons and to derive from \mathcal{F} invariants of some G -links.

Let $(\Gamma, g: \pi_1(C_\Gamma) \rightarrow G)$ be a \mathcal{C} -colored G -graph with circle components $(\ell_r)_r$. We transform Γ into a colored G -graph Ω_Γ without circle components as follows. Insert into each circle component ℓ_r of Γ a coupon Q_r with one input and one output, see Figure 11. In this figure Q_r is oriented counterclockwise, its bottom base is the bottom horizontal side, and the framing is given (on the boldface portions) by the vector field orthogonal to the page of the picture and directed behind the page. In this way, ℓ_r is transformed into a union of Q_r and an oriented segment e_r for all r . These coupons and segments together with $\Gamma \setminus \cup_r \ell_r$ form a ribbon graph $\Omega = \Omega_\Gamma$. Clearly, $\pi_1(C_\Omega) = \pi_1(C_\Gamma)$ so that the homomorphism $g: \pi_1(C_\Gamma) \rightarrow G$ induces a homomorphism $\pi_1(C_\Omega) \rightarrow G$ also denoted g .

The given coloring of Γ determines a coloring of all tracks of Ω except the tracks of the edges $(e_r)_r$ and the coupons $(Q_r)_r$. By colorings of Ω we shall mean only the colorings extending this “partial coloring”. To color the tracks of $(e_r)_r$ and $(Q_r)_r$, fix a z -path $\gamma(r)$ for each Q_r and set $\mu_r = \mu_{\gamma(r)} \in \pi_1(C_\Omega)$. Pushing the endpoint of $\gamma(r)$ on \tilde{Q}_r towards the top (resp. bottom) base, we obtain a z -path for e_r , cf. Section 5.3. Let γ^r and γ_r be the corresponding tracks of e_r . Clearly, $\mu_{\gamma^r} = \mu_{\gamma_r} = \mu_r$ and $\gamma_r = \lambda_r \gamma^r$ where $\lambda_r \in \pi_1(C_\Omega)$ is the longitude of ℓ_r determined by $\gamma(r)$ and the orientation and the framing of ℓ_r . Given objects $(X_r \in \mathcal{C}_{g(\mu_r)})_r$, Lemma 5.1 yields an edge-coloring u of Ω such that $u_{\gamma_r} = X_r$ for all r . Note that u gives an isomorphism $u_{\lambda_r^{-1}, \gamma_r}: u_{\gamma^r} \rightarrow \varphi_{g(\lambda_r)}(X_r)$ for all r . We color each coupon-track $\gamma(r)$ with the composition of a morphism $X_r \rightarrow \varphi_{g(\lambda_r)}(X_r)$ with $(u_{\lambda_r^{-1}, \gamma_r})^{-1}$. By Section 5.3, this extends to a coloring of Ω .

11.2. Special colored G -graphs. We call a colored G -graph (Γ, g) *special* if the longitudes of all circle components of Γ lie in $\text{Ker } g$. An example of a special G -graph is provided by the *trivial G -knot* defined as a framed oriented unknot in S^3 with trivial homomorphism of the fundamental group of the complement to G . A more general example is provided by any framed oriented link $\ell \subset S^3$ endowed

with homomorphism $\pi_1(S^3 \setminus \ell) \rightarrow G$ carrying the longitudes of all components of ℓ to 1. We call such links *special G -links*.

Let $(\Gamma, g: \pi_1(C_\Gamma) \rightarrow G)$ be a special \mathcal{C} -colored G -graph with circle components $(\ell_r)_r$. As in Section 11.1, consider an edge-coloring u of $\Omega = (\Omega_\Gamma, g)$ such that $u_{\gamma_r} = X_r \in \mathcal{C}_{g(\mu_r)}$ for all r . Consider the isomorphism $u_{\lambda_r^{-1}, \gamma_r}: u_{\gamma_r} \rightarrow \varphi_{g(\lambda_r)}(X_r) = \varphi_1(X_r)$. Given morphisms $(f_r \in \text{End}_{\mathcal{C}}(X_r))_{r=1}^n$, we color each $\gamma(r)$ with the morphism

$$(51) \quad v_{\gamma(r)} = (u_{\lambda_r^{-1}, \gamma_r})^{-1}(\varphi_0)_{X_r} f_r: u_{\gamma_r} \rightarrow u_{\gamma_r}.$$

This extends uniquely to a coloring (u, v) of Ω . The resulting colored G -graph is denoted $\Omega(X_r, f_r, \gamma(r))$. Different choices of u lead to isomorphic colored G -graphs so that $F(\Omega(X_r, f_r, \gamma(r))) \in \text{End}_{\mathcal{C}}(\mathbb{1})$ does not depend on the choice of u . The map $(X_r, f_r)_r \mapsto F(\Omega(X_r, f_r, \gamma(r)))$ extends by \mathbb{k} -linearity to an n -linear form

$$(52) \quad \otimes_{r=1}^n \tilde{L}_{g(\mu_r)} \rightarrow \text{End}_{\mathcal{C}}(\mathbb{1}),$$

where \tilde{L} is defined in Section 3.4. Generally speaking, the form (52) depends on the choice of the tracks $(\gamma(r))_r$. Before exploring this form note that every coloring (u, v) of $\Omega = (\Omega_\Gamma, g)$ is obtained as above from a unique family of *associated morphisms* $(f_r \in \text{End}_{\mathcal{C}}(X_r))_r$ computed by $f_r = (\varphi_0)_{X_r}^{-1} u_{\lambda_r^{-1}, \gamma_r} v_{\gamma(r)}$.

We now study the form (52). We begin with the following lemma.

Lemma 11.1. *For any $r = 1, \dots, n$ and any $f_r, h_r \in \text{End}_{\mathcal{C}}(X_r)$ the morphism $f_r h_r - h_r f_r \in \text{End}_{\mathcal{C}}(X_r)$ lies in the annihilator of (52).*

Proof. Assume for simplicity that $\Gamma = \ell_1$ is a knot so that $r = n = 1$; the general case is similar. Set $\pi = \pi_1(C_\Gamma) = \pi_1(C_\Omega)$. Let $\gamma = \gamma(1)$ be the fixed track of the coupon $Q = Q_1$ of Ω and let $\mu = \mu_\gamma \in \pi$ be the associated meridian. We must prove that $F(\Omega(X, fh, \gamma)) = F(\Omega(X, hf, \gamma))$ for any object $X \in \mathcal{C}_{g(\mu)}$ and any endomorphisms f, h of X . This equality is well known in the non-crossed case; the proof goes by replacing the fh -colored coupon with two coupons colored with f, h , then pushing the h -colored coupon along Γ so that it comes on top of the f -colored coupon and finally replacing the two resulting coupons with an hf -colored coupon. These operations preserve the invariant F and yield the required equality. The crossed case is similar but needs a more careful treatment as follows.

A schematic picture of the colored G -graph $\Omega = \Omega(X, fh, \gamma)$ is shown in Figure 12. Here γ^1 (resp. γ_1) is the track of the edge $e = e_1$ of Ω obtained by slightly pushing γ to the top (resp. bottom) of Q . We have $\gamma^1 = \lambda^{-1}\gamma_1$, where $\lambda \in \pi$ is the longitude of Γ determined by γ . By definition, the coloring (u, v) of Ω satisfies $u_{\gamma_1} = X$ and $v_\gamma = (u_{\lambda^{-1}, \gamma_1})^{-1}(\varphi_0)_X fh: X \rightarrow Y$ where $Y = u_{\gamma^1} \in \mathcal{C}_{g(\mu)}$.

We replace the coupon Q with two coupons as in Figure 12. The resulting ribbon graph Ω' has two edges d, d' where $d \subset e$. We identify $\pi_1(C_{\Omega'}) = \pi$ in the obvious way so that Ω' becomes a G -graph. The track γ determines in the obvious way the tracks ρ, η of the two coupons of Ω' so that $\rho^1 = \eta_1$ and $\rho_1 = \gamma_1, \eta^1 = \gamma^1$ (as tracks of e). The edge-coloring u of Ω induces an edge-coloring of Ω' as follows. Each track of d in $C_{\Omega'}$ determines a track of e in C_Ω and keeps its u -color; the same holds for the isomorphisms determined by pairs (an element of π , a track of d). We color the track $\rho^1 = \eta_1$ of d' with X . This data extends to an edge-coloring u' of Ω' . Note that $u'_{\rho_1} = u_{\gamma_1} = X$ and $u'_{\eta^1} = u_{\gamma^1} = Y$. The edge-coloring u' extends

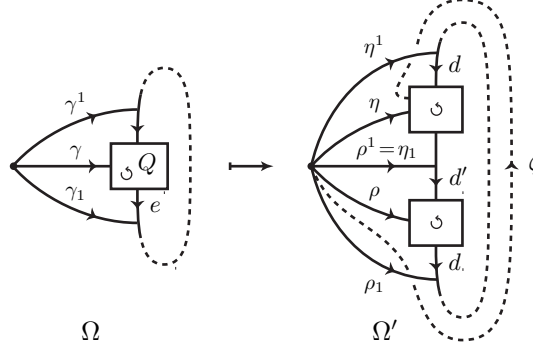
 FIGURE 12. The ribbon graphs Ω and Ω'

to a coloring (u', v') of Ω' such that $v'_\rho = h$ and $v'_\eta = (u_{\lambda^{-1}, \gamma_1})^{-1}(\varphi_0)_X f: X \rightarrow Y$. Note for the record that $\eta^1 = \lambda^{-1}\rho_1$ and $u'_{\lambda^{-1}, \rho_1} = u_{\lambda^{-1}, \gamma_1}: Y \rightarrow \varphi_1(X)$.

Pushing the upper coupon along d' and the lower coupon along d , we obtain a self-homeomorphism j of $\mathbb{R}^2 \times [0, 1]$ transforming Ω' into itself and permuting its edges and coupons. The homeomorphism j induces the identity automorphism of $\pi = \pi_1(C_{\Omega'})$. Transporting the coloring (u', v') of Ω' along j we obtain a coloring (u'', v'') of Ω' . Note that j transforms the tracks η, η_1, η^1 into the tracks ρ, ρ_1, ρ^1 , respectively. Therefore $u''_{\rho^1} = u'_{\eta^1} = X$, $u''_{\rho_1} = u'_{\eta_1} = Y$, and $v''_\rho = v'_\eta: X \rightarrow Y$. Consider the coupon-track $\zeta = j(\rho)$. Clearly, $\zeta^1 = j(\rho^1)$ and $\zeta_1 = j(\rho_1)$. Thus, $u''_{\zeta^1} = u'_{\rho^1} = X$, $u''_{\zeta_1} = u'_{\rho_1} = X$ and $v''_\zeta = v'_\rho = h$. The definition of j implies that the tracks ζ^1 and ρ_1 of d are equal: $\zeta^1 = \rho_1$.

Next, we contract the edge d' of Ω' to obtain the same G -graph Ω as before. The coloring (u'', v'') of Ω' induces a coloring (\bar{u}, \bar{v}) of Ω such that $\bar{u}_{\rho^1} = u''_{\rho^1} = X$, $\bar{u}_{\gamma^1} = u''_{\eta^1}$, and $\bar{v}_\gamma = v''_\eta v''_\rho: X \rightarrow \bar{u}_{\gamma^1} = u''_{\eta^1}$. It follows from the definitions that all these transformations of Ω preserve the invariant F :

$$F(\Omega, u, v) = F(\Omega', u', v') = F(\Omega', u'', v'') = F(\Omega, \bar{u}, \bar{v}).$$

The first equality is obtained by applying the definition of F to a diagram representing Ω and chosen so that the diagrammatic track of Q is equal to γ (such a diagram exists for any γ). The third equality is proven similarly. The second equality holds because the colored G -graphs (Ω', u', v') and (Ω', u'', v'') are isotopic.

To finish the proof, we identify the colored G -graph $(\Omega, \bar{u}, \bar{v})$ with $\Omega(X, hf, \gamma)$. It is enough to show that the endomorphism, x , of X associated with the coupon-track γ of $(\Omega, \bar{u}, \bar{v})$ is equal to hf . By definition,

$$\begin{aligned} x &= (\varphi_0)_X^{-1} \bar{u}_{\lambda^{-1}, \gamma_1} \bar{v}_\gamma = (\varphi_0)_X^{-1} u''_{\lambda^{-1}, \rho_1} v''_\eta v''_\rho = (\varphi_0)_X^{-1} u''_{\lambda^{-1}, \rho_1} v''_\eta v'_\eta \\ &= (\varphi_0)_X^{-1} u''_{\lambda^{-1}, \rho_1} v''_\eta (u_{\lambda^{-1}, \gamma_1})^{-1} (\varphi_0)_X f = (\varphi_0)_X^{-1} u''_{\lambda^{-1}, \zeta^1} v''_\eta (u''_{\lambda^{-1}, \zeta_1})^{-1} (\varphi_0)_X f \end{aligned}$$

where the last equality follows from the formulas $\zeta^1 = \rho_1$ and $u''_{\lambda^{-1}, \zeta_1} = u'_{\lambda^{-1}, \rho_1} = u_{\lambda^{-1}, \gamma_1}$. Using the equality of coupon-tracks $\eta = \lambda^{-1}\zeta$ and the definition of a coloring, we obtain

$$u''_{\lambda^{-1}, \zeta^1} v''_\eta (u''_{\lambda^{-1}, \zeta_1})^{-1} = u''_{\lambda^{-1}, \zeta^1} v''_{\lambda^{-1}\zeta} (u''_{\lambda^{-1}, \zeta_1})^{-1} = \varphi_{g(\lambda)}(v''_\zeta) = \varphi_1(h).$$

Hence $x = (\varphi_0)_X^{-1} \varphi_1(h) (\varphi_0)_X f = hf$. \square

Lemma 11.1 implies that the n -linear form (52) induces an n -linear form

$$(53) \quad \otimes_{r=1}^n L_{g(\mu_r)} \rightarrow \text{End}_{\mathcal{C}}(\mathbb{1}),$$

where $L = L(\mathcal{C})$ is the fusion algebra of \mathcal{C} (see Section 3.4). Given a family of vectors $\omega = (\omega_\alpha \in L_\alpha)_{\alpha \in G}$, we can evaluate (53) on $\otimes_{r=1}^n \omega_{g(\mu_r)}$. This yields an element of $\text{End}_{\mathcal{C}}(\mathbb{1})$ denoted $F(\Gamma, g, \omega, (\gamma(r))_r)$.

We say that ω is *conjugation invariant* if $\varphi_\beta(\omega_\alpha) = \omega_{\beta\alpha\beta^{-1}}$ for all $\alpha, \beta \in G$, where $\varphi: G \rightarrow \text{Aut}(L)$ is defined in Section 3.4.

Lemma 11.2. *If ω is conjugation invariant, then $F(\Gamma, g, \omega, (\gamma(r))_r)$ does not depend on the tracks $(\gamma(r))_r$ and $F(\Gamma, g, \omega) = F(\Gamma, g, \omega, (\gamma(r))_r)$ is an isotopy invariant of the special colored G -graph (Γ, g) .*

Proof. We need to prove that for any $(\beta_r \in \pi_1(C_\Omega))_{r=1, \dots, n}$,

$$(54) \quad F(\Gamma, g, \omega, (\gamma(r))_r) = F(\Gamma, g, \omega, (\beta_r \gamma(r))_r).$$

Pick any objects $(X_r \in \mathcal{C}_{g(\mu_r)})_r$ and their endomorphisms $(f_r)_r$. For all r , set

$$Y_r = \varphi_{g(\beta_r^{-1})}(X_r) \in \mathcal{C}_{g(\beta_r \mu_r \beta_r^{-1})} \quad \text{and} \quad j_r = \varphi_{g(\beta_r^{-1})}(f_r) \in \text{End}_{\mathcal{C}}(Y_r).$$

Consider the colored G -graphs $\Psi = \Omega(X_r, f_r, \gamma(r))$ and $\Psi' = \Omega(Y_r, j_r, \beta_r \gamma(r))$ with the same underlying G -graph Ω . We construct below an isomorphism of colored graphs $\Psi \approx \Psi'$. The existence of such an isomorphism implies that $F(\Psi) = F(\Psi')$. Since this holds for all choices of X_r, f_r , the forms (53) determined by the coupon-tracks $(\gamma(r))_r$ and $(\beta_r \gamma(r))_r$ are obtained from each other via the isomorphism

$$\otimes_{r=1}^n \varphi_{g(\beta_r^{-1})}: \otimes_{r=1}^n L_{g(\mu_r)} \rightarrow \otimes_{r=1}^n L_{g(\beta_r \mu_r \beta_r^{-1})}.$$

By assumption on ω , this isomorphism carries $\otimes_{r=1}^n \omega_{g(\mu_r)}$ into $\otimes_{r=1}^n \omega_{g(\beta_r \mu_r \beta_r^{-1})}$. This implies (54).

Denote the colorings of Ψ and Ψ' by (u, v) and (u', v') respectively. By definition $u_{\gamma_r} = X_r$ and $u'_{\beta_r \gamma_r} = Y_r = \varphi_{g(\beta_r^{-1})}(X_r)$ for all r . The isomorphisms

$$h_{\beta_r \gamma_r} = u_{\beta_r \gamma_r}: u_{\beta_r \gamma_r} \rightarrow \varphi_{g(\beta_r^{-1})}(u_{\gamma_r}) = u'_{\beta_r \gamma_r}$$

with $r = 1, \dots, n$ extend uniquely to an isomorphism of edge-colorings $h: u \rightarrow u'$. That h transforms v into v' follows from the fact that h conjugates $v_{\beta_r \gamma(r)}$ and $v'_{\beta_r \gamma(r)}$ for all r . To verify this fact, fix r and note that it is enough to show that $h_{\beta_r \gamma_r} = u_{\beta_r \gamma_r}$ conjugates the morphisms $f \in \text{End}_{\mathcal{C}}(u_{\beta_r \gamma_r})$ and $f' \in \text{End}_{\mathcal{C}}(u'_{\beta_r \gamma_r}) = \text{End}_{\mathcal{C}}(Y_r)$ associated with $v_{\beta_r \gamma(r)}$ and $v'_{\beta_r \gamma(r)}$, respectively. By the definition of v' , we have $f' = j_r = \varphi_{g(\beta_r^{-1})}(f_r)$. The homomorphism f is computed by

$$(55) \quad f = (\varphi_0)_{u_{\beta_r \gamma_r}}^{-1} u_{\beta_r \lambda_r^{-1} \beta_r^{-1}, \beta_r \gamma_r} v_{\beta_r \gamma(r)}.$$

The naturality of φ_0 yields the commutative diagram

$$(56) \quad \begin{array}{ccc} u_{\beta_r \gamma_r} & \xrightarrow{u_{\beta_r \gamma_r}} & \varphi_{g(\beta_r^{-1})}(u_{\gamma_r}) \\ (\varphi_0)_{u_{\beta_r \gamma_r}} \downarrow & & \downarrow (\varphi_0)_{\varphi_{g(\beta_r^{-1})}(u_{\gamma_r})} \\ \varphi_1(u_{\beta_r \gamma_r}) & \xrightarrow{\varphi_1(u_{\beta_r \gamma_r})} & \varphi_1 \varphi_{g(\beta_r^{-1})}(u_{\gamma_r}). \end{array}$$

Expanding $(\varphi_0)_{u_{\beta_r \gamma_r}}^{-1}$ from this diagram and substituting in (55) we obtain that

$$u_{\beta_r \gamma_r} f = \varphi_2(1, g(\beta_r^{-1}))_{u_{\gamma_r}} \varphi_1(u_{\beta_r \gamma_r}) u_{\beta_r \lambda_r^{-1} \beta_r^{-1}, \beta_r \gamma_r} v_{\beta_r \gamma(r)} = u_{\beta_r \lambda_r^{-1}, \gamma_r} v_{\beta_r \gamma(r)}.$$

Here the first equality holds because the inverse of the right vertical arrow in (56) is $\varphi_2(1, g(\beta_r^{-1}))_{u_{\gamma_r}}$ and the second equality follows from the commutativity of (26).

Consider now the following commutative diagram of isomorphisms:

$$(57) \quad \begin{array}{ccccc} u_{\beta_r \gamma_r} & \xrightarrow{u_{\beta_r, \gamma_r}} & \varphi_{g(\beta_r^{-1})}(u_{\gamma_r}) & \xrightarrow{f' = \varphi_{g(\beta_r^{-1})}(f_r)} & \varphi_{g(\beta_r^{-1})}(u_{\gamma_r}) \\ \downarrow v_{\beta_r, \gamma(r)} & & \downarrow \varphi_{g(\beta_r^{-1})}(v_{\gamma(r)}) & & \downarrow \varphi_{g(\beta_r^{-1})}((\varphi_0)_{u_{\gamma_r}}) \\ u_{\beta_r \gamma_r} & \xrightarrow{u_{\beta_r, \gamma_r}} & \varphi_{g(\beta_r^{-1})}(u_{\gamma_r}) & \xrightarrow{\varphi_{g(\beta_r^{-1})}(u_{\lambda_r^{-1}, \gamma_r})} & \varphi_{g(\beta_r^{-1})} \varphi_1(u_{\gamma_r}). \end{array}$$

Here the left square is the diagram (28) for the r -th coupon of Ω (this coupon has one entry and one exit so that \otimes and φ_2 do not come up.) The right square is commutative by (51). Note that the inverse of the rightmost vertical arrow is equal to $\varphi_2(g(\beta_r^{-1}), 1)_{u_{\gamma_r}}$. The commutativity of the diagram (26) implies that the composition of the isomorphisms in (57), going from the bottom left to the bottom right and then to the top right is equal to $u_{\beta_r \lambda_r^{-1}, \gamma_r}$. Therefore

$$f' u_{\beta_r, \gamma_r} = u_{\beta_r \lambda_r^{-1}, \gamma_r} v_{\beta_r, \gamma(r)} = u_{\beta_r, \gamma_r} f. \quad \square$$

Lemma 11.3. *Assume $\text{End}_{\mathcal{C}}(\mathbb{1}) = \mathbb{k} \text{id}_{\mathbb{1}}$ and ω is conjugation invariant. Then $F(\Gamma, \eta^{-1} g \eta, \omega) = F(\Gamma, g, \omega)$ for all $\eta \in G$.*

Proof. We prove a stronger claim which concerns an arbitrary, not necessarily conjugation invariant family of vectors $\omega = (\omega_{\alpha} \in L_{\alpha})_{\alpha \in G}$. Consider the family $\omega^{\eta} = (\omega_{\alpha}^{\eta} \in L_{\alpha})_{\alpha}$ defined by $\omega_{\alpha}^{\eta} = \varphi_{\eta}(\omega_{\eta \alpha \eta^{-1}})$ for all α . We claim that

$$(58) \quad F(\Gamma, \eta^{-1} g \eta, \omega^{\eta}, (\gamma(r))_r) = F(\Gamma, g, \omega, (\gamma(r))_r)$$

where $(\gamma(r))_r$ are the coupon-tracks as above. If ω is conjugation invariant, then $\omega^{\eta} = \omega$ and the lemma follows.

To prove (58), consider the G -graphs $\Omega = (\Omega_{\Gamma}, g)$ and $\Omega^{\eta} = (\Omega_{\Gamma}, \eta^{-1} g \eta)$. Let γ_r, X_r, f_r be as above. The η -conjugation transforms the colored G -graph $(\Omega, u, v) = \Omega(X_r, f_r, \gamma(r))$ into a colored G -graph $(\Omega^{\eta}, u^{\eta}, v^{\eta})$. The endomorphism of $u_{\gamma_r}^{\eta} = \varphi_{\eta}(u_{\gamma_r}) = \varphi_{\eta}(X_r)$ associated with (u^{η}, v^{η}) is computed from the definitions to be

$$\begin{aligned} & (\varphi_0)_{\varphi_{\eta}(X_r)}^{-1} u_{\lambda_r^{-1}, \gamma_r}^{\eta} \varphi_{\eta}(v_{\gamma(r)}) \\ &= (\varphi_0)_{\varphi_{\eta}(X_r)}^{-1} (\varphi_2(1, \eta)_{X_r})^{-1} \varphi_2(\eta, 1)_{X_r} \varphi_{\eta}(u_{\lambda_r^{-1}, \gamma_r}) \varphi_{\eta}(u_{\lambda_r^{-1}, \gamma_r}^{-1} (\varphi_0)_{X_r} f_r) \\ &= (\varphi_0)_{\varphi_{\eta}(X_r)}^{-1} (\varphi_2(1, \eta)_{X_r})^{-1} \varphi_2(\eta, 1)_{X_r} \varphi_{\eta}((\varphi_0)_{X_r}) \varphi_{\eta}(f_r) = \varphi_{\eta}(f_r). \end{aligned}$$

Therefore $(\Omega^{\eta}, u^{\eta}, v^{\eta}) = \Omega^{\eta}(\varphi_{\eta}(X_r), \varphi_{\eta}(f_r), \gamma(r))$. Since $\text{End}_{\mathcal{C}}(\mathbb{1}) = \mathbb{k} \text{id}_{\mathbb{1}}$, the remark after the statement of Theorem 10.3 implies that

$$F(\Omega^{\eta}(\varphi_{\eta}(X_r), \varphi_{\eta}(f_r), \gamma(r))) = F(\Omega^{\eta}, u^{\eta}, v^{\eta}) = F(\Omega, u, v) = F(\Omega(X_r, f_r, \gamma(r))).$$

Extending by linearity to the fusion algebra, we obtain (58). \square

Lemma 11.4. *If ω is conjugation invariant and $\omega_{\alpha}^* = \omega_{\alpha^{-1}}$ for all $\alpha \in G$, then $F(\Gamma, g, \omega)$ does not depend on the orientation of the circle components of Γ .*

Proof. This lemma follows from a stronger claim which says that $F(\Omega(X_r, f_r, \gamma(r)))$ is preserved when the orientation of ℓ_i is reversed and simultaneously the pair $(X_i, f_i \in \text{End}(X_i))$ is replaced with $(X_i^*, f_i^* \in \text{End}(X_i^*))$ (keeping the rest of the data). This claim is well known in the non-crossed setting. The proof in the crossed setting is left to the reader as an exercise. \square

An example of a family of vectors ω satisfying all requirements of the last three lemmas will be given in the next section.

11.3. Remark. The morphism $(u_{\lambda_r^{-1}, \gamma_r})^{-1}(\varphi_0)_{X_r} : X_r = u_{\gamma_r} \rightarrow u_{\gamma_r}$ appearing in (51) may be rewritten as $(\varphi_0)_{u_{\gamma_r}}^{-1} u_{\lambda_r, \gamma_r}$. Indeed,

$$\begin{aligned} u_{\lambda_r^{-1}, \gamma_r}(\varphi_0)_{u_{\gamma_r}}^{-1} u_{\lambda_r, \gamma_r} &= (\varphi_0)_{\varphi_1(X_r)}^{-1} \varphi_1(u_{\lambda_r^{-1}, \gamma_r}) u_{\lambda_r, \gamma_r} \\ &= (\varphi_0)_{\varphi_1(X_r)}^{-1} (\varphi_2(1, 1)_{\varphi_1(X_r)})^{-1} (\varphi_0)_{X_r} = (\varphi_0)_{X_r}. \end{aligned}$$

These equalities follow respectively from the naturality of φ_0 , the commutativity of the diagram (26), and the commutativity of the left triangle in (16).

12. G -MODULAR CATEGORIES

12.1. Pre-fusion and fusion categories. We call an object U of a \mathbb{k} -additive category \mathcal{C} *simple* if $\text{End}_{\mathcal{C}}(U)$ is a free \mathbb{k} -module of rank 1 (and so has the basis $\{\text{id}_U\}$). It is clear that an object isomorphic to a simple object is itself simple. If \mathcal{C} is pivotal, then the dual of a simple object of \mathcal{C} is simple.

A *split semisimple category (over \mathbb{k})* is a \mathbb{k} -additive category \mathcal{C} such that each object of \mathcal{C} is a finite direct sum of simple objects and $\text{Hom}_{\mathcal{C}}(i, j) = 0$ for any non-isomorphic simple objects i, j of \mathcal{C} .

Clearly, the Hom spaces in such a \mathcal{C} are free \mathbb{k} -modules of finite rank. For $X \in \mathcal{C}$ and a simple object $i \in \mathcal{C}$, the modules $\text{Hom}_{\mathcal{C}}(X, i)$ and $\text{Hom}_{\mathcal{C}}(i, X)$ have same rank denoted N_X^i and called the *multiplicity number*. A set I of simple objects of \mathcal{C} is *representative* if every simple object of \mathcal{C} is isomorphic to a unique element of I .

A *pre-fusion category (over \mathbb{k})* is a split semisimple \mathbb{k} -additive pivotal category \mathcal{C} such that the unit object $\mathbb{1}$ is simple. In such a category, the map $\mathbb{k} \rightarrow \text{End}_{\mathcal{C}}(\mathbb{1}), k \mapsto k \text{id}_{\mathbb{1}}$ is a \mathbb{k} -algebra isomorphism which we use to identify $\text{End}_{\mathcal{C}}(\mathbb{1}) = \mathbb{k}$. The left and right dimensions of any simple object of a pre-fusion category are invertible (see, for example, Lemma 4.1 of [TV1]).

If I is representative set of simple objects of pre-fusion category \mathcal{C} , then for any object X of \mathcal{C} , $N_X^i = 0$ for all but a finite number of $i \in I$, and

$$(59) \quad \dim_l(X) = \sum_{i \in I} \dim_l(i) N_X^i, \quad \dim_r(X) = \sum_{i \in I} \dim_r(i) N_X^i.$$

A *fusion category* is a pre-fusion category such that the set of isomorphism classes of simple objects is finite. The *dimension* $\dim(\mathcal{C})$ of a fusion category \mathcal{C} is

$$\dim(\mathcal{C}) = \sum_{i \in I} \dim_l(i) \dim_r(i) \in \mathbb{k},$$

where I is a (finite) set of simple objects of \mathcal{C} such that every simple object of \mathcal{C} is isomorphic to a unique element of I . The sum on the right-hand side does not depend on the choice of I .

12.2. G -fusion categories. In a pre-fusion G -graded category $\mathcal{C} = \bigoplus_{g \in G} \mathcal{C}_g$, every simple object is isomorphic to a simple object of \mathcal{C}_g for a unique $g \in G$. Moreover, for all $g \in G$, each object of \mathcal{C}_g is a finite direct sum of simple objects of \mathcal{C}_g .

A *G -fusion category* is a pre-fusion G -graded category \mathcal{C} such that the set of isomorphism classes of simple objects of \mathcal{C}_g is finite and non-empty for every $g \in G$. For $G = 1$, we obtain the notion of a fusion category (see Section 12.1). The neutral

component \mathcal{C}_1 of a G -fusion category \mathcal{C} is a fusion category. A G -fusion category is a fusion category if and only if G is finite.

The argument in [Tu2, Section VII.1] shows that if $\mathcal{C} = \bigoplus_{g \in G} \mathcal{C}_g$ is a G -fusion category, then for all $g \in G$,

$$(60) \quad \sum_{i \in I_g} \dim_l(i) \dim_r(i) = \dim(\mathcal{C}_1),$$

where I_g is any representative set of simple objects of \mathcal{C}_g .

The fusion algebra L of a G -fusion category \mathcal{C} (see Section 3.4) is a free \mathbb{k} -module with basis $(\langle i \rangle)_{i \in I}$, where I is an arbitrary representative set of simple objects of \mathcal{C} . For $X \in \mathcal{C}$, the vector $\langle X \rangle \in L$ expands as $\langle X \rangle = \sum_{i \in I} N_X^i \langle i \rangle$.

12.3. G -modular categories. A G -ribbon category \mathcal{C} is *spherical* in the sense that the left and right traces of any endomorphism g in \mathcal{C} coincide. This fact is a consequence of Theorem 8.1, since the graph diagrams representing $\text{tr}_l(g)$ and $\text{tr}_r(g)$ (see Section 2.6) are related by Reidemeister moves of type 1 and 2. Then $\text{tr}_l(g) = \text{tr}_r(g)$ is denoted $\text{tr}(g)$ and called the *trace* of g . Consequently, the left and right dimensions of an object X of \mathcal{C} coincide. Then $\dim_l(X) = \dim_r(X)$ is denoted $\dim(X)$ and called the *dimension* of X .

The neutral component \mathcal{C}_1 of a G -ribbon G -fusion category \mathcal{C} is a ribbon fusion category. Let I_1 be a (finite) representative set of simple objects of \mathcal{C}_1 . For $i, j \in I_1$, set

$$S_{i,j} = \text{tr}(c_{j,i} \circ c_{i,j} : i \otimes j \rightarrow i \otimes j) \in \text{End}_{\mathcal{C}}(\mathbb{1}) = \mathbb{k}$$

where $c_{i,j} : i \otimes j \rightarrow j \otimes i$ is the braiding in \mathcal{C}_1 (see Section 4.4). The matrix $S = [S_{i,j}]_{i,j \in I_1}$ does not depend on the choice of I_1 and is called the *S-matrix* of \mathcal{C} .

A *G -modular category* is a G -ribbon G -fusion category whose S -matrix is invertible (over \mathbb{k}). In other words, a G -modular category is a G -ribbon G -fusion category whose neutral component is modular in the sense of [Tu1].

Let \mathcal{C} be a G -modular category. Consider the fusion algebra $L = \bigoplus_{\alpha \in G} L_{\alpha}$ of \mathcal{C} (see Section 3.4). For $\alpha \in G$, set

$$\omega_{\mathcal{C}}^{\alpha} = \sum_{i \in I_{\alpha}} \dim(i) \langle i \rangle \in L_{\alpha},$$

where I_{α} is a representative set of simple objects of \mathcal{C}_{α} . The vector $\omega_{\mathcal{C}}^{\alpha}$ does not depend on the choice of I_{α} . Since the action of any $\beta \in G$ on \mathcal{C} transforms simple objects in \mathcal{C}_{α} into simple objects in $\mathcal{C}_{\beta\alpha\beta^{-1}}$ and preserves their dimension, the family $\omega_{\mathcal{C}} = (\omega_{\mathcal{C}}^{\alpha})_{\alpha}$ is conjugation invariant. By Lemma 11.2, $\omega_{\mathcal{C}}$ determines an isotopy invariant $F(\ell, \omega_{\mathcal{C}}) \in \mathbb{k}$ of special G -links ℓ .

We shall need several elements of \mathbb{k} associated with a G -modular category \mathcal{C} . Since each $i \in I_1$ is a simple object, the twist $v_i : i \rightarrow i$ in \mathcal{C}_1 (see Section 4.4) is equal to $v_i = \nu_i \text{id}_i$ for some $\nu_i \in \mathbb{k}$. Since v_i is an isomorphism, $\nu_i \in \mathbb{k}^*$. Set

$$\Delta_{\pm} = \sum_{i \in I_1} \nu_i^{\pm 1} (\dim(i))^2 \in \mathbb{k}.$$

Formulas (43) and (44) imply that $\Delta_{\pm} = F(\ell^{\pm}, \omega_{\mathcal{C}})$ where $\ell^{\pm} \subset S^3$ is a trivial G -knot with framing ± 1 , see Section 11.2. The properties of modular categories imply that $\Delta_{\pm} \in \mathbb{k}^*$ and $\Delta_+ \Delta_- = \dim(\mathcal{C}_1)$, see [Tu1, Formula II.2.4.a.]. In particular, $\dim(\mathcal{C}_1)$ is invertible in \mathbb{k} . A *rank* of \mathcal{C} is a square root $\mathcal{D} \in \mathbb{k}^*$ of $\dim(\mathcal{C}_1)$.

13. THE SURGERY HQFT

13.1. An invariant of G -manifolds. By a *closed connected G -manifold* we mean a closed connected oriented 3-dimensional manifold whose fundamental group is endowed with a conjugacy class of homomorphisms to G . A *closed G -manifold* is a disjoint union of a finite number of closed connected G -manifolds. A *homeomorphism* of closed G -manifolds is an orientation preserving homeomorphism whose action in π_1 commutes with the maps to G (up to conjugation).

We derive from a G -modular category \mathcal{C} with rank \mathcal{D} a multiplicative \mathbb{k} -valued homeomorphism invariant $\tau_{\mathcal{C}}$ of closed G -manifolds. The multiplicativity of $\tau_{\mathcal{C}}$ means that $\tau_{\mathcal{C}}(M \amalg N) = \tau_{\mathcal{C}}(M) \tau_{\mathcal{C}}(N)$ for all closed G -manifolds M, N .

It suffices to define $\tau_{\mathcal{C}}$ for closed connected G -manifolds. Present such a manifold M as the result of surgery on $S^3 = \mathbb{R}^3 \cup \{\infty\}$ along a framed link $\ell \subset \mathbb{R}^2 \times (0, 1)$ with $\#\ell$ components. Thus, M is obtained by gluing $\#\ell$ solid tori to the exterior E_{ℓ} of ℓ in S^3 . Pick a base point $z \in E_{\ell} \setminus \{\infty\}$ with big second coordinate. Composing the inclusion map $\pi_1(E_{\ell}, z) \rightarrow \pi_1(M, z)$ with a homomorphism $\pi_1(M, z) \rightarrow G$ in the given conjugacy class, we obtain a homomorphism $g: \pi_1(C_{\ell}, z) = \pi_1(E_{\ell}, z) \rightarrow G$. We orient ℓ in an arbitrary way. It is clear that the G -link (ℓ, g) is special in the sense of Section 11.2. Recall the elements $\Delta_+, \Delta_- \in \mathbb{k}$ from Section 12.3. Set

$$\tau_{\mathcal{C}}(M) = \Delta_-^{\sigma(\ell)} \mathcal{D}^{-\sigma(\ell) - \#\ell - 1} F(\ell, g, \omega_{\mathcal{C}}) \in \mathbb{k}$$

where $\sigma(\ell)$ is the signature of the compact oriented 4-manifold B_{ℓ} bounded by M and obtained from the 4-ball B^4 by attaching 2-handles along tubular neighborhoods of the components of ℓ in $S^3 = \partial B^4$. Here B_{ℓ} is oriented so that $\partial B_{\ell} = M$ in the category of oriented manifolds.

Theorem 13.1. $\tau_{\mathcal{C}}(M)$ is a homeomorphism invariant of the G -manifold M .

Proof. We should prove that $\tau_{\mathcal{C}}(M)$ does not depend on the choices made in its definition. First of all, the homomorphism g is well defined only up to conjugation. Lemma 11.1 implies that $F(\ell, g, \omega_{\mathcal{C}})$ is preserved under conjugation of g so that $\tau_{\mathcal{C}}(M)$ does not depend on the choice of g in its conjugacy class. Since the duality $V \mapsto V^*$ preserves the dimension and transforms simple objects in \mathcal{C}_{α} into simple objects in $\mathcal{C}_{\alpha^{-1}}$, we have $(\omega_{\mathcal{C}}^{\alpha})^* = \omega_{\mathcal{C}}^{\alpha^{-1}}$ for all $\alpha \in G$. Lemma 11.4 implies that $F(\ell, g, \omega_{\mathcal{C}})$ is independent of the choice of orientation of ℓ and so is $\tau_{\mathcal{C}}(M)$.

To prove the independence of the choice of ℓ we use Kirby's theory of moves on links. By [Ki], any two framed links in S^3 yielding via surgery homeomorphic 3-manifolds can be related by certain transformations called Kirby moves. There are moves of two kinds. The first move adds to a framed link $\ell \subset S^3$ a distant unknot ℓ^{\pm} with framing ± 1 ; under this move the 4-manifold B_{ℓ} is transformed into $B_{\ell} \# \mathbb{C}P^2$. The second move preserves B_{ℓ} and is induced by a sliding of a 2-handle of B_{ℓ} across another 2-handle. We need a more precise version of this theory. Denote the result of surgery on a framed link $\ell \subset S^3$ by M_{ℓ} . A *surgery presentation* of a closed connected oriented 3-manifold M is a pair (a framed link $\ell \subset S^3$, an isotopy class of orientation preserving homeomorphisms $f: M \rightarrow M_{\ell}$). Note that any framing preserving isotopy of ℓ onto itself induces a homeomorphism $j_0: M_{\ell} \rightarrow M_{\ell}$. For any $f: M \rightarrow M_{\ell}$ as above, the pair $(\ell, j_0 f)$ is a surgery presentation of M ; we say that it is obtained from (ℓ, f) by isotopy. The first Kirby move $\ell \mapsto \ell' = \ell \amalg \ell^{\pm}$ induces a homeomorphism $j_1: M_{\ell} \rightarrow M_{\ell'}$ which is the identity outside a small 3-ball containing ℓ^{\pm} . The second Kirby move $\ell \mapsto \ell'$ induces a homeomorphism

$B_\ell \rightarrow B_{\ell'}$ which restricts to a homeomorphism of boundaries $j_2: M_\ell \rightarrow M_{\ell'}$. In both cases we say that the surgery presentation $(\ell', j_k f: M \rightarrow M_{\ell'})$ (where $k = 1, 2$) is obtained from $(\ell, f: M \rightarrow M_\ell)$ by the k -th Kirby move. The arguments in [Ki], Section 2 show that for any surgery presentations $(\ell_1, f_1: M_1 \rightarrow M_{\ell_1})$ and $(\ell_2, f_2: M_2 \rightarrow M_{\ell_2})$ of closed connected oriented 3-manifolds M_1, M_2 and for any isotopy class of orientation preserving homeomorphisms $f: M_1 \rightarrow M_2$ there is a sequence of Kirby moves and isotopies transforming (ℓ_1, f_1) into $(\ell_2, f_2 f)$.

The 3-manifold M_ℓ obtained by surgery on a special G -link $(\ell \subset S^3, g: \pi_1(C_\ell) \rightarrow G)$ is a G -manifold in the obvious way. (Warning: by definition, G -links are oriented but their orientations play no role in the surgery construction.) A Kirby move on a special G -link (ℓ, g) yields a special G -link $(\ell' \subset S^3, g': \pi_1(C_{\ell'}) \rightarrow G)$ where g' is the composition of the inclusion homomorphism $\pi_1(C_{\ell'}) \rightarrow \pi_1(M_{\ell'})$, the isomorphism $\pi_1(M_{\ell'}) = \pi_1(M_\ell)$ induced by the homeomorphism $j: M_\ell \rightarrow M_{\ell'}$ as above and the homomorphism $\pi_1(M_\ell) \rightarrow G$ induced by g . The results of the previous paragraph imply that if surgeries on two special G -links in S^3 yield homeomorphic G -manifolds, then these G -links can be related by a finite sequence of Kirby moves, isotopies, and orientation reversions on link components.

It is clear that $\tau_{\mathcal{C}}(M_\ell)$ is invariant under isotopies on ℓ . To prove the theorem it is enough to show that $\tau_{\mathcal{C}}(M_\ell)$ is invariant under the Kirby moves on ℓ . Under the first Kirby move $\ell \mapsto \ell' = \ell \amalg \ell^\pm$ the meridian of ℓ^\pm is contractible in $M_{\ell'}$ and the G -link ℓ' is a disjoint union of ℓ and the G -unknot ℓ^\pm with framing ± 1 . Therefore

$$F(\ell', \omega_{\mathcal{C}}) = F(\ell^\pm, \omega_{\mathcal{C}}) F(\ell, \omega_{\mathcal{C}}) = \Delta_\pm F(\ell, \omega_{\mathcal{C}}).$$

This formula and the equalities $\#\ell' = \#\ell + 1$, $\sigma(\ell') = \sigma(\ell) \pm 1$, $\Delta_+ \Delta_- = \mathcal{D}^2$ imply that $\tau_{\mathcal{C}}(M_\ell) = \tau_{\mathcal{C}}(M_{\ell'})$.

We consider the second Kirby moves in the restricted form studied by Fenn and Rourke [FR]. The Kirby-Fenn-Rourke moves split into positive and negative ones. It is explained in [RT2] that (modulo the first Kirby moves) it is enough to consider only the negative Kirby-Fenn-Rourke moves. Such a move $\ell \mapsto \ell'$ replaces a piece Γ of ℓ lying in a closed 3-ball B^3 by another piece Γ' lying in B^3 and having the same endpoints. Here $\Gamma = B^3 \cap \ell$ is a system of $k \geq 1$ parallel strings with parallel framings and $\Gamma' = \Gamma^- \cup t$, where Γ^- is obtained from Γ by applying a full left-hand twist and t is an unknot encircling Γ and having the framing -1 . (This move $\ell \mapsto \ell'$ can be expanded as a composition of k Kirby moves of type 2 and a single Kirby move of type 1.) Note that $\#\ell' = \#\ell + 1$ and $\sigma(\ell') = \sigma(\ell) - 1$. We must prove that $F(\ell', \omega_{\mathcal{C}}) = \Delta_- F(\ell, \omega_{\mathcal{C}})$. This will follow from a ‘‘local’’ equality which we now formulate.

Let Γ be a trivial braid on k strings in $\mathbb{R}^2 \times [0, 1]$ with constant framing. Let $\Gamma' = \Gamma^- \cup t \subset \mathbb{R}^2 \times [0, 1]$ be the framed tangle obtained from Γ as above. Fix an arbitrary orientation of Γ' and the induced orientation of Γ . Let us transform Γ' into a ribbon graph $\Omega = \Gamma^- \cup \Omega_t$ by inserting a coupon in t as in Figure 11. Clearly, $C_\Gamma = (\mathbb{R}^2 \times [0, 1]) - \Gamma$ is obtained from $C_{\Gamma^-} = (\mathbb{R}^2 \times [0, 1]) - \Gamma^-$ by surgery on $t \subset C_{\Gamma^-}$. This yields inclusions $C_\Omega \subset C_{\Gamma'} = C_{\Gamma^-} \setminus t \subset C_\Gamma$. (The reader uncomfortable with open manifolds may replace the compliments by exteriors throughout the argument.) These inclusions induce a bijection $g \leftrightarrow g'$ between homomorphisms $g: \pi_1(C_\Gamma) \rightarrow G$ and homomorphisms $g': \pi_1(C_\Omega) = \pi_1(C_{\Gamma'}) \rightarrow G$ carrying the homotopy class of the (-1) -longitude of t to $1 \in G$. Any coloring u of the G -graph (Γ, g) induces a coloring u' of the G -graph (Ω, g') such that

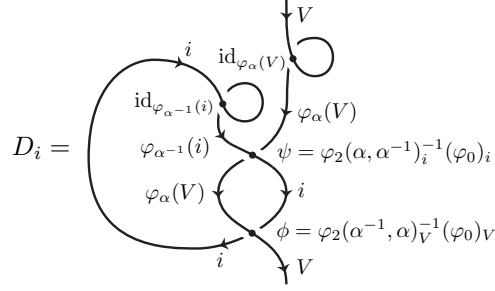

FIGURE 13.

- (a) the values of u' on the edge-tracks of $\Gamma^- \subset \Omega$ are equal to the values of u on the corresponding edge-tracks of Γ (and the same for the isomorphisms associated with pairs (a track of Γ^- , an element of $\pi_1(\mathcal{C}_\Omega)$);
- (b) Ω_t is colored as in Section 11.2 using the canonical color $\omega = \omega_{\mathcal{C}}$.

Clearly, the colored G -graphs Γ and Ω have the same source and the same target. The properties of the functor $F : \mathcal{G}_{\mathcal{C}} \rightarrow \mathcal{C}$ imply that to prove the equality $F(\ell', \omega_{\mathcal{C}}) = \Delta_- F(\ell, \omega_{\mathcal{C}})$, it is enough to show that for any orientation of Γ' and any g, u as above,

$$(61) \quad F(\Omega, g', u') = \Delta_- F(\Gamma, g, u).$$

Let us prove this formula. Let $(U_1, \varepsilon_1), \dots, (U_k, \varepsilon_k)$ be the source of Γ . Using the standard technique of coupons colored with identity morphisms, we can reduce the proof of (61) to the case where Γ is a single string oriented from top to bottom and colored with $\otimes_{r=1}^k U_r^{\varepsilon_r} \in \mathcal{C}$. Similarly, using a decomposition of this object as a direct sum of simple objects, we can further reduce ourselves to the case where the input and the output of Γ is a 1-term sequence $(V, +)$ where V is a simple object of \mathcal{C} . Suppose that $V \in \mathcal{C}_\alpha$ where $\alpha \in G$. By the argument above in this proof, $F(\Gamma', g', u')$ does not change if we invert the orientation of t . Therefore we can assume that t is oriented so that its linking number with the string Γ is equal to $+1$. Clearly, $F(\Gamma, g, u) = \text{id}_V$. Since V is simple,

$$F(\Omega, g', u') = (\dim(V))^{-1} \text{tr}(F(\Omega, g', u')) \text{id}_V.$$

To establish (61), we need only to prove that $\text{tr}(F(\Omega, g', u')) = \dim(V) \Delta_-$. By construction,

$$(62) \quad F(\Omega, g', u') = \sum_{i \in I_{\alpha^{-1}}} \dim(i) \mathcal{F}(D_i),$$

where $D_i \in \mathcal{D}_{\mathcal{C}}$ is the \mathcal{C} -colored diagram of Figure 13 and $I_{\alpha^{-1}}$ is a representative set of simple objects of $\mathcal{C}_{\alpha^{-1}}$. Let $i \in I_{\alpha^{-1}}$. From Lemmas 7.1 and 8.2, we obtain $\text{tr}(\mathcal{F}(D_i)) = \text{tr}(T_{i,V})$ with

$$T_{i,V} = (\theta_i^{-1} \otimes \theta_V^{-1}) \tau_{\varphi_{\alpha^{-1}}(i), \varphi_\alpha(V)}^{-1} (\text{id}_{\varphi_\alpha(V)} \otimes \psi) \tau_{\varphi_\alpha(V), i}^{-1} (\text{id}_i \otimes \phi).$$

Using the naturality of τ , Lemma 4.3, and (14), we obtain

$$\begin{aligned} T_{i,V} &= (\theta_i^{-1} \otimes \theta_V^{-1}) \tau_{\varphi_{\alpha^{-1}}(i), \varphi_\alpha(V)}^{-1} \tau_{\varphi_\alpha(V), \varphi_\alpha \varphi_{\alpha^{-1}}(i)}^{-1} (\psi \otimes \phi) \\ &= \theta_{i \otimes V}^{-1} (\varphi_1)_2(i, V) ((\varphi_0)_i \otimes (\varphi_0)_V) = \theta_{i \otimes V}^{-1} (\varphi_0)_{i \otimes V} = v_{i \otimes V}^{-1}, \end{aligned}$$

where $\{v_X = (\varphi_0)_X^{-1}\theta_X: X \rightarrow X\}_{X \in \mathcal{C}_1}$ is the (standard) twist of \mathcal{C}_1 (see Section 4.4). Recall that for any simple object X of \mathcal{C}_1 , $v_X = \nu_X \text{id}_X$ for some $\nu_X \in \mathbb{k}^*$. Let I_1 be a representative set of simple objects of \mathcal{C}_1 . Since $i \otimes V \in \mathcal{C}_1$ splits as a (finite) direct sum of objects of I_1 , there exists a finite family of morphisms $(p_a: i \otimes V \rightarrow i_a, q_a: i_a \rightarrow i \otimes V)_{a \in A}$ such that

$$\text{id}_{i \otimes V} = \sum_{a \in A} q_a p_a \quad \text{and} \quad p_a q_b = \delta_{a,b} \text{id}_{i_a} \quad \text{for all } a, b \in A.$$

Then

$$\begin{aligned} \text{tr}(\mathcal{F}(D_i)) &= \text{tr}(v_{i \otimes V}^{-1}) = \text{tr}(v_{i \otimes V}^{-1} \text{id}_{i \otimes V}) = \sum_{a \in A} \text{tr}(v_{i \otimes V}^{-1} p_a q_a) \\ &= \sum_{a \in A} \text{tr}(p_a v_{i_a}^{-1} q_a) = \sum_{a \in A} \nu_{i_a}^{-1} \text{tr}(p_a q_a) = \sum_{a \in A} \nu_{i_a}^{-1} \dim(i_a) \\ &= \sum_{k \in I_1} \sum_{\substack{a \in A \\ i_a = k}} \nu_k^{-1} \dim(k) = \sum_{k \in I_1} N_{i \otimes V}^k \nu_k^{-1} \dim(k). \end{aligned}$$

Finally, using (62) and (59), we obtain

$$\begin{aligned} \text{tr}(F(\Omega, g', u')) &= \sum_{i \in I_{\alpha^{-1}}} \sum_{k \in I_1} \dim(i) N_{i \otimes V}^k \nu_k^{-1} \dim(k) \\ &= \sum_{k \in I_1} \sum_{i \in I_{\alpha^{-1}}} \dim(i^*) N_{V \otimes k^*}^{i^*} \nu_k^{-1} \dim(k) = \sum_{k \in I_1} \left(\sum_{j \in I_{\alpha}} \dim(j) N_{V \otimes k^*}^j \right) \nu_k^{-1} \dim(k) \\ &= \sum_{k \in I_1} \dim(V \otimes k^*) \nu_k^{-1} \dim(k) = \sum_{k \in I_1} \dim(V) \nu_k^{-1} (\dim(k))^2 = \dim(V) \Delta_-. \end{aligned}$$

This concludes the proof of Theorem 13.1. \square

13.2. Remarks. 1. The 3-sphere S^3 has a unique structure of a closed G -manifold. It can be obtained by the surgery on S^3 along an empty link. Hence, $\tau_{\mathcal{C}}(S^3) = \mathcal{D}^{-1}$.

2. We have $\tau_{\mathcal{C}}(S^1 \times S^2, f) = 1$ for any homomorphism $f: \pi_1(S^1 \times S^2) \approx \mathbb{Z} \rightarrow G$. Indeed, the closed G -manifold $(S^1 \times S^2, f)$ can be obtained by the surgery on S^3 along an unknot ℓ with framing 0 and with homomorphism $g: \pi_1(C_\ell) \rightarrow G$ carrying a meridian of ℓ to a certain $\alpha \in G$. Then $\sigma(\ell) = 0$ and by (60),

$$\tau_{\mathcal{C}}(S^1 \times S^2, f) = \mathcal{D}^{-2} F(\ell, g, \omega_{\mathcal{C}}) = \mathcal{D}^{-2} \sum_{i \in I_{\alpha}} (\dim(i))^2 = \mathcal{D}^{-2} \dim(\mathcal{C}_1) = 1.$$

3. The definition of $\tau_{\mathcal{C}}(M)$ can be rewritten in a more symmetric form:

$$\tau_{\mathcal{C}}(M) = \mathcal{D}^{-b_1(M)-1} \Delta_-^{-\sigma_-} \Delta_+^{-\sigma_+} F(\ell, g, \omega_{\mathcal{C}})$$

where $b_1(M) = \#\ell - \sigma_+ - \sigma_-$ is the first Betti number of M and σ_+ (resp. σ_-) is the number of positive (resp. negative) squares in the diagonal decomposition of the intersection form $H_2(B_\ell) \times H_2(B_\ell) \rightarrow \mathbb{Z}$. The invariant

$$\mathcal{D}^{b_1(M)+1} \tau_{\mathcal{C}}(M) = \Delta_-^{-\sigma_-} \Delta_+^{-\sigma_+} F(\ell, g, \omega_{\mathcal{C}})$$

does not depend on the choice of \mathcal{D} .

4. The invariant $\tau_{\mathcal{C}}(M)$ can be defined without the invertibility assumption on the S -matrix of \mathcal{C} . It suffices to require the weaker condition $\Delta_+, \Delta_- \in \mathbb{k}^*$. The invertibility of the S -matrix is needed in order to extend $\tau_{\mathcal{C}}$ to an HQFT in the next subsection.

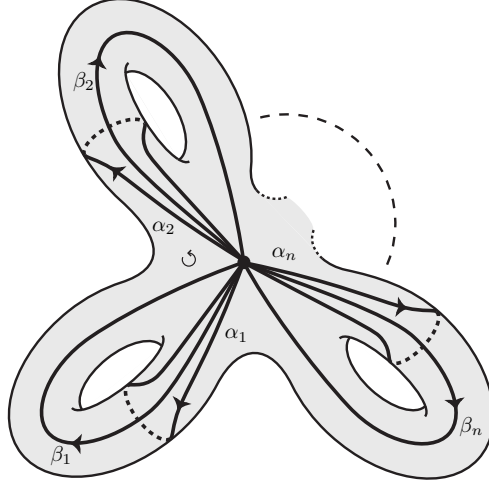

FIGURE 14.

13.3. The HQFT. Consider again a G -modular category \mathcal{C} with rank \mathcal{D} . The invariant $\tau_{\mathcal{C}}$ of closed G -manifolds extends to a 3-dimensional HQFT with target an Eilenberg-MacLane space $K(G, 1)$, i.e., to a symmetric monoidal projective functor from the category of G -surfaces and 3-dimensional G -cobordisms Cob^G to $\text{vect}_{\mathbb{k}}$. For precise definitions of G -surfaces, G -cobordisms, and HQFTs, we refer to [TV2]. The resulting projective functor $\text{Cob}^G \rightarrow \text{vect}_{\mathbb{k}}$ is still denoted by $\tau_{\mathcal{C}}$. The construction of $\tau_{\mathcal{C}}$ is given in [Tu2, Chapter VII] when \mathcal{C} belongs to the class of strict G -modular categories considered there; the same method applies to G -modular categories in the sense of this paper. The projectivity of $\tau_{\mathcal{C}}$ may be described more precisely: the homomorphism associated with any G -cobordism obtained by gluing two G -cobordisms is equal to the composition of the corresponding homomorphisms times an integer power of $\Delta_+ \Delta_-^{-1} \in \mathbb{k}^*$. If $\Delta_+ = \Delta_-$, then $\tau_{\mathcal{C}}$ is a functor. If $\Delta_+ \neq \Delta_-$, then the multiplicative ambiguity of $\tau_{\mathcal{C}}$ may be resolved by enriching G -surfaces (and in particular the bases of G -cobordisms) with Lagrangian subspaces in real 1-dimensional homology. The projective functor $\tau_{\mathcal{C}}$ lifts to a symmetric monoidal functor from the category of such enriched G -cobordisms to $\text{vect}_{\mathbb{k}}$, cf. [Tu2, Chapter VII].

For completeness, we give an explicit expression for (the isomorphism type of) the \mathbb{k} -module $\tau_{\mathcal{C}}(\Sigma) \in \text{vect}_{\mathbb{k}}$ associated with a (closed connected) G -surface Σ of genus $n \geq 0$. Such a surface carries a base point, \bullet , and a homomorphism $\pi_1(\Sigma, \bullet) \rightarrow G$. If $n = 0$, then $\tau_{\mathcal{C}}(\Sigma) \simeq \mathbb{k}$. If $n \geq 1$, then a skeleton of Σ is formed by $2n$ loops beginning and ending at \bullet as in Figure 14. Let $\alpha_1, \beta_1, \dots, \alpha_n, \beta_n \in G$ be the evaluations of the given homomorphism $\pi_1(\Sigma, a) \rightarrow G$ on these loops, as indicated in the figure. Note that $\prod_{i=1}^n \alpha_i^{-1} \beta_i^{-1} \alpha_i \beta_i = 1$. Given a representative set $\Pi_{\alpha \in G} \mathcal{I}_{\alpha}$ of simple objects of \mathcal{C} , we have

$$(63) \quad \tau_{\mathcal{C}}(\Sigma) \simeq \bigoplus_{J_1 \in \mathcal{I}_{\beta_1}, \dots, J_n \in \mathcal{I}_{\beta_n}} \text{Hom}_{\mathcal{C}}(\mathbb{1}_{\mathcal{C}}, \varphi_{\alpha_1}(J_1^*) \otimes J_1 \otimes \dots \otimes \varphi_{\alpha_n}(J_n^*) \otimes J_n).$$

This formula directly follows from the definition of $\tau_{\mathcal{C}}(\Sigma)$ and allows one to compute $\text{rank}_{\mathbb{k}} \tau_{\mathcal{C}}(\Sigma)$ via a version of the standard Verlinde formula, cf. [Tu2].

REFERENCES

- [Ba1] Balsam, B., *Turaev-Viro invariants as an extended TQFT II*, arXiv:1010.1222.
- [Ba2] Balsam, B., *Turaev-Viro invariants as an extended TQFT III*, arXiv:1012.0560.
- [Ca] Carlip, S., *Quantum gravity in 2 + 1 dimensions*. Cambridge Monographs on Math. Physics. Cambridge Univ. Press, Cambridge, 1998.
- [BK] Balsam, B., Kirillov, A., *Turaev-Viro invariants as an extended TQFT*, arXiv:1004.1533.
- [FR] Fenn, R., Rourke, C., *On Kirby's calculus of links*, *Topology* 18 (1979), 1–15.
- [KR] Kashaev, R., Reshetikhin, N., *Invariants of tangles with flat connections in their complements*. Graphs and patterns in mathematics and theoretical physics, 151–172, *Proc. Sympos. Pure Math.*, 73, Amer. Math. Soc., Providence, RI, 2005.
- [Ki] Kirby, R., *A calculus of framed links in S^3* , *Invent. Math.* 45 (1978), 35–56.
- [Mac] MacLane, S., *Categories for the working mathematician*, second ed., Springer-Verlag, New York, 1998.
- [Mal] Maltsiniotis, G. *Traces dans les catégories monoïdales, dualité et catégories monoïdales fibrées [Traces in monoidal categories, duality and fibered monoidal categories]*, *Cahiers Topologie Géom. Différentielle Catég.* 36 (1995), 195–288.
- [Po] Polyak, M., *Minimal generating sets of Reidemeister moves*, *Quantum Topology* 1 (2010), 399–411.
- [RT1] Reshetikhin, N., Turaev, V., *Ribbon graphs and their invariants derived from quantum groups*. *Comm. Math. Phys.* 127 (1990), no. 1, 1–26.
- [RT2] Reshetikhin, N., Turaev, V., *Invariants of 3-manifolds via link polynomials and quantum groups*, *Invent. Math.* 103 (1991), 547–598.
- [Sh] Shum, M. C. *Tortile tensor categories*, *J. Pure Appl. Algebra* 93 (1994), 57–110.
- [Tu1] Turaev, V., *Quantum invariants of knots and 3-manifolds*, de Gruyter Studies in Mathematics, 18. Walter de Gruyter, Berlin, 1994.
- [Tu2] Turaev, V., *Homotopy Quantum Field Theory*, EMS Tracts in Math. 10, European Math. Soc. Publ. House, Zürich 2010. Based on the preprints arXiv:math/9910010 and arXiv:math/0005291.
- [TV1] Turaev, V., Virelizier, A., *On two approaches to 3-dimensional TQFTs*, arXiv:1006.3501.
- [TV2] Turaev, V., Virelizier, A., *On 3-dimensional Homotopy Quantum Field Theory, I*, *Internat. J. Math.* 23 (2012) 1250094–28.
- [TV3] Turaev, V., Virelizier, A., *On the graded center of graded categories*, arXiv:1208.5696.
- [Wa] Wang, Z., *Topological quantum computation*. CBMS Regional Conf. Series in Math., 112. American Math. Society, Providence, RI, 2010.

VLADIMIR TURAEV
DEPARTMENT OF MATHEMATICS,
INDIANA UNIVERSITY
BLOOMINGTON IN47405
USA
E-MAIL: VTOURAEV@INDIANA.EDU

ALEXIS VIRELIZIER
DEPARTMENT OF MATHEMATICS,
UNIVERSITY LILLE 1
59655 VILLENEUVE D'ASCQ
FRANCE
E-MAIL: ALEXIS.VIRELIZIER@MATH.UNIV-LILLE1.FR