

# RIEMANN SURFACES OUT OF PAPER

ANDRÉ DE CARVALHO AND TOBY HALL

ABSTRACT. Let  $S$  be a surface obtained from a plane polygon by identifying infinitely many pairs of segments along its boundary. A condition is given under which the complex structure in the interior of the polygon extends uniquely across the quotient of its boundary to make  $S$  into a closed Riemann surface. When this condition holds, a modulus of continuity is obtained for a uniformizing map on  $S$ .

## 1. INTRODUCTION

In the usual approach to their topological classification, surfaces are constructed by making side identifications on plane polygons. Such constructions produce surfaces with more than just a topological structure. First, they are naturally metric spaces, with metrics that are Riemannian and flat away from finitely many points: at the exceptional points the metric fails to be Riemannian because there is too much or too little angle. Thus, for example, when a genus two surface is constructed from a regular octagon, all of the vertices of the polygon are identified and the corresponding point on the surface is a *cone* point with angle  $6\pi$ . Second, considering this argument from the conformal rather than the metric standpoint, the surfaces constructed in this way have a natural conformal structure: at flat points this comes from the Euclidean structure, while at cone points an appropriate fractional power can be used to introduce local coordinates.

This idea can be generalized by constructing surfaces from plane polygons with *infinitely* many pairs of segments along the boundary identified. It is natural to ask whether the above discussion carries through to yield a conformal structure on the quotient. The fact that infinitely many segment pairs are identified allows the possibility of *singular points* (such as accumulations of cone points) in the quotient across which it is no longer evident that the conformal structure extends. In addition, the set of singular points may itself have some topological complexity – for instance, it may be a Cantor set. These questions are not only of interest in their own right in the theory of Riemann surfaces, but have important applications in dynamical systems theory, which was the original motivation for this research. As explained below, surfaces constructed in this manner play an important role in the study of the dynamics of surface automorphisms, and the above questions are crucial for the construction of limits in families of such automorphisms.

The first main theorem of the paper provides a sufficient condition for the conformal structure to extend across the singular set, making the quotient into a closed Riemann surface. This condition is that a certain integral diverges at every point of the singular set. The second main theorem uses the rate of divergence of the integral to obtain a modulus of continuity for suitably normalized uniformizing maps on the Riemann surfaces.

To be more precise, let  $P$  be a finite collection of disjoint polygons in the complex plane. A *paper-folding scheme* is an equivalence relation which glues together segments, possibly infinitely many, along the boundary of  $P$ : the union of the segments is required to have full measure. The

image of  $\partial P$  in the quotient space  $S$  is called the *scar*: it may contain *cone points*, where the total angle is not equal to  $2\pi$ , and *singular points*, such as accumulations of cone points. Necessary and sufficient conditions can be given for the quotient space to be a surface, and the following statements summarize the main theorems of this paper in the surface case.

**Conformal Structure Theorem (Theorem 19)** *The natural conformal structure on the conic-flat part of  $S$  extends uniquely to all of  $S$  provided that a certain integral diverges at each point of the singular set.*

It should be emphasized that this theorem only provides a sufficient condition for the extension of the conformal structure across the singular set. The authors do not know any specific examples of surfaces formed in this way (with the singular set having zero push-forward measure) for which the natural conformal structure does not extend.

If the conditions of Theorem 19 are satisfied, then  $S$  has the structure of a closed Riemann surface. In the case where the paper-folding scheme is *plain*,  $S$  is topologically a sphere, and an explicit modulus of continuity of a suitably normalized uniformizing map from  $S$  to the Riemann sphere is found. The modulus of continuity is obtained by patching together local moduli of continuity about each point of the surface – these local moduli carry over to Riemann paper surfaces other than spheres, and could be used to construct global moduli in these cases also.

**Modulus of continuity of uniformizing map (Theorem 54)** *Suitably normalized uniformizing maps on Riemann paper spheres have moduli of continuity which depend only on the geometry of the polygons  $P$  and the metric on the scar.*

These results generalize and complete those set forth in [5], where only finite singular sets were considered. There the topological and metric structures on the quotients of paper foldings were studied and theorems were proved which guarantee that, under appropriate conditions, the quotient space is indeed a closed surface. In [5] the singular points, being isolated, could be considered independently; the extension of the conformal structure and the local modulus of continuity at a singular point were obtained from an analysis of the geometry of a system of nested annuli zooming down to the point in question. This approach is no longer viable in the case of general singular sets, and is replaced in this paper with the construction and analysis of more complicated systems of annuli: the main tool used is a criterion of McMullen [8] for a set to have absolute area zero (Theorem 7 below).

Thurston's pseudo-Anosov maps [10] provide a natural class of examples of surface automorphisms which are defined on (finite) paper surfaces: since every pseudo-Anosov admits a Markov partition, its surface of definition can be constructed from the disjoint union of Markov rectangles by identifying segments along their boundaries. The results of this paper give a means to construct limits of sequences of pseudo-Anosovs defined on the same underlying topological surface, but with puncture sets of varying cardinality.

In one case which motivated this work, the pseudo-Anosovs are the canonical Thurston representatives of the isotopy classes of Smale's horseshoe map [9] of the sphere relative to certain periodic orbits. Provided that the conditions of Theorem 54 apply uniformly along the sequence, the suitably normalized uniformizing maps from the abstract spheres of definition of the pseudo-Anosovs to the Riemann sphere have a uniform modulus of continuity. This enables Arzelà-Ascoli

type arguments to be used to construct limiting automorphisms of the Riemann sphere. In such examples the number of identifications along the boundaries of the polygons is finite, although unbounded along the sequence of pseudo-Anosovs: similar techniques can also be applied to the *generalized pseudo-Anosovs* of [4], for which an infinite number of identifications is required.

Section 2 contains a brief summary of necessary definitions and results from metric geometry and geometric function theory. The definition of paper surfaces, together with some of their key properties, is given in Section 3.

In Section 4, a sufficient condition for the conformal structure on the set of non-singular points of a paper surface to extend over an arbitrary singular set is given (Theorem 19).

In Section 5, attention is restricted to Riemann paper spheres, and the modulus of continuity of a suitably normalized isomorphism to the Riemann sphere is studied. An explicit modulus of continuity is given at each point of the paper sphere (Theorem 49), and it is shown that these give rise to a global modulus of continuity (Theorem 54).

**Acknowledgements:** The authors would like to thank Lasse Rempe for his very helpful comments on a draft of this paper. They gratefully acknowledge the support of FAPESP grant 2006/03829-2. The first author would also like to acknowledge the support of CNPq grant 151449/2008-2 and the hospitality of IMPA, where part of this work was developed.

## 2. BACKGROUND

In this section some necessary background from metric geometry and geometric function theory is briefly summarised. The book of Burago, Burago, and Ivanov [3] is an excellent reference for the former; and the texts of Ahlfors [1], Ahlfors-Sario [2], and Lehto-Virtanen [7] are the classic references for the latter.

**2.1. Metric spaces: quotient metrics and intrinsic metrics.** Let  $(X, d)$  be a metric space: it is convenient to take  $d: X \times X \rightarrow \mathbb{R}_{\geq 0} \cup \{\infty\}$ , so that two points can be infinitely distant from each other. If  $x \in X$  and  $\Lambda$  is a compact subset of  $X$ , then the notation  $d(x, \Lambda)$  is used to denote the distance from  $x$  to the closest point of  $\Lambda$ . The open and closed balls of radius  $r$  about  $\Lambda$  are denoted

$$\begin{aligned} B_X(\Lambda; r) &= \{y \in X : d(y, \Lambda) < r\} & \text{and} \\ \overline{B}_X(\Lambda; r) &= \{y \in X : d(y, \Lambda) \leq r\}. \end{aligned}$$

Let  $R$  be a relation on  $X$  (which in this paper will always be reflexive and symmetric). The *quotient metric space of  $X$  under  $R$*  is the quotient  $(X/d^R, d^R)$  of  $X$  by the greatest semi-metric  $d^R$  on  $X$  for which  $d^R(x, y) = 0$  whenever  $xRy$ , and  $d^R(x, y) \leq d(x, y)$  for all  $x, y \in X$  (so  $d^R$  is the supremum of all semi-metrics which satisfy these conditions).

The length of a path  $\gamma: [a, b] \rightarrow X$  is defined to be

$$|\gamma|_X = \sup \left\{ \sum_{i=1}^{k-1} d(\gamma(t_i), \gamma(t_{i+1})) \right\} \in \mathbb{R}_{\geq 0} \cup \{\infty\},$$

where the supremum is over all finite increasing sequences  $t_1 \leq t_2 \leq \dots \leq t_k$  in  $[a, b]$ . If  $|\gamma|_X < \infty$  then  $\gamma$  is said to be *rectifiable*.

The metric  $d$  on  $X$  is said to be *intrinsic* if the distance between any two points is arbitrarily well approximated by the lengths of paths joining them; and to be *strictly intrinsic* if the distance between any two points is equal to the length of a path joining them. It can be shown that a compact intrinsic metric is strictly intrinsic.

If  $d$  is not an intrinsic metric, then there is an induced intrinsic metric  $\hat{d}$  on  $X$  defined by

$$\hat{d}(x, y) = \inf\{|\gamma|_X : \gamma \text{ is a path from } x \text{ to } y\}$$

(and  $\hat{d}(x, y) = \infty$  if  $x$  and  $y$  lie in different path components of  $X$ ). For example, if  $P \subset \mathbb{C}$  is a polygon, then there is an intrinsic metric  $d_P$  on  $P$  induced by the Euclidean metric on  $\mathbb{C}$ , which does not in general agree with the subspace metric on  $P$ .

A proof of the following result can be found on pp. 62–63 of [3].

**Lemma 1.** *Let  $(X, d)$  be an intrinsic metric space, and  $R$  be a relation on  $X$ . Then the quotient metric space  $(X/d^R, d^R)$  is also intrinsic.*

## 2.2. Background geometric function theory.

**Definitions 2** (Module of an annular region, concentric and nested annular regions). An *annular region* in a surface is a subset homeomorphic to an open round annulus

$$A(r_1, r_2) = \{z \in \mathbb{C} : r_1 < |z| < r_2\},$$

where  $0 \leq r_1 < r_2 \leq \infty$ . If  $A \subset \mathbb{C}$  is an annular region, then there is a conformal map taking  $A$  onto some round annulus  $A(r_1, r_2)$ , and this map is unique up to postcomposition with a homothety. The ratio  $r_2/r_1$  is therefore a conformal invariant of  $A$ , and the *module*  $\text{mod } A$  of  $A$  is defined by

$$\text{mod } A = \begin{cases} \infty & \text{if } r_1 = 0 \text{ or } r_2 = \infty, \\ \frac{1}{2\pi} \ln \frac{r_2}{r_1} & \text{otherwise.} \end{cases}$$

Suppose that  $D$  is a closed topological disk and that  $A \subset D$  is an annular region. The *bounded component* of  $D \setminus A$  is the one which is disjoint from  $\partial D$ .

Annular regions  $A_0, A_1 \subset D$  are *concentric* if the bounded complementary component of one is contained in the bounded complementary component of the other. They are *nested* if one is entirely contained in the bounded complementary component of the other.

The following fundamental inequality will be important:

**Theorem 3** (Additivity of the module). *If  $A_n$  is a finite or countable family of nested annular regions all contained in and concentric with the annular region  $A$ , then*

$$\text{mod } A \geq \sum \text{mod } A_n.$$

A *conformal metric* on  $\mathbb{C}$  is a metric obtained defining the length of arcs by  $|\gamma|_\nu := \int_\gamma \nu(z)|dz|$ , where  $\nu$  is a nonnegative Borel measurable function defined on  $\mathbb{C}$ . If  $A$  is an annular region in  $\mathbb{C}$  whose boundary components are  $C_1, C_2$  then

$$\text{mod } A = \sup \left\{ \frac{d_\nu(C_1, C_2)^2}{\text{Area}_\nu(A)} : \nu(z)|dz| \text{ is a conformal metric} \right\},$$

where  $d_\nu(C_1, C_2)$  is the  $\nu$ -distance between the boundary components of  $A$  (i.e., the minimum  $\nu$ -length of an arc with endpoints in  $C_1$  and  $C_2$ ) and  $\text{Area}_\nu(A) = \iint_A \nu(z)^2 dx dy$  is the  $\nu$ -area of  $A$ . In particular, given any conformal metric  $\nu(z)|dz|$ ,

$$(1) \quad \text{mod } A \geq \frac{d_\nu(C_1, C_2)^2}{\text{Area}_\nu(A)}.$$

The following theorem provides an upper bound on the module of an annulus.

**Theorem 4** (Grötzsch Annulus Theorem). *Let  $A$  be an annular region contained in the disk  $|z| \leq R$  in  $\mathbb{C}$ , and suppose that the points  $z_1$  and  $z_2$  are contained in the bounded complementary component of  $A$ . Then*

$$\text{mod } A \leq \frac{1}{2\pi} \ln \frac{8R}{|z_1 - z_2|}.$$

□

A proof of the following straightforward distortion theorem can be found in [5].

**Theorem 5.** *Let  $P \subset \mathbb{C}$  be a closed topological disk,  $p \in \text{Int}(P)$  and  $\Phi: \text{Int}(P) \rightarrow \mathbb{C}$  be a univalent (i.e. injective and holomorphic) function with  $\Phi(p) = 0$  and  $\Phi'(p) = 1$ . Let  $Q(h)$  denote the closed interior collar neighborhood of  $\partial P$  of  $d_{\mathbb{C}}$ -width  $h > 0$  and set  $P_h := P \setminus Q(h)$ . Assume that  $h$  is small enough that  $P_h$  is path connected and  $p \in P_h$ , and set*

$$\kappa := \exp \left( \frac{8 \text{diam}_{P_h} P_h}{h} \right),$$

where  $\text{diam}_{P_h} P_h$  denotes the diameter of  $P_h$  in the intrinsic metric  $d_{P_h}$  on  $P_h$  induced by  $d_{\mathbb{C}}$ . Then  $\Phi$  is  $\kappa$ -biLipschitz in  $P_h$ .

□

A compact subset  $E \subset \mathbb{C}$  whose complement  $W_E := \mathbb{C} \setminus E$  is connected has *absolute area zero* if, for any univalent map  $f: W_E \rightarrow \mathbb{C}$ , the area of  $\mathbb{C} \setminus f(W_E)$  is zero. In terms of the classification of Riemann surfaces, this is equivalent to saying that  $W_E \in O_{AD}$ , the class of Riemann surfaces whose only analytic functions with bounded Dirichlet integral are the constants (Theorem IV.2B, p. 199 of [2]). This implies, in particular, the following *removability* theorem (see Theorem IV.4B, p. 201 of [2]):

**Theorem 6.** *Let  $\Omega \subset \mathbb{C}$  be a domain and  $E \subset \Omega$  be a subset with absolute area zero such that  $\Omega \setminus E$  is also a domain. Then any bounded univalent map  $g: \Omega \setminus E \rightarrow \mathbb{C}$  extends uniquely to all of  $\Omega$  as a bounded univalent map.*

□

The following criterion for a set to have absolute area zero is due to McMullen [8]:

**Theorem 7.** *Let  $U_1, U_2, \dots$  be a sequence of disjoint open sets in  $\mathbb{C}$  satisfying the following conditions:*

- a)  $U_n$  is a finite union of disjoint unnnested annular regions of finite module;
- b) any component of  $U_{n+1}$  is nested inside some component of  $U_n$ ;

c) if  $\{A_n\}$  is any nested sequence of annular regions, where  $A_n$  is a component of  $U_n$ , then  $\sum_n \text{mod}(A_n) = \infty$ .

Let  $E_n$  denote the union of the bounded components of  $\mathbb{C} \setminus U_n$  and set  $E := \bigcap_n E_n$ . Then  $E$  is a totally disconnected compact set of absolute area zero.

□

### 3. PAPER SURFACES

In this section the main objects of study – paper-folding schemes and paper surfaces – are introduced. Their topological and metric structures are discussed, and some pertinent results from [5] are stated without proof: the emphasis in this paper will be on the conformal structure of paper surfaces, which is discussed in Section 4.

**Definitions 8** (Arc, segment, polygon, multipolygon). An *arc* in a metric space  $X$  is a homeomorphic image  $\gamma \subset X$  of the interval  $[0, 1]$ . Its *endpoints* are the images of 0 and 1 and its *interior*  $\overset{\circ}{\gamma}$  is the image of  $(0, 1)$ . A *segment* is an arc in  $\mathbb{C}$  which is a subset of a straight line. The length of a segment  $\alpha$  is denoted  $|\alpha|$ . A *simple closed curve* in  $X$  is a homeomorphic image of the unit circle.

An arc or simple closed curve in  $\mathbb{C}$  is called *polygonal* if it is the concatenation of finitely many segments. The maximal segments are called the *edges* of the arc or simple closed curve, and their endpoints are its *vertices*.

A *polygon* is a closed topological disk in  $\mathbb{C}$  whose boundary is a polygonal simple closed curve. Its *vertices* are the same as its boundary's vertices and its *sides* are the edges forming its boundary.

A *multipolygon* is a disjoint union of finitely many polygons. A *polygonal multicurve* is a disjoint union of finitely many polygonal simple closed curves.

**Definitions 9** (Segment pairing, interior pair, full collection, fold). Let  $C \subset \mathbb{C}$  be an oriented polygonal multicurve and  $\alpha, \alpha' \subset C$  be segments (not necessarily edges) of the same length with disjoint interiors. The *segment pairing*  $\langle \alpha, \alpha' \rangle$  is the relation which identifies pairs of points of  $\alpha$  and  $\alpha'$  in a length-preserving and orientation-reversing way. The segments  $\alpha, \alpha'$  and any two points which are identified under the pairing are said to be *paired*. Two paired points which lie in the interior of a segment pairing form an *interior pair*. The notation for a pairing is not ordered, so that  $\langle \alpha, \alpha' \rangle$  and  $\langle \alpha', \alpha \rangle$  represent the same pairing.

A collection  $\{\langle \alpha_i, \alpha'_i \rangle\}$  of segment pairings is *interior disjoint* if the interiors of all of the segments  $\alpha_i$  and  $\alpha'_i$  are pairwise disjoint.

The *length* of a segment pairing  $\langle \alpha, \alpha' \rangle$ , denoted  $|\langle \alpha, \alpha' \rangle|$ , is the length of one of the arcs in the pairing, i.e.,  $|\langle \alpha, \alpha' \rangle| := |\alpha| = |\alpha'|$ .

A (necessarily countable) interior disjoint collection  $\mathcal{P} = \{\langle \alpha_i, \alpha'_i \rangle\}$  of segment pairings on  $C$  is *full* if  $\sum_i |\langle \alpha_i, \alpha'_i \rangle|$  equals half the length of  $C$ , so that the pairings in  $\mathcal{P}$  cover  $C$  up to a set of Lebesgue 1-dimensional measure zero.

A pairing of two segments which have an endpoint in common is called a *fold* and the common endpoint is called its *folding point*. The folding point of a fold is therefore not paired with any other point.

An interior disjoint collection  $\mathcal{P}$  of segment pairings induces a reflexive and symmetric *pairing relation*, also denoted  $\mathcal{P}$ , so  $\mathcal{P} = \{(x, x') : x, x' \text{ are paired or } x = x'\}$ .

**Definitions 10** (Paper-folding scheme). A *paper-folding scheme* is a pair  $(P, \mathcal{P})$  where  $P \subset \mathbb{C}$  is a multipolygon with the intrinsic metric  $d_P$  induced from  $\mathbb{C}$ , and  $\mathcal{P}$  is a full interior disjoint collection of segment pairings on  $\partial P$  (positively oriented). The metric quotient  $S := P/d_P^{\mathcal{P}}$  of  $P$  under the semi-metric  $d_P^{\mathcal{P}}$  induced by the pairing relation  $\mathcal{P}$  is the associated *paper space*. When  $S$  is a closed (compact without boundary) topological surface, then  $(P, \mathcal{P})$  is called a *surface paper-folding scheme* and  $S$  is the associated *paper surface*.

The projection map is denoted  $\pi: P \rightarrow S$  and the quotient  $G = \pi(\partial P) \subset S$  of the boundary is the *scar*. Notice that the restriction  $\pi: \text{Int}(P) \rightarrow S \setminus G$  is a homeomorphism.

The (quotient) metric on  $S$  is denoted  $d_S$ . The metric  $d_G$  on  $G$  is defined to be its intrinsic metric as a subset of  $S$ : this is equal to the quotient metric on  $G$  as a quotient of  $\partial P$ , where  $\partial P$  is endowed with its intrinsic metric as a subset of  $P$  (Lemma 12).

The measure  $m_G$  on  $G$  is defined to be the push-forward of Lebesgue 1-dimensional measure  $m_{\partial P}$  on  $\partial P$ . Hausdorff 1-dimensional measure on  $G$  is denoted  $\mu_G^1$  — Lemma 12 states that  $\mu_G^1 = \frac{1}{2}m_G$ .

The next definitions distinguish different types of points in a paper space.

**Definitions 11** (Vertex, edge, singular point, planar point). For  $k \in \mathbb{N} \cup \{\infty\}$ , a point  $x \in G$  is a *vertex of valence  $k$* , or a  *$k$ -vertex*, if either (i)  $\#\pi^{-1}(x) = k \neq 2$ ; or (ii)  $\#\pi^{-1}(x) = k = 2$  and  $\pi^{-1}(x)$  contains a vertex of  $P$ . Let  $\mathcal{V}$  denote the set of all vertices of  $G$ .

The points of the paper space  $S$  are divided into three types:

**Singular points:** vertices of valence  $\infty$  and accumulations of vertices. Let  $\mathcal{V}^s$  denote the set of singular points.

**Regular vertices:** vertices which are not singular (that is, isolated vertices of finite valence).

**Planar points:** all other points of  $S$ : that is, the points of  $S \setminus \overline{\mathcal{V}}$ .

The closures of the connected components of  $G \setminus \overline{\mathcal{V}}$  are called *edges* of the scar  $G$ .

The next lemma summarises the properties of the metric and measure on the scar  $G$  which will be used here.

**Lemma 12** ([5]). *Let  $G$  be the scar of the paper-folding scheme  $(P, \mathcal{P})$ . Then*

- a) *The set of planar points is open and dense in the scar  $G$ , while the set  $\overline{\mathcal{V}}$  of vertices and singular points is a closed nowhere dense subset of  $G$  with zero  $m_G$ -measure.*
- b) *The intrinsic metric on  $G$  induced by the inclusion  $G \subset S$  agrees with the quotient metric on  $G = \partial P/d_P^{\mathcal{P}}$  induced by the intrinsic metric  $d_{\partial P}$  on  $\partial P$ .*
- c)  *$G$  has Hausdorff dimension 1, and Hausdorff 1-dimensional measure  $\mu_G^1$  on  $G$  is equal to  $\frac{1}{2}m_G$ .*
- d) *Every arc  $\gamma$  in  $G$  is rectifiable, and  $|\gamma|_G = \frac{1}{2}m_G(\gamma)$ .*

□

For clarity of exposition, attention will be concentrated on *plain* folding schemes: these are both the most common and the simplest type of paper foldings and for them the paper space is always a sphere and the scar is always a dendrite (Theorem 14).

**Definitions 13** (Unlinked pairing, plain paper-folding scheme). Let  $\gamma$  be a polygonal arc or polygonal simple closed curve.

Two pairs of (not necessarily distinct) points  $\{x, x'\}$  and  $\{y, y'\}$  of  $\gamma$  are *unlinked* if one pair is contained in the closure of a connected component of the complement of the other. Otherwise they are *linked*.

A symmetric and reflexive relation  $R$  on  $\gamma$  is *unlinked* if any two unrelated pairs of related points are unlinked: that is, if  $x R x'$ ,  $y R y'$ , and neither  $x$  nor  $x'$  is related to either  $y$  or  $y'$ , then  $\{x, x'\}$  and  $\{y, y'\}$  are unlinked.

An interior disjoint collection  $\mathcal{P}$  of segment pairings on  $\gamma$  is *unlinked* if the corresponding relation  $\mathcal{P}$  is unlinked.

A paper-folding scheme  $(P, \mathcal{P})$  is *plain* if  $P$  is a single polygon and  $\mathcal{P}$  is unlinked.

**Theorem 14** (Topological structure of a plain paper folding [5]). *The quotient  $S$  of a plain paper-folding scheme is a topological sphere, and its scar  $G$  is a dendrite.*

□

*Remarks 15.* Recall that a *dendrite*  $G$  is a locally connected continuum which doesn't contain any simple closed curve. The following properties of dendrites will be used later [6, 11]:

- a) Any two distinct points of  $G$  are separated by a third point of  $G$ . Conversely, any continuum with this property is a dendrite.
- b) If  $x$  and  $y$  are distinct points of  $G$  then there is a unique arc in  $G$ , denoted  $[x, y]_G$ , with endpoints  $x$  and  $y$ . The notation  $(x, y)_G$  will be used to denote  $[x, y]_G \setminus \{x, y\}$ .
- c) Every subcontinuum of  $G$  is also a dendrite.

Necessary and sufficient conditions can also be given for a paper-folding scheme to be a surface paper folding. The only constraint is the obvious one: linked pairings create handles, and if there are infinitely many handles then the quotient space cannot be a compact surface – the paper-folding scheme must therefore be “finitely linked”. However, all that will be needed here is the following description of the scar of a surface paper folding.

**Theorem 16** ([5]). *Necessary and sufficient conditions can be given for a paper-folding scheme  $(P, \mathcal{P})$  to be a surface paper folding scheme. In this case, the scar  $G$  is a local dendrite, which can be written as  $G = C \cup \Gamma$ , where*

- $C$  is a finite connected graph in  $S$  with the property that any simple closed curve in  $C$  is homotopically non-trivial in  $S$ ; and
- $\Gamma$  is a union of finitely or countably many disjoint dendrites, with diameters decreasing to 0, each of which intersects  $C$  in exactly one point.

□

#### 4. CONFORMAL STRUCTURES ON PAPER SURFACES

If  $(P, \mathcal{P})$  is a surface paper-folding scheme with quotient paper surface  $S$ , then there is a natural complex structure on the set  $S \setminus \bar{\mathcal{V}}$  of planar points of  $S$  induced by the local Euclidean structure. This complex structure extends readily across regular (isolated) vertices of  $G$ : at such a vertex around which the total angle is  $\theta$ , maps of the form  $z \mapsto z^{2\pi/\theta}$  can be used as charts.

The question addressed in this section is whether this conformal structure on  $S \setminus \mathcal{V}^s$  extends uniquely across  $\mathcal{V}^s$  to endow  $S$  with a unique natural Riemann surface structure. When this is the case,  $S$  is said to be a *Riemann paper surface*.



In fact, it can be useful to ask whether the conformal structure extends across some subset  $\Lambda$  of the singular set. Throughout this section,  $(P, \mathcal{P})$  will be a surface paper-folding scheme with scar  $G$ , and  $\Lambda$  will denote a clopen (i.e. open and closed) subset of the set  $\mathcal{V}^s \subset \overline{\mathcal{V}}$  of singular points of  $G$ . By Lemma 12, any such set  $\Lambda$  is totally disconnected with  $m_G(\Lambda) = 0$ .

**4.1. Statement of results.** Theorem 19 below is the first main result of this paper: it gives sufficient conditions for the complex structure on  $S \setminus \mathcal{V}^s$  to extend uniquely across the set  $\Lambda$ . The theorem will be proved in Section 4.3 after some examples have been discussed in Section 4.2.

**Definitions 17** ( $CB_\Lambda(q; r)$ ,  $CC_\Lambda(q; r)$ ,  $cm_\Lambda(q; r)$ ,  $cn_\Lambda(q; r)$ ). Let  $q \in \Lambda$ . Denote by  $CB_\Lambda(q; r)$  the connected component of  $B_G(\Lambda; r)$  which contains  $q$ ; by  $CC_\Lambda(q; r)$  the boundary in  $G$  of  $CB_\Lambda(q; r)$ ; by  $cm_\Lambda(q; r) = m_G(CB_\Lambda(q; r))$  the measure of  $CB_\Lambda(q; r)$ ; and by  $cn_\Lambda(q; r) \in \mathbb{N} \cup \{\infty\}$  the cardinality of  $CC_\Lambda(q; r)$ .

*Remark 18.* If  $q_1, q_2, \dots, q_n \in \Lambda$  are such that  $d_G(q_i, q_{i+1}) < 2r$  for  $1 \leq i < n$ , then all of the sets  $CB_\Lambda(q_i; r)$  are equal.

**Theorem 19.** *Let  $(P, \mathcal{P})$  be a surface paper-folding scheme with associated paper surface  $S$  and scar  $G$ , and let  $\Lambda \subset \mathcal{V}^s$  be a clopen subset of  $\mathcal{V}^s$ . Then the complex structure on  $S \setminus \mathcal{V}^s$  extends uniquely across  $\Lambda$  provided that, for every  $q \in \Lambda$ ,*

$$(2) \quad \int_0^{\infty} \frac{dr}{cm_\Lambda(q; r) + r \cdot cn_\Lambda(q; r)} = \infty.$$

*In particular, if  $\Lambda = \mathcal{V}^s$  and (2) holds for every  $q \in \Lambda$ , then  $S$  is a Riemann paper surface.*

*Remark 20.* If  $\Lambda = \{q\}$  is a single point, then  $cm_\Lambda(q; r) = m_G(B_G(q; r))$  and  $cn_\Lambda(q; r)$  is the number of points of  $G$  at distance  $r$  from  $q$ : the theorem thus includes the corresponding result of [5] as a special case.

## 4.2. Examples.

**Example 21.** In the plain paper-folding scheme of this example, there is a countable set of singularities accumulating on a single point. Theorem 19 will be used to show that the conformal structure on the set of planar points extends uniquely to the whole of the paper sphere  $S$ .

Let  $P$  be the unit square  $\{x + iy: x, y \in [0, 1]\}$  in  $\mathbb{C}$ . The two vertical sides of the square are paired together, and the top side is folded in half. The segment pairings on the bottom side of  $P$  are depicted in Figure 1: in each of the shaded regions, the pairings are shown on the interval on the right of the figure.

To describe the pairings on that interval, define subintervals  $\alpha_k$  and  $\alpha'_k$  of  $[0, 1]$  for  $k \geq 0$  by  $\alpha_0 = [0, 1/4]$ ,  $\alpha'_0 = [3/4, 1]$ , and

$$\alpha_k = \left[ \frac{1}{4} + \frac{1}{2^{k+1}}, \frac{1}{4} + \frac{3}{2^{k+2}} \right], \quad \alpha'_k = \left[ \frac{1}{4} + \frac{3}{2^{k+2}}, \frac{1}{4} + \frac{1}{2^k} \right] \quad (k \geq 1),$$

so that  $|\alpha_k| = |\alpha'_k| = 1/2^{k+2}$  and  $\sum_{k \geq 0} |\alpha_k| = 1/2$ . For  $k \geq 1$ , write  $\xi_k = \frac{1}{4} + \frac{3}{2^{k+2}}$ , the common endpoint of  $\alpha_k$  and  $\alpha'_k$ .

Now define embeddings  $\varphi_j: [0, 1] \rightarrow \mathbb{C}$  for  $j \geq 0$  by  $\varphi_j(x) = (x + 1)/2^{j+1}$ , so that  $\varphi_j([0, 1]) = [1/2^{j+1}, 1/2^j]$ . The segment pairings on the bottom side of  $P$  are then given by  $\langle \alpha_{j,k}, \alpha'_{j,k} \rangle$  for

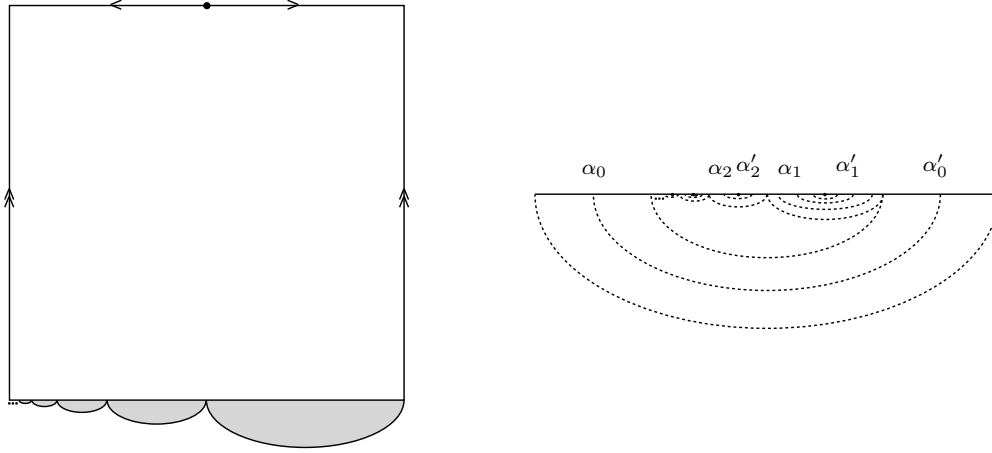

FIGURE 1. A paper-folding scheme with a sequence of singularities

$j, k \geq 0$ , where  $\alpha_{j,k} = \varphi_j(\alpha_k)$  and  $\alpha'_{j,k} = \varphi_j(\alpha'_k)$ . Observe that  $|\alpha_{j,k}| = |\alpha'_{j,k}| = 1/2^{j+k+3}$ , so that  $\sum_{j,k \geq 0} |\alpha_{j,k}| = 1/2$ .

Let  $S$  be the paper sphere corresponding to this paper-folding scheme  $(P, \mathcal{P})$  (which is clearly plain),  $\pi: P \rightarrow S$  be the projection, and  $G$  be the scar. Write  $a_{j,k} = \pi(\alpha_{j,k}) = \pi(\alpha'_{j,k})$  for  $j, k \geq 0$ , and  $a$  for the projection of the vertical edges of  $P$ . The scar is depicted in Figure 2. Its non-planar points are as follows:

- A valence 1 vertex at  $y = \pi(1/2 + i)$  and a valence 2 vertex at  $z = \pi(i) = \pi(1 + i)$ ;
- Valence 1 vertices at  $x_{j,k} = \pi(\varphi_j(\xi_k))$  for  $j \geq 0$  and  $k \geq 1$ ;
- Singularities at  $s_j = \pi(\varphi_j(1/4))$  for  $j \geq 0$ ; and
- A singularity at  $s = \pi(0) = \pi(1) = \pi(1/2) = \pi(1/4) = \dots$ .

Theorem 19 will now be applied with  $\Lambda = \mathcal{V}^s = \{s\} \cup \{s_j : j \geq 0\}$ . In order to do this, it is necessary to understand the sets  $\text{CB}_\Lambda(q; r)$  and the cardinality  $\text{cn}_\Lambda(q; r)$  of  $\text{CC}_\Lambda(q; r)$  for  $q \in \Lambda$ .

Observe first, using Remark 18, that if  $1/16 < r \leq 1/8$  then  $\text{CB}_\Lambda(q; r)$  is independent of  $q \in \Lambda$ , and consists of the union of all of the edges  $a_{j,k}$  together with a segment of the edge  $a$  of length  $r$ . Hence  $\text{cm}_\Lambda(q; r) = 1 + 2r$  and  $\text{cn}_\Lambda(q; r) = 1$ .

If  $1/32 < r \leq 1/16$  then there are two possibilities:

- 1) If  $q = s_0$  then  $\text{CB}_\Lambda(q; r)$  is the union of the edges  $a_{0,k}$  for  $k \geq 1$ , together with a segment of the edge  $a_{0,0}$  of length  $r$ . Hence  $\text{cm}_\Lambda(q; r) = 1/4 + 2r$  and  $\text{cn}_\Lambda(q; r) = 1$ .
- 2) Otherwise,  $\text{CB}_\Lambda(q; r)$  is the union of the edges  $a_{j,k}$  for  $j \geq 1$  and  $k \geq 0$ , together with segments of  $a_{0,0}$  and  $a$  of length  $r$ . Hence  $\text{cm}_\Lambda(q; r) = 1/2 + 4r$  and  $\text{cn}_\Lambda(q; r) = 2$ .

Therefore if  $1/32 < r \leq 1/16$  then  $\text{cm}_\Lambda(q; r) + r \cdot \text{cn}_\Lambda(q; r) \leq 1/2 + 6r$ .

By a similar argument, if  $1/2^{j+4} < r \leq 1/2^{j+3}$  for some  $j \geq 0$ , then both  $\text{cm}_\Lambda(q; r)$  and  $r \cdot \text{cn}_\Lambda(q; r)$  are maximised when  $s \in \text{CB}_\Lambda(q; r)$ ; in this case,  $\text{cm}_\Lambda(q; r) = 1/2^j + 2(j+1)r$  and

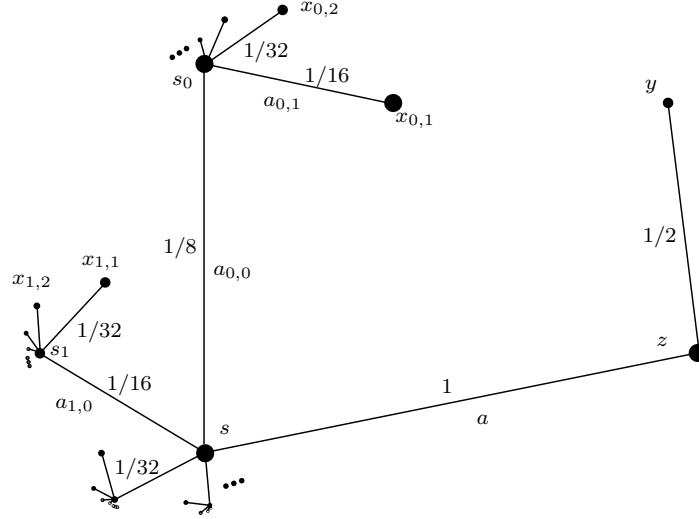

FIGURE 2. The scar of the paper-folding scheme of Figure 1

$\text{cn}_\Lambda(q; r) = j + 1$ . Therefore

$$\text{cn}_\Lambda(q; r) + r \cdot \text{cn}_\Lambda(q; r) \leq \frac{1}{2^j} + 3(j+1)r \quad \left( \frac{1}{2^{j+4}} < r \leq \frac{1}{2^{j+3}} \right).$$

Hence, for all  $q \in \Lambda$ ,

$$\begin{aligned} \int_{1/2^{j+4}}^{1/2^{j+3}} \frac{dr}{\text{cn}_\Lambda(q; r) + r \cdot \text{cn}_\Lambda(q; r)} &\geq \int_{1/2^{j+4}}^{1/2^{j+3}} \frac{dr}{\frac{1}{2^j} + 3(j+1)r} \\ &= \frac{1}{3(j+1)} \ln \left( \frac{22 + 6j}{19 + 3j} \right) \\ &\geq \frac{\ln(22/19)}{3(j+1)}, \end{aligned}$$

so that  $\int_0^1 \frac{dr}{\text{cn}_\Lambda(q; r) + r \cdot \text{cn}_\Lambda(q; r)}$  diverges.

It follows from Theorem 19 that there is a unique conformal structure on the paper sphere  $S$  which agrees with that induced by the Euclidean structure on the set of planar points.

*Remark 22.* If the sequence of lengths in the above example decreases polynomially rather than exponentially, then the integral converges. The authors do not know whether or not the conformal structure extends uniquely across  $\mathcal{V}^s$  in this case.

**Example 23.** An example is now sketched in which the paper sphere  $S$  has a Cantor set of singularities across which the conformal structure extends uniquely.

As in Example 21, the polygon  $P$  is the unit square  $\{x + iy : x, y \in [0, 1]\}$  in  $\mathbb{C}$ , the two vertical sides of  $P$  are paired together, and the top side is folded in half.

To describe the pairings on the bottom side  $[0, 1] \subset \mathbb{C}$  of  $P$ , first set  $E_0 = [2/3, 1]$ , and then let  $E_{i,j}$  for  $i \geq 1$  and  $0 \leq j < 2^{i-1}$  be a family of disjoint closed intervals with  $|E_{i,j}| = 2/3^{i+1}$  chosen as in the construction of the standard middle-thirds Cantor set in  $[0, 2/3]$ : thus  $E_{1,0} = [2/9, 4/9]$ ,  $E_{2,0} = [2/27, 4/27]$ ,  $E_{2,1} = [14/27, 16/27]$ , and so on: the intervals  $E_{i,j}$  are the middle thirds of the complementary components in  $[0, 2/3]$  of the union of all intervals  $E_{i',j'}$  with  $i' < i$ . (See the top section of Figure 3.)

Now subdivide each  $E_{i,j}$  into four subintervals of equal length  $1/(2 \cdot 3^{i+1})$ , denoted  $\beta_{i,j}$ ,  $\alpha_{i,j}$ ,  $\alpha'_{i,j}$ , and  $\gamma_{i,j}$  from left to right.

The pairings along the bottom side of  $P$  can be described succinctly as follows:  $\alpha_{i,j}$ ,  $\beta_{i,j}$  and  $\gamma_{i,j}$  are paired with  $\alpha'_{i,j}$ ,  $\beta'_{i,j}$  and  $\gamma'_{i,j}$ , where  $\beta'_{i,j}$  and  $\gamma'_{i,j}$  are subintervals of  $E_0$  chosen in such a way that the paper-folding scheme is plain.

To be more precise, write  $\beta_{i,j} = [\xi_{i,j}, \zeta_{i,j}]$ ,  $\alpha_{i,j} = [\zeta_{i,j}, \lambda_{i,j}]$ ,  $\alpha'_{i,j} = [\lambda_{i,j}, \zeta'_{i,j}]$ , and  $\gamma_{i,j} = [\zeta'_{i,j}, \eta_{i,j}]$ . Then  $\beta'_{i,j} := [\zeta''_{i,j}, \xi'_{i,j}] = [1 - \lambda_{i,j}/2, 1 - \xi_{i,j}/2]$ , and  $\gamma'_{i,j} := [\eta'_{i,j}, \zeta''_{i,j}] = [1 - \eta_{i,j}/2, 1 - \lambda_{i,j}/2]$ . The pairings along the bottom side of  $P$  are then given by  $\langle \alpha_{i,j}, \alpha'_{i,j} \rangle$ ,  $\langle \beta_{i,j}, \beta'_{i,j} \rangle$ , and  $\langle \gamma_{i,j}, \gamma'_{i,j} \rangle$  for  $i \geq 1$  and  $0 \leq j < 2^{i-1}$  (see Figure 3).

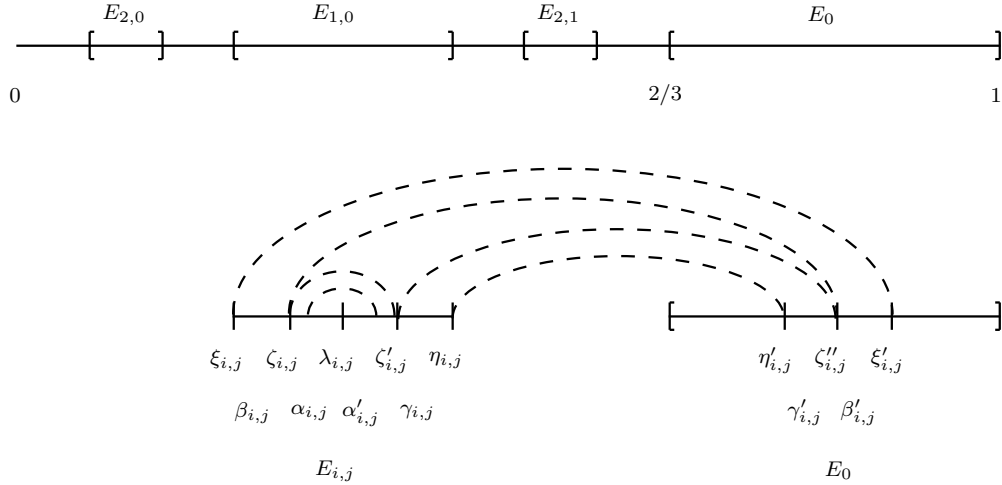

FIGURE 3. Construction of a paper sphere with a Cantor set of singularities

Let  $S$  be the paper sphere corresponding to this (plain) paper-folding scheme,  $\pi: P \rightarrow S$  be the projection and  $G$  be the scar. The vertices of  $G$  are all regular points, and are as follows:

- A valence 1 vertex at  $\pi(1/2+i)$  and valence two vertices at  $\pi(i) = \pi(1+i)$  and  $\pi(0) = \pi(1)$ ;
- Valence 1 vertices at  $w_{i,j} := \pi(\lambda_{i,j})$  for  $i \geq 1$  and  $0 \leq j < 2^{i-1}$ ; and
- Valence 3 vertices at  $z_{i,j} := \pi(\zeta_{i,j}) = \pi(\zeta'_{i,j}) = \pi(\zeta''_{i,j})$  for  $i \geq 1$  and  $0 \leq j < 2^{i-1}$ .

For each  $i \geq 1$  and  $0 \leq j < 2^{i-1}$ ,  $\pi(E_{i,j})$  is a triod with central vertex  $z_{i,j}$ , and ends  $w_{i,j}$ ,  $x_{i,j} := \pi(\xi_{i,j}) = \pi(\xi'_{i,j})$ , and  $y_{i,j} := \pi(\eta_{i,j}) = \pi(\eta'_{i,j})$ . The singular set  $\mathcal{V}^s$  consists of all of the

accumulation points of vertices: that is,

$$\mathcal{V}^s = \overline{\bigcup_{i,j} \{x_{i,j}, y_{i,j}\}}.$$

$\pi|_{E_0}$  is an isometric embedding of  $E_0$  into  $G$ , and  $\mathcal{V}^s$  is a standard middle-thirds Cantor set in  $\pi(E_0)$ .

Let  $\Lambda = \mathcal{V}^s$ . A similar argument to that of Example 21 can be used to show that the complex structure on  $S \setminus \mathcal{V}^s$  extends uniquely across  $\Lambda$ : if  $1/(2 \cdot 3^{k+2}) < r \leq 1/(2 \cdot 3^{k+1})$  for  $k \geq 0$ , then  $B_G(\Lambda; r)$  has  $2^k$  connected components, each of which has measure bounded above by  $1/3^k + 4r$  and at most three boundary points in  $G$ . Therefore, for all  $q \in \Lambda$ ,

$$\text{cm}_\Lambda(q; r) + r \cdot \text{cn}_\Lambda(q; r) \leq \frac{1}{3^k} + 7r \quad \left( \frac{1}{2 \cdot 3^{k+2}} < r \leq \frac{1}{2 \cdot 3^{k+1}} \right),$$

so that

$$\int_{1/2 \cdot 3^{k+2}}^{1/2 \cdot 3^{k+1}} \frac{dr}{\text{cm}_\Lambda(q; r) + r \cdot \text{cn}_\Lambda(q; r)} \geq \frac{\ln(39/25)}{7}$$

for all  $k \geq 0$ , and (2) follows.

*Remark 24.* In both of the examples, the identifications respect the horizontal and vertical structure of the square  $P$ . Therefore the quadratic differential  $dz^2$  on  $P$  projects to an  $L^1$  quadratic differential on the quotient (with  $L^1$  norm 1) which is holomorphic away from the singular set and has simple poles at the fold points.

### 4.3. Proof of Theorem 19.

4.3.1. *Preliminaries.* In this section the technical tools needed for the proof are developed: the main focus is on the way in which the number and structure of the components of  $B_G(\Lambda; r)$  vary with  $r$ .

**Definition 25** (Injectivity radius). A number  $\bar{r} > 0$  is called an *injectivity radius* for  $\Lambda$  if the closure  $\overline{\text{CB}_\Lambda(q; r)}$  of  $\text{CB}_\Lambda(q; r)$  is a dendrite, and a proper subset of  $G$ , for every  $q \in \Lambda$  and  $r \in (0, \bar{r})$ .

**Lemma 26.** *An injectivity radius for  $\Lambda$  exists.*

*Proof.* By Theorem 16,  $G$  can be written as  $G = C \cup \Gamma$ , where  $C$  is a finite connected graph and  $\Gamma$  is a union of countably many dendrites, each attached to  $C$  at a single point, which is an element of  $\overline{\mathcal{V}}$ .

If  $C \neq \emptyset$  then let  $e_1, \dots, e_N$  denote the edges of  $C$ , and choose arcs  $\gamma_i \subset e_i$  which are disjoint from  $\overline{\mathcal{V}}$  (this is possible since  $\overline{\mathcal{V}}$  is a closed and totally disconnected subset of  $G$ ). If  $C = \emptyset$ , then let  $N = 1$  and  $\gamma_1$  be any arc in  $G \setminus \overline{\mathcal{V}}$ .

Each connected component of  $G \setminus \bigcup_{i=1}^N \overset{\circ}{\gamma}_i$  is a continuum in which any two points are separated by a third point, and is therefore a dendrite by Remarks 15 a).

Let  $\bar{r} = \min_{1 \leq i \leq N} d_G(\gamma_i, \overline{\mathcal{V}}) > 0$ . Then if  $r \in (0, \bar{r})$  and  $q \in \Lambda$ , the set  $\overline{\text{CB}_\Lambda(q; r)}$  is a subcontinuum of the component of  $G \setminus \bigcup_{i=1}^N \overset{\circ}{\gamma}_i$  containing  $q$ , and is therefore a dendrite by Remarks 15 c) as required.  $\square$

Throughout the remainder of the section,  $\bar{r} > 0$  denotes a fixed choice of injectivity radius for  $\Lambda$ .

**Definitions 27** ( $\text{ncc}_\Lambda(r)$ ,  $\text{NC}(\Lambda)$ ,  $\text{C}\Lambda_\Lambda(q; r)$ ). For  $r \in (0, \bar{r})$ , let  $\text{ncc}_\Lambda(r)$  denote the number of connected components of  $B_G(\Lambda; r)$ . Let  $\text{NC}(\Lambda) \subset (0, \bar{r})$  denote the set of values  $r > 0$  at which  $\text{ncc}_\Lambda(r)$  is discontinuous (i.e. not locally constant).

Given  $q \in \Lambda$  and  $r \in (0, \bar{r})$ , write  $\text{C}\Lambda_\Lambda(q; r) = \Lambda \cap \text{C}B_\Lambda(q; r)$ , the set of points of  $\Lambda$  in the connected component of  $B_G(\Lambda; r)$  which contains  $q$ .

*Remark 28.* Fix  $r \in (0, \bar{r})$ . Each  $\text{C}\Lambda_\Lambda(q; r)$  is an open subset of  $\Lambda$  since  $\text{C}B_\Lambda(q; r)$  is open in  $G$ . If  $q_1, q_2 \in \Lambda$ , then  $\text{C}\Lambda_\Lambda(q_1; r)$  and  $\text{C}\Lambda_\Lambda(q_2; r)$  are either equal or disjoint. The sets  $\text{C}\Lambda_\Lambda(q; r)$  with  $q \in \Lambda$  therefore constitute a partition of  $\Lambda$  by clopen subsets: in particular, each  $\text{C}\Lambda_\Lambda(q; r)$  is compact.

**Lemma 29.**

- a)  $\text{ncc}_\Lambda(r)$  is finite, and is a decreasing function of  $r$ .
- b)  $\text{NC}(\Lambda)$  is finite if  $\Lambda$  is finite, and otherwise consists of a decreasing sequence converging to 0.
- c) Let  $(r_1, r_2)$  be a complementary component of  $\text{NC}(\Lambda)$  and let  $q \in \Lambda$ . Then the set  $\text{C}\Lambda_\Lambda(q; r)$  is constant for  $r \in (r_1, r_2)$ .
- d)  $\text{C}\Lambda_\Lambda(q; r)$  is the set of points of  $G$  which are exactly distance  $r$  from  $\text{C}\Lambda_\Lambda(q; r)$ .

*Proof.*

- a) Let  $K$  be a component of  $B_G(\Lambda; r)$ . It will be shown that  $\text{m}_G(K) \geq 2r$ , which establishes that  $\text{ncc}_\Lambda(r)$  is finite, since  $\text{m}_G(G)$  is finite.

First observe that  $K$  must contain some point  $q$  of  $\Lambda$ . For let  $x$  be any point of  $K$ , so that  $d_G(x, q) < r$  for some  $q \in \Lambda$ . Since  $d_G$  is strictly intrinsic (Lemma 1), there is an arc in  $G$  from  $q$  to  $x$  of length  $d_G(x, q)$ , and this arc is contained in  $B_G(\Lambda; r)$ : hence  $q \in K$  as required.

Since  $r < \bar{r}$ , there is some point  $y \in G \setminus B_G(q; r)$ . As  $d_G$  is strictly intrinsic, there is an arc in  $G$  from  $q$  to  $y$  of length at least  $r$ . The initial length  $r$  subarc of this arc has interior contained in  $K$ , so that  $\text{m}_G(K) \geq 2r$  by Lemma 12 d) as required.

If  $r < s$  then  $B_G(\Lambda; r) \subset B_G(\Lambda; s)$ , so that each connected component of  $B_G(\Lambda; r)$  is contained in a connected component of  $B_G(\Lambda; s)$ . Every component of  $B_G(\Lambda; s)$  contains a point of  $\Lambda$ , and hence contains a component of  $B_G(\Lambda; r)$ . Therefore  $\text{ncc}_\Lambda(r)$  is decreasing.

- b) On any interval bounded away from 0,  $r \mapsto \text{ncc}_\Lambda(r)$  is therefore a bounded decreasing positive integer-valued function, and so has only finitely many discontinuities.

If  $\Lambda$  is finite then  $\text{ncc}_\Lambda(r) = \#\Lambda$  for all sufficiently small  $r$ , so that  $\text{NC}(\Lambda)$  is finite.

If  $\Lambda$  is infinite then for every  $r_0 \in (0, \bar{r})$  pick distinct points  $q_1, q_2 \in \Lambda$  with  $d_G(q_1, q_2) < r_0$ . Let  $(p_1, p_2)_{\overline{\text{C}B_\Lambda(q_1; r_0)}}$  be a complementary component of  $\Lambda$  in  $[q_1, q_2]_{\overline{\text{C}B_\Lambda(q_1; r_0)}}$  (cf. Remark 15 b)), and let  $s = d_G(p_1, p_2)$ . Then  $\text{ncc}_\Lambda(r)$  has a discontinuity at  $r = s/2 < r_0$ . Hence  $\text{NC}(\Lambda)$  is infinite, and therefore consists of a sequence converging to 0.

- c) Let  $r_1 < r < s < r_2$ . As in the proof of a), every connected component of  $B_G(\Lambda; s)$  contains a connected component of  $B_G(\Lambda; r)$ . Since the two sets have the same number of connected components, every connected component of  $B_G(\Lambda; s)$  contains exactly one connected component of  $B_G(\Lambda; r)$ : these two components must therefore contain the same points of  $\Lambda$ .
- d) Write  $C = \text{C}\Lambda_\Lambda(q; r)$ . Let  $x \in G$ . If  $d_G(x, C) < r$  then all points in a neighborhood of  $x$  in  $G$  belong to  $\text{C}B_\Lambda(q; r)$ , and hence  $x$  is not in its boundary  $\text{C}\Lambda_\Lambda(q; r)$ ; similarly if  $d_G(x, C) > r$ .

Suppose, then, that  $d_G(x, C) = r$ , and let  $\gamma$  be an arc of length  $r$  in  $G$  from  $x$  to a point  $q$  of  $C$ . Then  $x \notin \text{CB}_\Lambda(q; r)$ , but points of  $\gamma$  arbitrarily close to  $x$  do belong to  $\text{CB}_\Lambda(q; r)$ , so that  $x$  lies in the boundary  $\text{CC}_\Lambda(q; r)$  of  $\text{CB}_\Lambda(q; r)$  as required.  $\square$

**Definition 30** (Planar radius,  $\text{PR}_\Lambda(q)$ ). A number  $r \in (0, \bar{r})$  is said to be a  $(q, \Lambda)$ -planar radius if  $r \notin \text{NC}(\Lambda)$  and all of the points of  $\text{CC}_\Lambda(q; r)$  are planar points. The set of  $(q, \Lambda)$ -planar radii is denoted  $\text{PR}_\Lambda(q) \subset (0, \bar{r})$ .

*Remark 31.* By Lemma 29 c) and d), if  $(r_1, r_2)$  is a complementary component of  $\text{NC}(\Lambda)$  and  $q \in \Lambda$ , then  $\text{CA}_\Lambda(q; r)$  is constant for  $r \in (r_1, r_2)$ , and if  $q' \in \text{CA}_\Lambda(q; r)$  then  $\text{PR}_\Lambda(q') \cap (r_1, r_2) = \text{PR}_\Lambda(q) \cap (r_1, r_2)$ .

**Lemma 32.** *Let  $q \in \Lambda$ . Then  $\text{PR}_\Lambda(q)$  is a full measure open subset of  $(0, \bar{r})$ , and  $\text{cn}_\Lambda(q; r)$  is finite and constant on each component of  $\text{PR}_\Lambda(q)$ .*

*Proof.* Since  $\text{NC}(\Lambda)$  is either finite or a sequence converging to zero, it suffices to prove the statement in each complementary component  $(r_1, r_2)$  of  $\text{NC}(\Lambda)$  in  $(0, \bar{r})$ .

For  $r \in (r_1, r_2)$ ,  $C = \text{CA}_\Lambda(q; r)$  is a fixed compact subset of  $G$  with  $\text{m}_G(C) = 0$ , and  $\text{CC}_\Lambda(q; r)$  is the set of points of  $G$  which are distance  $r$  from  $C$  (Lemma 29). Define  $f: G \rightarrow \mathbb{R}$  by  $f(x) = d_G(x, C)$ : then the set of  $(q, \Lambda)$ -non-planar radii in  $(r_1, r_2)$  is given by  $(r_1, r_2) \cap f(\bar{V})$ . Since  $f$  is continuous and  $\bar{V}$  is compact, the set of  $(q, \Lambda)$ -non-planar radii is a closed subset of  $(r_1, r_2)$ . Moreover,  $f$  is distance non-increasing and  $\mu_G^1(\bar{V}) = 0$  by Lemma 12, so that  $f(\bar{V})$  has zero 1-dimensional Hausdorff measure (i.e. Lebesgue measure). Therefore  $\text{PR}_\Lambda(q) \cap (r_1, r_2)$  is a full measure open subset of  $(r_1, r_2)$  as required.

Now let  $r \in \text{PR}_\Lambda(q) \cap (r_1, r_2)$ , and let  $\delta > 0$  be small enough that  $(r - \delta, r + \delta) \subset \text{PR}_\Lambda(q)$ . Then for each  $x \in \text{CC}_\Lambda(q; r)$ , the ball  $I_x = B_G(x; \delta)$  consists entirely of planar points of  $G$ , and is therefore isometric to an interval of length  $2\delta$ . Now  $\overline{\text{CB}_\Lambda(q; r)}$  is a dendrite and  $d_G$  is strictly intrinsic, so  $I_x$  cannot contain any other point of  $\text{CC}_\Lambda(q; r)$ . Since  $\text{m}_G(I_x) = 4\delta$ ,  $\text{cn}_\Lambda(q; r) = \#\text{CC}_\Lambda(q; r)$  is finite as required.

If  $r' \in (r - \delta, r + \delta)$  then each  $I_x$  contains a point of  $\text{CC}_\Lambda(q; r')$  (at distance  $|r' - r|$  from  $x$ ), and hence  $\text{cn}_\Lambda(q; r') \geq \text{cn}_\Lambda(q; r)$ . On the other hand, if  $r' \in (r - \delta/4, r + \delta/4)$ , then  $(r' - \delta/2, r' + \delta/2) \subset \text{PR}_\Lambda(q)$ , and by the same argument  $\text{cn}_\Lambda(q; r) \geq \text{cn}_\Lambda(q; r')$ . Therefore  $\text{cn}_\Lambda(q; r)$  is locally constant, and hence constant, on each component of  $\text{PR}_\Lambda(q)$  as required.  $\square$

**4.3.2. Foliated collaring of  $P$ .** Theorems 6 and 7 will be used to show that the conformal structure on  $S \setminus \mathcal{V}^s$  extends across  $\Lambda$ . The system of annuli required by the conditions of Theorem 7 will be constructed in the projection  $Q = \pi(\tilde{Q}) \subset S$  of a foliated collar  $\tilde{Q}$  of  $P$ , which is described in this section. For simplicity of notation it will be assumed that  $P$  has a single component: if  $P$  has several components, the collar can be constructed in each of them independently. It will also be assumed that the paper-folding scheme is plain, so that the paper surface is a topological sphere: since all of the constructions of annuli are carried out locally on a scale smaller than the injectivity radius  $\bar{r}$ , only minor modifications are needed in the non-plain case. The construction here is identical to that of [5], but is included for completeness.

$\tilde{Q}$  is constructed as a union of trapezoids whose bases are the sides of  $P$ ; whose vertical sides bisect the angles at the vertices of  $P$ ; and which have fixed height  $\bar{h}$ , chosen small enough that the trapezoids are far from degenerate and intersect only along their vertical sides. It has a *horizontal foliation* by leaves parallel to  $\partial P$ , and a *vertical foliation* by leaves joining the base and the top of each trapezoid: see Figure 4.

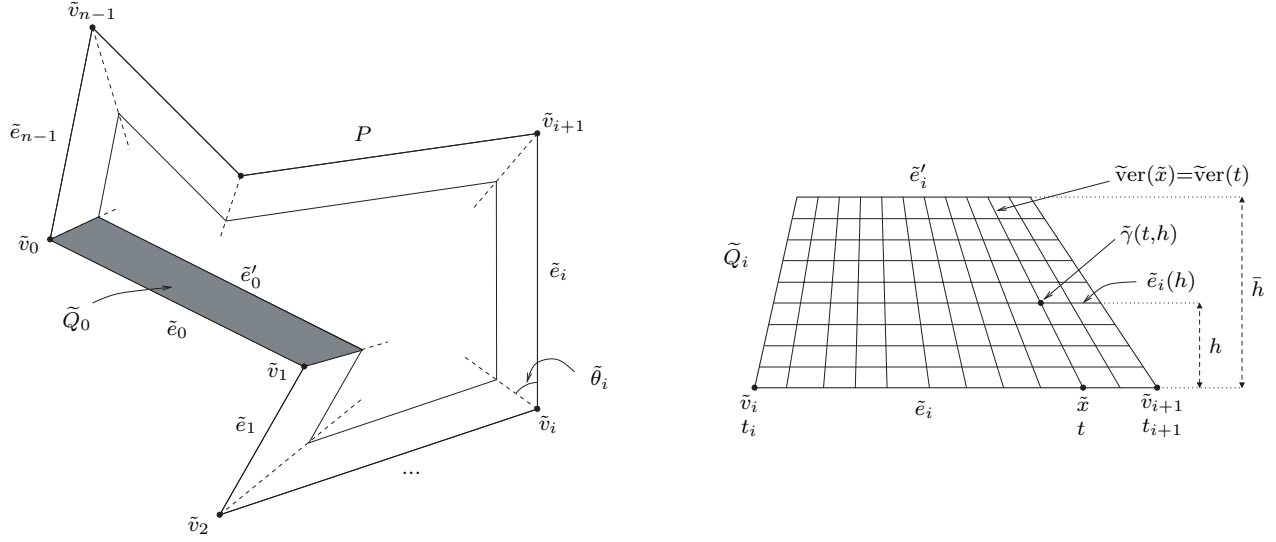

FIGURE 4. The collar  $\tilde{Q}$  and its foliations

Choose a labeling  $\tilde{v}_i$  ( $i = 0, \dots, n-1$ ) of the vertices of  $P$  listed counterclockwise around  $\partial P$ , and let  $\tilde{e}_i$  be the side of  $P$  with endpoints  $\tilde{v}_i$  and  $\tilde{v}_{i+1}$  (here and throughout, subscripts on cyclically ordered objects are taken mod  $n$ ). Write  $L = |\partial P|$ , and let  $\tilde{\gamma}_0: [0, L] \rightarrow \partial P$  be the order-preserving parameterization of  $\partial P$  by arc-length with  $\tilde{\gamma}_0(0) = \tilde{v}_0$ . Denote by  $t_i \in [0, L]$  the parameter with  $\tilde{\gamma}_0(t_i) = \tilde{v}_i$ .

A *trapezoid* is a quadrilateral in  $\mathbb{C}$  with two parallel sides, which are called its *base* and its *top*; the other sides are called *vertical sides*. The *height* of the trapezoid is the distance between the parallel lines containing its base and its top.

Pick a height  $\bar{h}$  small enough that the trapezoids  $\tilde{Q}_i$  which have bases  $\tilde{e}_i$ , heights  $\bar{h}$ , and vertical sides along the rays bisecting the internal angles of  $P$  satisfy:

- The lengths of the tops of the trapezoids are between half and twice the lengths of their bases; and
- The trapezoids intersect only along their vertical sides.

This height  $\bar{h}$  is an important quantity in the construction, and will remain fixed throughout the remainder of the section. Denote the top of  $\tilde{Q}_i$  by  $\tilde{e}'_i$ , and let  $\tilde{\theta}_i$  be half of the internal angle of  $\partial P$  at  $\tilde{v}_i$ : thus the internal angles of  $\tilde{Q}_i$  at the endpoints of its base are  $\tilde{\theta}_i$  and  $\tilde{\theta}_{i+1}$ .

Let

$$\tilde{Q} = \bigcup_{i=0}^{n-1} \tilde{Q}_i,$$



a closed collar neighborhood of  $\partial P$  in  $P$ .

For each  $h \in [0, \bar{h}]$ , let  $\tilde{e}_i(h) \subset \tilde{Q}_i$  be the segment parallel to the base of  $\tilde{Q}_i$  at height  $h$ , so that  $\tilde{e}_i(0) = \tilde{e}_i$  and  $\tilde{e}_i(\bar{h}) = \tilde{e}'_i$ . Then, for each  $h$ , the union  $\tilde{\text{hor}}(h)$  of these segments is a polygonal simple closed curve: these simple closed curves are the leaves of the *horizontal foliation*

$$\tilde{\text{Hor}} = \left\{ \tilde{\text{hor}}(h) : h \in [0, \bar{h}] \right\}$$

of  $\tilde{Q}$ . The parameter  $h$  is called the *height* of the leaf  $\tilde{\text{hor}}(h)$ .

Write

$$\tilde{Q}(h) = \bigcup_{h' \in [0, h]} \tilde{\text{hor}}(h'),$$

the subset of  $\tilde{Q}$  consisting of leaves with heights not exceeding  $h$ : therefore  $\tilde{Q}(h) \subset \tilde{Q} = \tilde{Q}(\bar{h})$  is also a closed collar neighborhood of  $\partial P$  for each  $h \in (0, \bar{h}]$ .

To construct the vertical foliation, let  $\varphi_i: \tilde{e}_i \rightarrow \tilde{e}'_i$  be the orientation-preserving scaling from  $\tilde{e}_i$  to  $\tilde{e}'_i$ . For each  $\tilde{x} = \tilde{\gamma}_0(t) \in \tilde{e}_i$ , denote by  $\tilde{\text{ver}}(\tilde{x})$  or  $\tilde{\text{ver}}(t)$  the straight line segment which joins  $\tilde{x}$  to  $\varphi_i(\tilde{x})$ . These segments are the leaves of the *vertical foliation*

$$\tilde{\text{Ver}} = \{ \tilde{\text{ver}}(t) : t \in [0, L] \}$$

of  $\tilde{Q}$ .

Define  $\tilde{\theta}: [0, L] \setminus \{t_0, \dots, t_{n-1}\} \rightarrow (0, \pi)$  by setting  $\tilde{\theta}(t)$  to be the angle between  $\partial P$  and  $\tilde{\text{ver}}(t)$  at  $\tilde{\gamma}_0(t)$ : that is, the angle between the oriented side of  $\partial P$  containing  $\tilde{\gamma}_0(t)$  and the leaf  $\tilde{\text{ver}}(t)$  pointing into  $P$ . This function has well-defined limits as  $t$  approaches each  $t_i$  from the left or the right:  $\tilde{\theta}(t_i^-) = \pi - \tilde{\theta}_i$ , and  $\tilde{\theta}(t_i^+) = \tilde{\theta}_i$ . The notation  $\tilde{\theta}(\tilde{x}) = \tilde{\theta}(t)$  will also be used when  $\tilde{x} = \tilde{\gamma}_0(t)$ .

The foliations  $\tilde{\text{Hor}}$  and  $\tilde{\text{Ver}}$  yield a parameterization

$$\tilde{\gamma}: [0, L] \times [0, \bar{h}] \rightarrow \tilde{Q}$$

of  $\tilde{Q}$ , where  $\tilde{\gamma}(t, h)$  is the unique point of  $\tilde{\text{ver}}(t) \cap \tilde{\text{hor}}(h)$ .

For each  $h \in (0, \bar{h}]$ , denote by  $\tilde{\psi}_h: \tilde{Q}(h) \rightarrow \partial P$  the retraction of  $\tilde{Q}(h)$  onto  $\partial P$  which slides each point along its vertical leaf:

$$\tilde{\psi}_h(\tilde{\gamma}(t, h')) = \tilde{\gamma}(t, 0) \quad (\text{all } t \in [0, L] \text{ and } h' \in [0, h]).$$

In particular,  $\tilde{\psi}_{\bar{h}}$  is a retraction which squashes all of  $\tilde{Q}$  onto  $\partial P$ .

The projections to the paper surface  $S$  of the structures defined above are denoted by removing tildes. Thus  $Q = \pi(\tilde{Q})$  is a closed disk neighborhood of the scar  $G$ , which is a dendrite by the plainness hypothesis and Theorem 14; and similarly  $Q(h) = \pi(\tilde{Q}(h))$  is a closed subdisk neighborhood for each  $h \in (0, \bar{h}]$ .  $Q$  has horizontal and vertical foliations  $\text{Hor} = \pi(\tilde{\text{Hor}})$  and  $\text{Ver} = \pi(\tilde{\text{Ver}})$ . The leaves of  $\text{Hor}$  are projections of leaves of  $\tilde{\text{Hor}}$ ,  $\text{hor}(h) = \pi(\tilde{\text{hor}}(h))$ : these are topological circles except for  $\text{hor}(0) = G$ . The leaves of  $\text{Ver}$ , however, are unions of projections of leaves of  $\tilde{\text{Ver}}$ : for each  $x \in G$ , the leaf of  $\text{Ver}$  containing  $x$  is defined to be

$$\text{ver}(x) := \bigcup \{ \pi(\tilde{\text{ver}}(\tilde{x})) : \tilde{x} \in \pi^{-1}(x) \}.$$

Thus  $\text{ver}(x)$  is an arc if and only if  $\#\pi^{-1}(x) \leq 2$ . If  $x$  is a  $k$ -vertex for  $k > 2$  then  $\text{ver}(x)$  is a star with  $k$  branches.

The disks  $Q(h)$  for  $0 < h \leq \bar{h}$  are similarly foliated by horizontal leaves  $\text{hor}(h')$  with  $0 < h' \leq h$ , and vertical leaves  $\text{ver}_h(x)$ , which are the leaves  $\text{ver}(x)$  trimmed at their intersection with  $\text{hor}(h)$ .

The composition  $\gamma := \pi \circ \tilde{\gamma}: [0, L] \times [0, \bar{h}] \rightarrow Q$  parameterizes  $Q$ , although it is not injective on the preimage of  $G$ .

Because the retractions  $\tilde{\psi}_h: \tilde{Q}(h) \rightarrow \partial P$  fix  $\partial P$  pointwise, the compositions

$$\psi_h := \pi \circ \tilde{\psi}_h \circ \pi^{-1}: Q(h) \rightarrow G$$

are well-defined retractions of  $Q(h)$  onto  $G$ .

**4.3.3. The system of annuli  $\text{Ann}_\Lambda(q; r, s)$ .** In this section annuli  $\text{Ann}_\Lambda(q; r, s)$  about  $q$  will be constructed for each pair of  $(q, \Lambda)$ -planar radii  $r < s$ . The annuli will be defined as differences of two topological closed disks:  $\text{Ann}_\Lambda(q; r, s) = \text{Int}(D_\Lambda(q; s)) \setminus D_\Lambda(q; r)$ .

The parameter  $r$  in the disk  $D_\Lambda(q; r)$  is related to the trimmed vertical leaves which it contains:  $\psi_{\bar{h}}(D_\Lambda(q; r)) = \overline{\text{CB}_\Lambda(q; r)}$ . A second parameter  $h$  could be used to specify the horizontal leaves which intersect  $D_\Lambda(q; r)$ , but it is convenient to make this parameter dependent on  $r$ , via the function  $h: [0, \bar{r}] \rightarrow [0, \bar{h}/2]$  defined by

$$h(r) := \left( \frac{\bar{h}}{2\bar{r}} \right) r.$$

**Definition 33** ( $D_\Lambda(q; r)$ ). Let  $q \in \Lambda$  and  $r \in (0, \bar{r})$ . The subset  $D_\Lambda(q; r)$  of  $Q$  is defined by

$$D_\Lambda(q; r) := \psi_{h(r)}^{-1} \left( \overline{\text{CB}_\Lambda(q; r)} \right).$$

Alternatively,  $D_\Lambda(q; r)$  is the intersection of  $Q(h(r))$  with the union of the vertical leaves  $\text{ver}(x)$  with  $x \in \overline{\text{CB}_\Lambda(q; r)}$ .

*Remark 34.* For all  $q \in \Lambda$ ,  $\bigcap_{r \in (0, \bar{r})} D_\Lambda(q; r) = \bigcap_{r \in (0, \bar{r})} \overline{\text{CB}_\Lambda(q; r)} = \{q\}$ . For let  $\varepsilon > 0$ , and let  $(r_1, r_2) \subset \text{PR}_\Lambda(q) \cap (0, \varepsilon)$ , where  $0 < r_1 < r_2 < \varepsilon$ . Then  $\text{CB}_\Lambda(q; (r_2 - r_1)/2)$  does not contain any point  $x$  with  $d_G(q, x) > \varepsilon$ . ( $\frac{r_2 - r_1}{2}$ -balls about points of  $\Lambda$  further than  $r_2$  from  $q$  cannot intersect those about points closer than  $r_1$  from  $q$ .)

**Lemma 35.** Let  $q \in \Lambda$  and  $r \in (0, \bar{r})$  be a  $(q, \Lambda)$ -planar radius. Write  $n = \text{cn}_\Lambda(q; r)$  and  $h = h(r)$ . Then  $D_\Lambda(q; r)$  is a topological closed disk, whose boundary is composed of  $n$  disjoint subarcs of the horizontal leaf  $\text{hor}(h)$ , and the  $n$  trimmed vertical leaves  $\text{ver}_h(x)$  with  $x \in \text{CC}_\Lambda(q; r)$ .

*Proof.* (See Figure 5.)  $n$  is finite by Lemma 32. Write  $\text{CC}_\Lambda(q; r) = \{x_0, \dots, x_{n-1}\}$ . The first step is to show that

$$\partial_{Q(h)} D_\Lambda(q; r) = \psi_h^{-1}(\text{CC}_\Lambda(q; r)) = \bigcup_{i=0}^{n-1} \psi_h^{-1}(x_i) = \bigcup_{i=0}^{n-1} \text{ver}_h(x_i).$$

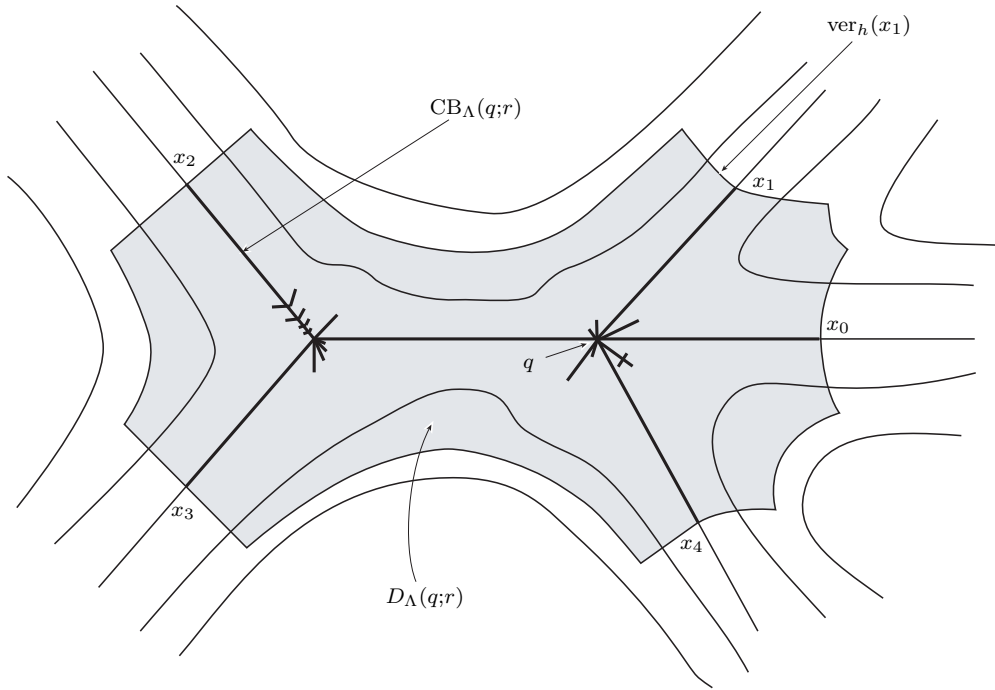
 FIGURE 5. The disk  $D_\Lambda(q; r)$ 

That  $\partial_{Q(h)} D_\Lambda(q; r) \subset \psi_h^{-1}(\overline{CC_\Lambda(q; r)})$  is immediate from the definition of  $D_\Lambda(q; r)$  (recall that  $D_\Lambda(q; r) = \psi_h^{-1}(\overline{CB_\Lambda(q; r)})$  and  $CC_\Lambda(q; r) = \partial_G CB_\Lambda(q; r)$ ). The opposite inclusion follows from the fact that  $r$  is  $(q, \Lambda)$ -planar, so that every neighborhood of each point of  $CC_\Lambda(q; r)$  contains both points which are closer to  $q$  and points which are further away (cf. the proof of Lemma 32).

Since the points  $x_i$  are planar, each  $\psi_h^{-1}(x_i) = \text{ver}_h(x_i)$  is an arc which intersects  $\text{hor}(h) = \partial_S Q(h)$  exactly at its endpoints: that is, a cross cut in  $Q(h)$ . For each  $i$ ,  $Q(h) \setminus \text{ver}_h(x_i)$  has exactly two components, one of which intersects  $G$  in the complement of  $\overline{CB_\Lambda(q; r)}$ . Therefore every  $\text{ver}_h(x_j)$  with  $j \neq i$  is contained in the same component as  $q$ . It follows that  $\partial_S D_\Lambda(q; r)$  is the simple closed curve composed of the arcs  $\text{ver}_h(x_i)$  and the  $n$  subarcs of  $\text{hor}(h)$  joining the endpoints of consecutive cross cuts in the cyclic order around  $\text{hor}(h)$ .  $\square$

The annuli which will be used in the proof of Theorem 19 can now be defined.

**Definition 36** ( $\text{Ann}_\Lambda(q; r, s)$ ). Let  $q \in \Lambda$ , and  $r, s \in \text{PR}_\Lambda(q)$  with  $r < s$ . The subset  $\text{Ann}_\Lambda(q; r, s)$  of  $Q$  is defined by

$$\text{Ann}_\Lambda(q; r, s) = \text{Int}(D_\Lambda(q; s)) \setminus D_\Lambda(q; r).$$

By Lemma 35, and since  $D_\Lambda(q; r) \subset \text{Int}(D_\Lambda(q; s))$ ,  $\text{Ann}_\Lambda(q; r, s)$  is an open annular region with  $q$  in its bounded complementary component (the complementary component not containing  $\partial Q$ ).

The following definition and theorem provide a lower bound on the modules of these annuli.

**Definition 37** (Paper-folding goodness function). Let  $(P, \mathcal{P})$  be a surface paper-folding scheme and  $\Lambda$  be a clopen subset of  $\mathcal{V}^s$ . Define  $\iota_\Lambda : \Lambda \times (0, \bar{r}) \rightarrow [0, \infty)$  by

$$\iota_\Lambda(q; r) = \begin{cases} \frac{M}{\text{cm}_\Lambda(q; r) + r \cdot \text{cn}_\Lambda(q; r)} & \text{if } \text{cn}_\Lambda(q; r) < \infty, \\ 0 & \text{otherwise,} \end{cases}$$

where  $M = \frac{1}{5} \min(\bar{r}/\bar{h}, \bar{h}/\bar{r})$ .  $\iota_\Lambda$  is called a *paper-folding goodness function* for  $(P, \mathcal{P})$  on  $\Lambda$ .

*Remark 38.* By Lemma 32, the set of radii  $r \in (0, \bar{r})$  at which  $\iota_\Lambda(q; r) = 0$  or  $\iota_\Lambda(q; r)$  is discontinuous is disjoint from  $\text{PR}_\Lambda(q)$ , and therefore has measure zero.

*Remark 39.* Since  $\text{cm}_\Lambda(q; r) = \text{m}_G(\text{CB}_\Lambda(q; r)) \geq \text{m}_G(B_G(q; r)) \geq 2r$  for  $r \in (0, \bar{r})$ ,  $\iota_\Lambda(q; r)$  is bounded above by  $M/2r$ .

**Theorem 40.** Let  $q \in \Lambda$  and  $r, s \in \text{PR}_\Lambda(q)$  with  $r < s$ . Then

$$\text{mod Ann}_\Lambda(q; r, s) \geq \int_r^s \iota_\Lambda(q; t) dt.$$

*Sketch proof.* The proof is analogous to that in [5] for the case where  $\Lambda$  consists of a single isolated singularity: a sketch of the main ideas is given here.

Let  $(r_1, r_2)$  be contained in the full measure open subset  $\text{PR}_\Lambda(q)$  of  $(0, \bar{r})$ . As  $r$  increases through  $(r_1, r_2)$ , the set  $\text{CB}_\Lambda(q; r)$  changes regularly: if  $r_1 < r < s < r_2$ , then  $\text{CB}_\Lambda(q; s) \setminus \text{CB}_\Lambda(q; r)$  is a union of  $n = \text{cn}_\Lambda(q; r)$  disjoint intervals of length  $s - r$  which are disjoint from  $\bar{V}$ .

It follows that the disk  $D_\Lambda(q; r)$  also changes regularly for  $r \in (r_1, r_2)$ , and using the foliations of  $Q$  it is possible to obtain an upper bound for the rate of change of the Euclidean area of  $D_\Lambda(q; r)$ ,

$$\frac{d}{dr} \text{Area}_S(D_\Lambda(q; r)) \leq \frac{5\bar{h}}{4\bar{r}} (\text{cm}_\Lambda(q; r) + r \cdot \text{cn}_\Lambda(q; r)).$$

Similarly, the distance between the boundary components of  $\text{Ann}_\Lambda(q; r, s)$  can be estimated for  $r_1 < r < s < r_2$ :

$$d_S(\partial D_\Lambda(q; r), \partial D_\Lambda(q; s)) \geq C(s - r),$$

where  $C = \frac{1}{2} \min(\bar{h}/\bar{r}, 1)$ .

Now if  $r_1 = s_0 < s_1 < \dots < s_k = r_2$  is a partition of  $[r_1, r_2]$ , it follows from Theorem 3 and (1) that

$$\begin{aligned} \text{mod Ann}_\Lambda(q; r_1, r_2) &\geq \sum_{j=1}^k \text{mod Ann}_\Lambda(q; s_{j-1}, s_j) \\ &\geq \sum_{j=1}^k \frac{C^2 (s_j - s_{j-1})^2}{\text{Area}_S(D_\Lambda(q; s_j)) - \text{Area}_S(D_\Lambda(q; s_{j-1}))}. \end{aligned}$$

Taking a limit over increasingly fine partitions gives

$$\text{mod Ann}_\Lambda(q; r_1, r_2) \geq \int_{r_1}^{r_2} \frac{C^2 dt}{\frac{d}{dt} \text{Area}_S(D_\Lambda(q; t))} \geq \int_{r_1}^{r_2} \iota_\Lambda(q; t) dt.$$

That the same bound holds for arbitrary  $r_1, r_2 \in \text{PR}_\Lambda(q)$  follows from additivity of the module and the fact that  $\text{PR}_\Lambda(q)$  is a full measure open subset of  $(0, \bar{r})$ .  $\square$

4.3.4. *Proof of Theorem 19.* By Lemma 29 b),  $\text{NC}(\Lambda) = \{r_k : k \geq 1\}$  where  $(r_k)$  is a decreasing sequence converging to 0 if  $\Lambda$  is infinite, and is finite if  $\Lambda$  is finite: in the finite case, extend  $\text{NC}(\Lambda)$  arbitrarily to a set of the form  $\{r_k : k \geq 1\}$ , where  $(r_k)$  is a decreasing sequence in  $(0, \bar{r})$  converging to 0.

Let  $k \geq 1$ . By Remark 28 and Lemma 29 c), there is an equivalence relation  $\sim_k$  on  $\Lambda$  whose classes  $[q]_k$  are equal to  $\text{C}\Lambda_\Lambda(q; r)$  for all  $r \in (r_{k+1}, r_k)$ : there are  $n_k = \text{ncc}_\Lambda(r_k)$  such classes. The set  $\text{PR}_\Lambda(q) \cap (r_{k+1}, r_k)$  of  $(q, \Lambda)$ -planar radii in  $(r_{k+1}, r_k)$  is a full measure open subset of  $(r_{k+1}, r_k)$  which is well defined on equivalence classes, by Remark 31 and Lemma 32.

The idea of the proof is to obtain lower bounds on the modules of the annuli  $\text{Ann}_\Lambda(q; r_{k+1}, r_k)$ , but since  $r_{k+1}$  and  $r_k$  are not  $(q, \Lambda)$ -planar radii, it is necessary first to increase  $r_{k+1}$  and decrease  $r_k$  by a controlled amount  $\varepsilon_k([q]_k) > 0$ . This number is chosen so that both  $r_{k+1} + \varepsilon_k([q]_k)$  and  $r_k - \varepsilon_k([q]_k)$  belong to  $\text{PR}_\Lambda(q)$ , and small enough that

$$\varepsilon_k([q]_k) \leq \min \left( \frac{r_{k+1}}{2^{k-1}M}, \frac{r_k - r_{k+1}}{3} \right).$$

Define an annulus  $\text{Ann}_k([q]_k)$  for each  $[q]_k \in \Lambda / \sim_k$  by

$$\text{Ann}_k([q]_k) = \text{Ann}_\Lambda(q; r_{k+1} + \varepsilon_k([q]_k), r_k - \varepsilon_k([q]_k))$$

(see Figure 6).

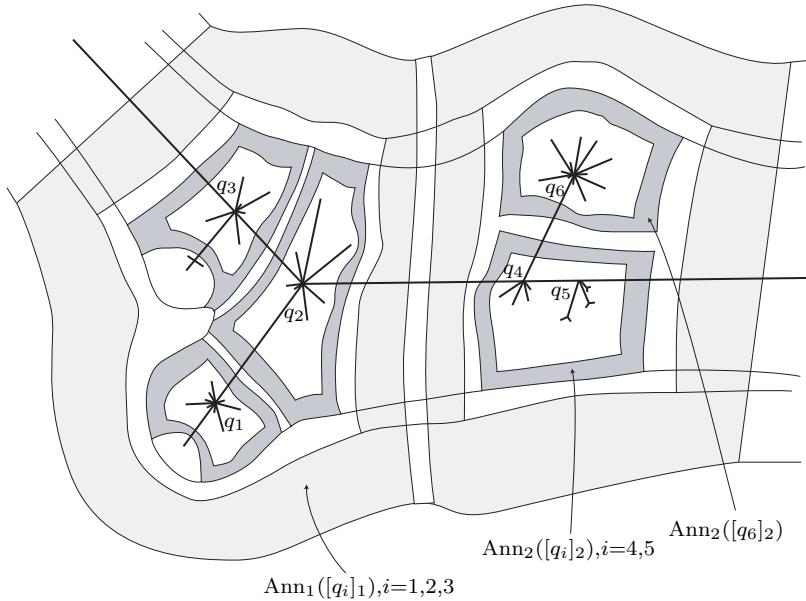

FIGURE 6. The annuli  $\text{Ann}_k([q]_k)$

It follows from Theorem 40 and Remark 39 that

$$\begin{aligned} \text{mod Ann}_k([q]_k) &\geq \int_{r_{k+1}+\varepsilon_k([q]_k)}^{r_k-\varepsilon_k([q]_k)} \iota_\Lambda(q; t) \, dt \\ &\geq \int_{r_{k+1}}^{r_k} \iota_\Lambda(q; t) \, dt - \frac{2\varepsilon_k([q]_k)M}{2r_{k+1}} \\ &\geq \int_{r_{k+1}}^{r_k} \iota_\Lambda(q; t) \, dt - \frac{1}{2^{k-1}}. \end{aligned}$$

In particular, if (2) holds then  $\sum_{k \geq 1} \text{mod Ann}_k([q]_k)$  diverges for all  $q \in \Lambda$ .

Observe the following properties of these annuli:

a) The  $n_k$  annuli  $\text{Ann}_k([q]_k)$  are mutually disjoint, since

$$\text{Ann}_k([q]_k) \subset D_\Lambda(q; r_k - \varepsilon([q]_k)) \subset \psi_{h(r_k)}^{-1}(\text{CB}_\Lambda(q; r_k)),$$

and  $\text{CB}_\Lambda(q_1; r_k) \cap \text{CB}_\Lambda(q_2; r_k) = \emptyset$  unless  $q_1 \sim_k q_2$ .

b) All of the points of  $[q]_k$  are contained in the bounded complementary component  $D_\Lambda(q; r_{k+1} + \varepsilon([q]_k))$  of  $\text{Ann}_k([q]_k)$ , and all of the points of  $\Lambda \setminus [q]_k$  are contained in the unbounded complementary component.

c)  $\text{Ann}_{k+1}([q]_{k+1})$  is nested into  $\text{Ann}_k([q]_k)$  for each  $q \in \Lambda$  and  $k \geq 1$ .

d) Let  $(q_k)$  be any sequence in  $\Lambda$  with the property that  $\text{Ann}_k([q_k]_k)$  is a nested sequence of annuli. Then there is a unique  $q \in \Lambda$  such that  $\text{Ann}_k([q_k]_k) = \text{Ann}_k([q]_k)$  for all  $k$ . For the sequence of bounded complementary components contains at least one point  $q \in S$  in its intersection. This point must lie in  $G$  since the sequence of inner heights of the annuli converges to zero; and it must lie in  $\Lambda$  since  $\Lambda$  is a closed subset of  $G$  and the sequence of inner radii of the annuli converges to zero. Then since  $q \in \Lambda$  lies in the bounded complementary component of every  $\text{Ann}_k([q_k]_k)$ , it follows from b) above that  $q \sim_k q_k$  for all  $k$ .

The proof of Theorem 19 can now be completed. Let  $q \in \Lambda$ . Since  $\Lambda$  is clopen in  $\mathcal{V}^s$ , there is some  $r \in \text{PR}_\Lambda(q)$  with  $D_\Lambda(q; r) \cap \mathcal{V}^s \subset \Lambda$ , and it suffices to show that the conformal structure on  $S \setminus \mathcal{V}^s$  extends uniquely over  $D_\Lambda(q; r)$ .

Let  $W = D_\Lambda(q; r) \setminus \Lambda$ . Then  $W$  is a planar Riemann surface, and so by Koebe's General Uniformization Theorem there is a uniformizing isomorphism  $\phi: W \rightarrow \phi(W)$  of  $W$  onto a domain  $\phi(W) \subset \mathbb{C}$ .

Let  $K$  be such that  $r_K < r$ . Pick any  $q' \in D_\Lambda(q; r) \cap \Lambda$ , and write  $A_k(q') = \phi(\text{Ann}_k([q']_k))$  for each  $k \geq K$ . Then  $\sum_{k \geq K} \text{mod } A_k(q')$  diverges by (2) and the argument above, so that the intersection of the bounded complementary components of the  $A_k(q')$  is a single point  $z(q')$ . Defining  $\phi(q') = z(q')$  for each  $q' \in D_\Lambda(q; r) \cap \Lambda$  extends  $\phi$  to a homeomorphism from  $D_\Lambda(q; r)$  into  $\mathbb{C}$ .

For  $k \geq K$ , define  $U_k = \bigcup_{q' \in D_\Lambda(q; r) \cap \Lambda} A_k(q')$ . Then the sets  $U_k$  satisfy the hypotheses of Theorem 7 by properties a) to d) above, so that  $\phi(\Lambda)$  is a totally disconnected set of absolute area zero. Hence if  $\psi: W \rightarrow \psi(W)$  is a second choice of uniformizing isomorphism on  $W$ , then  $\psi \circ \phi^{-1}$  extends uniquely across  $\phi(\Lambda)$  to a conformal map on  $\phi(D_\Lambda(q; r))$  by Theorem 6. There is therefore a uniquely defined conformal structure in  $D_\Lambda(q; r)$  which agrees with the given conformal structure on  $D_\Lambda(q; r) \setminus \Lambda$ .  $\square$

## 5. MODULUS OF CONTINUITY

Suppose that  $(P, \mathcal{P})$  is a plain paper-folding scheme with associated paper surface  $S$ , which is a topological sphere by Theorem 14; and that condition (2) holds at every point  $q$  of  $\Lambda = \mathcal{V}^s$ , so that  $S$  has a unique conformal structure which agrees with the natural conformal structure on  $S \setminus \mathcal{V}^s$ . It follows that  $S$  is conformally isomorphic to the Riemann sphere  $\widehat{\mathbb{C}}$ . The aim in this section is to construct an explicit modulus of continuity for a suitably normalized uniformizing map  $u: S \rightarrow \widehat{\mathbb{C}}$ . This modulus of continuity depends only on the geometry of  $P$  (specifically, on  $|\partial P|$  and on the collaring height  $\bar{h}$ ), and on the metric on  $G$ , as expressed by the injectivity radius  $\bar{r}$  and the paper-folding goodness function  $\iota_\Lambda$  (and an alternative version of this function for non-singular points which is described in Section 5.1).

The motivation for doing this is that when there is a uniform modulus of continuity across a family of such paper-folding schemes, it is possible to use Arzelà-Ascoli type arguments to construct a limiting complex sphere.

After some preliminaries in Section 5.1, a local modulus of continuity for  $u$  is obtained at each point of  $S$  (with respect to the metric  $d_S$  on  $S$  and the spherical metric  $d_{\widehat{\mathbb{C}}}$  on  $\widehat{\mathbb{C}}$ ) in Section 5.2. In Section 5.3 it is shown that these local moduli of continuity patch together to give a global modulus of continuity for  $\phi := u \circ \pi: P \rightarrow \widehat{\mathbb{C}}$ .

*Remark 41.* Because the local modulus of continuity derived in Section 5.2 arises from a *local* calculation, it applies equally to a uniformizing map from a disk neighborhood of a point of  $S$  to the unit disk in  $\mathbb{C}$  for an arbitrary Riemann paper surface.

**5.1. Preliminaries.** The following assumptions are made throughout Section 5:

- $(P, \mathcal{P})$  is a plain paper-folding scheme with associated paper sphere  $S$  and scar  $G$ .
- $\bar{h} > 0$  denotes a fixed choice of collaring height for  $P$  (Section 4.3.2).
- $\Lambda = \mathcal{V}^s$ , the singular set of  $G$ , and condition (2) holds at every point  $q \in \Lambda$ .
- $\bar{r} > 0$  denotes a fixed choice of injectivity radius for  $\Lambda$  (Definition 25).

In particular,  $S$  is conformally isomorphic to the Riemann sphere  $\widehat{\mathbb{C}}$ . A fixed choice of uniformizing map  $u: S \rightarrow \widehat{\mathbb{C}}$  is made as follows. Pick points  $\tilde{p}_0 \in \partial P$  and  $\tilde{p}_\infty \in P_{\bar{h}}$  (recall that  $P_{\bar{h}}$  is the complement in  $P$  of the height  $\bar{h}$  collaring  $\tilde{Q}(\bar{h})$  of  $P$ ). Let  $p_0 := \pi(\tilde{p}_0) \in G$  and  $p_\infty := \pi(\tilde{p}_\infty) \in S \setminus Q(\bar{h})$ , and define  $u: S \rightarrow \widehat{\mathbb{C}}$  to be the isomorphism with the following normalization:

- $u(p_0) = 0$ ;
- $u(p_\infty) = \infty$ ; and
- the reciprocal  $\Phi := 1/\phi$  of the composition  $\phi := u \circ \pi: P \rightarrow \widehat{\mathbb{C}}$  satisfies  $\Phi'(\tilde{p}_\infty) = 1$ .

**Definition 42** (Modulus of continuity). Let  $\rho: [0, \varepsilon) \rightarrow [0, \infty)$ , for some  $\varepsilon > 0$ , be a continuous and strictly increasing function with  $\rho(0) = 0$ . A function  $f: (X, d_X) \rightarrow (Y, d_Y)$  between metric spaces has *modulus of continuity*  $\rho$  at  $x_0 \in X$  if, for every  $x \in X$  with  $d_X(x_0, x) < \varepsilon$ ,

$$d_Y(f(x_0), f(x)) \leq \rho(d_X(x_0, x)).$$

$f$  is said to have *global modulus of continuity*  $\rho$  if this inequality holds for every pair of points  $x_0, x \in X$  with  $d_X(x_0, x) < \varepsilon$ .

*Remark 43.* Since the projection  $\pi: P \rightarrow S$  is distance non-increasing, a modulus of continuity  $\rho_q$  for  $u: S \rightarrow \widehat{\mathbb{C}}$  at  $q \in S$  is also a modulus of continuity for the composition  $\phi := u \circ \pi: P \rightarrow \widehat{\mathbb{C}}$  at the points of  $\pi^{-1}(q)$ .

In Section 4, disks  $D_\Lambda(q; r)$ , annuli  $\text{Ann}_\Lambda(q; r, s)$ , and paper-folding goodness functions  $\iota_\Lambda(q; r)$  providing a lower bound on the modules of the annuli were constructed depending on the set  $\Lambda$ . The only properties of the set  $\Lambda$  which were used in the constructions were that it is a closed subset of  $G$  with zero measure. In particular, the constructions can be repeated with  $\Lambda = \{q\}$ , where  $q$  is an arbitrary *non-singular* point of  $G$ . The objects thus constructed are denoted by dropping the subscript  $\Lambda$ : thus  $D(q; r)$  is a disk containing  $q$  for every  $q$ -planar radius  $r \in (0, \bar{r})$ ;  $\text{Ann}(q; r, s)$  is an annular region containing  $q$  in its bounded complementary component for every pair of  $q$ -planar radii  $0 < r < s < \bar{r}$ ; and

$$(3) \quad \text{mod Ann}(q; r, s) \geq \int_r^s \iota(q; t) dt,$$

where

$$\iota(q; r) = \begin{cases} \frac{M}{m(q; r) + r \cdot n(q; r)} & \text{if } n(q; r) < \infty, \\ 0 & \text{otherwise.} \end{cases}$$

Here  $m(q; r) = m_G(B_G(q; r)) = m_G(\text{CB}_{\{q\}}(q; r))$ , and  $n(q; r) = \text{cn}_{\{q\}}(q; r)$  is the number of points of  $G$  at distance exactly  $r$  from  $q$ .

Notice that

$$(4) \quad \int_0^{\bar{r}} \iota(q; s) ds = \infty$$

at any non-singular point  $q$ : for if  $q$  is an isolated valence  $k$  vertex or a planar point ( $k = 2$ ), then  $m(q; s) = 2ks$  and  $n(q; s) = k$  for all sufficiently small  $s$ .

The modulus of continuity for  $u$  at points  $q$  in a particular neighbourhood  $Q(\varepsilon)$  of  $G$  will be obtained by constructing annular regions  $A$  in  $Q(\bar{h})$  for which both  $q$  and a nearby point  $x$  at prescribed distance from  $q$  lie in the same complementary component. An upper bound on  $d_{\widehat{\mathbb{C}}}(u(q), u(x))$  can then be found by combining a lower bound for  $\text{mod } A$  (arising, for example, from Theorem 40) with the upper bound for  $\text{mod } u(A)$  provided by Theorem 4. There are two issues which need to be addressed in doing this:

- a) To find a radius  $R$  with the property that  $u(A)$  is contained in the disk  $|z| \leq R$ , so that Theorem 4 can be applied; and
- b) To relate the distance  $d_S$  in  $S$  with the parameter  $r$  used in the construction of the disks  $D_\Lambda(q; r)$  and  $D(q; r)$ .

The first of these issues is dealt with by the following lemma, which is a simple consequence of Koebe's one-quarter theorem and the normalization of  $u$ .



**Lemma 44.** *There is a constant  $R > 0$ , depending only on  $\bar{h}$ , such that  $u(Q(\bar{h}/2))$  is contained in the disk  $|z| < R$  in  $\mathbb{C}$ .*

□

For the second issue, the following technical lemma, which is proved in [5], is crucial. The distance of a point  $q \in Q(\bar{h})$  from  $G$  and from  $\Lambda$  is described by two numbers  $h_q$  and  $d_q$ :

**Definitions 45** ( $\psi, h_q, d_q$ ). Let  $\psi := \psi_{\bar{h}}$  denote the retraction of  $Q(\bar{h})$  onto  $G$ . Given  $q \in Q(\bar{h})$ , let  $h_q \geq 0$  denote the *height* of  $q$  (that is,  $q$  lies in the horizontal leaf  $\text{hor}(h_q)$ ); and let  $d_q := d_G(\psi(q), \Lambda) \geq 0$ .

Notice that both  $h_q$  and  $d_q$  depend continuously on  $q \in Q(\bar{h})$ .

**Lemma 46.** *Let*

$$(5) \quad \delta = \delta(\bar{r}, \bar{h}, |\partial P|) := \frac{1}{4} \min \left\{ \bar{r}, \bar{h}, \frac{2\bar{r}\bar{h}}{|\partial P|} \right\} > 0,$$

and define  $\mu: Q(\delta) \times [0, \delta] \rightarrow [0, \bar{r}]$  by

$$(6) \quad \mu(q; t) := \frac{\bar{r}}{2\delta}(t + h_q).$$

Then, for every  $q \in Q(\delta)$  and every  $r \in [0, \delta]$ ,

$$\begin{aligned} \overline{B}_S(q; r) &\subset D_\Lambda(\psi(q); \mu(q; r)) && \text{if } \psi(q) \in \Lambda, \\ \overline{B}_S(q; r) &\subset D(\psi(q); \mu(q; r)) && \text{if } \psi(q) \notin \Lambda. \end{aligned}$$

□

See Figure 7: note that it is clear that some result of this form must hold, and the content of Lemma 46 is the specific constants obtained.

In the next section, an explicit modulus of continuity  $\rho_q: [0, \delta/2] \rightarrow [0, \infty)$  will be given for each  $q \in Q(\delta/2)$ . For points  $q$  far from  $G$ , a modulus of continuity is easily obtained by applying Theorem 5 to the reciprocal of  $\phi: \text{Int}(P) \rightarrow \widehat{\mathbb{C}}$ :

**Lemma 47.** *Let  $\tilde{q}, \tilde{x} \in P_{\delta/3} = P \setminus \tilde{Q}(\delta/3)$ . Then*

$$d_{\widehat{\mathbb{C}}}(\phi(\tilde{q}), \phi(\tilde{x})) \leq \kappa d_P(\tilde{q}, \tilde{x}),$$

where

$$\kappa = 2 \exp \left( \frac{24 \text{diam}_{P_{\delta/3}} P_{\delta/3}}{\delta} \right) \leq 2 \exp \left( \frac{48|\partial P|}{\delta} \right).$$

That is,  $\phi$  is Lipschitz in  $P_{\delta/3}$  with a constant which depends only on  $\bar{r}$ ,  $\bar{h}$ , and  $|\partial P|$ .

□

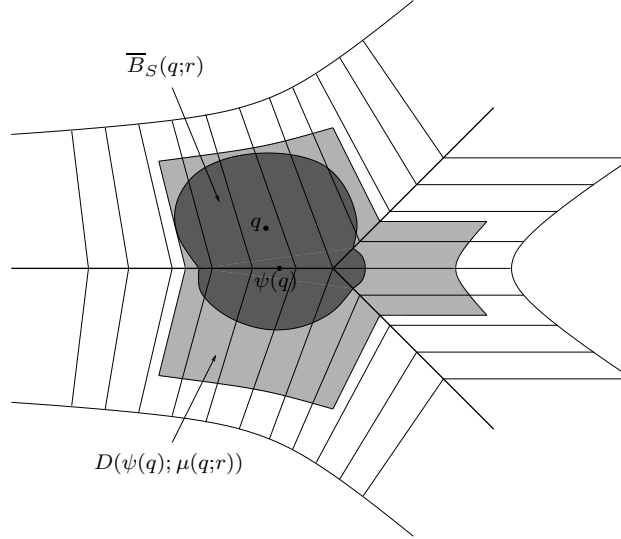

FIGURE 7. The disk  $D(\psi(q); \mu(q; r))$  and the ball  $\overline{B}_S(q; r)$ .

## 5.2. Modulus of continuity at a point.

**Definitions 48** ( $\xi, \lambda, \eta, \alpha, \beta$ ). Define functions  $\xi, \lambda, \eta: Q(\delta/2) \times [0, \delta/2) \rightarrow [0, \infty)$ , and  $\alpha, \beta: Q(\delta/2) \rightarrow [0, \infty)$  by

$$\begin{aligned} \xi(q; t) &= \max(h_q, t), \\ \lambda(q; t) &= \min(\mu(q; \xi(q; t)), d_q), \\ \eta(q; t) &= \max(\mu(q; \xi(q; t)), d_q), \\ \alpha(q) &= \min(2d_q, \bar{r}), \text{ and} \\ \beta(q) &= \max(2d_q, \bar{r}). \end{aligned}$$

The aim of this section is to prove the following theorem, which gives a modulus of continuity for  $u$  at each point  $q \in Q(\delta/2)$ . The expression (7) giving this modulus of continuity is difficult to parse: nevertheless it is amenable to explicit calculation in examples such as Example 51 below.

**Theorem 49.** *Let  $\rho: Q(\delta/2) \times [0, \delta/2) \rightarrow [0, \infty)$  be defined by  $\rho(q; t) := \rho_q(t) = 0$  if  $t = 0$  and, if  $t > 0$ ,*

$$(7) \quad \rho_q(t) := \frac{8Rt}{\xi(q; t) \cdot \exp\left(2\pi \int_{\lambda(q; t)}^{\alpha(q)/2} \iota(\psi(q); s) \, ds + 2\pi \int_{d_q + \eta(q; t)}^{\beta(q)} \iota_\Lambda(p; s) \, ds\right)}$$

where  $p$  is a point of  $\Lambda$  with  $d_G(\psi(q), p) = d_q$ , and  $R$  is the constant provided by Lemma 44. Then, for every  $q \in Q(\delta/2)$ ,  $\rho_q$  is a modulus of continuity for  $u: S \setminus \{p_\infty\} \rightarrow \mathbb{C}$  at  $q$  with respect to the metric  $d_S$  on  $S$  and the Euclidean metric on  $\mathbb{C}$ .

*Remark 50.* This expression makes sense. First, it does not depend on the particular point  $p \in \Lambda$  with  $d_G(\psi(q), p) = d_q$ . For if  $p' \in \Lambda$  is a second such point, then  $d_G(p, p') \leq 2d_q$ . Therefore if  $s > d_q$ , as is the case throughout the range of the second integral of (7), then  $\text{CB}_\Lambda(p; s) = \text{CB}_\Lambda(p'; s)$  by Remark 18, and hence  $\text{CC}_\Lambda(p; s) = \text{CC}_\Lambda(p'; s)$ ,  $\text{cm}_\Lambda(p; s) = \text{cm}_\Lambda(p'; s)$ ,  $\text{cn}_\Lambda(p; s) = \text{cn}_\Lambda(p'; s)$ , and finally  $\iota_\Lambda(p; s) = \iota_\Lambda(p'; s)$ .

Second, if  $\psi(q) \in \Lambda$  then  $\iota(\psi(q); s)$  is not defined: but in this case  $d_q = 0$ , so that the range of the first integral of (7) degenerates to a point.

Notice also that if  $q \in Q(\delta/2)$  and  $d_S(q, x) < \delta/2$  then  $x \in Q(\delta) \subset Q(\bar{h})$ , and hence  $x \neq p_\infty \in S \setminus Q(\bar{h})$ . There is therefore no loss of generality in restricting the domain of  $u$  to  $S \setminus \{p_\infty\}$ .

**Example 51.** If  $q \in \Lambda$  then  $h_q = d_q = 0$  and  $p = q$ , so that  $\xi(q; t) = t$ ,  $\lambda(q; t) = 0$ ,  $\eta(q; t) = \mu(q; t) = \bar{r}t/2\delta$ ,  $\alpha(q) = 0$ , and  $\beta(q) = \bar{r}$ . In this case (7) therefore reduces to

$$\rho_q(t) = \frac{8R}{\exp\left(2\pi \int_{\bar{r}t/2\delta}^{\bar{r}} \iota_\Lambda(q; s) \, ds\right)}.$$

Suppose, for example, that  $q$  is one of the points of the Cantor singular set of Example 23. Taking  $\bar{r} = 1/6$  and  $\bar{h} = 1/4$  and using  $|\partial P| = 4$  gives  $\delta = 1/192$ , so that the modulus of continuity is given by

$$\rho_q(t) = \frac{8R}{\exp\left(2\pi \int_{16t}^{1/6} \iota_\Lambda(q; s) \, ds\right)}$$

for  $0 \leq t < 1/384$ . Now, by the calculations of Example 23,

$$\iota_\Lambda(q; s) \geq \frac{M}{\frac{1}{3^k} + 7s} \quad \text{when} \quad \frac{1}{2 \cdot 3^{k+2}} < s \leq \frac{1}{2 \cdot 3^{k+1}},$$

where  $M = \frac{1}{5} \min(\bar{r}/\bar{h}, \bar{h}/\bar{r}) = 2/15$ . This gives

$$\rho_q(t) \leq Ct^{\left(\frac{4\pi \ln(39/25)}{105 \ln 3}\right)} \leq Ct^{1/21}$$

as a modulus of continuity at any point  $q \in \mathcal{V}^s$ , for  $0 \leq t < 1/384$ .

*Proof of Theorem 49.* Let  $q \in Q(\delta/2)$ . Observe first that  $\rho_q: [0, \delta/2) \rightarrow [0, \infty)$  is a modulus of continuity in the sense of Definition 42. For

- It is continuous in  $(0, \delta/2)$  since the functions  $t \mapsto \mu(q; t)$ ,  $t \mapsto \xi(q; t)$ ,  $t \mapsto \lambda(q; t)$ , and  $t \mapsto \eta(q; t)$  are all continuous, and  $\xi(q; t)$  is non-zero in  $t > 0$ .
- It is strictly increasing since:
  - a) if  $t < h_q$  then  $\xi(q; t) = h_q$ , so that  $\lambda(q; t)$  and  $\eta(q; t)$  are independent of  $t$ , and  $\rho_q(t)$  is proportional to  $t$ ; and
  - b) if  $t \geq h_q$  then  $\xi(q; t) = t$  (cancelling the  $t$  in the numerator), so that  $\mu(q; \xi(q; t)) = \mu(q; t)$  is strictly increasing in  $t$ . Hence  $\lambda(q; t)$  and  $\eta(q; t)$  are increasing, and one of them is strictly increasing. Since the integrands are positive except on a set of measure zero, the two integrals are decreasing and one of them is strictly decreasing.

- It is continuous at 0 since:

- If  $h_q = 0$  (i.e.  $q \in G$ ) then  $\xi(q; t) = t \rightarrow 0$  as  $t \rightarrow 0$ , so that  $\mu(q; \xi(q; t)) \rightarrow 0$  as  $t \rightarrow 0$ . If  $d_q > 0$  (so  $q \in G \setminus \Lambda$  and  $\alpha(q) > 0$ ) then  $\lambda(q; t) \rightarrow 0$  as  $t \rightarrow 0$ , and the first integral in the denominator diverges as  $t \rightarrow 0$  by (4). On the other hand, if  $d_q = 0$  (so that  $q \in \Lambda$ ) then  $\eta(q; t) \rightarrow 0$  as  $t \rightarrow 0$ , and the second integral in the denominator diverges as  $t \rightarrow 0$  by (2).
- If  $h_q > 0$  then  $\rho_q(t)$  is proportional to  $t$  for  $0 < t < h_q$ , so  $\rho_q(t) \rightarrow 0$  as  $t \rightarrow 0$ .

Now let  $x \in S$  with  $d_S(q, x) = t < \delta/2$ . It is required to show that  $|u(q) - u(x)| \leq \rho_q(t)$ .

The proof splits into three cases depending on whether  $\psi(q)$  is far from  $\Lambda$  (case A,  $d_q \geq \bar{r}/2$ );  $\psi(q)$  is close to  $\Lambda$  and  $h_q$  is large compared to  $d_q$  (case B,  $d_q \leq \bar{r}/2$  and  $h_q \geq \frac{\delta}{\bar{r}}d_q$ ); or  $\psi(q)$  is close to  $\Lambda$  and  $h_q$  is small compared to  $d_q$  (case C,  $d_q \leq \bar{r}/2$  and  $h_q \leq \frac{\delta}{\bar{r}}d_q$ ). See Figure 8.

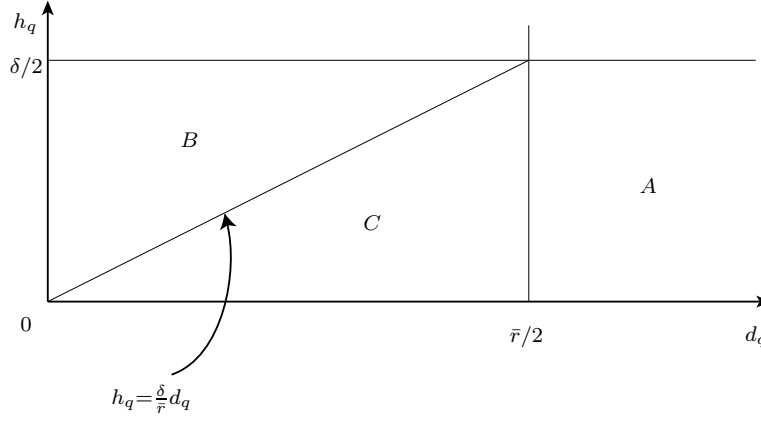

FIGURE 8. The three cases in the proof of Theorem 49

Case C is more complicated than the other two, and is treated in detail. The proofs in cases A and B are similar, and are only sketched.

**Case C:**  $d_q \leq \bar{r}/2$  and  $h_q \leq \frac{\delta}{\bar{r}}d_q$ .

In this case  $\alpha(q) = 2d_q$  and  $\beta(q) = \bar{r}$ . Notice that  $0 \leq h_q \leq \frac{2\delta}{\bar{r}}d_q - h_q$ . There are three subcases to consider:  $t \geq \frac{2\delta}{\bar{r}}d_q - h_q$ ,  $h_q \leq t \leq \frac{2\delta}{\bar{r}}d_q - h_q$ , and  $t \leq h_q$ .

- (C1) Suppose first that  $\frac{2\delta}{\bar{r}}d_q - h_q \leq t$ . Then  $\xi(q; t) = t$ , and  $\mu(q; \xi(q; t)) = \frac{\bar{r}}{2\delta}(t + h_q) \geq d_q$ . Therefore  $\lambda(q; t) = d_q$  (so that the first integral in the denominator of (7) vanishes) and  $\eta(q; t) = \mu(q; t)$ . Thus (7) reduces to

$$\rho_q(t) = \frac{8R}{\exp\left(2\pi \int_{d_q + \mu(q; t)}^{\bar{r}} \iota_\Lambda(p; s) \, ds\right)}.$$

Assume to start with that both  $d_q + \mu(q; t)$  and  $\bar{r}$  are  $(p, \Lambda)$  planar radii. Now

$$x \in \overline{B}_S(q; t) \subset D_\Lambda(p; d_q + \mu(q; t))$$

by Lemma 46: for if  $\psi(q) \notin \Lambda$  then  $\overline{B}_S(q; t) \subset D(\psi(q); \mu(q; t)) \subset D_\Lambda(p; d_q + \mu(q; t))$ ; while if  $\psi(q) \in \Lambda$  then  $\overline{B}_S(q; t) \subset D_\Lambda(\psi(q); \mu(q; t)) = D_\Lambda(p; d_q + \mu(q; t))$ , since  $d_q = 0$  and  $\psi(q) = p$ . Therefore both  $q$  and  $x$  lie in the bounded complementary component of  $\text{Ann}_\Lambda(p; d_q + \mu(q; t), \bar{r})$  (i.e. the complementary component which is contained in  $Q(\delta)$ ). See Figure 9.

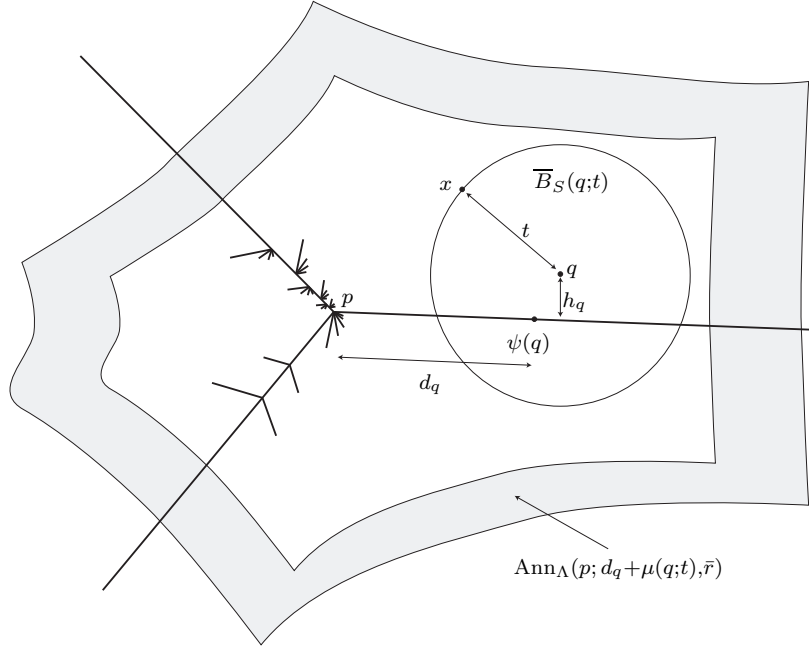

FIGURE 9. The annulus of case (C1)

By Lemma 44, the image  $u(\text{Ann}_\Lambda(p; d_q + \mu(q; t), \bar{r}))$  separates  $u(q)$  and  $u(x)$  from the circle  $|z| = R$ . Applying Theorem 40 and Theorem 4 gives

$$\begin{aligned} \int_{d_q + \mu(q; t)}^{\bar{r}} \iota_\Lambda(p; s) \, ds &\leq \text{mod } \text{Ann}_\Lambda(p; d_q + \mu(q; t), \bar{r}) \\ &= \text{mod } u(\text{Ann}_\Lambda(p; d_q + \mu(q; t), \bar{r})) \\ &\leq \frac{1}{2\pi} \ln \frac{8R}{|u(q) - u(x)|}, \end{aligned}$$

from which the required inequality  $|u(q) - u(x)| \leq \rho_q(t)$  follows.

If either or both of  $d_q + \mu(q; t)$  and  $\bar{r}$  are not  $(p, \Lambda)$ -planar, then increase  $d_q + \mu(q; t)$  and decrease  $\bar{r}$  by arbitrarily small amounts to  $(p, \Lambda)$ -planar radii. This increases the upper bound on  $|u(q) - u(x)|$ , but since it does so by an arbitrarily small amount, the upper bound as

stated remains valid. In the remaining cases of the proof, this finessing of the possibility that relevant radii are not planar will be carried out without comment.

- (C2) If  $h_q \leq t \leq \frac{2\delta}{\bar{r}}d_q - h_q$  then  $\xi(q; t) = t$  and  $\mu(q; \xi(q; t)) = \frac{\bar{r}}{2\delta}(t + h_q) \leq d_q$ . Therefore  $\lambda(q; t) = \mu(q; t)$  and  $\eta(q; t) = d_q$ , so that (7) becomes

$$\rho_q(t) = \frac{8R}{\exp\left(2\pi \int_{\mu(q;t)}^{d_q} \iota(\psi(q); s) ds + 2\pi \int_{2d_q}^{\bar{r}} \iota_\Lambda(p; s) ds\right)}.$$

By Lemma 46,  $x \in \overline{B_S(q; t)} \subset D(\psi(q); \mu(q; t))$  so that  $\text{Ann}(\psi(q); \mu(q; t), d_q)$  separates  $q$  and  $x$  from  $\partial Q(\delta)$ . This annulus is itself nested in the annulus  $\text{Ann}_\Lambda(p; 2d_q, \bar{r})$ , since  $D(\psi(q); d_q) \subset D_\Lambda(p; 2d_q)$ : see Figure 10

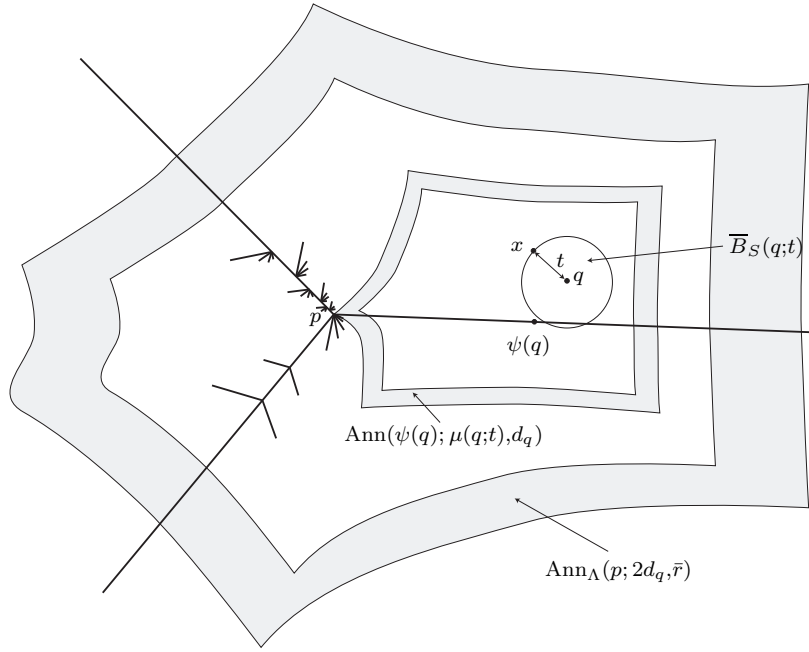

FIGURE 10. The two annuli of case (C2)

Therefore the annulus  $A$  with inner boundary  $\partial D(\psi(q); \mu(q; t))$  and outer boundary  $\partial D_\Lambda(p; \bar{r})$  satisfies (using (3) and Theorems 40 and 4)

$$\begin{aligned} \int_{\mu(q;t)}^{d_q} \iota(\psi(q); s) ds + \int_{2d_q}^{\bar{r}} \iota_\Lambda(p; s) ds &\leq \text{mod } A \\ &= \text{mod } u(A) \\ &\leq \frac{1}{2\pi} \ln \frac{8R}{|u(q) - u(x)|}, \end{aligned}$$

and the required inequality follows.

(C3) Finally, if  $0 < t \leq h_q$  then  $\xi(q; t) = h_q$ ,  $\lambda(q; t) = \mu(q; h_q)$  and  $\eta(q; r) = d_q$ . Therefore (7) becomes

$$\rho_q(t) = \frac{8Rt}{h_q \cdot \exp \left( 2\pi \int_{\mu(q; h_q)}^{d_q} \iota(\psi(q); s) ds + 2\pi \int_{2d_q}^{\bar{r}} \iota_\Lambda(p; s) ds \right)}.$$

By Lemma 46,  $\overline{B}_S(q; h_q) \subset D(\psi(q); \mu(q; h_q))$ , so the “round” annulus  $A = B_S(q; h_q) \setminus \overline{B}_S(q; t)$  is nested inside  $\text{Ann}(\psi(q); \mu(q; h_q), d_q)$ , which in turn is nested inside  $\text{Ann}_\Lambda(p; 2d_q, \bar{r})$ : see Figure 11.

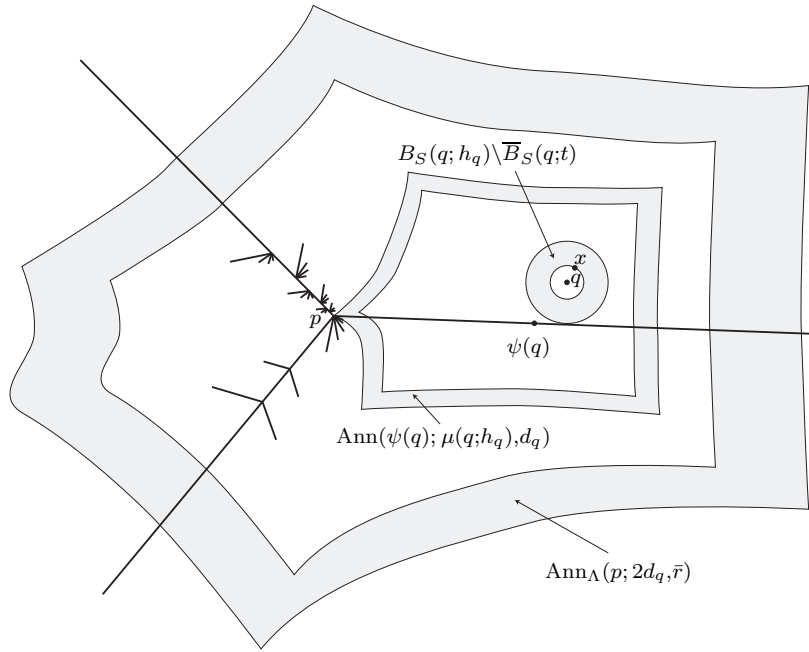

FIGURE 11. The three annuli of case (C3)

Since  $A$  is contained entirely in  $S \setminus G$  and is therefore conformally equivalent to the standard annulus  $A(t, h_q)$ , it has modulus  $\frac{1}{2\pi} \ln \frac{h_q}{t}$ . Applying (3) and Theorems 40 and 4 therefore gives

$$\frac{1}{2\pi} \ln \frac{h_q}{t} + \int_{\mu(q; h_q)}^{d_q} \iota(\psi(q); s) ds + \int_{2d_q}^{\bar{r}} \iota_\Lambda(p; s) ds \leq \frac{1}{2\pi} \ln \frac{8R}{|u(q) - u(x)|},$$

and the required inequality follows.

**Case A:**  $d_q \geq \bar{r}/2$ .

In this case  $\mu(q; t) = \frac{\bar{r}}{2\delta}(t + h_q) \leq \frac{\bar{r}}{2} \leq d_q$  for all  $(q; t) \in Q(\delta/2) \times [0, \delta/2)$ , so that  $\lambda(q; t) = \mu(q; \xi(q; t))$  and  $\eta(q; t) = d_q$ . Moreover  $\alpha(q) = \bar{r}$  and  $\beta(q) = 2d_q$ : in particular, the second integral in the denominator of (7) vanishes.

There are two subcases to consider.

- (A1) If  $h_q \leq t$  then the result comes from considering the annulus  $\text{Ann}(\psi(q); \mu(q, t), \bar{r}/2)$ .  
 (A2) If  $0 < t \leq h_q$  then the result comes from considering the annulus  $\text{Ann}(\psi(q); \mu(q; h_q), \bar{r}/2)$  together with the “round” annulus  $B_S(q; h_q) \setminus \bar{B}(q; t)$ , which is nested inside it.

**Case B:**  $d_q \leq \bar{r}/2$  and  $h_q \geq \frac{\delta}{\bar{r}}d_q$ .

In this case  $\mu(q; \xi(q; t)) \geq \mu(q; h_q) = \frac{\bar{r}}{\delta}h_q \geq d_q$ , so that  $\lambda(q; t) = d_q$  and  $\eta(q; t) = \mu(q; \xi(q; t))$ . Moreover  $\alpha(q) = 2d_q$  and  $\beta(q) = \bar{r}$ : in particular, the first integral in the denominator of (7) vanishes.

There are two subcases to consider.

- (B1) If  $h_q \leq t$  then the result comes from considering the annulus  $\text{Ann}_\Lambda(p; d_q + \mu(q; t), \bar{r})$  (the expression for  $\rho_q(t)$  in this case is identical to that of case (C1)).  
 (B2) If  $0 < t \leq h_q$  then the result comes from considering the annulus  $\text{Ann}_\Lambda(p; d_q + \mu(q; h_q), \bar{r})$  together with the “round” annulus  $B_S(q; h_q) \setminus \bar{B}(q; t)$  which is nested inside it.

□

**5.3. Global modulus of continuity.** In order to construct a global modulus of continuity from the local moduli of continuity of the previous section, it is first necessary to prove that the function  $\rho$  is (jointly) continuous on its domain  $Q(\delta/2) \times [0, \delta/2)$ , so that  $\max_{q \in Q(\delta/2)} \rho(q, t)$  is a modulus of continuity throughout  $Q(\delta/2)$ . Lemma 52 provides the basis for this argument, which is completed in Lemma 53. This is then combined with the modulus of continuity in  $P_{\delta/3}$  provided by Lemma 47 to give the required global modulus (Theorem 54).

**Lemma 52.** *Let  $I_1: G \setminus \Lambda \times (0, \bar{r})^2 \rightarrow \mathbb{R}$  and  $I_2: \Lambda \times (0, \bar{r}) \rightarrow (0, \infty)$  be defined by*

$$I_1(q; r, t) = \int_r^t \iota(q; s) \, ds, \quad \text{and}$$

$$I_2(q; r) = \int_r^{\bar{r}} \iota_\Lambda(q; s) \, ds.$$

Then

- a)  $I_1$  is continuous.
- b) For all  $K > 0$ ,  $q_0 \in G \setminus \Lambda$ , and  $t_0 \in (0, \bar{r})$ , there is some  $\eta > 0$  such that if  $q \in B_G(q_0; \eta)$  and  $r \in (0, \eta)$ , then  $I_1(q; r, t_0) > K$ .
- c) For all  $K > 0$  and  $q_0 \in \Lambda$ , there is some  $\eta > 0$  such that if  $q \in \Lambda \cap B_G(q_0; \eta)$  and  $r \in (0, \eta)$ , then  $I_2(q; r) > K$ .

*Proof.* Recall that

$$\iota(q; s) = \frac{M}{m(q; s) + s \cdot n(q; s)} \quad \text{and} \quad \iota_\Lambda(q; s) = \frac{M}{\text{cm}_\Lambda(q; s) + s \cdot \text{cn}_\Lambda(q; s)}.$$

By Remark 39,  $\iota_\Lambda(q; s)$  is bounded above by  $M/2s$ , and similarly  $\iota(q; s)$  is bounded above by  $M/2s$ .



- a) Let  $(q_0; r_0, t_0) \in G \setminus \Lambda \times (0, \bar{r})^2$ : it will be shown that  $I_1$  is continuous at  $(q_0; r_0, t_0)$ . Now for  $(q; r, t) \in G \setminus \Lambda \times (0, \bar{r})^2$ ,

$$I(q; r, t) - I(q_0; r_0, t_0) = \int_{r_0}^{t_0} \iota(q; s) \, ds - \int_{r_0}^{t_0} \iota(q_0; s) \, ds + \int_r^{r_0} \iota(q; s) \, ds + \int_{t_0}^t \iota(q; s) \, ds.$$

The final two integrals converge to zero as  $(q; r, t) \rightarrow (q_0; r_0, t_0)$ , since  $\iota(q; s)$  is bounded above by  $M/r_0$  for  $s \geq r_0/2$ . Hence it suffices to prove that, for any  $\varepsilon > 0$ ,

$$\left| \int_{r_0}^{t_0} (\iota(q; s) - \iota(q_0; s)) \, ds \right| < \varepsilon$$

provided that  $d_G(q, q_0)$  is sufficiently small.

Let  $B := [r_0, t_0] \cap \{d_G(q_0, q^*) : q^* \in \bar{\mathcal{V}}\}$ . Then (cf. the proof of Lemma 32),  $B$  is a compact set with zero Lebesgue measure, and hence can be covered by a finite union  $U$  of open intervals with total length less than  $\varepsilon r_0/2M$ . Let  $L := [r_0, t_0] \setminus U$  and let  $\delta > 0$  be the minimum distance from a point of  $L$  to a point of  $B$ . Then

$$\begin{aligned} \int_L \iota(q_0; s) \, ds &\geq \int_{r_0}^{t_0} \iota(q_0; s) \, ds - \frac{\varepsilon r_0}{2M} \cdot \frac{M}{2r_0} = \int_{r_0}^{t_0} \iota(q_0; s) \, ds - \frac{\varepsilon}{4}, \\ \int_L \iota(q; s) \, ds &\geq \int_{r_0}^{t_0} \iota(q; s) \, ds - \frac{\varepsilon}{4}, \end{aligned}$$

and  $(d_G(q_0, q^*) - \delta, d_G(q_0, q^*) + \delta)$  is disjoint from  $L$  for all  $q^* \in \bar{\mathcal{V}}$ .

It follows that  $\bar{B}_G(q; b) \setminus B_G(q; a)$  is a disjoint union of  $n(q_0; a)$  intervals of length  $b - a$  for each component  $[a, b]$  of  $L$  and each  $q \in B_G(q_0; \delta)$ , so that  $n(q; s) = n(q_0; a)$  is constant for  $q \in B_G(q_0; \delta)$  and  $s \in [a, b]$ , and  $m(q; s)$  is continuous on the domain  $B_G(q_0; \delta) \times [a, b]$ . Therefore if  $d_G(q, q_0)$  is sufficiently small then

$$\left| \int_L \iota(q_0; s) \, ds - \int_L \iota(q; s) \, ds \right| \leq \frac{\varepsilon}{2},$$

and the result follows.

- b) Let  $q_0 \in G \setminus \Lambda$ ,  $K > 0$ , and  $t_0 \in (0, \bar{r})$ .  $\eta \in (0, t_0)$  will be chosen small enough that  $B_G(q_0; \eta)$  is disjoint from  $\Lambda$ . Since (4) holds at  $q_0$ , there is some  $\varepsilon > 0$  such that

$$\int_{\varepsilon}^{t_0} \iota(q_0; s) \, ds > 3K.$$

As in part a), there is a subset  $L$  of  $[\varepsilon, t_0]$  consisting of a finite union of closed intervals, and a number  $\delta > 0$  such that

$$\int_L \iota(q_0; s) \, ds > 2K$$

and  $(d_G(q_0, q^*) - \delta, d_G(q_0, q^*) + \delta)$  is disjoint from  $L$  for all  $q^* \in \bar{\mathcal{V}}$ .

Again as in part a), there is some  $\delta' \in (0, \delta)$  such that

$$\int_L \iota(q; s) \, ds > K$$

provided that  $d_G(q; q_0) < \delta'$ . Hence

$$I_1(q; r, t_0) > \int_{\varepsilon}^{t_0} \iota(q; s) \, ds \geq \int_L \iota(q; s) \, ds > K$$

for all  $q$  with  $d_G(q, q_0) < \delta'$  and all  $r \in (0, \varepsilon)$ , as required.

c) Let  $q_0 \in \Lambda$  and  $K > 0$ . Since (2) holds at  $q_0$ , there is some  $\varepsilon > 0$  such that

$$\int_{\varepsilon}^{\bar{r}} \iota_{\Lambda}(q_0; s) \, ds > K.$$

Now if  $q \in \Lambda$  with  $d_G(q_0, q) < 2\varepsilon$  then  $\iota_{\Lambda}(q; s) = \iota_{\Lambda}(q_0; s)$  for all  $s \geq \varepsilon$  by Remark 18. Hence if  $d_G(q_0, q) < 2\varepsilon$  and  $r \in (0, \varepsilon)$  then

$$I_2(q; r) > \int_{\varepsilon}^{\bar{r}} \iota_{\Lambda}(q; s) \, ds = \int_{\varepsilon}^{\bar{r}} \iota_{\Lambda}(q_0; s) \, ds > K$$

as required. □

**Lemma 53.** *The function  $\rho: Q(\delta/2) \times [0, \delta/2) \rightarrow [0, \infty)$  of (7) is continuous.*

*Proof.* Let  $(q_0; t_0) \in Q(\delta/2) \times [0, \delta/2)$ : it will be shown that  $\rho$  is continuous at  $(q_0; t_0)$ .

**Case 1:**  $t_0 > 0$ .

Notice that in this case  $\xi(q; t) > t_0/2$ , and hence  $\mu(q; \xi(q; t)) > \bar{r}t_0/4\delta$  for all  $(q; t)$  sufficiently close to  $(q_0; t_0)$ .

a) Suppose first that  $\psi(q_0) \in \Lambda$ , so that  $d_{q_0} = 0$ . Then  $\lambda(q; t) = d_q$ ,  $\eta(q; t) = \mu(q; \xi(q; t))$ ,  $\alpha(q) = 2d_q$ , and  $\beta(q) = \bar{r}$  for all  $(q; t)$  sufficiently close to  $(q_0; t_0)$ , so that

$$\rho(q; t) = \frac{8Rt}{\xi(q; t) \cdot \exp\left(2\pi \int_{d_q + \mu(q; \xi(q; t))}^{\bar{r}} \iota_{\Lambda}(p; s) \, ds\right)},$$

where  $p \in \Lambda$  satisfies  $d_G(p, \psi(q)) = d_q$ . However if  $q$  is sufficiently close to  $q_0$  then  $\iota_{\Lambda}(p; s) = \iota_{\Lambda}(\psi(q_0); s)$  throughout the range of integration, and the continuity of  $\rho$  follows from the continuity of  $\mu$ ,  $\xi$ , and  $d_q$ .

b) Suppose that  $\psi(q_0) \notin \Lambda$ , so that  $d_{q_0} > 0$ . Let  $p_0 \in \Lambda$  with  $d_G(p_0, q_0) = d_{q_0}$ . Pick  $\varepsilon < d_{q_0}$ , and suppose that  $q \in Q(\delta/2)$  with  $d_G(\psi(q), \psi(q_0)) < \varepsilon$ : thus  $|d_{q_0} - d_q| < \varepsilon$ . Let  $p \in \Lambda$  with  $d_G(p, q) = d_q$ . Then  $d_G(p, p_0) \leq 2(d_{q_0} + \varepsilon)$ . Since  $s \geq 2(d_{q_0} - \varepsilon)$  throughout the range of integration of the second integral of (7),  $\iota_{\Lambda}(p_0; s) = \iota_{\Lambda}(p; s)$  throughout the range of integration for  $\varepsilon$  sufficiently small by Remark 18, and this second integral varies continuously with  $(q; t)$ . The first integral is  $I_1(\psi(q); \lambda(q; t), \alpha(q)/2)$ , which is continuous at  $(q_0; t_0)$  by Lemma 52 a), since  $\lambda(q_0; t_0) > 0$ .

**Case 2:**  $t_0 = 0$ .

In this case it is necessary to show that  $\rho(q; t) \rightarrow 0$  as  $(q; t) \rightarrow (q_0; 0)$  with  $t > 0$ .

- a) If  $h(q_0) > 0$  then  $\xi(q; t) = h_q$ , and hence  $\rho(q; t) \leq 8Rt/h_q$ , for all  $(q; t)$  sufficiently close to  $(q_0; 0)$ , and the result follows.
- b) If  $h(q_0) = 0$  and  $d_{q_0} > 0$  (i.e.  $q_0 \in G \setminus \Lambda$ ), then  $\alpha(q_0) > 0$  and, ignoring the second integral in the denominator of (7),

$$\rho(q; t) \leq \frac{8R}{\exp(2\pi I_1(\psi(q); \lambda(q; t), \alpha(q_0)/4))}$$

for  $(q; t)$  sufficiently close to  $(q_0; 0)$ , and the result follows by Lemma 52 b) since  $\lambda(q; t) \rightarrow 0$  as  $(q; t) \rightarrow (q_0; 0)$ .

- c) If  $h(q_0) = 0$  and  $d_{q_0} = 0$  (i.e.  $q_0 \in \Lambda$ ), then

$$\rho(q; t) \leq \frac{8R}{\exp(2\pi I_2(p; d_q + \eta(q; t)))}$$

for  $(q; t)$  sufficiently close to  $(q_0; 0)$ , and the result follows by Lemma 52 c) since  $d_q + \eta(q; t) \rightarrow 0$  and  $p \rightarrow q_0$  as  $(q; t) \rightarrow (q_0; 0)$ .

□

**Theorem 54.** *Let  $(P, \mathcal{P})$  be a plain paper-folding scheme and  $\Lambda = \mathcal{V}^s$  be the singular set. Let  $\bar{r}$  be an injectivity radius for  $\Lambda$  and  $\bar{h}$  be a collaring height for  $P$ . Suppose that condition (2) holds at every point  $q \in \Lambda$ . Then the uniformizing map  $\phi = u \circ \pi: P \rightarrow \widehat{\mathbb{C}}$  has a modulus of continuity  $\bar{\rho}$ , with respect to the Euclidean metric on  $P$  and the spherical metric on  $\widehat{\mathbb{C}}$ , which depends only on  $\bar{r}$ ,  $\bar{h}$ ,  $|\partial P|$ , and the functions  $\iota_\Lambda: \Lambda \times (0, \bar{r}) \rightarrow [0, \infty)$  and  $\iota: G \setminus \Lambda \times (0, \bar{r}) \rightarrow [0, \infty)$ .*

*Proof.* Define  $\hat{\rho}: [0, \delta/2) \rightarrow [0, \infty)$  by

$$\hat{\rho}(t) := 2 \max_{q \in Q(\delta/2)} \rho(q, t),$$

which is well defined since  $\rho$  is continuous and  $Q(\delta/2)$  is compact. Then  $\hat{\rho}$  is a continuous strictly increasing function with  $\hat{\rho}(0) = 0$  (since each  $\rho_q$  has these properties and  $\rho$  is continuous), and  $\phi$  has modulus of continuity  $\hat{\rho}$  on  $\tilde{Q}(\delta/2)$  with respect to the Euclidean metric on  $\tilde{Q}(\delta)$  and the spherical metric on  $\widehat{\mathbb{C}}$  (the factor 2 in the definition of  $\hat{\rho}$  arises from the translation from the Euclidean metric on  $\mathbb{C}$  to the spherical metric on  $\widehat{\mathbb{C}} \setminus \{\infty\}$ ).

On the other hand,  $\phi$  is  $\kappa$ -Lipschitz in  $P_{\delta/3}$  by Lemma 47. Hence  $\bar{\rho}: [0, \delta) \rightarrow [0, \infty)$  defined by

$$\bar{\rho}(t) := \max\{\hat{\rho}(t), \kappa t\}$$

is the desired modulus of continuity. □

## REFERENCES

1. L. V. Ahlfors, *Conformal invariants: topics in geometric function theory*, McGraw-Hill Book Co., New York, 1973, McGraw-Hill Series in Higher Mathematics.
2. L. V. Ahlfors and L. Sario, *Riemann surfaces*, Princeton Mathematical Series, No. 26, Princeton University Press, Princeton, N.J., 1960.
3. D. Burago, Y. Burago, and S. Ivanov, *A course in metric geometry*, Graduate Studies in Mathematics, vol. 33, American Mathematical Society, Providence, RI, 2001.

4. A. de Carvalho and T. Hall, *Unimodal generalized pseudo-Anosov maps*, *Geom. Topol.* **8** (2004), 1127–1188 (electronic).
5. ———, *Paper folding, Riemann surfaces, and convergence of pseudo-Anosov sequences*, arXiv:1010.3448 (2010).
6. K. Kuratowski, *Topology. Vol. II*, New edition, revised and augmented. Translated from the French by A. Kirkor, Academic Press, New York, 1968.
7. O. Lehto and K. I. Virtanen, *Quasiconformal mappings in the plane*, second ed., Springer-Verlag, New York, 1973, Translated from the German by K. W. Lucas, Die Grundlehren der mathematischen Wissenschaften, Band 126.
8. C. T. McMullen, *Complex dynamics and renormalization*, *Annals of Mathematics Studies*, vol. 135, Princeton University Press, Princeton, NJ, 1994.
9. S. Smale, *Differentiable dynamical systems*, *Bull. Amer. Math. Soc.* **73** (1967), 747–817.
10. W. P. Thurston, *On the geometry and dynamics of diffeomorphisms of surfaces*, *Bull. Amer. Math. Soc. (N.S.)* **19** (1988), no. 2, 417–431. MR MR956596 (89k:57023)
11. G. T. Whyburn, *Analytic topology*, American Mathematical Society Colloquium Publications, Vol. XXVIII, American Mathematical Society, Providence, R.I., 1963.

DEPARTAMENTO DE MATEMÁTICA APLICADA, IME - USP, RUA DO MATÃO 1010, CIDADE UNIVERSITÁRIA,  
05508-090 SÃO PAULO, SP, BRAZIL  
*E-mail address:* `andre@ime.usp.br`

DEPARTMENT OF MATHEMATICAL SCIENCES, UNIVERSITY OF LIVERPOOL, LIVERPOOL L69 7ZL, UK  
*E-mail address:* `T.Hall@liv.ac.uk`