

Technical Report: NUS-ACT-10-001-Ver.3:

Synchronized Task Decomposition for

Cooperative Multi-agent Systems

Preprint, Accepted by Automatica (entitled as
Guaranteed Global Performance Through Local
Coordinations)

Mohammad Karimadini, and Hai Lin,

Abstract

It is an amazing fact that remarkably complex behaviors could emerge from a large collection of very rudimentary dynamical agents through very simple local interactions. However, it still remains elusive on how to design these local interactions among agents so as to achieve certain desired collective behaviors. This paper aims to tackle this challenge and proposes a divide-and-conquer approach to guarantee specified global behaviors through local coordination and control design for multi-agent systems. The basic idea is to decompose the requested global specification into subtasks for each individual agent. It should be noted that the decomposition is not arbitrary. The global specification should be decomposed in such a way that the fulfillment of these subtasks by each individual agent will imply the satisfaction of the global specification as a team. Formally, a given global specification can be represented as an automaton A , while a multi-agent system can be captured as a parallel distributed system. The first question needs to be answered is whether it is always possible to decompose a given task automaton A into a finite number of sub-automata A_i , where the parallel composition of these sub-automata A_i is bisimilar to the automaton A . First, it is shown by a counterexample that not all specifications can

be decomposed in this sense. Then, a natural follow-up question is what the necessary and sufficient conditions should be for the proposed decomposability of a global specification. The main part of the paper is set to answer this question. The case of two cooperative agents is investigated first, and necessary and sufficient conditions are presented and proven. Later on, the result is generalized to the case of arbitrary finite number of agents, and a hierarchical algorithm is proposed, which is shown to be a sufficient condition. Finally, a cooperative control scenario for a team of three robots is developed to illustrate the task decomposition procedure.

I. INTRODUCTION

Strongly driven by its great potential in both civilian and industrial applications [1], [2], multi-agent systems has rapidly emerged as a hot research area at the intersection of control, communication and computation [3], [4], [5], [6]. The key issue in multi-agent system design is how to explicitly set the local interaction rules such that certain desirable global behaviors can be achieved by the team of cooperative agents[7]. Although it is known that sophisticated collective behaviors could emerge from a large collection of very elementary agents through simple local interactions, we still lack knowledge on how to change these rules to achieve or avoid certain global behaviors. As a result, it still remains elusive on how to design these local interaction rules so as to make sure that they, as a group, can achieve the specified requirements. In addition, we would like to point out that the desired collective behavior for a group of mobile agents could be very complicated, and might involve the coordination of many distributed independent and dependent modules in a parallel and environmental awareness manner. Hence, it poses new challenges that go beyond the traditional path planning, output regulation, or formation control[8], [9], [10], [5].

This paper aims to propose a decomposition approach applicable in divide-and-conquer design for cooperative multi-agent systems so as to guarantee the desired global behaviors. The core idea is to decompose a global specification into sub-specifications for individual agents, and then design local controllers for each agent to satisfy these local specifications, respectively. The decomposition should be done in such a way that the global behavior is achieved provided that all these sub-specifications are held true by individual agents. Hence, the global specification is guaranteed by design. In order to perform this idea, several questions are required to be answered, such as how to describe the global specification and subtasks in a succinct and formal

way; how to decompose the global specification; whether it is always possible to decompose, and if not, what are the necessary and sufficient conditions for decomposability.

To formally describe the specification, a deterministic finite automaton is chosen here to represent the global specifications for multi-agent systems, due to its expressibility for a large class of tasks[11], [12], its similarity to our human logical commands, and its connection to the temporal logic specifications[13], [14]. Accordingly, we will focus on the logical behavior of a multi-agent system and model its collective behavior through parallel composition [15]. It is assumed that each agent is equipped with a local event set, containing both private events and common events (shared with other agents). Furthermore, it is assumed that the global task automaton is defined over the union of all agents' events. Then, the decomposition problem can be stated as follows. Given the global desired behavior represented as a deterministic automaton, how to obtain the local task automata from it such that the composition of the obtained local task automata is equivalent to the original global task automaton?

Since the global task automaton is defined over the union of all agents' event sets, a reasonable way to obtain the local task automata is through natural projections with respect to each agent's event set. Namely, the agent will ignore the transitions marked by the events that are not in its own event set, i.e., blinds to these moves. The obtained automaton will be a sub-automaton of the global task automaton by deleting all the moves triggered by blind events of the agent. Given a task automaton and sets of local events, it is always feasible to do the projection operation, but the question is whether the obtained sub-automata preserve the required specifications in the sense that the fulfillment of each agent with its corresponding sub-task automaton will imply the satisfaction of the global specification as a group. Unfortunately, by a simple counterexample, it can be shown that the answer is not always. Then, a natural follow-up question is what the necessary and sufficient condition should be for the proposed decomposability of a global specification. The main part of the paper is set to answer this question.

Similar automaton decomposition problem has been studied in the computer science literature. Roughly speaking, two different classes of problems have been studied, so far. The first problem is to design the event distribution so as to make the automaton decomposable, which is typically studied in the context of concurrent systems. For example, [16] characterized the conditions for decomposition of asynchronous automata in the sense of isomorphism based on the maximal cliques of the dependency graph. The isomorphism equivalence used in [16] is however a strong

condition, in the sense that two isomorphic automata are bisimilar but not vice versa [11]. In many applications bisimulation relation suffices to capture the equivalence relationship. On the other hand, the second class of problems assumes that the distribution of the global event set is given and the objective is to find conditions on the automaton such that it is decomposable. This is usually called synthesis modulo problem [15] that can be investigated under three types of equivalence: isomorphism, bisimulation and language equivalence. Bisimulation synthesis modulo for a global automaton was addressed in [17], by introducing necessary and sufficient conditions for automaton decomposition based on language product of the automaton and determinism of its bisimulation quotient. Obtaining the bisimulation quotient, however, is generally a difficult task, and the condition on language product relies on language separability [18], which is another form of decomposability. These problems motivate us to develop new necessary and sufficient conditions that can characterize the decomposability based on the investigation of events and strings in the given automaton.

In this paper, we identify conditions on the global specification automaton in terms of its private and common events for the proposed decomposability, which are shown to be necessary and sufficient for the case of two agents. Later on, the result is generalized to the case of arbitrary finite number of agents, and a hierarchical algorithm is proposed, which is shown to be a sufficient condition. Furthermore, it is shown that if the global task is decomposable, then designing the local controller for each agent to satisfy its corresponding sub-task will lead the entire multi-agent system to achieve the global specification. To illustrate the decomposition approach, a coordination and control scenario has been developed and implemented on a team of three robots.

The rest of the paper is organized as follows. Preliminary lemmas, notations, definitions and problem formulation are represented in Section II. Section III introduces the necessary and sufficient conditions for decomposition of an automaton with respect to parallel composition and two local event sets. The algorithm for the hierarchical extension of the automaton decomposition is given in Section IV. To illustrate the task decomposition, an implementation result is given on a cooperative multi-robot system example in Section V. Finally, the paper concludes with remarks and discussions in Section VI. The proofs of lemmas are given in the Appendix.

II. PROBLEM FORMULATION

We first recall the definition of an automaton [12].

Definition 1: (Automaton) An automaton is a tuple $A = (Q, q_0, E, \delta)$ consisting of

- a set of states Q ;
- the initial state $q_0 \in Q$;
- a set of events E that causes transitions between the states, and
- a transition relation $\delta \subseteq Q \times E \times Q$ such that $(q, e, q') \in \delta$ if and only if $\delta(q, e) = q'$ (or $q \xrightarrow{e} q'$).

In general, automaton has also an argument Q_m which is the set of final or marked states, the states are marked when it is desired to attach a special meaning to them, such as accomplishing. This argument is dropped when the notion of marked state is not of interest or it is clear from the content.

As δ is a partial map from $Q \times E$ into Q , in general, not all states are reachable from the initial state. The accessible portion of the automaton is defined as

Definition 2: (Accessible Operator; [11]) Consider an automaton $A = (Q, q_0, E, \delta)$. The operator $Ac(\cdot)$ excludes the states and their attached transitions that are not reachable from the initial state, and is defined as $Ac(A) = (Q_{ac}, q_0, E, \delta_{ac})$ with $Q_{ac} = \{q \in Q \mid \exists s \in E^*, \delta(q_0, s) = q\}$ and $\delta_{ac} = \delta|_{Q_{ac} \times E \rightarrow Q_{ac}}$, restricting δ to the smaller domain of Q_{ac} . As $Ac(\cdot)$ has no effect on the behavior of the automaton, from now on we assume $A = Ac(A)$.

The transition relation can be extended to a finite string of events, $s \in E^*$, where E^* stands for *Kleene – Closure* of E (the set of all finite strings over elements of E), as follows $\delta(q, \varepsilon) = q$, and $\delta(q, se) = \delta(\delta(q, s), e)$ for $s \in E^*$ and $e \in E$. We focus on deterministic task automata that are simpler to be characterized, and cover a wide class of specifications. The qualitative behavior of a deterministic discrete event system (DES) is described by the set of all possible sequences of events starting from initial state. Each such a sequence is called a string, and the collection of strings represents the language generated by the automaton, denoted by $L(A)$. Given a language L , $\bar{L} \subseteq E^*$ is the prefix-closure of L defined as $\bar{L} = \{s \in E^* \mid \exists t \in E^*, st \in L\}$, consisting of all prefixes of all the strings in L . The existence of a transition over string $s \in E^*$ from a state $q \in Q$, is denoted by $\delta(q, s)!$, and considering a language L , by $\delta(q, L)!$ we mean $\forall \omega \in L : \delta(q, \omega)!$.

To describe the decomposability condition in the main result and during the proofs, we define successive event pair and adjacent event pair as follows.

Definition 3: (Successive event pair) Two events e_1 and e_2 are called successive events if $\exists q \in Q : \delta(q, e_1)! \wedge \delta(\delta(q, e_1), e_2)! \text{ or } \delta(q, e_2)! \wedge \delta(\delta(q, e_2), e_1)!$.

Definition 4: (Adjacent event pair) Two events e_1 and e_2 are called adjacent events if $\exists q \in Q : \delta(q, e_1)! \wedge \delta(q, e_2)!$.

To compare the task automaton and its decomposed automata, we use the simulation and bisimulation relations [11].

Definition 5: (Simulation and Bisimulation) Consider two automata $A_i = (Q_i, q_i^0, E, \delta_i)$, $i = 1, 2$. A relation $R \subseteq Q_1 \times Q_2$ is said to be a simulation relation from A_1 to A_2 if

- 1) $(q_1^0, q_2^0) \in R$
- 2) $\forall (q_1, q_2) \in R, \delta_1(q_1, e) = q'_1$, then $\exists q'_2 \in Q_2$ such that $\delta_2(q_2, e) = q'_2, (q'_1, q'_2) \in R$.

If R is defined for all states and all events in A_1 , then A_1 is said to be similar to A_2 (or A_2 simulates A_1), denoted by $A_1 \prec A_2$ [11].

If $A_1 \prec A_2, A_2 \prec A_1$ and R is symmetric then A_1 and A_2 are said to be bisimilar (bisimulate each other), denoted by $A_1 \cong A_2$ [19].

In general, bisimilarity implies languages equivalence but the converse does not necessarily hold true [20].

Definition 6: (Isomorphism, [21]) Isomorphism is one of the strongest equivalences relations between automata. Two automata $A_i = (Q_i, q_i^0, E, \delta_i)$, $i = 1, 2$, are said to be isomorphic, if there exists an isomorphism θ from A_1 to A_2 defined as a bijective function $\theta : Q_1 \rightarrow Q_2$ such that $\theta(q_1^0) = q_2^0$, and $\theta(\delta_1(q, e)) = \delta_2(\theta(q), e), \forall q \in Q_1, e \in E$.

By this definition, two isomorphic automata are bisimilar, but bisimilar automata are not necessarily isomorphic (see Example 3).

In this paper, we assume that the task automaton A_S and the sets of local events E_i are all given. It is further assumed that A_S is deterministic while its event set E is obtained by the union of local event sets, i.e., $E = \cup_i E_i$. The problem is to check whether the task automaton A_S can be decomposed into sub-automata A_{S_i} on the local event sets E_i , respectively, such that the collection of these sub-automata A_{S_i} is somehow equivalent to A_S . The equivalence is in the sense of bisimilarity as defined above, while the composition process for these sub-automata A_{S_i} could be in the usual sense of parallel composition as defined below. Parallel composition is used

to model the interactions between automata and represent the logical behavior of multi-agent systems. Parallel composition is formally defined as

Definition 7: (Parallel Composition [12]) Let $A_i = (Q_i, q_i^0, E_i, \delta_i)$, $i = 1, 2$, be automata. The parallel composition (synchronous composition) of A_1 and A_2 is the automaton $A_1 \parallel A_2 = (Q = Q_1 \times Q_2, q_0 = (q_1^0, q_2^0), E = E_1 \cup E_2, \delta)$, with δ defined as

$$\forall (q_1, q_2) \in Q, e \in E : \delta((q_1, q_2), e) = \begin{cases} (\delta_1(q_1, e), \delta_2(q_2, e)), & \text{if } \begin{cases} \delta_1(q_1, e)!, \delta_2(q_2, e)!, \\ e \in E_1 \cap E_2 \end{cases} ; \\ (\delta_1(q_1, e), q_2), & \text{if } \delta_1(q_1, e)!, e \in E_1 \setminus E_2; \\ (q_1, \delta_2(q_2, e)), & \text{if } \delta_2(q_2, e)!, e \in E_2 \setminus E_1; \\ \text{undefined,} & \text{otherwise} \end{cases} .$$

The parallel composition of A_i , $i = 1, 2, \dots, n$ is called parallel distributed system, and is defined based on the associativity property of parallel composition [11] as $\parallel_{i=1}^n A_i = A_1 \parallel \dots \parallel A_n = A_1 \parallel (A_2 \parallel (\dots \parallel (A_{n-1} \parallel A_n)))$.

A reasonable guess for task automaton decomposition is to use natural projections with respect to agents' event set. Natural projection over strings is denoted by $p_{E_i} = p_i : E^* \rightarrow E_i^*$, takes a string from the event set E and eliminates events in it that do not belong to the event set $E_i \subseteq E$. The natural projection is formally defined on the strings as

Definition 8: (Natural Projection on String, [11]) Consider a global event set E and its local event sets E_i , $i = 1, 2, \dots, n$, with $E = \bigcup_{i=1}^n E_i$. Then, the natural projection $p_i : E^* \rightarrow E_i^*$ is inductively defined as

$$p_i(\varepsilon) = \varepsilon; \\ \forall s \in E^*, e \in E : p_i(se) = \begin{cases} p_i(s)e & \text{if } e \in E_i; \\ p_i(s) & \text{otherwise.} \end{cases}$$

The natural projection is also defined on automata as $P_i(A_S) : A_S \rightarrow A_{S_i}$, where, A_{S_i} are obtained from A_S by replacing its events that belong to $E \setminus E_i$ by τ -moves (representing silent or unobservable transitions), and then, merging the τ -related states. The τ -related states form equivalent classes defined as follows.

Definition 9: (Equivalent class of states, [16]) Consider an automaton $A_S = (Q, q_0, E, \delta)$ and local event sets E_i , $i = 1, 2, \dots, n$, with $E = \bigcup_{i=1}^n E_i$. Then, the relation \sim_{E_i} (or \sim_i) is the least equivalence relation on the set Q of states such that $\delta(q, e) = q' \wedge e \notin E_i \Rightarrow q \sim_{E_i} q'$, and $[q]_{E_i} = [q]_i$ denotes the equivalence class of q defined on \sim_{E_i} . In this case, q and q' are said

to be τ -related.

The natural projection is then formally defined on an automaton as follows.

Definition 10: (Natural Projection on Automaton) Consider an automaton $A_S = (Q, q_0, E, \delta)$ and local event sets $E_i, i = 1, 2, \dots, n$, with $E = \bigcup_{i=1}^n E_i$. Then, $P_i(A_S) = (Q_i = Q/\sim_{E_i}, [q_0]_{E_i}, E_i, \delta_i)$, with $\delta_i([q]_{E_i}, e) = [q']_{E_i}$ if there are states q_1 and q'_1 such that $q_1 \sim_{E_i} q$, $q'_1 \sim_{E_i} q'$, and $\delta(q_1, e) = q'_1$.

The following example elaborates the concept of natural projection on a given automaton.

Example 1: Consider an automaton A_S :

and local event sets $E_1 = \{a, b, e_1\}$, $E_2 = \{a, b, e_2, e_4\}$. The natural projections of A_S into E_1 is obtained as $P_1(A_S)$:

related states. Similarly, the projection $P_2(A_S)$ is obtained as $P_2(A_S)$:

To investigate the interactions of transitions in two automata, particularly in $P_1(A_S)$ and $P_2(A_S)$, the interleaving of strings is defined, based on the path automaton as follows.

Definition 11: (Path Automaton) A sequence $q_1 \xrightarrow{e_1} q_2 \xrightarrow{e_2} \dots \xrightarrow{e_n} q_n$ is called a path automaton, characterized by its initial state q_1 and string $s = e_1 e_2 \dots e_n$, denoted by $PA(q_1, s)$, and defined as $PA(q_1, s) = (\{q_1, \dots, q_n\}, \{q_1\}, \{e_1, \dots, e_n\}, \delta_{PA})$, with $\delta_{PA}(q_i, e_i) = q_{i+1}$, $i = 1, \dots, n - 1$. $PA(q'_1, s')$ is defined, similarly.

Definition 12: (Interleaving) Given two sequences $q_1 \xrightarrow{e_1} q_2 \xrightarrow{e_2} \dots \xrightarrow{e_n} q_n$ and $q'_1 \xrightarrow{e'_1} q'_2 \xrightarrow{e'_2} \dots \xrightarrow{e'_m} q'_m$, the interleaving of their corresponding strings, $s = e_1 e_2 \dots e_n$ and $s' = e'_1 e'_2 \dots e'_m$, is denoted by $s|s'$, and defined as $s|s' = L\{PA(q_1, s) || PA(q'_1, s')\}$.

Example 2: Consider three strings $s_1 = e_1 a$, $s_2 = a e_2$ and $s_3 = a e_1$. Then the interleaving of s_1 and s_2 is $s_1|s_2 = \overline{e_1 a e_2}$ while the interleaving of two strings s_2 and s_3 becomes $s_2|s_3 = \overline{\{a e_1 e_2, a e_2 e_1\}}$.

Based on these definitions, we are now ready to formally define the decomposability of an automaton with respect to parallel composition and natural projections as follows.

Definition 13: (Automaton decomposability, or bisimulation synthesis modulo [15]) A task automaton A_S with the event set E and local event sets $E_i, i = 1, \dots, n$, $E = \bigcup_{i=1}^n E_i$, is said to be decomposable with respect to parallel composition and natural projections $P_i : A_S \rightarrow P_i(A_S)$,

$i = 1, \dots, n$, if $\prod_{i=1}^n P_i(A_S) \cong A_S$.

Now, let us see a motivating example to illustrate the decomposition procedure.

Example 3: Consider the task automaton A_S and its local event sets in Example 1. This automaton is decomposable with respect to parallel composition and natural projections, since $A_S \cong P_1(A_S) \parallel P_2(A_S)$, leading to $L(A_S) = L(P_1(A_S) \parallel P_2(A_S)) = \{\varepsilon, a, ae_1, ae_1b, e_2, e_2e_4, e_2e_4b\}$.

Two automata

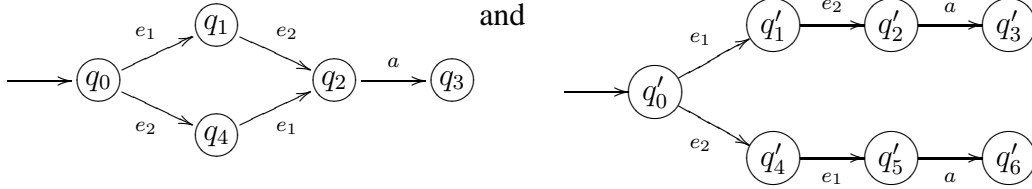

with $E = E_1 \cup E_2$, $E_1 = \{a, e_1\}$, $E_2 = \{a, e_2\}$ are other examples of decomposable automata.

Note that, these two automata are bisimilar (with the bisimulation relation $R = \{(q_0, q'_0), (q_1, q'_1), (q_2, q'_2), (q_3, q'_3), (q_4, q'_4), (q_2, q'_5), (q_3, q'_6)\}$), but not isomorphic. The first one is concrete (decomposable in the sense of isomorphism; satisfying *FD* (forward diamond) and *ID* (independent diamond)) as well as decomposable (in the sense of bisimulation). The latter automaton, on the other hand, is decomposable, but not concrete.

Examples 3 shows a decomposable task automaton; however, to deal with the top - down design we need to understand whether any task automaton is decomposable or not.

Problem 1: Given a deterministic task automaton A_S and local event sets $E_i, i = 1, \dots, n$, is it always possible to decompose A_S with respect to parallel composition and natural projections $P_i, i = 1, \dots, n$?

To answer this question, we examine the following example.

Example 4: Consider an automaton A_S :

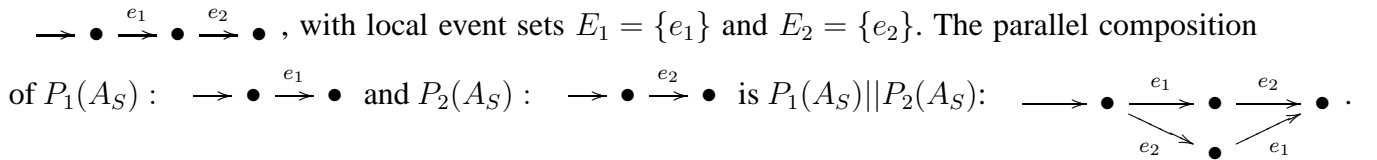

One can observe that $A_S \prec P_1(A_S) \parallel P_2(A_S)$ but $P_1(A_S) \parallel P_2(A_S) \not\prec A_S$ leading to $L(A_S) = \{\varepsilon, e_1, e_1e_2\} \subseteq L(P_1(A_S) \parallel P_2(A_S)) = \{\varepsilon, e_1, e_1e_2, e_2, e_2e_1\}$, but $L(P_1(A_S) \parallel P_2(A_S)) \not\subseteq L(A_S)$. Therefore, A_S is not decomposable with respect to parallel composition and natural projections $P_i, i = 1, 2$.

Therefore, not all automata are decomposable with respect to parallel composition and natural projections. Then, a natural follow-up question is what makes an automaton decomposable. It can be formally stated as follows.

Problem 2: Given a deterministic task automaton A_S and local event sets E_i , $i = 1, \dots, n$, what are the necessary and sufficient conditions that A_S is decomposable with respect to parallel composition and natural projections $P_i : A_S \rightarrow P_i(A_S)$, $i = 1, \dots, n$, such that $\prod_{i=1}^n P_i(A_S) \cong A_S$?

This problem will be addressed in the following two sections. In the next section, we will deal with the case of two agents and present necessary and sufficient conditions for decomposability. Then, the result is generalized in Section IV to a finite number of agents, as a sufficient condition.

III. TASK DECOMPOSITION FOR TWO AGENTS

In order for $A_S \cong P_1(A_S) \parallel P_2(A_S)$, from the definition of bisimulation, it is required to have $A_S \prec P_1(A_S) \parallel P_2(A_S)$; $P_1(A_S) \parallel P_2(A_S) \prec A_S$, and the simulation relations are symmetric. These requirements are provided by the following three lemmas. Firstly, the following simulation relationship always holds true.

Lemma 1: Consider any deterministic automaton A_S with event set $E = E_1 \cup E_2$, local event sets E_i , and natural projections P_i , $i = 1, 2$. Then $A_S \prec P_1(A_S) \parallel P_2(A_S)$.

Proof: See the Appendix for proof. ■

This lemma shows that, in general, $P_1(A_S) \parallel P_2(A_S)$ simulates A_S . The similarity of $P_1(A_S) \parallel P_2(A_S)$ to A_S , however, is not always true (see Example 4), and needs some conditions as stated in the following lemma.

Lemma 2: Consider a deterministic automaton $A_S = (Q, q_0, E = E_1 \cup E_2, \delta)$ and natural projections $P_i : A_S \rightarrow P_i(A_S)$, $i = 1, 2$. Then, $P_1(A_S) \parallel P_2(A_S) \prec A_S$ if and only if A_S satisfies the following conditions: $\forall e_1 \in E_1 \setminus E_2, e_2 \in E_2 \setminus E_1, q \in Q, s \in E^*$:

- *DC1* : $[\delta(q, e_1)! \wedge \delta(q, e_2)!] \Rightarrow [\delta(q, e_1 e_2)! \wedge \delta(q, e_2 e_1)!]$;
- *DC2* : $\delta(q, e_1 e_2 s)! \Leftrightarrow \delta(q, e_2 e_1 s)!$, and
- *DC3* : $\forall s, s' \in E^*$, sharing the same first appearing common event $a \in E_1 \cap E_2$, $s \neq s'$, $q \in Q$: $\delta(q, s)! \wedge \delta(q, s')! \Rightarrow \delta(q, p_1(s) \parallel p_2(s'))! \wedge \delta(q, p_1(s') \parallel p_2(s))!$.

Proof: See the Appendix for proof. ■

Next, we need to show that the two simulation relations R_1 (for $A_S \prec P_1(A_S)||P_2(A_S)$) and R_2 (for $P_1(A_S)||P_2(A_S) \prec A_S$), defined by the above two lemmas, are symmetric.

Lemma 3: Consider an automaton $A_S = (Q, q_0, E = E_1 \cup E_2, \delta)$ with natural projections $P_i : A_S \rightarrow P_i(A_S)$, $i = 1, 2$. If A_S is deterministic, $A_S \prec P_1(A_S)||P_2(A_S)$ with the simulation relation R_1 and $P_1(A_S)||P_2(A_S) \prec A_S$ with the simulation relation R_2 , then $R_1^{-1} = R_2$ (i.e., $\forall q \in Q, z \in Z: (z, q) \in R_2 \Leftrightarrow (q, z) \in R_1$) if and only if DC4: $\forall i \in \{1, 2\}, x, x_1, x_2 \in Q_i, x_1 \neq x_2, e \in E_i, t \in E_i^*, \delta_i(x, e) = x_1, \delta_i(x, e) = x_2: \delta_i(x_1, t)! \Leftrightarrow \delta_i(x_2, t)!$.

Proof: See the proof in the Appendix. ■

Based on these lemmas, the main result on task automaton decomposition is given as follows.

Theorem 1: A deterministic automaton $A_S = (Q, q_0, E = E_1 \cup E_2, \delta)$ is decomposable with respect to parallel composition and natural projections $P_i : A_S \rightarrow P_i(A_S)$, $i = 1, 2$, such that $A_S \cong P_1(A_S)||P_2(A_S)$ if and only if A_S satisfies the following decomposability conditions (DC): $\forall e_1 \in E_1 \setminus E_2, e_2 \in E_2 \setminus E_1, q \in Q, s \in E^*$,

- DC1: $[\delta(q, e_1)! \wedge \delta(q, e_2)!] \Rightarrow [\delta(q, e_1e_2)! \wedge \delta(q, e_2e_1)!]$;
- DC2: $\delta(q, e_1e_2s)! \Leftrightarrow \delta(q, e_2e_1s)!$, and
- DC3: $\forall s, s' \in E^*$, sharing the same first appearing common event $a \in E_1 \cap E_2, s \neq s', q \in Q: \delta(q, s)! \wedge \delta(q, s')! \Rightarrow \delta(q, p_1(s)|p_2(s'))! \wedge \delta(q, p_1(s')|p_2(s))!$;
- DC4: $\forall i \in \{1, 2\}, x, x_1, x_2 \in Q_i, x_1 \neq x_2, e \in E_i, t \in E_i^*, \delta_i(x, e) = x_1, \delta_i(x, e) = x_2: \delta_i(x_1, t)! \Leftrightarrow \delta_i(x_2, t)!$.

Proof: According to Definition 5, $A_S \cong P_1(A_S)||P_2(A_S)$ if and only if $A_S \prec P_1(A_S)||P_2(A_S)$ (that is always true due to Lemma 1), $P_1(A_S)||P_2(A_S) \prec A_S$ (that it is true if and only if DC1, DC2 and DC3 are true, according to Lemma 2) and the simulation relations are symmetric, i.e., $R_1^{-1} = R_2$ (that for a deterministic automaton A_S , when $A_S \prec P_1(A_S)||P_2(A_S)$ with simulation relation R_1 and $P_1(A_S)||P_2(A_S) \prec A_S$ with simulation relation R_2 , due to Lemma 3, $R_1^{-1} = R_2$ holds true if and only if DC4 is satisfied). Therefore, $A_S \cong P_1(A_S)||P_2(A_S)$ if and only if DC1, DC2, DC3 and DC4 are satisfied. ■

Remark 1: Intuitively, the decomposability condition DC1 means that for any successive or adjacent pair of private events $(e_1, e_2) \in \{(E_1 \setminus E_2, E_2 \setminus E_1), (E_2 \setminus E_1, E_1 \setminus E_2)\}$ (from different private event sets), both orders e_1e_2 and e_2e_1 should be legal from the same state, unless they are mediated by a common string.

Furthermore, e_1e_2 and e_2e_1 are not required to meet at the same state (unlike FD and ID in [16]); but due to $DC2$, any string $s \in E^*$ after them should be the same, or in other words, if e_1 and e_2 are necessary conditions for occurrence of a string s , then any order of these two events would be legal for such occurrence (see Example 3). Note that, as a special case, s could be ε .

The condition $DC3$ means that if two strings s and s' share the same first appearing common event, then any interleaving of these two strings should be legal in A_S . This requirement is due to synchronization of projections of these strings in $P_1(A_S)$ and $P_2(A_S)$.

The last condition, $DC4$, ensures the symmetry of mutual simulation relations between A_S and $P_1(A_S)||P_2(A_S)$. Given the determinism of A_S , this symmetry is guaranteed when each local task automaton bisimulates a deterministic automaton, leading to the existence of a deterministic automaton that is bisimilar to $P_1(A_S)||P_2(A_S)$. If the simulation relations are not symmetric, then some of the sequences that are allowed in A_S will be disabled in $P_1(A_S)||P_2(A_S)$.

The notion of language decomposability [22] is comparable with $DC2$ and means that any order of any successive events in any string of the language specification should be legal, or at least one of its projections (from the viewpoint of the corresponding local observer) should be capable of distinguishing this order. It also embodies a notion similar to $DC3$, stating that the global languages specification should contain all possible interleaving languages of all local languages. This notion, however, is not capable of capturing the other two conditions on the decision on the switch between adjacent transitions ($DC1$), and existence of deterministic bisimilar automata to $P_1(A_S)$ and $P_2(A_S)$ ($DC4$). The automaton decomposability conditions in this result, in terms of bisimulation, besides checking the capability of local plants on decision making on the orders of event ($DC2$), they should also be capable of decision making on the switches ($DC1$), and moreover, the synchronization of local task automata should not lead to an illegal behavior ($DC3$), and also ensures that like A_S , $P_1(A_S)||P_2(A_S)$ also has a deterministic behavior ($DC4$).

The decomposability conditions can be then paraphrased as follows: Any decision on order or switch between two transitions that cannot be made locally (by at least one local controller) should not be critical globally (any result of the decision should be allowed); and interpretation of the global task by the team of local plants should neither allow an illegal behavior (a string that is not in global task automaton), nor disallow a legal behavior (a string that appears in the global task automaton).

The following four examples illustrate the decomposability conditions for decomposable and undecomposable automata.

Example 5: This example illustrates the concept of decision making on switching between the events, mentioned in Remark 1. Furthermore, it shows an automaton that satisfies $DC2$, $DC3$ and $DC4$, but not $DC1$, leading to undecomposability. The automaton A_S :

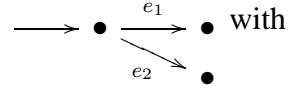

with local event sets $E_1 = \{e_1\}$ and $E_2 = \{e_2\}$, is not decomposable as the parallel composition of

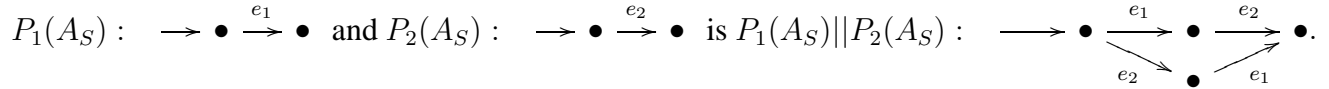

which does not bisimulate A_S . Here, A_S is not decomposable with respect to parallel composition and natural projections P_i , $i = 1, 2$, since two events $e_1 \in E_1 \setminus E_2$ and $e_2 \in E_2 \setminus E_1$ do not respect $DC1$, as none of the local plant takes in charge of decision making on the switching between these two events. One can observe that, if in this example $e_1 \in E_1 \setminus E_2$ and $e_2 \in E_2 \setminus E_1$ were separated by a common event $a \in E_1 \cap E_2$, then

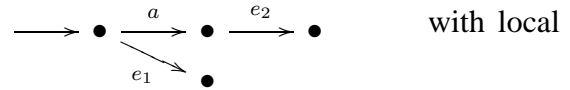

with local event sets $E_1 = \{e_1, a\}$ and $E_2 = \{e_2, a\}$, was decomposable, since the decision on the switch between e_1 and a could be made in E_1 and then E_2 could be responsible for the decision on the order of a and e_2 .

Example 6: The automaton A_S in Example 3 shows an automaton that respects $DC1$, $DC3$ and $DC4$, but is undecomposable due to violation of $DC2$. Here, A_S is not decomposable since none of the local plants take in charge of decision making on the order of two events $e_1 \in E_1 \setminus E_2$ and $e_2 \in E_2 \setminus E_1$. If $e_1 \in E_1 \setminus E_2$ and $e_2 \in E_2 \setminus E_1$ were separated by a common event $a \in E_1 \cap E_2$, then the automaton $\rightarrow \bullet \xrightarrow{e_1} \bullet \xrightarrow{a} \bullet \xrightarrow{e_2} \bullet$ with local event sets $E_1 = \{e_1, a\}$ and $E_2 = \{e_2, a\}$, was decomposable, since the decision on the orders of e_1 and a and then a and e_2 could be made in E_1 and then E_2 , subsequently. As another example, consider an automaton A_S :

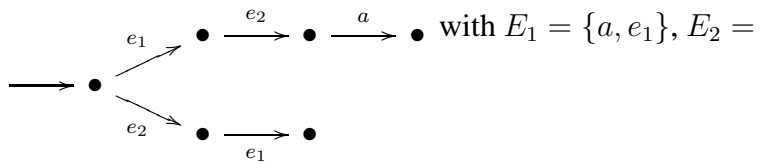

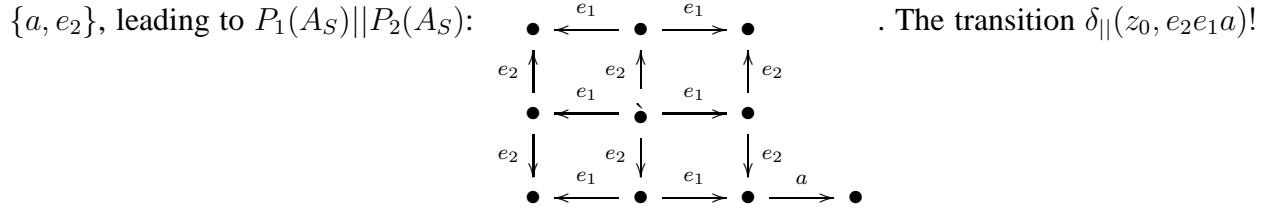

in $P_1(A_S) || P_2(A_S)$, but $\neg\delta(q_0, e_2e_1a)!$ in A_S . Therefore, A_S is not decomposable. If the lower branch was continued with a transition on a after e_2e_1 , then the automaton was decomposable (See Example 3).

Example 7: This example illustrates an automaton that satisfies *DC1*, *DC2* and *DC4*, but it is undecomposable as it does not fulfil *DC3*, since new strings appear in $P_1(A_S) || P_2(A_S)$ from the interleaving of two strings in $P_1(A_S)$ and $P_2(A_S)$, but they are not legal in A_S . Consider the task automaton A_S :

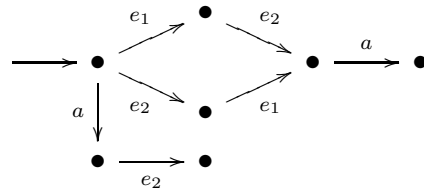

with $E_1 = \{a, e_1\}$, $E_2 = \{a, e_2\}$, leading

to $P_1(A_S) \cong$

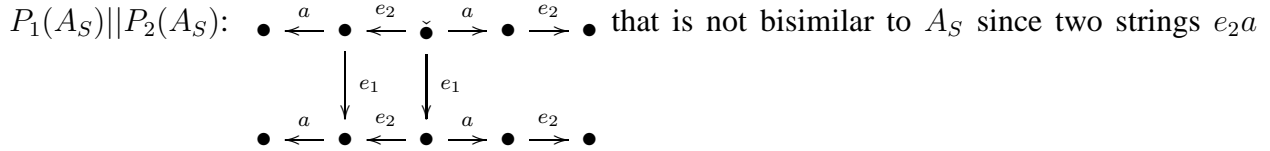
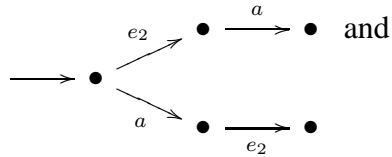
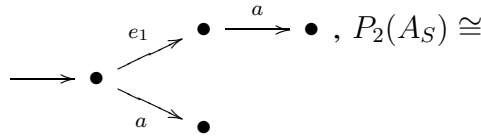

and e_1ae_2 are newly generated, while they do not appear in A_S , although both $P_1(A_S)$ and $P_2(A_S)$ are deterministic.

Example 8: This example illustrates an automaton that satisfies *DC1* and *DC2*, and *DC3*, but is undecomposable as it does not fulfil *DC4*. Consider the task automaton

A_S :

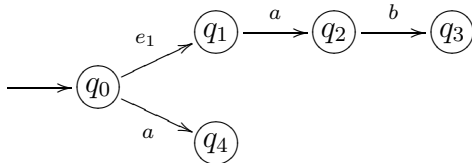

with $E_1 = \{a, b, e_1\}$, $E_2 = \{a, b\}$, leading to

$P_1(A_S)$:

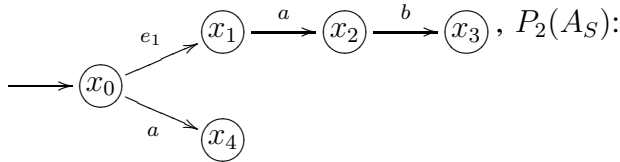

$P_2(A_S)$:

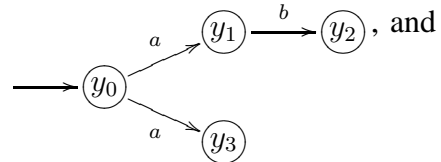

$P_1(A_S)||P_2(A_S)$:

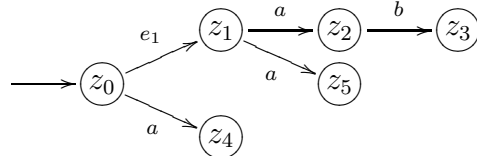

which is not bisimilar to A_S . This task

automaton A_S satisfies $DC1$ and $DC2$ as contains no successive/adjacent transitions defined on different local event sets. But, it does not fulfil $DC4$, although any string in $T = \{p_1(s)|p_2(s'), p_1(s')|p_2(s)\}$ (s and s' are the top and bottom strings in A_S and share the first appearing common event $a \in E_1 \cap E_2$), appears in A_S . The reason is that there exists a transition on string e_1a from z_0 to z_5 that stops in $P_1(A_S)||P_2(A_S)$, whereas, although e_1a transits from q_0 in A_S , it does not stop afterwards. This illustrate dissymmetry in simulation relations between A_S and $P_1(A_S)||P_2(A_S)$. Note that $A_S \prec P_1(A_S)||P_2(A_S)$ with the simulation relation R_1 over all events in E , from all states in Q into some states in Z , as $R_1 = \{(q_0, z_0), (q_1, z_1), (q_2, z_2), (q_3, z_3), (q_4, z_4)\}$. Moreover, $P_1(A_S)||P_2(A_S) \prec A_S$ with the simulation relation R_2 over all events in E , from all states in Z into some states in Q , as $R_2 = \{(z_0, q_0), (z_1, q_1), (z_2, q_2), (z_3, q_3), (z_4, q_4), (z_5, q_2)\}$. Therefore, although $A_S \prec P_1(A_S)||P_2(A_S)$ and $P_1(A_S)||P_2(A_S) \prec A_S$, $P_1(A_S)||P_2(A_S) \not\cong A_S$, since $\exists(z_5, q_2) \in R_2$, whereas $(q_2, z_5) \notin R_1$. If for stoping of string e_1a in $P_1(A_S)||P_2(A_S)$, there was a state in Q reachable from q_0 by e_1a and stopping there, then we would have $\forall q \in Q, z \in Z : (q, z) \in R_1 \Leftrightarrow (z, q) \in R_2$ and $P_1(A_S)||P_2(A_S) \cong A_S$.

It should be noted that the condition $DC4$ not only applies for nondeterminism on common events, but also it requires any nondeterminism on private event also to have a bisimilar deterministic counterpart. For example, consider the task automaton A_S :

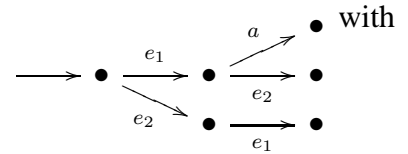

$E_1 = \{e_1, a\}$, $E_2 = \{e_2, a\}$. The parallel composition of $P_1(A_S)$:

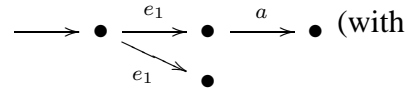

nondeterministic transition on private event e_1 and $P_2(A_S)$:

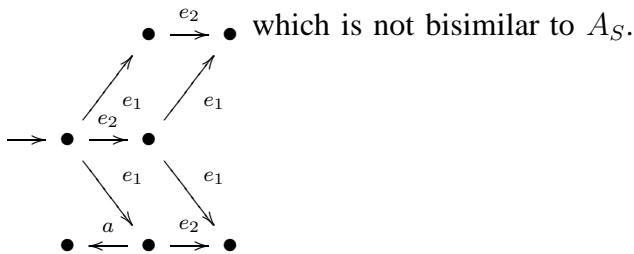
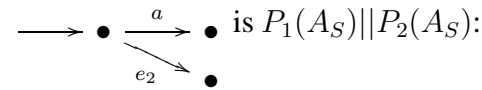

which is not bisimilar to A_S .

The automaton A_S :

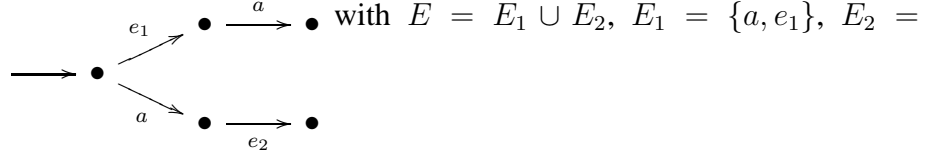

$\{a, e_2\}$, $P_1(A_S)$:

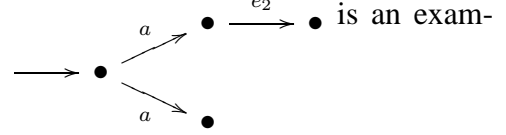
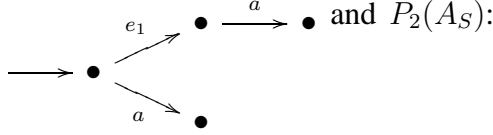

is an example of an undecomposable automaton that violates both $DC3$ and $DC4$. It violates $DC3$ since $\delta_{||}(z_0, e_1 a e_2)!$ in $P_1(A_S) || P_2(A_S)$, but $\neg \delta(q_0, e_1 a e_2)!$ in A_S , and it does not satisfy $DC4$ since $P_2(A_S)$ is nondeterministic and is not bisimilar to a deterministic automaton, leading to a string in $P_1(A_S) || P_2(A_S)$ that e_2 is disallowed after a while there is no such restriction in A_S . If A_S was A_S :

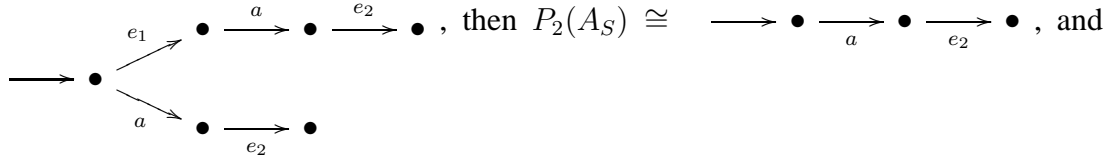

A_S was decomposable.

Remark 2: Example 8 also shows that the determinism of A_S does not reduce the bisimulation synthesis problem to language equivalence synthesis problem. Note that here, A_S and $P_1(A_S) || P_2(A_S)$ are language equivalent, but not bisimilar. The reason is that although A_S is deterministic, and $A_S \prec P_1(A_S) || P_2(A_S)$, $P_1(A_S) || P_2(A_S) \prec A_S$, the simulation relations are not symmetric due to existence of nondeterministic strings in $P_1(A_S) || P_2(A_S)$ that can not be replaced by a deterministic one. The nondeterminism in $P_1(A_S) || P_2(A_S)$ is inherited from a nondeterminism in $P_2(A_S)$. If A_S was in the form of A_S :

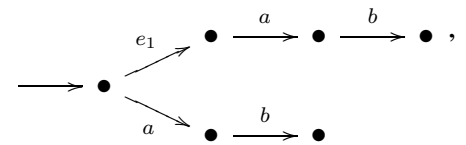

then $P_1(A_S) \cong A_S$, $P_2(A_S) \cong \longrightarrow \bullet \xrightarrow{a} \bullet \xrightarrow{b} \bullet$ and $P_1(A_S) || P_2(A_S) \cong A_S$.

IV. HIERARCHICAL DECOMPOSITION

The previous section showed the decomposition of an automaton with respect to the parallel composition and two local event sets. However, in practice, multi-agent systems are typically comprised of many individual agents that work as a team. The proposed procedure of decomposition can be generalized for more than two agents. However, the problem becomes rapidly complex as the number of agents increases. It is then advantageous to have a hierarchical decomposition

method to have only two individual event sets at a time for decomposition. Consider a task automaton A_S to be decomposed with respect to parallel composition and individual event sets $E_i, i = 1, 2, \dots, n$, so that $E = \bigcup_{i=1}^n E_i$. We propose the following algorithm as a sufficient condition for hierarchical decomposition of the given task automaton.

Algorithm 1: (Hierarchical Decomposition Algorithm)

- 1) $E = \bigcup_{i=1}^n E_i, \Sigma = \{E_1, \dots, E_n\}, K = \{1, \dots, n\}$.
- 2) $i = 1$, find $k \in K$ such that $\Sigma_i = E_k \in \Sigma, \bar{\Sigma}_i = \bigcup_{j \in K \setminus k} E_j$, so that A_S satisfies decomposability conditions *DC1-DC4* in Theorem 1, i.e., $A_S \cong P_{\Sigma_i}(A_S) \parallel P_{\bar{\Sigma}_i}(A_S)$.
- 3) $K = K \setminus k, \Sigma = \{E_j\}_{j \in K}, A_S = P_{\bar{\Sigma}_i}(A_S), i = i + 1$, go to Step 2.
- 4) Continue until $i = n - 1$ or no more decomposition is possible in $i = m - 1, m \leq n$. Then $\Sigma_m = \bar{\Sigma}_{m-1}$, and hence, A_S is decomposable with respect to parallel composition and natural projections into $\{\Sigma_1, \dots, \Sigma_m\} \subseteq \Sigma$, if the algorithm proceeds up to $i = m - 1$.

Remark 3: The algorithm will terminate due to finite number of states and local event sets. If the algorithm successfully proceeds to step $n - 1$, the automaton A_S is decomposable and we obtain a complete decomposition of the global specifications into subtasks for each individual agent. However, it is unclear whether the algorithm can successfully terminate for any decomposable task automaton (necessity). The computational complexity of the algorithm in the worst case is of order $O(n^2(|E|^2 \times |Q| \times \kappa + \sum_{a \in E_1 \cap E_2} |p_a(L(A_S))|^2))$, where $\kappa = \max_{t \in L(A_S)} |t|$, assuming the number of appearing events as the length of loops. In practice, during the iterations, $|E|$ is replaced by $\bigcup_{j=1}^{|K|} E_j$ which is decreasing with respect to iteration. Moreover, the second term in the complexity expression shows that the less number of common events and the less appearance of common events in A_S , the less complexity.

Once the subtasks are obtained, the next step is the design of controllers for each agent to achieve these subtasks respectively. The following result shows that the fulfillment of the decomposed subtasks will imply the global specifications for the multi-agent systems. Before stating the theorem, following two lemmas are presented to be used for the proof.

Lemma 4:

$$P_{\Sigma_1}(A_S) \parallel P_{\Sigma_2}(A_S) \parallel \dots \parallel P_{\Sigma_{m-1}}(A_S) \parallel P_{\Sigma_m}(A_S) \cong P_{\Sigma_1}(A_S) \parallel (P_{\Sigma_2}(A_S) \parallel (\dots \parallel (P_{\Sigma_{m-1}}(A_S) \parallel P_{\Sigma_m}(A_S))))$$

Proof: See the proof in the Appendix. ■

Lemma 5: If two automata A_2 and A_4 (bi)simulate, respectively, A_1 and A_3 , then $A_2 \parallel A_4$ (bi)simulates $A_1 \parallel A_3$, i.e.,

- 1) $(A_1 \prec A_2) \wedge (A_3 \prec A_4) \Rightarrow (A_1 \parallel A_3 \prec A_2 \parallel A_4)$;
- 2) $(A_1 \cong A_2) \wedge (A_3 \cong A_4) \Rightarrow (A_1 \parallel A_3 \cong A_2 \parallel A_4)$;

Proof: See the proof in the Appendix. ■

Theorem 2: Consider a plant, represented by a deterministic parallel distributed system $A_\Delta = \parallel_{i=1}^n A_{P_i}$, with given local event sets E_i , $i = 1, \dots, n$, and given specification represented by a deterministic decomposable automaton $A_S \cong \parallel_{i=1}^n P_i(A_S)$, with $E = \bigcup_{i=1}^n E_i$. If the Algorithm 1 continues up to $i = n - 1$, then designing local controllers A_{C_i} , so that $A_{C_i} \parallel A_{P_i} \cong P_i(A_S)$, $i = 1, 2, \dots, n$, derives the global closed loop system to satisfy the global specification A_S , in the sense of bisimilarity, i.e., $\parallel_{i=1}^n (A_{C_i} \parallel A_{P_i}) \cong A_S$.

Proof: Algorithm 1 is a direct extension of Theorem 1 combined with Lemma 4. Then, choosing local controllers A_{C_i} , so that $A_{C_i} \parallel A_{P_i} \cong P_i(A_S)$, $i = 1, 2, \dots, n$, due to Lemma 5.2 leads to $\parallel_{i=1}^n (A_{C_i} \parallel A_{P_i}) \cong \parallel_{i=1}^n P_i(A_S) \cong A_S$. ■

Now, if *DC1-DC4* is reduced to *DC1-DC3* (Theorem 1 is reduced into Lemma 2), then $\parallel_{i=1}^n P_i(A_S) \cong A_S$ is reduced into $\parallel_{i=1}^n P_i(A_S) \prec A_S$, and hence, choosing local controllers A_{C_i} , so that $A_{C_i} \parallel A_{P_i} \prec P_i(A_S)$, $i = 1, 2, \dots, n$, due to Lemma 5.1 leads to $\parallel_{i=1}^n (A_{C_i} \parallel A_{P_i}) \prec \parallel_{i=1}^n P_i(A_S) \prec A_S$. Therefore,

Corollary 1: Considering the plant and global task as stated in Theorem 2, if *DC1-DC4* is reduced to *DC1-DC3* in Algorithm 1 and it continues up to $i = n - 1$, then designing local controllers A_{C_i} , so that $A_{C_i} \parallel A_{P_i} \prec P_i(A_S)$, $i = 1, 2, \dots, n$, derives the global closed loop system to satisfy the global specification A_S , in the sense of similarity, i.e., $\parallel_{i=1}^n (A_{C_i} \parallel A_{P_i}) \prec A_S$.

Remark 4: It should be noted that in this approach, the parallel composition requires a fixed communication pattern among the “local” automata to synchronize on their common events. This framework is therefore suitable for static distributed systems. For moving agent systems, the agents are required to provide large enough communication range to ensure that the connectivity is preserved during the movement, to ensure the correct synchronization on the common events.

V. EXAMPLE

Consider a cooperative multi-robot system (MRS) configured in Figure 1. The MRS consists of three robots R_1 , R_2 and R_3 . All robots have the same communication and positioning capabilities. Furthermore, the robot R_2 has the rescue and fire-fighting capabilities, while R_1 and R_3 are normal robots with the pushing capability. Initially, all of them are positioned in Room 1. Rooms 2 and 3 are accessible from Room 1 by one-way door D_2 and two-way doors D_1 and D_3 , as shown in Figure 1. All doors are equipped with spring to be closed automatically, when there is no force to keep them open.

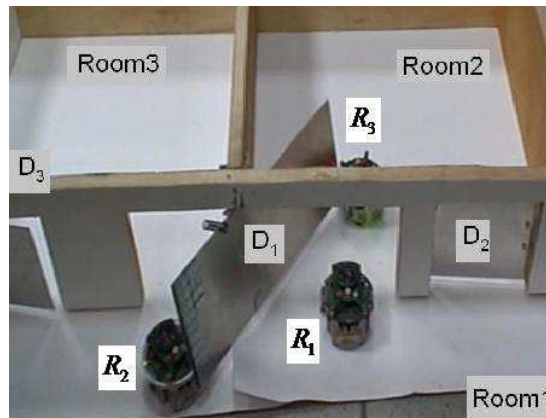

Fig. 1. The environment of MRS coordination example.

Assume that Room 2 requests help for fire extinguishing. After the help announcement, the Robot R_2 is required to go to Room 2, urgently from D_2 and accomplish its task there and come back immediately to Room 1. However, D_2 is a one-way door, and, D_1 is a heavy door and needs cooperation of two robots R_1 and R_3 to be opened. To save time, as soon as the robots hear the help request from Room 2, R_2 and R_3 go to Rooms 2 and 3, from D_2 and D_3 , respectively, and then R_1 and R_3 position on D_1 , synchronously open D_1 and wait for accomplishment of task of R_2 in Room 2 and returning to Room 1 (R_2 is fast enough). Afterwards, R_1 and R_3 move backward to close D_1 and then R_3 returns back to Room 1 from D_3 . All robots then stay at Room 1 for the next task.

These requirements can be translated into a task automaton for the robot team as it is illustrated in Figure 2, defined over local event sets $E_1 = \{h_1, R_1toD_1, R_1onD_1, FWD, D_1opened, R_2in1,$

$BWD, D_1closed, r\}$, $E_2 = \{h_2, R_2to2, R_2in2, D_1opened, R_2to1, R_2in1, r\}$, and $E_3 = \{h_3, R_3to3, R_3in3, R_3toD_1, R_3onD_1, FWD, D_1opened, R_2in1, BWD, D_1closed, R_3to1, R_3in1, r\}$, with $h_i := R_i$ received help request, $i = 1, 2, 3$; $R_jtoD_1 :=$ command for R_j to position on D_1 , $j = 1, 3$; $R_jonD_1 := R_j$ has positioned on D_1 , $j = 1, 3$; $FWD :=$ command for moving forward (to open D_1); $BWD :=$ command for moving backward (to close D_1); $D_1opened := D_1$ has been opened; $D_1closed := D_1$ has been closed; $r :=$ command to go to initial state for the next implementation; $R_itok :=$ command for R_i to go to Room k , and $R_ink := R_i$ has gone to Room k , $i = 1, 2, 3$, $k = 1, 2, 3$.

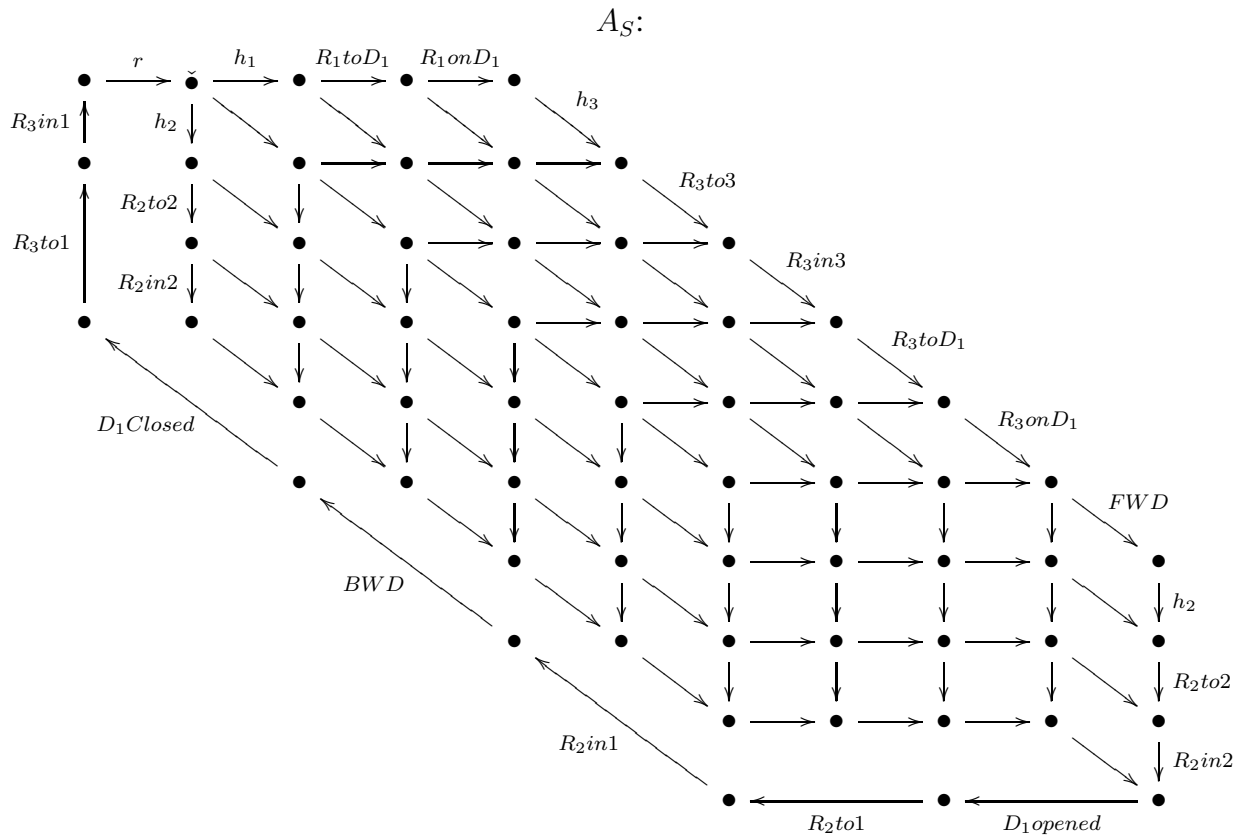

Fig. 2. Task automaton A_S for robot team.

The states show the labels of transitions after occurrence, and hence are not labeled, here. Meaning that $\delta(x, e) = y$ is interpreted as follows: Once e occurs in x , it transits into y and this state y is labeled by $e(occurred)$. For example, when “help request” event happens, the state of each robot transits from the initial state to the state “the robot received help request”.

We check decomposability condition for this global task automaton with respect to $\Sigma_1 = E_2$ and $\bar{\Sigma}_1 = E_1 \cup E_3$ for the first stage in Algorithm 1. Firstly, $\{h_2, R_2to2, R_2in2\} = \Sigma_1 \setminus \bar{\Sigma}_1$ can occur in any order with respect to $\{h_1, R_1toD_1, R_1onD_1, h_3, R_3to3, R_3in3, R_3toD_1, R_3onD_1, FWD\} = \bar{\Sigma}_1 \setminus \Sigma_1$, as it is shown in the global automaton in Figure 2, satisfying *DC1* and *DC2*. Moreover, $D_1opened$, R_2in1 and r are common events, provided by R_1 , R_2 and R_3 , respectively, and informed to the other two robots upon occurrence.

Since $\{D_1opened, FWD\} \subseteq \bar{\Sigma}_1$, $\{R_2in2, D_1opened\} \subseteq \Sigma_1$, $\{D_1opened, R_2to1\} \subseteq \Sigma_1$, $\{R_2to1, R_2in1\} \subseteq \Sigma_1$, $\{R_2in1, BWD\} \subseteq \bar{\Sigma}_1$, $\{BWD, D_1closed\} \subseteq \bar{\Sigma}_1$, $\{D_1closed, R_3to1\} \subseteq \bar{\Sigma}_1$, $\{R_3to1, R_3in1\} \subseteq \bar{\Sigma}_1$, $\{R_3in1, r\} \subseteq \bar{\Sigma}_1$, $\{r, h_1\} \subseteq \bar{\Sigma}_1$, $\{r, h_2\} \subseteq \Sigma_1$, $\{r, h_3\} \subseteq \bar{\Sigma}_1$, and hence all these successive transitions satisfy *DC1* and *DC2*. Furthermore, all common events $\{D_1opened, R_2in1, r\} \subseteq \Sigma_1 \cap \bar{\Sigma}_1$ appear in only one branch, and hence, *DC3* is satisfied. Finally, $P_{\Sigma_1}(A_S)$ and $P_{\bar{\Sigma}_1}(A_S)$ are both deterministic, and hence, *DC4* is satisfied.

Therefore, due to Theorem 1, A_S can be decomposed into $P_2(A_S) = P_{\Sigma_1}(A_S) = A_2$ and $P_{1,3} = P_{\bar{\Sigma}_1}(A_S)$. The second stage of hierarchical decomposition, decomposes $P_{1,3}(A_S)$ into $A_1 = P_1(A_S)$ and $A_3 = P_3(A_S)$. The private transitions defined over $E_1 \setminus E_3 = \{h_1, R_1toD_1, R_1onD_1\}$ can occur in any order with respect to the transitions defined over the private local event set $E_3 \setminus E_1 = \{h_3, R_3to3, R_3in3, R_3toD_1, R_3onD_1\}$. Since $\{R_3onD_1, FWD\} \subseteq E_3$, $\{R_1onD_1, FWD\} \subseteq E_1$, $\{FWD, D_1opened\} \subseteq E_1 \cap E_3$, $\{D_1opened, R_2in1\} \subseteq E_1 \cap E_3$, $\{R_2in1, BWD\} \subseteq E_1 \cap E_3$, $\{BWD, D_1closed\} \subseteq E_1 \cap E_3$, $\{D_1closed, R_3to1\} \subseteq E_3$, $\{R_3to1, R_3in1\} \subseteq E_3$, $\{R_3in1, r\} \subseteq E_3$, $\{r, h_3\} \subseteq E_3$ and $\{r, h_1\} \subseteq E_1$, then *DC1* and *DC2* are satisfied. Furthermore, since all common events $\{FWD, D_1opened, R_2in1, BWD, D_1closed, r\} \subseteq E_1 \cap E_3$ appear in only one branch in $P_{1,3}(A_S)$, therefore, there are no pairs of strings violating *DC3*, and hence, *DC3* is also satisfied. Moreover, $P_1(A_S)$ and $P_2(A_S)$ are both deterministic, and consequently, $P_{1,3}(A_S)$ satisfies *DC4*. The results of two decomposition stages are shown in Figures 3 and 4, such that $P_1(A_S) \parallel P_2(A_S) \parallel P_3(A_S) \cong A_S$.

It can be seen that the design of supervisor to satisfy these individual task automata is easier than the design of a global supervisor to satisfy the global specification. Furthermore, since the specification is determined for each agent, the global task can be achieved in a decentralized fashion.

Discussions on the design of supervisory control (for local local plants and local task automata) and also refining of the low level continuous controllers can be found in [11], [12], [23], [24]

$P_{1,3}(A_S)$:

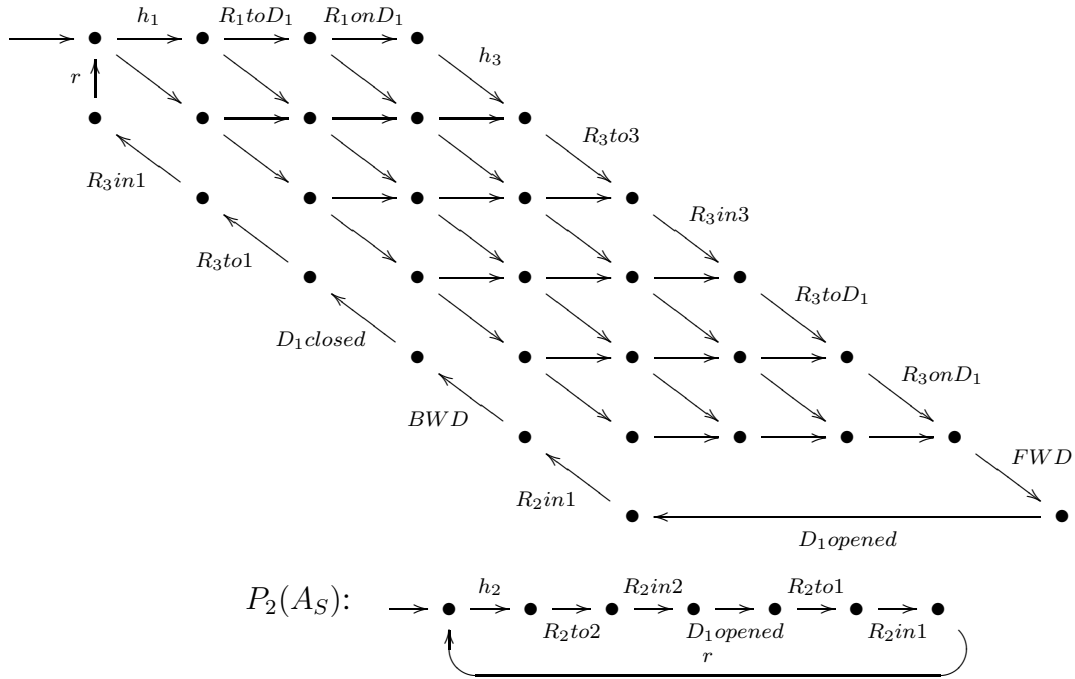

Fig. 3. $P_2(A_S)$ for R_2 and $P_{\{E_1 \cup E_3\}}(A_S)$ for the team $\{R_1, R_3\}$.

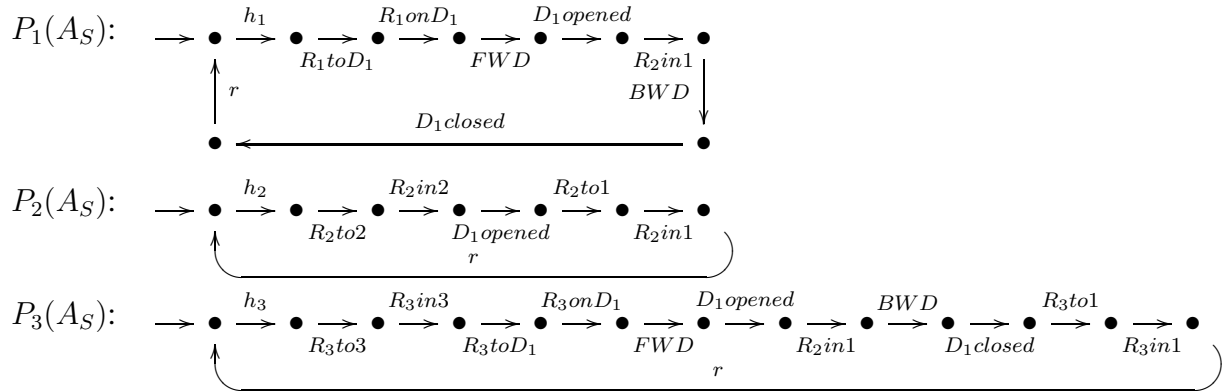

Fig. 4. $P_1(A_S)$ for R_1 ; $P_2(A_S)$ for R_2 and $P_3(A_S)$ for R_3 .

and [9].

This scenario has been successfully implemented on a team of three ground robots, shown in Figure 1.

VI. CONCLUSION

The paper proposed a formal method for automaton decomposition that facilitates the top-down distributed cooperative control of multi-agent systems. Given a set of agents whose logical behaviors can be modeled as a parallel distributed system, and a global task automaton, the paper has the following contributions: firstly, we have provided necessary and sufficient conditions for decomposability of an automaton with respect to parallel composition and natural projections into two local event sets; secondly, the approach has been extended into a sufficient condition for an arbitrary finite number of agents, using a hierarchical algorithm, and finally, we have shown that if a global task automaton is decomposed into the local tasks for the individual agents, designing the local supervisors for each agent, satisfying the local tasks, guarantees that the closed loop system of the team of agents satisfies the global specification.

The implementation of this approach is decentralized, in the sense that there is no central unit to coordinate the agents; however, they need communication to synchronize on common events. This approach differs from the classical decentralized supervisory control that refers to the configuration of a monolithic plant, controlled by several supervisors that are distributed into different nodes [11]. The proposed approach is more suitable for those applications with distributed configurations for both plant and supervisor, such as multi-robot coordination systems and sensor/actuator networks. In addition, due to associativity property of parallel composition, the proposed approach can be modular such that when a new task automaton is introduced to the systems, one can decompose the new global task automaton, and then compose the new local task automata with the corresponding old local task automata.

VII. APPENDIX

A. Proof for Lemma 1

We prove $A_S \prec P_1(A_S) \parallel P_2(A_S)$ by showing that $R = \{(q, z) \in Q \times Z \mid \exists s \in E^*, \delta(q_0, s) = q, z = ([q]_1, [q]_2)\}$ is a simulation relation, defined on all events in E and all reachable states in A_S . Consider $A_S = (Q, q_0, E = E_1 \cup E_2, \delta)$, $P_i(A_S) = (Q_i, q_i^0, E_i, \delta_i)$, $i = 1, 2$, $P_1(A_S) \parallel P_2(A_S) = (Z, z_0, E, \delta_{\parallel})$. Then, $\forall q, q' \in Q, e \in E, \delta(q, e) = q'$, according to definition of natural projection (Definition 10) $[q']_i = \begin{cases} \delta_i([q]_i, e) & \text{if } e \in E_i; \\ [q]_i & \text{if } e \notin E_i \end{cases}$, $i = 1, 2$, and due to definition of parallel compo-

sition (Definition 7) $\delta_{||}([q]_1, [q]_2, e) = ([q']_1, [q']_2) = \begin{cases} (\delta_1([q]_1, e), \delta_2([q]_2, e)), & \text{if } e \in E_1 \cap E_2; \\ (\delta_1([q]_1, e), [q]_2), & \text{if } e \in E_1 \setminus E_2; \\ ([q]_1, \delta_2([q]_2, e)), & \text{if } e \in E_2 \setminus E_1. \end{cases}$

This is true for any $q \in Q$, particularly for q_0 . This reasoning can be repeated for any reachable state in Q . Therefore, starting from q_0 and taking $(q_0, Z_0 = ([q_0]_1, [q_0]_2)) \in R$, from the above construction, it follows that for any reachable state in Q ($\exists s \in E^*, \delta(q_0, s) = q$) and $q' \in Q$, $e \in E$, $\delta(q, e) = q'$, there exists $z = ([q]_1, [q]_2)$, $z' = ([q']_1, [q']_2)$ such that $\delta(z, e) = z'$, and we can take $(q, z) \in R$ and $(q', z') \in R$. Therefore, $R = \{(q, z) \in Q \times Z \mid \exists s \in E^*, \delta(q_0, s) = q, z = ([q]_1, [q]_2)\}$ is a simulation relation, defined over all $e \in E$, and all reachable states in A_S , and hence, $A_S \prec P_1(A_S) || P_2(A_S)$.

B. Proof for Lemma 2

We use two following lemmas during the proof.

Lemma 6: Consider a deterministic automaton $A_S = (Q, q_0, E = E_1 \cup E_2, \delta)$. Then $DC1 \wedge DC2 \Rightarrow [\forall s \in E^*, \delta(q_0, s) \Rightarrow \delta(q_0, p_1(s)|p_2(s))]!$ in A_S .

This lemma means that for any transition defined on a string in A_S , all path automata defined on the interleaving of $p_1(s)$ and $p_2(s)$ in $P_1(A_S) || P_2(A_S)$ are simulated by A_S , provided $DC1$ and $DC2$.

Proof: Consider a deterministic automaton $A_S = (Q, q_0, E = E_1 \cup E_2, \delta)$, a string $s \in E^*$, $\delta(q_0, s) = q$, and its projections $p_1(s)$, $p_2(s)$ with $\delta_1(x_0, p_1(s)) = x$, $\delta_2(y_0, p_2(s)) = y$ and $(x, y) \in \delta_{||}((x_0, y_0), p_1(s)|p_2(s))$, in $P_1(A_S)$, $P_2(A_S)$ and $P_1(A_S) || P_2(A_S)$, respectively. Any string s can be written as $s = \omega^1 \gamma^1 \dots \omega^K \gamma^K$, with $\omega^k \in [E \setminus (E_1 \cap E_2)]^*$, $\gamma^k \in (E_1 \cap E_2)^*$, $p_1(\omega^k) = \alpha^k = \alpha_0^k \dots \alpha_{m_k}^k$, $\alpha_0^k = \varepsilon$, $p_2(\omega^k) = \beta^k = \beta_0^k \dots \beta_{n_k}^k$, $\beta_0^k = \varepsilon$, $p_1(\gamma^k) = p_2(\gamma^k) = \gamma^k = \gamma_0^k \dots \gamma_{r_k}^k$, $\gamma_0^k = \varepsilon$. The case $m_k = 0$, $n_k = 0$, $r_k = 0$, $K = 0$, results in $p_1(\omega^k) = \varepsilon$, $p_2(\omega^k) = \varepsilon$, $\gamma^k = \varepsilon$ and $s = \varepsilon$. Based on this setting and definition of parallel composition, for $k = 0, \dots, K$, $i = 0, \dots, m_k$, $j = 0, \dots, n_k$ and $r = 0, \dots, r_k$, the interleaving $p_1(s)|p_2(s)$ is evolved in $P_1(A_S) || P_2(A_S)$ as follows: $\forall (x_{k+i}, y_{k+j}) \in Q_1 \times Q_2$: $\delta_{||}((x_{k+i}, y_{k+j}), \alpha_i^k) = (\delta_1(x_{k+i}, \alpha_i^k), y_{k+j})$, $\delta_{||}((\delta_1(x_{k+i}, \alpha_i^k), y_{k+j}), \beta_j^k) = ((\delta_1(x_{k+i}, \alpha_i^k), \delta_2(y_{k+j}, \beta_j^k)), \delta_{||}((x_{k+i}, y_{k+j}), \beta_j^k) = (x_{k+i}, \delta_2(y_{k+j}, \beta_j^k))$, $\delta_{||}((x_{k+i}, \delta_2(y_{k+j}, \beta_j^k)), \alpha_i^k) = (\delta_1(x_{k+i}, \alpha_i^k), \delta_2(y_{k+j}, \beta_j^k))$, $\delta_{||}((x_{k+m_k+r}, y_{k+n_k+r}), \gamma_r^k) = (\delta_1(x_{k+m_k+r}, \gamma_r^k), \delta_2(y_{k+n_k+r}, \gamma_r^k))$ with $\delta_1(x_{k+i}, \alpha_i^k) = \begin{cases} x_{k+i} & \text{if } \alpha_i^k = \varepsilon \\ x_{k+i+1} & \text{if } \alpha_i^k \neq \varepsilon \end{cases}$, $\delta_2(y_{k+j}, \beta_j^k) =$

$$\left\{ \begin{array}{l} y_{k+j} \quad \text{if } \beta_j^k = \varepsilon \\ y_{k+j+1} \quad \text{if } \beta_j^k \neq \varepsilon \end{array} \right. \text{ and } (\delta_1(x_{k+m_k+r}, \gamma_r^k), \delta_2(y_{k+n_k+r}, \gamma_r^k)) = \left\{ \begin{array}{l} (x_{k+m_k+r}, y_{k+n_k+r}) \quad \text{if } \gamma_r^k = \varepsilon \\ (x_{k+m_k+r+1}, y_{k+n_k+r+1}) \quad \text{if } \gamma_r^k \neq \varepsilon \end{array} \right.$$

Moreover, *DC1* and *DC2* collectively imply that $\forall e_1 \in E_1 \setminus E_2, e_2 \in E_2 \setminus E_1, q \in Q, [\delta(q, e_1)! \wedge \delta(q, e_2)!] \vee \delta(q, e_1 e_2)! \vee \delta(q, e_2 e_1)! \Rightarrow \delta(q, e_1 e_2)! \wedge \delta(q, e_2 e_1)!$ which particularly means that $\forall k \in \{0, \dots, K\}, \forall \alpha_i^k, \beta_j^k, q_{i,j} \in Q, i = 0, \dots, m_k, j = 0, \dots, n_k, r = 0, \dots, r_k: \delta(q_{k+i, k+j}, \alpha_i^k \beta_j^k)! \wedge \delta(q_{k+i, k+j}, \beta_j^k \alpha_i^k)!$ with a simulation relation $R(\omega^k) = \{((x_{k+i}, y_{k+j}), q_{k+i, k+j}), (\delta_1(x_{k+i}, \alpha_i^k), y_{k+j}), \delta(q_{k+i, k+j}, \alpha_i^k), ((x_{k+i}, \delta_2(y_{k+j}, \beta_j^k))), \delta(q_{k+i, k+j}, \beta_j^k)), ((\delta_1(x_{k+i}, \alpha_i^k), \delta_2(y_{k+j}, \beta_j^k))), \delta(q_{k+i, k+j}, \alpha_i^k \beta_j^k)), ((\delta_1(x_{k+i}, \alpha_i^k), \delta_2(y_{k+j}, \beta_j^k))), \delta(q_{k+i, k+j}, \beta_j^k \alpha_i^k))\}$ from transitions defined on $p_1(\omega^k) | p_2(\omega^k)$ into A_S . For the transitions on the common events, the evolutions are $\delta(q_{k+m_k+r, k+n_k+r}, \gamma_r^k)!$ in A_S for $r = 0, \dots, r_k$, leading to simulation relation $R(\gamma^k) = \{((x_{k+m_k+r}, y_{k+n_k+r}), q_{k+m_k+r, k+n_k+r}), ((\delta_1(x_{k+m_k+r}, \gamma_r^k), \delta_2(y_{k+n_k+r}, \gamma_r^k))), \delta(q_{k+m_k+r, k+n_k+r}, \gamma_r^k))\}$ from transitions on $p_1(\gamma^k) | p_2(\gamma^k)$ into A_S . Therefore, for $i = 0, \dots, m_k, j = 0, \dots, n_k, r = 0, \dots, r_k, R = \bigcup_{k=0}^K R(\omega^k) \cup R(\gamma^k)$ defines a simulation relation from $PA(z_0, p_1(s) | p_2(s))$ (in $P_1(A_S) | P_2(A_S)$) into A_S . ■

Lemma 7: If *DC1* and *DC2* hold true, then $\forall s, s' \in E^*, \delta(q_0, s)!, \delta(q_0, s')!, s \neq s', p_{E_1 \cap E_2}(s), p_{E_1 \cap E_2}(s')$ do not start with the same $a \in E_1 \cap E_2$, then $\delta(q_0, p_1(s) | p_2(s'))! \wedge \delta(q_0, p_1(s') | p_2(s))!$ in A_S .

Proof: The antecedent of Lemma 7 addresses three following cases: (Case 1): $s = \omega_1, s' = \omega'_1$; (Case 2): $s = \omega_1 a \omega_2, s' = \omega'_1$, and (Case 3): $s = \omega_1 a \omega_2, s' = \omega'_1 b \omega'_2$, where, $\omega_1, \omega'_1 \in [E \setminus (E_1 \cap E_2)]^*, \omega_2, \omega'_2 \in (E_1 \cup E_2)^*, a, b \in E_1 \cap E_2$.

For Case 1, setting $K = 1, r_k = 0$, taking $p_1(\omega_1) = \alpha = \alpha_0 \dots \alpha_m \in (E_1 \setminus E_2)^*, p_2(\omega'_1) = \beta' = \beta'_0 \dots \beta'_n \in (E_2 \setminus E_1)^*, p_1(\omega'_1) = \alpha' = \alpha'_0 \dots \alpha'_{m'} \in (E_1 \setminus E_2)^*$ and $p_2(\omega_1) = \beta = \beta_0 \dots \beta_n \in (E_2 \setminus E_1)^*$, similar to the first part of Lemma 6, it follows that $\delta(q_0, p_1(\omega_1) | p_2(\omega'_1))!$ and $\delta(q_0, p_1(\omega'_1) | p_2(\omega_1))!$ in A_S .

For Case 2, from Case 1 and Lemma 6 it follows that $\delta(q_0, p_1(s) | p_2(s'))! = \delta(q_0, [p_1(\omega_1) | p_2(\omega'_1)] a p_1(\omega_2))!$ and $\delta(q_0, p_1(s') | p_2(s))! = \delta(q_0, [p_1(\omega'_1) | p_2(\omega_1)] a p_2(\omega_2))!$ in A_S .

For the third case, from definition of parallel composition combined with the first two cases and also Lemma 6, $\delta(q_0, p_1(s) | p_2(s'))!$ leads to $\delta(q_0, [p_1(\omega_1) | p_2(\omega'_1)] a [p_1(\omega_2) | p_2(\omega_2)])!$ and $\delta(q_0, [p_1(\omega_1) | p_2(\omega'_1)] b [p_1(\omega'_2) | p_2(\omega'_2)])!$ in A_S and similarly, $\delta(q_0, p_1(s') | p_2(s))!$ results in $\delta(q_0, [p_1(\omega'_1) | p_2(\omega_1)] a [p_1(\omega_2) | p_2(\omega_2)])!$ and $\delta(q_0, [p_1(\omega'_1) | p_2(\omega_1)] b [p_1(\omega'_2) | p_2(\omega'_2)])!$ in A_S .

Therefore, for all three cases, $\delta(q_0, p_1(s)|p_2(s'))!$ in A_S and $\delta(q_0, p_1(s')|p_2(s))!$ in A_S . ■

Now, Lemma 2 is proven as follows.

Sufficiency: The set of transitions in $P_1(A_S)||P_2(A_S)$, is defined as $T = \{(x_0, y_0) \xrightarrow{p_1(s)|p_2(s')} (x, y) \in Q_1 \times Q_2\}$, where, $(x_0, y_0) \xrightarrow{p_1(s)|p_2(s')} (x, y)$ in $P_1(A_S)||P_2(A_S)$ is the interleaving of transitions $x_0 \xrightarrow{p_1(s)} x$ in $P_1(A_S)$ and a transition $y_0 \xrightarrow{p_2(s')} y$ in $P_2(A_S)$ (projections of transitions $q_0 \xrightarrow{s} q$ and $q_0 \xrightarrow{s'} q'$, respectively, in A_S). T can be divided into three sets of transitions corresponding to a division $\{\Gamma_1, \Gamma_2, \Gamma_3\}$ on the set of interleaving strings $\Gamma = \{p_1(s)|p_2(s')|q_0 \xrightarrow{s} q, q_0 \xrightarrow{s'} q', q, q' \in Q, s, s' \in E^*\}$, where, $\Gamma_1 = \{p_1(s)|p_2(s') \in \Gamma | s = s'\}$, $\Gamma_2 = \{p_1(s)|p_2(s') \in \Gamma | s \neq s', p_{E_1 \cap E_2}(s)$ and $p_{E_1 \cap E_2}(s')$ do not start with the same event $\}$, and $\Gamma_3 = \{p_1(s)|p_2(s') \in \Gamma | s \neq s', p_{E_1 \cap E_2}(s)$ and $p_{E_1 \cap E_2}(s')$ start with the same event $\}$.

Now, for any $s, s', \delta(q_0, s)!, \delta(q_0, s')!$, in A_S , both $\delta(q_0, p_1(s)|p_2(s'))!$ and $\delta(q_0, p_1(s')|p_2(s))!$ are guaranteed, for Γ_1 , due to Lemma 6; for Γ_2 , due to Lemma 7, and for Γ_3 , due to combination of *DC3* and Lemma 6 (For simplification, in *DC3*, s and s' can be started from any q , instead of q_0 , and the strings between q_0 and q are checked by Lemma 6).

Necessity: The necessity is proven by contradiction. Suppose that A_S simulates $P_1(A_S)||P_2(A_S)$, but $\exists e_1 \in E_1 \setminus E_2, e_2 \in E_2 \setminus E_1, q \in Q, s \in E^*$ s.t. (1): $[\delta(q, e_1)! \wedge \delta(q, e_2)!] \wedge \neg[\delta(q, e_1 e_2)! \wedge \delta(q, e_2 e_1)!]$; (2): $\neg[\delta(q, e_1 e_2 s)! \Leftrightarrow \delta(q, e_2 e_1 s)!]$, or (3): $\exists s, s' \in E^*$, sharing the same first appearing common event $a \in E_1 \cap E_2, s \neq s', q \in Q: \delta(q, s)! \wedge \delta(q, s')! \wedge \neg[\delta(q, p_1(s)|p_2(s'))! \wedge \delta(q, p_1(s')|p_2(s))!]$.

In the first case, due to definition of parallel composition, the expression $[\delta(q, e_1)! \wedge \delta(q, e_2)!]$ leads to $\delta_{||}(z, e_1 e_2)! = \delta_{||}(z, e_2 e_1)!$, where $z \in Q_1 \times Q_2$ in $P_1(A_S)||P_2(A_S)$ corresponds to $q \in Q$ in A_S . Therefore, $\delta_{||}(z, e_1 e_2)! \wedge \delta_{||}(z, e_2 e_1)!$, but, $\neg[\delta(q, e_1 e_2)! \wedge \delta(q, e_2 e_1)!]$. This means that $P_1(A_S)||P_2(A_S) \not\prec A_S$ which is a contradiction. The second case means $\exists e_1 \in E_1 \setminus E_2, e_2 \in E_2 \setminus E_1, q \in Q, s \in E^*$ s.t. $[\delta(q, e_1 e_2 s)! \vee \delta(q, e_2 e_1 s)!] \wedge \neg[\delta(q, e_1 e_2 s)! \wedge \delta(q, e_2 e_1 s)!]$. From definition of parallel composition, then $\delta(q, e_1 e_2 s)! \vee \delta(q, e_2 e_1 s)!$ implies that $\delta_{||}(z, e_1 e_2)! = \delta_{||}(z, e_2 e_1)!$, for some $z \in Q_1 \times Q_2$ corresponding to $q \in Q$. Consequently, from definition of transition relation and $A_S \prec P_1(A_S)||P_2(A_S)$ it turns to $\delta_{||}(z, e_1 e_2 s)! = \delta_{||}(z, e_2 e_1 s)!$, meaning that $\delta_{||}(z, e_1 e_2 s)! \wedge \delta_{||}(z, e_2 e_1 s)!$, but, $\neg[\delta(q, e_1 e_2 s)! \wedge \delta(q, e_2 e_1 s)!]$. This in turn contradicts with the similarity assumption of $P_1(A_S)||P_2(A_S) \prec A_S$. The third case also leads to the contradiction as causes the violation of the simulation relation from $P_1(A_S)||P_2(A_S)$ into A_S as $\delta(q, s)! \wedge \delta(q, s')!$ leads to $\delta_{||}(z, p_1(s)|p_2(s'))! \wedge \delta_{||}(z, p_2(s)|p_1(s'))!$ in $P_1(A_S)||P_2(A_S)$, whereas

$$\neg[\delta(q, p_1(s)|p_2(s'))! \wedge \delta(q, p_2(s)|p_1(s'))!].$$

C. Proof for Lemma 3

To prove Lemma 3, we use following two lemmas together with Lemma 5. Firstly, the following lemma is introduced to characterize the symmetric property of simulation relations.

Lemma 8: Consider two automata A_1 and A_2 , and let A_1 be deterministic, $A_1 \prec A_2$ with the simulation relation R_1 and $A_2 \prec A_1$ with the simulation relation R_2 . Then, $R_1^{-1} = R_2$ if and only if there exists a deterministic automaton A'_1 such that $A'_1 \cong A_2$.

Proof:

Sufficiency: $A_1 \prec A_2$, $A_2 \prec A_1$ and $A'_1 \cong A_2$, collectively, result in $A_1 \prec A'_1$ and $A'_1 \prec A_1$, that due to determinism of A_1 and A'_1 lead to $A_1 \cong A'_1$. Finally, since $A'_1 \cong A_2$, from transitivity of bisimulation, $A_1 \cong A_2$, and consequently, $R_1^{-1} = R_2$.

Necessity: The necessity is proven by contradiction as follows. Consider two automata $A_1 = (X, x_0, E, \delta_1)$, $A_2 = (Y, y_0, E, \delta_2)$, let A_1 be deterministic, $A_1 \prec A_2$ with the simulation relation R_1 , $A_2 \prec A_1$ with the simulation relation R_2 and suppose that $R_1^{-1} = R_2$ (and hence $A_1 \cong A_2$), but there does not exist a deterministic automaton A'_1 such that $A'_1 \cong A_2$. This means that $\exists s \in E^*$, $\sigma \in E$, $y_1, y_2 \in Y$, $\delta_2(y_0, s) = y_1$, $\delta_2(y_0, s) = y_2$, $\delta_2(y_1, \sigma)!$, but $\neg\delta_2(y_2, \sigma)!$. From $A_2 \prec A_1$, $\delta_2(y_0, s) = y_1 \wedge \delta_2(y_1, \sigma)!$ implies that $\exists x_1 \in X$, $\delta_1(x_0, s) = x_1 \wedge \delta_1(x_1, \sigma)!$. On the other hand, A_1 is deterministic, and hence, $\forall x_2 \in X$, $\delta_1(x_0, s) = x_2 \Rightarrow x_2 = x_1$. Therefore, $A_2 \prec A_1$ necessarily leads to $(y_2, x_1) \in R_2$. But, $\exists \sigma \in E$ such that $\delta_1(x_1, \sigma)! \wedge \neg\delta_2(y_2, \sigma)!$, meaning that $(y_2, x_1) \in R_2 \wedge \neg(x_1, y_2) \in R_1$, i.e., $R_1^{-1} \neq R_2$, that contradicts with the hypothesis, and the necessity is followed. ■

Next, let A_1 and A_2 to be substituted by A_S and $P_1(A_S)||P_2(A_S)$, respectively, in Lemma 8. Then, the existence of $A'_1 = A'_S$ in Lemma 8 is characterized by the following lemma.

Lemma 9: Consider a deterministic automaton A_S and its natural projections $P_i(A_S)$, $i = 1, 2$. Then, there exists a deterministic automaton A'_S such that $A'_S \cong P_1(A_S)||P_2(A_S)$ if and only if there exist deterministic automata $P'_i(A_S)$ such that $P'_i(A_S) \cong P_i(A_S)$, $i = 1, 2$.

Proof: Let $A_S = (Q, q_0, E = E_1 \cup E_2, \delta)$, $P_i(A_S) = (Q_i, q_0^i, E_i, \delta_i)$, $P'_i(A_S) = (Q'_i, q'_{0,i}, E_i, \delta'_i)$, $i = 1, 2$, $P_1(A_S)||P_2(A_S) = (Z, z_0, E, \delta_{||})$, $P'_1(A_S)||P'_2(A_S) = (Z', z'_0, E, \delta'_{||})$. The proof of Lemma 9 is then presented as follows.

Sufficiency: The existence of deterministic automata $P'_i(A_S)$ such that $P'_i(A_S) \cong P_i(A_S)$, $i = 1, 2$ implies that δ'_1 and δ'_2 are functions, and consequently from definition of parallel composition (Definition 7), $\delta'_{||}$ is a function, and hence $P'_1(A_S)||P'_2(A_S)$ is deterministic. Moreover, from Lemma 5, $P'_i(A_S) \cong P_i(A_S)$, $i = 1, 2$ leads to $P'_1(A_S)||P'_2(A_S) \cong P_1(A_S)||P_2(A_S)$, meaning that there exists a deterministic automaton $A'_S = P'_1(A_S)||P'_2(A_S)$ such that $A'_S \cong P_1(A_S)||P_2(A_S)$.

Necessity: The necessity is proven by contraposition, namely, by showing that if there does not exist deterministic automata $P'_i(A_S)$ such that $P'_i(A_S) \cong P_i(A_S)$, for $i = 1$ or $i = 2$, then there does not exist a deterministic automaton A'_S such that $A'_S \cong P_1(A_S)||P_2(A_S)$.

Without loss of generality, assume that there does not exist a deterministic automaton $P'_1(A_S)$ such that $P'_1(A_S) \cong P_1(A_S)$. This means that $\exists q, q_1, q_2 \in Q$, $e \in E_1$, $t_2 \in (E_2 \setminus E_1)^*$, $t \in E^*$, $\delta(q, t_2 e) = q_1$, $\delta(q, e) = q_2$, $\neg(\delta(q_1, t) = q_2 \Leftrightarrow \delta(q_2, t)!)!$, meaning that $\delta(q_1, t)! \wedge \neg\delta(q_2, t)!$ or $\neg\delta(q_1, t)! \wedge \delta(q_2, t)!$. Again without loss of generality we consider the first case and show that it leads to a contradiction. From the first case, $\delta(q_1, t)! \wedge \neg\delta(q_2, t)!$, and definition of natural projection, it follows that $\delta_1([q]_1, e) = [q_1]_1$, $\delta_1([q]_1, p_1(t))!$, $\delta_1([q]_1, e) = [q_2]_1$, $\neg\delta_1([q_2]_1, p_1(t))!$, $\delta_2([q]_2, p_2(e)) = [q_2]_2$, $\neg\delta_2([q_2]_2, p_2(t))!$, and hence, $\delta_{||}([q]_1, [q]_2, e) = ([q_1]_1, [q_1]_2)$, $\delta_{||}([q]_1, [q]_2, p_1(t))!$, whereas $\delta_{||}([q]_1, [q]_2, e) = ([q_1]_1, [q_2]_2)$, $\neg\delta_{||}([q]_1, [q]_2, p_1(t))!$ in $P_1(A_S)||P_2(A_S)$, implying that there does not exist a deterministic automaton A'_S such that $A'_S \cong P_1(A_S)||P_2(A_S)$, and the necessity is proven. ■

Now, Lemma 3 is proven as follows.

Sufficiency: *DC4* implies that there exist deterministic automata $P'_i(A_S)$ such that $P'_i(A_S) \cong P_i(A_S)$, $i = 1, 2$. Then, from Lemmas 5 and 9, it follows, respectively, that $P'_1(A_S)||P'_2(A_S) \cong P_1(A_S)||P_2(A_S)$, and that there exists a deterministic automaton $A'_S = P'_1(A_S)||P'_2(A_S)$ such that $A'_S \cong P_1(A_S)||P_2(A_S)$ that due to Lemma 8, it results in $R_1^{-1} = R_2$.

Necessity: Let A_S be deterministic, $A_S \prec P_1(A_S)||P_2(A_S)$ with the simulation relation R_1 and $P_1(A_S)||P_2(A_S) \prec A_S$ with the simulation relation R_2 , and assume by contradiction that $R_1^{-1} = R_2$, but *DC4* is not satisfied. Violation of *DC4* implies that for $i = 1$ or $i = 2$, there does not exist a deterministic automaton $P'_i(A_S)$ such that $P'_i(A_S) \cong P_i(A_S)$. Therefore, due to Lemma 9, there does not exist a deterministic automaton A'_S such that $A'_S \cong P_1(A_S)||P_2(A_S)$, and hence, according to Lemma 8, it leads to $R_1^{-1} \neq R_2$ which is a contradiction.

D. Proof for Lemma 4

Lemma 4 comes from the associativity property of parallel decomposition [11] as for automata A_i , $i = 1, \dots, m$: $A_1 \parallel A_2 \parallel \dots \parallel A_{m-1} \parallel A_{E_m} = A_1 \parallel (A_2 \parallel (\dots \parallel (A_{m-1} \parallel A_m)))$.

E. Proof for Lemma 5

Lemma 5.1 is proven by showing that the relation $R = \{((q_1, q_3), (q_2, q_4)) \mid (q_1, q_2) \in R_1 \text{ and } (q_3, q_4) \in R_2\}$ is a simulation relation, where, R_1 and R_2 are the respective simulations from A_1 to A_2 and from A_3 to A_4 .

Consider $A_i = (Q_i, q_i^0, E_i, \delta_i)$, $i = 1, \dots, 4$, $A_1 \parallel A_3 = (Q_{1,3}, (q_1^0, q_3^0), E = E_1 \cup E_3, \delta_{1,3})$, $A_2 \parallel A_4 = (Q_{2,4}, (q_2^0, q_4^0), E = E_2 \cup E_4, \delta_{2,4})$, $E_1 = E_3$ and $E_2 = E_4$. Then, $\forall (q_1, q_3), (q_1, q_3)' \in Q_{1,3}$, $e \in E$, $q_2 \in Q_2$, $q_4 \in Q_4$ such that $\delta_{1,3}((q_1, q_3), e) = (q_1, q_3)'$, $(q_1, q_2) \in R_1$ and $(q_3, q_4) \in R_2$, according to definition of parallel composition (Definition 7), we have $(q_1, q_3)' = (q_1', q_3') =$

$$\begin{cases} (\delta_1(q_1, e), \delta_3(q_3, e)), & \text{if } \delta_1(q_1, e)!, \delta_3(q_3, e)!, e \in E_1 \cap E_3; \\ (\delta_1(q_1, e), q_3), & \text{if } \delta_1(q_1, e)!, e \in E_1 \setminus E_3; \\ (q_1, \delta_3(q_3, e)), & \text{if } \delta_3(q_3, e)!, e \in E_3 \setminus E_1; \end{cases}$$

and due to definition of simulation (Definition 5), $A_1 \prec A_2$ and $A_3 \prec A_4$, it follows that

$$\begin{cases} \exists q_i' \in Q_i, \delta_i(q_i, e) = q_i', i = 2, 4 & \text{if } e \in E_2 \cap E_4 \\ \exists q_2' \in Q_2, \delta_2(q_2, e) = q_2' & \text{if } e \in E_2 \setminus E_4 \\ \exists q_4' \in Q_4, \delta_4(q_4, e) = q_4' & \text{if } e \in E_4 \setminus E_2 \end{cases}$$

This, in turn, due to definition of parallel composition implies that $\exists (q_2', q_4') \in Q_{2,4}$ such that

$$\delta_{2,4}((q_2, q_4), e) = (q_2, q_4)' = \begin{cases} (\delta_2(q_2, e), \delta_4(q_4, e)), & \text{if } e \in E_2 \cap E_4; \\ (\delta_2(q_2, e), q_4), & \text{if } e \in E_2 \setminus E_4; \\ (q_2, \delta_4(q_4, e)), & \text{if } e \in E_4 \setminus E_2. \end{cases}$$

Therefore, $\forall (q_1, q_3), (q_1, q_3)' \in Q_{1,3}$, $(q_2, q_4) \in Q_{2,4}$, $e \in E$, such that $\delta_{1,3}((q_1, q_3), e) = (q_1, q_3)'$ and $((q_1, q_3), (q_2, q_4)) \in R$, then $\exists (q_2, q_4)' \in Q_{2,4}$, $\delta_{2,4}((q_2, q_4), e) = (q_2, q_4)'$, $((q_1, q_3)', (q_2, q_4)') \in R$. This together with $((q_1^0, q_3^0), (q_2^0, q_4^0)) \in R$, by construction, leads to $A_1 \parallel A_3 \prec A_2 \parallel A_4$.

Now, to prove Lemma 5.2, we define the relation $\bar{R} = \{((q_2, q_4), (q_1, q_3)) \mid (q_2, q_1) \in \bar{R}_1 \text{ and } (q_4, q_3) \in \bar{R}_2\}$, where, \bar{R}_1 and \bar{R}_2 are the respective simulation relations from A_2 to A_1 and from A_4 to A_3 , and then similar to the proof of the first part, we show that \bar{R} is a simulation relation. Now, to show that $A_1 \parallel A_3 \cong A_2 \parallel A_4$ it remains to show that $\forall (q_1, q_3) \in Q_{1,3}$, $(q_2, q_4) \in Q_{2,4}$: $((q_1, q_3), (q_2, q_4)) \in R \Leftrightarrow ((q_2, q_4), (q_1, q_3)) \in \bar{R}$. This is proven by contradiction. Suppose that $\exists (q_1, q_3) \in Q_{1,3}$, $(q_2, q_4) \in Q_{2,4}$ such that $((q_1, q_3), (q_2, q_4)) \in R \wedge ((q_2, q_4), (q_1, q_3)) \notin \bar{R}$,

or $((q_2, q_4), (q_1, q_3)) \in \bar{R} \wedge ((q_1, q_3), (q_2, q_4)) \notin R$. We prove that the first hypothesis leads to contradiction, and the contradiction of the second hypothesis is followed, similarly. The expression $((q_1, q_3), (q_2, q_4)) \in R \wedge ((q_2, q_4), (q_1, q_3)) \notin \bar{R}$ means that $\exists s \in E^*, \delta_{1,3}((q_1^0, q_3^0), s) = (q_1, q_3), \delta_{2,4}((q_2^0, q_4^0), s) = (q_2, q_4), \forall e \in E, \delta_{1,3}((q_1, q_3), e)!: \delta_{2,4}((q_2, q_4), e)!$; but, $\exists \sigma \in E, \delta_{2,4}((q_2, q_4), \sigma)! \wedge \neg \delta_{1,3}((q_1, q_3), \sigma)!$. From Definition 7, $\delta_{2,4}((q_2, q_4), \sigma)!$ means that

$$\begin{cases} \delta_2(q_2, \sigma)!, \delta_4(q_4, \sigma)! & \text{if } e \in E_2 \cap E_4; \\ \delta_2(q_2, \sigma)! & \text{if } e \in E_2 \setminus E_4; \\ \delta_4(q_4, \sigma)! & \text{if } e \in E_4 \setminus E_2. \end{cases}$$

Consequently, from $(q_2, q_1) \in \bar{R}_1$ and $E_1 = E_2$ (due to $A_1 \cong A_2$), $(q_4, q_3) \in \bar{R}_2$ and $E_3 = E_4$ (due

to $A_3 \cong A_4$), and Definition 5, it follows that $\begin{cases} \delta_1(q_1, \sigma)!, \delta_3(q_3, \sigma)! & \text{if } e \in E_2 \cap E_4 = E_1 \cap E_3; \\ \delta_1(q_1, \sigma)! & \text{if } e \in E_2 \setminus E_4 = E_1 \setminus E_3; \\ \delta_3(q_3, \sigma)! & \text{if } e \in E_4 \setminus E_2 = E_3 \setminus E_1, \end{cases}$ that from Definition 7 leads to $\delta_{1,3}((q_1, q_3), \sigma)!$ which contradicts with the hypothesis and the proof is followed.

REFERENCES

- [1] V. R. Lesser, "Cooperative multiagent systems: A personal view of the state of the art," *IEEE Transactions on Knowledge and Data Engineering*, vol. 11, pp. 133–142, 1999.
- [2] P. U. Lima and L. M. Custodio, *Multi-Robot Systems, Book Series Studies in Computational Intelligence, Book Innovations in Robot, Mobility and Control*. Berlin: Springer Berlin / Heidelberg, 2005, vol. 8.
- [3] J. Choi, S. Oh, and R. Horowitz, "Distributed learning and cooperative control for multi-agent systems," *Automatica*, vol. 45, no. 12, pp. 2802–2814, 2009.
- [4] E. Semsar-Kazerooni and K. Khorasani, "Multi-agent team cooperation: A game theory approach," *Automatica*, vol. 45, no. 10, pp. 2205–2213, 2009.
- [5] G. E. Fainekos, A. Girard, H. Kress-Gazit, and G. J. Pappas, "Temporal logic motion planning for dynamic robots," *Automatica*, vol. 45, no. 2, pp. 343–352, 2009.
- [6] Z. Ji, Z. Wang, H. Lin, and Z. Wang, "Brief paper: Interconnection topologies for multi-agent coordination under leader-follower framework," *Automatica*, vol. 45, no. 12, pp. 2857–2863, 2009.
- [7] V. Crespi, A. Galstyan, and K. Lerman, "Top-down vs bottom-up methodologies in multi-agent system design," *Auton. Robots*, vol. 24, no. 3, pp. 303–313, 2008.
- [8] P. Tabuada and G. Pappas, "Linear time logic control of discrete-time linear systems," *Automatic Control, IEEE Transactions on*, vol. 51, no. 12, pp. 1862–1877, Dec. 2006.
- [9] C. Belta, A. Bicchi, M. Egerstedt, E. Frazzoli, E. Klavins, and G. Pappas, "Symbolic planning and control of robot motion [grand challenges of robotics]," *Robotics and Automation Magazine, IEEE*, vol. 14, no. 1, pp. 61–70, March 2007.
- [10] M. Kloetzer and C. Belta, "Automatic deployment of distributed teams of robots from temporal logic motion specifications," *Robotics, IEEE Transactions on*, vol. 26, no. 1, pp. 48–61, feb. 2010.

- [11] C. G. Cassandras and S. Lafortune, *Introduction to discrete event systems*. USA: Springer, 2008.
- [12] R. Kumar and V. K. Garg, *Modeling and Control of Logical Discrete Event Systems*. Norwell, MA, USA: Kluwer Academic Publishers, 1999.
- [13] R. Gotzhein, "Temporal logic and applications: a tutorial," *Comput. Netw. ISDN Syst.*, vol. 24, no. 3, pp. 203–218, 1992.
- [14] P. Wolper, "Constructing automata from temporal logic formulas: a tutorial," pp. 261–277, 2002.
- [15] M. Mukund, *From global specifications to distributed implementations*, in B. Caillaud, P. Darondeau, L. Lavagno (Eds.), *Synthesis and Control of Discrete Event Systems*, Kluwer. Berlin: Springer Berlin / Heidelberg, 2002.
- [16] R. Morin, "Decompositions of asynchronous systems," in *CONCUR '98: Proceedings of the 9th International Conference on Concurrency Theory*. London, UK: Springer-Verlag, 1998, pp. 549–564.
- [17] I. Castellani, M. Mukund, and P. S. Thiagarajan, "Synthesizing distributed transition systems from global specification," in *Proceedings of the 19th Conference on Foundations of Software Technology and Theoretical Computer Science*. London, UK: Springer-Verlag, 1999, pp. 219–231.
- [18] Y. Willner and M. Heymann, "Supervisory control of concurrent discrete-event systems," *International Journal of Control*, vol. 54, pp. 1143–1169, 1991.
- [19] C. Zhou, R. Kumar, and S. Jiang, "Control of nondeterministic discrete-event systems for bisimulation equivalence," *Automatic Control, IEEE Transactions on*, vol. 51, no. 5, pp. 754 – 765, may 2006.
- [20] R. Alur, T. Henzinger, G. Lafferriere, and G. Pappas, "Discrete abstractions of hybrid systems," *Proceedings of the IEEE*, vol. 88, no. 7, pp. 971 –984, jul 2000.
- [21] M. V. Lawson, *Finite Automata, Book Series in Control Engineering, Book Handbook of Networked and Embedded Control System*. Springer Boston / Birkhuseg, 2007, vol. I.
- [22] K. Rudie and W. Wonham, "Think globally, act locally: decentralized supervisory control," *Automatic Control, IEEE Transactions on*, vol. 37, no. 11, pp. 1692 –1708, nov 1992.
- [23] P. Tabuada and G. Pappas, "From discrete specifications to hybrid control," in *Decision and Control, 2003. Proceedings. 42nd IEEE Conference on*, vol. 4, Dec. 2003, pp. 3366–3371 vol.4.
- [24] C. Belta, V. Isler, and G. Pappas, "Discrete abstractions for robot motion planning and control in polygonal environments," *Robotics, IEEE Transactions on*, vol. 21, no. 5, pp. 864 – 874, oct. 2005.