

Precision Polarimetry at the ILC: Concepts, Simulations and experiments

Christoph Bartels, Anthony Hartin, Christian Helebrant, Daniela Käfer, Jenny List^a

^aDESY, Hamburg, Germany

Abstract

The precision physics program of the ILC requires precise knowledge of the state of beam polarisation. In fact the Compton polarimeters intended for the ILC will have to measure the polarisation with error a factor of 2 smaller than the previous best measurement at the SLAC SLD experiment. In order to further reduce measurement error, spin tracking simulations in the ILC Beam Delivery System subject to ground motion induced misalignment have been performed and the expected variation in polarisation has been quantified. A prototype of a high precision spectrometer to record Compton scattered electrons from the interaction of a longitudinal laser and the charged beams has been developed. The Compton electrons interact with a gas in the polarimeter channels to produce Cherenkov radiation measured by photodetectors. The calibration of the photodetectors is crucial and exhaustive bench tests of the photodetector linearity have been performed. The polarimeter prototype itself will be tested at the ELSA testbeam in Bonn in Spring 2009.

Key words: Cherenkov detector, ILC polarimetry, photodetector tests, beam tests

1. Introduction

At the International Linear Collider, polarised electrons and positron beams are foreseen to collide at centre-of-mass energies between 90 and 500 GeV. Its physics program aims for extremely precise determination of the parameters of the Standard Model of particle physics as well as of yet unknown phenomena. This requires very precise beam parameter measurements, such as the beam energy and polarisation, to a precision in the order of 10^{-4} .

While such precision has already been reached for the beam energy measurement at LEP [1], the previous best polarisation measurement, performed at the SLAC SLD experiment, had a systematic uncertainty of 0.5% [2]. The ILC, by comparison, will employ a large range of beam energies, higher intensities and repetition rates. A gain in precision of a factor of 50 in the more demanding experimental conditions at the ILC is required. The planned system of upstream and downstream polarimeters combined with complementary physics measurements will give an overall precision gain of a factor of 50. An upstream polarimeter placed in a purpose designed chicane near the beginning of the Beam Delivery System (BDS)

2. Depolarisation simulations

In order to combine the measurements of the two Compton polarimeters with each other and with collision data, the depolarisation between these two measurement locations has to be studied. The main depolarisation source is at the Interaction Point (IP) and is due to strong beam-beam effects [3]. The Beam Delivery System (BDS) can also induce significant loss of polarisation due to ground

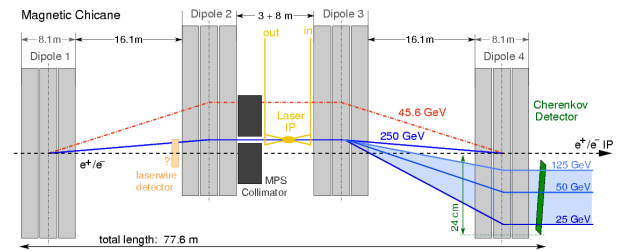

Figure 1: Placement of polarimeter in polarimeter chicane.

motion-induced misalignments of its lattice elements. To quantify this latter source of polarisation loss, a realistic simulation of depolarisation and spin precession in the BDS is presented.

A realistic bunch train is generated by using PLACET [4] to track bunches through a misaligned linac in which a 1:1 correction and dispersion free steering is made. BDS elements are misaligned using a model of the expected inter-train ground motion and the spin is tracked using the BMAD [5] program. Finally the expected luminosity-weighted depolarisation due to BDS misalignments and the evolution of bunch-to-bunch depolarisation along a bunch train corrected by intra-train feedback is investigated.

For random misalignments of BDS elements with a variance of 5 microns from true alignment, the mean helicity of the beam already declines by 0.11%, with an increasing helicity distribution width (figure 2). Depolarisation at the ILC is expected to add a further 0.14% luminosity weighted depolarisation to the physics collisions. The combined effect of both BDS and IP depolarisation makes it necessary to deploy also a downstream polarimeter to

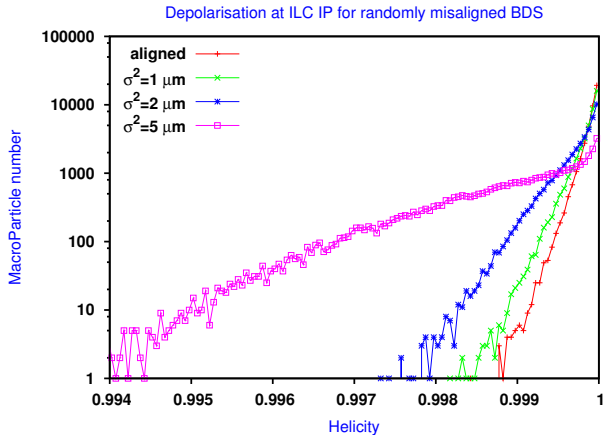

Figure 2: Depolarisation at the ILC for a misaligned Beam Delivery System

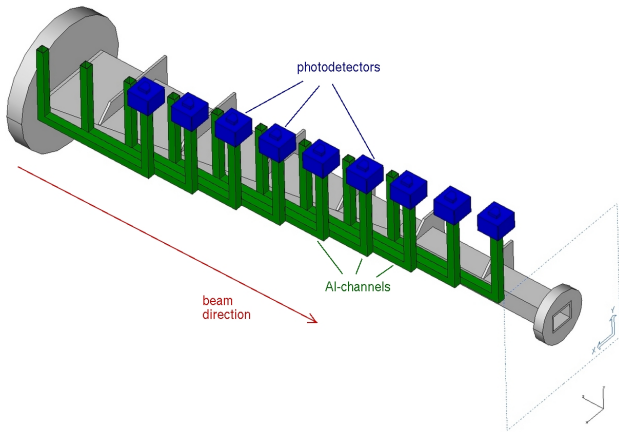

Figure 3: New Cherenkov detector design

provide independent information of the polarisation state in physics collisions.

3. Detector Prototype Design

The polarimeters measure the polarisation dependent energy spectrum of beam electrons undergoing Compton scattering with an oncoming laser. Approximately 10^3 scattered electrons per bunch are produced with scattering angles within $10 \mu\text{rad}$ w.r.t. to the original beam direction and a magnetic spectrometer is employed to transfer the energy distribution into a position distribution. Behind the spectrometer the electrons are then detected by an array of Cherenkov counters. Since knowledge of the analysing power of the whole spectrometer and the linearity of the detector setup were the main limiting factors for SLD polarimetry, the design of the Cherenkov detector is a crucial issue for improving the precision.

The Cherenkov detector is planned to consist of staggered, U-shaped aluminium channels along the z -axis to allow for a tapered beam pipe preventing wake field creation. The channels will have a cross section of about

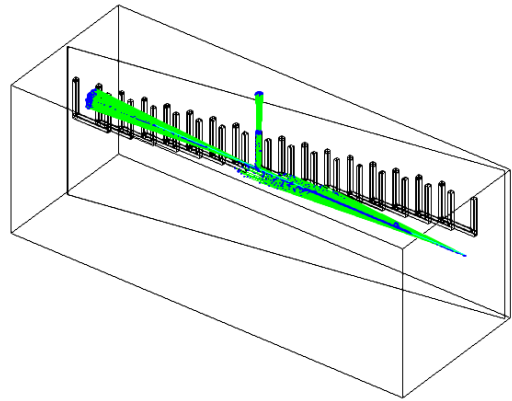

Figure 4: Geant simulation of new Cherenkov detector design

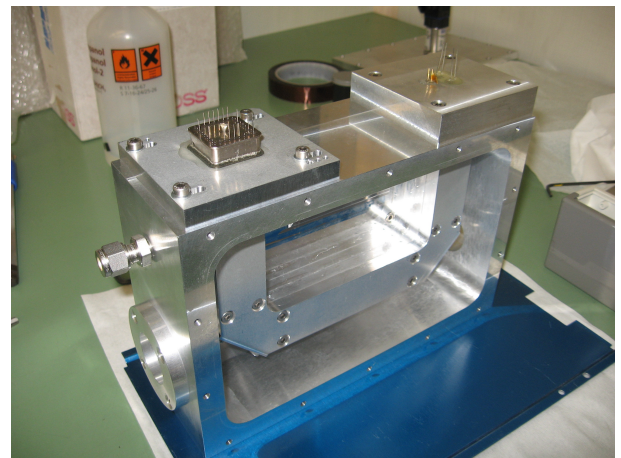

Figure 5: Two channel prototype Cherenkov detector

$1 \text{ cm} \times 1 \text{ cm}$ and are filled with C_4F_{10} as Cherenkov gas. One leg of the U-shaped gas tubes is equipped with a photodetector and subsequent readout, while the other leg is used for calibration purposes (via LED, or laser light). Geant simulations have been performed for the planned design showing a significant reduction in cross-talk across channels when the detector channels are rotated out of the expected plane of beam synchrotron radiation (figure 4).

To study the performance of the proposed Cherenkov detector design, a two channel prototype was constructed during summer 2008. This was then first tested in the laboratory (using LED, or laser light) and in a second step in the DESY II testbeam. Finally, the prototype was transported to Bonn in spring 2009 and set up at the “Elektron Stretcher Anlage” (ELSA). The ELSA testbeam provides higher bunch rates (approximately 7 orders of magnitude higher than for the tertiary DESY II beam) and the bunches themselves can contain about 100-1000 electrons, a situation closer to that of the linear collider Compton polarimeter design which foresees about 1000 Compton electrons ejected per bunch. The results of these testbeam runs will be reported on elsewhere

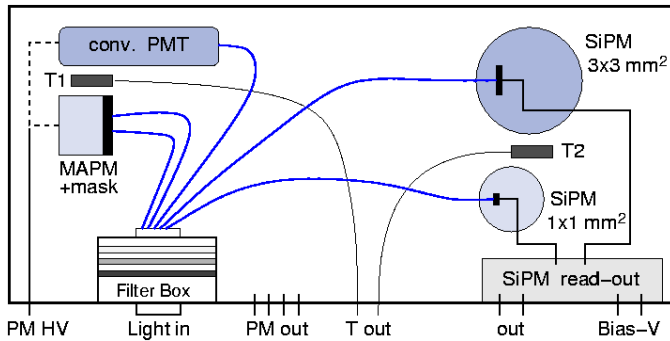

Figure 6: Schematic of photodetector test equipment

4. Photodetector Studies

Experiences from previous polarimeters show that the limiting factor of the Cherenkov design will not be of statistical but systematic nature. The linearity of the entire Cherenkov detector, especially the photodetector (PD) is of utmost importance [6, 7].

A test facility was set up to analyse different types of PDs regarding their adequacy for an ILC polarimeter. It consists of a light-tight box, that can be equipped with various types of PDs ranging from different conventional PD tubes to novel silicon based photomultipliers (SiPM). Due to the compactness of the latter (some mm²) a much higher spatial resolution of the Cherenkov detector could be achieved compared to more conventional PDs, and thus a more precise polarisation measurement. The light is generated by a blue LED connected to a function generator. The data acquisition is done via VME electronics using a high resolution 12-bit QDC.

Several methods are employed to measure the integral non-linearity of the PDs. First, a simple array of calibrated optical filters is used. A second series of measurements is done by varying the length of an rectangular LED pulse. Two more elaborate methods are exploited to measure the differential non-linearity of the PDs. For different LED pulse heights P_i and a fixed pulse $p \ll P_i$ the PD response to P_i and $P_i + p$ is measured. Another approach to measure the differential non-linearity uses a four-holed mask applied to the PD. An LED pulse is equally fed into four optical fibres, which can be applied to the four holes in the mask. The DNL is measured as the difference between the sum of the PD's responses to using only one fibre at a time and all four together.

Once the PD non-linearity has been accurately measured a correction can be applied in order to restore linearity on a per-mille level (figure 7)

5. Conclusion

Spin tracking simulations show a significant depolarisation in the beam delivery system of a planned future linear collider and so both an upstream and downstream

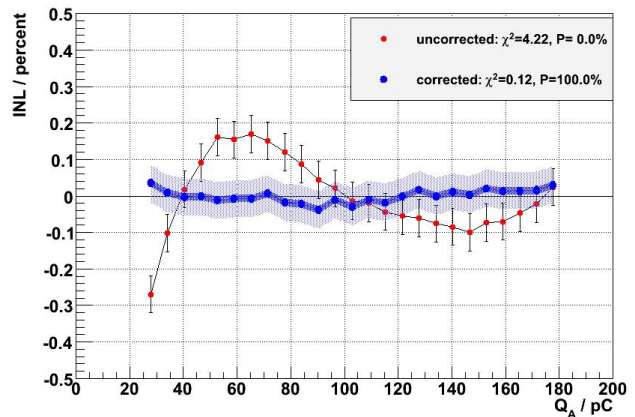

Figure 7: Measured PD Integrated non-linearity and applied correction.

polarimeter will be necessary to establish the polarisation state of particle collisions at the IP of a linear collider. Additionally, the required physics measurements will necessitate a polarimeter Cherenkov detector of unprecedented accuracy. A new detector prototype has been designed with the detector arms formed into a staggered U shapes. Geant simulations have shown a reduction in channel cross-talk compared to previous designs. The accuracy requirements dictate that the non-linearity of the photodetectors used in the Cherenkov detector be well understood and correctable. A laboratory testbox was developed and correction of the measured photodetector non-linearity was achieved to a per-mille level. A 2 channel detector prototype was setup and tested in the DESY test-beam and the ELSA facility in Bonn.

Acknowledgements

This work has been supported by the DFG via the Emmy-Noether grant Li 1560/1-1.

References

- [1] R. Assmann *et al.* [LEP Energy Working Group], Eur. Phys. J. C **39** (2005) 253 [arXiv:hep-ex/0410026].
- [2] K. Abe *et al.* [SLD Collaboration], Phys. Rev. Lett. **84** (2000) 5945 [arXiv:hep-ex/0004026].
- [3] I.R. Bailey, A.F. Hartin *et al.*, "Depolarisation and Beam-Beam Effects at the Linear Collider", 2008, EUROTeV-Report-2008-026.
- [4] D.Schulte, "The PLACET manual", <https://savannah.cern.ch/projects/placet>.
- [5] D.Sagan, "The BMAD reference manual", <http://www.lepp.cornell.edu/~dcs/bmad>.
- [6] R.D. Elia, "Measurement of the Left-Right Asymmetry in Z Boson Production by Electron-Positron Collisions", Ph.D. Thesis, 1994, SLAC-R-429.
- [7] P.L. Reinertsen, "Non-Linear Effects in the Compton Polarimeter System and Impact on the Measured Electron Polarisation", 1999, SLD Note 261.