

FIBERED KNOTS AND PROPERTY 2R, II

ROBERT E. GOMPF AND MARTIN SCHARLEMANN

ABSTRACT. Following [ST], a knot $K \subset S^3$ is said to have *Property nR* if, whenever K is a component of an n -component link $L \subset S^3$ and some integral surgery on L produces $\#_n(S^1 \times S^2)$, there is a sequence of handle slides on L that converts L into a 0-framed unlink. The Generalized Property R Conjecture is that all knots have Property nR for all $n \geq 1$.

The simplest plausible counterexample could be the square knot. Exploiting the remarkable symmetry of the square knot, we characterize all two-component links that contain it and which surger to $\#_2(S^1 \times S^2)$. We argue that at least one such link probably cannot be reduced to the unlink by a series of handle-slides, so the square knot probably does not have Property 2R. This example is based on a classic construction of the first author.

On the other hand, the square knot may well satisfy a somewhat weaker property, which is still useful in 4-manifold theory. For the weaker property, copies of canceling Hopf pairs may be added to the link before the handle slides and then removed after the handle slides. Beyond our specific example, we discuss the mechanics of how addition and later removal of a Hopf pair can be used to reduce the complexity of a surgery description.

1. INTRODUCTION: REVIEW OF PROPERTY nR

We briefly review the background material from [ST], to which we refer the reader for details. Recall the famous Property R theorem, proven in a somewhat stronger form by David Gabai [Ga]:

Theorem 1.1 (Property R). *If 0-framed surgery on a knot $K \subset S^3$ yields $S^1 \times S^2$ then K is the unknot.*

There is a natural way of trying to generalize Theorem 1.1 to links in S^3 . First recall a small bit of 4-manifold handlebody theory [GS]. Suppose L is a link in an oriented 3-manifold M and each component of L is assigned a framing, that is a preferred choice of cross section to the

Date: November 4, 2018.

Research partially supported by National Science Foundation grants. Thanks also to Mike Freedman and Microsoft's Station Q for rapidly organizing a mini-conference on this general topic.

normal circle bundle of the component in M . For example, if $M = S^3$, a framing on a knot is determined by a single integer, the algebraic intersection of the preferred cross-section with the longitude of the knot. (In an arbitrary 3-manifold M a knot may not have a naturally defined longitude.) Surgery on the link via the framing is standard Dehn surgery (though restricted to integral coefficients): a regular neighborhood of each component is removed and then reattached so that the meridian is identified with the cross-section given by the framing. Associated to this process is a certain 4-manifold: attach 4-dimensional 2-handles to $M \times I$ along $L \times \{1\}$, using the given framing of the link components. The result is a 4-dimensional cobordism, called the *trace* of the surgery, between M and the 3-manifold M' obtained by surgery on L . The collection of belt spheres of the 2-handles constitutes a link $L' \subset M'$ called the dual link; the trace of the surgery on $L \subset M$ can also be viewed as the trace of a surgery on $L' \subset M'$.

The 4-manifold trace of the surgery on L is unchanged if one 2-handle is slid over another 2-handle. Such a handle slide is one of several moves allowed in the Kirby calculus [Ki1]. When the 2-handle corresponding to the framed component U of L is slid over the framed component V of L the effect on the link is to replace U by the band sum \overline{U} of U with a certain copy of V , namely the copy given by the preferred cross-section realizing the framing of V . If $M = S^3$ and the framings of U and V are given by the integers m and n , respectively, then the integer for \overline{U} will be $m + n \pm 2 \cdot \text{link}(U, V)$ where *link* denotes the linking number and the sign is $+$ precisely when the orientations of U and the copy of V fit together to orient \overline{U} . (This requires us to orient U and V , but the answer is easily seen to be independent of the choice of orientations.) The terms *handle addition* and *subtraction* are used to distinguish the two cases of sign ($+$ and $-$, respectively) in the formula.

If the handle slide is viewed dually, via the description of the 4-manifold as the trace of surgery on $L' \subset M'$, the picture is counterintuitive: Let $U' \subset M'$ and $V' \subset M'$ be the dual knots to U and V . Then the link in M' that is dual to $\overline{U} \cup V$ is $U' \cup \overline{V'}$, where $\overline{V'}$ is obtained by a handle-slide of V' over U' .

Let $\#_n(S^1 \times S^2)$ denote the connected sum of n copies of $S^1 \times S^2$. The Generalized Property R conjecture (see [Ki2, Problem 1.82]) says this:

Conjecture 1 (Generalized Property R). *Suppose L is an integrally framed link of $n \geq 1$ components in S^3 , and surgery on L via the specified framing yields $\#_n(S^1 \times S^2)$. Then there is a sequence of handle slides on L that converts L into a 0-framed unlink.*

The hypothesis immediately implies that all framings and linking numbers are zero.

There is a way of stating the conjecture so that the focus is on knots, rather than links:

Definition 1.2. *A knot $K \subset S^3$ has **Property nR** if it does not appear among the components of any n -component counterexamples to the Generalized Property R conjecture. That is, whenever K is a component of an n -component link $L \subset S^3$ and some integral surgery on L produces $\#_n(S^1 \times S^2)$, then there is a sequence of handle slides on L that converts L into a 0-framed unlink*

The Generalized Property R conjecture is that the following is true for all $n \geq 1$:

Conjecture 2 (Property nR Conjecture). *All knots have Property nR.*

From this perspective, Gabai's theorem 1.1 is that all knots have Property 1R. It is known ([ST, Prop. 2.3]) that any counterexample to any Property nR Conjecture must be slice (at least topologically). It is further shown in [ST] that the unknot has Property 2R and, if there is any fibered counterexample to Property 2R, there is a non-fibered counterexample of lower genus. These considerations suggest that, if one is searching for a potential counterexample to Property nR, the simplest candidate could be the square knot as a potential counterexample to Property 2R, for the square knot is slice, fibered and of genus 2.

2. THE SQUARE KNOT IN LINKS THAT SURGER TO $\#_2(S^1 \times S^2)$

The square knot Q is the connected sum of two trefoil knots, K_R and K_L , respectively the right-hand trefoil knot and the left-hand trefoil knot. There are many 2-component links containing Q so that surgery on the link gives $\#_2(S^1 \times S^2)$. Figure 1 shows (by sliding Q over the unknot) that the other component could be the unknot; Figure 2 shows (by instead sliding the unknot over Q) that the second component could be quite complicated. In this section we show that, up to handle-slides of V over Q , there is a straight-forward description of all two component links $Q \cup V$, so that surgery on $Q \cup V$ gives $\#_2(S^1 \times S^2)$.

The critical ingredient in the characterization of V is the collection of properties listed below, which apply because Q is a genus two fibered knot. Here h denotes the monodromy homeomorphism on the fiber F_- of a genus two fibered knot U and F is the closed genus two surface obtained by capping off ∂F_- with a disk. Equivalently, F is the fiber of

the *closed* genus two fibered 3-manifold obtained by 0-framed surgery on U .

Proposition 2.1. *Suppose $U \subset S^3$ is a genus two fibered knot and $V \subset S^3$ is a disjoint knot. Then 0-framed surgery on $U \cup V$ gives $\#_2(S^1 \times S^2)$ if and only if after possible handle-slides of V over U ,*

- (1) V lies in a fiber of U ;
- (2) $h(V)$ can be isotoped to be disjoint from V in F (though not necessarily in F_-);
- (3) $h(V)$ is not isotopic to V in F ; and
- (4) the framing of V given by F is the 0-framing of V in S^3 .

Proof. See [ST, Corollary 5.4] □

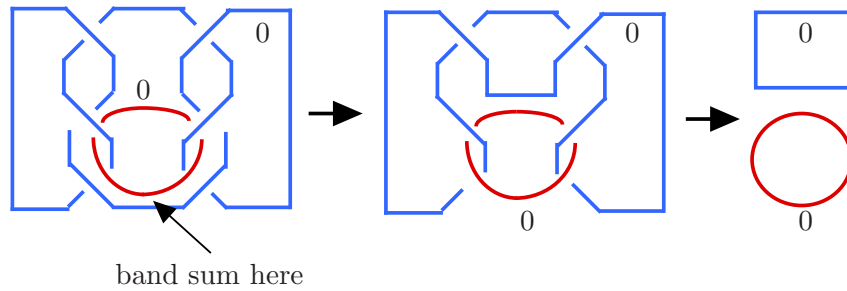

FIGURE 1.

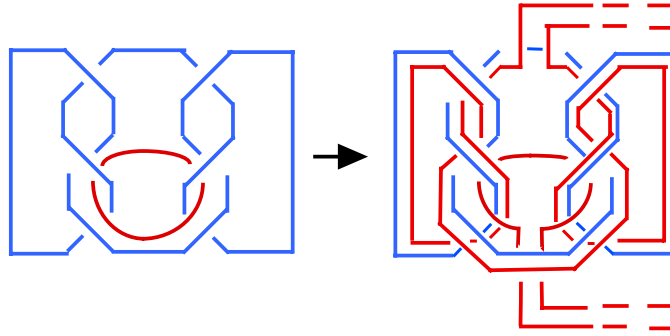

FIGURE 2.

Let M be the 3-manifold obtained by 0-framed surgery on the square knot Q , so M fibers over the circle with fiber the genus 2 surface F . There is a simple picture of the monodromy $h : F \rightarrow F$ of the bundle M , obtained from a similar picture of the monodromy on the fiber of a trefoil knot, essentially by doubling it [Ro, Section 10.I]:

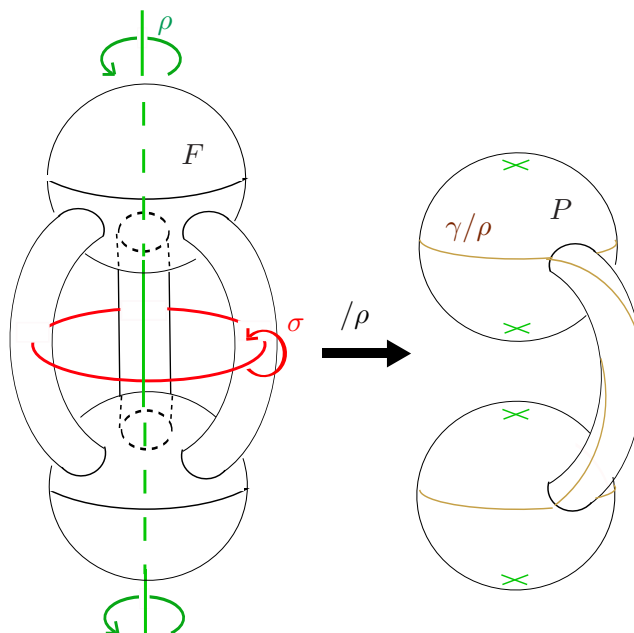

FIGURE 3.

Regard F as obtained from two spheres by attaching 3 tubes between them. See Figure 3. There is an obvious period 3 symmetry $\rho : F \rightarrow F$ gotten by rotating $\frac{2\pi}{3}$ around an axis intersecting each sphere in two points, and a period 2 symmetry (the hyperelliptic involution) $\sigma : F \rightarrow F$ obtained by rotating around a circular axis that intersects each tube in two points. Then $h = \rho \circ \sigma = \sigma \circ \rho$ is an automorphism of F of order $2 \times 3 = 6$.

The quotient of F under the action of ρ is a sphere with 4 branch points, each of branching index 3. Let P be the 4-punctured sphere obtained by removing the branch points. A simple closed curve in P is *essential* if it doesn't bound a disk and is not ∂ -parallel. Put another way, a simple closed curve in P is essential if and only if it divides P into two twice-punctured disks. It is easy to see (viz. [ST, Section 6]) that there is a separating simple closed curve $\gamma \subset F$ that is invariant under σ and ρ , and hence under h , that separates F into two punctured tori F_R and F_L ; the restriction of h to F_R or F_L is the monodromy of the trefoil knot. The quotient of γ under ρ is shown as the brown curve in Figure 3 .

An important property of the hyperelliptic involution $\sigma : F \rightarrow F$ is that it fixes the isotopy class of each curve. That is, for any simple closed curve $c \subset F$, $\sigma(c)$ is isotopic to c . The isotopy preserves orientation on c if and only if c is separating.

This immediately gives

Corollary 2.2. *For any simple closed curve $c \subset F$, $h(c)$ is isotopic in F to a curve disjoint from c if and only if $\rho(c)$ is isotopic in F to a curve disjoint from c .*

Proof. Since $h^3(c) = \sigma(c)$ is isotopic to c in F , $h(c)$ is isotopic to a curve disjoint from c if and only if $h(c)$ is isotopic to a curve disjoint from $h^3(c)$. Applying $h^{-3} : F \rightarrow F$ shows that $h(c)$ is isotopic to a curve disjoint from $h^3(c)$ if and only if $h^{-2}(c) = \rho(c)$ is isotopic to a curve disjoint from c . \square

Lemma 2.3. *For the 3-fold branched covering $\rho : F \rightarrow S^2 \supset P$ described above:*

- (1) *An essential simple closed curve $c \subset F$ has the property that $\rho(c)$ can be isotoped to be disjoint from c if and only if c is isotopic to a lift of an essential simple closed curve \bar{c} in P .*
- (2) *A lift c of an essential simple closed curve \bar{c} in P is separating in F if and only if \bar{c} separates the pair of branch points coming from F_L from the branch points coming from F_R .*
- (3) *A single lift c of an essential simple closed curve \bar{c} in P is non-separating in F if and only if c projects homeomorphically to \bar{c} .*

Proof. Since \bar{c} is embedded, any lift c of \bar{c} will either be carried by ρ to a disjoint curve, or to c itself. In either case, $\rho(c)$ can be isotoped off of c . On the other hand, suppose $\rho(c)$ can be isotoped off of c . Give F the standard hyperbolic metric, which is invariant under ρ , and isotope c to a geodesic in F . Then $\rho(c)$ is also a geodesic and, since they can be isotoped apart, either $\rho(c) = c$ or $c \cap \rho(c) = \emptyset$. Apply $\rho^{\pm 1}$ to deduce that $c, \rho(c), \rho^2(c)$ either all coincide or are all disjoint. In either case, c projects to an embedded curve in P . This proves the first part of the Lemma.

To prove the second and third parts, we first establish:

Claim: An essential simple closed curve $\bar{c} \subset P$ lifts to a curve c that is invariant under ρ if and only if c is separating in F .

Proof of Claim. Since ± 1 are not eigenvalues of the monodromy matrix for $h_* : \mathbb{Z}^4 \rightarrow \mathbb{Z}^4$, no non-separating curve is left invariant by h or ρ . On the other hand, if the essential curve c (and hence also $\rho(c)$) is separating and $\rho(c)$ is disjoint from c then, since F only has genus 2, c and $\rho(c)$ must be parallel in F . This proves the claim.

The Claim establishes the third part of the Lemma. For the second part, we restate the Claim: whether \bar{c} lifts to a non-separating or to a separating curve is completely determined by whether \bar{c} is covered in F by three distinct curves or is thrice covered by a single curve. That, in turn, is determined by whether \bar{c} represents an element of $\pi_1(P)$ that is mapped trivially or non-trivially to \mathbb{Z}_3 under the homomorphism $\pi_1(P) \rightarrow \mathbb{Z}_3$ that defines the branched covering $F \rightarrow S^2 \supset P$. One way to view such a curve \bar{c} in P is as the boundary of a regular neighborhood of an arc \underline{c} between two branch points of $S^2 \supset P$, namely a pair of branch points (either pair will do) that lie on the same side of \bar{c} in S^2 . From that point of view, \bar{c} represents a trivial element of \mathbb{Z}_3 if and only if the normal orientations of the branch points at the ends of the arc \underline{c} disagree; that is, one is consistent with a fixed orientation of the rotation axis and one is inconsistent. Put another way, \bar{c} represents a trivial element if and only if one endpoint of \underline{c} is a north pole in Figure 3 and the other is a south pole. The brown curve in the Figure, which lifts to the curve separating F_R from F_L , separates both north poles from both south poles. This establishes the second part of the Lemma. \square

Lemma 2.4. *If $c \subset F$ projects to a simple closed curve \bar{c} in P then the framing of c given by the Seifert surface $F_- \subset S^3$ of Q is the 0-framing.*

Proof. Here is an equivalent conclusion: If c' is a parallel copy of c in F_- , then $\text{link}(c, c') = 0$ in S^3 . Consider the following automorphism τ of S^3 that preserves the Seifert surface F_- of Q , as viewed in the left side of Figure 4: Reflect through the plane of the knot projection (this reflection makes the right-hand trefoil a left-hand trefoil, and vice versa), then do a π rotation around an axis in S^3 that passes through the center of the arc $\gamma_- \subset F_-$ that separated K_R from K_L . The automorphism is orientation preserving on the Seifert surface, but orientation reversing on γ and on S^3 . Because of the last fact, $\text{link}(\tau(c), \tau(c')) = -\text{link}(c, c')$.

The automorphism $\tau|_{F_-}$ descends to an automorphism $\bar{\tau}$ of $S^2 \supset P$ given by π -rotation about the blue axis shown in Figure 4. This rotation exchanges F_R and F_L but, up to isotopy and orientation, leaves invariant the simple closed curves in P . It follows that in F , $\tau(c)$ is isotopic to some $\pm\rho^i(c)$. Of course the monodromy h , hence ρ , preserves the linking pairing. (The fiber structure describes an isotopy of a curve to its image under the monodromy.) Hence we have, for some $0 \leq i \leq 2$, $\text{link}(c, c') = -\text{link}(\tau(c), \tau(c')) = -\text{link}(\pm\rho^i(c), \pm\rho^i(c')) = -\text{link}(c, c')$. This implies that $\text{link}(c, c') = 0$. \square

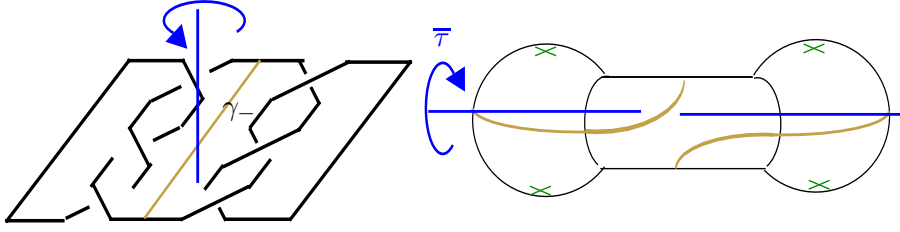

FIGURE 4.

Corollary 2.5. *Suppose $Q \subset S^3$ is the square knot with fiber $F_- \subset S^3$ and $V \subset S^3$ is a disjoint knot. Then 0-framed surgery on $Q \cup V$ gives $\#_2(S^1 \times S^2)$ if and only if, after perhaps some handle-slides of V over Q , V lies in F_- and ρ projects V homeomorphically to an essential simple closed curve in P .*

Note that, according to Lemma 2.3, essential simple closed curves \bar{c} in P that are such homeomorphic projections are precisely those for which one branch point of F_L (or, equivalently, one branch point from F_R) lies on each side of \bar{c} . So another way of saying that ρ projects V homeomorphically to an essential simple closed curve in P is to say that V is the lift of an essential simple closed curve in P that separates one branch point of F_L (or, equivalently F_R) from the other.

Proof. This is an application of Proposition 2.1. Suppose that 0-framed surgery on $Q \cup V$ gives $\#_2(S^1 \times S^2)$. Then, after possible handle-slides over Q , V lies in F_- . According to Proposition 2.1, in the closed surface F , $h(V)$ can be isotoped to be disjoint from V but is not isotopic to V . The result then follows from Lemma 2.3.

Conversely, suppose that after some handle-slides of V over Q , V lies in F_- and $\rho : F \rightarrow S^2 \supset P$ projects V homeomorphically to an essential simple closed curve \bar{c} in P . $\rho(V)$ then can't be isotopic to V in F (or else in fact $\rho(V) = V$ and so $\rho|_V : V \rightarrow \bar{c}$ would not be a homeomorphism) but $\rho(V)$ is disjoint from V , since \bar{c} is embedded. Thus the first two conditions of Proposition 2.1 are satisfied. Lemma 2.4 establishes the third condition. \square

3. THE 4-MANIFOLD VIEWPOINT: A NON-STANDARD HANDLE STRUCTURE ON S^4

To understand why the square knot Q is likely to fail Property 2R, it is useful to ascend to 4 dimensions. We use an unusual family of handlebodies from [Go1] to construct a family of 2-component links in S^3 , each containing Q as one component. Each of these links will fail to satisfy Generalized Property R if a certain associated presentation of the

trivial group fails (as seems likely) to satisfy the Andrews-Curtis Conjecture. Each link also has another intriguing attribute: it is smoothly slice, and each component is ribbon, but it is not known whether the entire link is ribbon.

In [Go1], the first author provided unexpected examples of handle structures on homotopy 4-spheres which do not obviously simplify to give the trivial handle structure on S^4 . At least one family is highly relevant to the discussion above. This is example [Go1, Figure 1], reproduced here as the left side of Figure 5. (Setting $k = 1$ gives rise to the square knot.) The two circles with dots on them represent 1-handles, indicating that the 4-manifold with which we begin is $(S^1 \times D^3) \natural (S^1 \times D^3)$ with boundary $\#_2(S^1 \times S^2)$ given by 0-surgery. (Think of the two dotted unknotted circles as bounding disjoint unknotted disks in the 4-ball; the dots indicate one should scoop these disks out of D^4 rather than attach 2-handles to D^4 .) The circles without dots represent 2-handles attached to $\#_2(S^1 \times S^2)$ with the indicated framing. A sequence of Kirby operations in [Go1, §2] shows that the resulting 4-manifold has boundary S^3 .

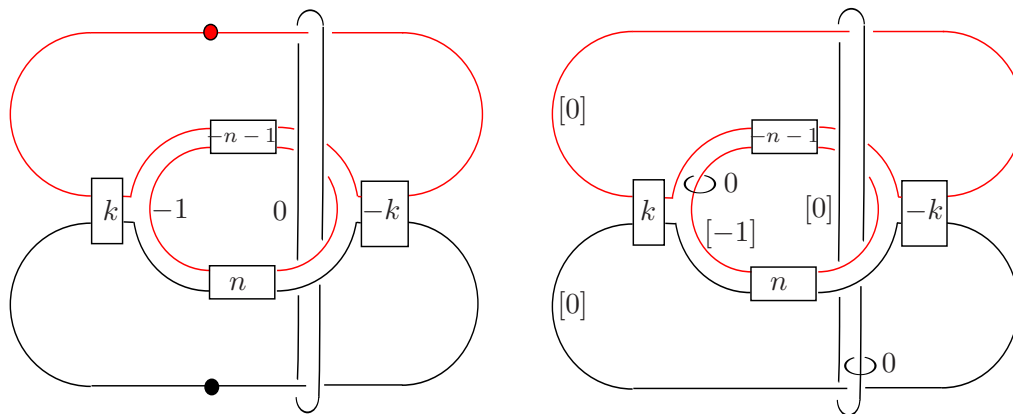

FIGURE 5.

We will be interested in the 4-manifold that is the trace of the 2-handle surgeries, the manifold that lies between $\#_2(S^1 \times S^2)$ and S^3 . Our viewpoint, though, is dual to that in [Go1]; the 4-manifold is thought of as starting with S^3 (actually, with ∂D^4) to which two 2-handles are attached to get $\#_2(S^1 \times S^2)$. This dual viewpoint puts the construction solidly in the context of this paper.

A recipe for making the switch in perspective is given in [GS, Example 5.5.5]. The result is shown in the right half of Figure 5. The circles representing 1-handles are changed to 0-framed 2-handles and

then all 2-handles have their framing integers bracketed. We call these circles bracketed circles; they form a complicated surgery description of S^3 . New 0-framed 2-handles are added, each linking one of these original 2-handles. These small linking 2-handles will eventually be the 2-handles we seek, after we eliminate the other components by following the recipe for turning the original diagram into a trivial diagram of the 3-sphere. This process allows handle slides of bracketed or unbracketed circles over bracketed ones, but does not allow handle slides of bracketed circles over unbracketed circles. The reduction is done in Figure 6 and roughly mimics [Go1, Figures 7 and 8]: The top (red) circle is handle-slid over the bottom (black) circle C via a band that follows the tall thin [0]-framed circle. In order to band-sum to a 0-framed push-off of C , the n twists that are added in the lower twist box are undone by adding $-n$ twists via a new twist box to the left. The Hopf link at the bottom of the left diagram is removed in a 2-stage process: The unbracketed component is handleslid over C , so it is no longer linked with the [0]-framed component of the Hopf link. Then C is canceled with the [0]-framed circle of the Hopf link. The result is the picture on the right. The apparent change is both that the Hopf link has been removed and the framing of C has been changed from [0] to 0.

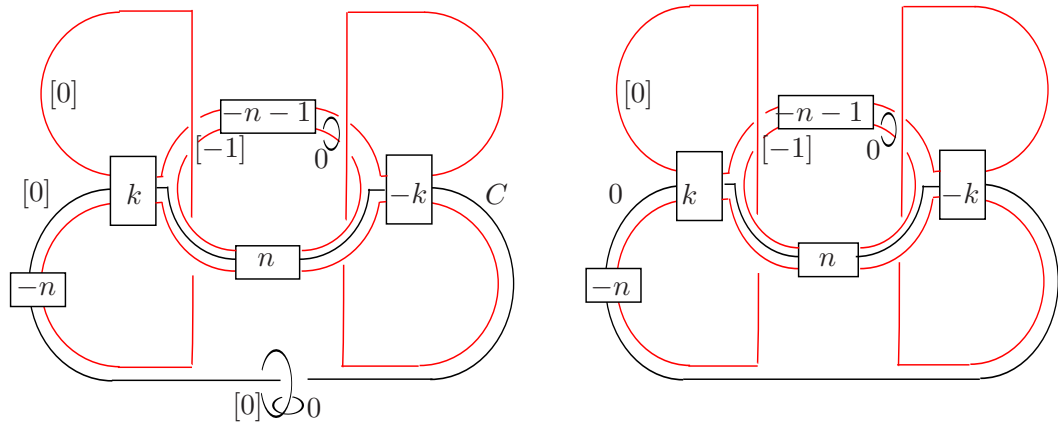

FIGURE 6.

Next (Figure 7) the large red [0]-framed circle is handle-slid over the central red $[-1]$ -framed circle. That gives the figure on the left. Note that the twist boxes guarantee we have pushed off with framing -1 as required. Since there is now only one strand going through the top twist-box, the box can be ignored. The handle-slide changes the [0]-framing on the slid circle to a $[+1]$ -framing, since the two curves,

if oriented in the same direction through the braid boxes, have linking number $n + (-n - 1) = -1$ and, with that orientation, the handle-slide corresponds to a handle subtraction. To get the figure on the right, the lower black circle is moved into position and a flype moves the lower twist-box to a new upper twist-box. (Note the sphere enclosing the left half of the diagram, intersecting the n -twist box and two other strands.)

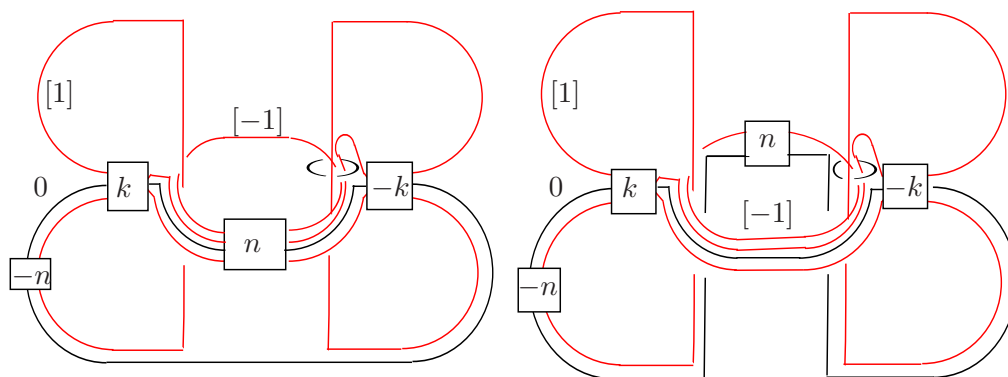

FIGURE 7.

Aim now for the square knot, by setting $k = 1$ and changing the full twists to half twists by a flype. Figure 8 then shows a series of isotopies (clockwise around the figure beginning at the upper left) that simplify the red $[\pm 1]$ -framed circles, while dragging along the 0-framed black circles.

Finally, Figure 9 shows that the middle 0-framed component, when the two red $[\pm 1]$ -framed components are blown down, becomes the square knot $Q \subset S^3$. (The other component becomes an interleaved connected sum of two torus knots, $V_n = T_{n,n+1} \# \overline{T_{n,n+1}}$.)

This leaves two natural questions.

Question One: As described, V_n does not obviously lie on a Seifert surface for Q . According to Corollary 2.5, some handle slides of V_n over Q should alter V_n so that it is one of the easily enumerated curves that do lie on the Seifert surface, in particular it would be among those that are lifts of (half of) the essential simple closed curves in the 4-punctured sphere P . Which curves in P represent V_n for some n ?

Question Two: Is each $Q \cup V_n, n \geq 3$, a counter-example to Generalized Property R?

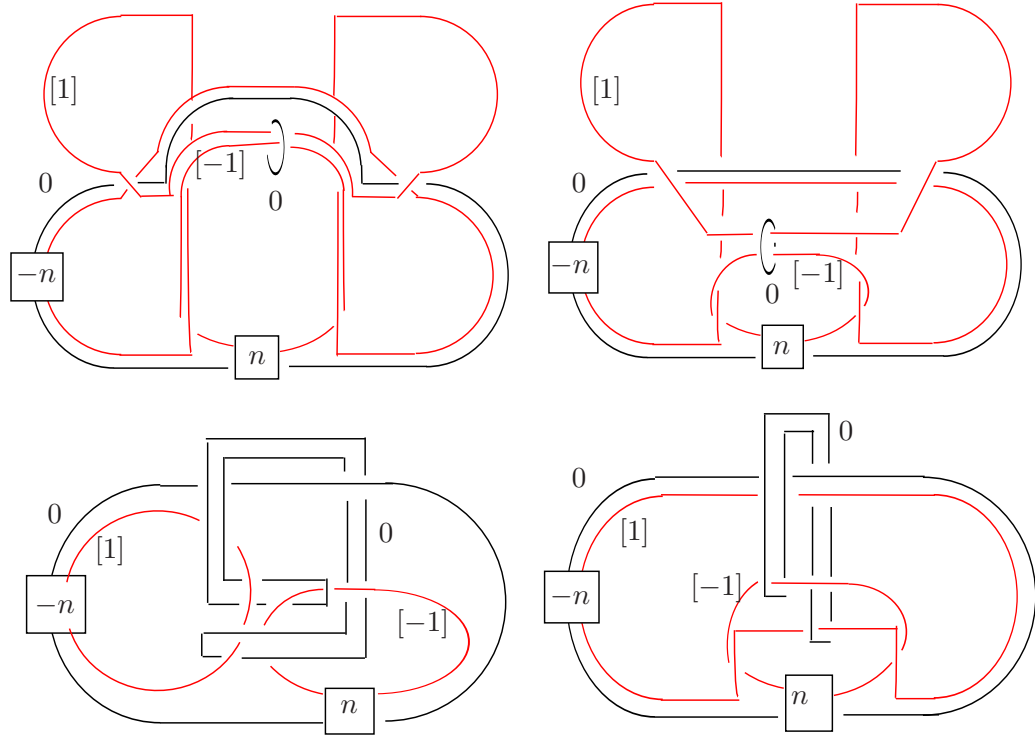

FIGURE 8.

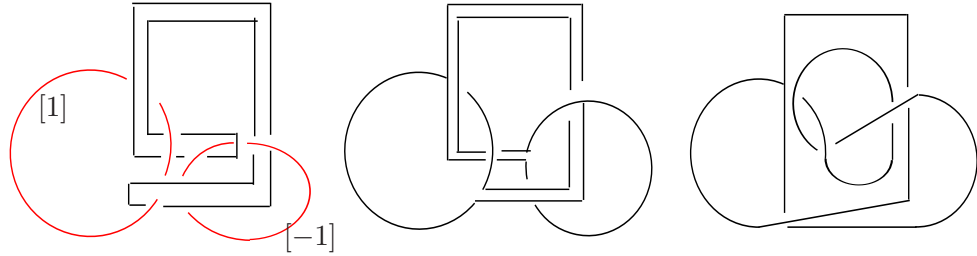

FIGURE 9.

This second question is motivated by Figure 5. As described in [Go1], the first diagram of that figure exhibits a simply connected 2-complex, presenting the trivial group as

$$\langle x, y \mid y = w^{-1}xw, x^{n+1} = y^n \rangle,$$

where w is some word in $x^{\pm 1}, y^{\pm 1}$ depending on k and equal to yx when $k = 1$. If the 2-component link $L_{n,k}$ of Figure 7 (obtained by blowing down the two bracketed circles) can be changed to the unlink by handle slides, then the dual slides in Figure 5 will trivialize that picture, showing that the above presentation is Andrews-Curtis trivial.

For $k = 1$, for example, this is regarded as very unlikely when $n \geq 3$. Since surgery on $L_{n,k}$ is $\#_2(S^1 \times S^2)$ by construction, this suggests an affirmative answer to Question Two, which (for any one n) would imply:

Conjecture 3. *The square knot does not have Property 2R.*

The invariant we have implicitly invoked here can be described in a purely 3-dimensional way. Suppose L is an n -component framed link that satisfies the hypothesis of Generalized Property R. Then surgery on L yields $\#_n(S^1 \times S^2)$, whose fundamental group G is free on n generators. Its basis $\{g_i\}$ is unique up to Nielsen moves. If we pick a meridian of each component of L , attached somehow to the base point, we obtain n elements $\{r_i\}$ that normally generate G (since they normally generate the group of the link complement). Thus, we have a presentation $\langle g_1, \dots, g_n | r_1, \dots, r_n \rangle$ of the trivial group. Changing our choices in the construction changes the presentation by Andrews-Curtis moves. If we change L by sliding one component L_i over another L_j , then r_j ceases to be a meridian, but it again becomes one via the dual slide over a meridian to L_i . This is again an Andrews-Curtis move, multiplying r_j by a conjugate of r_i . Thus, the link L up to handle slides determines a balanced presentation of the trivial group up to Andrews-Curtis moves. Unfortunately, there is presently no way to distinguish Andrews-Curtis equivalence classes from each other. When such technology emerges, it should be able to distinguish handle-slide equivalence classes of links satisfying the hypothesis of Generalized Property R, such as the links $L_{n,k}$ of Figure 7. For a related perspective, see also [CL].

Remark: The link $L_{n,k}$ is interesting for another reason. Recall that it is exhibited in Figure 5 as the two meridians of the 2-handles, which obviously bound disjoint disks in the pictured 4-manifold. (These are the cores of the 2-handles in the dual picture.) Since the 4-manifold is actually diffeomorphic to a 4-ball [Go1], it follows that $L_{n,k}$ is smoothly slice. Furthermore, each component is ribbon. (A band move turns the small component in Figure 7 into a meridian of each of the bracketed circles, becoming an unlink when these are blown down, and the other component is easily seen to be $T_{n,n+1} \# \overline{T_{n,n+1}}$.) However, there seems to be no reason to expect $L_{n,k}$ to be a ribbon link. (In general, a link satisfying the hypothesis of Generalized Property R is slice in a possibly exotic 4-ball, whereas the conclusion of Generalized Property R implies it is ribbon.) Band-summing together the components of $L_{n,k}$ yields a smoothly slice knot that could potentially fail to be ribbon.

4. WEAKENING PROPERTY nR

The evidence above suggests that Property 2R, and hence the Generalized Property R Conjecture, may fail for a knot as simple as the square knot. There are other reasons to be unhappy with this set of conjectures: For one thing, there is no clear relation between Property nR and Property (n+1)R: If K has Property nR, there is no reason to conclude that no $(n+1)$ -component counterexample to Generalized Property R contains K . After all, Gabai has shown that *every knot has Property 1R*. Conversely, if K does not have Property nR, so there is an n -component counterexample L to Generalized Property R, and $K \subset L$, it may well be that even adding a distant 0-framed unknot to L creates a link that satisfies Generalized Property R. So K might still satisfy Property (n+1)R.

A four-dimensional perspective on this last possibility is instructive. (See also [FGMW, Section 3].) Suppose L is an n -component link on which surgery gives $\#_n(S^1 \times S^2)$. Suppose further that, after adding a distant 0-framed r -component unlink to L , the resulting link L' can be reduced to an $(n+r)$ -component unlink by handle-slides. Consider the 4-manifold W obtained by attaching 2-handles to D^4 via the framed link L , then attaching $\natural_n(S^1 \times B^3)$ to the resulting manifold along their common boundary $\#_n(S^1 \times S^2)$. Via [LP] we know there is essentially only one way to do this. The result is a simply-connected (since no 1-handles are attached) homology 4-sphere, hence a homotopy 4-sphere. If the 2-handles attached along L can be slid so that the attaching link is the unlink, this would show that $W \cong S^4$, since it implies that the 2-handles are exactly canceled by the 3-handles. But the same is true if handle-slides convert L' to the unlink: the 4-manifold W is the same, but attaching first r more trivial 2-handles and then canceling with r more 3-handles has no effect on the topology of the associated 4-manifold. So from the point of view of 4-manifolds, this weaker form of Generalized Property R (in which a distant r -component unlink may be added to the original link) would suffice.

From the 4-manifold point of view there is a dual operation which also makes no difference to the topology of the underlying 4-manifold: adding also pairs of canceling 1- and 2- handles. From the point of view of Kirby calculus, each such pair is conventionally noted in two possible ways (see Section 5.4 of [GS] and Figure 10 below):

- A dumb-bell shaped object. The ends of the dumb-bell represent 3-balls on which a 1-handle is attached; the connecting rod represents the attaching circle for a canceling 2-handle.

- A Hopf link. One component of the link is labeled with a dot and the other is given framing 0. The dotted component represents the 1-handle and the 0-framed component represents the attaching circle for a canceling 2-handle. Call such an object a canceling Hopf pair and call the union of s such pairs, each lying in a disjoint 3-ball, a *set of s canceling Hopf pairs*.

(The rules for handle-slides of these dotted components in canceling Hopf pairs are fairly restricted; see [GS]. For example, they cannot slide over non-dotted components. Note that while we require the 2-handle of a canceling Hopf pair to have framing 0, we can change it to any even framing by sliding the 2-handle over the dotted circle to exploit the nonzero linking number.)

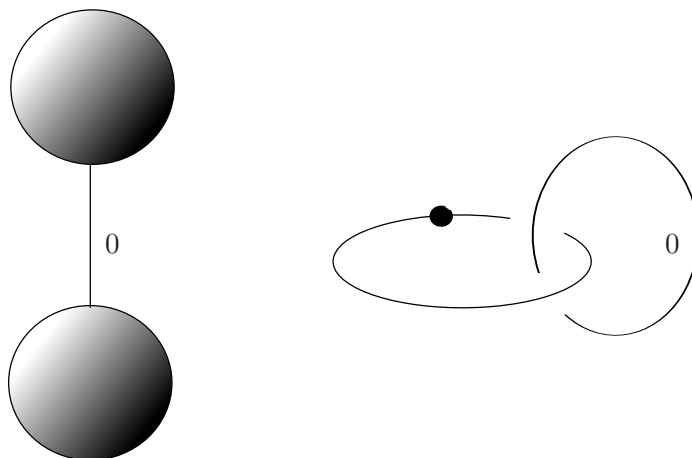

FIGURE 10.

The 4-manifold perspective suggests the following weaker and more awkward version of Generalized Property R:

Conjecture 4 (Weak Generalized Property R). *Suppose L is a framed link of $n \geq 1$ components in S^3 , and surgery on L yields $\#_n(S^1 \times S^2)$. Then, perhaps after adding a distant r -component 0-framed unlink and a set of s canceling Hopf pairs to L , there is a sequence of handle-slides that creates the distant union of an $n + r$ component 0-framed unlink with a set of s canceling Hopf pairs.*

The move to Weak Generalized Property R destroys the Andrews-Curtis invariant of the previous section, since adding a canceling Hopf pair leaves the surgered manifold, and hence G , unchanged, but introduces a new relator that is obviously trivial. In fact, we will see in the

next section that the links $L_{n,k}$ are not counterexamples to this weaker conjecture (even if we set $r = 0$, $s = 1$). On the other hand, stabilization by adding a distant unknot to L changes the corresponding presentation by adding a generator g_{n+1} and relator $r_{n+1} = g_{n+1}$, and this preserves the Andrews-Curtis class. Thus, the Hopf pairs seem crucial to the conjecture, whereas it is unclear whether the distant unlink is significant. (Of course, if we allow 1-handles in our original diagram as in Figure 5, then the Andrews-Curtis problem seems to make the distant unlink necessary.)

Definition 4.1. *A knot $K \subset S^3$ has **Weak Property nR** if it does not appear among the components of any n -component counterexample to the Weak Generalized Property R conjecture.*

We have seen that Property nR and Weak Property nR are probably quite different, due to the Hopf pairs. The latter property also exhibits nicer formal behavior due to the distant unlink, in that if K has Weak Property (n+1)R then it has Weak Property nR: Suppose K appears among the components of an n -component framed link L and surgery on L via the specified framing yields $\#_n(S^1 \times S^2)$. Then the corresponding statement is true for the union L' of L with a distant 0-framed unknot. If K has Weak Property (n+1)R then the distant union L'' of L' with the 0-framed r -component unlink and a set of s canceling Hopf pairs has a sequence of handle-slides that creates the 0-framed unlink of $n + r + 1$ components and a set of s canceling Hopf pairs. But L'' can also be viewed as the union of L with the 0-framed $(r + 1)$ -component unlink and a set of s canceling Hopf pairs. Thus K satisfies Weak Property nR.

The Weak Generalized Property R Conjecture is closely related to the Smooth (or PL) 4-Dimensional Poincaré Conjecture, that every homotopy 4-sphere is actually diffeomorphic to S^4 . For a precise statement, we restrict attention to homotopy spheres that admit handle decompositions without 1-handles.

Proposition 4.2. *The Weak Generalized Property R Conjecture is equivalent to the Smooth 4-Dimensional Poincaré Conjecture for homotopy spheres that admit handle decompositions without 1-handles.*

While there are various known ways of constructing potential counterexamples to the Smooth 4-Dimensional Poincaré Conjecture, each method is known to produce standard 4-spheres in many special cases. (The most recent developments are [Ak], [Go2].) Akbulut's recent work [Ak] has eliminated the only promising potential counterexamples currently known to admit handle decompositions without 1-handles. For

3-dimensional renderings of the full Smooth 4-Dimensional Poincaré Conjecture and other related conjectures from 4-manifold theory, see [FGMW].

Proof. Suppose Σ is a homotopy sphere with no 1-handles and n 2-handles. Since there are no 1-handles, the 2-handles are attached to some framed n -component link $L \subset S^3$ in the boundary of the unique 0-handle D^4 in Σ . Since Σ has Euler characteristic 2, there are n 3-handles attached to the resulting boundary, showing that surgery on L is $\#_n(S^1 \times S^2)$. If the Weak Generalized Property R Conjecture is true, there are some r, s so that when a distant 0-framed r -component unlink and a distant set of s canceling Hopf pairs is added to L (call the result L') then after a series of handle slides, L' becomes the distant union of an $n+r$ component unlink and a set of s canceling Hopf pairs.

To the given handle decomposition of Σ , add r copies of canceling 2- and 3- handle pairs and s copies of canceling 1- and 2-handle pairs. After this change of handle decomposition, the manifold Σ_2 that is the union of 0-, 1- and 2-handles can be viewed as obtained by the surgery diagram $L' \subset \partial D^4$. After a sequence of handle-slides, which preserve the diffeomorphism type of Σ_2 , L' is simplified as above; it can be further simplified by canceling the 1- and 2-handle pairs given by the set of s canceling Hopf pairs. What remains is a handle description of Σ_2 given by 0-framed surgery on an unlink of $n+r$ components.

Since Σ has Euler characteristic 2, it is obtained by attaching exactly $(n+r)$ 3-handles and then a single 4-handle to Σ_2 . If we view Σ_2 as obtained by attaching 2-handles via the 0-framed $(n+r)$ -component unlink, there is an obvious way to attach some set of $(n+r)$ 3-handles so that they exactly cancel the 2-handles, creating S^4 . It is a theorem of Laudenbach and Poenaru [LP] that, up to handle-slides, there is really only one way to attach $(n+r)$ 3-handles to Σ_2 . Hence Σ is diffeomorphic to S^4 as required.

Conversely, if 0-framed surgery on an n -component link $L \subset S^3$ gives $\#_n(S^1 \times S^2)$ then a smooth homotopy 4-sphere Σ can be constructed by attaching to the trace of the surgery n 3-handles and a 4-handle. If Σ is S^4 , then standard Cerf theory says one can introduce some canceling 1- and 2- handle pairs, plus some canceling 2- and 3- handle pairs to the given handle description of Σ , then slide handles until all handles cancel. But introducing these canceling handle pairs, when expressed in the language of framed links, constitutes the extra moves that are allowed under Weak Generalized Property R. (To see that the framings in the canceling Hopf pairs can be taken to be 0, first arrange them to

be even by choosing the diagram to respect the unique spin structure on Σ , then slide as necessary to reduce to the 0-framed case.) \square

5. HOW A HOPF PAIR CAN HELP SIMPLIFY

With the Weak Generalized Property R Conjecture in mind, return now to the square knot example of Section 3. In [Go1] it is shown that the introduction of a canceling 2,3-handle pair does make Figure 5 equivalent by handle-slides to the corresponding canceling diagram. In our dualized context, that means that the introduction of a canceling 1,2 handle pair (in our terminology, a canceling Hopf pair) should allow $Q \cup V_n$ (or more generally any $L_{n,k}$) to be handle-slid until the result is the union of the unlink and a canceling Hopf pair. In particular, the square knot examples provide no evidence against the Weak Generalized Property R Conjecture.

It is a bit mysterious how adding a Hopf pair can help to simplify links. Since the dotted circle is not allowed to slide over the other link components, it may seem that any slides over its meridian would only need to be undone to remove extraneous linking with the dotted circle. In this section, we give a general procedure that exploits a nontrivial self-isotopy of the meridian to create families of potential counterexamples to Generalized Property R. The examples $L_{n,k}$ of Section 3 arise as a special case for each fixed k . This suggests that Generalized Property R probably fails frequently for links constructed by this method, whereas Weak Generalized Property R does not.

Begin with an oriented 3-manifold M containing a framed link $L = L' \cup L''$. We will construct an infinite family of framed links in M that may not be handle-slide equivalent, but become so after a Hopf pair is added. (In our main examples, M will be S^3 with L a 0-framed 2-component link.) Let M' be the manifold made from M by surgery on L' .

Let $\varphi : T^2 \rightarrow M'$ be a generic immersion that is an embedding on each fiber $S^1 \times \{t\}$, $t \in S^1 = \mathbb{R}/\mathbb{Z}$. Denote the image circle $\varphi(S^1 \times \{t\})$ by C_t . Since φ is generic, it is transverse both to L'' and to the core of the surgery solid tori in M' . In particular,

- only finitely many circles C_{t_i} intersect L''
- each such circle C_{t_i} intersects L'' in exactly one point
- the curves C_{t_i} are pairwise disjoint and
- each C_{t_i} lies in the link complement $M - L' \subset M'$.

The immersion φ determines an infinite family of framed links $L_n = L' \cup L''_n$ in M , $n \in \mathbb{Z}$: For each t_i , there is an annulus A_i in $M - L'$

centered on C_{t_i} , transverse to φ near $S^1 \times \{t_i\}$ and intersecting L'' in an arc, with A_i oriented so that its positive normal direction corresponds to increasing t . See Figure 11, where the left and right edges of each diagram are glued together. The annuli A_i are unique up to isotopy, and we can assume they are pairwise disjoint. Let L''_n be the framed link obtained from L'' by diverting each arc $L'' \cap A_i$ so that it spirals $|n|$ times around in A_i (relative to its original position) as in Figure 11, starting with a right turn iff $n > 0$. (Thus $L_0 = L$.) We specify the framings by taking them to be tangent to A_i everywhere inside these annuli (before and after) and unchanged outside. Note that L_n depends on our initial choices of how to isotope the curves C_{t_i} off of the surgery solid tori, but changing the choices only modifies L_n by handle slides of L''_n over L' .

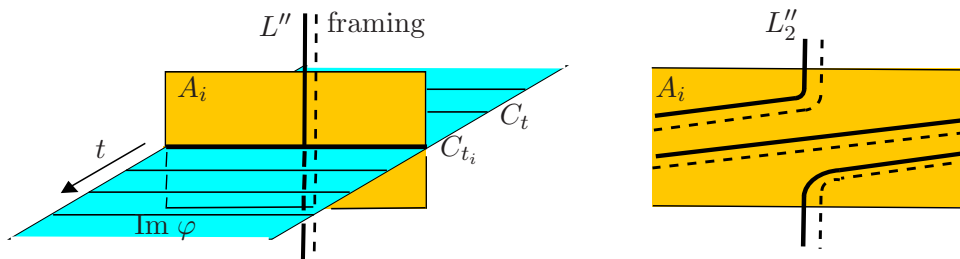

FIGURE 11.

In our main examples below, φ is an embedding. Whenever this occurs, there is a self-diffeomorphism of M' sending L'' onto L''_n , namely the n -fold Dehn twist along $\text{Im } \varphi$ parallel to the circles C_t . This shows directly in this case that the manifolds obtained by surgery on L_n are all diffeomorphic, regardless of n . In general, we can obtain more specific information:

Proposition 5.1. *For $L \subset M$ and φ a generic immersion as above, suppose that C_0 is disjoint from all other circles C_t and bounds an embedded disk in M whose algebraic intersection with nearby curves C_t is ± 1 . Then all of the framed links L_n become handle-slide equivalent after the addition of a single canceling Hopf pair.*

Since C_0 is nullhomologous in M , it has a canonical longitude, determined by any Seifert surface in M . Thus, the last hypothesis can be restated by saying that C_0 is an unknot in M for which the immersion φ determines the ± 1 framing.

To see that the hypotheses are not unreasonable, note that they are satisfied for $M = S^3$, L' empty and C_0 a $(1, \pm 1)$ -curve in the standard torus T . In this case, the links L''_n are obviously all equivalent for any

fixed L'' . (Since T is embedded, the links L_n'' are all related as above by Dehn twisting along T in $M' = M = S^3$. These Dehn twists are isotopic to the identity by an isotopy fixing one complementary solid torus of T and twisting the other by both of its circle actions.) The more interesting examples $L_{n,k}$ that arise in [Go1] will be exhibited below. These all arise from the same general procedure: Start with a 0-framed unlink in S^3 . Slide handles to create a more complicated link L satisfying Generalized Property R. Locate a suitable immersion φ , then apply Proposition 5.1 to create an infinite family $\{L_n\}$ of links that still satisfy the hypothesis of Generalized Property R, but not necessarily the conclusion for most n . One can generalize still further, for example replacing the domain of φ by a Klein bottle, although the authors presently have no explicit examples of this.

Proof of Proposition 5.1. Since φ is an immersion and C_0 is disjoint from all other C_t , there is a neighborhood of C_0 in M intersecting $\text{Im } \varphi$ in an annulus. Let C^* be a circle in this neighborhood, parallel to C_0 and disjoint from $\text{Im } \varphi$. Thus, it is pushed off of C_0 by the ± 1 framing in M . (All signs in the proof agree with the one in the statement of the theorem.) Let $L_n^* \subset M$ be the framed link obtained from L_n by adding a ± 2 -framed component along C_0 and a dotted circle along C^* . We will show that L_n^* is obtained from L_n by adding a canceling Hopf pair and sliding handles, and that the links L_n^* are all handle-slide equivalent. (As usual, the dotted circle is not allowed to slide over the other link components.) This will complete the proof.

To reduce L_n^* to L_n , slide C_0 over the dotted circle C^* using the simplest band connecting the parallel circles. This changes C_0 to a 0-framed meridian of C^* . (To compute the framing, recall that the dotted circle is automatically 0-framed, and that if C_0 and C^* have parallel orientations, we are subtracting handles with linking number ± 1 .) The dotted circle C^* bounds a disk $D \subset M$ and now has a 0-framed meridian, but this is not yet a canceling Hopf pair since the link L may still intersect D . However, we can easily remove each intersection by sliding the offending strand of L over the meridian. This does not change L but liberates the Hopf pair as required.

To see that the links L_n^* are handle-slide equivalent, we wish to isotope their common component C at C_0 around the continuous family C_t , returning to the original position at $C_1 = C_0$. By construction, C will never meet the dotted circle at C^* , but it will meet components of L_n . Since the isotopy lies in M' , each encounter with L' consists of a push across a surgery solid torus in M' , which is precisely a handle

slide in M of C over a component of L' . On the other hand, L''_n transversely intersects the path of C , once at each annulus A_i , so we must somehow reverse the crossing of C with L''_n there. Since the framing of C has ± 1 twist relative to φ , and hence to A_i , we can reverse the crossing by sliding L''_n over C . This is shown by Figure 12 (or its mirror image if the sign is -1), where A_i is drawn as in Figure 11, but after a diffeomorphism so that L''_n appears as a vertical line. (To see that the framing transforms as drawn, note that the right twist in the framing of the curve parallel to C cancels the left twist introduced by the self-crossing added to L''_n by the band-sum.) When C returns to its original position at $C_1 = C_0$, the link has been transformed to $L''_{n\pm 1}$ by handle slides, completing the proof. \square

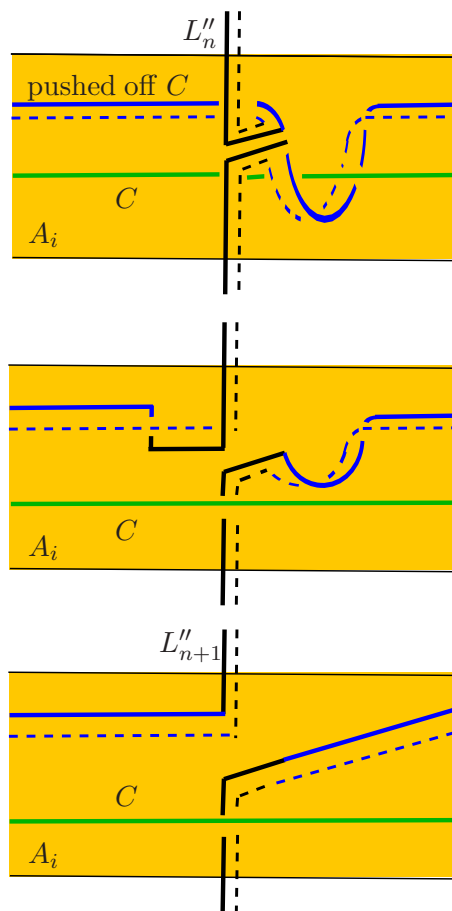

FIGURE 12.

The examples $L_{n,k}$ from Section 3 form a family as in Proposition 5.1 for each fixed k , generated by the handle-slide trivial case $n = 0$. Figure

13 shows the starting point. It is basically the right side of Figure 7 with both a twist-box and one of the 0-framed links moved to a more symmetric position.

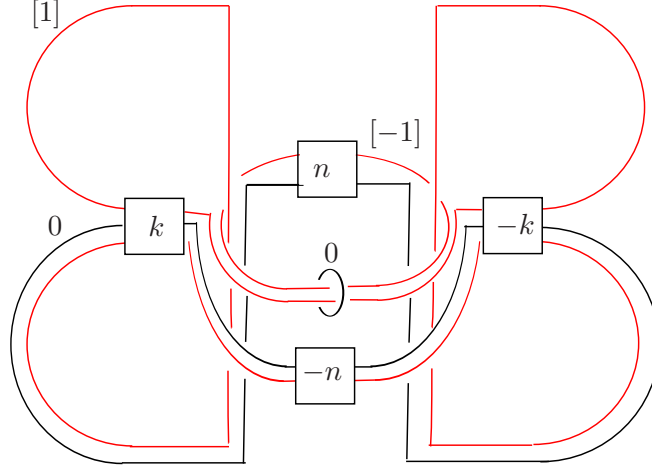

FIGURE 13.

Let M be the manifold diffeomorphic to S^3 obtained by surgery on the bracketed (red) circles. (Recall that these form an unlink in S^3 .) Let L' and L''_n be the small and large 0-framed circles, respectively. There is a vertical plane, perpendicular to the page, that bisects the picture. This plane bisects both $\pm n$ twist boxes and contains L' . We interpret this plane as a 2-sphere in the background S^3 . Surgery on L' splits the sphere into a disjoint pair of spheres. Neither of these lies in M' since each is punctured by both bracketed circles. However, we can remove the punctures by tubing the spheres together along both bracketed curves, obtaining an embedded torus in M' . The fibers C_t of this torus include a meridian of each bracketed circle, and the torus induces the 0-framing on these relative to the background S^3 . To see these in M , ignore the link L_n and unwind the bracketed link. Blowing down reveals the 0-framed meridian of the $[\mp 1]$ -framed curve to be a ± 1 -framed unknot in M (see [GS, Figure 5.18]). Thus, we can choose either meridian to be C_0 , with framing ± 2 in M , i.e., ± 1 in S^3 . (In either case, the framing in S^3 is preserved as we travel around the torus, so it becomes 0 in M when we reach the other meridian, showing that we cannot get off the ride in the middle.) Since L''_n intersects the torus at two points, at the $\pm n$ -twist boxes, it is easy to verify that the procedure turns L''_n into $L''_{n\pm 1}$, with the sign depending both on the choice of C_0 and the direction of motion around the torus. It is

instructive to view the procedure explicitly as a sequence of four handle slides in Figure 13.

It is not completely obvious how to trivialize the link by handle slides when $n = 0$. In the $k = 1$ case, Figures 8 and 9 isotope the link to Figure 1, solving the problem with a single handle slide. For general k , it is helpful to begin from a somewhat simpler picture of $L_{n,k}$, Figure 14, which is obtained from Figure 13 by an isotopy that rotates both $\pm k$ twist boxes 180 degrees outward about vertical axes. Now set $n = 0$ and consider the two handle slides in Figure 15 (following the arrows, framed by the plane of the paper). The slides first complicate L' , but after an isotopy shrinking the strands shown in green, L' simplifies, so that a slide over the $[-1]$ -framed circle changes it to a meridian of the $[+1]$ -framed circle. The $\pm k$ -twist boxes then cancel, showing that the link is trivial.

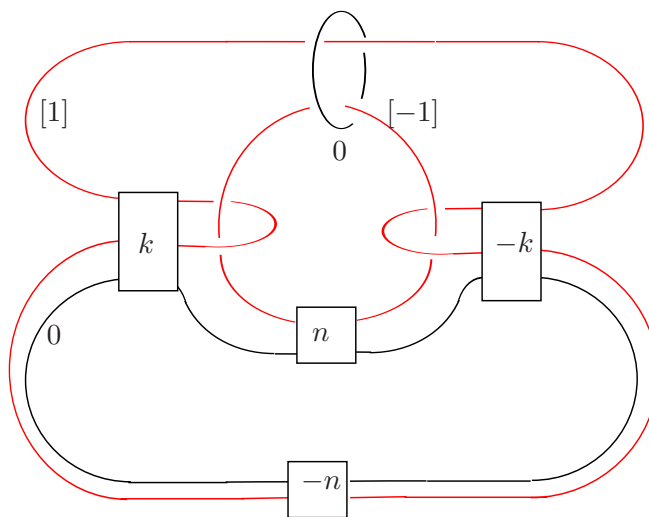

FIGURE 14.

This construction was derived from the dual construction in [Go1], showing that the relevant homotopy balls are standard by introducing a canceling 2-handle/3-handle pair. While it was not easy to explicitly dualize the construction, in the end the two constructions appear rather similar. The construction in [Go1] also involves introducing a new link component and moving it around a torus. In that case, the new component was a 0-framed unknot, the attaching circle of the new 2-handle. Akbulut's recent proof [Ak] that infinitely many Cappell-Shaneson homotopy 4-spheres are standard again relies on such a trick. In each case, the key seems to be an embedded torus with trivial normal bundle, to which a 2-handle is attached with framing ± 1 , forming

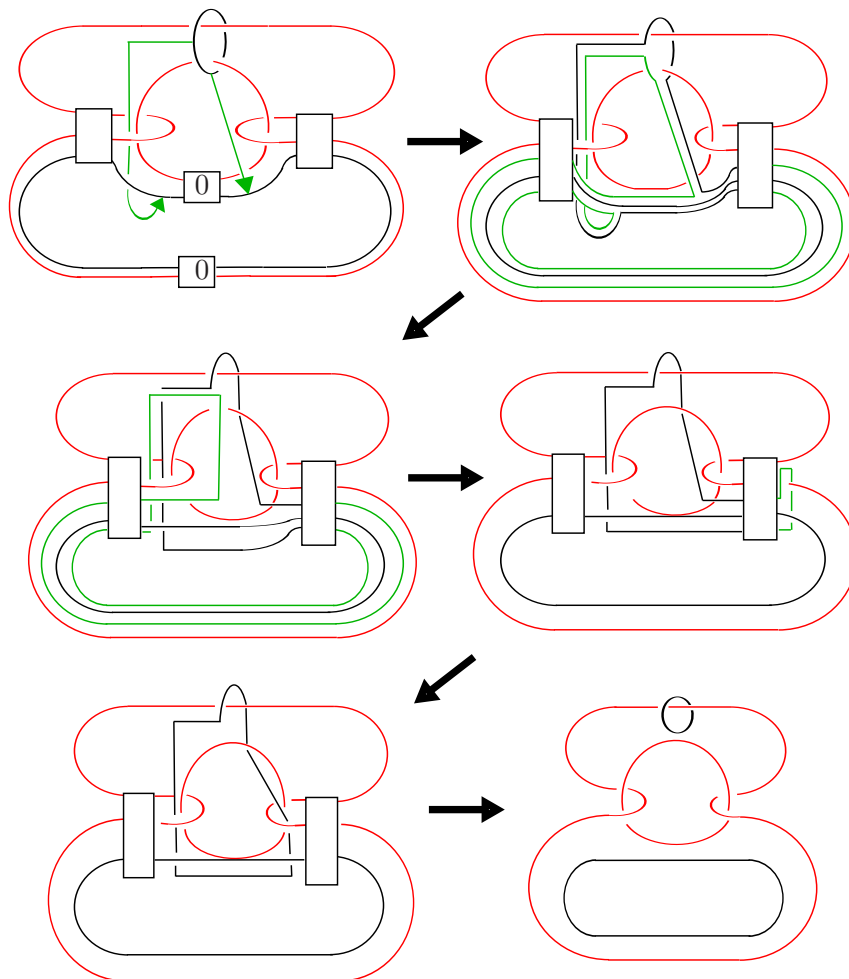

FIGURE 15.

a *fishtail neighborhood*. This neighborhood has self-diffeomorphisms that can undo certain cut-and-paste operations on the 4-manifold, as we implicitly saw in the case of Proposition 5.1 with φ an embedding. While this procedure has been known in a different context for at least three decades, underlying the proof that simply elliptic surfaces with fixed b_2 are determined by their multiplicities, it still appears to be underused. In fact, one can obtain a simpler and more general proof that many Cappell-Shaneson 4-spheres are standard by going back to their original definition and directly locating fishtail neighborhoods [Go2].

REFERENCES

- [Ak] S. Akbulut, Cappell-Shaneson homotopy spheres are standard, arXiv:0907.0136.
- [CL] T. Cochran, J. Levine, Homology boundary links and the Andrews-Curtis conjecture, *Topology* **30** (1991) 231–239.
- [FGMW] M. Freedman, R. Gompf, S. Morrison, K. Walker, Man and machine thinking about the smooth 4-dimensional Poincare conjecture, arXiv:0906.5177.
- [Ga] D. Gabai, Foliations and the topology of 3-manifolds. III, *J. Differential Geom.* **26** (1987) 479–536.
- [GS] R. Gompf and A. Stipsicz, 4-Manifolds and Kirby Calculus, Graduate Studies in Mathematics **20** American Mathematical Society, Providence, RI, 1999.
- [Go1] R. Gompf, Killing the Akbulut-Kirby 4-sphere, with relevance to the Andrews-Curtis and Schoenflies problems *Topology* **30** (1991), 97–115.
- [Go2] R. Gompf, More Cappell-Shaneson spheres are standard, arXiv:0908.1914.
- [Ki1] R. Kirby, A calculus for framed links in S^3 *Invent. Math* **45** (1978) 35–56.
- [Ki2] R. Kirby, Problems in Low-Dimensional Topology, in Geometric Topology, Edited by H. Kazez, AMS/IP Vol. 2, International Press, 1997.
- [LP] F. Laudenbach and V. Poénaru, A note on 4-dimensional handlebodies, *Bull. Soc. Math. France* **100** (1972) 337–344.
- [Ro] D. Rolfsen, Knots and Links, Mathematics Lecture Series, **7**. Publish or Perish, Inc., Berkeley, Calif., 1976.
- [ST] M. Scharlemann, A. Thompson, Fibered knots and Property 2R, to appear, ArXiv 0901.2319 .

ROBERT GOMPF, MATHEMATICS DEPARTMENT, UNIVERSITY OF TEXAS AT AUSTIN,
1 UNIVERSITY STATION C1200, AUSTIN TX 78712-0257, USA

E-mail address: gompf@math.utexas.edu

MARTIN SCHARLEMANN, MATHEMATICS DEPARTMENT, UNIVERSITY OF CALIFORNIA,
SANTA BARBARA, CA USA

E-mail address: mgscharl@math.ucsb.edu