

Nonlocal SUSY deformations of periodic potentials

David J. Fernández C.* , Bogdan Mielnik*[†],
Oscar Rosas-Ortiz*, and Boris F. Samsonov[‡]

* Departamento de Física, CINVESTAV-IPN, A.P. 14-740, 07000 México D.F., Mexico

[†] Institute of Theoretical Physics, UW, Hoża 69, Warsaw, Poland

[‡] Department of Quantum Field Theory, Tomsk State University 36 Lenin Ave., 634050 Tomsk, Russia

Abstract. Irreducible 2-order Darboux transformations are applied to the periodic Schrödinger's operators. It is shown that for the pairs of factorization energies inside of the same forbidden band they can create new non-singular potentials with periodicity defects and bound states embedded into the spectral gaps. The method is applied to the Lamé and periodic piece-wise transparent potentials. An interesting phenomenon of *translational Darboux invariance* reveals nonlocal aspects of the supersymmetric deformations.

PACS: 03.65.Ge; 03.65.Fd; 03.65.Ca

Keywords: Darboux transformation, supersymmetric quantum mechanics, isospectral periodic potentials

1 Introduction

The one dimensional periodic potentials play an essential role in physics. The simple model of Kronig-Penney has been recently used for describing superlattice structure of ultrathin epitaxial layers with diverse constituent-semiconductor compositions such as GaAs and $\text{Al}_x\text{Ga}_{1-x}\text{As}$ [1]. The Kronig-Penney lattice with R matrix interaction at the end of each block has been proposed for analyzing the behavior of neutrons in crystals [2]. The Mathieu equation has successfully described the diffraction of intense standing light by strong sinusoidal media [3].

The progress of these models is delayed by the fact that few analytically solvable periodic potentials are known, including the text-book examples of Kronig-Penney [4], Lamé, and Mathieu [5]. The inverse Sturm-Liouville methods could be applied [6] but up to the authors knowledge no simple periodic potentials have been found in this way. In order to enlarge the class, the Darboux transformations of various orders can be used [7, 8, 9, 10, 11], the subject commonly known as the *supersymmetric quantum mechanics* (SUSY QM) [12, 13, 14]. By employing 2-nd order irreducible techniques, proposed initially for non-periodic potentials [15] (see also a hint by Krein [16]), the factorization energies above the bound states can give new non-singular potentials [17, 18, 19]. We shall now extend the method by showing that it can be applied in a non-singular way to the periodic potentials if the E -values are in the same spectral gap. In the most interesting cases, the operation can generate the defects of the periodic structure, creating the bound states inserted into spectral gaps (a typical phenomenon in solid state physics [20]).

Below, the technique will be applied to Lamé and periodically continued soliton potentials. In its most inconspicuous form, it produces an interesting non-local effect: the transformed potential becomes an exact or approximate displaced copy of the initial one, a phenomenon which we call the *translational invariance with respect to Darboux transformations* or shortly *Darboux invariance* [21]. Quite significantly, the effect shows itself asymptotically even if the periodicity of the initial potential is not preserved. It permits to understand the structure of Darboux generated lattice impurities as the *contact effects* caused by a conflict between two non-local *SUSY* transformations.

2 First and second order Darboux transformations

Let us outline briefly the main points of the Darboux method. Consider the Schrödinger equation with an arbitrary potential $V_0(x)$:

$$h_0\psi_E(x) = E\psi_E(x), \quad h_0 = -\partial_x^2 + V_0(x). \quad (1)$$

The method permits to use the solutions $\psi_E(x)$ of the initial Schrödinger equation (1) to obtain the solutions $\varphi_E(x)$ of the transformed Schrödinger equation

$$h_1\varphi_E = E\varphi_E, \quad h_1 = -\partial_x^2 + V_1(x) \quad (2)$$

by applying a certain differential operator L , $\varphi_E(x) = L\psi_E(x)$. In the first order case $L = -\partial_x + w(x)$, the transformation yields:

$$\Delta V(x) = V_1(x) - V_0(x) = -2[\ln u(x)]'' \quad (3)$$

where $u(x)$ is a solution of (1) called the *transformation function* while $w(x) = [\ln u(x)]'$ is the *superpotential*. Note that the method applies for any $E \in \mathbb{R}$ in the spectrum or in the resolvent set of h_0 ; it links the solutions of (1) and (2), without requiring that ψ_E should be bounded or square integrable (though in some problems, such assumptions can be pertinent). Quite obviously, in order to avoid the creation of singularities in $w(x)$ and in $V_1(x)$ one must look for nodeless $u(x)$.

In the second order case, the new potentials and eigenfunctions are defined by a pair of transformation functions $u_1(x)$ and $u_2(x)$, $h_0 u_{1,2} = \alpha_{1,2} u_{1,2}$ (we use deliberately the symbols α_1, α_2 instead of E_1, E_2 to stress that both parameters do not need to belong to the spectrum of h_0). The transformation reads:

$$\begin{aligned}\varphi_E &= W^{-1}(u_1, u_2)W(u_1, u_2, \psi_E), \\ \Delta V &= -2[\ln W(u_1, u_2)]''\end{aligned}\tag{4}$$

where W denotes the Wronskian of the corresponding functions.

For the periodic potentials $V_0(x) \equiv V_0(x + T)$ the method is often affected by singularities. Some authors opt to use the band edge solutions [7, 8, 17] (which are periodic or antiperiodic [22]). We are going to show that the use of the generalized *Bloch functions* belonging to the same spectral gap brings even more interesting results.

3 Bloch eigenfunctions and Darboux transformations

The Bloch functions are usually defined as physically interpretable eigenfunctions of (1) for E belonging to the spectrum of h_0 . Yet, they exist also out of the spectral area. By writing (1) for any $E \in \mathbb{R}$ as the first order differential equation for a vector formed by ψ and its derivative ψ'

$$\frac{d}{dx} \begin{bmatrix} \psi \\ \psi' \end{bmatrix} = \begin{bmatrix} 0 & 1 \\ V_0 - E & 0 \end{bmatrix} \begin{bmatrix} \psi \\ \psi' \end{bmatrix}\tag{5}$$

one sees that $\psi(x), \psi'(x)$ are given by a certain linear transformation applied to $\psi(0), \psi'(0)$:

$$\begin{bmatrix} \psi(x) \\ \psi'(x) \end{bmatrix} = b(x) \begin{bmatrix} \psi(0) \\ \psi'(0) \end{bmatrix}\tag{6}$$

where $b(x)$ is a 2×2 symplectic *transfer matrix* [22, 23]. Note that $b(x)$ can be expressed in terms of special real solutions $v_1(x), v_2(x)$ of (5) defined by the initial data $v_1(0) = 1, v_1'(0) = 0, v_2(0) = 0, v_2'(0) = 1$:

$$b(x) = \begin{pmatrix} v_1(x) & v_2(x) \\ v_1'(x) & v_2'(x) \end{pmatrix},\tag{7}$$

implying $\text{Det}[b(x)] \equiv 1$. If $V_0(x)$ is periodic, an essential role belongs to the *Floquet* (or *monodromy*) *matrix* $b(T)$ (see e.g. [22, 24]). Since $\text{Det}[b(T)] = 1$, its eigenvalues β are given by:

$$\beta^2 - D\beta + 1 = 0\tag{8}$$

where

$$D = D(E) = \text{Tr}[b(T)]\tag{9}$$

is called the *Lyapunov function*, *Hill determinant* or *discriminant* of (1) [6, 22, 25]. As follows from (8), β takes two values β_{\pm} such that $\beta_+\beta_- = 1$:

$$\beta_{\pm} = D/2 \pm \sqrt{D^2/4 - 1} . \quad (10)$$

Whenever for any $E \in \mathbb{R}$, one of the eigenvectors of $b(T)$ (for either $\beta = \beta_+$ or $\beta = \beta_-$) is used as an initial condition for ψ and ψ' at $x = 0$, it originates a special solution of (1) for which the transfer law (6) at $x = T$ reduces to:

$$\psi(T) = \beta\psi(0), \quad \psi'(T) = \beta\psi'(0) \quad (11)$$

and more generally

$$\psi(x + nT) = \beta^n\psi(x), \quad \psi'(x + nT) = \beta^n\psi'(x), \quad (12)$$

$n = 0, \pm 1, \dots$ The eigenfunctions $\psi(x)$ of (1) which fulfill (11,12) exist for any parameter $E = \alpha \in \mathbb{R}$ (not necessarily belonging to the energy spectrum of h_0) and are called the *Bloch functions*. Their structure depends essentially on the values of E .

If $|D(E)| < 2$, E is *inside* of a spectral band and the eigenvalues β_{\pm} in (10) are complex numbers of modulus 1. We can put then

$$\beta_+ = \exp(ikT) \quad \beta_- = \exp(-ikT) \quad (13)$$

where k is a real parameter called the *crystal quasimomentum*. The equations (10) and (13) define an implicit function $k = k(E)$ called the *dispersion law*. The corresponding bounded and essentially complex Bloch functions are the ones traditionally considered in the solid state physics.

The equation $|D(E)| = 2$, in turn, defines the band edges [22]. Following [17] let us denote them by

$$E_0 < E_1 \leq E_{1'} < E_2 \leq E_{2'} < \dots < E_j \leq E_{j'} < \dots$$

At each band edge the Bloch eigenvalues (10) are $\beta_+ = \beta_- = \pm 1$, and the degenerate $b(T)$ defines one Bloch function, periodic or antiperiodic. Both edge eigenfunctions ψ_j and $\psi_{j'}$ are real and have the same number j of nodes.

If $|D(E)| > 2$, the eigenvalues (10) are real $\beta_+ = \beta$, $\beta_- = 1/\beta$ ($0 \neq \beta \in \mathbb{R}$); $b(T)$ has the real eigenvectors for both $\beta = \beta_{\pm}$, originating the real Bloch functions, which form a natural basis for the general solutions of (1). (In what follows, when speaking about the Bloch functions in this regime, we shall always have in mind the *real Bloch functions*, without specially mentioning it. The complex Bloch functions [26] have a constant phase and are easily reduced to the real ones.) Note that all solutions of (1) diverge in either $+\infty$ or $-\infty$, hence E is in a forbidden band (resolvent set of h_0). The Bloch functions here are deprived of a physical meaning but happen to be crucial as transformation functions in the Darboux algorithms. Their properties still depend on the specific localization of E in the resolvent set.

The interval $(-\infty, E_0)$ constitutes the lowest forbidden band where $D > 2$ and $\beta_{\pm} > 0$. In the following spectral gaps $(E_j, E_{j'})$ one has either $D > 2$ and $\beta_{\pm} > 0$ for j even or $D < -2$ and $\beta_{\pm} < 0$ for j odd.

Let $u(x)$ be one of the Bloch eigenfunctions for $E = \alpha < E_0$. Due to (12), $u(x)$ has either no zeroes at all or a periodically distributed infinite set. The last possibility cannot occur since then, according to the Sturm oscillator theorem (see e.g. [27]), the ground state eigenfunction should have an infinity of zeroes as well, which contradicts the fact that $\psi_0(x)$ is nodeless. Thus, for any $\alpha < E_0$ there exist two linearly independent *nodeless* Bloch eigenfunctions, both suitable to generate non-singular Darboux transformations (3). As nodeless must be the Wronskian $W(u_1, u_2)$ for any two Bloch functions u_1, u_2 with $\alpha_1, \alpha_2 < E_0$, thus generating a non-singular reducible transformation (4) [28].

Let us now examine the situation in the higher spectral gaps. We shall show that while the first order Darboux transformations here are singular, the second order ones can be regular, in analogy with [29]. Indeed one has:

Proposition 1. Let u_1, u_2 be two linearly independent Bloch eigenfunctions of (1), $u_i(x+T) = \beta_i u_i(x)$, $h_0 u_i = \alpha_i u_i$, with α_1, α_2 in the spectral gap $(E_j, E_{j'})$ of a continuous, periodic $V_0(x)$. Then: (i) In each periodicity interval $[x_0, x_0 + T)$ both $u_1(x)$ and $u_2(x)$ have j roots, depending continuously on α_1 and α_2 ; (ii) if $\alpha_1 \neq \alpha_2$, or $\alpha_1 = \alpha_2 = \alpha$ but $\beta_1 \neq \beta_2$, then the roots of u_1 and u_2 cannot coincide; they form two infinite alternating sequences extending from $-\infty$ to $+\infty$; (iii) the Wronskian $W(x) \equiv W(u_1, u_2)$ has no nodal points on \mathbb{R} (and so, defines a non-singular transformation (4)).

Proof. (i) is well known in the theory of Hill's equations [25]. (ii) If $\alpha_1 < \alpha_2$ then due to the oscillatory theorem [27], between each two neighbouring nodes of u_1 there is at least one nodal point of u_2 (but no more than one because of (i)). Moreover, the nodal point of u_1 cannot be nodal for u_2 , since then the oscillatory theorem would require still one more node of u_2 in between the vicinal nodes of u_1 ; so u_2 would have more nodes than u_1 in $[x_0, x_0 + T)$. If $\alpha_1 = \alpha_2$ but $\beta_1 \neq \beta_2$, u_1, u_2 cannot have a common nodal point. If they did, they would satisfy proportional initial conditions at the common node and so, they would be proportional all over \mathbb{R} , which is impossible if $\beta_1 \neq \beta_2$. Finally, due to (12) the zeroes of u_1 and u_2 are periodically distributed on \mathbb{R} , so they must form two alternating sequences extending from $-\infty$ to $+\infty$. (iii) Let now ν and $\tilde{\nu}$ be two neighbouring nodes of $u_1(x), u_2(x)$ respectively. Observe, that at the extremes of the interval $(\nu, \tilde{\nu})$ the values $W(\nu) = -u_2(\nu)u_1'(\nu)$ and $W(\tilde{\nu}) = u_1(\tilde{\nu})u_2'(\tilde{\nu})$ cannot vanish and must have the same sign. Indeed, since we assume that neither u_1 nor u_2 have zeros inside of $(\nu, \tilde{\nu})$ the sign of $u_1(x)$ coincides with the sign of $u_1'(\nu)$ while the sign of $u_2(x)$ is opposite to that of $u_2'(\tilde{\nu})$ in all $[\nu, \tilde{\nu}]$. Moreover, the first derivative $W'(u_1, u_2) = (\alpha_1 - \alpha_2)u_1 u_2$ either vanishes everywhere (if $\alpha_1 = \alpha_2$), or nowhere in $(\nu, \tilde{\nu})$ (if $\alpha_1 \neq \alpha_2$). In both cases $W(u_1, u_2)$ is monotonic, extends between two non-zero values of the same sign and so, it cannot vanish in $[\nu, \tilde{\nu}]$. Since the same holds for any other neighbouring nodes of u_1 and u_2 then $W(u_1, u_2)$ has no nodal points on the entire \mathbb{R} . ■

While for a fixed $\alpha \in (E_j, E_{j'})$ the zeroes of the Bloch pair are isolated points, when α varies, they draw a sequence of continuous *nodal curves*. These curves cannot intersect inside of $(E_j, E_{j'})$ and, moreover, each one can intersect any vertical line $x = c$ only once (compare Proposition 1ii), so they form a sequence of strictly monotonic branches which meet at the band edges, where two Bloch solutions degenerate to one (see Fig. 1); a pattern which permits to extend the Proposition 1 to non-trivial linear combinations of the Bloch functions. In what follows we shall use the simplified symbol u^β to denote the Bloch eigenfunction for any α , corresponding to the Bloch eigenvalue β (so to be exact $u^\beta \equiv u(x, \alpha, \beta)$).

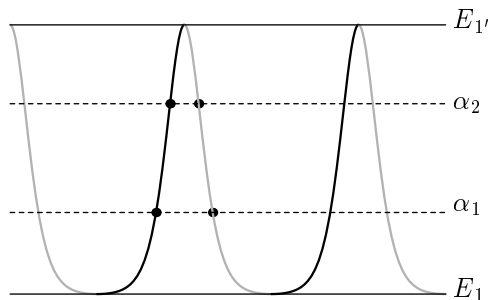

Figure 1: The “nodal curves” illustrating the α -dependence of the nodal points of two Bloch functions u^β (black line) and $u^{1/\beta}$ (shadow line). Notice that any two vicinal nodes situated at $\alpha = \alpha_1$ are never separated just by a single node at $\alpha = \alpha_2$, though they can be separated by a pair. The graphic was obtained for the Lamé potential (23) with $n = 1$, $m = 0.99$.

Theorem 1. Let $u_1(x) = u^{\beta_1}(x)$, $u_2(x) = u^{\beta_2}(x)$ be two nontrivial Bloch functions of h_0 for two different eigenvalues $\alpha_1, \alpha_2 \in (E_j, E_{j'})$ and let $v_1(x) = u^{\beta_1} + \kappa_1 u^{1/\beta_1}$, $v_2(x) = u^{\beta_2} + \kappa_2 u^{1/\beta_2}$, where $(\kappa_1, \kappa_2) \in \mathbb{R}^2$. Then there exists an infinite closed sector in \mathbb{R}^2 , bordered by κ_1 - and κ_2 -axes, where the Wronskians $W(v_1, v_2)$ are nodeless.

Proof. Note that the Bloch functions $u^{\beta_1}, u^{1/\beta_1}$ ($\alpha = \alpha_1$) and $u^{\beta_2}, u^{1/\beta_2}$ ($\alpha = \alpha_2$) determine four sequences of nodal points on \mathbb{R} . In view of the nodal configuration of Fig. 1, each two neighbouring nodes $\nu_1, \tilde{\nu}_1$ of u^{β_1} and u^{1/β_1} can be separated by a pair of nodes $\nu_2, \tilde{\nu}_2$ of $u^{\beta_2}, u^{1/\beta_2}$ but not by just one of them. Without losing generality one can choose the point $x = 0$ so that $u^{\beta_i}(0) \neq 0$, $u^{1/\beta_i}(0) \neq 0$ and that the four subsequent nodal points are $\nu_1, \tilde{\nu}_1, \nu_2, \tilde{\nu}_2$ (belonging to $u^{\beta_1}, u^{1/\beta_1}, u^{\beta_2}, u^{1/\beta_2}$ respectively). By multiplying each Bloch functions by ± 1 one can also achieve $u^{\beta_i}(x_0) > 0$ and $u^{1/\beta_i}(x_0) > 0$. According to Proposition 1, all Wronskians $W(u^{\beta_1}, u^{\beta_2})$, $W(u^{\beta_1}, u^{1/\beta_2})$, $W(u^{1/\beta_1}, u^{\beta_2})$, $W(u^{1/\beta_1}, u^{1/\beta_2})$ have constant signs; moreover, it is straightforward to check that they are now strictly positive. Henceforth, by choosing $\kappa_1, \kappa_2 \geq 0$ one obtains

$$W(v_1, v_2) = W(u^{\beta_1}, u^{\beta_2}) + \kappa_2 W(u^{\beta_1}, u^{1/\beta_2}) + \kappa_1 W(u^{1/\beta_1}, u^{\beta_2}) + \kappa_1 \kappa_2 W(u^{1/\beta_1}, u^{1/\beta_2})$$

strictly positive, producing a non-singular Darboux transformation (4). ■

4 The translational effects of the Darboux operations

We shall show now that for certain classes of potentials the Darboux transformations might yield an interesting non-local effect. Consider first of all the 1-soliton well [30]

$$V_0(x) = -2\gamma_0^2 \operatorname{sech}^2 \gamma_0 x, \quad \gamma_0 > 0, \quad (14)$$

with one eigenvalue $E_0 = -\gamma_0^2$. We shall check that the wells (14) admit special Darboux transformations leading to the exact coordinate displacements. Note that the Schrödinger equation (1) with the potential (14) can be exactly solved for any $E \in \mathbb{R}$ by applying the Darboux transformation (3) to the free Hamiltonian. One of the solutions is:

$$u(x) = \frac{\cosh \gamma_0(x + \delta_1)}{\cosh \gamma_0 x} e^{-\gamma_1 x} \quad (15)$$

If now $\alpha_1 = -\gamma_1^2 < E_0$, then using (15) as a 1-SUSY transformation function for our 1-soliton well $V_0(x)$, one obtains a displaced version of (14), $V_1(x) = V_0(x + \delta_1)$, with

$$\delta_1 = \frac{1}{\gamma_0} \operatorname{artanh} \frac{\gamma_0}{\gamma_1} \quad (16)$$

If $\alpha_1 > E_0$, the first order Darboux transformation can neither produce the displaced, nor even nonsingular potential, but the second order SUSY opens new possibilities. Taking $\delta_1 = \delta + i\frac{\pi}{2\gamma_0} = \delta + i\tau'$, where τ' is half the imaginary period of the transparent well (14), we easily induce a *complex* displacement generated by $u_1 = e^{-\gamma_1 x} \sinh \gamma_0(x + \delta) / \cosh \gamma_0 x$ and leading to the *real but singular* $V_1(x) = 2\gamma_0^2 \operatorname{csch}^2 \gamma_0 x$. By repeating now the operation with a new complex $\delta_2 = \delta' - i\frac{\pi}{2\gamma_0}$ one returns to the original transparent well displaced additionally by $\delta'' = \delta_1 + \delta_2 = \delta + \delta'$. The corresponding nodeless Wronskian in (4) is:

$$W(u_1, u_2) = (\gamma_1 - \gamma_2) \frac{\cosh \gamma_0(x + \delta'')}{\cosh \gamma_0 x} e^{-(\gamma_1 + \gamma_2)x}. \quad (17)$$

Until now our second order displacements (4) were backed by pairs of first order transformations (3) of the displacement type, with real or complex δ 's. It would be interesting to achieve the same effect without this kind of first order scenario. This indeed happens for the symmetric 2-soliton well

$$V_0(x) = \frac{2(\gamma_1^2 - \gamma_2^2)(\gamma_1^2 \operatorname{sech}^2 \gamma_1 x + \gamma_2^2 \operatorname{csch}^2 \gamma_2 x)}{(\gamma_1 \tanh \gamma_1 x - \gamma_2 \coth \gamma_2 x)^2} \quad (18)$$

obtained from the null potential using (4) with $u_1(x) = \cosh \gamma_1 x$, $u_2(x) = \sinh \gamma_2 x$, where $\gamma_2 > \gamma_1$. The potential (18) has two discrete energy levels at $E_0 = -\gamma_2^2$, $E_1 = -\gamma_1^2$. Denote now $u_3(x) = e^{-\gamma_3 x}$, $u_4(x) = e^{-\gamma_4 x}$ and $W_{ij}(x) \equiv W(u_i(x), u_j(x))$, $W_{ijl}(x) \equiv W(u_i(x), u_j(x), u_l(x))$; then apply an isospectral second order Darboux transformation to the potential (18) using two new eigenfunctions $\tilde{u}_3(x) = W_{123}(x)/W_{12}(x)$, $\tilde{u}_4(x) = W_{124}(x)/W_{12}(x)$. A straightforward calculation shows:

$$\tilde{W}_{34}(x) = e^{-(\gamma_3 + \gamma_4)x} (\gamma_3 - \gamma_4) \Gamma W_{12}(x + \delta) / W_{12}(x) \quad (19)$$

where

$$\Gamma^2 = (\gamma_1^2 - \gamma_3^2)(\gamma_2^2 - \gamma_3^2)(\gamma_1^2 - \gamma_4^2)(\gamma_2^2 - \gamma_4^2) \quad (20)$$

As one can easily see, $\tilde{W}_{34}(x)$ induces a second order Darboux displacement, $V_1(x) = V_0(x + \delta)$, if and only if the following two numbers coincide:

$$\delta = \frac{1}{\gamma_1} \operatorname{artanh} \left[\frac{\gamma_1(\gamma_3 + \gamma_4)}{\gamma_1^2 + \gamma_3 \gamma_4} \right] \quad (21)$$

$$\delta = \frac{1}{\gamma_2} \operatorname{artanh} \left[\frac{\gamma_2(\gamma_3 + \gamma_4)}{\gamma_2^2 + \gamma_3 \gamma_4} \right] \quad (22)$$

Notice that there are three regions in which (19) yields a non-singular Darboux transformation (4), $\Omega_1 = \{\gamma_3, \gamma_4 < \gamma_1\}$, $\Omega_2 = \{\gamma_1 < \gamma_3, \gamma_4 < \gamma_2\}$, $\Omega_3 = \{\gamma_3, \gamma_4 > \gamma_2\}$, but only in Ω_2 can one achieve the consistency between (21) and (22), visualized by the intersection of two surfaces represented on Fig. 2. The points (γ_3, γ_4) on the intersection curve provide

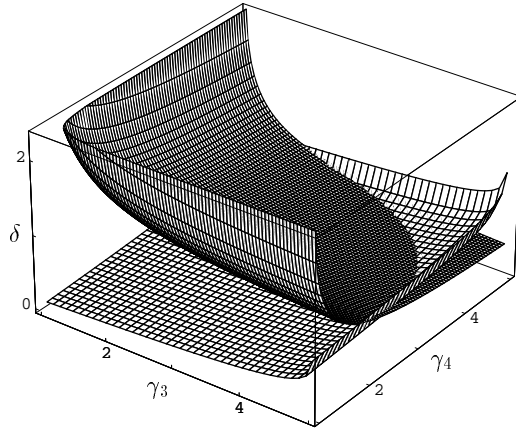

Figure 2: The intersection of two surfaces (21) and (22) provides the consistent data for the second order Darboux displacements of the 2-solitonic potential (18).

the precise data for the displacement, with δ defined as the common value of (21) and (22).

The approximate forms of all these phenomena can be observed for the “collage potentials” composed of fragments of the transparent wells. The simplest case is the periodic potential obtained by truncating (14) to a finite interval $[-a, a]$ and then periodically repeating all over \mathbb{R} . One arrives at a periodic $V(x)$ with $T = 2a$, for which the Schrödinger equation (1) can be explicitly solved for any $E = k^2$, permitting to calculate the Lyapunov function [31]

$$\frac{1}{2}D = \frac{w_0}{k} \left(\frac{w_0^2 - 2k^2 - \gamma_0^2}{k^2 + \gamma_0^2} \right) \sin 2ka + \left(1 - \frac{2w_0^2}{k^2 + \gamma_0^2} \right) \cos 2ka$$

(with $w_0 = \gamma_0 \tanh \gamma_0 a$). Notice that the equation defining the band edges $|D| = 2$ is no more complicated than for the Kronig-Penney potential. The discrete energy level of the original potential (14) at $E_0 = -\gamma_0^2$ belongs now to the lowest allowed band [31]. The former ground level expands into the first spectral band and the interval (E_0, ∞) splits into the subsequent gaps and bands.

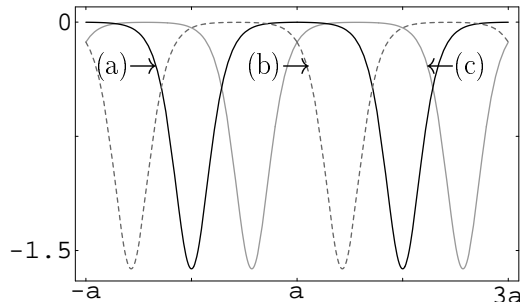

Figure 3: Second order Darboux transformations of the periodically continued one soliton potential with $a = 5$ and $\gamma_0 = 0.9$. (a) The initial potential; (b-c) The modified forms after using (4) with u_1, u_2 chosen to be the pairs of Bloch functions for $\alpha_1 = -2$ and $\alpha_2 = -0.9$.

To illustrate the result of the Darboux transformation, we choose $a = 5$ and $\gamma_0 = 0.9$,

the numerical values of the lowest band edges becoming $E_0 = -0.8107$, $E_1 = -0.8090$, $E_{1'} = 0.0001$, $E_2 = 0.1578$, $E_{2'} = 0.1580$; $E_3 = 0.5926$, $E_{3'} = 0.5929$. If now the transformation (4) is applied, the transformed potential $V_1(x)$ approximates very well a displaced copy of $V(x)$: the effect looks as if the main body of $V_0(x)$ was displaced, leaving only some tiny remnants in vicinities of the former peaks (Fig.3).

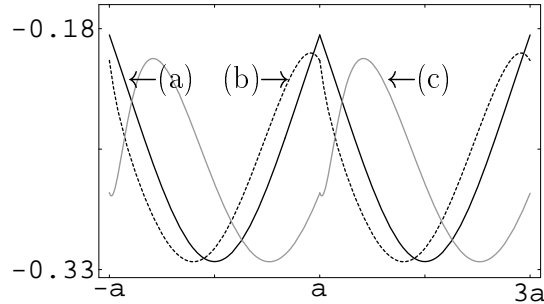

Figure 4: Second order Darboux transformations of the periodically continued one soliton potential with $a = 2$ and $\gamma_0 = 0.4$. (a) The initial potential; (b-c) The modified forms after using (4) with u_1, u_2 chosen to be the pairs of Bloch functions for $\alpha_1 = -10$ and $\alpha_2 = -2$.

The phenomenon quite obviously imitates the behaviour of the original 1-soliton well, with an accuracy depending on the size of the repeated 1-soliton fragment (the bigger the fragment the better the effect). To examine this accuracy, we have performed the next computer experiment for the periodic potential composed of smaller pieces of (14), taking $\gamma_0 = 0.4$ and $a = 2$. The lowest band edges are now $E_0 = -0.2664$, $E_1 = 0.3204$, $E_{1'} = 0.3817$, $E_2 = 2.1967$, $E_{2'} = 2.2073$, $E_3 = 5.2838$, $E_{3'} = 5.2885$, and the results of the 2-order Darboux transformation are shown on Fig.4. One can again observe a displacement affecting the main part of the original potential, though now the points of non-differentiability visibly resist the operation.

An even more interesting effect occurs for the fragmented 2-soliton wells. By choosing the truncation borders $\pm a$ exactly at its minima, then repeating periodically and applying (4) one gets a surprisingly exact picture of the displacement (Fig. 5).

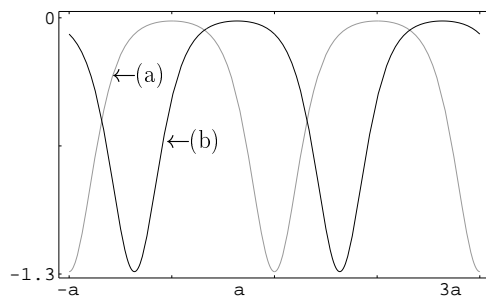

Figure 5: Darboux operations on a periodically continued two soliton potential with $\gamma_1 = 0.8$, $\gamma_2 = 0.805$ and $a = 4.0279$. (a) The initial potential; (b) the result of a 2-order Darboux transformation for a pair of Bloch functions with $\alpha_1 = -0.6$, $\alpha_2 = -0.0007$ in the first energy gap ($E_1 = -0.6359$, $E_{1'} = 0$). Notice a very good approximation to a finite displacement.

The effect once again cannot be perfect (the points of discontinuity of the third derivative are now fixed), but the difference between the supersymmetrically transformed and displaced potential on our scale is practically invisible.

Significantly, the existence of this kind of non-local phenomena (exact or approximate) tells a lot about the nature of the periodicity defects which can be supersymmetrically generated. To see this, let us consider a class of periodic potentials where the (non-local) displacements appear in their purest form.

5 Supersymmetric transformations of the Lamé potentials

We refer to the Lamé potentials, frequently considered in crystallography:

$$V_0(x) = n(n+1)m \operatorname{sn}^2(x|m), \quad n \in \mathbb{N} \quad (23)$$

where $\operatorname{sn}(x|m)$ is the standard Jacobi elliptic function. The potentials (23) have exactly $2n+1$ band edges, $n+1$ allowed and $n+1$ forbidden bands, and there exist analytic formulae for the eigenfunctions at the band edges (see e.g. [17]).

We shall show that the global SUSY displacement is a typical phenomenon in the subclass of Lamé functions with $n=1$, already for the first order Darboux transformations. In fact, we have

Theorem 2. The Bloch eigenfunctions $u^\beta(x)$, $u^{1/\beta}(x)$ for a factorization energy $\alpha \leq E_0$ used in the first order Darboux transformations generate a displacement $V_1(x) = V_0(x + \delta)$ of an arbitrary periodic $V_0(x)$ if and only if

$$u^\beta(x)u^{1/\beta}(x + \delta) = c \quad (24)$$

where c is a constant.

Proof. Suppose that $u^\beta(x)$ induces the Darboux displacement $V_1(x) = V_0(x + \delta)$. The standard Darboux theory and $u^\beta(x + T) = \beta u^\beta(x)$ imply that $\tilde{u}^{1/\beta}(x) \propto 1/u^\beta(x)$ is the Bloch eigenfunction for h_1 with the same factorization energy α , so that $\tilde{u}^{1/\beta}(x + T) = (1/\beta)\tilde{u}^{1/\beta}(x)$. As $V_1(x) = V_0(x + \delta)$, the coordinate change $x \rightarrow x + \delta$ in the Schrödinger equation for $\tilde{u}^{1/\beta}(x)$ and the fact that the Bloch eigenfunctions are unique up to a multiplicative factor imply that $\tilde{u}^{1/\beta}(x) \propto u^{1/\beta}(x + \delta)$. Hence

$$u^{1/\beta}(x + \delta) = \frac{c}{u^\beta(x)} \Rightarrow u^\beta(x)u^{1/\beta}(x + \delta) = c \quad (25)$$

Conversely, suppose that the Bloch eigenfunctions of h_0 for the eigenvalue α satisfy $u^\beta(x)u^{1/\beta}(x + \delta) = c$. Then perform a first order Darboux transformation using $u^\beta(x)$. In terms of $u^\beta(x)$ and $u^{1/\beta}(x)$ the initial potential is given by:

$$V_0(x) = \frac{[u^\beta(x)]''}{u^\beta(x)} + \alpha = \frac{[u^{1/\beta}(x)]''}{u^{1/\beta}(x)} + \alpha. \quad (26)$$

Quite similarly, the final potential can be expressed in terms of $\tilde{u}^{1/\beta}(x) \propto 1/u^\beta(x) = u^{1/\beta}(x + \delta)/c$:

$$V_1(x) = \frac{[\tilde{u}^{1/\beta}(x)]''}{\tilde{u}^{1/\beta}(x)} + \alpha = \frac{[u^{1/\beta}(x + \delta)]''}{u^{1/\beta}(x + \delta)} + \alpha. \quad (27)$$

By comparing (26) and (27) one immediately sees: $V_1(x) = V_0(x + \delta)$. ■

Notice now that the criterion (24) indeed holds for the Lamé potentials with $n = 1$. In order to prove that, consider the Bloch functions associated to the corresponding Lamé equation (see [26], Section 23.7):

$$\begin{aligned} u^\beta(x) &= \frac{\sigma(x_0 + \omega')}{\sigma(x_0 + a + \omega')} \frac{\sigma(x + a + \omega')}{\sigma(x + \omega')} e^{-\zeta(a)(x-x_0)} \\ u^{1/\beta}(x) &= \frac{\sigma(x_0 + \omega')}{\sigma(x_0 - a + \omega')} \frac{\sigma(x - a + \omega')}{\sigma(x + \omega')} e^{\zeta(a)(x-x_0)} \end{aligned} \quad (28)$$

where x_0 is a fixed point in $[0, T = 2K)$ selected so that $u^\beta(x_0) = u^{1/\beta}(x_0) = 1$, $\beta = \exp[2a\zeta(\omega) - 2\omega\zeta(a)]$, and $\omega = K$, $\omega' = iK'$ are the real and imaginary half-periods of the Jacobi elliptic functions, σ and ζ are the non-elliptic Weierstrass functions, and the factorization energy α and a are related by

$$\alpha = \frac{2}{3}(m + 1) - \wp(a), \quad (29)$$

where \wp is the well known Weierstrass function [26]. Thus:

$$u^\beta(x)u^{1/\beta}(x + \delta) = \frac{\sigma^2(x_0 + \omega')}{\sigma(x_0 + a + \omega')\sigma(x_0 - a + \omega')} \frac{\sigma(x + a + \omega')\sigma(x - a + \delta + \omega')}{\sigma(x + \omega')\sigma(x + \delta + \omega')} e^{\delta\zeta(a)} \quad (30)$$

By taking $a = \delta$ we arrive at:

$$u^\beta(x)u^{1/\beta}(x + \delta) = \frac{\sigma^2(x_0 + \omega')e^{\delta\zeta(\delta)}}{\sigma(x_0 + \delta + \omega')\sigma(x_0 - \delta + \omega')} \quad (31)$$

where the right hand side does not depend on x , as was to be proved. It is not difficult to check that our criterion is not satisfied for the Lamé functions with $n > 1$ ([26], Section 23.7).

Let us remind that the former results permitted to induce $\delta = T/2$ [7, 8, 17]. This is now recovered for $\alpha = E_0$ and for the unique Bloch eigenfunction $u(x) = \psi_0(x)$ satisfying $\psi_0(x)\psi_0(x \pm T/2) = c$.

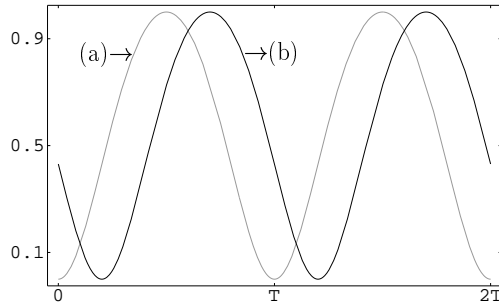

Figure 6: The translational effect of the 2-nd order Darboux transformation. (a) The initial Lamé potential with $n = 1$ and $m = 0.5$; (b) The 2-susy equivalent. The factorization energies $\alpha_1 = 1.1$, $\alpha_2 = 1.4$ belong to the first energy gap $(E_1, E_{1'})$, the displacement $\delta'' = 0.747 \neq T/2$. The final effect is very simple but it is not reducible to the nonsingular 1-st order steps.

The existence of the corresponding second order displacements in the upper spectral gap follows from the inverse spectral theorems. Indeed, if the transformation (4) involves

the Bloch functions (11,12), it does not change the spectrum of V_0 . As the shape of the Lamé potential with $n = 1$ is uniquely defined by its band structure (cf. the inverse scattering theorems [32,33,34], see also [22] p. 299, Theorem XIII.91.b), we infer that the non-singular Darboux transformation of Proposition 1 can cause no more but a coordinate displacement. Once again, the abstract argument can be supported by the explicit formulae. In fact, by superposing a pair of Darboux operations (3) with the complex transformation functions $u_i(x)$ given by (28), where $a = \delta_i$ are the complex displacements $\delta_1 = \delta + \omega'$, $\delta_2 = \delta' + \omega'$, one returns to the original Lamé potential displaced by $\delta'' = \delta + \delta'$ (Fig. 6). The corresponding second order transformation (4) has the real Wronskian:

$$W(u_1, u_2) = W_0 \frac{\sigma(x + \delta_1 + \delta_2 + \omega')}{\sigma(x + \omega')} e^{-[\zeta(\delta_1) + \zeta(\delta_2)](x - x_0)}, \quad (32)$$

where

$$W_0 = \frac{\sigma(\delta_2 - \delta_1)\sigma^2(x_0 + \omega')}{\sigma(\delta_1)\sigma(\delta_2)\sigma(x_0 + \delta_1 + \omega')\sigma(x_0 + \delta_2 + \omega')}. \quad (33)$$

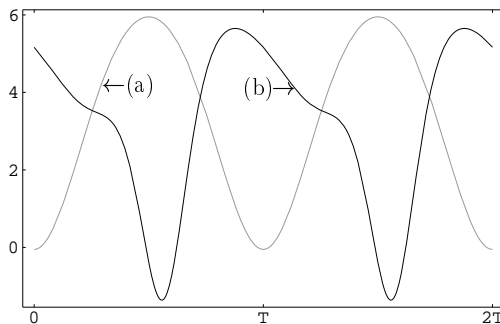

Figure 7: A non-trivial result of the periodicity preserving second order Darboux transformation. (a) The original Lamé potential with $n = 3$ and $m = 0.5$ (b) The Darboux deformed version. The factorization energies $\alpha_1 = 2.15$, $\alpha_2 = 4.05$ belong to the energy gap (E_1, E_1') . The global displacement affects the minima and maxima but simultaneously the potential is deformed.

To examine the limitations of the method we have applied the second order Darboux transformations [15, 29, 35, 36, 37, 38] to the case $n = 3$ (see Fig. 7). A simple comparison with previous results [17] shows that the effect is global but essentially new (one sees the displaced minima and maxima but also a non-trivial deformation). As it is already known, the first order Darboux transformations cannot displace the Lamé potentials with $n > 1$ (see [21]). The problem whether the same effect can be produced by higher order Darboux operations is still open (compare the discussion of Khare and Sukhatme [8] with Dunne and Feinberg [7]).

Once clarified the mechanism of the Darboux invariance, we have used the transformation functions in (3-4) defined as nontrivial linear combinations of the Bloch basis. Notice that the corresponding Darboux operations must affect the periodic structure, since on both extremes $x \rightarrow \pm\infty$ the transformation function reduces to two different Bloch functions, causing two opposite asymptotic displacements. On Fig.8 we show the periodicity defect and the injected localized state of the Lamé potential (23) with $n = 1$, due to the 1-st order transformation (3) with $\alpha < E_0$. The Fig.9, in turn, shows a defect of the same potential caused by the 2-nd order (irreducible) transformation (4), which has injected a

pair of localized states at the factorization constants $\alpha_1 = 1.2$, $\alpha_2 = 1.3$. In both cases, the effect *looks local* but it is not (in fact, it is enough to compare minima and maxima of the initial and transformed potentials). The resulting periodicity defects arise as if a detail of the lattice was crushed by two opposite supersymmetric displacements, creating a “Darboux model” for the contact effects.

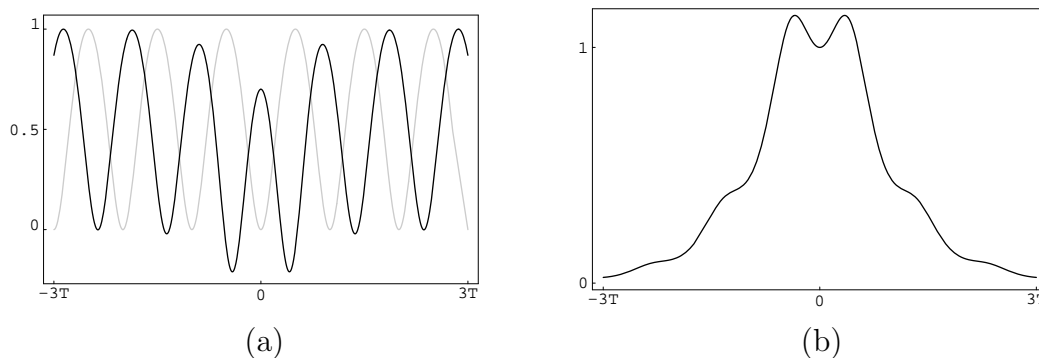

Figure 8: The result of the first order Darboux transformation applied to the Lamé potential with $n = 1$ and $m = 0.5$: (a) the supersymmetrically generated periodicity defect. Notice the asymptotic translational invariance; (b) the energy bound state for $\alpha = 0.35$ injected into the infinite forbidden band $(-\infty, E_0)$.

To summarize, let us underline again an intriguing role of the translational invariance, which can appear either as an exact or approximate and/or asymptotic effect. This is an exceptional situation when the most elementary symmetry transformation, the unitary but *nonlocal* finite displacements, can be implemented by Darboux transformations typically producing *local* but *non-unitary* effects, a phenomenon specially convenient for the exact description of the contact effects (tentatively, including tiny quantum wells [39]).

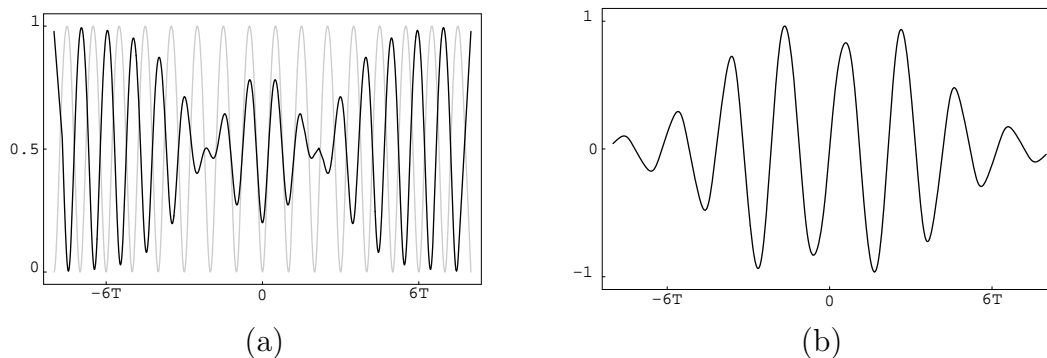

Figure 9: The result of the second order Darboux transformation (4) with the factorization constants $\alpha_1 = 1.2$, $\alpha_2 = 1.3$ applied to the Lamé potential with $n = 1$ and $m = 0.5$: (a) the supersymmetrically generated periodicity defect. Notice the asymptotic translational invariance; (b) one of the energy bound states for $\alpha_1 = 1.2$ injected into the forbidden band $(E_1, E_{1'})$.

Acknowledgements. The authors acknowledge the support of CONACYT project 32086E (México). BFS is grateful for the support of the Russian Foundation for Basic Research and for the kind hospitality at the Physics Department of CINVESTAV in the spring of 2001. ORO acknowledges the support of CINVESTAV, project JIRA'2001/17.

References

- [1] S. Pan, S. Feng, Phys. Rev. B 44 (1991) 5668
- [2] G. Monsivais, M. Moshinsky, J. Phys. A 32 (1999) 3637
- [3] M. Horne, I. Jex, A. Zeilinger, Phys. Rev. A 59 (1999) 2190
- [4] L.R. Kronig , W.G. Penney, Proc. R. Soc. A 130 (1931) 499
- [5] G. Bateman, A. Erdelyi, Higher Transcendental functions, V. 3, Mc Graw-Hill, New York, 1955
- [6] B.M. Levitan, Inverse Sturm-Liouville Problems, Nauka, Moscow, 1984
- [7] G. Dunne, J. Feinberg, Phys. Rev. D 57 (1998) 1271
- [8] A. Khare, U. Sukhatme, J. Math. Phys. 40 (1999) 5473
- [9] M.M. Crum, Quart. J. Math. 6 (1955) 121
- [10] C.V. Sukumar, J. Phys. A 19 (1986) 2297
- [11] A.A. Andrianov, M.V. Ioffe, F. Cannata, J.P. Dedonder, Int. J. Mod. Phys. A 10 (1995) 2683
- [12] G. Junker, Supersymmetric Methods in Quantum and Statistical Physics, Springer, Berlin, 1996
- [13] B.K. Bagchi, Supersymmetry in Quantum and Classical Mechanics, Chapman & Hall, New York, 2001
- [14] F. Cooper, A. Khare, U. Sukhatme, Supersymmetry in Quantum Mechanics, World Scientific, Singapore, 2001
- [15] B.F. Samsonov, Mod. Phys. Lett. A 11 (1996) 1563
- [16] M.G. Krein, DAN SSSR 113 (1957) 970
- [17] D.J. Fernández, J. Negro, L.M. Nieto, Phys. Lett. A 275 (2000) 338
- [18] H. Aoyama, M. Sato, T. Tanaka, M. Yamamoto, Phys. Lett. B 498 (2001) 117
- [19] L. Trlifaj, Inv. Prob. 5 (1989) 1145
- [20] J. Blinowski, private discussion. See also F. Bassani, Theory of impurity states, in Theory of Imperfect Crystalline Solids: Trieste Lectures 1970, Vienna, 1971

- [21] D.J. Fernández, B. Mielnik, O. Rosas-Ortiz, B.F. Samsonov, *Phys. Lett. A* 294, (2002) 168
- [22] M. Reed, B. Simon, *Methods of Modern Mathematical Physics IV*, Academic, New York, 1978
- [23] B. Mielnik, M.A. Reyes, *J. Phys. A* 29 (1996) 6009
- [24] F. Delgado, B. Mielnik, M.A. Reyes, *Phys. Lett. A* 237 (1998) 359
- [25] W. Magnus, S. Winkler, *Hill's Equation*, John Wiley & Sons, New York, 1966
- [26] E.T Whittaker, G.N. Watson, *A course of modern analysis*, Cambridge University Press, Cambridge, 1927
- [27] F.A. Berezin, M.A. Shubin, *The Schrödinger Equation*, Kluwer, Dordrecht, 1991
- [28] V.G. Bagrov, B.F. Samsonov, *Phys. Part. Nucl.* 28 (1997) 374
- [29] B.F. Samsonov, *Phys. Lett. A* 263 (1999) 274
- [30] V.B. Matveev, M.A. Salle, *Darboux transformations and solitons*, Springer, Berlin, 1991
- [31] B.F. Samsonov, *Eur. J. Phys.* 22 (2001) 305
- [32] H. Hochstadt, *Arch. Rat. Mech. Anal.* 19 (1965) 353
- [33] B.A. Dubrovin, V.B. Matveev, S.P. Novikov, *Russ. Math. Surv.* 31 (1976) 59
- [34] E.D. Belokolos, A.I Bobenko, V.Z. Enol'skii, A.R. Its, *Algebro-geometric approach to nonlinear integrable equations*, Springer-Verlag, Berlin (1994)
- [35] A. Stahlhofen, *Phys. Rev. A* 51 (1995) 934
- [36] D.J. Fernández, *Int. J. Mod. Phys. A* 12 (1997) 171
- [37] J.O. Rosas-Ortiz, *J. Phys. A* 31 (1998) 10163; *J. Phys. A* 31 (1998) L507
- [38] B. Bagchi, A. Ganguly, D. Bhaumik, A. Mitra, *Mod. Phys. Lett. A* 14 (1999) 27
- [39] P. Díaz-Arencibia, I. Hernández-Calderón, L.M. Hernández-Ramírez, M.C. Tamargo, *J. Vac. Sci. Tech. B* 18 (2000) 1526