

# Quantization and renormalization of the manifest left-right symmetric model of electroweak interactions.

P. Duka<sup>1</sup>, J. Gluza<sup>1,2</sup> and M. Zrałek<sup>1</sup>.

<sup>1</sup> Department of Field Theory and Particle Physics  
Institute of Physics, University of Silesia  
Uniwersytecka 4, PL-40-007 Katowice, Poland

<sup>2</sup> DESY Zeuthen, Platanenalle 6, 15738 Zeuthen, Germany

## Abstract

Quantization and renormalization of the left-right symmetric model is the main purpose of the paper. First the model at tree level with a Higgs sector containing one bidoublet and two triplets is precisely discussed. Then the canonical quantization and Faddeev-Popov Lagrangian are carried out ('t Hooft gauge). The BRST symmetry is discussed. Subsequently the on mass shell renormalization is performed and, as a test of consistency, the renormalization of the  $ZN_iN_j$  vertex is analyzed.

# I Introduction.

The Standard Model (SM) agrees with all ever done experiments on both classical and quantum levels [1]. Any announcement of detection of a new, non-standard signal has, sooner or later, died out. For instance, world-wide discussed discrepancies at LEP have disappeared when more data have been collected and analyzed [2]. However, recent Superkamiokande (SK) atmospheric observations [3] show (indirectly) strong evidence for neutrino mass. This has been recognized as a first positive sign of physics beyond the orthodox SM. Nonzero neutrino masses are quite natural in the electroweak theory. With the known left-handed neutrinos and the standard Higgs doublet massive neutrinos appear from higher dimension operators acting at the Planck scale [4]. However, expected effects of quantum gravity in SM induce Majorana masses, few order of magnitudes smaller than we need to explain SK data [5]. In these circumstances right-handed neutrinos seem to be inevitable in the theory and open the route to higher unification e.g. via left-right symmetric gauge groups [5,6]. Whether such models are responsible for the SK signal is still an open question. Putting aside the problem of neutrino masses, left right models have many other interesting and nonstandard features. Actually, the theoretical concept of the left-right symmetry in physics at very high energies has already been invented almost 25 years ago simultaneously with the idea of GUT models [6,7].

The smallest gauge group which implements the hypothesis of left-right symmetry of weak interactions is

$$SU(2)_L \otimes SU(2)_R \otimes U(1)_{B-L}. \quad (1)$$

This gauge group can be understood as a second step (after the SM) in unifying fundamental interactions and unravels several puzzles of the SM.

First of all it restores quark-lepton symmetry. In the SM both left-handed neutrinos and charged leptons of the same flavour are elements of the same object with respect to the  $SU(2)$  gauge group. The same happens with left-handed up and down quarks. However, right-handed fields i.e. quarks and leptons are not treated in the same way: they are singlet fields with respect to the  $SU(2)$  gauge group. In the left-right symmetric models both left-handed and right-handed fields are treated in the same way - they form doublets under  $SU(2)$  left- and  $SU(2)$  right- gauge groups. Moreover, violation of the space inversion symmetry is not an ad hoc assumption but follows from vacuum structure of the theory. At high energy parity is conserved, but at some energy scale  $v_R$  (connected with the masses of heavy gauge bosons) the space inversion symmetry is broken spontaneously. Observed near maximal parity violation at low energies is explained by the large difference between masses of heavy and light gauge bosons. The suppression of the right-handed charged currents (not visible up to now) is linked with the high-low (left-right) energy gap, too.

Phenomena mentioned above are generic to the left-right symmetric unified models. There are also other important features of the model which appear naturally and are able to solve some unanswered SM's problems. Among them the following issues can be specified:

- i) Small masses of light neutrinos.

In the conventional version of the L-R model [8] we have three light and three heavy (presumably Majorana) neutrinos. Small masses of known neutrinos can be explained via so-called seesaw mechanism [9].

ii) Physical interpretation of the  $U(1)$  generator as the B-L quantum number [10]

The SM has an anomaly free global B-L symmetry. The right-handed neutrinos create the B-L symmetry to be local and anomaly free. Such a symmetry is gaugeable which makes it possible to replace the arbitrary weak hypercharge  $Y$  of the SM by better known and invented earlier B(aryon) and L(epton) numbers. Then the electric charges of particles are connected with known quantities, eigenvalues of the left ( $T_{3L}$ ) and right ( $T_{3R}$ ) generators of the  $SU_L(2)$  and  $SU_R(2)$  groups, respectively in the way:

$$Q = T_{3L} + T_{3R} + \frac{B - L}{2}. \quad (2)$$

iii) Charge quantization [11],

If neutrinos are Majorana particles (Dirac neutrinos are not so natural) then the B-L number is violated and the requirement that the theory must be anomaly free (which is necessary for renormalizability) leads to charge quantization.

iv) Understanding of the smallness of CP violation in the quark sector [12].

In some versions of the L-R models phases responsible for CP violation are connected with the right-handed quark sector. Then the smallness of the CP effect is related directly to the suppression of the V+A current: the bigger  $M_{W_2}$ , the smaller CP violation.

v) Solution of the strong CP problem [13].

As it was mentioned above mirror symmetry is an exact symmetry in the L-R models before spontaneous breakdown. Then the strong CP parameter  $\Theta$  changes under parity to  $-\Theta$ , thus in the L-R models  $\Theta = 0$  naturally. Small, finite contributions to  $\Theta$  arise at two loop level.

Not all puzzles of the SM are solved. Some of them still remain. The large number of parameters (masses and mixing angles) and the fine-tuning problems (the naturality problem and the cosmological constant problem) wait for disentanglement. Supersymmetric version of the model finds the answer to some questions (e.g. naturalness problem) but still more of them wait for an explanation. We may only hope that all these doubts will be explained in the future.

Plenty of different L-R symmetric models based on the gauge group Eq. (1) have appeared in the literature [14]. They have usually been used to find out new phenomenological phenomena connected with

- extra gauge bosons at lepton [15–17] and hadron colliders [17–19];
- heavy neutrinos at  $e^+e^-$  [16,19–22],  $e^-\gamma$  [22] and hadron colliders [23];
- doubly [24,25], singly charged [24,26,27] and neutral [24,27,28] Higgs particles;
- lepton number violating processes at both high [29] and low energies [30];

- CP effects in Higgs [31], lepton [32] and quark [12], [33] sectors;
- electromagnetic properties [34] and nature [35] of neutrinos;
- flavour changing neutral processes (FCNC) [36];
- Kaon [37,38] and B [39] physics.

We are aware of only few papers where radiative corrections to the LR model have been used [40,41]. Typical non standard one loop diagrams have been used very rarely (finite box diagrams) [38]. Wherever needed, only the SM virtual corrections have been considered [37,42]. Such a (misleading) procedure has been justified by the argument that corrections to small non standard tree level diagrams are negligible (see for contrary arguments in [43,44]). However, the experimental results (for example from LEP I and II) are getting better and better. We also do not know the role of the Higgs sector in the case of strongly broken ‘custodial’ symmetry. Moreover, it was found [40] that in left-right models heavy boson scalars do not decouple in low-energy phenomena. In such circumstances a natural question arises whether non standard corrections are really negligible. To answer that question it is necessary to calculate them. To make it properly the model has to be renormalized (see [43] for another renormalization approach to the LR model).

Since 1971 we know [45] how to build a renormalizable gauge field theory. The L-R gauge model satisfies all its requirements so it is a renormalizable model. Although theoretically understood, the problem is how to make it in practice, especially when much more new quantities in comparison to the SM must be worked out. The problem is not only with the larger number of Feynman diagrams which have to be added for each quantity. New important renormalization constants such as new heavy gauge and Higgs fields appear. There are also two new mixing angles between charged and neutral gauge bosons. Mixing matrices in quark [46] and lepton [47] sectors have to be renormalized. Neutrinos are Majorana particles so little more complicated techniques have to be applied [48].

At the beginning of the development of the L-R models the breaking of the gauge symmetry was implemented by choosing two Higgs doublets  $\chi_L(2,0,2)$  and  $\chi_R(0,2,2)$  and the bidoublet  $\phi(2,2,0)$  [49]. Later on it was realized that choosing, instead of two doublets, two Higgs triplets  $\Delta_L(3,1,2)$  and  $\Delta_R(1,3,2)$  the smallness of neutrino masses may be connected with the large scale of right-handed symmetry breaking [50,51]. For many different purposes also other Higgs sectors were considered. It made it possible to understand a small mass for neutrinos by radiative corrections, to have see-saw mechanism for Dirac neutrinos, or to eliminate the FCNC in quark interaction. There were introduced Higgs sectors with (i) bidoublet, doublets and triplets [52], (ii) doublets and triplets [53], (iii) doublets and singlets [54]. We will focus here on the model where two triplets and bidoublet form the Higgs sector and where P symmetry prior to symmetry breakdown is assumed (for models without explicit P symmetry, see e.g. [55,56]). This is a realization of the so called Manifest (or quasi-manifest) L-R symmetric model where the gauge couplings  $g_L$  and  $g_R$  of the  $SU(2)_L$  and  $SU(2)_R$  subgroups, respectively, are equal [57–59] and Yukawa couplings form hermitian matrices [60].

At the tree level this minimal (manifest or quasi-manifest) L-R symmetric model has been analyzed extensively from both theoretical [61] and phenomenological point of views [42], [62], [63].

In order to be consistent with observed phenomena, the symmetry breaking pattern in our model should satisfy inequalities:  $v_R \gg \sqrt{\kappa_1^2 + \kappa_2^2} \gg v_L$  where  $v_R, \kappa_1, \kappa_2, v_L$  are the VEVs of appropriate fields (see Chapter 1). To avoid fine-tuning problems with the model parameters it was shown that  $v_L = 0$  should be imposed [51,64]. In what follows we also require vanishing of VEV for the left-handed neutral triplet field,  $\langle \Delta_L \rangle_0 = 0$ . The most general form of the L-R symmetric Yukawa potential is worked out, however, with one assumption that there is no hard CP violation in the Higgs sector [51].

In the next Chapter we describe in full details the model at the tree level. First, the Lagrangian in the weak basis before diagonalization is discussed. Then the Higgs potential is described. The fermion and boson mass matrices are diagonalized, the L-R model Lagrangian in the physical basis and CP symmetry are considered. Presented couplings among the physical fields are very convenient in practical model applications. In Chapter 3 the procedure of the L-R model quantization is presented. The linear gauge fixing terms are introduced (the 'tHooft gauge). The Goldstone bosons and the Faddeev-Popov ghosts are defined. Next BRST transformations for all physical and unphysical fields are introduced and afterwards the Faddeev-Popov ghost Lagrangian is given. In Chapter 4 the renormalization procedure is presented. All renormalization constants for the fields, masses, mixing parameters are defined. The renormalization of the charged and neutral current mixing matrices is described. Finally in Chapter 5, to check the consistency of the procedures the renormalization of the  $Z_1 N_i N_j$  vertex is performed. At the beginning the general scheme and calculations of necessary renormalization constants are presented. Then, the cancellation of the infinite part of the  $Z_1 N_i N_j$  vertex is analyzed.

## II Model at the tree level.

We write down below the full Lagrangian at the tree level which we use in the paper. First we present the Lagrangian in a weak unphysical base. Then, after mass matrices diagonalization, the Lagrangian in the physical base is given.

### 2.1 STRUCTURE OF THE LAGRANGIAN OF THE THEORY.

#### 2.1.1 Fermion and gauge fields.

In the  $SU(2)_L \otimes SU(2)_R \otimes U(1)_{B-L}$  gauge model quarks (Q) and leptons (L) are placed in doublets [61]

$$L_{iL} = \begin{pmatrix} \nu'_i \\ l'_i \end{pmatrix}_L : (2, 1, -1), \quad L_{iR} = \begin{pmatrix} \nu'_i \\ l'_i \end{pmatrix}_R : (1, 2, -1), \quad (3)$$

$$Q_{iL} = \begin{pmatrix} u'_i \\ d'_i \end{pmatrix}_L : (2, 1, 1/3), \quad Q_{iR} = \begin{pmatrix} u'_i \\ d'_i \end{pmatrix}_R : (1, 2, 1/3). \quad (4)$$

$i=1,2,3$  runs over number of generations. The numbers  $(d_L, d_R, Y)$  in parenthesis characterize the  $SU(2)_L, SU(2)_R$  and  $U(1)_{B-L}$  representation.  $d_{L,R}$  denote dimensions of the  $SU(2)_L$  and  $SU(2)_R$  representation,  $Y = B - L$ . The

quantum numbers for  $U(1)_{B-L}$  gauge group are connected with charges of the particles by Eq.(2). The fermion fields (Eq. (3) and (4)) have the following gauge transformations ( $\Psi_{L,R} = (Q, L)_{L,R}$ )

$$\begin{aligned}\Psi'_L &= \left[ e^{-ig' \frac{Y}{2} \Theta(x)} e^{-ig_L \frac{\vec{\Theta}}{2}(x)} \right] \Psi_L, \\ \Psi'_R &= \left[ e^{-ig' \frac{Y}{2} \Theta(x)} e^{-ig_R \frac{\vec{\Theta}}{2}(x)} \right] \Psi_R.\end{aligned}\quad (5)$$

Gauge invariance is achieved when 7 gauge fields  $(\vec{W}_{L,R})_\mu, B_\mu$  are introduced. Then, appropriate covariant derivatives for  $\Psi_{L,R}$  fields are

$$\begin{aligned}D_\mu \Psi_L &= \left( \partial_\mu - ig_L \frac{\vec{\tau}}{2} \vec{W}_{L\mu} - ig' \frac{Y}{2} B_\mu \right) \Psi_L, \\ D_\mu \Psi_R &= \left( \partial_\mu - ig_R \frac{\vec{\tau}}{2} \vec{W}_{R\mu} - ig' \frac{Y}{2} B_\mu \right) \Psi_R,\end{aligned}\quad (6)$$

with the following gauge fields transformations

$$\begin{aligned}\left( \frac{\vec{\tau}}{2} \vec{W}_{L,R} \right)'_\mu &= e^{-ig_{L,R} \frac{\vec{\tau}}{2} \Theta_{L,R}(x)} \left( \frac{\vec{\tau}}{2} \vec{W}_{L,R} \right)_\mu e^{ig_{L,R} \frac{\vec{\tau}}{2} \Theta_{L,R}(x)} \\ &\quad - \frac{1}{ig_{L,R}} e^{-ig_{L,R} \frac{\vec{\tau}}{2} \Theta_{L,R}(x)} \partial_\mu \left( e^{ig_{L,R} \frac{\vec{\tau}}{2} \Theta_{L,R}(x)} \right),\end{aligned}\quad (7)$$

$$B'_\mu = B_\mu - \frac{1}{ig} e^{-ig' \frac{Y}{2} \Theta(x)} \partial_\mu \left( e^{ig' \frac{Y}{2} \Theta(x)} \right).\quad (8)$$

We start with the three different couplings  $g_L, g_R$  and  $g'$ . Transformations defined in Eqs. (5-8) allow consistently to build up two kinds of invariant interactions. The first one gives the fermion-gauge interaction

$$L_f = \sum_{\Psi=(Q),(L)} \bar{\Psi}_L \gamma^\mu \left( i\partial_\mu + g_L \frac{\vec{\tau}}{2} \vec{W}_{L\mu} + g' \frac{Y}{2} B_\mu \right) \Psi_L + (L \rightarrow R).\quad (9)$$

The second gives the gauge-gauge one

$$L_g = -\frac{1}{4} W_{Li}^{\mu\nu} W_{L\mu\nu} - \frac{1}{4} W_{Ri}^{\mu\nu} W_{R\mu\nu} - \frac{1}{4} B^{\mu\nu} B_{\mu\nu},\quad (10)$$

where

$$\begin{aligned}W_{1L,R}^{\mu\nu} &= \partial^\mu W_{1L,R}^\nu - \partial^\nu W_{1L,R}^\mu + g_{L,R} (W_{2L,R}^\mu W_{3L,R}^\nu - W_{3L,R}^\mu W_{2L,R}^\nu), \\ W_{2L,R}^{\mu\nu} &= \partial^\mu W_{2L,R}^\nu - \partial^\nu W_{2L,R}^\mu + g_{L,R} (W_{3L,R}^\mu W_{1L,R}^\nu - W_{1L,R}^\mu W_{3L,R}^\nu), \\ W_{3L,R}^{\mu\nu} &= \partial^\mu W_{3L,R}^\nu - \partial^\nu W_{3L,R}^\mu + g_{L,R} (W_{1L,R}^\mu W_{2L,R}^\nu - W_{2L,R}^\mu W_{1L,R}^\nu), \\ B^{\mu\nu} &= \partial^\mu B^\nu - \partial^\nu B^\mu.\end{aligned}\quad (11)$$

Until now fermion and gauge fields are massless - mass terms which could appear are not gauge invariant. To make them massive we have to introduce scalar fields - Higgs particles and apply the spontaneous symmetry breaking mechanism.

### 2.1.2 Higgs sector of the theory.

In order to produce fermion mass matrices we need to introduce only one Higgs multiplet - the so called bidoublet [58] (again, as in the fermion case, in parenthesis quantum numbers  $(d_L, d_R, B - L)$  are given)

$$\phi = \begin{pmatrix} \phi_1^0 & \phi_1^+ \\ \phi_2^- & \phi_2^0 \end{pmatrix} : (2, 2, 0), \quad (12)$$

with gauge transformation

$$\phi' = e^{-ig_L \frac{\vec{x}}{2} \vec{\Theta}(x)} \phi e^{ig_R \frac{\vec{x}}{2} \vec{\Theta}(x)}. \quad (13)$$

Consequently the most general Yukawa Lagrangian is given by

$$L_Y = - \sum_{i,j} \bar{L}_{iL} \left( (h_l)_{ij} \phi + (\tilde{h}_l)_{ij} \tilde{\phi} \right) L_{jR} - \sum_{i,j} \bar{Q}_{iL} \left( (h_q)_{ij} \phi + (\tilde{h}_q)_{ij} \tilde{\phi} \right) Q_{jR} + h.c., \quad (14)$$

where

$$\tilde{\phi} = \tau_2 \phi^* \tau_2 = \begin{pmatrix} \phi_2^{0*} & -\phi_2^+ \\ -\phi_1^- & \phi_1^{0*} \end{pmatrix} \quad (15)$$

is also the object with quantum numbers  $(2, 2, 0)$ . However, bidoublet  $\phi$  is not sufficient for breaking  $SU(2)_L \otimes SU(2)_R \otimes U(1)_{B-L}$  to the  $U(1)_{em}$ , the only symmetry which remains. There are many other possible ways to break the symmetry [65]. Among them the most popular ones are models with Higgs triplets  $(\Delta_L \sim (3, 1, 2), \Delta_R \sim (1, 3, 2))$  in addition to the bidoublet [58]

$$\Delta_{L,R} = \begin{pmatrix} \delta_{L,R}^+ / \sqrt{2} & \delta_{L,R}^{++} \\ \delta_{L,R}^0 & -\delta_{L,R}^+ / \sqrt{2} \end{pmatrix}. \quad (16)$$

The gauge transformations for the triplets fields are the following

$$\Delta'_{L,R} = e^{-ig' \frac{\vec{y}}{2} \Theta(x)} e^{-ig_{L,R} \frac{\vec{x}}{2} \vec{\Theta}(x)} \Delta_{L,R} e^{ig_{L,R} \frac{\vec{x}}{2} \vec{\Theta}(x)}. \quad (17)$$

Now we can build the kinetic part of the Higgs bosons Lagrangian

$$L_{Higgs}^{kin} = Tr \left[ (D_\mu \Delta_L)^\dagger (D^\mu \Delta_L) \right] + Tr \left[ (D_\mu \Delta_R)^\dagger (D^\mu \Delta_R) \right] + Tr \left[ (D_\mu \phi)^\dagger (D^\mu \phi) \right], \quad (18)$$

where

$$\begin{aligned} D_\mu \phi &= \partial_\mu \phi - ig_L \vec{W}_{L\mu} \frac{\vec{\tau}}{2} \phi + ig_R \phi \frac{\vec{\tau}}{2} \vec{W}_{R\mu}, \\ D_\mu \Delta_{L,R} &= \partial_\mu \Delta_{L,R} - ig_{L,R} \left[ \frac{\vec{\tau}}{2} \vec{W}_{L,R\mu}, \Delta_{L,R} \right] - ig' B_\mu \Delta_{L,R}. \end{aligned} \quad (19)$$

In L-R symmetric models every L field has an R counterpart. This allows the definition of the space inversion symmetry  $(Px = (t, -\vec{x}), \varepsilon(\mu) = 1 \text{ for } \mu = 0 \text{ and } -1 \text{ for } \mu = 1, 2, 3)$ ;

$$\psi_{L,R}(x) \rightarrow \psi_{R,L}(Px), \quad (20)$$

$$\vec{W}_{L,R}^\mu(x) \rightarrow \varepsilon(\mu)\vec{W}_{R,L}^\mu(Px), \quad (21)$$

$$B^\mu(x) \rightarrow \varepsilon(\mu)B^\mu(Px), \quad (22)$$

and

$$\Delta_{L,R}(x) \rightarrow \Delta_{R,L}(Px), \quad (23)$$

$$\phi(x) \rightarrow \phi^\dagger(Px). \quad (24)$$

From now on, we will consider a model which is symmetric under the above parity transformation (Eq.(20 - 24)). The parts of the Lagrangian density which we have already discussed ( Eqs. (9), (10), (14), (18)) have the P symmetry if  $g_L = g_R \equiv g$ ,  $h_{l,q} = h_{l,q}^\dagger$ ,  $\tilde{h}_{l,q} = \tilde{h}_{l,q}^\dagger$ .

### 2.1.3 The Higgs potential.

In order to break the left-right symmetry to the final  $U(1)_{em}$  the Higgs potential is introduced. The most general potential for one bidoublet  $\phi$  (12) and two triplets  $\Delta_{L,R}$  (16) which have the left-right symmetry (Eq.(23 - 24)) was introduced in [51]

$$\begin{aligned} V(\phi, \Delta_L, \Delta_R) = & -\mu_1^2 (Tr [\phi^\dagger \phi]) - \mu_2^2 (Tr [\tilde{\phi} \phi^\dagger] + Tr [\tilde{\phi}^\dagger \phi]) - \mu_3^2 (Tr [\Delta_L \Delta_L^\dagger] + Tr [\Delta_R \Delta_R^\dagger]) \\ & + \lambda_1 ((Tr [\phi \phi^\dagger])^2) + \lambda_2 ((Tr [\tilde{\phi} \phi^\dagger])^2 + (Tr [\tilde{\phi}^\dagger \phi])^2) + \lambda_3 (Tr [\tilde{\phi} \phi^\dagger] Tr [\tilde{\phi}^\dagger \phi]) \\ & + \lambda_4 (Tr [\phi \phi^\dagger] (Tr [\tilde{\phi} \phi^\dagger] + Tr [\tilde{\phi}^\dagger \phi])) + \rho_1 ((Tr [\Delta_L \Delta_L^\dagger])^2 + (Tr [\Delta_R \Delta_R^\dagger])^2) \\ & + \rho_2 (Tr [\Delta_L \Delta_L] Tr [\Delta_L^\dagger \Delta_L^\dagger] + Tr [\Delta_R \Delta_R] Tr [\Delta_R^\dagger \Delta_R^\dagger]) + \rho_3 (Tr [\Delta_L \Delta_L^\dagger] Tr [\Delta_R \Delta_R^\dagger]) \\ & + \rho_4 (Tr [\Delta_L \Delta_L] Tr [\Delta_R^\dagger \Delta_R^\dagger] + Tr [\Delta_L^\dagger \Delta_L^\dagger] Tr [\Delta_R \Delta_R]) \\ & + \alpha_1 (Tr [\phi \phi^\dagger] (Tr [\Delta_L \Delta_L^\dagger] + Tr [\Delta_R \Delta_R^\dagger])) + \alpha_2 (Tr [\phi \tilde{\phi}^\dagger] Tr [\Delta_R \Delta_R^\dagger] + Tr [\phi^\dagger \tilde{\phi}] Tr [\Delta_L \Delta_L^\dagger]) \\ & + \alpha_2^* (Tr [\phi^\dagger \tilde{\phi}] Tr [\Delta_R \Delta_R^\dagger] + Tr [\tilde{\phi}^\dagger \phi] Tr [\Delta_L \Delta_L^\dagger]) + \alpha_3 (Tr [\phi \phi^\dagger \Delta_L \Delta_L^\dagger] + Tr [\phi^\dagger \phi \Delta_R \Delta_R^\dagger]) \\ & + \beta_1 (Tr [\phi \Delta_R \phi^\dagger \Delta_L^\dagger] + Tr [\phi^\dagger \Delta_L \phi \Delta_R^\dagger]) + \beta_2 (Tr [\tilde{\phi} \Delta_R \phi^\dagger \Delta_L^\dagger] + Tr [\tilde{\phi}^\dagger \Delta_L \phi \Delta_R^\dagger]) \\ & + \beta_3 (Tr [\phi \Delta_R \tilde{\phi}^\dagger \Delta_L^\dagger] + Tr [\phi^\dagger \Delta_L \tilde{\phi} \Delta_R^\dagger]). \end{aligned} \quad (25)$$

From the parity transformation (Eq.(20 - 24)) it follows also that all terms in the potential are self-conjugate except the  $\alpha_2$  terms. This means that all parameters  $\mu_i$ ,  $\lambda_i$ ,  $\rho_i$  and  $\beta_i$  are real. Only  $\alpha_2$  can be complex. To avoid the explicit CP symmetry breaking in the Higgs sector also  $\alpha_2$  is taken to be real ( ref. [51]). The neutral Higgs fields  $\phi_1^0$ ,  $\phi_2^0$ ,  $\delta_L^0$  and  $\delta_R^0$  acquire VEV for which the potential Eq.(25) has minimum

$$\langle \phi \rangle = \begin{pmatrix} \kappa_1/\sqrt{2} & 0 \\ 0 & \kappa_2/\sqrt{2} \end{pmatrix}, \quad \langle \Delta_{L,R} \rangle = \begin{pmatrix} 0 & 0 \\ v_{L,R}/\sqrt{2} & 0 \end{pmatrix}. \quad (26)$$



The VEV's for  $\phi_{1,2}^0, \delta_{L,R}^0$  can be complex, but the freedom of gauge symmetry transformation gives a chance to make two of them real. Usually  $v_R$  and  $\kappa_1$  are taken to be real and  $v_L$  and  $\kappa_2$  remain complex

$$v_L = |v_L|e^{i\Theta_L}, \quad \kappa_2 = |\kappa_2|e^{i\Theta_2}. \quad (27)$$

There are six minimization conditions

$$\frac{\partial V}{\partial v_R} = \frac{\partial V}{\partial \kappa_1} = \frac{\partial V}{\partial |v_L|} = \frac{\partial V}{\partial \Theta_L} = \frac{\partial V}{\partial |\kappa_2|} = \frac{\partial V}{\partial \Theta_2} = 0 \quad (28)$$

which connect the VEV's with the Higgs potential parameters. From equation (28) it follows that in order to avoid fine-tuning and to satisfy the phenomenological requirements, the  $\Theta_2$  phase,  $|v_L|$  and  $\beta_i$  parameters in the potential must vanish [51]

$$\Theta_2 = v_L = \beta_1 = \beta_2 = \beta_3 = 0. \quad (29)$$

In what follows we consider the Higgs potential in the form given by Eq.(25) with  $\beta_1 = \beta_2 = \beta_3 = 0$  without explicit CP symmetry breaking ( $\alpha_2 = \alpha_2^*$ ) where spontaneous CP symmetry breaking also does not appear ( $\Theta_2 = |v_L| = 0$ ). After SSB when  $\phi$  acquires VEV (Eq.(26)), the full gauge symmetry Eq.(1) is broken to  $U(1)_Q \otimes U(1)_{B-L}$ . The one  $U(1)_{B-L}$  group follows from the  $B-L=0$  attribution for  $\phi$ , ( $(B-L) \langle \phi \rangle = 0$ ). The other  $U(1)_Q$  follows from the remaining gauge symmetry given by the charge operator  $\hat{Q}$

$$\hat{Q} \langle \phi \rangle = \left[ \frac{1}{2} \tau_3, \langle \phi \rangle \right] = 0. \quad (30)$$

Next from SSB for right-handed triplet it follows that

$$U(1)_Q \otimes U(1)_{B-L} \xrightarrow{\Delta_R \rightarrow \langle \Delta_R \rangle} U(1)_Q, \quad (31)$$

which is possible to see from

$$(B-L) \langle \Delta_R \rangle = 2 \langle \Delta_R \rangle \neq 0, \quad (32)$$

and

$$\hat{Q} \langle \Delta_R \rangle = \left[ \frac{1}{2} \tau_3, \langle \Delta_R \rangle \right] + \frac{B-L}{2} \langle \Delta_R \rangle = 0. \quad (33)$$

It is worth to stress that the SSB for bidoublet  $\phi$  and right - handed triplet  $\Delta_R$  is sufficient to get the correct final gauge group  $U(1)_Q \equiv U(1)_{em}$ . The left - handed triplet  $\Delta_L$  does not have to be spontaneously broken ( $v_L = 0$ ).

## 2.2 LAGRANGIAN IN THE PHYSICAL BASIS.

In the previous section we have introduced the full Lagrangian with scalar, fermion and gauge fields. Now we will find transformations of these fields to physical basis.

### 2.2.1 The physical fields.

We consider the diagonalization of the mass matrices separately for gauge bosons, for fermions and for Higgs particles. The CP symmetry can be broken only in the fermion sector. Some comments about it are also given.

#### 2.2.1.1 Gauge bosons.

After SSB (Eq.(26)) charged and neutral gauge bosons mass matrices  $\tilde{M}_W^2$  and  $\tilde{M}_0^2$  are obtained from  $L_{Higgs}^{kin}$  (Eq.(18)). In the  $W_{L,R}^{\mu\pm} = \frac{1}{\sqrt{2}}(W_{L,R}^{1\mu} \mp iW_{L,R}^{2\mu})$  and  $(W_{3L}^\mu, W_{3R}^\mu, B^\mu)$  basis we have

$$L_M = (W_L^{+\mu}, W_R^{+\mu}) \tilde{M}_W^2 \begin{pmatrix} W_{L\mu}^- \\ W_{R\mu}^- \end{pmatrix} + h.c. + \frac{1}{2} (W_{3L}^\mu, W_{3R}^\mu, B^\mu) \tilde{M}_0^2 \begin{pmatrix} W_{3L\mu} \\ W_{3R\mu} \\ B_\mu \end{pmatrix}, \quad (34)$$

$$\tilde{M}_W^2 = \frac{g^2}{4} \begin{pmatrix} \kappa_+^2 & -2\kappa_1\kappa_2 \\ -2\kappa_1\kappa_2 & \kappa_+^2 + 2v_R^2 \end{pmatrix}, \quad (35)$$

and

$$\tilde{M}_0^2 = \frac{1}{2} \begin{pmatrix} \frac{g^2}{2}\kappa_+^2 & -\frac{g^2}{2}\kappa_+^2 & 0 \\ -\frac{g^2}{2}\kappa_+^2 & \frac{g^2}{2}(\kappa_+^2 + 4v_R^2) & -2gg'v_R^2 \\ 0 & -2gg'v_R^2 & 2g'^2v_R^2 \end{pmatrix}, \quad (36)$$

where  $\kappa_+ = \sqrt{\kappa_1^2 + \kappa_2^2}$ .

The symmetric mass matrices are diagonalized by the orthogonal transformations

$$\begin{pmatrix} W_L^\pm \\ W_R^\pm \end{pmatrix} = \begin{pmatrix} \cos\xi & \sin\xi \\ -\sin\xi & \cos\xi \end{pmatrix} = \begin{pmatrix} W_1^\pm \\ W_2^\pm \end{pmatrix}, \quad (37)$$

and

$$\begin{pmatrix} W_{3L} \\ W_{3R} \\ B \end{pmatrix} = \begin{pmatrix} c_W c & c_W s & s_W \\ -s_W s_M c - c_M s & -s_W s_M s + c_M c & c_W s_M \\ -s_W c_M c + s_M s & -s_W c_M s - s_M c & c_W c_M \end{pmatrix} \begin{pmatrix} Z_1 \\ Z_2 \\ A \end{pmatrix} \equiv \begin{pmatrix} x_1 & x_2 & x_3 \\ y_1 & y_2 & y_3 \\ v_1 & v_2 & v_3 \end{pmatrix} \begin{pmatrix} Z_1 \\ Z_2 \\ A \end{pmatrix}, \quad (38)$$

where

$$g = \frac{e}{\sin\Theta_W}, \quad g' = \frac{e}{\sqrt{\cos 2\Theta_W}}, \quad c_W = \cos\Theta_W, \quad s_W = \sin\Theta_W, \\ c_M = \frac{\sqrt{\cos 2\Theta_W}}{\cos\Theta_W}, \quad s_M = \tan\Theta_W, \quad s = \sin\phi, \quad c = \cos\phi.$$

From the relations above it is easy to see that  $x_3$  and  $y_3$  in the matrix Eq.(38) are equal, i.e.  $x_3 = y_3$ .

Masses of the physical gauge bosons are the following

$$M_{W_{1,2}}^2 = \frac{g^2}{4} \left[ \kappa_+^2 + v_R^2 \mp \sqrt{v_R^4 + 4\kappa_1^2\kappa_2^2} \right], \quad (39)$$

$$M_{Z_{1,2}}^2 = \frac{1}{4} \left\{ [g^2\kappa_+^2 + 2v_R^2(g^2 + g'^2)] \mp \sqrt{[g^2\kappa_+^2 + 2v_R^2(g^2 + g'^2)]^2 - 4g^2(g^2 + 2g'^2)\kappa_+^2 v_R^2} \right\}. \quad (40)$$

The mixing angles are given by

$$\tan 2\xi = -\frac{2\kappa_1\kappa_2}{v_R^2}, \quad \sin 2\phi = -\frac{g^2\kappa_+^2\sqrt{\cos 2\Theta_W}}{2\cos^2\Theta_W(M_{Z_2}^2 - M_{Z_1}^2)}. \quad (41)$$

Experimental data gives bounds on the additional gauge boson masses  $M_{W_2}$ ,  $M_{Z_2}$  and the  $\rho = \frac{M_{W_1}^2}{M_{Z_1}^2 \cos^2\Theta_W}$  parameter which are satisfied only if  $v_R \gg \kappa_+$ . In this approximation there is (to the first order in  $\frac{\kappa_+}{v_R}$  and  $\frac{\sqrt{\kappa_1\kappa_2}}{v_R}$ )

$$\begin{aligned} M_{W_1}^2 &\simeq \frac{g^2}{4}\kappa_+^2 \left( 1 - \frac{(\kappa_1\kappa_2)^2}{\kappa_+^2 v_R^2} \right), \quad M_{W_2}^2 \simeq \frac{g^2 v_R^2}{2}, \\ M_{Z_1}^2 &\simeq \frac{g^2 \kappa_+^2}{4 \cos^2 \Theta_W} \left( 1 - \frac{\cos^2 2\Theta_W \kappa_+^2}{2 \cos^4 \Theta_W v_R^2} \right), \quad M_{Z_2}^2 \simeq \frac{v_R^2 g^2 \cos^2 \Theta_W}{\cos 2\Theta_W}, \quad \sin 2\phi \simeq -\frac{\kappa_+^2 (\cos 2\Theta_W)^{\frac{3}{2}}}{2v_R^2 \cos^4 \Theta_W}. \end{aligned} \quad (42)$$

### 2.2.1.2 Fermions.

**a. Quarks.** The most general Yukawa interaction for quarks is given by Eq.(14). After SSB the mass Lagrangian is

$$L_{mass}^q = -\bar{U}'_L M_u U'_R - \bar{D}'_L M_d D'_R + h.c., \quad (43)$$

where

$$M_u = \frac{1}{\sqrt{2}} (h_q \kappa_1 + \tilde{h}_q \kappa_2), \quad M_d = \frac{1}{\sqrt{2}} (\tilde{h}_q \kappa_1 + h_q \kappa_2), \quad (44)$$

and  $U'_{L,R}$ ,  $D'_{L,R}$  are three dimensional vectors built of the weak quark fields (e.g.  $\bar{U}'_L = (\bar{u}'_L \bar{c}'_L \bar{t}'_L)$ ).

In the considered model  $\kappa_1$  and  $\kappa_2$  are real, thus from relation Eq.(44) follows that quark mass matrices are hermitian

$$M_u = M_u^\dagger, \quad M_d = M_d^\dagger. \quad (45)$$

These matrices are diagonalized by a biunitary transformation

$$U'_{L,R} = V_{L,R}^u U_{L,R}, \quad D'_{L,R} = V_{L,R}^d D_{L,R}, \quad (46)$$

and

$$\begin{aligned}
V_L^{u\dagger} M_u V_R^u &= \text{diag}(m_u, m_c, m_t), \\
V_L^{d\dagger} M_d V_R^d &= \text{diag}(m_d, m_s, m_c).
\end{aligned} \tag{47}$$

If all diagonal mass matrix elements are positive after the unitary transformation

$$V_L^i = V_R^i \text{ for } i = u, d, \tag{48}$$

the Manifest Left-Right Symmetric model (MLRS) is realized [51]. If after the unitary transformation some masses are negative, then to make them positive we must modify Eq.(48), namely

$$V_R^{(i)} = V_L^{(i)} W^{(i)} \text{ for } i = u, d, \tag{49}$$

where  $W^{(i)} = \text{diag}(\varepsilon_1^{(i)}, \varepsilon_2^{(i)}, \varepsilon_3^{(i)})$  and  $\varepsilon_k^{(i)} = +1$  if  $m_k > 0$  and  $\varepsilon_k^{(i)} = -1$  for  $m_k < 0$ . We refer to the relation Eq.(49) as Quasi Manifest L-R Symmetry (QMLRS) [51].

**b. Leptons.** The Yukawa interaction for leptons is more complicated. Leptons have both Dirac and Majorana Yukawa couplings. The most general Lagrangian invariant under the gauge transformation (Eqs.(5),(13),(17)) and the discrete L-R symmetry operation (Eq.(20 - 24)) is [51]

$$L_{Yukawa}^{lepton} = - \left\{ \bar{L}_L \left[ h_l \phi + \tilde{h}_l \tilde{\phi} \right] L_R + h.c. \right\} - \bar{L}_R^c \Sigma_L h_M L_L - \bar{L}_L^c \Sigma_R h_M L_R + h.c., \tag{50}$$

where

$$\Sigma_{L,R} = i\tau_2 \Delta_{L,R} = \begin{pmatrix} \delta_{L,R}^0 & -\delta_{L,R}^+ \sqrt{2} \\ -\delta_{L,R}^+ \sqrt{2} & -\delta_{L,R}^{++} \end{pmatrix}, \tag{51}$$

and the  $3 \times 3$  complex matrix  $h_M$  is symmetric ( $h_M = h_M^T$ ). After SSB, the neutrino and charged lepton mass Lagrangians are obtained

$$L_{mass}^\nu = -\frac{1}{2} (\bar{n}'_L M_\nu n'_R + \bar{n}'_R M_\nu^* n'_L), \quad n'_R = \begin{pmatrix} \nu'_R{}^c \\ \nu'_R \end{pmatrix}, \quad n'_L = \begin{pmatrix} \nu'_L \\ \nu'_L{}^c \end{pmatrix}, \quad \nu'_{L,R} = C \bar{\nu}'_{R,L}{}^T, \tag{52}$$

$$L_{mass}^l = -\bar{l}'_L M_l l'_R - \bar{l}'_R M_l^\dagger l'_L, \tag{53}$$

where  $\nu'_{L,R}$  ( $l'_{L,R}$ ) are three dimensional vectors constructed from neutrino (charged lepton) fields and

$$M_\nu = \begin{pmatrix} 0 & M_D \\ M_D^T & M_R \end{pmatrix} = M_\nu^T, \quad M_D = \frac{1}{\sqrt{2}} (h_l \kappa_1 + \tilde{h}_l \kappa_2) = M_D^\dagger, \tag{54}$$

$$M_R = \sqrt{2} h_M \nu_R = M_R^T, \quad M_l = \frac{1}{\sqrt{2}} (h_l \kappa_2 + \tilde{h}_l \kappa_1) = M_l^\dagger. \tag{55}$$

To find the neutrino and charged lepton mass eigenstates a unitary transformation must be performed

$$n'_R = V N_R, \quad n'_L = V^* N_L, \quad l'_{L,R} = V_{L,R}^l l_{L,R}, \tag{56}$$

where  $V$  ( $V_{L,R}^l$ ) is unitary  $6 \times 6$  ( $3 \times 3$ ) matrix. After the transformation one gets

$$V^T M_\nu V = (M_\nu)_{diag}, \quad V_L^{l\dagger} M_l V_R^l = (M_l)_{diag}, \quad (57)$$

where  $(M_\nu)_{diag}$  and  $(M_l)_{diag}$  are diagonal, positive mass matrices. Similarly like in the quark sector, if  $V_R^l = V_L^l$  and all diagonal masses  $(M_l)_{diag}$  are positive, then Manifest L-R Symmetric model is realized. If the normal unitary transformation with  $V_R^l = V_L^l$  in Eq.(57) does not give positive  $(M_l)_{diag}$ , then the modification is necessary  $V_R^l = V_L^l W^l$  and QMLRS model is in the game.

In the physical bases, Lagrangian (Eq.52, 53) is given by

$$L_{mass}^{lepton} = -\frac{1}{2} \bar{N} (M_\nu)_{diag} N - \bar{l} (M_l)_{diag} l, \quad (58)$$

where

$$N = N_R + N_L = N^c, \quad l = l_L + l_R. \quad (59)$$

**c. CP symmetry.** In the model which we consider (MLRS or QMLRS) any CP violating phase can appear only in the quark and lepton mass matrices. The CP symmetry violation or conservation depends on the specific form of the  $M_u$  and  $M_d$  for quarks or  $M_l$  and  $M_\nu$  for leptons. If they are real the CP symmetry is conserved, but even if they are complex the CP symmetry can still be satisfied. This is so because we can perform a unitary transformation on the fermion fields without changing the physical observables but redefine the mass matrices. If there exist quark and lepton bases in which the mass matrices are real the CP is conserved. And opposite, if in any weak base the mass matrices are complex the CP symmetry is violated. In the quark sector this condition is equivalent to existence of a unitary and symmetric matrix  $V_q$  such that

$$V_q^\dagger M_u V_q = M_u^*, \quad V_q^\dagger M_d V_q = M_d^*. \quad (60)$$

This condition means that in the weak base where one of the mass matrices (e.q.  $M_d$ ) is diagonal the other has phase structure (for details see e.g. [32])

$$(M_u)_{ij} = |(M_u)_{ij}| \exp \left[ i \left( \frac{\delta_i - \delta_j}{2} \right) \right]. \quad (61)$$

For  $n$  generation in the hermitian matrix  $M_u$  only  $\frac{n(n-1)}{2} - n + 1 = \frac{n^2-3n+2}{2}$  phases do not satisfy the condition ( 61 ). This means that in the MLRS or QMLRS model in the quark sector for three generation only one phase breaks CP symmetry. (for two generation CP is conserved).

In the lepton sector the CP symmetry is satisfied if there is a unitary symmetric matrix  $V_l$  such that

$$V_l^\dagger M_l V_l = M_l^*, \quad V_l^\dagger M_D V_l = M_D^*, \quad (62)$$

and

$$V_l^T M_R V_l = M_R^*. \quad (63)$$

Then from Eqs. (62) and (63) it follows that in the base where  $M_L$  is diagonal the  $M_D$  and  $M_R$  matrices have the phase structure ( see Ref. [33] )

$$(M_D)_{ij} = |(M_D)_{ij}| \exp \left[ i \left( \frac{\chi_i - \chi_j}{2} \right) \right], \quad (M_R)_{ij} = |(M_R)_{ij}| \exp \left[ -i \left( \frac{\chi_i + \chi_j}{2} \right) \right]. \quad (64)$$

This means that all phases in the hermitian matrix  $M_D$  and symmetric matrix  $M_R$  which do not satisfy the condition ( 64 ) break the CP symmetry. There are  $\frac{n(n-1)}{2} + \frac{n(n+1)}{2} - n = n(n-1)$  such phases. For  $n = 3$  generation there are 6 phases which cause the CP symmetry violation.

### 2.2.1.3 Higgs particles.

The Higgs sector is described by 20 degrees of freedom (8 real fields for bidoublet and  $6 \times 2$  degrees of freedom for two triplets). After spontaneous symmetry breaking in the Higgs potential bilinear terms appear which form the mass matrices for Higgs particles. The precise form of these matrices are given in Ref. [51], [63]. To get the physical Higgs particles, the mass matrices have to be diagonalized. The initial 20 degrees of freedom give two charged  $G_{L,R}^\pm$  and two neutral  $\tilde{G}_{1,2}^0$  Goldstone bosons and 14 physical particles. These physical degrees of freedom produce:

- (i) four neutral scalars with  $J^{PC} = 0^{++}$  ( $H_i^0$   $i = 0, 1, 2, 3$ ),
- (ii) two neutral pseudoscalars with  $J^{PC} = 0^{+-}$  ( $A_i^0$   $i = 1, 2$ ),
- (iii) two singly charged bosons ( $H_i^\pm$   $i = 1, 2$ ), and
- (iv) two doubly charged Higgs particles ( $\delta_L^{\pm\pm}, \delta_R^{\pm\pm}$ ).

**(i) Four neutral scalars.** The masses of  $H_0^0$ ,  $H_1^0$  and  $H_2^0$  fields are obtained from the mass matrix which in the basis

$$(\phi_-^{0r}, \phi_+^{0r}, \delta_R^{0r}) \equiv \left[ \frac{\sqrt{2}}{\kappa_+} \text{Re} (\kappa_1 \phi_1^0 + \kappa_2 \phi_2^{0*}), \frac{\sqrt{2}}{\kappa_+} \text{Re} (\kappa_1 \phi_2^{0*} - \kappa_1 \phi_1^0), \sqrt{2} \text{Re} \delta_R^0 \right] \quad (65)$$

has the following elements ( $\varepsilon = \frac{2\kappa_1\kappa_2}{\kappa_+^2}$ )

$$\begin{aligned} M_{11} &= 2\kappa_+^2 [\lambda_1 + \varepsilon^2 (2\lambda_2 + \lambda_3) + 2\lambda_4 \varepsilon], \\ M_{12} &= M_{21} = 2\kappa_+^2 \sqrt{1 - \varepsilon^2} (2\lambda_2 + \lambda_3 + \lambda_4), \\ M_{13} &= M_{31} = \frac{1}{2} \kappa_+ v_R [2\alpha_1 + 2\alpha_2 \varepsilon + \alpha_3 (1 - \sqrt{1 - \varepsilon^2})], \\ M_{22} &= 2(2\lambda_2 + \lambda_3) \kappa_+^2 (1 - \varepsilon^2) + \frac{1}{2} \alpha_3 v_R^2 \frac{1}{\sqrt{1 - \varepsilon^2}}, \\ M_{23} &= M_{32} = \frac{1}{2} \kappa_+ v_R [4\alpha_2 \sqrt{1 - \varepsilon^2} + \alpha_3 \varepsilon], \\ M_{23} &= 2\rho_1 v_R^2. \end{aligned}$$

This mass matrix is diagonalized by the orthogonal transformation

$$\begin{pmatrix} \phi_-^{or} \\ \phi_+^{or} \\ \delta_R^{or} \end{pmatrix} = \begin{pmatrix} a_0 & a_1 & a_2 \\ b_0 & b_1 & b_2 \\ c_0 & c_1 & c_2 \end{pmatrix} \begin{pmatrix} H_0^0 \\ H_1^0 \\ H_2^0 \end{pmatrix}. \quad (67)$$

We will not present the precise results. However, if  $v_R \gg \kappa_+$ , we can find approximately that  $H_0^0 \simeq \phi_-^{or}$ ,  $H_1^0 \simeq \phi_+^{or}$  and  $H_2^0 \simeq \delta_R^{or}$  with the masses

$$\begin{aligned} M_{H_0^0}^2 &\simeq 2\kappa_+^2 [\lambda_1 + \varepsilon^2 (2\lambda_1 + \lambda_3) + 2\lambda_4\varepsilon], \\ M_{H_1^0}^2 &\simeq \frac{1}{2}\alpha_3 v_R^2 \frac{1}{\sqrt{1-\varepsilon^2}}, \\ M_{H_2^0}^2 &\simeq 2\rho_1 v_R^2. \end{aligned} \quad (68)$$

The fourth Higgs particle  $H_3^0$  is the real part of the  $\delta_L^0$  field

$$H_3^0 = \sqrt{2} \text{Re}(\delta_L^0), \quad (69)$$

and has the mass

$$M_{H_3^0}^2 = \frac{1}{2}v_R^2 (\rho_3 - 2\rho_1). \quad (70)$$

**(ii) Two neutral pseudoscalars.** Without any approximation the masses of two pseudoscalars  $A_1^0$  and  $A_2^0$  are given by

$$\begin{aligned} M_{A_1^0}^2 &= \frac{1}{2}\alpha_3 v_R^2 \frac{1}{\sqrt{1-\varepsilon^2}} - 2\kappa_+^2 (2\lambda_2 - \lambda_3), \\ M_{A_2^0}^2 &= \frac{1}{2}v_R^2 (\rho_3 - 2\rho_1). \end{aligned} \quad (71)$$

**(iii) Two singly charged Higgs particles.** The masses of the  $H_i^\pm$  ( $i = 1, 2$ ) are obtained by diagonalization of a  $2 \times 2$  mass matrix. The result is

$$\begin{aligned} M_{H_1^\pm}^2 &= \frac{1}{2}v_R^2 (\rho_3 - 2\rho_1) + \frac{1}{4}\alpha_3 \kappa_+^2 \sqrt{1-\varepsilon^2}, \\ M_{H_2^\pm}^2 &= \frac{1}{2}\alpha_3 \left[ v_R^2 \frac{1}{\sqrt{1-\varepsilon^2}} + \frac{1}{2}\kappa_+^2 \sqrt{1-\varepsilon^2} \right]. \end{aligned} \quad (72)$$

**(iv) Two doubly charged Higgs particles.** They are simply components of Higgs triplets and

$$\begin{aligned} M_{\delta_L^{\pm\pm}}^2 &= \frac{1}{2} \left[ v_R^2 (\rho_3 - 2\rho_1) + \alpha_3 \kappa_+^2 \sqrt{1-\varepsilon^2} \right], \\ M_{\delta_R^{\pm\pm}}^2 &= 2\rho_2 v_R^2 + \frac{1}{2}\alpha_3 \kappa_+^2 \sqrt{1-\varepsilon^2}. \end{aligned} \quad (73)$$

The relations among non physical Higgs particles and the physical ones and Goldstone bosons are given by ( $\kappa_- = \sqrt{\kappa_1^2 - \kappa_2^2}$ ):

$$\begin{aligned}
\phi_1^0 &= \frac{1}{\sqrt{2}\kappa_+} \left[ H_0^0 (\kappa_1 a_0 - \kappa_2 b_0) + H_1^0 (\kappa_1 a_1 - \kappa_2 b_1) + H_2^0 (\kappa_1 a_2 - \kappa_2 b_2) + i\kappa_1 \tilde{G}_1^0 - i\kappa_2 A_1^0 \right], \\
\phi_2^0 &= \frac{1}{\sqrt{2}\kappa_+} \left[ H_0^0 (\kappa_2 a_0 + \kappa_1 b_0) + H_1^0 (\kappa_2 a_1 + \kappa_1 b_1) + H_2^0 (\kappa_2 a_2 + \kappa_1 b_2) - i\kappa_2 \tilde{G}_1^0 - i\kappa_1 A_1^0 \right], \\
\delta_L^0 &= \frac{1}{\sqrt{2}} (H_3^0 + iA_2^0), \\
\delta_R^0 &= \frac{1}{\sqrt{2}} (c_0 H_0^0 + c_1 H_1^0 + c_2 H_2^0 + i\tilde{G}_2^0), \\
\phi_1^+ &= \frac{\kappa_1}{\kappa_+ \sqrt{1 + \left(\frac{\kappa_-^2}{\sqrt{2}\kappa_+ v_R}\right)^2}} H_2^+ - \frac{\kappa_1}{\kappa_+ \sqrt{1 + \left(\frac{\sqrt{2}\kappa_+ v_R}{\kappa_-^2}\right)^2}} G_R^+ - \frac{\kappa_2}{\kappa_+} G_L^+ \equiv a_{12} H_2^+ + a_{1R} G_R^+ + a_{1L} G_L^+, \\
\phi_2^+ &= \frac{\kappa_2}{\kappa_+ \sqrt{1 + \left(\frac{\kappa_-^2}{\sqrt{2}\kappa_+ v_R}\right)^2}} H_2^+ - \frac{\kappa_2}{\kappa_+ \sqrt{1 + \left(\frac{\sqrt{2}\kappa_+ v_R}{\kappa_-^2}\right)^2}} G_R^+ + \frac{\kappa_1}{\kappa_+} G_L^+ \equiv a_{22} H_2^+ + a_{2R} G_R^+ + a_{2L} G_L^+, \\
\delta_L^+ &= H_1^+, \\
\delta_R^+ &= \frac{1}{\sqrt{1 + \left(\frac{\kappa_-^2}{\sqrt{2}\kappa_+ v_R}\right)^2}} G_R^+ + \frac{1}{\sqrt{1 + \left(\frac{\sqrt{2}\kappa_+ v_R}{\kappa_-^2}\right)^2}} H_2^+ \equiv a_{RR} G_R^+ + a_{R2} H_2^+. \tag{74}
\end{aligned}$$

The doubly charged Higgs bosons  $\delta_{L,R}^{\pm\pm}$  are already physical. Combinations of the Goldstone bosons  $G_{L,R}^\pm$  and  $\tilde{G}_{1,2}^0$  are absorbed by  $W_{L,R}^\pm$  and  $Z_{1,2}$  respectively. Through this mechanism gauge bosons become massive. In the approximation  $v_R \gg \kappa_+$  the relations between physical and unphysical Higgs particles become much simpler. They are:

$$\phi_1^0 \simeq \frac{1}{\kappa_+ \sqrt{2}} \left[ \kappa_1 H_0^0 - \kappa_2 H_1^0 + i\kappa_1 \tilde{G}_1^0 - i\kappa_2 A_1^0 \right], \tag{75}$$

$$\phi_2^0 \simeq \frac{1}{\kappa_+ \sqrt{2}} \left[ \kappa_2 H_0^0 + \kappa_1 H_1^0 - i\kappa_2 \tilde{G}_1^0 - i\kappa_1 A_1^0 \right], \tag{76}$$

$$\delta_R^0 = \frac{1}{\sqrt{2}} (H_2^0 + iG_2^0), \tag{77}$$

$$\phi_1^+ \simeq \frac{\kappa_1}{\kappa_+} H_2^+ - \frac{\kappa_2}{\kappa_+} G_L^+, \tag{78}$$

$$\phi_2^+ \simeq \frac{\kappa_2}{\kappa_+} H_2^+ + \frac{\kappa_1}{\kappa_+} G_L^+, \tag{79}$$

$$\delta_R^+ \simeq G_R^+. \tag{80}$$



## 2.2.2 Interactions among physical fields.

### 2.2.2.1 Gauge boson - fermion interactions.

The charged and neutral current interactions for fermions are obtained from Eq.(9). For quarks the charged current interaction is equal

$$L_{CC}^{(q)} = \frac{g}{\sqrt{2}} (\bar{U}\gamma^\mu (P_L \cos \xi U_L^{CKM} - P_R \sin \xi U_R^{CKM}) DW_{1\mu}^+ + \bar{U}\gamma^\mu (P_L \sin \xi U_L^{CKM} + P_R \cos \xi U_R^{CKM}) DW_{2\mu}^+) + h.c. , \quad (81)$$

where  $U = U_L + U_R$ ,  $D = D_L + D_R$  are the quark eigenmass states (Eq.(46)) and the Cabibbo - Kobayashi - Maskawa (CKM) matrices are given by

$$U_L^{CKM} = V_L^{u\dagger} V_L^d, \quad U_R^{CKM} = V_R^{u\dagger} V_R^d. \quad (82)$$

From Eq.(48) it follows that in the MLRS the CKM mixing matrices for left - and right - handed quarks are equal

$$U_R^{CKM} = U_L^{CKM}, \quad (83)$$

and in agreement with Eq.(49), for QMLRS model

$$(U_R^{CKM})_{ij} = \pm (U_L^{CKM})_{ij}. \quad (84)$$

The neutral current interaction for quarks is given by

$$L_{NC}^{(q)} = \frac{e}{2 \sin \Theta_W \cos \Theta_W} \sum_{i=up, down, j=1,2} \sum \bar{\psi}_i \gamma^\mu [A_L^{ji} P_L + A_R^{ji} P_R] \psi_i Z_{j\mu} + e \sum_{i=up, down} Q_i \bar{\psi}_i \gamma^\mu \psi_i A_\mu. \quad (85)$$

The left and right handed couplings  $A_{L,R}^{1,2;i}$  ( $i = up$  or  $down$ ) are the following

$$A_L^{1i} = \cos \phi g_L^i + \sin \phi g_L^i, \quad (86)$$

$$A_R^{1i} = \cos \phi g_R^i + \sin \phi g_R^i, \quad (87)$$

$$A_L^{2i} = \sin \phi g_L^i - \cos \phi g_L^i, \quad (88)$$

$$A_R^{2i} = \sin \phi g_R^i - \cos \phi g_R^i, \quad (89)$$

where

$$g_L^i = 2T_{3i}^L - 2Q_i \sin^2 \Theta, \quad (90)$$

$$g_L^i = \frac{2 \sin^2 \Theta}{\sqrt{\cos 2\Theta}} (Q_i - T_{3i}^L), \quad (91)$$

$$g_R^i = -2Q_i \sin^2 \Theta, \quad (92)$$

$$g_R^i = \frac{2}{\sqrt{\cos 2\Theta}} (Q_i \sin^2 \Theta - T_{3i}^R \cos^2 \Theta). \quad (93)$$

For leptons the charged current interaction is given by

$$L_{CC}^{(l)} = \frac{g}{\sqrt{2}} (\bar{N}\gamma^\mu (P_L \cos \xi K_L - P_R \sin \xi K_R) l W_{1\mu}^+ + \bar{N}\gamma^\mu (P_L \sin \xi K_L + P_R \cos \xi K_R) l W_{2\mu}^+) + h.c. , \quad (94)$$

where  $K_L$  ( $K_R$ ) are  $6 \times 3$  mixing matrices

$$K_L = V_L^{\nu\dagger} V_L^l, \quad K_R = V_R^{\nu\dagger} V_R^l. \quad (95)$$

The matrices  $V_{L,R}^l$  are given by Eq.(56) and Eq.(57), the  $6 \times 3$  matrices  $V_{L,R}^{\nu\dagger}$  are defined by the V matrix (Eq.(56), Eq.(57)) in the way

$$V = \begin{pmatrix} V_L^{\nu*} \\ V_R^\nu \end{pmatrix}. \quad (96)$$

The charged leptons and neutrino neutral current interactions are

$$L_{NC}^{(l)} = \frac{e}{2 \sin \Theta_W \cos \Theta_W} [J_1^\mu Z_{1\mu} + J_2^\mu Z_{2\mu}] + e J_{EM}^\mu A_\mu , \quad (97)$$

where

$$J_i^\mu = \sum_{\text{charged leptons}} \bar{l}\gamma^\mu [A_L^{il} P_L + A_R^{il} P_R] l + \sum_{\text{neutrinos}} \bar{N}\gamma^\mu [A_L^{i\nu} \Omega_L P_L + A_R^{i\nu} \Omega_R P_R] N, \quad (98)$$

and

$$J_{EM}^\mu = - \sum_{\text{charged leptons}} \bar{l}\gamma^\mu l. \quad (99)$$

The  $6 \times 6$  mixing matrices  $\Omega_{L,R}$  are defined in the way

$$\Omega_L = V_L^{\nu\dagger} V_L^\nu = \Omega_L^\dagger, \quad \Omega_R = V_R^{\nu\dagger} V_R^\nu = \Omega_R^\dagger. \quad (100)$$

The couplings  $A_{L,R}^{1,2;i}$  ( $i = \nu$  or  $l$ ) are given by the same formula as for quarks (Eqs.(86-93)) where we have only put:  $Q_\nu = 0$ ,  $T_{3\nu}^{L,R} = +\frac{1}{2}$  for neutrinos and  $Q_l = -1$ ,  $T_{3l}^{L,R} = -\frac{1}{2}$  for charged leptons.

The mixing matrices satisfy a few constrains which are useful in future applications. From the relation  $VV^\dagger = I_{6 \times 6}$  it follows that

$$V_L^\nu V_L^{\nu\dagger} = V_R^\nu V_R^{\nu\dagger} = I_{3 \times 3}, \quad V_R^\nu V_L^{\nu T} = 0. \quad (101)$$

Then, from the definition of  $K_{L,R}$  matrices we have

$$K_L^\dagger K_L = K_R^\dagger K_R = I_{3 \times 3}, \quad K_L^T K_R = K_R^T K_L = 0, \quad (102)$$

and

$$K_L K_L^\dagger = \Omega_L, \quad K_R K_R^\dagger = \Omega_R. \quad (103)$$

From the relations Eq.(101) and (102) there is also

$$K_R^T \Omega_L = K_L^T \Omega_R = \Omega_L \Omega_R^T = 0, \quad (104)$$

and

$$\Omega_L K_L = K_L, \quad \Omega_R K_R = K_R. \quad (105)$$

From the relation  $V^\dagger V = I_{6 \times 6}$  we have

$$\Omega_L^* + \Omega_R = I_{6 \times 6}. \quad (106)$$

The relation  $V^T M_\nu V = (M_\nu)_{diag}$  gives

$$V_L^{\nu\dagger} M_D V_R^\nu + \left( V_L^{\nu\dagger} M_D V_R^\nu \right)^T + V_R^{\nu T} M_R V_R^\nu = (M_\nu)_{diag}. \quad (107)$$

But from  $M_\nu = V^* (M_\nu)_{diag} V^\dagger$  it follows

$$V_L^\nu (M_\nu)_{diag} V_L^{\nu T} = 0, \quad (108)$$

$$V_L^\nu (M_\nu)_{diag} V_R^{\nu\dagger} = M_D, \quad (109)$$

$$V_R^\nu (M_\nu)_{diag} V_R^{\nu T} = M_R^*. \quad (110)$$

From Eq.(108) three other relations follow

$$\Omega_L (M_\nu)_{diag} \Omega_L^* = \Omega_L (M_\nu)_{diag} K_L^* = K_L^\dagger (M_\nu)_{diag} K_L^* = 0 \quad (111)$$

All the above relations are useful when studying leptons - Higgs particles couplings, and give the possibility to express unphysical couplings by masses  $(M_\nu)_{diag}$  and elements of mixing matrices  $K_{L,R}$ ,  $\Omega_{L,R}$ .

### 2.2.2.2 Three and four gauge particles interactions.

The structure of three and four gauge couplings is very similar to the analogous couplings in the SM. There are only different factors. To get the coupling for physical gauge particles we use the Lagrangian Eq.(10) where we introduce the physical fields  $W_i^\pm$ ,  $Z_i$  ( $i = 1, 2$ ) and A (Eqs.(37),(38)). For three gauge boson interactions we obtained:

$$\begin{aligned} L_g^3 = & \left\{ -ig \left( \partial_\gamma^x g_{\nu\delta} - \partial_\delta^x g_{\nu\gamma} - \partial_\nu^y g_{\gamma\delta} + \partial_\delta^y g_{\nu\gamma} + \partial_\nu^z g_{\gamma\delta} - \partial_\gamma^z g_{\nu\delta} \right) \left[ (y_1 \sin^2 \xi + x_1 \cos^2 \xi) (W_1^{-\nu}(x) W_1^{+\gamma}(y) Z_1^\delta(z)) \right. \right. \\ & + (y_2 \sin^2 \xi + x_2 \cos^2 \xi) (W_1^{-\nu}(x) W_1^{+\gamma}(y) Z_2^\delta(z)) + x_3 (W_1^{-\nu}(x) W_1^{+\gamma}(y) A^\delta(z)) \\ & + (y_1 \cos^2 \xi + x_1 \sin^2 \xi) (W_2^{-\nu}(x) W_2^{+\gamma}(y) Z_1^\delta(z)) + (y_2 \cos^2 \xi + x_2 \sin^2 \xi) (W_2^{-\nu}(x) W_2^{+\gamma}(y) Z_2^\delta(z)) \\ & + x_3 (W_2^{-\nu}(x) W_2^{+\gamma}(y) A^\delta(z)) + ((x_1 - y_1) \cos \xi \sin \xi) (W_1^{-\nu}(x) W_2^{+\gamma}(y) Z_1^\delta(z) + W_2^{-\nu}(x) W_1^{+\gamma}(y) Z_1^\delta(z)) \\ & \left. \left. + ((x_2 - y_2) \cos \xi \sin \xi) (W_1^{-\nu}(x) W_2^{+\gamma}(y) Z_2^\delta(z) + W_2^{-\nu}(x) W_1^{+\gamma}(y) Z_2^\delta(z)) \right] \right\} |_{x=y=z}. \quad (112) \end{aligned}$$

The four gauge bosons interactions can be given in the comprehensive form:

$$\begin{aligned}
L_g^4 = & -g^2 (2g_{\mu\nu}g_{\gamma\delta} - g_{\mu\gamma}g_{\nu\delta} - g_{\mu\delta}g_{\nu\gamma}) \left\{ \frac{1}{2} [(y_1^2 \sin^2 \xi + x_1^2 \cos^2 \xi) (W_1^{-\mu}W_1^{+\nu}Z_1^\gamma Z_1^\delta) \right. \\
& + (y_2^2 \sin^2 \xi + x_2^2 \cos^2 \xi) (W_1^{-\mu}W_1^{+\nu}Z_2^\gamma Z_2^\delta) + x_3^2 (W_1^{-\mu}W_1^{+\nu}A^\gamma A^\delta) + (y_1^2 \cos^2 \xi + x_1^2 \sin^2 \xi) (W_2^{-\mu}W_2^{+\nu}Z_1^\gamma Z_1^\delta) \\
& + (y_2^2 \cos^2 \xi + x_2^2 \sin^2 \xi) (W_2^{-\mu}W_2^{+\nu}Z_2^\gamma Z_2^\delta) + x_3^2 (W_2^{-\mu}W_2^{+\nu}A^\gamma A^\delta) \\
& + ((x_1^2 - y_1^2) \cos \xi \sin \xi) (W_1^{-\mu}W_2^{+\nu}Z_1^\gamma Z_1^\delta + W_2^{-\mu}W_1^{+\nu}Z_1^\gamma Z_1^\delta) \\
& + ((x_2^2 - y_2^2) \cos \xi \sin \xi) (W_1^{-\mu}W_2^{+\nu}Z_2^\gamma Z_2^\delta + W_2^{-\mu}W_1^{+\nu}Z_2^\gamma Z_2^\delta)] \\
& + (y_1 y_2 \sin^2 \xi + x_1 x_2 \cos^2 \xi) (W_1^{-\mu}W_1^{+\nu}Z_1^\gamma Z_2^\delta) + (y_1 y_3 \sin^2 \xi + x_1 x_3 \cos^2 \xi) (W_1^{-\mu}W_1^{+\nu}Z_1^\gamma A^\delta) \\
& + (y_2 y_3 \sin^2 \xi + x_2 x_3 \cos^2 \xi) (W_1^{-\mu}W_1^{+\nu}Z_2^\gamma A^\delta) + (y_1 y_2 \cos^2 \xi + x_1 x_2 \sin^2 \xi) (W_2^{-\mu}W_2^{+\nu}Z_1^\gamma Z_2^\delta) \\
& + (y_1 y_3 \cos^2 \xi + x_1 x_3 \sin^2 \xi) (W_2^{-\mu}W_2^{+\nu}Z_1^\gamma A^\delta) + (y_2 y_3 \cos^2 \xi + x_2 x_3 \sin^2 \xi) (W_2^{-\mu}W_2^{+\nu}Z_2^\gamma A^\delta) \\
& + ((x_1 x_2 - y_1 y_2) \cos \xi \sin \xi) (W_1^{-\mu}W_2^{+\nu}Z_1^\gamma Z_2^\delta + W_2^{-\mu}W_1^{+\nu}Z_1^\gamma Z_2^\delta) \\
& + ((x_1 x_3 - y_1 y_3) \cos \xi \sin \xi) (W_1^{-\mu}W_2^{+\nu}Z_1^\gamma A^\delta + W_2^{-\mu}W_1^{+\nu}Z_1^\gamma A^\delta) \\
& + ((x_2 x_3 - y_2 y_3) \cos \xi \sin \xi) (W_1^{-\mu}W_2^{+\nu}Z_2^\gamma A^\delta + W_2^{-\mu}W_1^{+\nu}Z_2^\gamma A^\delta) \\
& - \frac{1}{2} \left[ \frac{1}{2} (\sin^4 \xi + \cos^4 \xi) (W_1^{-\mu}W_1^{-\nu}W_1^{+\gamma}W_1^{+\delta} + W_2^{-\mu}W_2^{-\nu}W_2^{+\gamma}W_2^{+\delta}) \right. \\
& + (-\sin^3 \xi \cos \xi + \cos^3 \xi \sin \xi) (W_1^{-\mu}W_1^{-\nu}W_1^{+\gamma}W_2^{+\delta} + W_1^{-\mu}W_2^{-\nu}W_1^{+\gamma}W_1^{+\delta}) \\
& + (-\cos^3 \xi \sin \xi + \sin^3 \xi \cos \xi) (W_2^{-\mu}W_2^{-\nu}W_2^{+\gamma}W_1^{+\delta} + W_2^{-\mu}W_1^{-\nu}W_2^{+\gamma}W_2^{+\delta}) \\
& \left. + \sin^2 \xi \cos^2 \xi (W_2^{-\mu}W_2^{-\nu}W_1^{+\gamma}W_1^{+\delta} + W_1^{-\mu}W_1^{-\nu}W_2^{+\gamma}W_2^{+\delta}) \right] - 2 \sin^2 \xi \cos^2 \xi W_1^{-\mu}W_2^{-\nu}W_2^{+\gamma}W_1^{+\delta} \left. \right\}. \quad (113)
\end{aligned}$$

### 2.2.2.3 Fermion - scalar boson interactions.

The fermion - Higgs particles interactions are given by Lagrangian Eq.(14) for quarks and Eq.(50) for leptons. We have to express the weak fields by the physical ones and the Yukawa couplings by fermion masses and CKM mixing matrices elements. For quark - Higgs particles couplings we have

$$-\sum_{i,j} \bar{Q}_{iL} \left( (h_q)_{ij} \phi + (\tilde{h}_q)_{ij} \tilde{\phi} \right) Q_{jR} + h.c. = L_{mass}^q + L_{quark-Higgs}, \quad (114)$$

where  $L_{mass}^q$  is given by Eq.(43), and

$$\begin{aligned}
L_{quark-Higgs}(u, d) = & -\bar{U} \left[ P_L \left( M_{diag}^u B_0^* + U_R^{CKM} M_{diag}^d U_L^{CKM\dagger} A_0 \right) \right. \\
& + P_R \left( M_{diag}^u B_0 + U_L^{CKM} M_{diag}^d U_R^{CKM\dagger} A_0^* \right) \left. \right] U \\
& -\bar{D} \left[ P_L \left( M_{diag}^d B_0 + U_R^{CKM\dagger} M_{diag}^u U_L^{CKM} A_0^* \right) \right. \\
& \left. + P_R \left( M_{diag}^d B_0^* + U_L^{CKM\dagger} M_{diag}^u U_R^{CKM} A_0 \right) \right] D
\end{aligned}$$

$$\begin{aligned}
& -\bar{U} \left[ P_L \left( M_{diag}^u U_L^{CKM} B^+ - U_R^{CKM} M_{diag}^d A^+ \right) \right. \\
& + P_R \left( M_{diag}^u U_R^{CKM} A^+ - U_L^{CKM} M_{diag}^d B^+ \right) \left. \right] D \\
& -\bar{D} \left[ P_L \left( U_R^{CKM\dagger} M_{diag}^u A^- - M_{diag}^d U_L^{CKM\dagger} B^- \right) \right. \\
& + P_R \left( U_L^{CKM\dagger} M_{diag}^u B^- - M_{diag}^d U_R^{CKM\dagger} A^- \right) \left. \right] U.
\end{aligned} \tag{115}$$

The  $A_0$ ,  $B_0$ ,  $A^\pm$  and  $B^\pm$  are combinations of physical Higgs fields and Goldstone bosons:

$$\begin{aligned}
A_0 &= \frac{\sqrt{2}}{\kappa_-^2} (\kappa_1 \phi_2^0 - \kappa_2 \phi_1^{0*}) = \frac{\kappa_+}{\kappa_-^2} (H_0^0 b_0 + H_1^0 b_1 + H_2^0 b_2 - i A_1^0), \\
B_0 &= \frac{\sqrt{2}}{\kappa_-^2} (\kappa_1 \phi_1^0 - \kappa_2 \phi_2^{0*}) \\
&= \frac{1}{\kappa_-^2 \kappa_+} \left[ H_0^0 (a_0 \kappa_-^2 - 2\kappa_1 \kappa_2 b_0) + H_1^0 (a_1 \kappa_-^2 - 2\kappa_1 \kappa_2 b_1) + H_2^0 (a_2 \kappa_-^2 - 2\kappa_1 \kappa_2 b_2) + i \kappa_-^2 \tilde{G}_1^0 - i 2\kappa_1 \kappa_2 A_1^0 \right], \\
A^\pm &= \frac{\sqrt{2}}{\kappa_-^2} (\kappa_1 \phi_1^\pm + \kappa_2 \phi_2^\pm) = \left[ \frac{4\kappa_+^4 v_R^2}{\kappa_-^4 (2\kappa_+^2 v_R^2 + \kappa_-^4)} \right]^{\frac{1}{2}} H_2^\pm - \left[ \frac{2\kappa_+^2}{\kappa_-^4 + 2\kappa_+^2 v_R^2} \right]^{\frac{1}{2}} G_R^\pm, \\
B^\pm &= \frac{\sqrt{2}}{\kappa_-^2} (\kappa_2 \phi_1^\pm + \kappa_1 \phi_2^\pm) = \frac{4\kappa_1 \kappa_2 v_R}{\kappa_-^2 \sqrt{2\kappa_+^2 v_R^2 + \kappa_-^4}} H_2^\pm - \frac{2\sqrt{2}\kappa_1 \kappa_2}{\kappa_+ \sqrt{2\kappa_+^2 v_R^2 + \kappa_-^4}} G_R^\pm + \frac{\sqrt{2}}{\kappa_+} G_L^\pm.
\end{aligned} \tag{116}$$

For lepton - Higgs particle couplings there is

$$-\left\{ \bar{L}_L \left[ h_l \phi + \tilde{h}_l \tilde{\phi} \right] L_R + h.c. \right\} - \bar{L}_R^c \Sigma_L h_M L_L - \bar{L}_L^c \Sigma_R h_M L_R = L_{mass}^\nu + L_{mass}^l + L_{lepton-Higgs}, \tag{117}$$

where  $L_{mass}^\nu$  ( $L_{mass}^l$ ) are given by Eq.(52), (Eq.(53)) and

$$\begin{aligned}
L_{lepton-Higgs} &= -\bar{\nu}'_L \left( h_l \phi_1^0 + \tilde{h}_l \phi_2^{0*} \right) \nu'_R - \bar{\nu}'_L \left( h_l \phi_1^+ - \tilde{h}_l \phi_2^+ \right) l'_R - \bar{l}'_L \left( h_l \phi_2^- - \tilde{h}_l \phi_1^- \right) \nu'_R - \bar{l}'_L \left( h_l \phi_2^0 + \tilde{h}_l \phi_1^{0*} \right) l'_R \\
&\quad - \delta_L^+ \bar{\nu}'_R^c h_M \nu'_L + \frac{\delta_L^+}{\sqrt{2}} \left( \bar{\nu}'_R^c h_M l'_L + \bar{l}'_R^c h_M \nu'_L \right) + \delta_L^{++} \bar{l}'_R^c h_M l'_L \\
&\quad - \delta_R^+ \bar{\nu}'_L^c h_M \nu'_R + \frac{\delta_R^+}{\sqrt{2}} \left( \bar{\nu}'_L^c h_M l'_R + \bar{l}'_L^c h_M \nu'_R \right) + \delta_R^{++} \bar{l}'_L^c h_M l'_R + h.c. .
\end{aligned} \tag{118}$$

Now in each term we can introduce the physical fields and the physical parameters.

For two Majorana neutrinos - neutral Higgs particle interaction we have:

$$\begin{aligned}
& \bar{\nu}'_L \left( h_l \phi_1^0 + \tilde{h}_l \phi_2^{0*} \right) \nu'_R + h.c. = \\
& \sum_a \bar{N}_a \left\{ \left[ (\Omega_L)_{aa} m_a^N B_0 + \sum_l (K_L)_{al} (K_R^*)_{al} m_l A_0^* \right] P_R + \left[ m_a^N (\Omega_L)_{aa} B_0^* + \sum_l (K_L^*)_{al} (K_R)_{al} m_l A_0 \right] P_L \right\} N_a \\
& + \sum_{a>b,c} \bar{N}_a \left\{ \left[ ((\Omega_L)_{ac} m_c^N (\Omega_R)_{cb} + (\Omega_L)_{bc} m_c^N (\Omega_R)_{ca}) B_0 + \sum_l m_l ((K_L)_{al} (K_R^*)_{bl} + (K_L)_{bl} (K_R^*)_{al}) A_0^* \right] P_R \right. \\
& + \left. \left[ ((\Omega_L)_{ac} m_c^N (\Omega_R)_{cb} + (\Omega_L)_{bc} m_c^N (\Omega_R)_{ca}) B_0^* + \sum_l m_l ((K_L^*)_{bl} (K_R)_{al} + (K_L^*)_{al} (K_R)_{bl}) A_0 \right] P_L \right\} N_b,
\end{aligned} \tag{119}$$

$$\begin{aligned} \delta_R^0 \bar{\nu}_L^c h_M \nu_R' + h.c. &= \frac{1}{2v_R} \sum_a \bar{N}_a \left( \sum_c m_c^N \left[ (\Omega_R)_{ca}^2 P_R \delta_R^0 + (\Omega_R^*)_{ca}^2 P_L \delta_R^{0*} \right] \right) N_a \\ &+ \frac{1}{v_R} \sum_{a>b} \bar{N}_a \left( \sum_c m_c^N \left[ (\Omega_R)_{cb} (\Omega_R)_{ca} P_R \delta_R^0 + (\Omega_R^*)_{cb} (\Omega_R^*)_{ca} P_L \delta_R^{0*} \right] \right) N_b, \end{aligned} \quad (120)$$

and

$$\delta_L^0 \bar{\nu}_R^c h_M \nu_L' + h.c. = \frac{1}{\sqrt{2}v_R} \sum_a \bar{N}_a \left[ X_{aa} \delta_L^0 P_L + X_{aa}^* \delta_L^{0*} P_R \right] N_a + \frac{\sqrt{2}}{v_R} \sum_{a>b} \bar{N}_a \left[ X_{ab} \delta_L^0 P_L + X_{ab}^* \delta_L^{0*} P_R \right] N_b, \quad (121)$$

where the  $6 \times 6$  matrix X is given by

$$X = (K_L^* W^l K_R^T) (M_\nu)_{diag} (K_R W^l K_L^+) = X^T. \quad (122)$$

Majorana neutrinos interact with charged leptons and charged Higgs particles in the way:

$$\begin{aligned} &\bar{\nu}_L' (h_l \phi_1^+ - \tilde{h}_l \phi_2^+) l_R' + \bar{l}_L' (h_l \phi_2^- - \tilde{h}_l \phi_1^-) \nu_R' + h.c. = \\ &\sum_{a,l} \bar{N}_a \left\{ \left[ \sum_b (\Omega_L)_{ab} m_b^N (K_R)_{bl} A^+ - (K_L)_{al} m_l B^+ \right] P_R + \left[ m_a^N (K_L)_{al} B^+ - (K_R)_{al} m_l A^+ \right] P_L \right\} l_l \\ &+ \sum_{a,l} \bar{l}_l \left\{ \left[ \sum_b (K_R^\dagger)_{lb} m_b^N (\Omega_L)_{ba} A^- - m_l (K_L^\dagger)_{la} B^- \right] P_L + \left[ (K_L^\dagger)_{la} m_a^N B^- - m_l (K_R^\dagger)_{la} A^- \right] P_R \right\} N_a, \end{aligned} \quad (123)$$

$$\begin{aligned} \frac{\delta_R^+}{\sqrt{2}} (\bar{\nu}_L^c h_M l_R' + \bar{l}_L^c h_M \nu_R') + h.c. &= \frac{1}{v_R} \sum_{a,l} \left\{ \bar{N}_a \left[ \sum_b (\Omega_R^*)_{ab} m_b^N (K_R)_{bl} \right] P_R l_l \delta_R^+ \right. \\ &\left. + \bar{l}_l \left[ \sum_b (K_R^\dagger)_{lb} m_b^N (\Omega_R^*)_{ba} \right] P_L N_a \delta_R^- \right\}, \end{aligned} \quad (124)$$

and

$$\frac{\delta_L^+}{\sqrt{2}} (\bar{\nu}_R^c h_M l_L' + \bar{l}_R^c h_M \nu_L') + h.c. = \frac{1}{v_R} \sum_{a,l} \left\{ \delta_L^+ [\bar{N}_a (X K_L)_{al} P_L l_l] + \delta_L^- [\bar{l}_l (K_L^+ X^*)_{la} P_R N_a] \right\}. \quad (125)$$

Finally, two charged leptons interact with neutral Higgs particles:

$$\begin{aligned} &\bar{l}_L (h_l \phi_2^0 + \tilde{h}_l \phi_1^{0*}) l_R' + h.c. = \\ &\sum_{l,k} \bar{l}_l \left\{ \left[ \delta_{lk} m_l B_0^* + \sum_a (K_L^*)_{al} (K_R)_{ak} m_a^N A_0 \right] P_R + \left[ \delta_{lk} m_l B_0 + \sum_a (K_L)_{ak} (K_R^*)_{al} m_a^N A_0^* \right] P_L \right\} l_k, \end{aligned} \quad (126)$$

and doubly charged Higgs particles

$$\delta_R^{++} \bar{l}_L^c h_M l'_R + h.c. = \frac{1}{\sqrt{2}v_R} \sum_{l,k} \left\{ \delta_R^{++} \left[ l_l^T C \left( K_R^T (M_\nu)_{diag} K_R \right)_{lk} P_R l_k \right] + \delta_R^{--} \left[ \bar{l}_l \left( K_R^+ (M_\nu)_{diag} K_R^* \right)_{lk} P_L C \bar{l}_k^T \right] \right\}, \quad (127)$$

$$\delta_L^{++} \bar{l}_R^c h_M l'_L + h.c. = \frac{1}{\sqrt{2}v_R} \sum_{l,k} \left\{ \delta_L^{++} \left[ l_k^T C \left( K_L^T X K_L^* \right)_{kl} P_L l_l \right] + \delta_L^{--} \left[ \bar{l}_k \left( K_L^T X^* K_L^* \right)_{kl} P_R C \bar{l}_l^T \right] \right\}. \quad (128)$$

### 2.2.2.4 Gauge bosons - Higgs particles interactions.

The interactions among gauge bosons  $W_i^\pm$ ,  $Z_i$ ,  $A$  ( $i = 1, 2$ ) and Higgs particles  $H_i^0$ , ( $i = 0, 1, 2, 3$ )  $A_k^0$ ,  $A_k^\pm$ , ( $i = 1, 2$ ),  $\delta_{L,R}^{\pm\pm}$  together with Goldstone bosons are given by the Lagrangian  $L_{Higgs}^{kin}$  (Eq.(18)). After SSB (Eq.(26)) we obtain

$$L_{Higgs}^{kin} = L_{Higgs}^{(2)} + L_{Higgs}^{gauge}. \quad (129)$$

The Lagrangian  $L_{Higgs}^{(2)}$  contains four components:

$$L_{Higgs}^{(2)} = L_H^{kin} + L_{GB}^{kin} + L_{bilinear} + L_M. \quad (130)$$

The  $L_H^{kin}$  term is the kinetic energy for Higgs particles

$$\begin{aligned} L_H^{kin} &= \frac{1}{2} \sum_{i=0}^3 (\partial^\mu H_i^0) (\partial_\mu H_i^0) + \frac{1}{2} \sum_{i=0}^2 (\partial^\mu A_i^0) (\partial_\mu A_i^0) \\ &+ \sum_{i=1}^2 (\partial^\mu H_i^+) (\partial_\mu H_i^-) + (\partial^\mu \delta_L^{++}) (\partial_\mu \delta_L^{--}) + (\partial^\mu \delta_R^{++}) (\partial_\mu \delta_R^{--}), \end{aligned} \quad (131)$$

and

$$L_{GB}^{kin} = (\partial^\mu G_L^+) (\partial_\mu G_L^-) + (\partial^\mu G_R^+) (\partial_\mu G_R^-) + \frac{1}{2} (\partial^\mu \tilde{G}_1^0) (\partial_\mu \tilde{G}_1^0) + \frac{1}{2} (\partial^\mu \tilde{G}_2^0) (\partial_\mu \tilde{G}_2^0) \quad (132)$$

is the kinetic energy for Goldstone bosons.  $L_M$  is the mass Lagrangian of the Gauge bosons (Eq.(34)).  $L_{bilinear}$  contains bilinear terms between Gauge and Higgs particles and is given by

$$\begin{aligned} L_{bilinear} &= \frac{ig}{2\sqrt{2}} \left[ \kappa_1 \partial^\mu (\phi_1^0 - \phi_1^{0*}) - \kappa_2 \partial^\mu (\phi_2^0 - \phi_2^{0*}) \right] [W_{3L\mu} - W_{3R\mu}] \\ &+ \frac{ig}{2} \left\{ [\kappa_1 (\partial^\mu \phi_2^-) - \kappa_2 (\partial^\mu \phi_1^-)] W_{L\mu}^+ + [\kappa_2 (\partial^\mu \phi_1^+) - \kappa_1 (\partial^\mu \phi_2^+)] W_{L\mu}^- \right\} \\ &+ \frac{ig}{2} \left\{ [\kappa_1 (\partial^\mu \phi_1^-) - \kappa_2 (\partial^\mu \phi_2^-)] W_{R\mu}^+ + [\kappa_2 (\partial^\mu \phi_2^+) - \kappa_1 (\partial^\mu \phi_1^+)] W_{R\mu}^- \right\} \\ &+ ig \frac{v_R}{\sqrt{2}} \left\{ (\partial^\mu \delta_R^+) W_{R\mu}^- - (\partial^\mu \delta_R^-) W_{R\mu}^+ \right\} + i \frac{v_R}{\sqrt{2}} \left\{ \partial^\mu [(\delta_R^{0*}) - (\delta_R^0)] (gW_{3R\mu} - g'B_\mu) \right\}. \end{aligned} \quad (133)$$

The gauge fixing Lagrangian (see next Chapter) will be chosen to cancel the  $L_{bilinear}$  which complicates the calculation of Higgs particle propagators.

The remaining part  $L_{Higgs}^{gauge}$  describes the interactions among gauge bosons and Higgs particles. The number of couplings is large. There are 324 couplings among four bosons. We do not give all the couplings here explicitly. Here we describe the procedure by which all couplings can be obtained. We divide the  $L_{Higgs}^{gauge}$  terms into triple and quadruple couplings

$$L_{Higgs}^{gauge} = L^{(III)} + L^{(IV)}. \quad (134)$$

**III A. Three bosons coupling with one Higgs particle.** There are 21 different couplings between two gauge and one charged Higgs (Goldstone) particles which are obtained from the Lagrangian

$$\begin{aligned} & \frac{g^2}{2} \left\{ [\phi_1^- \kappa_2 - \phi_2^- \kappa_1] W_{3R}^\mu W_{L\mu}^+ + [\phi_2^- \kappa_2 - \phi_1^- \kappa_1] W_{3L}^\mu W_{R\mu}^+ \right\} \\ & + \sqrt{2} g v_R W_{R\mu}^+ \delta_R^- \left[ g' B^\mu - \frac{1}{2} g W_{3R}^\mu \right] - \frac{g^2 v_R}{\sqrt{2}} W_{R\mu}^+ W^{\mu+} \delta_R^{--} + h.c. . \end{aligned} \quad (135)$$

There are 20 couplings with two gauge bosons and one neutral Higgs particle. They are obtained from the Lagrangian

$$\frac{g^2}{4\sqrt{2}} [\phi_1^0 \kappa_1 + \phi_2^0 \kappa_2] (W_{3L\mu} - W_{3R\mu}) (W_{3L}^\mu - W_{3R}^\mu) + \frac{v_R}{\sqrt{2}} \delta_R^0 (g W_{3R\mu} - g' B_\mu) (g W_{3R}^\mu - g' B^\mu) + h.c. \quad (136)$$

and

$$\begin{aligned} & \frac{g^2}{2\sqrt{2}} [\phi_1^0 \kappa_1 + \phi_2^0 \kappa_2] \left( W_{L\mu}^+ W_L^{-\mu} + W_{R\mu}^+ W_R^{-\mu} \right) - \frac{g^2}{\sqrt{2}} [\phi_1^0 \kappa_2 + \phi_2^{0*} \kappa_1] W_L^{-\mu} W_R^{+\mu} \\ & + \frac{g^2 v_R}{\sqrt{2}} \delta_R^0 W_{R\mu}^+ W_R^{-\mu} + h.c. . \end{aligned} \quad (137)$$

It is worth to stress that the combinations  $W_{3L\mu} - W_{3R\mu}$  and  $g W_{3R\mu} - g' B_\mu$  do not contain the photon field. As it should be, the photon does not couple to chargeless particles. To understand the absence of other couplings it is worth to explore the charge conjugation symmetry C. The Gauge - Higgs particle part of the Lagrangian is C symmetric. We set the P and C eigenvalues  $J^{PC} = 1^{--}$  to gauge bosons, and  $0^{++}$  or  $0^{+-}$  to  $H_i^0$  and  $A_i^0$  ( $G_i^0$ ) scalar Higgs particles (Goldstone bosons) respectively. Then it is easy to understand that the couplings of the type  $A_i^0 Z_k Z_j$ ,  $\tilde{G}_i^0 Z_k Z_j$  and also  $\tilde{G}_i^0 W_k^+ W_k^-$  are absent as they are not symmetric under C transformation.

**III B. Couplings of one gauge boson and two Higgs (Goldstone) bosons.** There are 33 couplings of one gauge boson and two charged Higgs particles which are given by the Lagrangian

$$\begin{aligned} & \frac{ig}{2} [(\partial^\mu \phi_1^+) \phi_1^- - (\partial^\mu \phi_2^-) \phi_2^+] (W_{3L\mu} + W_{3R\mu}) - ig' [(\partial^\mu \delta_R^-) \delta_R^+ + (\partial^\mu \delta_L^-) \delta_L^+] B_\mu \\ & - i [(\partial^\mu \delta_R^{--}) \delta_R^{++}] (g W_{3R\mu} + g' B_\mu) - i [(\partial^\mu \delta_L^{--}) \delta_L^{++}] (g W_{3L\mu} + g' B_\mu) \\ & - ig [(\partial^\mu \delta_R^+) \delta_R^{--} - (\partial^\mu \delta_R^{--}) \delta_R^+] W_{R\mu}^+ - ig [(\partial^\mu \delta_L^+) \delta_L^{--} - (\partial^\mu \delta_L^{--}) \delta_L^+] W_{L\mu}^+ + h.c. . \end{aligned} \quad (138)$$

The other 38 couplings describe the interactions of one gauge boson with one charged and one neutral Higgs (Goldstone) particles. They follow from the Lagrangian



$$\begin{aligned}
& \frac{ig}{\sqrt{2}} \left\{ (\partial^\mu \phi_2^-) \phi_1^{0*} - (\partial^\mu \phi_1^-) \phi_2^0 + (\partial^\mu \phi_2^0) \phi_1^- - (\partial^\mu \phi_1^{0*}) \phi_2^- - \sqrt{2} [(\partial^\mu \delta_L^-) \delta_L^0 - (\partial^\mu \delta_L^0) \delta_L^-] W_{L\mu}^+ \right\} \\
& + \frac{ig}{\sqrt{2}} \left\{ (\partial^\mu \phi_1^-) \phi_1^0 - (\partial^\mu \phi_2^-) \phi_2^{0*} + (\partial^\mu \phi_2^{0*}) \phi_2^- - (\partial^\mu \phi_1^0) \phi_1^- - \sqrt{2} [(\partial^\mu \delta_R^-) \delta_R^0 - (\partial^\mu \delta_R^0) \delta_R^-] W_{R\mu}^+ \right\} + h.c. . \quad (139)
\end{aligned}$$

There are 20 couplings among one gauge boson and two neutral Higgs (Goldstone) particles, given by the Lagrangian

$$\begin{aligned}
& \frac{ig}{2} [(\partial^\mu \phi_1^0) \phi_1^{0*} - (\partial^\mu \phi_2^0) \phi_2^{0*}] (W_{3L\mu} - W_{3R\mu}) + i [(\partial^\mu \delta_R^{0*}) \delta_R^0] (gW_{3R\mu} - g'B_\mu) \\
& + i [(\partial^\mu \delta_L^{0*}) \delta_L^0] (gW_{3L\mu} - g'B_\mu) + h.c. . \quad (140)
\end{aligned}$$

Here photon also does not couple to neutral particles. From C symmetry there are no couplings of the type  $H_i^0 H_j^0 Z_k$  or  $\tilde{G}_1^0 A_1^0 Z_i$ .

**IV. Couplings between two gauge bosons and two Higgs (Goldstone) particles.** In this case we divide all four bosons couplings into three classes with two charged scalars, one charged and one neutral and two neutral Higgs (Goldstone) particles. All 117 couplings among two gauge bosons and two charged scalar particles are described by the Lagrangian

$$\begin{aligned}
& \frac{g^2}{4} [\phi_2^+ \phi_2^- + \phi_1^+ \phi_1^-] (W_{3L\mu} + W_{3R\mu}) (W_{3L}^\mu + W_{3R}^\mu) + g'^2 [\delta_L^+ \delta_L^- + \delta_R^+ \delta_R^-] B_\mu B^\mu \\
& + \frac{g^2}{2} [\phi_2^+ \phi_2^- + \phi_1^+ \phi_1^-] (W_{L\mu}^- W_L^{+\mu} + W_{R\mu}^- W_R^{+\mu}) + 2g^2 \delta_R^+ \delta_R^- W_{R\mu}^- W_R^{+\mu} + 2g^2 \delta_L^+ \delta_L^- W_{L\mu}^- W_L^{+\mu} \\
& + [\delta_R^{++} \delta_R^{--}] [(gW_{3R\mu} + g'B_\mu) (gW_{3R}^\mu + g'B^\mu) + g^2 W_{R\mu}^- W_R^{+\mu}] \\
& + [\delta_L^{++} \delta_L^{--}] [(gW_{3L\mu} + g'B_\mu) (gW_{3L}^\mu + g'B^\mu) + g^2 W_{L\mu}^- W_L^{+\mu}], \quad (141)
\end{aligned}$$

and

$$\begin{aligned}
& -g^2 [\phi_2^+ \phi_1^+] W_{L\mu}^- W_R^{-\mu} - g [\delta_R^+ \delta_R^{--}] (2g'B^\mu + gW_{3R}^\mu) W_{R\mu}^+ \\
& -g [\delta_L^+ \delta_L^{--}] (2g'B^\mu + gW_{3L}^\mu) W_{L\mu}^+ + h.c. . \quad (142)
\end{aligned}$$

The 132 couplings among two gauge bosons and two scalars, one neutral and one charged, are given by the Lagrangian

$$\begin{aligned}
& \frac{g^2}{\sqrt{2}} [\phi_1^- \phi_2^0 - \phi_2^- \phi_1^{0*}] W_{3R}^\mu W_{L\mu}^+ + \frac{g^2}{\sqrt{2}} [\phi_2^- \phi_2^{0*} - \phi_1^- \phi_1^0] W_{3L}^\mu W_{R\mu}^+ \\
& + g [\delta_R^- \delta_R^0] (2g'B^\mu - gW_{3R}^\mu) W_{R\mu}^+ + g [\delta_L^- \delta_L^0] (2g'B^\mu - gW_{3L}^\mu) W_{L\mu}^+ \\
& - g^2 [\delta_R^{--} \delta_R^0] W_R^{+\mu} W_{R\mu}^+ - g^2 [\delta_L^{--} \delta_L^0] W_L^{+\mu} W_{L\mu}^+ + h.c. . \quad (143)
\end{aligned}$$

Finally, there are 75 couplings among two gauge bosons and two neutral scalars. They are described by the Lagrangian

$$\begin{aligned}
& \frac{g^2}{4} [\phi_1^0 \phi_1^{0*} + \phi_2^0 \phi_2^{0*}] (W_{3L\mu} - W_{3R\mu}) (W_{3L}^\mu - W_{3R}^\mu) + [\delta_R^0 \delta_R^{0*}] (gW_{3R\mu} - g'B_\mu) (gW_{3R}^\mu - g'B^\mu) \\
& + [\delta_L^0 \delta_L^{0*}] (gW_{3L\mu} - g'B_\mu) (gW_{3L}^\mu - g'B^\mu) + g^2 [\delta_L^0 \delta_L^{0*}] W_{L\mu}^+ W_L^{-\mu} \\
& + g^2 [\delta_R^0 \delta_R^{0*}] W_{R\mu}^+ W_R^{-\mu} - g^2 [\phi_1^0 \phi_2^{0*}] W_{L\mu}^- W_R^{+\mu} - g^2 [\phi_1^{0*} \phi_2^0] W_{L\mu}^+ W_R^{-\mu}. \quad (144)
\end{aligned}$$

From the structure of this Lagrangian it is easy to see that the photon does not take part in this interaction. From charge conjugation invariance it follows that only couplings among two gauge particles and two scalars with the same C parities appear. For this reason all couplings of the type  $H_i^0 A_j^0 Z_k Z_l$  or  $H_i^0 \tilde{G}_j^0 W_k^+ W_l^-$  vanish.

#### 2.2.2.5 Interaction among scalar bosons.

From the Higgs potential Eq.(25) we can find all couplings among Higgs and Goldstone bosons. The number of different couplings is very large. However, in the one loop approximation for processes with light external fermions and gauge bosons only, the knowledge of scalar particle interactions is useless. So we will not present them here. This means that we also do not renormalize the parameters in the Higgs potential.

## III Quantization of the left-right symmetric model.

The canonical quantization of any gauge theory is not straightforward. For such theories the Lagrangian is singular and canonical conjugate momenta do not exist. Then, it is impossible to define the Hamiltonian of the system. The second problem is connected with the fact that gauge fields, described by four vectors, have only two degrees of freedom. Their fields must satisfy additional conditions which disagree with the commutation relations. Finally, gauge particle equations of motion are not reversible which causes problems with the definition of their propagators. All these problems have been solved many years ago, first for abelian gauge theories. In the fifties, the so called gauge fixing condition was introduced [66] and later the auxiliary hermitian scalar fields  $B(x)$  were invented [67]. For non-abelian gauge theories the same procedure as for quantum electrodynamics can not be applied. Feynman has shown [68] in 1963 that the physical S-matrix is not unitary. Contrary to the abelian case, contributions from the unphysical longitudinal and scalar modes of gauge bosons to intermediate states do not cancel out. Feynman [68] and later De Witt [69] found that the violation of unitarity can be eliminated by introducing the missing contribution to loops from some massless scalar fermions. A clear-cut explanation why such fictitious particles have to appear was given by Faddeev and Popov [70] from the viewpoint of path-integral formalism. Since then these fermions with strange statistics are called Faddeev-Popov ghosts. The very important point in proving the consistency of the theory (for quantization and also for renormalization) are relations among Green functions which follow from gauge invariance of the theory. Such relations are known as Ward-Takahashi [71] for abelian theory and Slavnov-Taylor [72] identities in non abelian case. Later it was shown [73] that the full Lagrangian of gauge theory, after adding the gauge fixing and Faddeev-Popov terms, still possesses some global symmetry. This symmetry is a remnant of local gauge invariance and is known as BRST symmetry [73]. In the same time it was proved that all Slavnov-Taylor identities can be found from the BRST invariance of the full Lagrangian [74]. There are two different popular approaches to constructing the quantum theory of gauge fields. The first, very fashionable approach bases on the path integral formalism. Almost

all textbooks on the non-abelian gauge theory are based on this approach [75]. The second one is well known from QED, the canonical quantization formalism. In the context of non-abelian gauge theories it was introduced by Kugo and Ojima [76] and is known as operator formalism [77]. Here this approach is adopted. The left-right model is the gauge theory with spontaneous symmetry breaking. To define the gauge fixing Lagrangian we have to remember that as remnant of SSB some bilinear terms appear (Eq.(135)). In the next Chapter the gauge fixing Lagrangian is introduced. The ghost particles, BRST transformations and the Faddeev - Popov Lagrangian of the theory are considered in Chapter 3.2.

### 3.1 THE GAUGE FIXING LAGRANGIAN.

It was mentioned in section 2.2.2.4 that bilinear terms with gauge and Higgs particles in  $L_{bilinear}$  (Eq.(133)) complicate the Higgs particles propagators. They can be canceled by an appropriate choice of the gauge fixing Lagrangian ( $L_{GF}$ ). Using the equations (37) and (38) for gauge bosons and Eq.(74) for Higgs and Goldstone particles the  $L_{bilinear}$  can be expressed in the form

$$\begin{aligned}
L_{bilinear} = & Z_{1\mu} \left\{ -\frac{g\kappa_+}{2 \cos \Theta_W} \left( \cos \phi + \sqrt{\cos 2\Theta_W} \sin \phi \right) \partial^\mu \tilde{G}_1^0 + \cot \Theta_W (-v_R g' \sin \phi) \partial^\mu \tilde{G}_2^0 \right\} \\
& + Z_{2\mu} \left\{ -\frac{g\kappa_+}{2 \cos \Theta_W} \left( \sin \phi - \sqrt{\cos 2\Theta_W} \cos \phi \right) \partial^\mu \tilde{G}_1^0 + \cot \Theta_W (v_R g' \cos \phi) \partial^\mu \tilde{G}_2^0 \right\} \\
& + igW_{1\mu}^+ \left\{ \left( \frac{\kappa_+}{2} \cos \xi + \frac{\kappa_1 \kappa_2}{\kappa_+} \sin \xi \right) \partial^\mu G_L^- + \left( \frac{\sqrt{\kappa_-^4 + 2v_R^2 \kappa_+^2}}{2\kappa_+} \sin \xi \right) \partial^\mu G_R^- \right\} + h.c. \\
& + igW_{2\mu}^+ \left\{ \left( \frac{\kappa_+}{2} \sin \xi - \frac{\kappa_1 \kappa_2}{\kappa_+} \cos \xi \right) \partial^\mu G_L^- + \left( -\frac{\sqrt{\kappa_-^4 + 2v_R^2 \kappa_+^2}}{2\kappa_+} \cos \xi \right) \partial^\mu G_R^- \right\} + h.c. .
\end{aligned} \tag{145}$$

Now we can introduce the gauge fixing Lagrangian

$$\begin{aligned}
L_{GF} = & -\frac{1}{\xi_{W_1}} \left| \partial^\mu W_{1\mu}^+ + i\xi_{W_1} M_{W_1} G_1^+ \right|^2 - \frac{1}{\xi_{W_2}} \left| \partial^\mu W_{2\mu}^+ + i\xi_{W_2} M_{W_2} G_2^+ \right|^2 \\
& - \frac{1}{2\xi_{Z_1}} \left( \partial^\mu Z_{1\mu} - \xi_{Z_1} M_{Z_1} G_1^0 \right)^2 - \frac{1}{2\xi_{Z_2}} \left( \partial^\mu Z_{2\mu} - \xi_{Z_2} M_{Z_2} G_2^0 \right)^2 - \frac{1}{2\xi_A} \left( \partial^\mu A_\mu \right)^2 .
\end{aligned} \tag{146}$$

It is easy to check that the following terms which are present in Eq.(146)

$$\begin{aligned}
& iM_{W_1} \left[ \left( \partial^\mu W_{1\mu}^+ \right) G_1^- \right] + iM_{W_2} \left[ \left( \partial^\mu W_{2\mu}^+ \right) G_2^- \right] + h.c. \\
& + M_{Z_1} \left[ \left( \partial^\mu Z_{1\mu} \right) G_1^0 \right] + M_{Z_2} \left[ \left( \partial^\mu Z_{2\mu} \right) G_2^0 \right]
\end{aligned} \tag{147}$$

cancel  $L_{bilinear}$  in Eq.(145) if the following Goldstone particles transformations are made

$$\begin{pmatrix} G_1^\pm \\ G_2^\pm \end{pmatrix} \equiv \begin{pmatrix} \cos \psi_c & -\sin \psi_c \\ \sin \psi_c & \cos \psi_c \end{pmatrix} \begin{pmatrix} G_R^\pm \\ G_L^\pm \end{pmatrix}, \tag{148}$$

$$\begin{aligned}\cos \psi_c &= \frac{g}{2M_{W_1} \kappa_+} \sqrt{\kappa_-^2 + 2v_R^2 \kappa_+^2} \sin \xi, \\ \sin \psi_c &= -\frac{g}{2M_{W_1} \kappa_+} (\kappa_+^2 \cos \xi + 2\kappa_1 \kappa_2 \sin \xi),\end{aligned}\quad (149)$$

and analogously in the neutral sector

$$\begin{pmatrix} G_1^o \\ G_2^o \end{pmatrix} \equiv \begin{pmatrix} \cos \psi_n & \sin \psi_n \\ \sin \psi_n & -\cos \psi_n \end{pmatrix} \begin{pmatrix} \tilde{G}_1^o \\ \tilde{G}_2^o \end{pmatrix}, \quad (150)$$

$$\begin{aligned}\cos \psi_n &= -\frac{g\kappa_+}{2M_{Z_1} \cos \Theta_W} \left( \cos \phi + \sqrt{\cos 2\Theta_W} \sin \phi \right), \\ \sin \psi_n &= -\frac{1}{M_{Z_1}} \cot \Theta_W v_R g' \sin \phi.\end{aligned}\quad (151)$$

Adding  $L_{GF}$  (Eq.(146)),  $L_{bilinear}$  (Eq.(145)) and  $L_{GB}^{kin}$  (Eq.(132)) one gets

$$\begin{aligned}L_{GF} + L_{bilinear} + L_{GB}^{kin} &= -\frac{1}{\xi_{W_1}} |\partial^\mu W_{1\mu}^+|^2 - \frac{1}{\xi_{W_2}} |\partial^\mu W_{2\mu}^+|^2 - \frac{1}{2\xi_{Z_1}} (\partial^\mu Z_{1\mu})^2 - \frac{1}{2\xi_{Z_2}} (\partial^\mu Z_{2\mu})^2 \\ &+ (\partial^\mu G_1^+) (\partial_\mu G_1^-) - \xi_{W_1} M_{W_1}^2 G_1^+ G_1^- + (\partial^\mu G_2^+) (\partial_\mu G_2^-) - \xi_{W_2} M_{W_2}^2 G_2^+ G_2^- \\ &+ \frac{1}{2} (\partial^\mu G_1^0) (\partial_\mu G_1^0) - \frac{1}{2} \xi_{Z_1} M_{Z_1}^2 (G_1^0)^2 + \frac{1}{2} (\partial^\mu G_2^0) (\partial_\mu G_2^0) \\ &- \frac{1}{2} \xi_{Z_2} M_{Z_2}^2 (G_2^0)^2.\end{aligned}\quad (152)$$

The gauge boson part from Eq.(152) together with Eq.(10) and Eq.(34) give the kinetic energy Lagrangian for the physical gauge bosons

$$\begin{aligned}& -\frac{1}{2} F_{1\mu\nu}^+ F_1^{-\mu\nu} + M_{W_1}^2 W_{1\mu}^+ W_1^{-\mu} - \frac{1}{\xi_{W_1}} |\partial^\mu W_{1\mu}^+|^2 \\ & -\frac{1}{2} F_{2\mu\nu}^+ F_2^{-\mu\nu} + M_{W_2}^2 W_{2\mu}^+ W_2^{-\mu} - \frac{1}{\xi_{W_2}} |\partial^\mu W_{2\mu}^+|^2 \\ & -\frac{1}{4} F_{1\mu\nu} F_1^{\mu\nu} + \frac{1}{2} M_{Z_1}^2 Z_{1\mu} Z_1^\mu - \frac{1}{2\xi_{Z_1}} (\partial^\mu Z_{1\mu})^2 \\ & -\frac{1}{4} F_{2\mu\nu} F_2^{\mu\nu} + \frac{1}{2} M_{Z_2}^2 Z_{2\mu} Z_2^\mu - \frac{1}{2\xi_{Z_2}} (\partial^\mu Z_{2\mu})^2 \\ & -\frac{1}{4} F_{\mu\nu} F^{\mu\nu} - \frac{1}{2\xi_A} (\partial^\mu A_\mu)^2.\end{aligned}\quad (153)$$

From Eq.(153) the propagators for gauge bosons are obtained

$$i\Delta^{\mu\nu}(p) = \frac{i}{p^2 - M_i^2 + i\epsilon} \left[ -g^{\mu\nu} + (1 - \xi_i) \frac{p^\mu p^\nu}{p^2 - \xi_i M_i^2} \right], \quad (154)$$

where

$$M_i = \begin{cases} M_{W_{1,2}} & \text{for } W_{1,2}^\pm \\ M_{Z_{1,2}} & \text{for } Z_{1,2} \\ 0 & \text{for } A \end{cases}, \quad \xi_i = \begin{cases} \xi_{W_{1,2}} & \text{for } W_{1,2}^\pm \\ \xi_{Z_{1,2}} & \text{for } Z_{1,2} \\ \xi_A & \text{for } A \end{cases}. \quad (155)$$

The second part of Eq.(152) gives the Goldstone bosons propagators

$$i\Delta(p) = \frac{i}{p^2 - \xi_i M_i^2 + i\epsilon}, \quad \text{where } M_i, (\xi_i) = \begin{cases} M_{Z_{1,2}}, (\xi_{Z_{1,2}}) & \text{for } G_{1,2}^0 \\ M_{W_{1,2}}, (\xi_{W_{1,2}}) & \text{for } G_{1,2}^\pm \end{cases}. \quad (156)$$

### 3.2 THE GHOST PARTICLES, BRST TRANSFORMATIONS AND FADDEEV - POPOV LAGRANGIAN.

To avoid the violation of unitarity ghost particles must be introduced to the model. This is achieved by imposing infinitesimal gauge transformations for gauge and Higgs fields where instead of the gauge parameter we put the product  $\lambda c$ . The  $\lambda$  parameter is a Grassman number which commutes with all gauge bosons as well as with Higgs particles but anticommutes with the ghost fields "c"

$$\lambda^2 = 0, \quad \{\lambda, c\} = 0. \quad (157)$$

The BRST transformations for gauge bosons are as follows:

$$\begin{aligned} \delta^{BRST} W_{L,R\mu}^i &= \lambda \left( \partial_\mu c_{L,R}^i + \sum_{e,f=1}^3 g \varepsilon^{ief} W_{L,R\mu}^e c_{L,R}^f \right), \\ \delta^{BRST} B_\mu &= \lambda (\partial_\mu c^4). \end{aligned} \quad (158)$$

From Eq.(158) one obtains (we define  $\tilde{\delta}^{BRST} \equiv \frac{\delta^{BRST}}{\lambda}$ ):

$$\begin{aligned} \tilde{\delta}^{BRST} W_{L,R}^{3\mu} &= \partial^\mu c_{L,R}^3 + g(W_{L,R}^{1\mu} c_{L,R}^2 - W_{L,R}^{2\mu} c_{L,R}^1), \\ \tilde{\delta}^{BRST} W_{L,R}^{1,2\mu} &= \partial^\mu c_{L,R}^{1,2} + g(W_{L,R}^{2,3\mu} c_{L,R}^{3,1} - W_{L,R}^{3,1\mu} c_{L,R}^{2,3}), \\ \tilde{\delta}^{BRST} B^\mu &= \partial^\mu c^4. \end{aligned} \quad (159)$$

The ghost particles  $c_{L,R}^1, c_{L,R}^2, c_{L,R}^3, c^4$  anticommute with each other and commute with all remaining fields. According to Eqs.(13,17) there are the following BRST transformations for scalar fields:

$$\begin{aligned} \tilde{\delta}^{BRST} \phi &= -ig_R c_R^a \phi \frac{\tau_a}{2} + ig_L c_L^a \frac{\tau_a}{2} \phi \quad a = 1, 2, 3, \\ \tilde{\delta}^{BRST} \Delta_{R,L} &= \frac{ig_R}{2} c_{R,L}^a (\tau_a \Delta_{R,L} + \Delta_{R,L} \tau_a) + ig' c^4 \Delta_{R,L}, \quad a = 1, 2, 3, \end{aligned} \quad (160)$$

explicitly

$$\begin{aligned} \tilde{\delta}^{BRST} \phi_1^0 &= -\frac{ig}{2} (\sqrt{2} c_R^- \phi_1^+ + c_R^3 \phi_1^0 - \sqrt{2} c_L^+ \phi_2^- - c_L^3 \phi_1^0), \\ \tilde{\delta}^{BRST} \phi_1^+ &= -\frac{ig}{2} (\sqrt{2} c_R^+ \phi_1^0 - c_R^3 \phi_1^+ - \sqrt{2} c_L^+ \phi_2^0 - c_L^3 \phi_1^+), \\ \tilde{\delta}^{BRST} \phi_2^- &= -\frac{ig}{2} (\sqrt{2} c_R^- \phi_2^0 + c_R^3 \phi_2^- - \sqrt{2} c_L^- \phi_1^0 + c_L^3 \phi_2^-), \\ \tilde{\delta}^{BRST} \phi_2^0 &= -\frac{ig}{2} (\sqrt{2} c_R^+ \phi_2^- - c_R^3 \phi_2^0 - \sqrt{2} c_L^- \phi_1^+ + c_L^3 \phi_2^0), \\ \tilde{\delta}^{BRST} \delta_{R,L}^+ &= +ig(\delta_{R,L}^0 c_{R,L}^+ - \delta_{R,L}^{++} c_{R,L}^-) + ig' c^4 \delta_{R,L}^+, \\ \tilde{\delta}^{BRST} \delta_{R,L}^{++} &= -ig(\delta_{R,L}^+ c_{R,L}^+ - \delta_{R,L}^{++} c_{R,L}^3) + ig' c^4 \delta_{R,L}^{++}, \\ \tilde{\delta}^{BRST} \delta_{R,L}^o &= +ig \delta_{R,L}^+ c_{R,L}^- + ig' c^4 \delta_{R,L}^o - ig \delta_{R,L}^o c_{R,L}^3, \end{aligned} \quad (161)$$

where

$$c_{L,R}^{\pm} = \frac{1}{\sqrt{2}}(c_{L,R}^1 \mp ic_{L,R}^2). \quad (162)$$

Let us now rewrite the gauge fixing Lagrangian form Eq.(146) using auxiliary fields "E" (from now we will not distinguish among  $\xi_{Z_{1,2}}$ ,  $\xi_{W_{1,2}}$  and  $\xi_A$  except a case of renormalization of two point functions for unphysical particles):

$$\begin{aligned} L_{GF} = & E_1^- (\partial^\mu W_{1\mu}^+ + C_{1E}^+) + E_1^+ (\partial^\mu W_{1\mu}^- + C_{1E}^-) + \xi E_1^+ E_1^- \\ & + E_2^- (\partial^\mu W_{2\mu}^+ + C_{2E}^+) + E_2^+ (\partial^\mu W_{2\mu}^- + C_{2E}^-) + \xi E_2^+ E_2^- \\ & + E_{Z_1} (\partial^\mu Z_{1\mu} + C_E^{Z_1}) + \frac{\xi}{2} E_{Z_1}^2 + E_{Z_2} (\partial^\mu Z_{2\mu} + C_E^{Z_2}) + \frac{\xi}{2} E_{Z_2}^2 + E_A (\partial^\mu A_\mu) + \frac{\xi}{2} E_A^2, \end{aligned} \quad (163)$$

where

$$\begin{aligned} C_{1E}^+ &= i\xi M_{W_1} G_1^+, \\ C_{2E}^+ &= i\xi M_{W_2} G_2^+, \\ C_E^{Z_1} &= -\xi M_{Z_1} G_1^0, \\ C_E^{Z_2} &= -\xi M_{Z_2} G_2^0. \end{aligned} \quad (164)$$

The Faddeev - Popov Lagrangian ( $L_{FP}$ ) is constructed by requiring that the sum  $L_{GF} + L_{FP}$  is BRST invariant. So, first we have to find the BRST transformation for  $L_{GF}$  (for all auxiliary fields  $\tilde{\delta}^{BRST} E = 0$  is imposed, where  $E = E_{1,2}^{\pm}, E_{Z_{1,2}}, E_A$ ). To do this one has to know:

$$\begin{aligned} \tilde{\delta}^{BRST} (\partial^\mu W_{1\mu}^+ + C_{1E}^+) &\equiv D_1^+, \\ \tilde{\delta}^{BRST} (\partial^\mu W_{1\mu}^- + C_{1E}^-) &\equiv D_1^-, \\ \tilde{\delta}^{BRST} (\partial^\mu W_{2\mu}^+ + C_{2E}^+) &\equiv D_2^+, \\ \tilde{\delta}^{BRST} (\partial^\mu W_{2\mu}^- + C_{2E}^-) &\equiv D_2^-, \\ \tilde{\delta}^{BRST} (\partial^\mu Z_{1\mu} + C_E^{Z_1}) &\equiv D_{Z_1}, \\ \tilde{\delta}^{BRST} (\partial^\mu Z_{2\mu} + C_E^{Z_2}) &\equiv D_{Z_2}, \\ \tilde{\delta}^{BRST} \partial^\mu A_\mu &\equiv D_A. \end{aligned} \quad (165)$$

To calculate BRST transformations in Eq.(165) the  $\tilde{\delta}^{BRST} W_{1,2\mu}^{\pm}$ ,  $\tilde{\delta}^{BRST} Z_{1,2\mu}$ ,  $\tilde{\delta}^{BRST} A_\mu$ ,  $\tilde{\delta}^{BRST} G_{1,2}^{\pm}$  and  $\tilde{\delta}^{BRST} G_{1,2}^0$  are necessary. The BRST transformations for the physical gauge particles are obtained from Eq.(159) using Eqs.(37,38) for gauge bosons as well as for ghost particles, i.e.:

$$\begin{pmatrix} c_L^{\pm} \\ c_R^{\pm} \end{pmatrix} = \begin{pmatrix} \cos\xi & \sin\xi \\ -\sin\xi & \cos\xi \end{pmatrix} \begin{pmatrix} c_1^{\pm} \\ c_2^{\pm} \end{pmatrix}, \quad (166)$$

$$\begin{pmatrix} c_L^3 \\ c_R^3 \\ c^4 \end{pmatrix} = \begin{pmatrix} x_1 & x_2 & x_3 \\ y_1 & y_2 & y_3 \\ v_1 & v_2 & v_3 \end{pmatrix} \begin{pmatrix} c_1 \\ c_2 \\ c_0 \end{pmatrix}. \quad (167)$$

The explicit form of the BRST transformations for gauge particles is presented below:

$$\begin{aligned}\tilde{\delta}^{BRST} W_{1\mu}^{\pm} &= \partial_{\mu} c_1^{\pm} \pm ie [W_{1\mu}^{\pm} (c_1 f(s_{\xi}, c_{\xi}) + c_2 g(s_{\xi}, c_{\xi}) + c_0) + W_{2\mu}^{\pm} (c_1 h(s_{\phi}, c_{\phi}) + c_2 h(-c_{\phi}, s_{\phi})) \\ &\quad - Z_{1\mu} (c_1^{\pm} f(s_{\xi}, c_{\xi}) + c_2^{\pm} h(s_{\phi}, c_{\phi})) - Z_{2\mu} (c_1^{\pm} g(s_{\xi}, c_{\xi}) + c_2^{\pm} h(-c_{\phi}, s_{\phi})) - A_{\mu} c_1^{\pm}],\end{aligned}\tag{168}$$

$$\begin{aligned}\tilde{\delta}^{BRST} W_{2\mu}^{\pm} &= \partial_{\mu} c_2^{\pm} \pm ie [W_{1\mu}^{\pm} (c_1 h(s_{\phi}, c_{\phi}) + c_2 h(-c_{\phi}, s_{\phi})) + W_{2\mu}^{\pm} (c_1 f(s_{\xi}, c_{\xi}) + c_2 g(s_{\xi}, c_{\xi}) + c_0) \\ &\quad - Z_{1\mu} (c_1^{\pm} h(s_{\phi}, c_{\phi}) + c_2^{\pm} f(s_{\xi}, c_{\xi})) - Z_{2\mu} (c_1^{\pm} h(-c_{\phi}, s_{\phi}) + c_2^{\pm} g(s_{\xi}, c_{\xi})) - A_{\mu} c_2^{\pm}],\end{aligned}\tag{169}$$

$$\begin{aligned}\tilde{\delta}^{BRST} Z_{1\mu} &= \partial_{\mu} c_1 - ie [W_{1\mu}^{+} (c_1^{-} f_1(s_{\xi}, c_{\xi}) + c_2^{-} h_1(s_{\phi}, c_{\phi})) - W_{1\mu}^{-} (c_1^{+} f_1(s_{\xi}, c_{\xi}) + c_2^{+} h_1(s_{\phi}, c_{\phi})) \\ &\quad + W_{2\mu}^{+} (c_1^{-} h_1(s_{\phi}, c_{\phi}) + c_2^{-} f_1(c_{\xi}, s_{\xi})) - W_{2\mu}^{-} (c_1^{+} h_1(s_{\phi}, c_{\phi}) + c_2^{+} f_1(c_{\xi}, s_{\xi}))],\end{aligned}\tag{170}$$

$$\begin{aligned}\tilde{\delta}^{BRST} Z_{2\mu} &= \partial_{\mu} c_2 - ie [W_{1\mu}^{+} (c_1^{-} g(s_{\xi}, c_{\xi}) + c_2^{-} h(-c_{\phi}, s_{\phi})) - W_{1\mu}^{-} (c_1^{+} g(s_{\xi}, c_{\xi}) + c_2^{+} h(-c_{\phi}, s_{\phi})) \\ &\quad + W_{2\mu}^{+} (c_1^{-} h(-c_{\phi}, s_{\phi}) + c_2^{-} g(c_{\xi}, s_{\xi})) - W_{2\mu}^{-} (c_1^{+} h(-c_{\phi}, s_{\phi}) + c_2^{+} g(c_{\xi}, s_{\xi}))],\end{aligned}\tag{171}$$

and

$$\tilde{\delta}^{BRST} A_{\mu} = \partial_{\mu} c_0 - ie (W_{1\mu}^{+} c_1^{-} - W_{1\mu}^{-} c_1^{+} + W_{2\mu}^{+} c_2^{-} - W_{2\mu}^{-} c_2^{+}),\tag{172}$$

with the following definitions of the  $f(s_{\xi}, c_{\xi})$ ,  $f_1(s_{\xi}, c_{\xi})$ ,  $g(s_{\xi}, c_{\xi})$ ,  $g_2(s_{\xi}, c_{\xi})$ ,  $h(s_{\phi}, c_{\phi})$ ,  $h_1(s_{\phi}, c_{\phi})$ ,  $h(-c_{\phi}, c_{\phi})$  functions:

$$\begin{aligned}f(s_{\xi}, c_{\xi}) &= \cos^2 \xi \cot \Theta_W \cos \phi - \sin^2 \xi \tan \Theta_W \cos \phi - \sin^2 \xi \frac{\sqrt{\cos 2\Theta_W}}{\sin \Theta_W \cos \Theta_W} \sin \phi, \\ f_1(s_{\xi}, c_{\xi}) &= \cos^2 \xi \cot \Theta_W \cos \phi + \sin^2 \xi \tan \Theta_W \cos \phi + \sin^2 \xi \frac{\sqrt{\cos 2\Theta_W}}{\sin \Theta_W \cos \Theta_W} \sin \phi, \\ g(s_{\xi}, c_{\xi}) &= \cos^2 \xi \cot \Theta_W \sin \phi - \sin^2 \xi \tan \Theta_W \sin \phi + \sin^2 \xi \frac{\sqrt{\cos 2\Theta_W}}{\sin \Theta_W \cos \Theta_W} \cos \phi, \\ h(s_{\phi}, c_{\phi}) &= \sin \xi \cos \xi \left( \cot \Theta_W \cos \phi + \tan \Theta_W \cos \phi + \frac{\sqrt{\cos \Theta_W}}{\sin \Theta_W \cos \Theta_W} \sin \phi \right), \\ h_1(s_{\phi}, c_{\phi}) &= \sin \xi \cos \xi \left( \cot \Theta_W \cos \phi - \tan \Theta_W \cos \phi - \frac{\sqrt{\cos \Theta_W}}{\sin \Theta_W \cos \Theta_W} \sin \phi \right), \\ h(-c_{\phi}, s_{\phi}) &= \sin \xi \cos \xi \left( \cot \Theta_W \sin \phi + \tan \Theta_W \sin \phi - \frac{\sqrt{\cos \Theta_W}}{\sin \Theta_W \cos \Theta_W} \cos \phi \right).\end{aligned}\tag{173}$$

The BRST transformations for Goldstone particles are obtained from Eq.(161) :

$$\begin{aligned}
\tilde{\delta}^{BRST} \tilde{G}_1^0 = & \frac{e}{\sqrt{2}\kappa_+} \left\{ \kappa_2 \left[ \left( c_1 \tilde{h}(s_\phi, c_\phi) + c_2 \tilde{h}(-c_\phi, s_\phi) \right) (\phi_2^{0*} + \phi_2^0) \right. \right. \\
& - \frac{1}{\sqrt{2} \sin \Theta_W} (\cos \xi (c_1^+ \phi_1^- + c_1^- \phi_1^+) + \sin \xi (c_2^+ \phi_1^- + c_2^- \phi_1^+)) \\
& \left. \left. + \frac{1}{\sqrt{2} \sin \Theta_W} (-\sin \xi (c_1^- \phi_2^+ + c_1^+ \phi_2^-) + \cos \xi (c_2^- \phi_2^+ + c_2^+ \phi_2^-)) \right] \right. \\
& - \kappa_1 \left[ \left( -c_1 \tilde{h}(s_\phi, c_\phi) + c_2 \tilde{h}(-c_\phi, s_\phi) \right) (\phi_1^{0*} + \phi_1^0) \right. \\
& - \frac{1}{\sqrt{2} \sin \Theta_W} (\cos \xi (c_1^- \phi_2^+ + c_1^+ \phi_2^-) + \sin \xi (c_2^- \phi_2^+ + c_2^+ \phi_2^-)) \\
& \left. \left. + \frac{1}{\sqrt{2} \sin \Theta_W} (-\sin \xi (c_1^- \phi_1^+ + c_1^+ \phi_1^-) + \cos \xi (c_2^- \phi_1^+ + c_2^+ \phi_1^-)) \right] \right\}, \tag{174}
\end{aligned}$$

$$\begin{aligned}
\tilde{\delta}^{BRST} \tilde{G}_2^0 = & -\frac{e}{\sqrt{2}} \left\{ \frac{\sin \xi}{\sin \Theta_W} (c_1^+ \delta_R^- + c_1^- \delta_R^+) - \frac{\cos \xi}{\sin \Theta_W} (c_2^+ \delta_R^- + c_2^- \delta_R^+) \right. \\
& \left. - c_1 \left( \frac{\cot \Theta_W}{\sqrt{\cos 2\Theta_W}} \sin \phi \right) (\delta_R^{0*} + \delta_R^0) + c_2 \left( \frac{\cot \Theta_W}{\sqrt{\cos 2\Theta_W}} \cos \phi \right) (\delta_R^{0*} + \delta_R^0) \right\}, \tag{175}
\end{aligned}$$

and

$$\begin{aligned}
\tilde{\delta}^{BRST} G_1^0 &= \cos \psi_n \tilde{\delta}^{BRST} \tilde{G}_1^0 + \sin \psi_n \tilde{\delta}^{BRST} \tilde{G}_2^0, \\
\tilde{\delta}^{BRST} G_2^0 &= \sin \psi_n \tilde{\delta}^{BRST} \tilde{G}_1^0 - \cos \psi_n \tilde{\delta}^{BRST} \tilde{G}_2^0, \tag{176}
\end{aligned}$$

$$\begin{aligned}
\tilde{\delta}^{BRST} G_1^+ = & ie \left\{ (\cos \psi_c a_{1R} - \sin \psi_c a_{1L}) \left[ \sqrt{\cos 2\Theta_W} \left( -c_1 \tilde{h}(-c_\phi, s_\phi) + c_2 \tilde{h}(s_\phi, c_\phi) + c_0 \right) \phi_1^+ \right. \right. \\
& + \frac{1}{\sqrt{2} \sin \Theta_W} (\cos \xi c_1^+ + \sin \xi c_2^+) \phi_2^0 - \frac{1}{\sqrt{2} \sin \Theta_W} (-\sin \xi c_1^+ + \cos \xi c_2^+) \phi_1^0 \left. \right] \\
& + (\cos \psi_c a_{2R} - \sin \psi_c a_{2L}) \left[ \sqrt{\cos 2\Theta_W} \left( -c_1 \tilde{h}(-c_\phi, s_\phi) + c_2 \tilde{h}(s_\phi, c_\phi) + c_0 \right) \phi_2^+ \right. \\
& - \frac{1}{\sqrt{2} \sin \Theta_W} (\cos \xi c_1^+ + \sin \xi c_2^+) \phi_1^{0*} + \frac{1}{\sqrt{2} \sin \Theta_W} (-\sin \xi c_1^+ + \cos \xi c_2^+) \phi_2^{0*} \left. \right] \\
& + (\cos \psi_c a_{RR}) \left[ \left( -\frac{\sin \xi}{\sin \Theta_W} c_1^+ + \frac{\cos \xi}{\sin \Theta_W} c_2^+ \right) \delta_R^0 - \left( -\frac{\sin \xi}{\sin \Theta_W} c_1^- + \frac{\cos \xi}{\sin \Theta_W} c_2^- \right) \delta_R^{++} \right. \\
& + \left( -\tan \Theta_W \cos \phi + \frac{\sin \Theta_W}{\cos \Theta_W \sqrt{\cos 2\Theta_W}} \sin \phi \right) c_1 \delta_R^+ \\
& \left. \left. + \left( -\tan \Theta_W \sin \phi - \frac{\sin \Theta_W}{\cos \Theta_W \sqrt{\cos 2\Theta_W}} \cos \phi \right) c_2 \delta_R^+ + c_0 \delta_R^+ \right] \right\}, \tag{177}
\end{aligned}$$

$$\begin{aligned}
\tilde{\delta}^{BRST} G_2^+ = & ie \left\{ (\sin \psi_c a_{1R} + \cos \psi_c a_{1L}) \left[ \sqrt{\cos 2\Theta_W} \left( -c_1 \tilde{h}(-c_\phi, s_\phi) + c_2 \tilde{h}(s_\phi, c_\phi) + c_0 \right) \phi_1^+ \right. \right. \\
& + \frac{1}{\sqrt{2} \sin \Theta_W} (\cos \xi c_1^+ + \sin \xi c_2^+) \phi_2^0 - \frac{1}{\sqrt{2} \sin \Theta_W} (-\sin \xi c_1^+ + \cos \xi c_2^+) \phi_1^0 \left. \right] \\
& \left. \left. + \left( -\tan \Theta_W \cos \phi + \frac{\sin \Theta_W}{\cos \Theta_W \sqrt{\cos 2\Theta_W}} \sin \phi \right) c_1 \delta_R^+ \right. \right. \\
& \left. \left. + \left( -\tan \Theta_W \sin \phi - \frac{\sin \Theta_W}{\cos \Theta_W \sqrt{\cos 2\Theta_W}} \cos \phi \right) c_2 \delta_R^+ + c_0 \delta_R^+ \right] \right\},
\end{aligned}$$



$$\begin{aligned}
& + (\sin \psi_c a_{2R} + \cos \psi_c a_{2L}) \left[ \sqrt{\cos 2\Theta_W} \left( -c_1 \tilde{h}(-c_\phi, s_\phi) + c_2 \tilde{h}(s_\phi, c_\phi) + c_0 \right) \phi_2^+ \right. \\
& - \left. \frac{1}{\sqrt{2} \sin \Theta_W} (\cos \xi c_1^+ + \sin \xi c_2^+) \phi_1^{0*} + \frac{1}{\sqrt{2} \sin \Theta_W} (-\sin \xi c_1^+ + \cos \xi c_2^+) \phi_2^{0*} \right] \\
& + (\sin \psi_c a_{RR}) \left[ \left( -\frac{\sin \xi}{\sin \Theta_W} c_1^+ + \frac{\cos \xi}{\sin \Theta_W} c_2^+ \right) \delta_R^0 - \left( -\frac{\sin \xi}{\sin \Theta_W} c_1^- + \frac{\cos \xi}{\sin \Theta_W} c_2^- \right) \delta_R^{++} \right. \\
& + \left( -\tan \Theta_W \cos \phi + \frac{\sin \Theta_W}{\cos \Theta_W \sqrt{\cos 2\Theta_W}} \sin \phi \right) c_1 \delta_R^+ \\
& \left. + \left( -\tan \Theta_W \sin \phi - \frac{\sin \Theta_W}{\cos \Theta_W \sqrt{\cos 2\Theta_W}} \cos \phi \right) c_2 \delta_R^+ + c_0 \delta_R^+ \right] \Big\}, \tag{178}
\end{aligned}$$

where

$$\tilde{h}(-c_\phi, s_\phi) = \frac{h(-c_\phi, s_\phi)}{2 \sin \xi \sin \xi}, \quad \tilde{h}(s_\phi, c_\phi) = \frac{h(s_\phi, c_\phi)}{2 \sin \xi \sin \xi}. \tag{179}$$

Introducing "bar" fields for each ghost particle with the BRST transformations:

$$\begin{aligned}
\tilde{\delta}^{BRST} \bar{c}_1^\pm &= \pm i E_1^\pm, \\
\tilde{\delta}^{BRST} \bar{c}_2^\pm &= \pm i E_2^\pm, \\
\tilde{\delta}^{BRST} \bar{c}_1 &= i E_{Z_1}, \\
\tilde{\delta}^{BRST} \bar{c}_2 &= i E_{Z_2}, \\
\tilde{\delta}^{BRST} \bar{c}_0 &= i E_A,
\end{aligned} \tag{180}$$

we can construct the Faddeev - Popov Lagrangian in the form

$$L_{FP} = i \bar{c}_1^+ D_1^- + i \bar{c}_1^- D_1^+ + i \bar{c}_2^+ D_2^- + i \bar{c}_2^- D_2^+ + i \bar{c}_1 D_{Z_1} + i \bar{c}_2 D_{Z_2} + i \bar{c}_0 D_A. \tag{181}$$

If we define BRST transformations for ghost particles in the following way:

$$\begin{aligned}
\delta^{BRST} c_{L,R}^1 &= -\lambda g c_{L,R}^2 c_{L,R}^3, \\
\delta^{BRST} c_{L,R}^2 &= -\lambda g c_{L,R}^3 c_{L,R}^1, \\
\delta^{BRST} c_{L,R}^3 &= -\lambda g c_{L,R}^1 c_{L,R}^2, \\
\delta^{BRST} c^4 &= 0,
\end{aligned} \tag{182}$$

then it is easy to check that

$$\delta^{BRST} [L_{GF} + L_{FP}] = 0. \tag{183}$$

Since the rest of the Lagrangian is gauge invariant, it is also BRST invariant ( the BRST is infinitesimal gauge transformation). The kinetic energy Lagrangian for ghost particles is obtained after the BRST transformations for all fields in Eq.(181)

$$\begin{aligned}
L_{ghost}^{kin} = & -i (\partial_\mu \bar{c}_1^+) (\partial^\mu c_1^-) + i\xi M_{W_1}^2 \bar{c}_1^+ c_1^- - i (\partial_\mu \bar{c}_2^+) (\partial^\mu c_2^-) + i\xi M_{W_2}^2 \bar{c}_2^+ c_2^- + h.c. \\
& -i (\partial_\mu \bar{c}_1) (\partial^\mu c_1) + i\xi M_{Z_1}^2 \bar{c}_1 c_1 - i (\partial_\mu \bar{c}_2) (\partial^\mu c_2) + i\xi M_{Z_2}^2 \bar{c}_2 c_2 - i (\partial_\mu \bar{c}_A) (\partial^\mu c_A).
\end{aligned} \tag{184}$$

According to Eq.(184) the masses of ghost particles are as follows:

$$\begin{aligned}
(M_{c_{1,2}^\pm})^2 &= \xi(M_{W_{1,2}^\pm})^2, \\
(M_{c_{1,2}})^2 &= \xi(M_{Z_{1,2}})^2, \\
M_{c_0} &= 0,
\end{aligned} \tag{185}$$

and the propagators are (it is worth to stress that a -1 factor appears in the numerator)

$$i\Delta_i(p) = \frac{-1}{p^2 - \xi M_i^2 + i\varepsilon}, \quad \text{where } M_i = \begin{cases} M_{W_1} & \text{for } c_1^\pm, \\ M_{W_2} & \text{for } c_2^\pm, \\ M_{Z_1} & \text{for } c_1, \\ M_{Z_2} & \text{for } c_2, \\ 0 & \text{for } c_0. \end{cases} \tag{186}$$

For further use we write down the ghost particles - gauge bosons interactions obtained from Eq.(181)

$$\begin{aligned}
L_{FP}^{GB-GH} = & g \left\{ (x_1 (\partial^\mu \bar{c}_1) + x_2 (\partial^\mu \bar{c}_2) + x_3 (\partial^\mu \bar{c}_0)) \right. \\
& \times [\cos^2 \xi W_{1\mu}^- c_1^+ + \cos \xi \sin \xi W_{1\mu}^- c_2^+ + \cos \xi \sin \xi W_{2\mu}^- c_1^+ + \sin^2 \xi W_{2\mu}^- c_2^+] \\
& + (y_1 (\partial^\mu \bar{c}_1) + y_2 (\partial^\mu \bar{c}_2) + y_3 (\partial^\mu \bar{c}_0)) \\
& \times [\sin^2 \xi W_{1\mu}^- c_1^+ - \cos \xi \sin \xi W_{1\mu}^- c_2^+ - \cos \xi \sin \xi W_{2\mu}^- c_1^+ + \cos^2 \xi W_{2\mu}^- c_2^+] \\
& + [\cos^2 \xi (\partial^\mu \bar{c}_1^-) W_{1\mu}^+ + \cos \xi \sin \xi (\partial^\mu \bar{c}_2^-) W_{1\mu}^+ \\
& + \cos \xi \sin \xi (\partial^\mu \bar{c}_1^-) W_{2\mu}^+ + \sin^2 \xi (\partial^\mu \bar{c}_2^-) W_{2\mu}^+] (x_1 c_1 + x_2 c_2 + x_3 c_0) \\
& + [\sin^2 \xi (\partial^\mu \bar{c}_1^-) W_{1\mu}^+ - \cos \xi \sin \xi (\partial^\mu \bar{c}_2^-) W_{1\mu}^+ \\
& - \cos \xi \sin \xi (\partial^\mu \bar{c}_1^-) W_{2\mu}^+ + \cos^2 \xi (\partial^\mu \bar{c}_2^-) W_{2\mu}^+] (y_1 c_1 + y_2 c_2 + y_3 c_0) \\
& - (x_1 Z_{1\mu} + x_2 Z_{2\mu} + x_3 A_\mu) \\
& \times [\cos^2 \xi (\partial^\mu \bar{c}_1^-) c_1^+ + \cos \xi \sin \xi (\partial^\mu \bar{c}_1^-) c_2^+ + \cos \xi \sin \xi (\partial^\mu \bar{c}_2^-) c_1^+ + \sin^2 \xi (\partial^\mu \bar{c}_2^-) c_2^+] \\
& - (y_1 Z_{1\mu} + y_2 Z_{2\mu} + y_3 A_\mu) \\
& \left. \times [\sin^2 \xi (\partial^\mu \bar{c}_1^-) c_1^+ - \cos \xi \sin \xi (\partial^\mu \bar{c}_1^-) c_2^+ - \cos \xi \sin \xi (\partial^\mu \bar{c}_2^-) c_1^+ + \cos^2 \xi (\partial^\mu \bar{c}_2^-) c_2^+] \right\} \\
& + h.c. .
\end{aligned} \tag{187}$$

In our approach the ghost fields are hermitian, so we have:

$$(c_i^\pm)^\dagger = c_i^\mp, \quad (\bar{c}_i^\pm)^\dagger = \bar{c}_i^\mp, \quad i = 1, 2 \tag{188}$$

for charged ghost, and

$$(c_i)^+ = c_i, \quad (\bar{c}_i)^+ = \bar{c}_i \quad (189)$$

for neutral ghost. The ghosts  $c$  and  $\bar{c}$  anticommute

$$\{c, \bar{c}\} = 0. \quad (190)$$

Using the relations Eqs.(188-190) one can prove the hermicity of all terms in the Lagrangian with ghost particles.

# IV On the mass - shell renormalization of the left - right model.

It has been proved first by 't Hooft that non abelian theories are renormalizable [45]. Further contributions have clarified the structure of gauge theories [72], [78], [79], [80]. In the following sections the full (i.e. all Green functions are claimed to be finite) on - shell renormalization scheme of the left - right symmetric model is presented [81], [82], [83]. First, the definitions of renormalization constants for fields, masses, couplings, mixing angles and mixing matrices are given. Then, in Chapter 4.2.1, the renormalization of tadpoles is considered. In Chapter 4.2.2 the renormalization conditions and counter terms for two - point functions are presented. Finally in Chapter 4.2.3 the renormalization of remaining parameters ( $\cos \varphi$ ,  $\sin \xi$ ,  $\Omega_{L,R}$ ,  $K_{L,R}$ ) is performed.

## 4.1 DEFINITIONS OF THE RENORMALIZATION CONSTANTS.

All quantities written below with (without) suffix 0 denote bare (renormalized) ones. Capital "IJ" (small "ij") indices represent up (down) fermions in the left and right handed doublets. For abbreviation the  $i, j$  indices are used to denote the neutral physical Higgses ( $i = H^0, H_1^0, H_2^0, H_3^0, A_1^0, A_2^0$ ), (e.g.  $Z_{ij}^{\frac{1}{2}}$  in Eq.(213)). Similarly, the single (doubly) charged Higgses  $H_{1,2}^{\pm}$  ( $\delta_{L,R}^{\pm\pm}$ ) without '±' ('±±') prefixes are written (e.g.  $Z_{H_1^+ H_2^+}^{\frac{1}{2}} \equiv Z_{H_1 H_2}^{\frac{1}{2}}$ ,  $Z_{\delta_L^+ \delta_R^+}^{\frac{1}{2}} \equiv Z_{\delta_L \delta_R}^{\frac{1}{2}}$ ).

### 4.1.1 Definitions of the renormalization constants for fields.

i) Charged gauge bosons, charged Nambu-Goldstone bosons and ghost particles:

$$\begin{pmatrix} \circ^{\pm} \\ W_{1\mu} \\ \circ^{\pm} \\ W_{2\mu} \end{pmatrix} = \begin{pmatrix} Z_{W_1 W_1}^{\frac{1}{2}} & Z_{W_1 W_2}^{\frac{1}{2}} \\ Z_{W_2 W_1}^{\frac{1}{2}} & Z_{W_2 W_2}^{\frac{1}{2}} \end{pmatrix} \begin{pmatrix} W_{1\mu}^{\pm} \\ W_{2\mu}^{\pm} \end{pmatrix}, \quad (191)$$

$$\begin{pmatrix} \circ^{\pm} \\ G_1 \\ \circ^{\pm} \\ G_2 \end{pmatrix} = \begin{pmatrix} (Z_G^{\pm})_{11} & (Z_G^{\pm})_{12} \\ (Z_G^{\pm})_{12} & (Z_G^{\pm})_{22} \end{pmatrix} \begin{pmatrix} G_1^{\pm} \\ G_2^{\pm} \end{pmatrix}, \quad (192)$$

$$\begin{pmatrix} \circ^{\pm} \\ c_1 \\ \circ^{\pm} \\ c_2 \end{pmatrix} = \begin{pmatrix} \tilde{Z}_{W_1 W_1}^{\frac{1}{2}} & \tilde{Z}_{W_1 W_2}^{\frac{1}{2}} \\ \tilde{Z}_{W_2 W_1}^{\frac{1}{2}} & \tilde{Z}_{W_2 W_2}^{\frac{1}{2}} \end{pmatrix} \begin{pmatrix} c_1^{\pm} \\ c_2^{\pm} \end{pmatrix}, \quad (193)$$

$$\overset{\circ}{c}_{1,2}^{\pm} = \bar{c}_{1,2}^{\pm}, \quad (194)$$

where the renormalization constants from Eqs.(191,193) are given by:

$$Z_{W_i W_j}^{\frac{1}{2}} = \delta_{ij} + \delta Z_{W_i W_j}^{\frac{1}{2}}, \quad (Z_G^{\pm})_{ij} = \delta_{ij} + \delta (Z_G^{\pm})_{ij}, \quad \tilde{Z}_{W_i W_j}^{\frac{1}{2}} = \delta_{ij} + \delta \tilde{Z}_{W_i W_j}^{\frac{1}{2}}. \quad (195)$$

ii) Neutral gauge bosons, neutral Nambu-Goldstone bosons and ghost particles:

$$\begin{pmatrix} \overset{\circ}{Z}_{1\mu} \\ \overset{\circ}{Z}_{2\mu} \\ \overset{\circ}{A}_\mu \end{pmatrix} = \begin{pmatrix} Z_{Z_1 Z_1}^{\frac{1}{2}} & Z_{Z_1 Z_2}^{\frac{1}{2}} & Z_{Z_1 A}^{\frac{1}{2}} \\ Z_{Z_2 Z_1}^{\frac{1}{2}} & Z_{Z_2 Z_2}^{\frac{1}{2}} & Z_{Z_2 A}^{\frac{1}{2}} \\ Z_{AZ_1}^{\frac{1}{2}} & Z_{AZ_2}^{\frac{1}{2}} & Z_{AA}^{\frac{1}{2}} \end{pmatrix} \begin{pmatrix} Z_{1\mu} \\ Z_{2\mu} \\ A_\mu \end{pmatrix}, \quad (196)$$

$$\begin{pmatrix} \overset{\circ}{G}_1^0 \\ \overset{\circ}{G}_2^0 \end{pmatrix} = \begin{pmatrix} (Z_G^0)_{11} & (Z_G^0)_{12} \\ (Z_G^0)_{12} & (Z_G^0)_{22} \end{pmatrix} \begin{pmatrix} G_1^0 \\ G_2^0 \end{pmatrix}, \quad (197)$$

$$\begin{pmatrix} \overset{\circ}{c}_1 \\ \overset{\circ}{c}_2 \\ \overset{\circ}{c}_0 \end{pmatrix} = \begin{pmatrix} \tilde{Z}_{Z_1 Z_1}^{\frac{1}{2}} & \tilde{Z}_{Z_1 Z_2}^{\frac{1}{2}} & \tilde{Z}_{Z_1 A}^{\frac{1}{2}} \\ \tilde{Z}_{Z_2 Z_1}^{\frac{1}{2}} & \tilde{Z}_{Z_2 Z_2}^{\frac{1}{2}} & \tilde{Z}_{Z_2 A}^{\frac{1}{2}} \\ \tilde{Z}_{AZ_1}^{\frac{1}{2}} & \tilde{Z}_{AZ_2}^{\frac{1}{2}} & \tilde{Z}_{AA}^{\frac{1}{2}} \end{pmatrix} \begin{pmatrix} c_1 \\ c_2 \\ c_0 \end{pmatrix}. \quad (198)$$

Similarly as for charged particle there is:

$$Z_{Z_i Z_j}^{\frac{1}{2}} = \delta_{ij} + \delta Z_{Z_i Z_j}^{\frac{1}{2}}, \quad (199)$$

$$(Z_G^0)_{ij} = \delta_{ij} + \delta (Z_G^0)_{ij}, \quad (200)$$

$$\tilde{Z}_{Z_i Z_j}^{\frac{1}{2}} = \delta_{ij} + \delta \tilde{Z}_{Z_i Z_j}^{\frac{1}{2}}, \quad (201)$$

$$Z_{Z_A Z_A}^{\frac{1}{2}} = 1 + \delta Z_{Z_A Z_A}^{\frac{1}{2}}. \quad (202)$$

For the  $\bar{c}$  - type ghosts it is not necessary to introduce renormalization constants (they occur always in pairs with  $c$  - type ghosts), and

$$\overset{\circ}{\bar{c}}_1 = \bar{c}_1, \quad (203)$$

$$\overset{\circ}{\bar{c}}_2 = \bar{c}_2, \quad (204)$$

$$\overset{\circ}{\bar{c}}_0 = \bar{c}_0. \quad (205)$$

iii) Fermions.

After SSB the left - right symmetric model is a chiral theory and left and right handed parts of fermion fields interacts in a different way. So the  $\psi_L$  and  $\psi_R$  fields must have independent renormalization constants. To satisfy all on mass - shell renormalization conditions one has to introduce the renormalization matrix.

$$\overset{\circ}{\psi}_{LI} = \sum_J (Z_L^{\frac{1}{2}})_{IJ} \psi_{LJ}, \quad (206)$$

$$\overset{\circ}{\psi}_{Li} = \sum_j (Z_L^{\frac{1}{2}})_{ij} \psi_{Lj}, \quad (207)$$

$$\overset{\circ}{\psi}_{RI} = \sum_J (Z_R^{\frac{1}{2}})_{IJ} \psi_{RJ}, \quad (208)$$

$$\overset{\circ}{\psi}_{Ri} = \sum_j (Z_R^{\frac{1}{2}})_{ij} \psi_{Rj}, \quad (209)$$

where

$$(Z_{L,R}^{\frac{1}{2}})_{ij} = \delta_{ij} + (\delta Z_{L,R}^{\frac{1}{2}})_{ij}, \quad (210)$$

$$(Z_{L,R}^{\frac{1}{2}})_{IJ} = \delta_{IJ} + (\delta Z_{L,R}^{\frac{1}{2}})_{IJ}, \quad (211)$$

and the sum is taken over up (IJ) and down (ij) quarks, or over charged leptons (ij) and neutrinos (IJ). For convenience we will also write  $(Z_{L,R}^{l\frac{1}{2}})_{ij}$  and  $(Z_{L,R}^{\nu\frac{1}{2}})_{IJ}$  for charged leptons and neutrinos respectively. The matrices  $Z_{L,R}$  can be complex and not unitary. If neutrinos are Majorana particles then there are relations between left and right handed fields, and the  $Z_L$  and  $Z_R$  are related by

$$Z_L = Z_R^*. \quad (212)$$

iv) Higgs particles.

Since all charge-less Higgs particles mix between each other (CP is not conserved), the renormalization matrix must be introduced for them:

$$\overset{\circ}{H}_i^0 = \sum_j Z_{ij}^{\frac{1}{2}} H_j^0, \quad i, j = H_0^0, H_1^0, H_2^0, H_3^0, A_1^0, A_2^0, \quad (213)$$

and similarly for charged particles:

$$\overset{\circ}{H}_i = \sum_j Z_{H_i H_j}^{\frac{1}{2}} H_j, \quad i, j = 1, 2, \quad (214)$$

$$\begin{pmatrix} \overset{\circ}{\delta}_L^{\pm\pm} \\ \overset{\circ}{\delta}_R^{\pm\pm} \end{pmatrix} = \begin{pmatrix} Z_{\delta_L^{\pm\pm}}^{\frac{1}{2}} & Z_{\delta_L^{\pm\pm} \delta_R}^{\frac{1}{2}} \\ Z_{\delta_R^{\pm\pm} \delta_L}^{\frac{1}{2}} & Z_{\delta_R^{\pm\pm}}^{\frac{1}{2}} \end{pmatrix} \begin{pmatrix} \delta_L^{\pm\pm} \\ \delta_R^{\pm\pm} \end{pmatrix}. \quad (215)$$

In the case of CP conservation the charge-less  $H$  and  $A$  particles have different CP parities and do not mix.

#### 4.1.2 Definitions of the renormalization constants for masses.

The masses of all physical particles are renormalized and we define:

$$\overset{\circ}{M}_{W_i}^2 = M_{W_i}^2 + \delta M_{W_i}^2 \equiv G_{W_i}^2 M_{W_i}^2, \quad i = 1, 2, \quad (216)$$

$$\overset{\circ}{M}_{Z_i}^2 = M_{Z_i}^2 + \delta M_{Z_i}^2 \equiv G_{Z_i}^2 M_{Z_i}^2, \quad i = 1, 2, \quad (217)$$

$$\overset{\circ}{M}_i^2 = M_i^2 + \delta M_i^2 \equiv G_i^2 M_i^2, \quad i = H^0, H_1^0, H_2^0, H_3^0, A_1^0, A_2^0, \quad (218)$$

$$\overset{\circ}{M}_{H_i^\pm}^2 = M_{H_i^\pm}^2 + \delta M_{H_i^\pm}^2 \equiv G_{H_i^\pm}^2 M_{H_i^\pm}^2, \quad i = 1, 2, \quad (219)$$

$$\overset{\circ}{M}_{\delta_L^{\pm\pm}}^2 = M_{\delta_L^{\pm\pm}}^2 + \delta M_{\delta_L^{\pm\pm}}^2 \equiv G_{\delta_L}^2 M_{\delta_L}^2, \quad (220)$$

$$\overset{\circ}{M}_{\delta_R^{\pm\pm}}^2 = M_{\delta_R^{\pm\pm}}^2 + \delta M_{\delta_R^{\pm\pm}}^2 \equiv G_{\delta_R}^2 M_{\delta_R}^2, \quad (221)$$

$$\overset{\circ}{m}_f^2 = m_f^2 + \delta m_f^2 \equiv G_f^2 m_f^2, \quad f = \text{leptons, quarks.} \quad (222)$$

#### 4.1.3 Definitions of the renormalization constants for couplings, mixing angles and mixing matrices.

There are more free parameters in the left - light symmetric model than in the SM  $(\cos \varphi, \sin \xi, \Omega_{L,R}, K_{L,R})$ . Thus, more renormalization constants must be introduced. The definitions of the renormalization constants for remaining parameters are as follows:

$$\overset{\circ}{e} = Y e \equiv (1 + \delta Y) e, \quad (223)$$

$$\overset{\circ}{\cos} \varphi = G_\varphi \cos \varphi \equiv (1 + \delta G_\varphi) \cos \varphi, \quad (224)$$

$$\overset{\circ}{\sin} \Theta_W = G_{\Theta_W} \sin \Theta_W \equiv (1 + \delta G_{\Theta_W}) \sin \Theta_W, \quad (225)$$

$$\overset{\circ}{\sin} \xi = G_\xi \sin \xi \equiv (1 + \delta G_\xi) \sin \xi, \quad (226)$$

$$\overset{\circ}{\Omega}_{L,R} = \Omega_{L,R} + \delta \Omega_{L,R}, \quad (227)$$

$$\overset{\circ}{K}_{L,R} = K_{L,R} + \delta K_{L,R}, \quad (228)$$

$$\overset{\circ}{U}_{L,R}^{CKM} = U_{L,R}^{CKM} + \delta U_{L,R}^{CKM}. \quad (229)$$

## 4.2 ON MASS - SHELL RENORMALIZATION CONDITIONS AND COUNTER TERMS

### 4.2.1 Renormalization of tadpoles.

Lorentz invariance prevents tadpoles for fields other than scalar ones. To get the renormalization conditions for the tadpoles, to each order of perturbation the requirement that the tadpole terms in effective action disappear is imposed. Thus, if the diagram

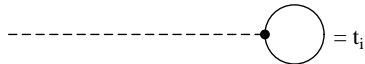

denotes tadpole  $t_i$  ( $i = H^0, H_1^0, H_2^0, H_3^0, A_1^0, A_2^0$ ) and the diagram

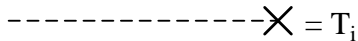

is an appropriate counter term  $T_i$  the renormalization conditions  $t_i + T_i = 0$  give renormalization constants  $T_i$ .

#### 4.2.2 Renormalization conditions and counter terms for two-point functions.

##### 4.2.2.1 Gauge bosons.

There are two kind of counter terms of two - point functions for gauge bosons. One is coming from kinetic energy

$$-\frac{1}{4}F^{\mu\nu}F_{\mu\nu}, \quad (230)$$

and the second is given by the mass term, e.q. for Z bosons

$$M_{Z_i}^2 Z_i^\mu Z_{i\mu}. \quad (231)$$

In the momentum space these two terms give contributions:

$$\begin{aligned} \text{kinetic energy} &\longrightarrow -ik^2 \left( g^{\mu\nu} - \frac{k^\mu k^\nu}{k^2} \right), \\ \text{mass term} &\longrightarrow ig^{\mu\nu}. \end{aligned} \quad (232)$$

It is better to use two orthogonal tensors:

$$T^{\mu\nu} = g^{\mu\nu} - \frac{k^\mu k^\nu}{k^2}, \quad L^{\mu\nu} = \frac{k^\mu k^\nu}{k^2}. \quad (233)$$

Then of course

$$T^{\mu\nu} L_{\nu\rho} = 0, \quad T^{\mu\nu} + L^{\mu\nu} = g^{\mu\nu}. \quad (234)$$

Since the gauge fixing parameter is free it is not necessary to renormalize the gauge fixing term, e.g.

$$-\frac{1}{\xi} (\partial^\mu Z_{i\mu})^2 \quad (235)$$

for Z bosons.

In all the following pictures in this section the diagram

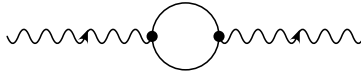

represents n-loop self-energy contribution, whereas

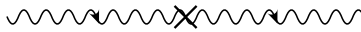



is the appropriate counter term. The letter ' $k$ ' stands for the external particle momentum.

For two charged gauge bosons we have two diagonal propagators and two mixed.

$$\begin{array}{c} \text{W}_{1\mu}^+ \\ \text{wavy line} \end{array} \begin{array}{c} \text{---} \bullet \\ \text{---} \bullet \end{array} \begin{array}{c} \text{W}_{1\nu}^+ \\ \text{wavy line} \end{array} = T^{\mu\nu} A^{W_1}(k^2) + L^{\mu\nu} B^{W_1}(k^2),$$

$$\begin{array}{c} \text{W}_{1\mu}^+ \\ \text{wavy line} \end{array} \begin{array}{c} \text{---} \times \\ \text{---} \times \end{array} \begin{array}{c} \text{W}_{1\nu}^+ \\ \text{wavy line} \end{array} =$$

$$T^{\mu\nu} \left[ (M_{W_1}^2 + \delta M_{W_1}^2) \left( Z_{W_1 W_1}^{\frac{1}{2}} \right)^2 + \right.$$

$$\left. (M_{W_2}^2 + \delta M_{W_2}^2) \left( Z_{W_2 W_1}^{\frac{1}{2}} \right)^2 - k^2 \left( \left( Z_{W_1 W_1}^{\frac{1}{2}} \right)^2 + \left( Z_{W_2 W_1}^{\frac{1}{2}} \right)^2 \right) \right] +$$

$$L^{\mu\nu} \left[ (M_{W_1}^2 + \delta M_{W_1}^2) \left( Z_{W_1 W_1}^{\frac{1}{2}} \right)^2 + (M_{W_2}^2 + \delta M_{W_2}^2) \left( Z_{W_2 W_1}^{\frac{1}{2}} \right)^2 \right]. \quad (236)$$

$$\begin{array}{c} \text{W}_{2\mu}^+ \\ \text{wavy line} \end{array} \begin{array}{c} \text{---} \bullet \\ \text{---} \bullet \end{array} \begin{array}{c} \text{W}_{2\nu}^+ \\ \text{wavy line} \end{array} = T^{\mu\nu} A^{W_2}(k^2) + L^{\mu\nu} B^{W_2}(k^2),$$

$$\begin{array}{c} \text{W}_{2\mu}^+ \\ \text{wavy line} \end{array} \begin{array}{c} \text{---} \times \\ \text{---} \times \end{array} \begin{array}{c} \text{W}_{2\nu}^+ \\ \text{wavy line} \end{array} =$$

$$T^{\mu\nu} \left[ (M_{W_2}^2 + \delta M_{W_2}^2) \left( Z_{W_2 W_2}^{\frac{1}{2}} \right)^2 + \right.$$

$$\left. (M_{W_1}^2 + \delta M_{W_1}^2) \left( Z_{W_1 W_2}^{\frac{1}{2}} \right)^2 - k^2 \left( \left( Z_{W_2 W_2}^{\frac{1}{2}} \right)^2 + \left( Z_{W_1 W_2}^{\frac{1}{2}} \right)^2 \right) \right] +$$

$$L^{\mu\nu} \left[ (M_{W_2}^2 + \delta M_{W_2}^2) \left( Z_{W_2 W_2}^{\frac{1}{2}} \right)^2 + (M_{W_1}^2 + \delta M_{W_1}^2) \left( Z_{W_1 W_2}^{\frac{1}{2}} \right)^2 \right]. \quad (237)$$

$$\begin{array}{c}
W_{1\mu}^+ \\
\text{wavy line} \quad \bullet \quad \text{circle} \quad \bullet \\
W_{2\nu}^+
\end{array}
= T^{\mu\nu} A^{W_1 W_2}(k^2) + L^{\mu\nu} B^{W_1 W_2}(k^2),$$

$$\begin{array}{c}
W_{1\mu}^+ \\
\text{wavy line} \quad \times \\
W_{2\nu}^+
\end{array}
=$$

$$\begin{aligned}
& T^{\mu\nu} \left[ (M_{W_1}^2 + \delta M_{W_1}^2) Z_{W_1 W_1}^{\frac{1}{2}} Z_{W_1 W_2}^{\frac{1}{2}} + \right. \\
& \left. (M_{W_2}^2 + \delta M_{W_2}^2) Z_{W_2 W_2}^{\frac{1}{2}} Z_{W_2 W_1}^{\frac{1}{2}} - k^2 \left( Z_{W_1 W_1}^{\frac{1}{2}} Z_{W_1 W_2}^{\frac{1}{2}} + Z_{W_2 W_2}^{\frac{1}{2}} Z_{W_2 W_1}^{\frac{1}{2}} \right) \right] + \\
& L^{\mu\nu} \left[ (M_{W_1}^2 + \delta M_{W_1}^2) Z_{W_1 W_1}^{\frac{1}{2}} Z_{W_1 W_2}^{\frac{1}{2}} + (M_{W_2}^2 + \delta M_{W_2}^2) Z_{W_2 W_2}^{\frac{1}{2}} Z_{W_2 W_1}^{\frac{1}{2}} \right].
\end{aligned} \tag{238}$$

Renormalization conditions

Renormalization constants

$$\left. \begin{array}{l}
A^{W_1}(M_{W_1}^2) = 0 \\
A^{W_1'}(M_{W_1}^2) = 0 \\
A^{W_2}(M_{W_2}^2) = 0 \\
A^{W_2'}(M_{W_2}^2) = 0 \\
A^{W_1 W_2}(M_{W_1}^2) = 0 \\
A^{W_1 W_2}(M_{W_2}^2) = 0
\end{array} \right\} \Rightarrow \begin{array}{l}
Z_{W_1 W_1}^{\frac{1}{2}}, Z_{W_2 W_2}^{\frac{1}{2}}, \delta M_{W_1}^2 \\
Z_{W_1 W_2}^{\frac{1}{2}}, Z_{W_2 W_1}^{\frac{1}{2}}, \delta M_{W_2}^2.
\end{array} \tag{239}$$

These equations allow us to calculate six renormalization constants. Prime superscript in the renormalization conditions above means differentiation with respect to  $k^2$  e.g.

$$A^{W_1'}(M_{W_1}^2) = \frac{\partial A^{W_1}(k^2)}{\partial k^2} \Big|_{k^2=M_{W_1}^2}. \tag{240}$$

For neutral gauge bosons the situation is more complicated. There are three diagonal propagators and three mixed.

$$\begin{array}{c} Z_{1\mu} \\ \text{wavy line} \end{array} \begin{array}{c} \circ \\ \text{circle} \\ \circ \end{array} \begin{array}{c} Z_{1\nu} \\ \text{wavy line} \end{array} = T^{\mu\nu} A^{Z_1}(k^2) + L^{\mu\nu} B^{Z_1}(k^2),$$

$$\begin{array}{c} Z_{1\mu} \\ \text{wavy line} \end{array} \begin{array}{c} \times \\ \text{cross} \\ \times \end{array} \begin{array}{c} Z_{1\nu} \\ \text{wavy line} \end{array} =$$

$$T^{\mu\nu} \left[ (M_{Z_1}^2 + \delta M_{Z_1}^2) \left( Z_{Z_1 Z_1}^{\frac{1}{2}} \right)^2 + \right.$$

$$\left. (M_{Z_2}^2 + \delta M_{Z_2}^2) \left( Z_{Z_2 Z_1}^{\frac{1}{2}} \right)^2 - k^2 \left( \left( Z_{Z_1 Z_1}^{\frac{1}{2}} \right)^2 + \left( Z_{Z_2 Z_1}^{\frac{1}{2}} \right)^2 + \left( Z_{AZ_1}^{\frac{1}{2}} \right)^2 \right) \right] +$$

$$L^{\mu\nu} \left[ (M_{Z_1}^2 + \delta M_{Z_1}^2) \left( Z_{Z_1 Z_1}^{\frac{1}{2}} \right)^2 + (M_{Z_2}^2 + \delta M_{Z_2}^2) \left( Z_{Z_2 Z_1}^{\frac{1}{2}} \right)^2 \right]. \quad (241)$$

$$\begin{array}{c} Z_{2\mu} \\ \text{wavy line} \end{array} \begin{array}{c} \circ \\ \text{circle} \\ \circ \end{array} \begin{array}{c} Z_{2\nu} \\ \text{wavy line} \end{array} = T^{\mu\nu} A^{Z_2}(k^2) + L^{\mu\nu} B^{Z_2}(k^2),$$

$$\begin{array}{c} Z_{2\mu} \\ \text{wavy line} \end{array} \begin{array}{c} \times \\ \text{cross} \\ \times \end{array} \begin{array}{c} Z_{2\nu} \\ \text{wavy line} \end{array} =$$

$$T^{\mu\nu} \left[ (M_{Z_2}^2 + \delta M_{Z_2}^2) \left( Z_{Z_2 Z_2}^{\frac{1}{2}} \right)^2 + \right.$$

$$\left. (M_{Z_1}^2 + \delta M_{Z_1}^2) \left( Z_{Z_1 Z_2}^{\frac{1}{2}} \right)^2 - k^2 \left( \left( Z_{Z_2 Z_2}^{\frac{1}{2}} \right)^2 + \left( Z_{Z_1 Z_2}^{\frac{1}{2}} \right)^2 + \left( Z_{AZ_2}^{\frac{1}{2}} \right)^2 \right) \right] +$$

$$L^{\mu\nu} \left[ (M_{Z_2}^2 + \delta M_{Z_2}^2) \left( Z_{Z_2 Z_2}^{\frac{1}{2}} \right)^2 + (M_{Z_1}^2 + \delta M_{Z_1}^2) \left( Z_{Z_1 Z_2}^{\frac{1}{2}} \right)^2 \right]. \quad (242)$$

$$\begin{array}{c} Z_{1\mu} \\ \text{wavy line} \end{array} \begin{array}{c} \text{circle} \\ \text{wavy line} \end{array} \begin{array}{c} Z_{2\nu} \\ \text{wavy line} \end{array} = T^{\mu\nu} A^{Z_1 Z_2}(k^2) + L^{\mu\nu} B^{Z_1 Z_2}(k^2),$$

$$\begin{array}{c} Z_{1\mu} \\ \text{wavy line} \end{array} \begin{array}{c} \text{crossed-out wavy line} \\ \text{wavy line} \end{array} \begin{array}{c} Z_{2\nu} \\ \text{wavy line} \end{array} =$$

$$\begin{aligned} & T^{\mu\nu} \left[ (M_{Z_1}^2 + \delta M_{Z_1}^2) Z_{Z_1 Z_1}^{\frac{1}{2}} Z_{Z_1 Z_2}^{\frac{1}{2}} + \right. \\ & \left. (M_{Z_2}^2 + \delta M_{Z_2}^2) Z_{Z_2 Z_2}^{\frac{1}{2}} Z_{Z_2 Z_1}^{\frac{1}{2}} - k^2 \left( Z_{Z_1 Z_1}^{\frac{1}{2}} Z_{Z_1 Z_2}^{\frac{1}{2}} + Z_{Z_2 Z_2}^{\frac{1}{2}} Z_{Z_2 Z_1}^{\frac{1}{2}} + Z_{AZ_1}^{\frac{1}{2}} Z_{AZ_2}^{\frac{1}{2}} \right) \right] + \\ & L^{\mu\nu} \left[ (M_{Z_1}^2 + \delta M_{Z_1}^2) Z_{Z_1 Z_1}^{\frac{1}{2}} Z_{Z_1 Z_2}^{\frac{1}{2}} + (M_{Z_2}^2 + \delta M_{Z_2}^2) Z_{Z_2 Z_2}^{\frac{1}{2}} Z_{Z_2 Z_1}^{\frac{1}{2}} \right]. \end{aligned} \quad (243)$$

$$\begin{array}{c} A_\mu \\ \text{wavy line} \end{array} \begin{array}{c} \text{circle} \\ \text{wavy line} \end{array} \begin{array}{c} A_\nu \\ \text{wavy line} \end{array} = T^{\mu\nu} A^A(k^2) + L^{\mu\nu} B^A(k^2),$$

$$\begin{array}{c} A_\mu \\ \text{wavy line} \end{array} \begin{array}{c} \text{crossed-out wavy line} \\ \text{wavy line} \end{array} \begin{array}{c} A_\nu \\ \text{wavy line} \end{array} =$$

$$\begin{aligned} & T^{\mu\nu} \left[ (M_{Z_1}^2 + \delta M_{Z_1}^2) \left( Z_{Z_1 A}^{\frac{1}{2}} \right)^2 + \right. \\ & \left. (M_{Z_2}^2 + \delta M_{Z_2}^2) \left( Z_{Z_2 A}^{\frac{1}{2}} \right)^2 - k^2 \left( \left( Z_{Z_1 A}^{\frac{1}{2}} \right)^2 + \left( Z_{Z_2 A}^{\frac{1}{2}} \right)^2 + \left( Z_{AA}^{\frac{1}{2}} \right)^2 \right) \right] + \\ & L^{\mu\nu} \left[ (M_{Z_1}^2 + \delta M_{Z_1}^2) \left( Z_{Z_1 A}^{\frac{1}{2}} \right)^2 + (M_{Z_2}^2 + \delta M_{Z_2}^2) \left( Z_{Z_2 A}^{\frac{1}{2}} \right)^2 \right]. \end{aligned} \quad (244)$$

$$\begin{array}{c} Z_{1\mu} \\ \text{wavy line} \end{array} \begin{array}{c} \text{circle} \\ \text{wavy line} \end{array} \begin{array}{c} A_\nu \\ \text{wavy line} \end{array} = T^{\mu\nu} A^{Z_1 A}(k^2) + L^{\mu\nu} B^{Z_1 A}(k^2),$$

$$\begin{array}{c} Z_{1\mu} \\ \text{wavy line} \end{array} \begin{array}{c} \text{crossed wavy line} \\ \text{wavy line} \end{array} \begin{array}{c} A_\nu \\ \text{wavy line} \end{array} =$$

$$\begin{aligned} & T^{\mu\nu} \left[ (M_{Z_1}^2 + \delta M_{Z_1}^2) Z_{Z_1 Z_1}^{\frac{1}{2}} Z_{Z_1 A}^{\frac{1}{2}} + \right. \\ & \left. (M_{Z_2}^2 + \delta M_{Z_2}^2) Z_{Z_2 Z_1}^{\frac{1}{2}} Z_{Z_2 A}^{\frac{1}{2}} - k^2 \left( Z_{Z_1 Z_1}^{\frac{1}{2}} Z_{Z_1 A}^{\frac{1}{2}} + Z_{Z_2 Z_1}^{\frac{1}{2}} Z_{Z_2 A}^{\frac{1}{2}} + Z_{AZ_1}^{\frac{1}{2}} Z_{AA}^{\frac{1}{2}} \right) \right] + \\ & L^{\mu\nu} \left[ (M_{Z_1}^2 + \delta M_{Z_1}^2) Z_{Z_1 Z_1}^{\frac{1}{2}} Z_{Z_1 A}^{\frac{1}{2}} + (M_{Z_2}^2 + \delta M_{Z_2}^2) Z_{Z_2 Z_1}^{\frac{1}{2}} Z_{Z_2 A}^{\frac{1}{2}} \right]. \end{aligned} \quad (245)$$

$$\begin{array}{c} Z_{2\mu} \\ \text{wavy line} \end{array} \begin{array}{c} \text{circle} \\ \text{wavy line} \end{array} \begin{array}{c} A_\nu \\ \text{wavy line} \end{array} = T^{\mu\nu} A^{Z_2 A}(k^2) + L^{\mu\nu} B^{Z_2 A}(k^2),$$

$$\begin{array}{c} Z_{2\mu} \\ \text{wavy line} \end{array} \begin{array}{c} \text{crossed wavy line} \\ \text{wavy line} \end{array} \begin{array}{c} A_\nu \\ \text{wavy line} \end{array} =$$

$$\begin{aligned} & T^{\mu\nu} \left[ (M_{Z_2}^2 + \delta M_{Z_2}^2) Z_{Z_2 Z_2}^{\frac{1}{2}} Z_{Z_2 A}^{\frac{1}{2}} + \right. \\ & \left. (M_{Z_1}^2 + \delta M_{Z_1}^2) Z_{Z_1 Z_2}^{\frac{1}{2}} Z_{Z_1 A}^{\frac{1}{2}} - k^2 \left( Z_{Z_2 Z_2}^{\frac{1}{2}} Z_{Z_2 A}^{\frac{1}{2}} + Z_{Z_1 Z_2}^{\frac{1}{2}} Z_{Z_1 A}^{\frac{1}{2}} + Z_{AZ_2}^{\frac{1}{2}} Z_{AA}^{\frac{1}{2}} \right) \right] + \\ & L^{\mu\nu} \left[ (M_{Z_2}^2 + \delta M_{Z_2}^2) Z_{Z_2 Z_2}^{\frac{1}{2}} Z_{Z_2 A}^{\frac{1}{2}} + (M_{Z_1}^2 + \delta M_{Z_1}^2) Z_{Z_1 Z_2}^{\frac{1}{2}} Z_{Z_1 A}^{\frac{1}{2}} \right]. \end{aligned} \quad (246)$$

There are 12 renormalization conditions but only 11 renormalization constants. In fact not all 12 conditions are independent. The BRST invariance gives relations among them, so only 11 are independent. It is worth to stress that to satisfy all 11 conditions, the renormalization matrix (Eq. (196)) does not have to be a symmetric one. From these 11 independent conditions all constants can be determined.

Renormalization conditions

Renormalization constants

$$\left. \begin{array}{l}
A^{Z_1}(M_{Z_1}^2) = 0, \quad A^{Z_1'}(M_{Z_1}^2) = 0, \\
A^{Z_2}(M_{Z_2}^2) = 0, \quad A^{Z_2'}(M_{Z_2}^2) = 0, \\
A^{Z_1 A}(M_{Z_1}^2) = 0, \quad A^{Z_1 A}(0) = 0, \\
A^{Z_2 A}(M_{Z_2}^2) = 0, \quad A^{Z_2 A}(0) = 0, \\
A^{Z_1 Z_2}(M_{Z_1}^2) = 0, \quad A^{Z_1 Z_2}(M_{Z_2}^2) = 0, \\
A^A(0) = 0, \quad A^{A'}(0) = 0
\end{array} \right\} \Rightarrow \begin{array}{l}
Z_{Z_1 Z_1}^{\frac{1}{2}}, Z_{Z_1 A}^{\frac{1}{2}}, Z_{Z_2 A}^{\frac{1}{2}}, Z_{A Z_1}^{\frac{1}{2}}, Z_{A Z_2}^{\frac{1}{2}}, Z_{AA}^{\frac{1}{2}}, \\
\delta M_{Z_1}^2, \delta M_{Z_2}^2, Z_{Z_1 Z_2}^{\frac{1}{2}}, Z_{Z_2 Z_1}^{\frac{1}{2}}, Z_{Z_2 Z_2}^{\frac{1}{2}}.
\end{array} \quad (247)$$

#### 4.2.2.2 Scalar particles.

We don't write the tadpole part for scalar bosons because according to the discussion in section 4.2.1 it equals zero. For neutral scalar particles the counter terms come from the following part of the inverse propagators Lagrangian

$$-\sum_{i=1}^6 \frac{1}{2} H_i^0 (\square + M_i^2) H_i^0. \quad (248)$$

As all 6 neutral particles mix together we have six diagonal propagators and 15 off diagonal ones.

$$\begin{array}{c}
\text{H}_i \text{---} \bullet \text{---} \text{H}_j \\
\text{---} \bullet \text{---} \bullet \text{---} \\
\text{---} \bullet \text{---}
\end{array} = F_{ij}(k^2), \quad i, j = H^0, H_1^0, H_2^0, H_3^0, A_1^0, A_2^0 \quad i \geq j,$$

$$\begin{array}{c}
\text{H}_i \text{---} \times \text{---} \text{H}_j \\
\text{---} \times \text{---}
\end{array} = \sum_{k=1}^6 Z_{ki}^{\frac{1}{2}} Z_{kj}^{\frac{1}{2}} (k^2 - M_k^2 - \delta M_k^2).$$

Altogether 42 renormalization conditions give us 42 renormalization constants.

Renormalization conditions

Renormalization constants

$$\left. \begin{array}{l}
F_{ii}(M_i^2) = 0 \\
F_{ii}'(M_i^2) = 0 \\
F_{ij}(M_i^0) = 0, \quad i > j \\
F_{ij}(M_j^2) = 0, \quad i > j
\end{array} \right\} \Rightarrow Z_{ii}^{\frac{1}{2}}, Z_{ij}^{\frac{1}{2}}, Z_{ji}^{\frac{1}{2}}, \delta M_i^2. \quad (249)$$

The following part of the inverse propagators Lagrangian gives contributions to counter terms of the single charged scalar particles

$$-\sum_{i=1}^2 H_i^+ (\square + M_{H_i}^2) H_i^- . \quad (250)$$

$$= F_{H_i H_j}(k^2), \quad i, j = 1, 2; \quad i \geq j,$$

$$= \sum_{k=1}^2 Z_{H_k H_i}^{\frac{1}{2}} Z_{H_k H_j}^{\frac{1}{2}} (k^2 - M_{H_k}^2 - \delta M_{H_k}^2) .$$

In this case 6 renormalization constants is fixed:

Renormalization conditions      Renormalization constants

$$\left. \begin{array}{l} F_{H_i H_i}(M_{H_i}^2) = 0 \\ F'_{H_i H_i}(M_{H_i}^2) = 0 \\ F_{H_i H_j}(M_{H_i}^2) = 0, \quad i > j \\ F_{H_i H_j}(M_{H_j}^2) = 0, \quad i > j \end{array} \right\} \Rightarrow Z_{H_1 H_1}^{\frac{1}{2}}, Z_{H_2 H_2}^{\frac{1}{2}}, Z_{H_1 H_2}^{\frac{1}{2}}, Z_{H_2 H_1}^{\frac{1}{2}}, \delta M_{H_1}^2, \delta M_{H_2}^2 . \quad (251)$$

Finally, 6 renormalization constants connected with doubly charged Higgses can be found.

For doubly charged scalar particles the counter terms come from the following part of the inverse propagators Lagrangian

$$-\delta_L^{++} (\square + M_{\delta_L}) \delta_L^{--} - \delta_R^{++} (\square + M_{\delta_R}) \delta_R^{--} . \quad (252)$$

$$\delta_i^{++} \text{---} \bullet \text{---} \bigcirc \text{---} \bullet \text{---} \delta_j^{++} = F_{\delta_i \delta_j}(k^2), \quad i, j = L, R, \quad i \geq j,$$

$$\delta_i^{++} \text{---} \times \text{---} \delta_j^{++} = \sum_{k=1}^2 Z_{\delta_k \delta_i}^{\frac{1}{2}} Z_{\delta_k \delta_j}^{\frac{1}{2}} \left( k^2 - M_{\delta_k}^2 - \delta M_{\delta_k}^2 \right).$$

Renormalization conditions      Renormalization constants

$$\left. \begin{aligned} F_{\delta_i}(M_{\delta_j}^2) &= 0 \\ F'_{\delta_i}(M_{\delta_i}^2) &= 0 \\ F_{\delta_i \delta_j}(M_{\delta_i}^2) &= 0, \quad i > j \\ F_{\delta_i \delta_j}(M_{\delta_j}^2) &= 0, \quad i > j \end{aligned} \right\} \Rightarrow Z_{\delta_L \delta_L}^{\frac{1}{2}}, Z_{\delta_L \delta_R}^{\frac{1}{2}}, Z_{\delta_R \delta_L}^{\frac{1}{2}}, Z_{\delta_R \delta_R}^{\frac{1}{2}}, \delta M_{\delta_L}^2, \delta M_{\delta_R}^2. \quad (253)$$

#### 4.2.2.3 Fermions.

The following part of the inverse propagators Lagrangian gives contributions to the counter terms of fermions

$$\sum_i \bar{\psi}_i (i\gamma^\mu \partial_\mu - m_i) \psi_i + \sum_I \bar{\psi}_I (i\gamma^\mu \partial_\mu - m_I) \psi_I. \quad (254)$$

It is suitable to divide the renormalized inverse fermion propagator matrix  $K = (K_{ij})$  into four parts

$$K^{ren} = A_L P_L + A_R P_R + B_L \hat{k} P_L + B_R \hat{k} P_R, \quad (255)$$

where

$$A_{L,R} = \left\{ (A_{L,R})_{ij} \right\}, \quad B_{L,R} = \left\{ (B_{L,R})_{ij} \right\} \quad (256)$$

are independent matrices in flavor space separate for up - quarks ( $A_{L,R}^{up}$ ,  $B_{L,R}^{up}$ ), down - quarks ( $A_{L,R}^{down}$ ,  $B_{L,R}^{down}$ ), charged leptons ( $A_{L,R}^l$ ,  $B_{L,R}^l$ ) and neutrinos ( $A_{L,R}^\nu$ ,  $B_{L,R}^\nu$ ). These matrices for up and down quarks and charged leptons are 3 dimensional. For neutrinos  $A_{L,R}^\nu$  and  $B_{L,R}^\nu$  have  $6 \times 6$  dimension. So we have



$$\begin{array}{c} \text{i} \\ \longrightarrow \\ \bullet \\ \circlearrowleft \\ \bullet \\ \longrightarrow \\ \text{j} \end{array} = A_L^{ij} P_L + A_R^{ij} P_R + B_L^{ij} \widehat{k} P_L + B_R^{ij} \widehat{k} P_R,$$

and counter terms

$$\begin{array}{c} \text{i} \\ \longrightarrow \\ \times \\ \longrightarrow \\ \text{j} \end{array} = - (Z_L^+(m + \delta m) Z_R)_{ij} P_R - (Z_R^+(m + \delta m) Z_L)_{ij} P_L + (Z_R^+ Z_R)_{ij} \widehat{k} P_R + (Z_L^+ Z_L)_{ij} \widehat{k} P_L. \quad (257)$$

The on - mass shell renormalization conditions are the following

for  $i = j$  :

$$\begin{cases} A_L^{ii}(m_i^2) = -m_i B_R^{ii}(m_i^2), \\ A_R^{ii}(m_i^2) = -m_i B_L^{ii}(m_i^2), \\ B_L^{ii}(m_i^2) = B_R^{ii}(m_i^2), \\ m_i (A_L^{ii'}(m_i^2) + A_R^{ii'}(m_i^2)) + \frac{1}{2} (B_L^{ii}(m_i^2) + B_R^{ii}(m_i^2)) + m_i^2 (B_L^{ii'}(m_i^2) + B_R^{ii'}(m_i^2)) = 1, \end{cases} \quad (258)$$

and for  $i > j$  :

$$\begin{cases} A_L^{ij}(m_j^2) + m_j B_R^{ij}(m_j^2) = 0, \\ A_R^{ij}(m_j^2) + m_j B_L^{ij}(m_j^2) = 0, \\ A_L^{ij}(m_i^2) + m_i B_R^{ij}(m_i^2) = 0, \\ A_R^{ij}(m_i^2) + m_i B_L^{ij}(m_i^2) = 0. \end{cases} \quad (259)$$

For Dirac particles of  $N$  generations (quarks and charged leptons) there are  $4N^2$  independent on mass - shell conditions and the same number of renormalization constants. So, for three generations there are altogether  $3 \times 4 \times 3^2 = 108$  renormalization constants which have to be determined. For Majorana particles there are  $2 \times (2N)^2 + 2N = 78$  renormalization constants which must be found.

#### 4.2.2.4 Unphysical particles.

The unphysical particles do not appear on external lines, so we may impose any renormalization conditions for these "particles". It is most convenient to use the minimal subtraction scheme. To express the Faddeev-Popov Lagrangian (Eq.(181)) by bare quantities we define the renormalization constants for auxiliary fields in the following way:

$$\begin{pmatrix} E_1^\pm \\ E_2^\pm \end{pmatrix} = \left( Z_W^{\frac{1}{2}T} \right)_{ij} \begin{pmatrix} \overset{\circ}{E}_1^\pm \\ \overset{\circ}{E}_2^\pm \end{pmatrix}, \quad (260)$$

$$\begin{pmatrix} E_{Z_1} \\ E_{Z_2} \\ E_A \end{pmatrix} = \left( Z_Z^{\frac{1}{2}T} \right)_{ij} \begin{pmatrix} \overset{\circ}{E}_{Z_1} \\ \overset{\circ}{E}_{Z_2} \\ \overset{\circ}{E}_A \end{pmatrix}. \quad (261)$$

Then the gauge fixing Lagrangian (Eq.163) in bare fields (omitting bilinear terms of auxiliary fields) reads

$$\begin{aligned} \overset{\circ}{L}_{GF} &= \overset{\circ}{E}_1^- \partial^\mu \overset{\circ}{W}_{1\mu}^+ + \overset{\circ}{E}_2^- \partial^\mu \overset{\circ}{W}_{2\mu}^+ + i \overset{\circ}{E}_1^- \left( \overset{\circ}{\xi}_{W_1} \overset{\circ}{M}_{W_1} \overset{\circ}{G}_1^+ + \overset{\circ}{\gamma}_{c1} \overset{\circ}{G}_2^+ \right) + i \overset{\circ}{E}_2^- \left( \overset{\circ}{\xi}_{W_2} \overset{\circ}{M}_{W_2} \overset{\circ}{G}_2^+ + \overset{\circ}{\gamma}_{c2} \overset{\circ}{G}_1^+ \right) + h.c. \\ &+ \overset{\circ}{E}_{Z_1} \partial^\mu \overset{\circ}{Z}_{1\mu} + \overset{\circ}{E}_{Z_2} \partial^\mu \overset{\circ}{Z}_{2\mu} + \overset{\circ}{E}_A \partial^\mu \overset{\circ}{A}_\mu - \overset{\circ}{E}_{Z_1} \left( \overset{\circ}{\xi}_{Z_1} \overset{\circ}{M}_{Z_1} \overset{\circ}{G}_1^0 + \overset{\circ}{\gamma}_{n1} \overset{\circ}{G}_2^0 \right) - \overset{\circ}{E}_{Z_2} \left( \overset{\circ}{\xi}_{Z_2} \overset{\circ}{M}_{Z_2} \overset{\circ}{G}_2^0 + \overset{\circ}{\gamma}_{n2} \overset{\circ}{G}_1^0 \right) \\ &- E_A \beta_1 \overset{\circ}{G}_1^0 - E_A \beta_2 \overset{\circ}{G}_2^0, \end{aligned} \quad (262)$$

where

$$\begin{aligned} \overset{\circ}{\xi}_{W_1} &= \left( \xi \frac{M_{W_1}}{\overset{\circ}{M}_{W_1}} \left( Z_W^{\frac{1}{2}T} \right)_{11} (Z_G^{+-1})_{11} + \xi \frac{M_{W_2}}{\overset{\circ}{M}_{W_1}} \left( Z_W^{\frac{1}{2}T} \right)_{21} (Z_G^{+-1})_{21} \right), \\ \overset{\circ}{\xi}_{W_2} &= \left( \xi \frac{M_{W_1}}{\overset{\circ}{M}_{W_2}} \left( Z_W^{\frac{1}{2}T} \right)_{12} (Z_G^{+-1})_{12} + \xi \frac{M_{W_2}}{\overset{\circ}{M}_{W_2}} \left( Z_W^{\frac{1}{2}T} \right)_{22} (Z_G^{+-1})_{22} \right), \\ \overset{\circ}{\xi}_{Z_1} &= \left( \xi \frac{M_{Z_1}}{\overset{\circ}{M}_{Z_1}} \left( Z_Z^{\frac{1}{2}T} \right)_{11} (Z_G^{0-1})_{11} + \xi_{Z_2} \frac{M_{Z_2}}{\overset{\circ}{M}_{Z_1}} \left( Z_Z^{\frac{1}{2}T} \right)_{21} (Z_G^{0-1})_{21} \right), \\ \overset{\circ}{\xi}_{Z_2} &= \left( \xi \frac{M_{Z_1}}{\overset{\circ}{M}_{Z_2}} \left( Z_Z^{\frac{1}{2}T} \right)_{12} (Z_G^{0-1})_{12} + \xi \frac{M_{Z_2}}{\overset{\circ}{M}_{Z_2}} \left( Z_Z^{\frac{1}{2}T} \right)_{22} (Z_G^{0-1})_{22} \right), \\ \overset{\circ}{\gamma}_{n1} &= \xi M_{Z_1} \left( Z_Z^{\frac{1}{2}T} \right)_{11} (Z_G^{0-1})_{12} + \xi M_{Z_2} \left( Z_Z^{\frac{1}{2}T} \right)_{21} (Z_G^{0-1})_{22}, \\ \overset{\circ}{\gamma}_{n2} &= \xi M_{Z_1} \left( Z_Z^{\frac{1}{2}T} \right)_{12} (Z_G^{0-1})_{11} + \xi M_{Z_2} \left( Z_Z^{\frac{1}{2}T} \right)_{22} (Z_G^{0-1})_{21}, \\ \overset{\circ}{\gamma}_{c1} &= \xi M_{W_1} \left( Z_W^{\frac{1}{2}T} \right)_{11} (Z_G^{+-1})_{12} + \xi M_{W_2} \left( Z_W^{\frac{1}{2}T} \right)_{21} (Z_G^{+-1})_{22}, \\ \overset{\circ}{\gamma}_{c2} &= \xi M_{W_1} \left( Z_W^{\frac{1}{2}T} \right)_{12} (Z_G^{+-1})_{11} + \xi M_{W_2} \left( Z_W^{\frac{1}{2}T} \right)_{22} (Z_G^{+-1})_{21}, \\ \beta_1 &= \xi M_{Z_1} \left( Z_Z^{\frac{1}{2}T} \right)_{13} (Z_G^{0-1})_{11} + \xi M_{Z_2} \left( Z_Z^{\frac{1}{2}T} \right)_{23} (Z_G^{0-1})_{21}, \\ \beta_2 &= \xi M_{Z_1} \left( Z_Z^{\frac{1}{2}T} \right)_{13} (Z_G^{0-1})_{12} + \xi M_{Z_2} \left( Z_Z^{\frac{1}{2}T} \right)_{23} (Z_G^{0-1})_{22}. \end{aligned} \quad (263)$$

The bare "D" quantities from Eq.(165) read:

$$\overset{\circ}{D}_{Z_1} = \tilde{\delta}^{BRST} \left( \partial^\mu \overset{\circ}{Z}_{1\mu} - \overset{\circ}{\xi}_{Z_1} \overset{\circ}{M}_{Z_1} \overset{\circ}{G}_1^0 - \overset{\circ}{\gamma}_{n1} \overset{\circ}{G}_2^0 \right),$$

$$\begin{aligned}
\mathring{D}_{Z_2} &= \tilde{\delta}^{BRST} \left( \partial^\mu \mathring{Z}_{2\mu} - \mathring{\xi}_{Z_2} \mathring{M}_{Z_2} \mathring{G}_2^0 - \mathring{\gamma}_{n2} \mathring{G}_1^0 \right), \\
\mathring{D}_A &= \tilde{\delta}^{BRST} \left( \partial^\mu \mathring{A}_\mu - \beta_1 \mathring{G}_1^0 - \beta_2 \mathring{G}_2^0 \right), \\
\mathring{D}_1^+ &= \tilde{\delta}^{BRST} \left( \partial^\mu \mathring{W}_{1\mu}^+ + i \mathring{\xi}_{W_1} \mathring{M}_{W_1} \mathring{G}_1^+ + i \mathring{\gamma}_{c1} \mathring{G}_2^+ \right), \\
\mathring{D}_2^+ &= \tilde{\delta}^{BRST} \left( \partial^\mu \mathring{W}_{2\mu}^+ + i \mathring{\xi}_{W_2} \mathring{M}_{W_2} \mathring{G}_2^+ + i \mathring{\gamma}_{c2} \mathring{G}_1^+ \right).
\end{aligned} \tag{264}$$

**a. Goldstone - bosons.** Three renormalization constants for charged Goldstone bosons are determined from three inverse propagators

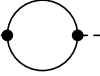
$$\begin{array}{c} \mathring{G}_i^+ \\ \dashrightarrow \end{array} \text{---} \text{---} \text{---} \text{---} \begin{array}{c} \mathring{G}_j^+ \\ \dashrightarrow \end{array} = F_{ij}^\pm(k^2), \quad i \geq j,$$



$$\begin{array}{c} \mathring{G}_i^+ \\ \dashrightarrow \end{array} \text{---} \text{---} \text{---} \text{---} \begin{array}{c} \mathring{G}_j^+ \\ \dashrightarrow \end{array} =$$

$$\begin{aligned}
&k^2 \left[ (Z_G^\pm)_{1i} (Z_G^\pm)_{1j} + (Z_G^\pm)_{2i} (Z_G^\pm)_{2j} \right] \\
&- \left[ \mathring{\xi}_{W_1} (M_{W_1}^2 + \delta M_{W_1}^2) (Z_G^\pm)_{1i} (Z_G^\pm)_{1j} + \mathring{\xi}_{W_2} (M_{W_2}^2 + \delta M_{W_2}^2) (Z_G^\pm)_{2i} (Z_G^\pm)_{2j} \right].
\end{aligned}$$

From any renormalization conditions  $\Rightarrow (Z_G^\pm)_{11}, (Z_G^\pm)_{12}, (Z_G^\pm)_{22}$ .

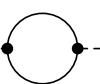
For neutral Goldstone - bosons there is a similar situation:

$$\begin{array}{c} \mathring{G}_i^0 \\ \dashrightarrow \end{array} \text{---} \text{---} \text{---} \text{---} \begin{array}{c} \mathring{G}_j^0 \\ \dashrightarrow \end{array} = F_{ij}^0(k^2), \quad i \geq j,$$

$$\begin{array}{c} \mathring{G}_i^0 \\ \dashrightarrow \end{array} \text{---} \text{---} \text{---} \text{---} \begin{array}{c} \mathring{G}_j^0 \\ \dashrightarrow \end{array} =$$

$$\begin{aligned}
&k^2 \left[ (Z_G^0)_{1i} (Z_G^0)_{1j} + (Z_G^0)_{2i} (Z_G^0)_{2j} \right] \\
&- \left[ \mathring{\xi}_{Z_1} (M_{Z_1}^2 + \delta M_{Z_1}^2) (Z_G^0)_{1i} (Z_G^0)_{1j} + \mathring{\xi}_{Z_2} (M_{Z_2}^2 + \delta M_{Z_2}^2) (Z_G^0)_{2i} (Z_G^0)_{2j} \right].
\end{aligned}$$

And from any renormalization conditions  $\Rightarrow (Z_G^0)_{11}, (Z_G^0)_{12}, (Z_G^0)_{22}$ .

**b. Faddeev - Popov ghosts.** For charged Faddeev - Popov ghosts there are four inverse propagators and four counter terms to them:

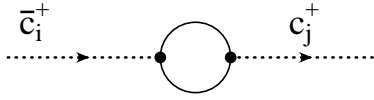
$$\bar{c}_i^+ \text{---} \bullet \text{---} \text{---} \bullet \text{---} c_j^+ = \gamma_{ij}^+(k^2), \quad i, j = 1, 2,$$

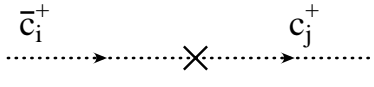
$$\bar{c}_i^+ \text{---} \times \text{---} c_j^+ = i \left( -k^2 + \overset{\circ}{\xi}_{W_i} (M_{W_i}^2 + \delta M_{W_i}^2) \right) \tilde{Z}_{W_i W_j}^{\frac{1}{2}}.$$

From any renormalization condition, four renormalization constants  $\tilde{Z}_{W_i W_j}^{\frac{1}{2}}$  ( $i, j = 1, 2$ ) will be determined.

For neutral Faddeev - Popov ghosts there are nine inverse propagators and the same number of counter terms:

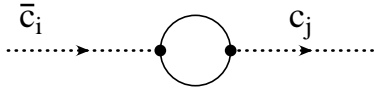
$$\bar{c}_i \text{---} \bullet \text{---} \text{---} \bullet \text{---} c_j = \gamma_{ij}^0(k^2), \quad i, j = Z_1, Z_2, A,$$

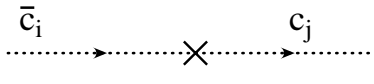
$$\bar{c}_i \text{---} \times \text{---} c_j = i \left( -k^2 + \overset{\circ}{\xi}_i (M_i^2 + \delta M_i^2) \right) \tilde{Z}_{ij}^{\frac{1}{2}}.$$

The already determined renormalization constants make finite all other two - point functions.

#### 4.2.3 Renormalization of couplings, mixing angles and mixing matrices.

As it was mentioned in section 4.1.3 there are more free parameters in the left - right symmetric model than in SM. To calculate the renormalization constants for them, additional renormalization conditions must be imposed. In the next section the renormalization of charge is performed. Subsequently, the renormalization of mixing angles  $\varphi$ ,  $\Theta_W$ ,  $\xi$  and mixing matrices is analyzed.

### 4.2.3.1 Renormalization of charge.

In order to calculate the renormalization constant for charge ( $\delta Y$ ), the  $A^\mu e^- e^+$  vertex is considered

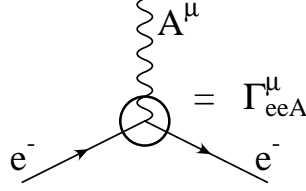

Renormalization condition

Renormalization constant

$$\bar{u}(m_e)\Gamma_{eeA}^\mu u(m_e) |_{k^2=0} = 0 \quad \Rightarrow \quad \delta Y. \quad (265)$$

The vertex  $\Gamma_{eeA}^\mu$  contains the counter term part and the proper vertex of all the Feynman diagrams

$$\Gamma_{eeA}^\mu = ie\gamma^\mu (\Gamma_{CT}^{eeA} + \Gamma_D^{eeA}). \quad (266)$$

Putting the definitions of appropriate renormalization constants from Chapter 4.1 to  $L_{NC}^{(l)}$  (Eq.(97)), the following form of  $\Gamma_{eeA}^\mu$  in one loop approximation is obtained

$$\begin{aligned} \Gamma_{CT}^{eeA} = & - \left[ \delta Y + \delta Z_{AA}^{\frac{1}{2}} + (\delta Z_L^l)_{ee} P_L + (\delta Z_R^l)_{ee} P_R \right] \\ & + Z_{Z_1 A}^{\frac{1}{2}} \frac{1}{\sin 2\Theta_W} \left[ \left( \cos \varphi (-1 + 2 \sin^2 \Theta_W) - \sin \varphi \frac{\sin^2 \Theta_W}{\sqrt{\cos 2\Theta_W}} \right) P_L \right. \\ & \left. + \left( 2 \cos \varphi \sin^2 \Theta_W + \sin \varphi \frac{1 - 3 \sin^2 \Theta_W}{\sqrt{\cos 2\Theta_W}} \right) P_R \right] \\ & + Z_{Z_2 A}^{\frac{1}{2}} \frac{1}{\sin 2\Theta_W} \left[ \left( \sin \varphi (-1 + 2 \sin^2 \Theta_W) + \cos \varphi \frac{\sin^2 \Theta_W}{\sqrt{\cos 2\Theta_W}} \right) P_L \right. \\ & \left. + \left( 2 \sin \varphi \sin^2 \Theta_W + \cos \varphi \frac{-1 + 3 \sin^2 \Theta_W}{\sqrt{\cos 2\Theta_W}} \right) P_R \right], \end{aligned} \quad (267)$$

where

$$(\delta Z_{L,R}^l)_{ee} = (\delta Z_{L,R}^{l\frac{1}{2}})_{ee} + (\delta Z_{L,R}^{l\frac{1}{2}})_{ee}^\dagger. \quad (268)$$

### 4.2.3.2 Renormalization of mixing angle in neutral sector ( $\phi$ ) and mixing angle $\Theta_W$ .

In order to calculate the  $\delta G_\varphi$  and  $\delta G_{\Theta_W}$  renormalization constants an additional vertex -  $Z_1 e^- e^+$  is exploited

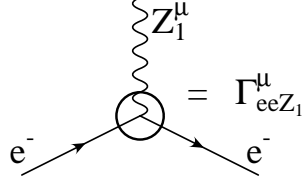

By considering renormalization conditions separately for vector and axial vector parts, two renormalization constants can be obtained

Renormalization conditions

Renormalization constants

$$\bar{u}(m_e)\Gamma_{eeZ_1}^\mu u(m_e) |_{k^2=M_{Z_1}^2} = 0 \quad \left( \begin{array}{l} \text{from the vector} \\ \text{and axial vector parts} \end{array} \right) \Rightarrow \delta G_\varphi, \delta G_{\Theta_W}. \quad (269)$$

Similarly as in previous two sections,  $\Gamma_{eeZ_1}^\mu$  can be split into two terms

$$\Gamma_{eeZ_1}^\mu = ie\gamma^\mu \left( \Gamma_{CT}^{eeZ_1} + \Gamma_D^{eeZ_1} \right). \quad (270)$$

By applying definitions from Chapter 4.1 to Eq.(97), for the one loop level the following form of counter term ensues

$$\begin{aligned} \Gamma_{CT}^{eeZ_1} = & \left[ \left( \delta Y + (\delta Z_L^l)_{ee} + \delta Z_{Z_1 Z_1}^{\frac{1}{2}} + \delta G_\varphi + \delta G_{\Theta_W} \frac{1}{\cos^2 \Theta_W (-1 + 2 \sin^2 \Theta_W)} \right) \right. \\ & \times \left( \cos \varphi \frac{(-1 + 2 \sin^2 \Theta_W)}{\sin 2\Theta_W} \right) \\ & + \left( \delta Y + (\delta Z_L^l)_{ee} + \delta Z_{Z_1 Z_1}^{\frac{1}{2}} - \delta G_\varphi \cot^2 \varphi + \delta G_{\Theta_W} \frac{(1 - 2 \sin^4 \Theta_W)}{(1 - \sin^2 \Theta_W)(1 - 2 \sin^2 \Theta_W)} \right) \\ & \times \left. \left( \sin \varphi \frac{(-\sin^2 \Theta_W)}{\sin 2\Theta_W \sqrt{\cos 2\Theta_W}} \right) \right] P_L \\ & + \left[ \left( \delta Y + (\delta Z_R^l)_{ee} + \delta Z_{Z_1 Z_1}^{\frac{1}{2}} + \delta G_\varphi + \delta G_{\Theta_W} \frac{1}{\cos^2 \Theta_W} \right) \times \left( \cos \varphi \frac{2 \sin^2 \Theta_W}{\sin 2\Theta_W} \right) \right. \\ & + \left( \delta Y + (\delta Z_R^l)_{ee} + \delta Z_{Z_1 Z_1}^{\frac{1}{2}} - \delta G_\varphi \cot^2 \phi \right. \\ & + \left. \delta G_{\Theta_W} \frac{-3 \sin^2 \Theta_W + 6 \sin^4 \Theta_W - 6 \sin^6 \Theta_W + 1}{(-1 + 3 \sin^2 \Theta_W)(1 - \sin^2 \Theta_W)(1 - 2 \sin^2 \Theta_W)} \right) \\ & \times \left. \left( \sin \varphi \frac{(1 - 3 \sin^2 \Theta_W)}{\sin 2\Theta_W \sqrt{\cos 2\Theta_W}} \right) \right] P_R \\ & + Z_{Z_2 Z_1}^{\frac{1}{2}} \left[ \left( \cos \varphi \frac{\sin^2 \Theta_W}{\sin 2\Theta_W \sqrt{\cos 2\Theta_W}} + \sin \varphi \frac{(-1 + 2 \sin^2 \Theta_W)}{\sin 2\Theta_W} \right) P_L \right. \\ & + \left. \left( \cos \varphi \frac{(-1 + 3 \sin^2 \Theta_W)}{\sin 2\Theta_W \sqrt{\cos 2\Theta_W}} + \sin \varphi \frac{2 \sin^2 \Theta_W}{\sin 2\Theta_W} \right) P_R \right] - Z_{AZ_1}^{\frac{1}{2}}. \quad (271) \end{aligned}$$

### 4.2.3.3 Renormalization of mixing angle in charged sector ( $\xi$ ).

The renormalization constant for mixing angle in charged sector ( $\delta G_\xi$ ) can be determined from the  $W_1 \nu_i e$  vertex

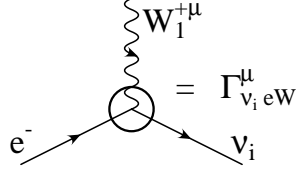

Renormalization condition      Renormalization constant

$$\bar{u}(m_{\nu_i}) \Gamma_{N_i e W_1}^\mu u(m_e) |_{k^2=M_{W_1}^2} = 0 \quad \Rightarrow \quad \delta G_\xi. \quad (272)$$

Similarly as for  $A^\mu e^- e^+$  vertex,  $\Gamma_{\nu_i e W_1}^\mu$  is the sum of the counter term and Feynman diagrams part

$$\Gamma_{N_i e W_1}^\mu = ie\gamma^\mu \left( \Gamma_{CT}^{N_i e W_1} + \Gamma_D^{N_i e W_1} \right). \quad (273)$$

After setting to  $L_{CC}^{(l)}$  (Eq.(94)) the definitions of appropriate renormalization constants from Chapter 4.1, in one loop approximation the counter term reads

$$\begin{aligned} \Gamma_{CT}^{N_i e W_1} = & \frac{\cos \xi}{\sqrt{2} \sin \Theta_W} \left\{ \left[ \delta Y + \delta Z_{W_1 W_1}^{\frac{1}{2}} - \delta G_{\Theta_W} - \delta G_\xi \frac{\sin^2 \xi}{\cos^2 \xi} \right] (K_L)_{Ie} \right. \\ & + \frac{1}{2} \sum_A \left( (\delta Z_L^{\nu \frac{1}{2}})_{IA} + (\delta Z_L^{\nu \frac{1}{2}})_{IA}^\dagger \right) (K_L)_{Ae} \\ & + \frac{1}{2} \sum_b \left( (\delta Z_L^{l \frac{1}{2}})_{be} + (\delta Z_L^{l \frac{1}{2}})_{be}^\dagger \right) (K_L)_{Ib} + Z_{W_2 W_1}^{\frac{1}{2}} \frac{\sin \xi}{\sqrt{2} \sin \Theta_W} (K_L)_{Ie} \left. \right\} P_L \\ & - \frac{\sin \xi}{\sqrt{2} \sin \Theta_W} \left\{ \left[ \delta Y + \delta Z_{W_1 W_1}^{\frac{1}{2}} - \delta G_{\Theta_W} + \delta G_\xi \right] (K_R)_{Ie} \right. \\ & + \frac{1}{2} \sum_A \left( (\delta Z_R^{\nu \frac{1}{2}})_{IA} + (\delta Z_R^{\nu \frac{1}{2}})_{IA}^\dagger \right) (K_R)_{Ae} \\ & + \frac{1}{2} \sum_b \left( (\delta Z_R^{l \frac{1}{2}})_{be} + (\delta Z_R^{l \frac{1}{2}})_{be}^\dagger \right) (K_R)_{Ib} + Z_{W_2 W_1}^{\frac{1}{2}} \frac{\cos \xi}{\sqrt{2} \sin \Theta_W} (K_R)_{Ie} \left. \right\} P_R. \end{aligned} \quad (274)$$

### 4.2.3.4 Renormalization of mixing matrices.

The renormalization of the mixing matrices  $U_{L,R}^{CKM}$  in the quark sector and  $K_{L,R}$  in the weak charged current Lagrangian has already been analyzed [46], [47]. In this section the renormalization of mixing matrices in the weak neutral current sector ( $\Omega_{L,R}$ ) is performed.

First, let us consider the left handed part of the unrenormalized charged current interactions (for the right handed part all formulas are analogous) in the form

$$\left(\overset{\circ}{L}CC\right)_{left} \propto \overset{\circ}{N} \gamma^\mu P_L \overset{\circ}{K} \overset{\circ}{l}. \quad (275)$$

In terms of the renormalized quantities the right hand side of Eq.(275) reads

$$\begin{aligned} \bar{N}_L Z_L^{\nu\frac{1}{2}\dagger} \gamma^\mu (K_L + \delta K_L) Z_L^{l\frac{1}{2}} l_L &= \bar{N}_L \left(1 + \frac{1}{2}\delta Z_L^{\nu\dagger}\right) \gamma^\mu (K_L + \delta K_L) \left(1 + \frac{1}{2}\delta Z_L^l\right) l_L \\ &= (J_L^\mu)_{CC} + (\delta J_L^\mu)_{CC}, \end{aligned} \quad (276)$$

where

$$\begin{aligned} (\delta J_L^\mu)_{CC} &= \bar{N}_L \gamma^\mu \left(\frac{1}{2}\delta Z_L^{\nu\dagger} K_L + \delta K_L + \frac{1}{2}K_L \delta Z_L^l\right) l_L \\ &= \bar{N}_L \gamma^\mu \left(\frac{1}{2}\delta Z_L^{\nu\dagger} K_L + \delta K_L + \frac{1}{2}K_L \delta Z_L^l\right) l_L + \bar{N}_L \gamma^\mu \left(\frac{1}{4}\delta Z_L^\nu K_L - \frac{1}{4}\delta Z_L^\nu K_L\right) l_L \\ &\quad + \bar{N}_L \gamma^\mu \left(\frac{1}{4}K_L \delta Z_L^{l\dagger} - \frac{1}{4}K_L \delta Z_L^{l\dagger}\right) l_L. \end{aligned} \quad (277)$$

Using the formulas (satisfied both for the bare and renormalized quantities):

$$K_L = V_L^{\nu\dagger} V_L^l, \quad (278)$$

$$V_L^\nu V_L^{\nu\dagger} = I, \quad (279)$$

$$V_L^l V_L^{l\dagger} = V_L^{l\dagger} V_L^l = I, \quad (280)$$

in one loop approximation one gets

$$\begin{aligned} \overset{\circ}{V}_L^{\nu\dagger} \overset{\circ}{V}_L^l &= \left(V_L^{\nu\dagger} + \delta V_L^{\nu\dagger}\right) \left(V_L^l + \delta V_L^l\right) = K_L + V_L^{\nu\dagger} \delta V_L^l + \delta V_L^{\nu\dagger} V_L^l = K_L + \delta V_L^{\nu\dagger} V_L^\nu K_L + K_L V_L^{l\dagger} \delta V_L^l \\ &= K_L + \delta K_L, \end{aligned} \quad (281)$$

and thus

$$\begin{aligned} (\delta J_L^\mu)_{CC} &= \bar{N}_L \gamma^\mu \left\{ \frac{1}{4} \left( \delta Z_L^{\nu\dagger} + \delta Z_L^\nu \right) K_L + \frac{1}{4} K_L \left( \delta Z_L^l + \delta Z_L^{l\dagger} \right) \right\} l_L \\ &\quad + \bar{N}_L \gamma^\mu \left[ \frac{1}{4} \left( \delta Z_L^{\nu\dagger} - \delta Z_L^\nu \right) + \delta V_L^{\nu\dagger} V_L^\nu \right] K_L l_L \\ &\quad + \bar{N}_L \gamma^\mu K_L \left[ \frac{1}{4} \left( \delta Z_L^l - \delta Z_L^{l\dagger} \right) + V_L^{l\dagger} \delta V_L^l \right] l_L. \end{aligned} \quad (282)$$

We may fix  $\delta V_L^{\nu\dagger}$  and  $\delta V_L^\nu$  by requiring that the antihermitian part in Eq.(282) (i.e. the terms in square brackets) vanishes:

$$\delta V_L^{\nu\dagger} = -\frac{1}{4} \left( \delta Z_L^{\nu\dagger} - \delta Z_L^\nu \right) V_L^{\nu\dagger}, \quad (283)$$



$$\delta V_L^\nu = -\frac{1}{4}V_L^\nu \left( \delta Z_L^\nu - \delta Z_L^{\nu\dagger} \right). \quad (284)$$

The same procedure used for the right part of the neutral current Lagrangian yields similar expressions for  $\delta V_R^\nu$  and  $\delta V_R^{\nu\dagger}$ :

$$\delta V_R^{\nu\dagger} = -\frac{1}{4} \left( \delta Z_R^{\nu\dagger} - \delta Z_R^\nu \right) V_R^{\nu\dagger}, \quad (285)$$

$$\delta V_R^\nu = -\frac{1}{4}V_R^\nu \left( \delta Z_R^\nu - \delta Z_R^{\nu\dagger} \right). \quad (286)$$

Let us consider now the left handed part of the unrenormalized neutral current interactions (for the right handed part all formulas are analogous) in the form

$$\left( \overset{\circ}{L}_{NC} \right)_{left} \propto \overset{\circ}{N} \gamma^\mu P_L \overset{\circ}{\Omega}_L \overset{\circ}{N}. \quad (287)$$

Rewriting the right side of Eq.(287) in terms of renormalized quantities one gets

$$\begin{aligned} \bar{N}_L Z_L^{\nu\frac{1}{2}\dagger} \gamma^\mu (\Omega_L + \delta\Omega_L) Z_L^{\nu\frac{1}{2}} N_L &= \bar{N}_L \left( 1 + \frac{1}{2}\delta Z_L^{\nu\dagger} \right) \gamma^\mu (\Omega_L + \delta\Omega_L) \left( 1 + \frac{1}{2}\delta Z_L^\nu \right) N_L \\ &= (J_L^\mu)_{NC} + (\delta J_L^\mu)_{NC}, \end{aligned} \quad (288)$$

with the following expression for  $(\delta J_L^\mu)_{NC}$

$$\begin{aligned} (\delta J_L^\mu)_{NC} &= \bar{N}_L \gamma^\mu \left( \frac{1}{2}\delta Z_L^{\nu\dagger} \Omega_L + \delta\Omega_L + \frac{1}{2}\Omega_L \delta Z_L^\nu \right) N_L \\ &= \bar{N}_L \gamma^\mu \left( \frac{1}{2}\delta Z_L^{\nu\dagger} \Omega_L + \delta\Omega_L + \frac{1}{2}\Omega_L \delta Z_L^\nu \right) N_L + \bar{N}_L \gamma^\mu \left( \frac{1}{4}\delta Z_L^\nu \Omega_L - \frac{1}{4}\delta Z_L^\nu \Omega_L \right) N_L \\ &\quad + \bar{N}_L \gamma^\mu \left( \frac{1}{4}\Omega_L \delta Z_L^{\nu\dagger} - \frac{1}{4}\Omega_L \delta Z_L^{\nu\dagger} \right) N_L. \end{aligned} \quad (289)$$

Applying the formula

$$\Omega_L = V_L^{\nu\dagger} V_L^\nu \quad (290)$$

satisfied for the bare and renormalized quantities, at the one loop level one obtains

$$\begin{aligned} \overset{\circ}{V}_L^{\nu\dagger} \overset{\circ}{V}_L^\nu &= \left( V_L^{\nu\dagger} + \delta V_L^{\nu\dagger} \right) \left( V_L^\nu + \delta V_L^\nu \right) = \Omega_L + V_L^{\nu\dagger} \delta V_L^\nu + \delta V_L^{\nu\dagger} V_L^\nu = \Omega_L + \Omega_L V_L^{\nu\dagger} \delta V_L^\nu + \delta V_L^{\nu\dagger} V_L^\nu \Omega_L \\ &= \Omega_L + \delta\Omega_L \end{aligned} \quad (291)$$

and further

$$\begin{aligned} (\delta J_L^\mu)_{NC} &= \bar{N}_L \gamma^\mu \left\{ \frac{1}{4} \left( \delta Z_L^{\nu\dagger} + \delta Z_L^\nu \right) \Omega_L + \frac{1}{4}\Omega_L \left( \delta Z_L^\nu + \delta Z_L^{\nu\dagger} \right) \right\} N_L \\ &\quad + \bar{N}_L \gamma^\mu \left[ \frac{1}{4} \left( \delta Z_L^{\nu\dagger} - \delta Z_L^\nu \right) \Omega_L + \delta V_L^{\nu\dagger} V_L^\nu \Omega_L \right] N_L \\ &\quad + \bar{N}_L \gamma^\mu \left[ \frac{1}{4}\Omega_L \left( \delta Z_L^\nu - \delta Z_L^{\nu\dagger} \right) + \Omega_L V_L^{\nu\dagger} \delta V_L^\nu \right] N_L. \end{aligned} \quad (292)$$

It is easy to see that after using the formulas from Eq.(283) and Eq.(284), the antihermitian part in Eq.(292) (i.e. the terms written in square brackets) cancels, and when the mixing matrices for the charged currents  $K_L$ ,  $K_R$  are renormalized the matrices  $\Omega_{L,R}$  are renormalized as well.

# V Renormalization of the Z - two Majorana neutrinos vertex ( $Z_1 N_i N_j$ ) in the frame of the left - right symmetric model.

In the previous Chapter the method to renormalize the left - right symmetric model was presented. Analyzing the procedure, it is easy to realize that the expressions used for renormalization of the left - right symmetric model are much more complicated than for SM. First of all, there are more fields (and what follows more masses) that have to be renormalized. More particles in the model means more Feynman diagrams one has to take into account when calculating processes. Furthermore, additional renormalization conditions for new free parameters ( $\phi, \xi, \Omega_{L,R}, K_{L,R}$ ) must be imposed.

To have a good test whether the method developed in Chapter IV works a cancelation of the infinite part (ultraviolet divergences) in the  $Z_1 N_i N_j$  vertex in the next section is verified. In Chapter 5.1 the general renormalization scheme for the  $Z_1 N_i N_j$  vertex is presented. Then, in Chapter 5.2 the calculation of the necessary renormalization constants is performed. Finally, in Chapter 5.3 the numerical calculations for the  $Z_1 N_i N_j$  vertex are described.

## 5.1 THE GENERAL SCHEME - DEFINITIONS OF THE COUNTER TERMS.

Having the definitions of renormalization constants and appropriate renormalization conditions we can go to the renormalization of the  $Z_1 N_i N_j$  vertex

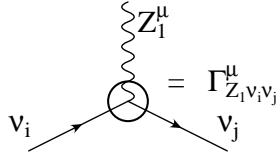

As usually, the full  $Z_1 N_i N_j$  vertex is the sum of the counter term part and proper vertex of all the Feynman diagrams

$$\Gamma_{Z_1 N_i N_j}^\mu = ie\gamma^\mu \left( \Gamma_{CT}^{Z_1 N_i N_j} + \Gamma_D^{Z_1 N_i N_j} \right). \quad (293)$$

We can decompose the counter term part into left and right components

$$\Gamma_{CT}^{Z_1 N_i N_j} \equiv (P_L(CT)_L + P_R(CT)_R). \quad (294)$$

The following bare Lagrangian (see Eq.(97,98)) contributes to the  $Z_1 N_i N_j$  vertex

$$\begin{aligned}
\mathring{L}_{Z_1\nu_i\nu_j} = & \frac{\mathring{e}}{2 \sin \Theta_W \mathring{\cos} \Theta_W} \sum_{a,b} \left\{ \mathring{N}_a \gamma^\mu P_L \left( \mathring{A}_L^{1\nu} (\mathring{\Omega}_L)_{ab} - \mathring{A}_R^{1\nu} (\mathring{\Omega}_R)_{ba} \right) \mathring{N}_b \mathring{Z}_{1\mu} + \right. \\
& \mathring{N}_a \gamma^\mu P_R \left( \mathring{A}_R^{1\nu} (\mathring{\Omega}_R)_{ab} - \mathring{A}_L^{1\nu} (\mathring{\Omega}_L)_{ba} \right) \mathring{N}_b \mathring{Z}_{1\mu} + \\
& \mathring{N}_a \gamma^\mu P_L \left( \mathring{A}_L^{2\nu} (\mathring{\Omega}_L)_{ab} - \mathring{A}_R^{2\nu} (\mathring{\Omega}_R)_{ba} \right) \mathring{N}_b \mathring{Z}_{2\mu} + \\
& \left. \mathring{N}_a \gamma^\mu P_R \left( \mathring{A}_R^{2\nu} (\mathring{\Omega}_R)_{ab} - \mathring{A}_L^{2\nu} (\mathring{\Omega}_L)_{ba} \right) \mathring{N}_b \mathring{Z}_{2\mu} \right\}. \tag{295}
\end{aligned}$$

To be consistent with the definitions of renormalization constants from section 4.1.3, the couplings  $A_{L,R}^{1,2\nu}$  should be taken in the form:

$$\mathring{A}_L^{1\nu} = \mathring{\cos} \phi - \sqrt{1 - \mathring{\cos}^2 \phi} \frac{\mathring{\sin}^2 \Theta_W}{\sqrt{1 - 2 \mathring{\sin}^2 \Theta_W}}, \tag{296}$$

$$\mathring{A}_R^{1\nu} = -\sqrt{1 - \mathring{\cos}^2 \phi} \frac{1 - \mathring{\sin}^2 \Theta_W}{\sqrt{1 - 2 \mathring{\sin}^2 \Theta_W}}, \tag{297}$$

$$\mathring{A}_L^{2\nu} = \sqrt{1 - \mathring{\cos}^2 \phi} + \mathring{\cos} \phi \frac{\mathring{\sin}^2 \Theta_W}{\sqrt{1 - 2 \mathring{\sin}^2 \Theta_W}}, \tag{298}$$

$$\mathring{A}_R^{2\nu} = \mathring{\cos} \phi \frac{1 - \mathring{\sin}^2 \Theta_W}{\sqrt{1 - 2 \mathring{\sin}^2 \Theta_W}}. \tag{299}$$

After transformation to the renormalized quantities, (including renormalization of the mixing matrices  $\Omega_{L,R}$ ) the following form of  $(CT)_L$  and  $(CT)_R$  is obtained from Eq.(295):

$$\begin{aligned}
(CT)_L = & \frac{1}{\sin 2\Theta_W} \left\{ \left[ \delta Y - \delta G_{\Theta_W} \frac{1 - 2 \sin^2 \Theta_W}{\cos^2 \Theta_W} + \delta Z_{Z_1 Z_1}^{\frac{1}{2}} + \delta G_\varphi \right] \cos \varphi (\Omega_L)_{ji} \right. \\
& + \left[ \delta Y + \delta G_{\Theta_W} \frac{1 - 2 \sin^4 \Theta_W}{\cos^2 \Theta_W (1 - 2 \sin^2 \Theta_W)} + \delta Z_{Z_1 Z_1}^{\frac{1}{2}} - \delta G_\varphi \cot^2 \varphi \right] \\
& \times \sin \varphi \frac{-\sin^2 \Theta_W}{\sqrt{\cos 2\Theta_W}} (\Omega_L)_{ji} \\
& + \left[ \delta Y + \delta G_{\Theta_W} \frac{-1 + 4 \sin^2 \Theta_W - 2 \sin^4 \Theta_W}{\cos^2 \Theta_W (1 - 2 \sin^2 \Theta_W)} + \delta Z_{Z_1 Z_1}^{\frac{1}{2}} - \delta G_\varphi \cot^2 \varphi \right] \\
& \times \sin \varphi \frac{\cos^2 \Theta_W}{\sqrt{\cos 2\Theta_W}} (\Omega_R)_{ij} \\
& + Z_{Z_2 Z_1}^{\frac{1}{2}} \left[ \cos \varphi \frac{\sin^2 \Theta_W}{\sqrt{\cos 2\Theta_W}} + \sin \varphi \right] (\Omega_L)_{ji} - Z_{Z_2 Z_1}^{\frac{1}{2}} \cos \varphi \frac{\cos^2 \Theta_W}{\sqrt{\cos 2\Theta_W}} (\Omega_R)_{ij} \\
& + \left[ \frac{1}{2} \sum_A \left( (\delta Z_L^{\nu \frac{1}{2}})_{JA} + (\delta Z_L^{\nu \frac{1}{2}})_{JA}^\dagger \right) (\Omega_L)_{Ai} + \frac{1}{2} \sum_B \left( (\delta Z_L^{\nu \frac{1}{2}})_{BI} + (\delta Z_L^{\nu \frac{1}{2}})_{BI}^\dagger \right) (\Omega_L)_{jB} \right] \\
& \times \left( \cos \varphi + \sin \varphi \frac{-\sin^2 \Theta_W}{\sqrt{\cos 2\Theta_W}} \right)
\end{aligned}$$

$$\begin{aligned}
& + \left[ \frac{1}{2} \sum_A \left( (\delta Z_L^{\nu \frac{1}{2}})_{JA} + (\delta Z_L^{\nu \frac{1}{2}})_{JA}^\dagger \right) (\Omega_R)_{iA} + \frac{1}{2} \sum_B \left( (\delta Z_L^{\nu \frac{1}{2}})_{BI} + (\delta Z_L^{\nu \frac{1}{2}})_{BI}^\dagger \right) (\Omega_R)_{Bj} \right] \\
& \times \left( \sin \varphi \frac{\cos^2 \Theta_W}{\sqrt{\cos 2\Theta_W}} \right) \Big\},
\end{aligned} \tag{300}$$

$$\begin{aligned}
(CT)_R = & -\frac{1}{\sin 2\Theta_W} \left\{ \left[ \delta Y - \delta G_{\Theta_W} \frac{1 - 2 \sin^2 \Theta_W}{\cos^2 \Theta_W} + \delta Z_{Z_1 Z_1}^{\frac{1}{2}} + \delta G_\varphi \right] \cos \varphi (\Omega_L)_{ij} \right. \\
& + \left[ \delta Y + \delta G_{\Theta_W} \frac{1 - 2 \sin^4 \Theta_W}{\cos^2 \Theta_W (1 - 2 \sin^2 \Theta_W)} + \delta Z_{Z_1 Z_1}^{\frac{1}{2}} - \delta G_\varphi \cot^2 \varphi \right] \\
& \times \sin \varphi \frac{-\sin^2 \Theta_W}{\sqrt{\cos 2\Theta_W}} (\Omega_L)_{ij} \\
& + \left[ \delta Y + \delta G_{\Theta_W} \frac{-1 + 4 \sin^2 \Theta_W - 2 \sin^4 \Theta_W}{\cos^2 \Theta_W (1 - 2 \sin^2 \Theta_W)} + \delta Z_{Z_1 Z_1}^{\frac{1}{2}} - \delta G_\varphi \cot^2 \varphi \right] \\
& \times \sin \varphi \frac{\cos^2 \Theta_W}{\sqrt{\cos 2\Theta_W}} (\Omega_R)_{ji} \\
& + Z_{Z_2 Z_1}^{\frac{1}{2}} \left[ \cos \varphi \frac{\sin^2 \Theta_W}{\sqrt{\cos 2\Theta_W}} + \sin \varphi \right] (\Omega_L)_{ij} - Z_{Z_2 Z_1}^{\frac{1}{2}} \cos \varphi \frac{\cos^2 \Theta_W}{\sqrt{\cos 2\Theta_W}} (\Omega_R)_{ji} \\
& + \left[ \frac{1}{2} \sum_A \left( (\delta Z_R^{\nu \frac{1}{2}})_{JA} + (\delta Z_R^{\nu \frac{1}{2}})_{JA}^\dagger \right) (\Omega_L)_{iA} + \frac{1}{2} \sum_B \left( (\delta Z_R^{\nu \frac{1}{2}})_{BI} + (\delta Z_R^{\nu \frac{1}{2}})_{BI}^\dagger \right) (\Omega_L)_{Bj} \right] \\
& \times \left( \cos \varphi + \sin \varphi \frac{-\sin^2 \Theta_W}{\sqrt{\cos 2\Theta_W}} \right) \\
& + \left[ \frac{1}{2} \sum_A \left( (\delta Z_R^{\nu \frac{1}{2}})_{JA} + (\delta Z_R^{\nu \frac{1}{2}})_{JA}^\dagger \right) (\Omega_R)_{Ai} + \frac{1}{2} \sum_B \left( (\delta Z_R^{\nu \frac{1}{2}})_{BI} + (\delta Z_R^{\nu \frac{1}{2}})_{BI}^\dagger \right) (\Omega_R)_{jB} \right] \\
& \times \left( \sin \varphi \frac{\cos^2 \Theta_W}{\sqrt{\cos 2\Theta_W}} \right) \Big\}.
\end{aligned} \tag{301}$$

There is a symmetry between the left and the right part of the Lagrangian that allows us to check the cancelation of the infinite part only for one (left or right) component. In the section 5.3 the calculations for the left - handed part of  $Z_1 N_i N_j$  vertex are described.

## 5.2 CALCULATION OF THE RENORMALIZATION CONSTANTS.

In this section the calculations (in one loop approximation ) of the renormalization constants indispensable for renormalization of the  $Z_1 N_i N_j$  vertex are presented. All calculations are performed in the Feynman gauge ( $\xi = 1$ ).

### 5.2.1 Calculation of the renormalization constants for gauge bosons.

i) The renormalization constant  $Z_{Z_1 Z_1}^{\frac{1}{2}}$ .

The  $Z_{Z_1 Z_1}^{\frac{1}{2}}$  constant is obtained from renormalization condition (see Eq.(247))

$$A^{Z_1'}(M_{Z_1}^2) = 0. \quad (302)$$

After taking the counter term from Eq.(241) and splitting  $A^{Z_1}(k^2)$  into counter term part  $A_{CT}^{Z_1}(k^2)$  and Feynman diagram component  $A_D^{Z_1}(k^2)$ , Eq.(302) leads to

$$\sum_n A_{Dn}^{Z_1'}(M_{Z_1}^2) - 2Z_{Z_1 Z_1}^{\frac{1}{2}} = 0 \Rightarrow Z_{Z_1 Z_1}^{\frac{1}{2}} = \frac{1}{2} \sum_n A_{Dn}^{Z_1'}(M_{Z_1}^2), \quad (303)$$

where the sum in Eq.(303) is over all Feynman diagrams that contribute to the  $Z_1 - Z_1$  Green function (see Fig. 1).

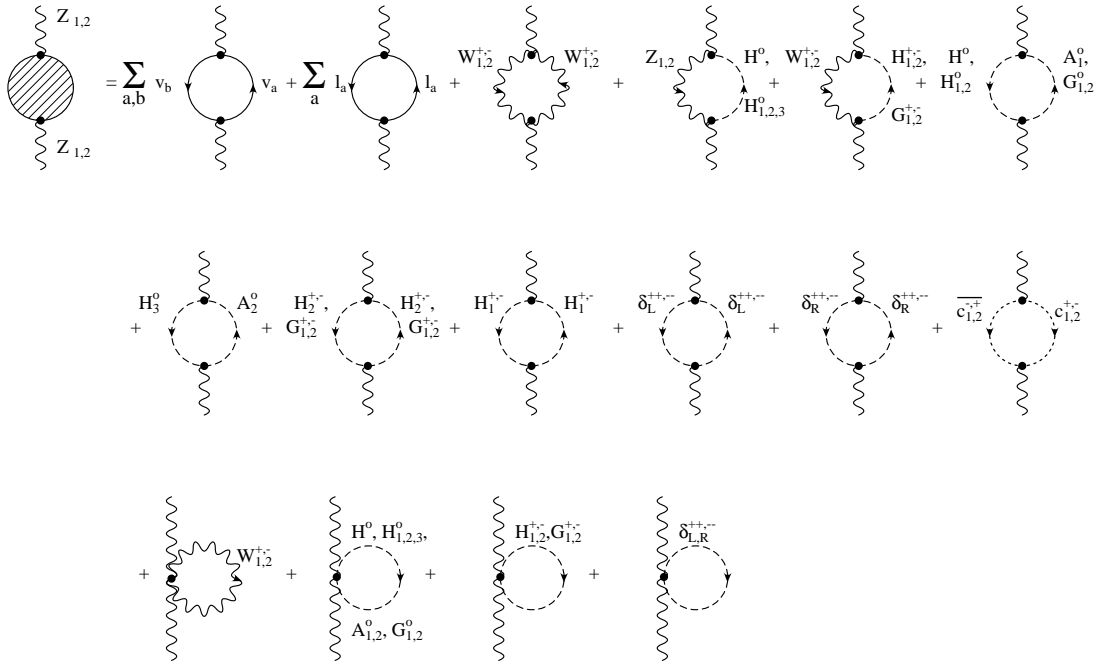

Fig.1

The  $Z_{1,2} - Z_{1,2}$  one loop Green functions.

ii) The renormalization constant  $Z_{AA}^{\frac{1}{2}}$ .

Taking the counter term from Eq.(244) and renormalization condition ( Eq.(247))

$$A^{A'}(0) = 0, \quad (304)$$

one gets the following expression for  $Z_{AA}^{\frac{1}{2}}$

$$Z_{AA}^{\frac{1}{2}} = \frac{1}{2} \sum_n A_{Dn}^{A'}(0). \quad (305)$$

Similarly like for  $Z_{Z_1 Z_1}^{\frac{1}{2}}$  the sum in Eq.(305) is over all Feynman diagrams that contribute to the  $A - A$  Green function (see Fig. 2).

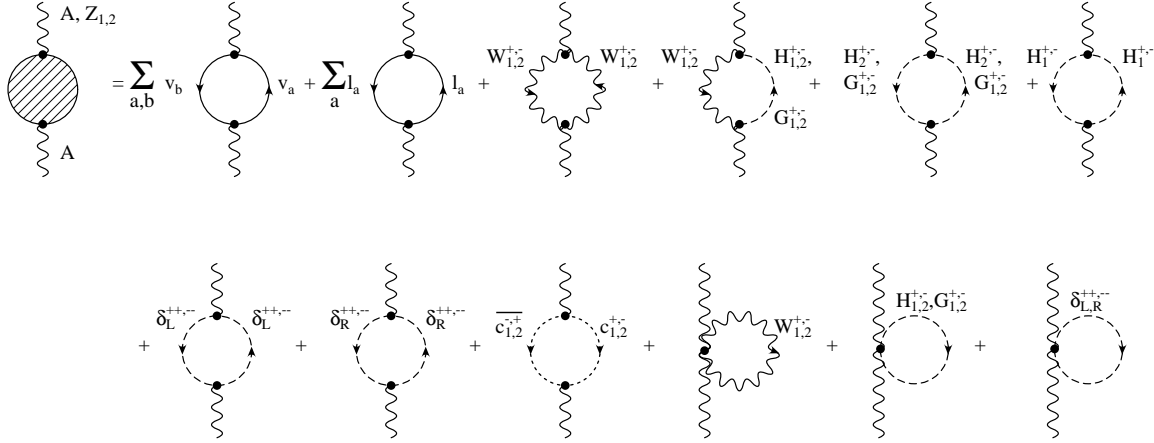

Fig.2

The  $A - A, Z_{1,2}$  one loop Green functions. The summation is over the neutrino ( $N_a, N_b$ ) and the charged lepton flavors ( $l_a$ ).

iii) The renormalization constant  $Z_{Z_1 A}^{\frac{1}{2}}$ .

From the counter term Eq.(245) and renormalization condition ( Eq.(247))

$$A^{Z_1 A}(0) = 0, \quad (306)$$

the following expression for  $Z_{Z_1 A}^{\frac{1}{2}}$  is obtained

$$Z_{Z_1 A}^{\frac{1}{2}} = -\frac{1}{M_{Z_1}^2} \sum_n A_{Dn}^{Z_1 A}(0). \quad (307)$$

The diagrams contributing to  $Z_1 - A$  Green function are presented in Fig. 2.

iv) The renormalization constant  $Z_{Z_2 A}^{\frac{1}{2}}$ .

Taking the counter term from Eq.(246) and renormalization condition ( Eq.(247))

$$A^{Z_2 A}(0) = 0, \quad (308)$$

one gets

$$Z_{Z_2 A}^{\frac{1}{2}} = -\frac{1}{M_{Z_2}^2} \sum_n A_{Dn}^{Z_2 A}(0). \quad (309)$$

The diagrams contributing to  $Z_2 - A$  Green function are the same as for  $Z_1 - A$  (see Fig. 2).

v) The renormalization constant  $Z_{AZ_1}^{\frac{1}{2}}$ .

From the counter term from Eq.(245) and renormalization condition ( Eq.(247))

$$A^{Z_1 A}(M_{Z_1}^2) = 0, \quad (310)$$

the following expression for  $Z_{AZ_1}^{\frac{1}{2}}$  is obtained

$$Z_{AZ_1}^{\frac{1}{2}} = \frac{1}{M_{Z_1}^2} \sum_n A_{Dn}^{Z_1 A}(M_{Z_1}^2). \quad (311)$$

The sum in Eq.(311) is also over diagrams presented in Fig. 2.

vi) The renormalization constant  $Z_{Z_2 Z_1}^{\frac{1}{2}}$ .

Taking the counter term from Eq.(243) and renormalization condition ( Eq.(247))

$$A^{Z_1 Z_2}(M_{Z_1}^2) = 0, \quad (312)$$

one gets

$$Z_{Z_2 Z_1}^{\frac{1}{2}} = \frac{1}{M_{Z_1}^2 - M_{Z_2}^2} \sum_n A_{Dn}^{Z_1 Z_2}(M_{Z_1}^2). \quad (313)$$

The sum is over diagrams given in Fig. 1.

### 5.2.2 Calculation of the renormalization constants for fermions.

First of all, one should notice that renormalization constants for fermions occur in  $\Gamma_{CT}^{eeA}$  (Eq.(267)) and  $(CT)_L$  (Eq.(300)) only in combination

$$\delta Z_{L,R}^{\frac{1}{2}} + \delta Z_{L,R}^{\frac{1}{2}\dagger}. \quad (314)$$

Hence, it is sufficient to find the expression for all terms from Eq.(314) not worrying about the form of particular elements. Furthermore, for the infinite part of  $A_L^{ij}$ ,  $A_R^{ij}$ ,  $B_L^{ij}$ ,  $B_R^{ij}$  the following relations take place:



$$\begin{aligned}
A_L^{ij}(m_j^2) &= A_L^{ij}(m_i^2) \equiv A_L^{ij}, \\
A_R^{ij}(m_j^2) &= A_R^{ij}(m_i^2) \equiv A_R^{ij}, \\
B_L^{ij}(m_j^2) &= B_L^{ij}(m_i^2) \equiv B_L^{ij}, \\
B_R^{ij}(m_j^2) &= B_R^{ij}(m_i^2) \equiv B_R^{ij}.
\end{aligned} \tag{315}$$

Using renormalization condition from Eq.(259) and counter term given in Eq.(257) one obtains:

$$\left[ \left( \delta Z_L^{\frac{1}{2}} \right)_{ij} + \left( \delta Z_L^{\frac{1}{2}\dagger} \right)_{ij} \right]_{infinite\ part} = -2B_L^{ij}, \tag{316}$$

$$\left[ \left( \delta Z_R^{\frac{1}{2}} \right)_{ij} + \left( \delta Z_R^{\frac{1}{2}\dagger} \right)_{ij} \right]_{infinite\ part} = -2B_R^{ij}. \tag{317}$$

Here indices  $i, j$  mean the charged lepton and neutrino flavors separately, and  $i = j$  or  $i \neq j$ . As usually index  $D$  means the Feynman diagrams contribution. The electron and neutrino self energy diagrams are presented in Fig. 3 and Fig. 4 respectively.

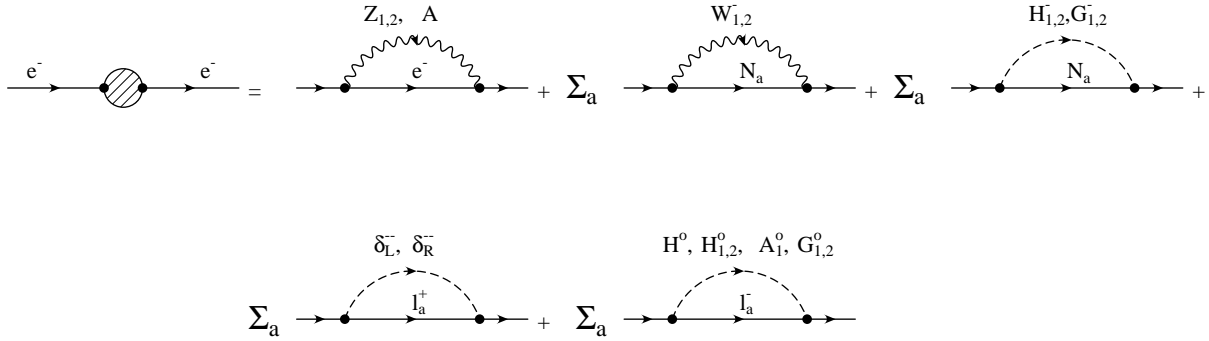

Fig.3

The electron one-loop self energy diagrams.

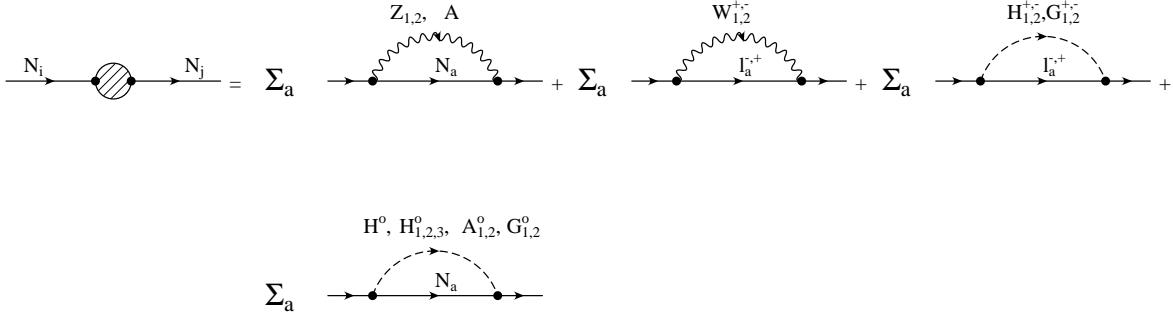

Fig.4

The neutrino one-loop self energy diagrams.

### 5.2.3 Calculation of the renormalization constant for charge.

Having renormalization constants for gauge bosons and fermions, the renormalization constant for charge ( $Y$ ) can be easily calculated from renormalization condition Eq.(265). The  $\Gamma_{CT}^{eeA}$  component of  $\Gamma_{eeA}^\mu$  is given in Eq.(267). The diagrams contributing to  $\Gamma_D^{eeA}$  are shown in Fig. 5.

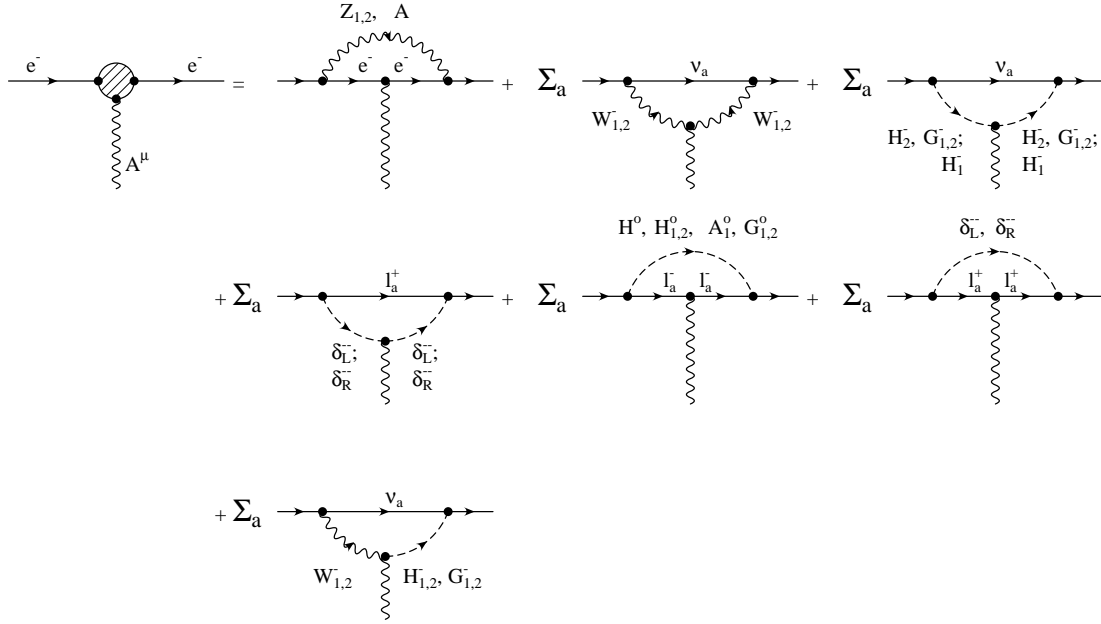

Fig.5

The one-loop diagrams for the  $Aee$  vertex.

### 5.2.4 Calculation of the renormalization constants for mixing angles $\phi$ and $\Theta_W$ .

Using renormalization constants for gauge bosons, fermions and charge, the renormalization constants  $\delta_{G_\phi}$  and  $\delta_{G_{\Theta_W}}$  are obtained from renormalization condition Eq.(269). The  $\Gamma_{CT}^{eeZ_1}$  component of  $\Gamma_{eeZ_1}^\mu$  is presented in Eq.(271). The diagrams contributing to  $\Gamma_D^{eeZ_1}$  are shown in Fig. 6.

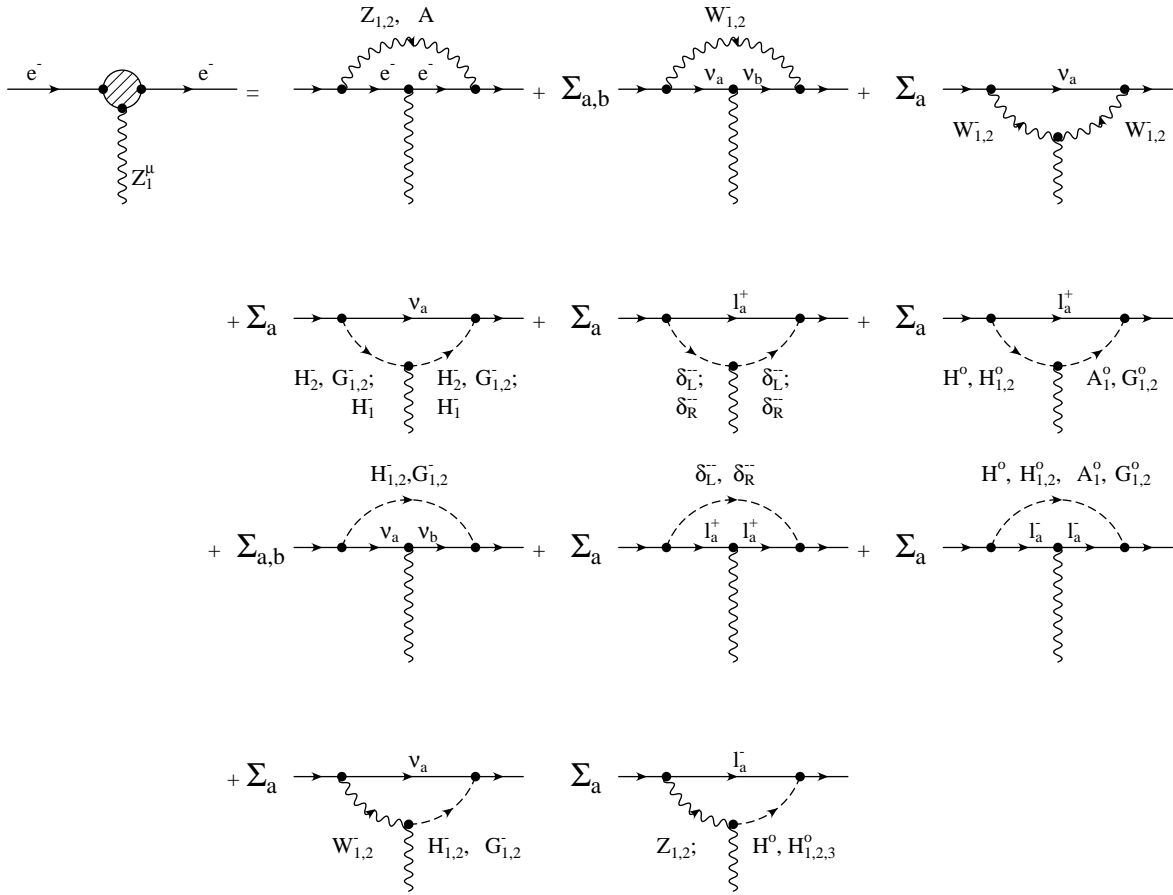

Fig.6

The one-loop diagrams for the  $Z_1 ee$  vertex.

### 5.3 INFINITE PART OF THE $Z_1 N_i N_j$ VERTEX AND RENORMALIZATION.

As it was already mentioned in Chapter 5.1, the symmetry between the left and the right part of the Lagrangian allows us to check the cancellation of the infinite part only for one (left or right) component of the  $\Gamma_{Z_1 N_i N_j}^\mu$ . For further consideration the left part has been chosen. Therefore, the following equation had to be verified (see Eq.(293,294))

$$\begin{aligned}
\left[ \left( \Gamma_{Z_1 N_i N_j}^\mu \right)_L \right]_{infinite\ part} &= ie\gamma^\mu \left[ \left( \Gamma_{CT}^{Z_1 N_i N_j} \right)_L + \left( \Gamma_D^{Z_1 N_i N_j} \right)_L \right]_{infinite\ part} \\
&= ie\gamma^\mu \left[ PL(CT)_L + \left( \Gamma_D^{Z_1 N_i N_j} \right)_L \right]_{infinite\ part} = 0.
\end{aligned} \tag{318}$$

The diagrams contributing to  $\Gamma_D^{Z_1 N_i N_j}$  are shown in Fig. 7.

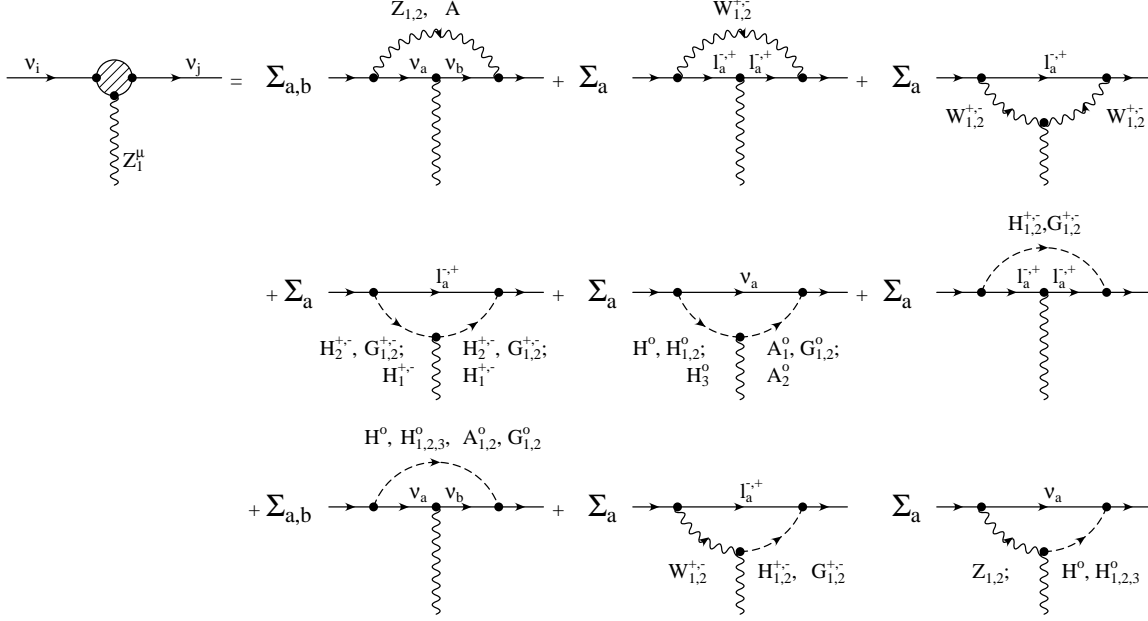

Fig.7

The one-loop diagrams for the  $Z_1 N_i N_j$  vertex.

As the first step of the calculations, the dimensional regularization for all necessary two and three point functions has been performed. Then, all needed couplings have been derived (see Figs.1-7), and the infinite part of all necessary renormalization constants and diagrams contributing to  $Z_1 N_i N_j$  vertex have been calculated. Since neutrinos are Majorana particles, little more complicated techniques must have been applied during the calculation of the diagrams (see [48]). Finally, a numerical calculation (with the help of "Mathematica" program) has been performed, proving the validity of Eq.(318). From the technical side it is worth noting that the infinite part of the renormalization constant for charge ( $Y$ ) has been found to be zero. Moreover, the calculations would not change if the  $Z_{Z_2 Z_1}^{\frac{1}{2}}$  constant were held as a variable (i.e. without putting its explicit value).

# VI Summary

The on mass shell scheme has been used to renormalize the manifest left-right symmetric model. We have given general conditions to renormalize the bulk of physical fields which enter the model. Also nonstandard parameters ( $\phi, \xi, \Omega_{L,R}, K_{L,R}$ ), connected with neutral and charged, left and right handed currents have been discussed and renormalized. Consistency of the scheme has been checked using the  $Z_1 N_i N_j$  vertex (cancelations of infinities).

## ACKNOWLEDGMENTS

This work was supported by Polish Committee for Scientific Researches under Grants No. 2 P03B 033 15 and 2 P03B 04215. J.G. appreciates also the support of the Alexander von Humboldt-Stiftung.

- 
- [1] W. Hollik, Proceedings of ICHEP'98, Vancouver 1998.
  - [2] A. Blondel, Proceedings of ICHEP'96, ed. Z. Ajduk and A.K. Wróblewski, Warszawa 1996.
  - [3] Super-Kamiokande Collaboration, (Y. Fukuda *et al.*), Phys. Rev. Lett. **81**; (1998) 1562.
  - [4] R. E. Shrock, in *Review of particle physics. Particle Data Group*, Phys. Rev. **D54** (1996) 1.
  - [5] J. C. Pati in Neutrino '98, Takayama, Japan, e-Print Archive: **hep-ph/980315**
  - [6] J.C. Pati and A. Salam, Phys. Rev. **D10** (1974) 275;  
R.N. Mohapatra, J.C.Pati, Phys. Rev. **D11** (1975) 2558;  
R.N. Mohapatra, J.C.Pati, *ibid.* **D11** (1975) 566;  
G. Senjanovic and R.N Mohapatra, *ibid.* **D12** (1975) 1502;  
R.N. Mohapatra, P.B. Pal, Phys. Rev. **D38** (1988) 2226;  
G. Senjanovic, Nucl. Phys. **B153** (1979) 334.
  - [7] H. Georgi and S.L. Glashow, Phys. Rev. Lett. **32** (1974) 438.
  - [8] R.N. Mohapatra and G. Senjanovic, Phys. Rev. Lett. **44** (1980) 912; Phys. Rev. **D21** (1981) 165;  
R.N. Mohapatra and R.E. Marshak, Phys. Rev. Lett. **44** (1980) 1316.
  - [9] T. Yanagida, *Proc. of the Workshop on Unified Theory and Baryon Number in the Universe*, eds. O. Sawada and A. Sugamoto (KEK, 79-18, 1979);  
M. Gell-Mann, P. Ramond, and R. Slansky, in *Supergravity*, ed. by P. van Nieuwenhuizen and D. Freedman (North-Holland, Amsterdam, 1979).
  - [10] R.N. Mohapatra and R.E. Marshak, Phys. Lett. **B91** (1980) 222;  
A. Davidson, Phys. Rev. **D20** 776 (1979).
  - [11] K.S. Babu, R.N. Mohapatra, Phys. Rev. **D41** (1990) 271;  
M. Zralek and J. Śladkowski, Phys. Rev. **D45** (1992) 1701.
  - [12] R.N. Mohapatra, *Unification and Supersymmetry*, Springer-Verlag, 1986.
  - [13] M.A.B. Beg and H.S. Tsao, Phys. Rev. Lett. **41** 278 (1978);  
R.N. Mohapatra and G. Senjanovic, Phys. Lett. **79B** 283 (1978).
  - [14] see e.g. K.S. Babu, C. Kolda and J. March-Russell, Europ. Phys. J. **C3** (1998) 252.
  - [15] F.I. Olness, M.E. Ebel, Phys. Rev. **D30** (1984) 1034;  
J.L. Hewett and T. Rizzo, *Contribution to Proc. of Snowmass Workshop, 1988 Summer Study of High Energy Physics in the 1990's, Snowmass, CO, Jun 27 - Jul 15, 1988*;  
J. Maalampi, *Signatures of left-right symmetry at high energies*, published in Tallinn Neutrino 1993 (hep-ph/9310295);  
J. Maalampi, A. Pietila, M. Raidal, Phys. Rev. **D48** (1993) 4467;  
K. Huitu, J. Maalampi, M. Raidal, Phys. Lett. **B365** (1996) 407;

- A. Pietila, J. Vuori, J. Maalampi, Turku-FL-R9, March 1993.
- [16] E. Accomando et al., Phys. Rep. **299** (1998) 1.
- [17] A. Djouadi, J. Ng, T. Rizzo, 'New particles and interactions', SLAC-PUB-95-6772 (hep-ph/9504210);  
T. Rizzo, Phys. Rev. **D50** (1994) 5602;  
H. Czyż , P. Duka, M. Zralek, Phys. Rev. **D49** (1994) 4941;  
H. Czyż , P. Duka, M. Zralek, in "New Physics with New Experiment.", Proc. of XVI Kazimierz Meeting on elementary particle Physics, Kazimierz, May 1993, ed. by Z. Ajduk, S. Pokorski, A.K. Wróblewski, World Scientific 1994, p.287.
- [18] Wai-Yee Keung and G. Senjanovic, Phys. Rev. Lett. **50** (1983) 1427;  
Ho Tso-hsiu, Ching Cheng-rui, Tao Zhi-jian, Phys. Rev. **D42** (1990) 2265;  
T. Rizzo, hep-ph/9609248;  
Dal Soo Oh, M.H. Reno, hep-ph/9812219.
- [19] W. Buchmüller and C. Greub, Phys. Lett. **B267** (1991) 395; Phys. Lett. **B256** (1991) 465.
- [20] For LEPI energy and below see e.g.:  
A. Ali, Phys. Rev. **D10** (1974) 2801;  
M. Gourdin, X.Y. Pham, Nucl. Phys. **B164** (1980) 387;  
J.L. Rosner, Nucl. Phys. **B248** (1984) 503;  
M. Ditmar, A. Santamaria, M.C. Gonzales-Garcia and J.W.F. Valle, Nucl. Phys. **B332** (1990)1;  
M.C. Gonzales-Garcia, A. Santamaria and J.W.F. Valle, Nucl. Phys. **B342** (1990) 108;  
J. Kugo and S.Y. Tsai Prog. Theor. Phys. **86** (1991) 183;  
J.W.F. Valle Nucl. Phys. Proc. Suppl. **48** (1996) 137;  
J.W.F. Valle, hep-ph/9603307;  
A. Hofer and L.M. Sehgal, Phys.Rev. **D54** (1996) 1944.
- [21] Above LEPI energy, see e.g.  
F. del Aguila, E. Laermann and P. Zerwas, Nucl. Phys. **B297** (1988)1;  
E. Ma and J. Pantaleone, Phys. Rev. **D40** (1989) 2172;  
W. Buchmüller and C. Greub, Nucl. Phys. **B363** (1991) 345 and **B381** (1992) 109;  
J. Maalampi, K. Mursula and R. Vuopionperä, Nucl. Phys. **B372** (1992)23;  
M.C. Gonzales-Garcia, O.J.P. Eboli, F. Halzen and S.F. Noaves Phys. Lett. **B280** (1992) 313;  
A. Djouadi, Z. Phys. **C63** (1994) 317;  
A. Djouadi and G. Azuelos, Z. Phys. **C63** (1994) 327;  
J. Gluza and M. Zralek, Phys. Rev. **D48** (1993) 5093; Phys. Rev. **D51** (1995) 4707; Acta Phys. Pol. **B27** (1996) 1557;  
Phys. Lett. **B372** (1996) 259; Phys. Rev. **D55** (1997) 7030;  
G. Cvetič and C.S. Kim, hep-ph/9906253; G. Cvetič, C.S. Kim and C.W. Kim, Phys. Rev. Lett. **82** (1999) 4761;  
P. Duka, J. Gluza, M. Zralek, Phys. Rev. **D58** (1998) 053009.
- [22] J. Gluza, J. Maalampi, M. Raidal and M. Zralek, Phys. Lett. **B407** (1997) 45.
- [23] D.A. Dicus, D.D. Karatas, P. Roy Phys. Rev. **D44** (1991) 2033;  
B. Mukhopadhyaya Phys. Rev. **D49** (1994) 1350;  
H. Tso-hsiu, Ch. Cheng-rui, T. Zhi-jian Phys. Rev. **D42** (1990) 2265;  
W. Buchmuller, C. Greub Nucl. Phys. **B381** (1992) 109;  
G. Ingelman, J. Rathsman Z. Phys. **C60** (1993) 243;  
A. Datta, M. Guchait, D.P. Roy Phys. Rev. **D47** (1993) 961;  
D.A. Dicus, P. Roy Phys. Rev. **D44** (1991) 1593.
- [24] *The Higgs Hunter's Guide* by J. F. Gunion, H. E. Haber, G. L. Kane and S. Dawson, Addison-Wesley Pub. Comp., Redwood City, CA, 1990.
- [25] V. Barger, J.F. Beacom, K. Cheung, Phys. Rev. **D50** (1994) 6704;  
J.A. Coarasa, A. Mendez, J. Sola, Phys. Lett. **B374** (1996) 131;  
J.F. Gunion, C. Loomis, K.T. Pitts, hep-ph/9610237;  
J.F. Gunion, Int. J. Mod. Phys., **A11** (1996) 1551;  
K. Huitu, J. Maalampi, A. Pietila, M. Raidal, Nucl. Phys. **B487** (1997) 27;  
G. Barenboim, K. Huitu, J. Maalampi, M. Raidal, Phys. Lett. **B394** (1997) 132;  
J. Gluza, Phys. Lett. **B403** (1997) 304.
- [26] J. Gunion, A. Mendez, F. Olness, Int. J. Mod. Phys. **A2** (1987) 1085.
- [27] F.I. Olness, M.E. Ebel, Phys. Rev. **D32** (1985) 1769.
- [28] R. N. Mohapatra, P.B. Pal, Phys. Lett. **B179** (1986) 105.

- [29] T. Rizzo, Phys.Lett.**B116** (1982)23;  
D. London, G. Belanger and J.N. Ng, Phys. Lett. **B188** (1987) 155;  
J. Maalampi, A. Pietila and J. Vuori, Nucl. Phys. **B381** (1992) 544;  
C.A. Heusch and P. Minkowski, Nucl. Phys. **B416** (1994) 3 and Phys. Lett. **B374** (1996) 116;  
P. Helde, K. Huitu, J. Maalampi, M. Raidal, Nucl. Phys. **B437** (1995) 305;  
J. Gluza and M. Zralek, Phys. Rev. **D52** (1995) 6238; Phys. Lett. **B362** (1995) 148;  
T. Rizzo Int. J. Mod. Phys. **A11** (1996) 1563.
- [30] T.P. Cheng and L.F. Li, Phys. Rev.**D44** (1991) 1502;  
A. Ilakovac and A. Pilaftsis Nucl. Phys. **B437** (1995) 491;  
D. Tommasini, G. Barenboim, J. Bernabeu and C. Jarlskog, Nucl. Phys. **B444** (1995) 451;  
D. Wyler and L. Wolfenstein, Nucl. Phys. **B218** (1983) 205;  
R.N. Mohapatra and J.W.F. Valle, Phys. Rev. **D34** (1986) 1642;  
E. Witten, Nucl. Phys. **B268** (1986) 79;  
J. Bernabeu et al., Phys. Lett. **B187** (1987) 303;  
J.L. Hewett and T.G. Rizzo, Phys. Rep. **183** (1989) 193;  
E. Nardi, Phys. Rev. **D48** (1993) 3277;  
S. Pastor, S.D. Rindani and J.W. Valle, JHEP **05** (1999) 012.
- [31] D. Cocolicchio, G. L. Fogli, Phys. Rev. **D32** (1985) 3020; *ibid.*, **D35** (1987) 3462;  
G. Ecker, W. Grimus, H. Neufeld, Nucl. Phys. **B247** (1984) 70;  
P. Basak, A. Datta, Int. J. Mod. Phys. **A7** (1992) 6325.
- [32] F. del Aguila, M. Zralek, Nucl. Phys. **B447** (1995) 211; Acta. Phys. Pol. **27** (1996) 971.
- [33] D.Chang, Nucl. Phys. **B214** (1983) 435; G.Beal and A.Soni, Phys Rev. Lett. **47** (1981) 552;  
G. Ecker, W. Grimus, H. Neufeld, Nucl. Phys. **B229** (1983) 421;  
A.Masiero, R. Mohapatra, and R.D. Peccei, Nucl. Phys. **B192** (1981) 66;  
G. Branco, J.Frere, and J. Gerard, Nucl. Phys. **B221** (1983) 317.
- [34] M.A.B. Beg, W.J. Marciano, M. Ruderman, Phys. Rev. **D17** (1978) 1395;  
s P.Pal, R.N. Mohapatra, *Massive Neutrinos in Physics and Astrophysics*, World Scientific, Singapore, 1991;  
M. Fukugita, T. Yanagida, Phys. Rev. Lett. **58** (1987) 1807;  
B. Kayser, Phys. Rev. **D26** (1982) 1662;  
M. Fukugita, A. Suzuki, *Physics and Astrophysics of Neutrinos*, Springer-Verlag, Tokyo 1994 1; M. Czakon, J. Gluza and M. Zralek, Phys. Rev. **D59** (1999) 013010.
- [35] L.F. Li, L.F. Wilczek, Phys. Rev. **D25** (1982) 143;  
B. Kayser, R.E. Shrock, Phys. Lett. **B112** (1982) 137;  
B. Kayser, F. Gibrat-Debu, F. Perier, *The Physics of Massive Neutrinos*, World Scientific, Singapore, 1988;  
B. Kayser, A.S. Goldhaber, Phys. Rev. **D22** (1983) 1023.
- [36] M.E. Pospelov, Phys. Rev. **D56** (1997) 259.
- [37] G. Barenboim, J. Bernabeu, J. Prades, M. Raidal, Phys. Rev. **D55** (1997) 4213.
- [38] G. Beall, M. Bander and A. Soni, Phys. Rev. Lett. **48** (1982) 848.
- [39] T.G. Rizzo, Phys. Rev. **D50** (1994) 3303;  
P. Cho, M. Misiak, Phys. Rev. **D49** (1994) 5894;  
G. Barenboim, J. Bernabeu, M. Raidal, Phys. Rev. Lett. **80** (1998) 4625;  
G. Barenboim, J. Bernabeu, M. Raidal Nucl. Phys. **B511** (1998) 577.
- [40] G. Senjanovic, A. Sokorac, Phys. Lett. **B76** (1978) 610; Phys. Rev. **D18** (1978) 2708.
- [41] A. Pilaftsis,, Phys. Rev. **D52** (1995) 459;  
Z. Gagy-Palfy, A. Pilaftsis, K. Schilcher, Nucl. Phys. **B513** (1998) 517.
- [42] J. Polak, M. Zralek, Nucl. Phys. **B363** (1991) 385; Phys. Lett. **B276** (1992) 492; Phys. Rev. **D46** (1992) 3871; M. Czakon,  
J. Gluza and M. Zralek, Phys. Lett. **B458** (1999) 355.
- [43] M. Czakon, M. Zralek and J. Gluza, hep-ph/9906356.
- [44] M. Czakon, J. Gluza, F. Jegerlehner and M. Zralek, hep-ph/9909242.
- [45] G. 't Hooft, Nucl. Phys. **B33** (1971) 173; *ibid.* **B35** (1971) 167.
- [46] A.Denner and T. Sack, Nucl. Phys. **B347** (1990) 203.
- [47] B. Kniehl, Nucl. Phys. **B474** (1996) 286.  
B. Kniehl, A. Pilaftsis, Nucl. Phys. **B474** (1996) 286.
- [48] J. Gluza and M. Zralek Phys.Rev.**D45** (1992) 1693;

- A. Denner et al., Phys. Lett. **B219** (1992) 278; Nucl. Phys. **B387** (1992) 467.
- [49] P. Ramond and D.B. Reiss, Phys. Lett. **B80** (1978) 87;  
D. Chang, R.N. Mohapatra, Phys. Rev. Lett. **58** (1987) 1600;  
R.N. Mohapatra, Phys. Lett. **B198** (1987) 69;  
K.S. Babu, V.S. Mathur, Phys. Rev. **D38** (1988) 3550;  
S. Bartolini and J. Liu, Nucl. Phys. **B297** (1988) 401.
- [50] R.N. Mohapatra and G. Senjanovic, Phys. Rev. Lett. **44** (1980) 912; Phys. Rev. **D23** (1981) 165.
- [51] N.G. Deshpande, J.F. Gunion, B. Kayser, F. Olness, Phys. Rev. **D44** (1991) 837.
- [52] R.N. Mohapatra, P.B. Pal, Phys. Rev. **D38** (1988) 2226.
- [53] B.S. Balakrishna and R.N. Mohapatra, Phys. Lett. **B216** (1989) 349.
- [54] S. Rajport, Phys. Lett. **B191** (1987) 122;  
A. Davidson and K.C. Wali, Phys. Rev. Lett. **59** (1987) 393;  
B.S. Balakrishna, Phys. Lett. **60** (1988) 1602;  
K.S. Babu and R.N. Mohapatra, Phys. Rev. Lett. **62** (1989) 1079;  
R.N. Mohapatra, Phys. Lett. **B201** (1988) 517;  
B.S. Balakrishna, A. Kagan and R.N. Mohapatra, Phys. Lett. **B205** (1988) 345;  
B.S. Balakrishna, E. Ma Phys. Lett. **B214** (1988) 267; Phys. Rev. Lett. **63** (1989) 349.
- [55] P. Langacker, S. Sankar, Phys. Rev. **D40** (1989) 1569;
- [56] D. Chang et al., Phys. Rev. **D31**, (1985) 1718;  
J. M. Gipson and R.E. Marshak, Phys. Rev. **D31** (1985) 1705;  
Y. Tosa et al., Phys. Rev. **D28** (1983) 1731;  
F.I. Olness, M.E. Ebel, Phys. Rev. **D30** (1984) 1034, ;
- [57] J.C. Pati, S. Rajpoot, A. Salam, Phys. Rev. **D17** (1978) 131.
- [58] R.N. Mohapatra and G. Senjanovic, Phys. Rev. Lett. **44** (1980) 912.
- [59] M.A. Beg, R.V. Budny, R. Mohapatra and A. Sirlin, Phys. Rev. Lett. **38** (1977) 1252; Erratum-ibid. **39** (1977) 54.
- [60] A. Datta, A. Raychaudhuri, Phys. Rev. **D28** (1983) 1170 and Phys. Lett. **B122** (1983) 392;  
M. Aquino, A. Garcia, A. Fernandez, Phys. Lett. **B261** (1991) 280.
- [61] W. Grimus *Lecture given at the 4th Hellenic School on elementary Particle Physics, Corfu, 2-20 September 1992.*
- [62] V. Barger, E. Ma and K. Whisnant, Phys Rev **D26**; (1982) 2378 I Liede, J. Maalampi and M. Ross Nucl. Phys. **B146** (1978) 157; T.Rizzo and G Senjanovic Phys. Rev. **D24** (1981) 704; X. Li and D. Marshak, Phys. Rev. **D25** (1982) 1886; J.E. Kim, P. Langacker, M. Levine and H. Williams, Rev. Mod. Phys. **53** (1981) 211.
- [63] J. Gluza, M. Zralek, Phys. Rev. **D51** (1995) 4695.
- [64] J.F. Gunion, J. Grifols, A. Mendez, B. Kayser, F. Olness, Phys. Rev. **D40** (1989) 1546.
- [65] R.N. Mohapatra and D.P. Sidhu, Phys. Rev. Lett. **38**, (1977) 667; G. Senjanovic, Nucl. Phys. **B153** (1979) 334;
- [66] S.N. Gupta, Proc. Phys. Soc. **A63** (1950) 681;  
K. Bleuler, Helv. Phys. Acta **23** (1950) 567.
- [67] N. Nakamishi, Progr. Theor. Phys. **35** (1967) 1111;  
B. Lautrup, Mat. Fys. Meeld. Dan. Viol. Selsk. **35** (1967) no. 11.
- [68] R.P. Feynman, Acta Phys. Pol. **24** (1963) 697.
- [69] B.S. De Witt, Phys. Rev. **162** (1967) 1195, 1239.
- [70] L. D. Faddeev. V.N. Popov, Phys. Lett **B25** (1967) 29;  
L.D. Faddeev, Teor. Mat. Fiz. **1** (1969) 3.
- [71] J. Ward, Phys. Rev. **72** (1950) 182;  
Y. Takahashi, Nouvo Cimento **6** (1957) 370.
- [72] J.C. Taylor, Nucl. Phys. **33** (1971) 436;  
A. Slavnov, Teor. Mat. Fiz. **10** (1972) 153.
- [73] C. Becchi, A. Rouet and R. Stora, Phys. Lett. **52** (1974) 344; Comm. Math. Phys. **42** (1975) 127; Ann. of Phys. **98** (1976) 287;  
I.V. Tyutin, Lebedev preprint FIAN No. **39** (1975).
- [74] R Brandt, Nucl. Phys. **B16** (1976) 414;  
see also N. Nakamishi and I. Ojima, *Covariant operator formalism of gauge theories and quantum gravity*, World Scientific Lecture Notes in Physics Vol. **27**, World Scientific, Singapore, 1990.
- [75] see e.q. S. Weinberg, "The quantum theory of fields", Cambridge University Press, 1995.
- [76] T. Kugo and I. Ojima, Prog. Theor. Phys. Suppl. No. **66** (1971) 1.



- [77] see also the Nakamishi Ojima book cited in [74].
- [78] B. W. Lee and J. Zinn-Justin, Phys. Rev. **D5** (1972) 3121, 3137, 3155.
- [79] G. 't Hooft, M. Veltman, Nucl. Phys. **B50** (1972) 318.
- [80] K. Fujikava, B. W. Lee and A. I. Sanda, Phys. Rev. **D6** (1972) 2923.
- [81] G. 't Hooft, M. Veltman, Nucl. Phys. **B44** (1972) 189.
- [82] D. A. Ross, J.C. Taylor, Nucl. Phys. **B51** (1973) 125.
- [83] K.Aoki, Z. Hioki, R. Kawabe, M. Konuma, T. Muta, Prog.Theor. Phys. Supp. **73** (1982).

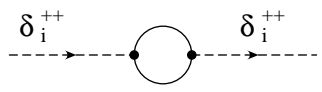

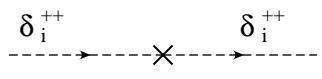

$$\begin{aligned}
 & \text{Shaded circle with } W_1 \text{ external lines} \\
 &= \Psi_L \text{ loop} + \Psi_R \text{ loop} + W_{1,2} \text{ loop } Z_1 + W_{1,2} \text{ loop } Z_2 + W_{1,2} \text{ loop } A + Z_{1,2} \text{ loop } 3\text{csp} +
 \end{aligned}$$

$$\begin{aligned}
 & A \text{ loop } 3\text{csp} + W_{1,2} \text{ loop } 6\text{nsp} + \text{csp loop } \text{nsp} + \bar{c}_1 \text{ loop } c_{1,2,0} + \bar{c}_2 \text{ loop } c_{1,2,0} + \bar{c}_1 \text{ loop } \bar{c}_{1,2,0} +
 \end{aligned}$$

$$\begin{aligned}
 & \bar{c}_2 \text{ loop } \bar{c}_{1,2,0} + W_{1,2} \text{ loop } W_{1,2} + Z_{1,2} \text{ loop } Z_{1,2} + A \text{ loop } A + \text{nsp loop } 8\text{nsp} + \text{csp loop } 4\text{csp} +
 \end{aligned}$$

$$\begin{aligned}
 & \text{2dcsp loop} + \text{crossed-out diagram}
 \end{aligned}$$

$$\begin{aligned}
 & \text{Shaded circle with } W_1 \text{ external lines} \\
 &= \Psi_L \text{ loop} + \Psi_R \text{ loop} + W_{1,2} \text{ loop } Z_1 + W_{1,2} \text{ loop } Z_2 + W_{1,2} \text{ loop } A + Z_{1,2} \text{ loop } 3\text{csp} +
 \end{aligned}$$

$$\begin{aligned}
 & A \text{ loop } 3\text{csp} + W_{1,2} \text{ loop } 6\text{nsp} + \text{csp loop } \text{nsp} + \bar{c}_1 \text{ loop } c_{1,2,0} + \bar{c}_2 \text{ loop } c_{1,2,0} + \bar{c}_1 \text{ loop } \bar{c}_{1,2,0} +
 \end{aligned}$$

$$\begin{aligned}
 & \bar{c}_2 \text{ loop } \bar{c}_{1,2,0} + W_{1,2} \text{ loop } W_{1,2} + Z_{1,2} \text{ loop } Z_{1,2} + A \text{ loop } A + \text{nsp loop } 8\text{nsp} + \text{csp loop } 4\text{csp} +
 \end{aligned}$$

$$\begin{aligned}
 & \text{2dcsp loop} + \text{crossed-out diagram}
 \end{aligned}$$

$Z_1$   
 $Z_1$   
 $= \Psi_L + \Psi_R + W_1 + W_2 + W_1 + W_2 + W_2 + Z_{1,2} + 8csp +$   
 $24d$   
 $24d$   
 $W_1 + W_2$   
 $W_2 + W_1$   
 $W_2 + W_1$   
 $8csp$

$W_{1,2} + csp + dcspl + \bar{c}_1^{+-} + \bar{c}_2^{+-} + \bar{c}_1^{+-} +$   
 $4nsp$   
 $nsp$   
 $2d$   
 $c_1^{+-}$   
 $c_2^{+-}$   
 $c_2^{+-}$   
 $19d$   
 $2d$   
 $c_1^{+-}$   
 $c_2^{+-}$   
 $c_1^{+-}$

$\bar{c}_2^{+-} + W_{1,2} + 8nsp + 4csp + 2dcspl +$   
 $c_1^{+-}$   
 $W_{1,2}$   
 $8nsp$   
 $4csp$   
 $2dcspl$   
 $\times$

P. Duka, J.Gluza and M.Zralek  
Department of Field Theory and Particle Physics  
Institute of Physics, University of Silesia  
Uniwersytecka 4, PL-40-007 Katowice, Poland

s

## II. Renormalization.

In this chapter we present the definitions of all renormalization constants and the on mass shell scheme. The way how to calculate all counter terms for tadpoles, two and three point functions are given.

### I RENORMALIZATION OF THE TADPOLES

#### A Denitions of the renormalization constants

$$H^0, H_1^0, H_2^0, H_3^0, A_1^0, A_2^0 \quad \text{---} \bullet \text{---} \bigcirc = \text{tadpoles},$$

---

\*This work was supported by Polish Committee for Scientific Researches under Grants Nos. 2252/2/91 and 2P30225206/93

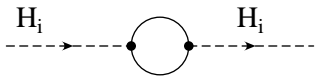



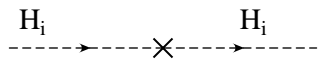

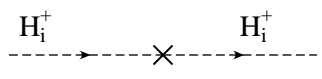

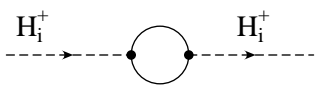

P. Duka, J.Gluza and M.Zralek  
 Department of Field Theory and Particle Physics  
 Institute of Physics, University of Silesia  
 Uniwersytecka 4, PL-40-007 Katowice, Poland

<sup>s</sup>  
 PACS number(s): 13.15.-f, 12.15.Cc,14.60.Gh

## Part I

# Model at the tree level.

For consistency we have written down below the full Lagrangian at the tree level we use. As stated in this section we use the model where

- (i) manifest-left right symmetry (Eq.(23));
- (ii)  $g_L = g_R$ ;
- (iii) Higgs sector is simplified
- (iv) .....

### I STRUCTURE OF THE LAGRANGIAN OF THE THEORY

#### A Fermion and gauge elds

In the  $SU(2)_L \otimes SU(2)_R \otimes U(1)_{B-L}$  gauge model quarks (Q) and leptons (L) are placed in doublets

$$L_{iL} = \begin{pmatrix} \nu_i \\ l_i^- \end{pmatrix}_L : (2, 1, -1), L_{iR} = \begin{pmatrix} \nu_i \\ l_i^- \end{pmatrix}_R : (1, 2, -1) \quad (1)$$

$$Q_{iL} = \begin{pmatrix} u_i \\ d_i \end{pmatrix}_L : (2, 1, 1/3), Q_{iR} = \begin{pmatrix} u_i \\ d_i \end{pmatrix}_R : (1, 2, 1/3) \quad (2)$$

$i=1,2,3$  running over number of generations. In paranthesis quantum numbers connected with  $SU(2)_L, SU(2)_R, U(1)_{B-L}$  groups respectively are assigned. The quantum number for  $U(1)_{B-L}$  gauge group is obtained by means of particles' charge identification

---

\*This work was supported by Polish Committee for Scientific Researches under Grants Nos. 2252/2/91 and 2P30225206/93

In order to produce fermion mass matrices we need the following Higgs multiplets (again as, in the fermion case, in paranthesis quantum numbers  $(T_{3L}, T_{3R}, Y_{B-L})$  are given)

$$\phi = \begin{pmatrix} \phi_1^0 & \phi_1^+ \\ \phi_2^- & \phi_2^0 \end{pmatrix} : \left( \frac{1}{2}, \frac{1^*}{2}, 0 \right); \quad (13)$$

$$\tilde{\phi} = \tau_2 \phi^* \tau_2 : \left( \frac{1}{2}, \frac{1^*}{2}, 0 \right) \quad (14)$$

with gauge transformation

$$\phi' = \left[ e^{-ig_L \frac{\boldsymbol{\tau}}{2} \tilde{\Theta}(x)} \otimes e^{ig_R \frac{\boldsymbol{\tau}}{2} \tilde{\Theta}(x)} \otimes 1_{B-L} \right] \phi. \quad (15)$$

Consequently the most general Yukawa Lagrangian is given by

$$L_Y = \sum_{\Psi=Q,L} \bar{\Psi}_L (h\phi + \tilde{h}\tilde{\phi}) \Psi_R + h.c. \quad (16)$$

However, bidoublet  $\phi$  is not sufficient for breaking  $SU(2)_L \otimes SU(2)_R \otimes U(1)_{B-L}$  gauge group to the standard  $SU(2)_L \otimes U(1)$  one. This is because after SSB  $\langle \phi \rangle = \begin{pmatrix} \kappa_1 & 0 \\ 0 & \kappa_2 \end{pmatrix}$  symmetry is broken to  $U(1) \otimes U(1)$  gauge group. Explicitly

$$Y \langle \phi \rangle = 0 \quad (17)$$

$$(T_{3L} + T_{3R}) \langle \phi \rangle = \left( Q - \frac{Y}{2} \right) \langle \phi \rangle = 0. \quad (18)$$

There are however other possibilities to break this gauge group to the SM one [?]. Among them the most popular is breaking using Higgs triplets  $(\Delta_L \sim (3, 1, 2), \Delta_R \sim (1, 3, 2))$  in addition to the bidoublet  $\phi$

$$\Delta_{L,R} = \begin{pmatrix} \delta_{L,R}^+/\sqrt{2} & \delta_{L,R}^{++} \\ \delta_{L,R}^0 & -\delta_{L,R}^+/\sqrt{2} \end{pmatrix}. \quad (19)$$

This Higgs sector leads to appropriate gauge symmetry breaking by the chain

$$SU(2)_L \otimes SU(2)_R \otimes U(1)_{B-L} \xrightarrow{v_R} SU(2)_L \otimes U(1)_Y \xrightarrow{\kappa_1, \kappa_2, v_L} U(1)_{em}. \quad (20)$$

This will be shown in the next Section.

Now we can build the kinetic part of the Lagrangian

$$L = Tr \left[ (D_\mu \Delta_L)^\dagger (D^\mu \Delta_L) \right] + Tr \left[ (D_\mu \Delta_R)^\dagger (D^\mu \Delta_R) \right] + Tr \left[ (D_\mu \phi)^\dagger (D^\mu \phi) \right]. \quad (21)$$

In the previous section we've introduced the full Lagrangian with scalar, fermion and gauge fields. Now we will find transformation of these fields to physical basis.

## A The physical elds

### 1. Gauge bosons

Masses of gauge bosons are obtained from the Lagrangian Eq.(21)

The charged  $(W_L^{\mu\pm} = \frac{1}{\sqrt{2}}(W_{1L}^\mu \mp iW_{2L}^\mu), W_R^{\mu\pm} = \frac{1}{\sqrt{2}}(W_{1R}^\mu \mp iW_{2R}^\mu))$  and neutral  $(W_{3L}^\mu, W_{3R}^\mu, B^\mu)$  gauge boson mass matrices  $\tilde{M}_W^2, \tilde{M}_0^2$  are the following

$$\begin{aligned} \tilde{M}_W^2 &= \frac{g^2}{4} \begin{pmatrix} \kappa_+^2 & -4\kappa_1\kappa_2 \\ -4\kappa_1\kappa_2 & \kappa_+^2 + 2v_R^2 \end{pmatrix} \\ \tilde{M}_0^2 &= \begin{pmatrix} \frac{g^2}{2}\kappa_+^2 & -\frac{g^2}{2}\kappa_+^2 & 0 \\ -\frac{g^2}{2}\kappa_+^2 & \frac{g^2}{2}(\kappa_+^2 + 4v_R^2) & -4gg'v_R^2 \\ 0 & -4gg'v_R^2 & 4g'^2v_R^2 \end{pmatrix}. \end{aligned} \quad (28)$$

These mass matrices are diagonalized by the unitary transformation for charged gauge bosons

$$\begin{pmatrix} W_L^\pm \\ W_R^\pm \end{pmatrix} = \begin{pmatrix} \cos\xi & \sin\xi \\ -\sin\xi & \cos\xi \end{pmatrix} = \begin{pmatrix} W_1^\pm \\ W_2^\pm \end{pmatrix} \quad (29)$$

and by orthogonal transformation in neutral sector

$$\begin{aligned} \begin{pmatrix} W_{3L} \\ W_{3R} \\ B \end{pmatrix} &= \begin{pmatrix} c_w c & c_w s & s_w \\ -s_w s_m c - c_m s & -s_w s_m s + c_m c & c_w s_m \\ -s_w c_m c + s_m s & -s_w c_m s - s_m c & c_w c_m \end{pmatrix} \begin{pmatrix} Z_1 \\ Z_2 \\ A \end{pmatrix} \equiv \\ &\begin{pmatrix} x_1 & x_2 & x_3 \\ y_1 & y_2 & y_3 \\ v_1 & v_2 & v_3 \end{pmatrix} \begin{pmatrix} Z_1 \\ Z_2 \\ A \end{pmatrix} \end{aligned} \quad (30)$$

where

$$\begin{aligned} s(c)_w &\equiv \sin(\cos)\Theta, & s(c) &\equiv \sin(\cos)\phi; \\ c_m &\equiv \frac{\sqrt{\cos 2\Theta}}{\cos \Theta}, & s_m &\equiv \tan \Theta, \\ g &= \frac{e}{\sin \Theta}, & g' &= \frac{e}{\sqrt{\cos 2\Theta}} \end{aligned}$$

$$\begin{aligned}\nu_L &= U_L \hat{\nu}_L^c \equiv U_L (P_L N), \\ \nu_R &= U_R \hat{\nu}_R \equiv U_R (P_R N),\end{aligned}\tag{40}$$

The mass matrix for charged leptons is

$$\tilde{m}_l = \frac{1}{\sqrt{2}} \left( h \kappa_1 + \tilde{h} \kappa_2 \right),\tag{41}$$

and is diagonalized by the biunitary transformation

$$U_L^{l\dagger} \tilde{m}_l U_R^l = m_l\tag{42}$$

where  $m_l$  is a diagonal, positive  $3 \times 3$  matrix and unitary matrices  $U_{L,R}^l$  yield the physical lepton fields  $\hat{l} = \hat{l}_L + \hat{l}_R$ ,

$$l_{L,R} = U_{L,R}^l \hat{l}_{L,R}.\tag{43}$$

The Yukawa interaction for quarks equal

$$L_{Yukawa}^q = \sum_{Q_L, Q_R} \bar{Q}_L \left[ h^q \phi + \tilde{h}^q \tilde{\phi} \right] Q_R + h.c.\tag{44}$$

Charge conservation does not allow for Majorana terms (Eq.30) to be present here.

After SSB we get

$$L_{mass}^q = -M_u \bar{u}_L u_R - M_d \bar{d}_L d_R\tag{45}$$

where

$$M_u = \frac{1}{\sqrt{2}} \left( h^q \kappa_1 + \tilde{h}^q \kappa_2 \right), \quad M_d = \frac{1}{\sqrt{2}} \left( \tilde{h}^q \kappa_1 + h^q \kappa_2 \right).\tag{46}$$

Defining physical states

$$u_{L,R} = V_{L,R}^u \hat{u}_{L,R},\tag{47}$$

$$d_{L,R} = V_{L,R}^d \hat{d}_{L,R}\tag{48}$$

we have

$$M_u^{diag} = (m_u, m_c, m_t)_{diag} = V_L^{u\dagger} M_u V_R^u,\tag{49}$$

$$M_d^{diag} = (m_d, m_s, m_b)_{diag} = V_L^{d\dagger} M_d V_R^d.\tag{50}$$

### 3. Higgs particles

Minimalization of the Higgs potential gives us relation between physical and gauge Higgses, too  $\left( \kappa_{\pm} = \sqrt{\kappa_1^2 \pm \kappa_2^2} \right)$

**Leptons**

The charged current Lagrangian (Eq.10)

$$L_{CC} = \frac{g}{\sqrt{2}} \bar{\nu} \gamma^\mu \left( P_L W_{L\mu}^+ + P_R W_{R\mu}^+ \right) l + h.c. \quad (64)$$

converted to the physical one is following (Eqs.(39),(42),(28))

$$L_{CC} = \bar{N} \gamma^\mu \left( A_L^{(1)} P_L + A_R^{(1)} P_R \right) \hat{W}_{1\mu}^+ + \bar{N} \gamma^\mu \left( A_L^{(2)} P_L + A_R^{(2)} P_R \right) \hat{W}_{2\mu}^+ + h.c., \quad (65)$$

where

$$A_L^{(1)} = \frac{e}{\sqrt{2} \sin \Theta} \cos \xi K_L, \quad A_R^{(1)} = -\frac{e}{\sqrt{2} \sin \Theta} \sin \xi K_R, \\ A_L^{(2)} = \frac{e}{\sqrt{2} \sin \Theta} \sin \xi K_L, \quad A_R^{(2)} = \frac{e}{\sqrt{2} \sin \Theta} \cos \xi K_R,$$

and  $K_L(K_R)$  are  $6 \times 3$  mixing matrices

$$K_L = U_L^\dagger U_L^l, \quad K_R = U_R^\dagger U_R^l. \quad (66)$$

Similarly the neutral current Lagrangian in the L-R model is given by

$$L_{NC} = \frac{e}{2 \sin \Theta_W \cos \Theta_W} [J_1^\mu Z_{1\mu} + J_2^\mu Z_{2\mu}] - e J_{em}^\mu A_\mu, \quad (67)$$

where  $J_{em}^\mu = \bar{l} \gamma^\mu l$  and neutral currents  $J_{1,2}^\mu$  are equal

$$J_i^\mu = \bar{l} \gamma^\mu [A_L^{il} P_L + A_R^{il} P_R] l + \bar{\nu} \gamma^\mu [A_L^{i\nu} \Omega_L P_L + A_R^{i\nu} \Omega_R P_R] \nu, \quad (68)$$

where

$$\Omega_L = U_L^\dagger U_L, \quad \Omega_R = U_R^\dagger U_R; \\ A_L^{1l} = \cos \phi g_L^e + \sin \phi g_L^{\prime e}, \quad A_L^{1\nu} = \cos \phi + \sin \phi g_L^{\prime e} \\ A_R^{1l} = \cos \phi g_R^e + \sin \phi g_R^{\prime e}, \quad A_R^{1\nu} = \sin \phi g_R^{\prime e}, \\ A_L^{2l} = \cos \phi \left( -g_L^{\prime e} \right) + \sin \phi g_L^e, \quad A_L^{2\nu} = \cos \phi \left( -g_L^{\prime e} \right) + \sin \phi, \\ A_R^{2l} = \cos \phi \left( -g_R^{\prime e} \right) + \sin \phi g_R^e, \quad A_R^{2\nu} = \cos \phi \left( -g_R^{\prime e} \right), \quad (69)$$

and



This Lagrangian is defined in Eq.(28) and can be written in physical basis taking into account Eqs.(28),(29).

$$\begin{aligned}
 L_g^{3,4} = & -ig \left\{ \partial^\mu W_1^{-\nu} \left[ (\sin^2 \xi W_{1\mu}^+ - \cos \xi \sin \xi W_{2\mu}^+) (y_1 Z_{1\nu} + y_2 Z_{2\nu} + y_3 A_\nu) \right. \right. \\
 & - \left. \left. (\sin^2 \xi W_{1\nu}^+ - \cos \xi \sin \xi W_{2\nu}^+) (y_1 Z_{1\mu} + y_2 Z_{2\mu} + y_3 A_\mu) \right] - h.c. \right. \\
 & + \partial^\mu W_2^{-\nu} \left[ (-\cos \xi \sin \xi W_{1\mu}^+ + \cos^2 \xi W_{2\mu}^+) (y_1 Z_{1\nu} + y_2 Z_{2\nu} + y_3 A_\nu) \right. \\
 & - \left. \left. (-\cos \xi \sin \xi W_{1\nu}^+ + \cos^2 \xi W_{2\nu}^+) (y_1 Z_{1\mu} + y_2 Z_{2\mu} + y_3 A_\mu) \right] - h.c. \right\} \\
 & - g^2 \left\{ [\sin^2 \xi W_1^{-\mu} W_{1\mu}^+ - \cos \xi \sin \xi (W_1^{+\mu} W_{2\mu}^- + W_1^{-\mu} W_{2\mu}^+) + \cos^2 \xi W_2^{+\mu} W_{2\mu}^-] \right. \\
 & \times (y_1 Z_1^\nu + y_2 Z_2^\nu + y_3 A^\nu) (y_1 Z_{1\nu} + y_2 Z_{2\nu} + y_3 A_\nu) \\
 & - [\sin^2 \xi W_1^{+\nu} W_{1\nu}^- - \cos \xi \sin \xi (W_2^{-\nu} W_{1\mu}^+ + W_2^{+\nu} W_{1\mu}^-) + \cos^2 \xi W_2^{+\nu} W_{2\mu}^-] \\
 & \left. \times (y_1 Z_1^\mu + y_2 Z_2^\mu + y_3 A^\mu) (y_1 Z_{1\nu} + y_2 Z_{2\nu} + y_3 A_\nu) \right\} \\
 & - ig \left\{ \partial^\mu (y_1 Z_1^\nu + y_2 Z_2^\nu + y_3 A^\nu) [\sin^2 \xi (-W_{1\mu}^+ W_{1\nu}^- + W_{1\mu}^- W_{1\nu}^+) \right. \\
 & - \left. \cos \xi \sin \xi (-W_{2\mu}^+ W_{1\nu}^- + W_{2\mu}^- W_{1\nu}^+ - W_{1\mu}^+ W_{2\nu}^- + W_{1\mu}^- W_{2\nu}^+) + \cos^2 \xi (-W_{2\mu}^+ W_{2\nu}^- + W_{2\mu}^- W_{1\nu}^+) \right\} \\
 & + \frac{1}{2} g^2 \left\{ \sin^4 \xi [W_1^{-\mu} W_{1\mu}^- W_1^{+\nu} W_{1\nu}^+ - W_1^{+\mu} W_{1\mu}^- W_1^{-\nu} W_{1\nu}^+] \right. \\
 & - 2 \sin^3 \xi \cos \xi [W_1^{-\mu} W_{1\mu}^- W_1^{+\nu} W_{2\nu}^+ - W_1^{+\mu} W_{1\mu}^- W_1^{-\nu} W_{2\nu}^+ - W_1^{-\mu} W_{1\mu}^+ W_1^{+\nu} W_{2\nu}^- + W_1^{+\mu} W_{1\mu}^+ W_1^{-\nu} W_{2\nu}^-] \\
 & + 4 \sin^2 \xi \cos^2 \xi \left[ 2W_1^{-\mu} W_{2\mu}^- W_1^{+\nu} W_{2\nu}^+ - W_1^{+\mu} W_{2\mu}^- W_1^{-\nu} W_{2\nu}^+ - \frac{1}{2} W_1^{+\mu} W_{2\mu}^- W_1^{+\nu} W_{2\nu}^- - \frac{1}{2} W_1^{-\mu} W_{2\mu}^+ W_1^{-\nu} W_{2\nu}^+ \right. \\
 & \left. + \frac{1}{2} W_1^{-\mu} W_{1\mu}^- W_2^{+\nu} W_{2\nu}^+ - W_1^{+\mu} W_{1\mu}^- W_2^{-\nu} W_{2\nu}^+ + \frac{1}{2} W_1^{+\mu} W_{1\mu}^+ W_2^{-\nu} W_{2\nu}^- \right] \\
 & - 2 \cos^3 \xi \sin \xi [W_1^{-\mu} W_{2\mu}^- W_2^{+\nu} W_{2\nu}^+ - W_1^{+\mu} W_{2\mu}^- W_2^{-\nu} W_{2\nu}^+ - W_1^{-\mu} W_{2\mu}^+ W_2^{+\nu} W_{2\nu}^- + W_1^{+\mu} W_{2\mu}^+ W_2^{-\nu} W_{2\nu}^-] \\
 & \left. + \cos^4 \xi [W_2^{-\mu} W_{2\mu}^- W_2^{+\nu} W_{2\nu}^+ - W_2^{+\mu} W_{2\mu}^- W_2^{-\nu} W_{2\nu}^+] \right\} \\
 & - ig \left\{ \partial^\mu W_1^{-\nu} \left[ (\cos^2 \xi W_{1\mu}^+ + \cos \xi \sin \xi W_{2\mu}^+) (y_1 Z_{1\nu} + y_2 Z_{2\nu} + y_3 A_\nu) \right. \right. \\
 & - \left. \left. (\cos^2 \xi W_{1\nu}^+ + \cos \xi \sin \xi W_{2\nu}^+) (y_1 Z_{1\mu} + y_2 Z_{2\mu} + y_3 A_\mu) \right] - h.c. \right. \\
 & + \partial^\mu W_2^{-\nu} \left[ (+\cos \xi \sin \xi W_{1\mu}^+ + \sin^2 \xi W_{2\mu}^+) (y_1 Z_{1\nu} + y_2 Z_{2\nu} + y_3 A_\nu) \right. \\
 & - \left. \left. (+\cos \xi \sin \xi W_{1\nu}^+ + \sin^2 \xi W_{2\nu}^+) (y_1 Z_{1\mu} + y_2 Z_{2\mu} + y_3 A_\mu) \right] - h.c. \right\} \\
 & - g^2 \left\{ [\cos^2 \xi W_1^{-\mu} W_{1\mu}^+ + \cos \xi \sin \xi (W_1^{+\mu} W_{2\mu}^- + W_1^{-\mu} W_{2\mu}^+) + \sin^2 \xi W_2^{+\mu} W_{2\mu}^-] \right. \\
 & \times (y_1 Z_1^\nu + y_2 Z_2^\nu + y_3 A^\nu) (y_1 Z_{1\nu} + y_2 Z_{2\nu} + y_3 A_\nu) \\
 & - [\cos^2 \xi W_1^{+\nu} W_{1\nu}^- + \cos \xi \sin \xi (W_2^{-\nu} W_{1\mu}^+ + W_2^{+\nu} W_{1\mu}^-) + \sin^2 \xi W_2^{+\nu} W_{2\mu}^-]
 \end{aligned}$$

$m_b^N$  denotes neutrino masses, three light (b=1,2,3) and three heavy (b=4,5,6). The parameters  $A_0, B_0, A^\pm$  and  $B^\pm$  denote the combination of the Higgs fields

$$\begin{aligned} A_0 &= \frac{\sqrt{2}}{\kappa_-^2} \left( \kappa_1 \phi_2^0 - \kappa_2 \phi_1^{0*} \right), & B_0 &= \frac{\sqrt{2}}{\kappa_-^2} \left( \kappa_1 \phi_1^0 - \kappa_2 \phi_2^{0*} \right), \\ A^\pm &= \frac{\sqrt{2}}{\kappa_-^2} \left( \kappa_1 \phi_1^\pm + \kappa_2 \phi_2^\pm \right), & B^\pm &= \frac{\sqrt{2}}{\kappa_-^2} \left( \kappa_2 \phi_1^\pm + \kappa_1 \phi_2^\pm \right). \end{aligned} \quad (79)$$

The right-handed triplet interaction with leptons is

$$-L_Y^R = \delta_R^0 \bar{\nu}_L^c h_R \nu_R - \frac{\delta_R^+}{\sqrt{2}} (\bar{\nu}_L^c h_R e_R + \bar{e}_L^c h_R \nu_R) - \delta_R^{++} \bar{e}_L^c h_R e_R + h.c., \quad (80)$$

where the first two parts are given by

$$\begin{aligned} \delta_R^0 \bar{\nu}_L^c h_R \nu_R + h.c. &= -\frac{1}{2v_R} \sum_a \bar{N}_a \left( \sum_c m_c^N \left[ (\Omega_R)_{ca}^2 P_R \delta_R^0 + (\Omega_R^*)_{ca}^2 P_L \delta_R^{0*} \right] \right) N_a \\ &- \frac{1}{v_R} \sum_{a>b} \bar{N}_a \left( \sum_c m_c^N \left[ (\Omega_R)_{cb} (\Omega_R)_{ca} P_R \delta_R^0 + (\Omega_R^*)_{cb} (\Omega_R^*)_{ca} P_L \delta_R^{0*} \right] \right) N_b \end{aligned} \quad (81)$$

and

$$\begin{aligned} -\frac{\delta_R^+}{\sqrt{2}} (\bar{\nu}_L^c h_R e_R + \bar{e}_L^c h_R \nu_R) + h.c. &= -\frac{1}{v_R} \sum_{a,l} \left\{ \bar{N}_a \left[ \sum_b (\Omega_R^*)_{ab} m_b^N (K_R)_{bl} \right] P_R e_l \delta_R^+ \right. \\ &\left. + \bar{e}_l \left[ \sum_b (K_R^\dagger)_{lb} m_b^N (\Omega_R^*)_{ba} \right] P_L N_a \delta_R^- \right\}. \end{aligned} \quad (82)$$

Since  $v_L = 0$ , the interaction of the left-handed triplet can not be simple obtained by taking  $R \rightarrow L$  in Eqs. (81,82).

To get this interaction we use relation  $h_L = h_R \neq 0$ . Then

$$\begin{aligned} \delta_L^0 \bar{\nu}_R^c h_L \nu_L + h.c. &= \frac{1}{\sqrt{2}v_R} \sum_a \bar{N}_a \left[ X_{aa} \delta_L^0 P_L + X_{aa}^* \delta_L^{0*} P_R \right] N_a \\ &+ \frac{\sqrt{2}}{v_R} \sum_{a>b} \bar{N}_a \left[ X_{ab} \delta_L^0 P_L + X_{ab}^* \delta_L^{0*} P_R \right] N_b, \end{aligned} \quad (83)$$

and

$$\begin{aligned} &-\frac{\delta_L^+}{\sqrt{2}} (\bar{\nu}_R^c h_L e_L + \bar{e}_R^c h_L \nu_L) + h.c. = \\ &-\frac{1}{v_R} \delta_L^+ \sum_{a,l} \bar{N}_a \sum_b X_{ab} (K_L)_{bl} P_L e_l + \frac{1}{v_R} \delta_L^- \sum_{a,l} \bar{e}_l \sum_b (K_L^\dagger)_{lb} (X^*)_{ba} P_R N_a, \end{aligned} \quad (84)$$

The matrix X is given by

$$X_{ab} = \sum_c \left( U_R^\dagger U_L \right)_{ac}^T m_c^N \left( U_R^\dagger U_L \right)_{cb} = X_{ba}. \quad (85)$$

The quark part of the Yukawa lagrangian is the following

$$\begin{aligned}
L_{GF} = & -\frac{1}{2\xi} \left[ \partial^\mu Z_{1\mu} - \xi \left( a_{11}^{ZG} \tilde{G}_1^o + b_{12}^{ZG} \tilde{G}_2^o \right) \right]^2 - \frac{1}{2\xi} \left[ \partial^\mu Z_{2\mu} - \xi \left( a_{21}^{ZG} \tilde{G}_1^o + b_{22}^{ZG} \tilde{G}_2^o \right) \right]^2 \\
& - \frac{1}{\xi} \left[ \partial^\mu W_{1\mu}^+ + i\xi \left( (ab)_{1R}^{WG} G_R^+ + a_{1L}^{WG} G_L^+ \right) \right] \times \left[ \partial^\mu W_{1\mu}^- - i\xi \left( (ab)_{1R}^{WG} G_R^- + a_{1L}^{WG} G_L^- \right) \right] \\
& - \frac{1}{\xi} \left[ \partial^\mu W_{2\mu}^+ + i\xi \left( (ab)_{2R}^{WG} G_R^+ + a_{2L}^{WG} G_L^+ \right) \right] \times \left[ \partial^\mu W_{2\mu}^- - i\xi \left( (ab)_{2R}^{WG} G_R^- + a_{2L}^{WG} G_L^- \right) \right]
\end{aligned} \tag{90}$$

where;

$$\begin{aligned}
a_{11}^{ZG} &= -\frac{g}{\sqrt{2}} \kappa_+^2 (x_1 - y_1), & a_{21}^{ZG} &= -\frac{g}{\sqrt{2}} \kappa_+^2 (x_2 - y_2) \\
b_{12}^{ZG} &= -v_R (g' v_1 - g y_1), & b_{22}^{ZG} &= -v_R (g' v_2 - g y_2)
\end{aligned} \tag{91}$$

$$\begin{aligned}
(ab)_{1R}^{WG} &= s \left\{ \kappa_2 a_{2R} - \kappa_1 a_{1R} + \frac{g v_R}{\sqrt{2}} a_{RR} \right\} \\
(ab)_{2R}^{WG} &= -c \left\{ \kappa_2 a_{2R} - \kappa_1 a_{1R} - \frac{g v_R}{\sqrt{2}} a_{RR} \right\} \\
a_{1L}^{WG} &= s (\kappa_2 a_{2L} - \kappa_1 a_{1L}) \\
a_{2L}^{WG} &= -c (\kappa_2 a_{2L} - \kappa_1 a_{1L}).
\end{aligned} \tag{92}$$

We can define new Goldstone fields using the ortogonal transformations;

$$\begin{pmatrix} G_1^\pm \\ G_2^\pm \end{pmatrix} = \begin{pmatrix} \frac{(ab)_{1R}^{WG}}{M_{W_1}} & \frac{a_{1L}^{WG}}{M_{W_1}} \\ \frac{(ab)_{2R}^{WG}}{M_{W_2}} & \frac{a_{2L}^{WG}}{M_{W_2}} \end{pmatrix} \begin{pmatrix} G_R^\pm \\ G_L^\pm \end{pmatrix} \equiv \begin{pmatrix} \cos \psi_c & -\sin \psi_c \\ \sin \psi_c & \cos \psi_c \end{pmatrix} \begin{pmatrix} G_R^\pm \\ G_L^\pm \end{pmatrix} \tag{93}$$

$$\begin{pmatrix} G_1^o \\ G_2^o \end{pmatrix} = \begin{pmatrix} \frac{a_{11}^{ZG}}{M_{Z_1}} & \frac{b_{12}^{ZG}}{M_{Z_1}} \\ \frac{a_{21}^{ZG}}{M_{Z_2}} & \frac{b_{22}^{ZG}}{M_{Z_2}} \end{pmatrix} \begin{pmatrix} \tilde{G}_1^o \\ \tilde{G}_2^o \end{pmatrix} \equiv \begin{pmatrix} \cos \psi_n & \sin \psi_n \\ \sin \psi_n & -\cos \psi_n \end{pmatrix} \begin{pmatrix} \tilde{G}_1^o \\ \tilde{G}_2^o \end{pmatrix} \tag{94}$$

Applying above definition of the Goldstons fields for the gauge fixing Lagrangian one gets;

$$\begin{aligned}
L_{GF} = & -\frac{1}{2\xi} \left[ \partial^\mu Z_{1\mu} - \xi M_{Z_1} G_1^o \right]^2 - \frac{1}{2\xi} \left[ \partial^\mu Z_{2\mu} - \xi M_{Z_2} G_2^o \right]^2 \\
& - \frac{1}{\xi} \left[ \partial^\mu W_{1\mu}^+ + i\xi M_{W_1} G_1^+ \right] \left[ \partial^\mu W_{1\mu}^- - i\xi M_{W_1} G_1^- \right] \\
& - \frac{1}{\xi} \left[ \partial^\mu W_{2\mu}^+ + i\xi M_{W_2} G_2^+ \right] \left[ \partial^\mu W_{2\mu}^- - i\xi M_{W_2} G_2^- \right]
\end{aligned} \tag{95}$$

Now we can establish Fadeev-Popov Lagrangian of the theory. First using auxilary fields  $B_{L,R}^3, B_{L,R}^\pm, B_B$  we can change  $L_{GF}$  to the form

Because auxiliary fields  $B_{L,R}^3, B_{L,R}^\pm, B_B$  under BRS transformations give zero

$$\delta^{BRS} B_{L,R,B}^{3,\pm} = 0,$$

the F-P Lagrangian is explicitly as follow

$$\begin{aligned} L_{FP} = & \bar{c}_L^3 \delta^{BRS} \left\{ \partial^\mu W_{3L\mu} - \frac{ig\xi}{2\sqrt{2}} [\kappa_1(\phi_1^o - \phi_1^{o*}) - \kappa_2(\phi_2^o - \phi_2^{o*})] \right\} \\ & + \bar{c}_R^3 \delta^{BRS} \left\{ \partial^\mu W_{3R\mu} - \frac{ig\xi}{2} [\kappa(\phi_2^o - \phi_2^{o*}) - \kappa(\phi_1^o - \phi_1^{o*}) - 2v_R(\delta_R^o - \delta_R^{o*})] \right\} \\ & + \bar{c}^4 \delta^{BRS} \left[ \partial^\mu B_\mu - \frac{ig'v_R\xi}{\sqrt{2}}(\delta_R^o - \delta_R^{o*}) \right] + \bar{c}_L^- \delta^{BRS} \left\{ \partial^\mu W_{L\mu}^+ + \frac{ig\xi}{2} [\kappa_1\phi_2^+ - \kappa_2\phi_1^+] \right\} \\ & + \bar{c}_L^+ \delta^{BRS} \left\{ \partial^\mu W_{L\mu}^- - \frac{ig\xi}{2} [\kappa_1\phi_2^- - \kappa_2\phi_1^-] \right\} + \bar{c}_R^- \delta^{BRS} \left\{ \partial^\mu W_{R\mu}^+ + \frac{ig\xi}{2} [\kappa_1\phi_1^+ - \kappa_2\phi_2^+ - \sqrt{2}v_R\delta_R^+] \right\} \\ & + \bar{c}_R^+ \delta^{BRS} \left\{ \partial^\mu W_{R\mu}^- - \frac{ig\xi}{2} [\kappa_1\phi_1^- - \kappa_2\phi_2^- - \sqrt{2}v_R\delta_R^-] \right\} \end{aligned} \quad (98)$$

Putting for ghost fields  $c_{L,R}^{3\pm}, c^4$  the same transformations as for gauge bosons (Eqs.(2.1.2),(2.1.3)), namely

$$\begin{pmatrix} c_L^\pm \\ c_R^\pm \end{pmatrix} = \begin{pmatrix} \cos\xi & \sin\xi \\ -\sin\xi & \cos\xi \end{pmatrix} = \begin{pmatrix} c_1^\pm \\ c_2^\pm \end{pmatrix} \quad (99)$$

and

$$\begin{pmatrix} c_L^3 \\ c_R^3 \\ c^4 \end{pmatrix} = \begin{pmatrix} x_1 & x_2 & x_3 \\ y_1 & y_2 & y_3 \\ v_1 & v_2 & v_3 \end{pmatrix} \begin{pmatrix} c_1 \\ c_2 \\ c_0 \end{pmatrix} \quad (100)$$

we get all fields in physical terms. Masses of ghost fields are

$$(m_{c_{1,2}^\pm})^2 = i\xi(m_{W_{1,2}^\pm})^2$$

$$(m_{c_{1,2}})^2 = i\xi(m_{Z_{1,2}})^2$$

$$m_{c_0} = 0. \quad (101)$$

Finally let's write forms of propagators

- Ghost fields

$$i\Delta(p) = \frac{-1}{p^2 - \xi M_i^2 + i\varepsilon}, \quad \text{where } M_i = \begin{cases} M_{W_1} & \text{for } c_1^\pm \\ M_{W_2} & \text{for } c_2^\pm \\ M_{Z_1} & \text{for } c_1 \\ M_{Z_2} & \text{for } c_2 \end{cases} \quad (102)$$

# Renormalization procedure.

In this chapter we present definitions of renormalization constants on the mass shell scheme. The way how to calculate all counter terms for tadpoles, two and three point functions are given. Because unphysical particles do not appear in the external lines, we may impose any renormalization conditions for them thus we do not include them. Practically, it is convenient to use the minimal subtraction procedure (see [1]).

## IV RENORMALIZATION OF TADPOLES

Lorentz invariance prevents tadpoles for fields other than scalar ones. Thus if the diagram

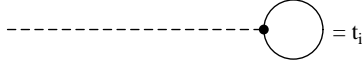

denotes tadpole  $t_i$  ( $i = H^0, H_1^0, H_2^0, H_3^0, A_1^0, A_2^0$ ) and the diagram

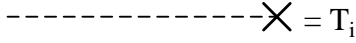

is an appropriate counter term  $T_i$  the renormalization conditions  $t_i + T_i = 0$  give renormalization constants  $T_i$ .

## V RENORMALIZATION CONDITIONS AND COUNTER TERMS FOR TWOPOINT FUNCTIONS

### A Denitions of the renormalization constants

All quantities below with (without) suffix 0 denote bare (renormalized) ones. Capital "IJ" (small "ij") indices represent up (down) fermions in the left and right handed doublets. For abbreviation we denote neutral physical Higgses ( $i = H^0, H_1^0, H_2^0, H_3^0, A_1^0, A_2^0$ ) using  $i, j$  indices (e.g.  $Z_{ij}^{\frac{1}{2}}$ 's in Eq.(...)), single charged Higgses  $H_{1,2}^{\pm}$  without ' $\pm$ ' prefix (e.g.  $Z_{H_1^+ H_2^+}^{\frac{1}{2}} \equiv Z_{H_1 H_2}^{\frac{1}{2}}$ ) and analogically we treat doubly charged Higgses (e.g.  $Z_{\delta_L^+ \delta_R^+}^{\frac{1}{2}} \equiv Z_{\delta_L \delta_R}^{\frac{1}{2}}$ ).

$$\begin{pmatrix} \circ^{\pm} \\ W_{1\mu}^{\pm} \\ \circ^{\pm} \\ W_{2\mu}^{\pm} \end{pmatrix} = \begin{pmatrix} Z_{W_1 W_1}^{\frac{1}{2}} & Z_{W_1 W_2}^{\frac{1}{2}} \\ Z_{W_2 W_1}^{\frac{1}{2}} & Z_{W_2 W_2}^{\frac{1}{2}} \end{pmatrix} \begin{pmatrix} W_{1\mu}^{\pm} \\ W_{2\mu}^{\pm} \end{pmatrix} \quad (108)$$

$$\begin{pmatrix} \circ^{\pm} \\ c_1^{\pm} \\ \circ^{\pm} \\ c_2^{\pm} \end{pmatrix} = \begin{pmatrix} \tilde{Z}_{W_1 W_1}^{\frac{1}{2}} & \tilde{Z}_{W_1 W_2}^{\frac{1}{2}} \\ \tilde{Z}_{W_2 W_1}^{\frac{1}{2}} & \tilde{Z}_{W_2 W_2}^{\frac{1}{2}} \end{pmatrix} \begin{pmatrix} c_1^{\pm} \\ c_2^{\pm} \end{pmatrix} \quad (109)$$

$$\circ_{1,2}^{\pm} = \bar{c}_{1,2}^{\pm} \quad (110)$$

$$\overset{\circ}{M}_{W_i}^2 = M_{W_i}^2 + \delta M_{W_i}^2 \equiv G_{W_i}^2 M_{W_i}^2 \quad i = 1, 2 \quad (128)$$

$$\overset{\circ}{M}_{Z_i}^2 = M_{Z_i}^2 + \delta M_{Z_i}^2 \equiv G_{Z_i}^2 M_{Z_i}^2 \quad i = 1, 2 \quad (129)$$

$$\overset{\circ}{M}_{G_i^0}^2 = M_{G_i^0}^2 + \delta M_{G_i^0}^2 \equiv G_{G_i^0}^2 M_{G_i^0}^2 \quad i = 1, 2 \quad (130)$$

$$\overset{\circ}{M}_i^2 = M_i^2 + \delta M_i^2 \equiv G_i^2 M_i^2 \quad i = H^0, H_1^0, H_2^0, H_3^0, A_1^0, A_2^0 \quad (131)$$

$$\overset{\circ}{M}_{G_i^\pm}^2 = M_{G_i^\pm}^2 + \delta M_{G_i^\pm}^2 \equiv G_{G_i^\pm}^2 M_{G_i^\pm}^2 \quad i = 1, 2 \quad (132)$$

$$\overset{\circ}{M}_{H_i^\pm}^2 = M_{H_i^\pm}^2 + \delta M_{H_i^\pm}^2 \equiv G_{H_i^\pm}^2 M_{H_i^\pm}^2 \quad i = 1, 2 \quad (133)$$

$$\overset{\circ}{M}_{\delta_L^{\pm\pm}}^2 = M_{\delta_L^{\pm\pm}}^2 + \delta M_{\delta_L^{\pm\pm}}^2 \equiv G_{\delta_L}^2 M_{\delta_L}^2 \quad (134)$$

$$\overset{\circ}{M}_{\delta_R^{\pm\pm}}^2 = M_{\delta_R^{\pm\pm}}^2 + \delta M_{\delta_R^{\pm\pm}}^2 \equiv G_{\delta_R}^2 M_{\delta_R}^2 \quad (135)$$

$$\overset{\circ}{m}_f^2 = m_f^2 + \delta m_f^2 \equiv G_f^2 m_f^2 \quad f = \text{leptons, quarks.} \quad (136)$$

## B Renormalization conditions and counter terms

### 1. Gauge-bosons.

In all the following pictures in this section the diagram

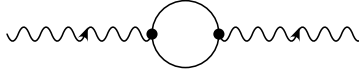

represents n-loop self-energy contribution, whereas



is an appropriate counter term. ‘ $k$ ’ stands for the particle momentum.

$$\begin{array}{c} \text{W}_{1\mu}^+ \\ \text{W}_{2\nu}^+ \end{array} \text{---} \text{---} \text{---} \text{---} = \left( g_{\mu\nu} - \frac{k_\mu k_\nu}{k^2} \right) A^{W_1 W_2}(k^2) + \frac{k_\mu k_\nu}{k^2} B^{W_1 W_2}(k^2),$$

$$\begin{array}{c} \text{W}_{1\mu}^+ \\ \text{W}_{2\nu}^+ \end{array} \text{---} \text{---} \text{---} \text{---} =$$

$$\left( g_{\mu\nu} - \frac{k_\mu k_\nu}{k^2} \right) \left[ (M_{\tilde{W}_1}^2 + \delta M_{\tilde{W}_1}^2) Z_{\tilde{W}_1 W_1}^{\frac{1}{2}} Z_{\tilde{W}_1 W_2}^{\frac{1}{2}} + \right.$$

$$(M_{\tilde{W}_2}^2 + \delta M_{\tilde{W}_2}^2) Z_{\tilde{W}_2 W_2}^{\frac{1}{2}} Z_{\tilde{W}_2 W_1}^{\frac{1}{2}} - k^2 \left( Z_{\tilde{W}_1 W_1}^{\frac{1}{2}} Z_{\tilde{W}_1 W_2}^{\frac{1}{2}} + Z_{\tilde{W}_2 W_2}^{\frac{1}{2}} Z_{\tilde{W}_2 W_1}^{\frac{1}{2}} \right) \left. \right] +$$

$$\frac{k_\mu k_\nu}{k^2} \left[ (M_{\tilde{W}_1}^2 + \delta M_{\tilde{W}_1}^2) Z_{\tilde{W}_1 W_1}^{\frac{1}{2}} Z_{\tilde{W}_1 W_2}^{\frac{1}{2}} + (M_{\tilde{W}_2}^2 + \delta M_{\tilde{W}_2}^2) Z_{\tilde{W}_2 W_2}^{\frac{1}{2}} Z_{\tilde{W}_2 W_1}^{\frac{1}{2}} \right].$$

These equations allow us to calculate six renormalization constants (prime prefix in the renormalization conditions below means differentiation over  $k^2$ ).

Renormalization conditions

Renormalization constants

$$\left. \begin{array}{l} A^{W_1}(M_{\tilde{W}_1}^2) = 0 \\ A^{W_1'}(M_{\tilde{W}_1}^2) = 0 \\ A^{W_2}(M_{\tilde{W}_2}^2) = 0 \\ A^{W_2'}(M_{\tilde{W}_2}^2) = 0 \\ A^{W_1 W_2}(M_{\tilde{W}_1}^2) = 0 \\ A^{W_1 W_2}(M_{\tilde{W}_2}^2) = 0 \end{array} \right\} \Rightarrow \begin{array}{l} Z_{\tilde{W}_1 W_1}^{\frac{1}{2}}, Z_{\tilde{W}_2 W_2}^{\frac{1}{2}}, \delta M_{\tilde{W}_1}^2 \\ Z_{\tilde{W}_1 W_2}^{\frac{1}{2}}, Z_{\tilde{W}_2 W_1}^{\frac{1}{2}}, \delta M_{\tilde{W}_2}^2 \end{array} \quad (137)$$

$$\begin{array}{c} \text{Z}_{1\mu} \\ \text{Z}_{1\nu} \end{array} \text{---} \text{---} \text{---} \text{---} = \left( g_{\mu\nu} - \frac{k_\mu k_\nu}{k^2} \right) A^{Z_1}(k^2) + \frac{k_\mu k_\nu}{k^2} B^{Z_1}(k^2),$$

$$\begin{array}{c} \text{Z}_{1\mu} \\ \text{Z}_{1\nu} \end{array} \text{---} \text{---} \text{---} \text{---} =$$

$$\left( g_{\mu\nu} - \frac{k_\mu k_\nu}{k^2} \right) \left[ (M_{\tilde{Z}_1}^2 + \delta M_{\tilde{Z}_1}^2) \left( Z_{\tilde{Z}_1 Z_1}^{\frac{1}{2}} \right)^2 + \right.$$

$$(M_{\tilde{Z}_2}^2 + \delta M_{\tilde{Z}_2}^2) \left( Z_{\tilde{Z}_2 Z_1}^{\frac{1}{2}} \right)^2 - k^2 \left( \left( Z_{\tilde{Z}_1 Z_1}^{\frac{1}{2}} \right)^2 + \left( Z_{\tilde{Z}_2 Z_1}^{\frac{1}{2}} \right)^2 + \left( Z_{AZ_1}^{\frac{1}{2}} \right)^2 \right) \left. \right] +$$

$$\frac{k_\mu k_\nu}{k^2} \left[ (M_{\tilde{Z}_1}^2 + \delta M_{\tilde{Z}_1}^2) \left( Z_{\tilde{Z}_1 Z_1}^{\frac{1}{2}} \right)^2 + (M_{\tilde{Z}_2}^2 + \delta M_{\tilde{Z}_2}^2) \left( Z_{\tilde{Z}_2 Z_1}^{\frac{1}{2}} \right)^2 \right].$$

$$\begin{array}{c} Z_{1\mu} \\ \text{wavy line} \end{array} \begin{array}{c} \text{circle} \\ \text{wavy line} \end{array} \begin{array}{c} A_\nu \\ \text{wavy line} \end{array} = \left( g_{\mu\nu} - \frac{k_\mu k_\nu}{k^2} \right) A^{Z_1 A}(k^2) + \frac{k_\mu k_\nu}{k^2} B^{Z_1 A}(k^2),$$

$$\begin{array}{c} Z_{1\mu} \\ \text{wavy line} \end{array} \begin{array}{c} \text{crossed circle} \\ \text{wavy line} \end{array} \begin{array}{c} A_\nu \\ \text{wavy line} \end{array} =$$

$$\begin{aligned} & \left( g_{\mu\nu} - \frac{k_\mu k_\nu}{k^2} \right) \left[ (M_{Z_1}^2 + \delta M_{Z_1}^2) Z_{Z_1 Z_1}^{\frac{1}{2}} Z_{Z_1 A}^{\frac{1}{2}} + \right. \\ & \left. (M_{Z_2}^2 + \delta M_{Z_2}^2) Z_{Z_2 Z_1}^{\frac{1}{2}} Z_{Z_2 A}^{\frac{1}{2}} - k^2 \left( Z_{Z_1 Z_1}^{\frac{1}{2}} Z_{Z_1 A}^{\frac{1}{2}} + Z_{Z_2 Z_1}^{\frac{1}{2}} Z_{Z_2 A}^{\frac{1}{2}} + Z_{AZ_1}^{\frac{1}{2}} Z_{AA}^{\frac{1}{2}} \right) \right] + \\ & \frac{k_\mu k_\nu}{k^2} \left[ (M_{Z_1}^2 + \delta M_{Z_1}^2) Z_{Z_1 Z_1}^{\frac{1}{2}} Z_{Z_1 A}^{\frac{1}{2}} + (M_{Z_2}^2 + \delta M_{Z_2}^2) Z_{Z_2 Z_1}^{\frac{1}{2}} Z_{Z_2 A}^{\frac{1}{2}} \right]. \end{aligned}$$

$$\begin{array}{c} Z_{2\mu} \\ \text{wavy line} \end{array} \begin{array}{c} \text{circle} \\ \text{wavy line} \end{array} \begin{array}{c} A_\nu \\ \text{wavy line} \end{array} = \left( g_{\mu\nu} - \frac{k_\mu k_\nu}{k^2} \right) A^{Z_2 A}(k^2) + \frac{k_\mu k_\nu}{k^2} B^{Z_2 A}(k^2),$$

$$\begin{array}{c} Z_{2\mu} \\ \text{wavy line} \end{array} \begin{array}{c} \text{crossed circle} \\ \text{wavy line} \end{array} \begin{array}{c} A_\nu \\ \text{wavy line} \end{array} =$$

$$\begin{aligned} & \left( g_{\mu\nu} - \frac{k_\mu k_\nu}{k^2} \right) \left[ (M_{Z_2}^2 + \delta M_{Z_2}^2) Z_{Z_2 Z_2}^{\frac{1}{2}} Z_{Z_2 A}^{\frac{1}{2}} + \right. \\ & \left. (M_{Z_1}^2 + \delta M_{Z_1}^2) Z_{Z_1 Z_2}^{\frac{1}{2}} Z_{Z_1 A}^{\frac{1}{2}} - k^2 \left( Z_{Z_2 Z_2}^{\frac{1}{2}} Z_{Z_2 A}^{\frac{1}{2}} + Z_{Z_1 Z_2}^{\frac{1}{2}} Z_{Z_1 A}^{\frac{1}{2}} + Z_{AZ_2}^{\frac{1}{2}} Z_{AA}^{\frac{1}{2}} \right) \right] + \\ & \frac{k_\mu k_\nu}{k^2} \left[ (M_{Z_2}^2 + \delta M_{Z_2}^2) Z_{Z_2 Z_2}^{\frac{1}{2}} Z_{Z_2 A}^{\frac{1}{2}} + (M_{Z_1}^2 + \delta M_{Z_1}^2) Z_{Z_1 Z_2}^{\frac{1}{2}} Z_{Z_1 A}^{\frac{1}{2}} \right]. \end{aligned}$$

Renormalization conditions

Renormalization constants

$$\left. \begin{array}{l} A^{Z_1}(M_{Z_1}^2) = 0, \quad A^{Z_1'}(M_{Z_1}^2) = 0, \\ A^{Z_2}(M_{Z_2}^2) = 0, \quad A^{Z_2'}(M_{Z_2}^2) = 0, \\ A^{Z_1 A}(M_{Z_1}^2) = 0, \quad A^{Z_1 A}(0) = 0, \\ A^{Z_2 A}(M_{Z_2}^2) = 0, \quad A^{Z_2 A}(0) = 0, \\ A^{Z_1 Z_2}(M_{Z_1}^2) = 0, \quad A^{Z_1 Z_2}(M_{Z_2}^2) = 0 \\ A^{A'}(0) = 0, \end{array} \right\} \Rightarrow \begin{array}{l} Z_{Z_1 Z_1}^{\frac{1}{2}}, Z_{Z_1 A}^{\frac{1}{2}}, Z_{Z_2 A}^{\frac{1}{2}}, Z_{AZ_1}^{\frac{1}{2}}, Z_{AZ_2}^{\frac{1}{2}}, Z_{AA}^{\frac{1}{2}}, \\ \delta M_{Z_1}^2, \delta M_{Z_2}^2, Z_{Z_1 Z_2}^{\frac{1}{2}}, Z_{Z_2 Z_1}^{\frac{1}{2}}, Z_{Z_2 Z_2}^{\frac{1}{2}}. \end{array} \quad (138)$$



$$\begin{array}{c}
\text{H}_i^+ \\
\text{---} \rightarrow \bullet \text{---} \circ \text{---} \bullet \text{---} \rightarrow \text{H}_i^+ \\
= F_{H_i H_i}(k^2), \quad i = 1, 2
\end{array}$$

$$\begin{array}{c}
\text{H}_i^+ \\
\text{---} \rightarrow \times \text{---} \rightarrow \text{H}_i^+ \\
= \\
- (M_{H_i}^2 + \delta M_{H_i}^2) \left( Z_{\frac{1}{2} H_i H_i} \right)^2 + k^2 \left( Z_{\frac{1}{2} H_i H_i} \right)^2 \\
- \left( M_{H_j}^2 + \delta M_{H_j}^2 \right) \left( Z_{\frac{1}{2} H_j H_i} \right)^2 + k^2 \left( Z_{\frac{1}{2} H_j H_i} \right)^2 .
\end{array}$$

$$\begin{array}{c}
\text{H}_i^+ \\
\text{---} \rightarrow \bullet \text{---} \circ \text{---} \bullet \text{---} \rightarrow \text{H}_j^+ \\
= F_{H_i H_j}(k^2),
\end{array}$$

$$\begin{array}{c}
\text{H}_i^+ \\
\text{---} \rightarrow \times \text{---} \rightarrow \text{H}_j^+ \\
= \\
- (M_{H_i}^2 + \delta M_{H_i}^2) \left( Z_{\frac{1}{2} H_i H_i} \right) \left( Z_{\frac{1}{2} H_i H_j} \right) + k^2 \left( Z_{\frac{1}{2} H_i H_i} \right) \left( Z_{\frac{1}{2} H_i H_j} \right) \\
- \left( M_{H_j}^2 + \delta M_{H_j}^2 \right) \left( Z_{\frac{1}{2} H_j H_j} \right) \left( Z_{\frac{1}{2} H_j H_i} \right) + k^2 \left( Z_{\frac{1}{2} H_j H_j} \right) \left( Z_{\frac{1}{2} H_j H_i} \right) .
\end{array}$$

In this case 6 renormalization constants are fixed.

Renormalization conditions      Renormalization constants

$$\left. \begin{array}{l}
F_{H_i H_i}(M_{H_i}^2) = 0 \\
F'_{H_i H_i}(M_{H_i}^2) = 0 \\
F_{H_i H_j}(M_{H_i}^2) = 0 \\
F_{H_i H_j}(M_{H_j}^2) = 0
\end{array} \right\} \Rightarrow Z_{\frac{1}{2} H_1 H_1}, Z_{\frac{1}{2} H_2 H_2}, Z_{\frac{1}{2} H_1 H_2}, Z_{\frac{1}{2} H_2 H_1}, \delta M_{H_1}^2, \delta M_{H_2}^2 \quad (140)$$

Finally, 6 renormalization constants connected with doubly charged Higgses can be found.

$$\begin{array}{c} i \\ \longrightarrow \\ \text{---} \circ \text{---} \\ \text{---} \circ \text{---} \\ \text{---} \longrightarrow \\ j \end{array} = K_1^{ij}(k^2)1 + K_5^{ij}(k^2)\gamma^5 + K_\gamma^{ij}(k^2)\hat{k} + K_5^{ij}\gamma(k^2)\hat{k}\gamma^5,$$

$$\begin{array}{c} i \\ \longrightarrow \\ \text{---} \times \text{---} \\ \longrightarrow \\ j \end{array} =$$

$$\begin{aligned} & \sum_a \left\{ 1 \left[ -\frac{1}{2}(Z_L^{\frac{1}{2}+})_{ia}(m_a + \delta m_a)(Z_R^{\frac{1}{2}})_{aj} - \right. \right. \\ & \left. \frac{1}{2}(Z_R^{\frac{1}{2}+})_{ia}(m_a + \delta m_a)(Z_L^{\frac{1}{2}})_{aj} \right] + \gamma^5 \left[ -\frac{1}{2}(Z_L^{\frac{1}{2}+})_{ia}(m_a + \delta m_a)(Z_R^{\frac{1}{2}})_{aj} + \right. \\ & \left. \frac{1}{2}(Z_R^{\frac{1}{2}+})_{ia}(m_a + \delta m_a)(Z_L^{\frac{1}{2}})_{aj} \right] + \hat{k} \left[ \frac{1}{2}(Z_L^{\frac{1}{2}+})_{ia}(Z_L^{\frac{1}{2}})_{aj} + \frac{1}{2}(Z_R^{\frac{1}{2}+})_{ia}(Z_R^{\frac{1}{2}})_{aj} \right] + \\ & \left. \hat{k}\gamma^5 \left[ -\frac{1}{2}(Z_L^{\frac{1}{2}+})_{ia}(Z_L^{\frac{1}{2}})_{aj} + \frac{1}{2}(Z_R^{\frac{1}{2}+})_{ia}(Z_R^{\frac{1}{2}})_{aj} \right] \right\}. \end{aligned}$$

Taking renormalization conditions

$i = j$  :

$$\begin{cases} K_1^{ii}(m_i^2) + m_i K_\gamma^{ii}(m_i^2) = 0 \\ K_5^{ii}(m_i^2) = 0 \\ K_{5\gamma}^{ii}(m_i^2) = 0 \\ \left[ \frac{\partial}{\partial k} (K_1^{ii}(k^2) + \hat{k} K_\gamma^{ii}(k^2)) \right]_{\hat{k}=m_i} = 0 \end{cases} \quad (142)$$

$i > j$  :

$$\begin{cases} K_1^{ij}(m_j^2) + m_j K_\gamma^{ij}(m_j^2) = 0 \\ K_5^{ij}(m_j^2) - m_j K_{5\gamma}^{ij}(m_j^2) = 0 \\ K_1^{ij}(m_i^2) + m_i K_\gamma^{ij}(m_i^2) = 0 \\ K_5^{ij}(m_i^2) + m_i K_{5\gamma}^{ij}(m_i^2) = 0 \end{cases} \quad (143)$$

78 renormalization constants can be found.

## VI RENORMALIZATION OF THE REMAINING PARAMETERS

### A Denitions of the renormalization constants

There are more free parameters in the Left-Right Symmetric Model than in the S.M.  $(\cos \varphi, \sin \xi, \Omega_{L,R}, K_{L,R})$ . Thus more renormalization condition must be introduced. We define the renormalization constants for remainig parameters as follow

where

$$(\delta Z_{L,R})_{ee} = (\delta Z_{L,R}^{\frac{1}{2}})_{ee} + (\delta Z_{L,R}^{\frac{1}{2}+})_{ee} \quad (154)$$

2. The renormalization constant  $\delta G_\xi$ .

One can determine the  $\delta G_\xi$  constant from the  $W_1 \nu_i e$  vertex for example;

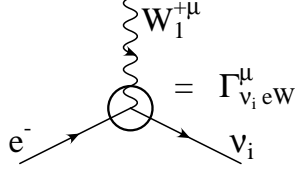

Renormalization conditions

Renormalization constants

$$\bar{u}(m_e) \Gamma_{\nu_i e W_1}^\mu u(m_e) |_{k^\mu = M_{W_1}} = 0 \quad \Rightarrow \quad \delta G_\xi. \quad (155)$$

where

$$\Gamma_{\nu_i e W_1}^\mu = i e \gamma^\mu \left( \Gamma_{CT}^{\nu_i e W_1} + \Gamma_D^{\nu_i e W_1} \right) \quad (156)$$

and

$$\begin{aligned} \Gamma_{CT}^{\nu_i e W_1} = & \frac{\cos \xi}{\sqrt{2} \sin \Theta} \left\{ \left[ \delta Y + \delta Z_{W_1 W_1}^{\frac{1}{2}} - \delta G_\Theta - \delta G_\xi \frac{\sin^2 \xi}{\cos^2 \xi} \right] (K_L)_{Ie} + \frac{1}{2} \sum_A \left( (\delta Z_L^{\frac{1}{2}})_{IA} + (\delta Z_L^{\frac{1}{2}+})_{IA} \right) (K_L)_{Ae} \right. \\ & + \frac{1}{2} \sum_b \left( (\delta Z_L^{\frac{1}{2}})_{be} + (\delta Z_L^{\frac{1}{2}+})_{be} \right) (K_L)_{Ib} + Z_{W_2 W_1}^{\frac{1}{2}} \frac{\sin \xi}{\sqrt{2} \sin \Theta} (K_L)_{Ie} \left. \right\} P_L \\ & - \frac{\sin \xi}{\sqrt{2} \sin \Theta} \left\{ \left[ \delta Y + \delta Z_{W_1 W_1}^{\frac{1}{2}} - \delta G_\Theta + \delta G_\xi \right] (K_R)_{Ie} + \frac{1}{2} \sum_A \left( (\delta Z_R^{\frac{1}{2}})_{IA} + (\delta Z_R^{\frac{1}{2}+})_{IA} \right) (K_R)_{Ae} \right. \\ & + \frac{1}{2} \sum_b \left( (\delta Z_R^{\frac{1}{2}})_{be} + (\delta Z_R^{\frac{1}{2}+})_{be} \right) (K_R)_{Ib} + Z_{W_2 W_1}^{\frac{1}{2}} \frac{\cos \xi}{\sqrt{2} \sin \Theta} (K_R)_{Ie} \left. \right\} P_R \end{aligned} \quad (157)$$

3. The renormalization constants  $\delta G_\varphi, \delta G_\Theta$ .

To determine the  $\delta G_\varphi$  and  $\delta G_\Theta$  renormalization constants we exploit an additional vertex -  $Z_1 e^- e^-$ ;

Let us first consider the left handed part of the unrenormalized charged current interactions (for the right handed part all formulas are analogous) in the form

$$\overset{\circ}{N} \gamma^\mu P_L \overset{\circ}{K} \overset{\circ}{l} \quad (162)$$

which in the renormalized quantities reads

$$\begin{aligned} \bar{N}_L Z_L^{\frac{1}{2}\dagger} \gamma^\mu (K_L + \delta K_L) Z_L^{\frac{1}{2}} l_L &= \bar{N}_L \left(1 + \frac{1}{2} \delta Z_L^\dagger\right) \gamma^\mu (K_L + \delta K_L) \left(1 + \frac{1}{2} \delta Z_L^l\right) l_L \\ &= (J_L^\mu)_{CC} + (\delta J_L^\mu)_{CC} \end{aligned} \quad (163)$$

where

$$\begin{aligned} (\delta J_L^\mu)_{CC} &= \bar{N}_L \gamma^\mu \left( \frac{1}{2} \delta Z_L^\dagger K_L + \delta K_L + \frac{1}{2} K_L \delta Z_L^l \right) l_L \\ &= \bar{N}_L \gamma^\mu \left( \frac{1}{2} \delta Z_L^\dagger K_L + \delta K_L + \frac{1}{2} K_L \delta Z_L^l \right) l_L + \bar{N}_L \gamma^\mu \left( \frac{1}{4} \delta Z_L K_L - \frac{1}{4} \delta Z_L K_L \right) l_L \\ &\quad + \bar{N}_L \gamma^\mu \left( \frac{1}{4} K_L \delta Z_L^{\dagger l} - \frac{1}{4} K_L \delta Z_L^{\dagger l} \right) l_L. \end{aligned} \quad (164)$$

Using the formulas

$$K_L = U_L^\dagger U_L^l \quad (165)$$

$$U_L U_L^\dagger = I \quad (166)$$

$$U_L^l U_L^{\dagger l} = U_L^{\dagger l} U_L^l = I, \quad (167)$$

which are satisfied for the bar and renormalized quantities, for the one loop level we have

$$\begin{aligned} \overset{\circ}{U}_L \overset{\circ}{U}_L^l &= \left( U_L^\dagger + \delta U_L^\dagger \right) \left( U_L^l + \delta U_L^l \right) = K_L + U_L^\dagger \delta U_L^l + \delta U_L^\dagger U_L^l = K_L + \delta U_L^\dagger U_L K_L + K_L U_L^{\dagger l} \delta U_L^l \\ &= K_L + \delta K_L \end{aligned} \quad (168)$$

and thus

$$\begin{aligned} (\delta J_L^\mu)_{CC} &= \bar{N}_L \gamma^\mu \left\{ \frac{1}{4} \left( \delta Z_L^\dagger + \delta Z_L \right) K_L + \frac{1}{4} K_L \left( \delta Z_L^l + \delta Z_L^{\dagger l} \right) \right\} l_L \\ &\quad + \bar{N}_L \gamma^\mu \left[ \frac{1}{4} \left( \delta Z_L^\dagger - \delta Z_L \right) + \delta U_L^\dagger U_L \right] K_L l_L + \bar{N}_L \gamma^\mu K_L \left[ \frac{1}{4} \left( \delta Z_L^l - \delta Z_L^{\dagger l} \right) + U_L^{\dagger l} \delta U_L^l \right] l_L. \end{aligned} \quad (169)$$

Requiring that the antihermitean part vanish (i.e. the terms in square brackets) we may fix  $\delta U_L^\dagger$  and  $\delta U_L$

$$\delta U_L^\dagger = -\frac{1}{4} \left( \delta Z_L^\dagger - \delta Z_L \right) U_L^\dagger \quad (170)$$

$$\delta U_L = -\frac{1}{4} U_L \left( \delta Z_L - \delta Z_L^\dagger \right). \quad (171)$$

# Renormalization of the $Z_1\nu_i\nu_j$ vertex.

## VII THE GENERAL SCHEME

Having definitions of renormalization constants we can go to the main part of our work i.e. to the renormalization of the  $Z_1\nu_i\nu_j$  vertex;

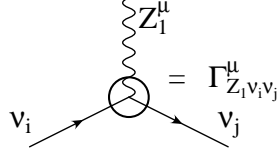

We can decompose the full  $Z_1\nu_i\nu_j$  vertex in the two components, to the counter term part and to the contributions from the diagrams

$$\Gamma_{Z_1\nu_i\nu_j}^\mu = ie\gamma^\mu \left( \Gamma_{CT}^{Z_1\nu_i\nu_j} + \Gamma_D^{Z_1\nu_i\nu_j} \right) \quad (180)$$

where

$$\Gamma_{CT}^{Z_1\nu_i\nu_j} \equiv (P_L(CT)_L + P_R(CT)_R). \quad (181)$$

The following bar Lagrangian contributes to the  $Z_1\nu_i\nu_j$  vertex

$$\begin{aligned} \mathring{L}_{Z_1\nu_i\nu_j} = \frac{i\mathring{e}}{2\sin\Theta\mathring{c}\Theta} \sum_{a,b} \left\{ \mathring{N}_a \gamma^\mu P_L \left( \mathring{A}_L^{1\nu} (\mathring{\Omega}_L)_{ab} - \mathring{A}_R^{1\nu} (\mathring{\Omega}_R)_{ba} \right) \mathring{N}_b \mathring{Z}_{1\mu} + \right. \\ \mathring{N}_a \gamma^\mu P_R \left( \mathring{A}_R^{1\nu} (\mathring{\Omega}_R)_{ab} - \mathring{A}_L^{1\nu} (\mathring{\Omega}_L)_{ba} \right) \mathring{N}_b \mathring{Z}_{1\mu} + \\ \mathring{N}_a \gamma^\mu P_L \left( \mathring{A}_L^{2\nu} (\mathring{\Omega}_L)_{ab} - \mathring{A}_R^{2\nu} (\mathring{\Omega}_R)_{ba} \right) \mathring{N}_b \mathring{Z}_{2\mu} + \\ \left. \mathring{N}_a \gamma^\mu P_R \left( \mathring{A}_R^{2\nu} (\mathring{\Omega}_R)_{ab} - \mathring{A}_L^{2\nu} (\mathring{\Omega}_L)_{ba} \right) \mathring{N}_b \mathring{Z}_{2\mu} \right\} \quad (182) \end{aligned}$$

where

$$\mathring{A}_L^{1\nu} = \mathring{c}\phi - \sqrt{1 - \mathring{c}\phi^2} \frac{\mathring{\sin}^2 \Theta}{\sqrt{1 - 2\mathring{\sin}^2 \Theta}} \quad (183)$$

$$\mathring{A}_R^{1\nu} = -\sqrt{1 - \mathring{c}\phi^2} \frac{1 - \mathring{\sin}^2 \Theta}{\sqrt{1 - 2\mathring{\sin}^2 \Theta}} \quad (184)$$

$$\mathring{A}_L^{2\nu} = \sqrt{1 - \mathring{c}\phi^2} + \mathring{c}\phi \frac{\mathring{\sin}^2 \Theta}{\sqrt{1 - 2\mathring{\sin}^2 \Theta}} \quad (185)$$

Analyzing the previous paragraphs it is easy to realize that expressions needed for the renormalizing  $Z_1\nu_i\nu_j$  vertex in the Left-Right Symmetric Model are much more complex than ones for the Standard Model. To have a good test if the method really works we have decided to check the cancellation of the infinity part in the  $Z_1\nu_i\nu_j$  vertex. In fact it was the most important task to do. If our calculations failed all work would be useless. We have made numerical calculations using the "Mathematica" program, proving that all infinities in the  $Z_1\nu_i\nu_j$  vertex really cancell. Since the full formulas (i.e. the finity and infinity part) for renormalization constants take too much room we don't write them explicitly in the article ( we plan to put all of them on the server). Here we show only the diagrams which contributes to the propagators and to the vertices used for the renormalization of the  $Z_1\nu_i\nu_j$  vertex;

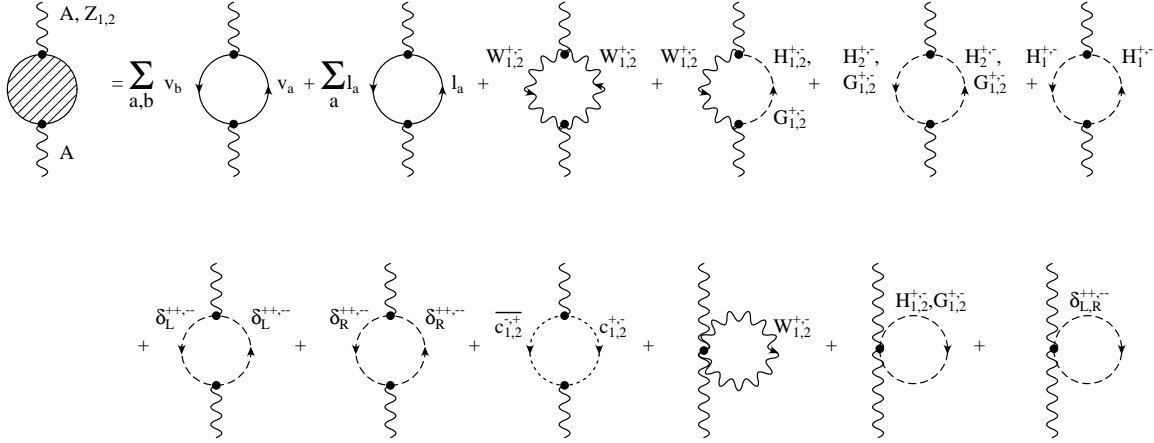

Fig.1

The  $A - A, Z_{1,2}$  bosons one loop self-energy diagrams. The summation is over the neutrino ( $\nu_a, \nu_b$ ) and the charged lepton flavors ( $l_a$ ).

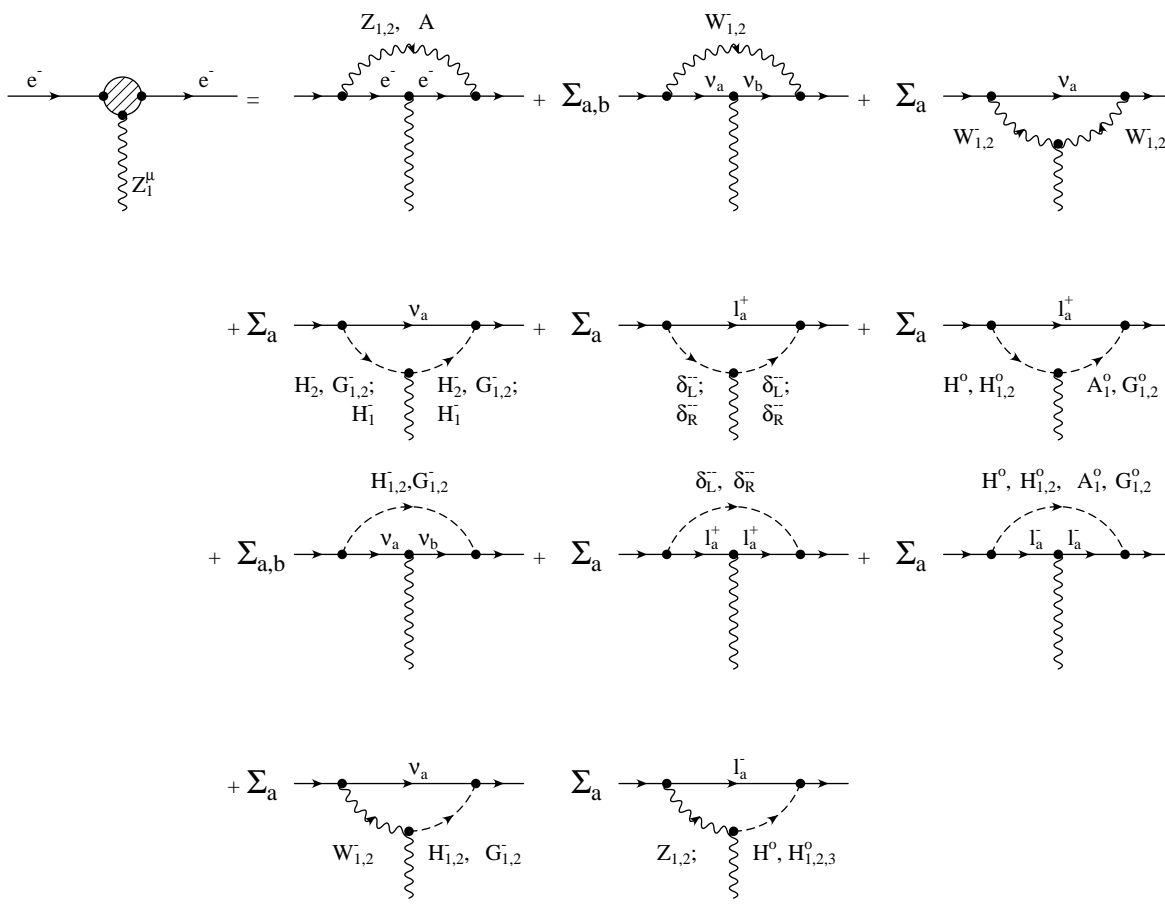

Fig.4

The one-loop diagrams for the  $Z_1 ee$  vertex.

P. Duka, J.Gluza and M.Zralek  
 Department of Field Theory and Particle Physics  
 Institute of Physics, University of Silesia  
 Uniwersytecka 4, PL-40-007 Katowice, Poland

<sup>s</sup>  
 PACS number(s): 13.15.-f, 12.15.Cc,14.60.Gh

## Part I

# Model at the tree level.

For consistency we have written down below the full Lagrangian at the tree level we use. As stated in this section we use the model where

- (i) manifest-left right symmetry (Eq.(23));...
- (ii)  $g_L = g_R$ .....;
- (iii) Higgs sector is simplified ....
- (iv) .....

### I STRUCTURE OF THE LAGRANGIAN OF THE THEORY

#### A Fermion and gauge elds

In the  $SU(2)_L \otimes SU(2)_R \otimes U(1)_{B-L}$  gauge model quarks (Q) and leptons (L) are placed in doublets

$$L_{iL} = \begin{pmatrix} \nu_i \\ l_i^- \end{pmatrix}_L : (2, 1, -1), L_{iR} = \begin{pmatrix} \nu_i \\ l_i^- \end{pmatrix}_R : (1, 2, -1) \quad (1)$$

$$Q_{iL} = \begin{pmatrix} u_i \\ d_i \end{pmatrix}_L : (2, 1, 1/3), Q_{iR} = \begin{pmatrix} u_i \\ d_i \end{pmatrix}_R : (1, 2, 1/3) \quad (2)$$

$i=1,2,3$  runs over number of generations. In paranthesis quantum numbers connected with  $SU(2)_L, SU(2)_R, U(1)_{B-L}$  groups respectively are assigned. The quantum number for  $U(1)_{B-L}$  gauge group is obtained by means of particles' charge identification

---

\*This work was supported by Polish Committee for Scientific Researches under Grants Nos. 2252/2/91 and 2P30225206/93



In order to produce fermion mass matrices we need the following Higgs multiplets (again as, in the fermion case, in paranthesis quantum numbers  $(T_{3L}, T_{3R}, Y_{B-L})$  are given)

$$\phi = \begin{pmatrix} \phi_1^0 & \phi_1^+ \\ \phi_2^- & \phi_2^0 \end{pmatrix} : \left( \frac{1}{2}, \frac{1}{2}, 0 \right); \quad (13)$$

$$\tilde{\phi} = \tau_2 \phi^* \tau_2 : \left( \frac{1}{2}, \frac{1}{2}, 0 \right) \quad (14)$$

with gauge transformation

$$\phi' = \left[ e^{-ig_L \frac{\tau}{2} \tilde{\Theta}(x)} \otimes e^{ig_R \frac{\tau}{2} \tilde{\Theta}(x)} \otimes 1_{B-L} \right] \phi. \quad (15)$$

Consequently the most general Yukawa Lagrangian is given by

$$L_Y = \sum_i \bar{L}_{iL} \left( h\phi + \tilde{h}\tilde{\phi} \right) L_{iR} + \sum_i \bar{Q}_{iL} \left( h\phi^q + \tilde{h}^q \tilde{\phi} \right) Q_{iR} + h.c. \quad (16)$$

However, bidoublet  $\phi$  is not sufficient for breaking  $SU(2)_L \otimes SU(2)_R \otimes U(1)_{B-L}$  gauge group to the standard  $SU(2)_L \otimes U(1)$  one. This is because after SSB  $\langle \phi \rangle = \begin{pmatrix} \kappa_1 & 0 \\ 0 & \kappa_2 \end{pmatrix}$  symmetry is broken to  $U(1) \otimes U(1)$  gauge group. Explicitly

$$Y \langle \phi \rangle = 0 \quad (17)$$

$$(T_{3L} + T_{3R}) \langle \phi \rangle = \left( Q - \frac{Y}{2} \right) \langle \phi \rangle = 0. \quad (18)$$

There are other possibilities to break this gauge group to the SM one [?]. Among them the most popular is breaking using Higgs triplets  $(\Delta_L \sim (3, 1, 2), \Delta_R \sim (1, 3, 2))$  in addition to the bidoublet  $\phi$

$$\Delta_{L,R} = \begin{pmatrix} \delta_{L,R}^+/\sqrt{2} & \delta_{L,R}^{++} \\ \delta_{L,R}^0 & -\delta_{L,R}^+/\sqrt{2} \end{pmatrix}. \quad (19)$$

This Higgs sector leads to appropriate gauge symmetry breaking by the chain

$$SU(2)_L \otimes SU(2)_R \otimes U(1)_{B-L} \xrightarrow{v_R} SU(2)_L \otimes U(1)_Y \xrightarrow{\kappa_1, \kappa_2, v_L} U(1)_{em}. \quad (20)$$

This will be shown in the next Section.

Now we can build the kinetic part of the Lagrangian

$$L = Tr \left[ (D_\mu \Delta_L)^\dagger (D^\mu \Delta_L) \right] + Tr \left[ (D_\mu \Delta_R)^\dagger (D^\mu \Delta_R) \right] + Tr \left[ (D_\mu \phi)^\dagger (D^\mu \phi) \right]. \quad (21)$$

where

$$\begin{aligned} D_\mu \phi &= \partial_\mu \phi - ig_L \vec{W}_{L\mu} \frac{\vec{\tau}}{2} \phi - ig_R \phi \frac{\vec{\tau}}{2} \vec{W}_{R\mu}, \\ D_\mu \Delta_{L,R} &= \partial_\mu \Delta_{L,R} - ig_L \left[ \frac{\vec{\tau}}{2} \vec{W}_{L\mu}, \Delta_L \right] - ig_R \left[ \frac{\vec{\tau}}{2} \vec{W}_{R\mu}, \Delta_R \right] - ig' B_\mu \Delta_{L,R}. \end{aligned} \quad (22)$$

1. Gauge bosons

Masses of gauge bosons are obtained from the Lagrangian Eq.(21)

The charged and neutral gauge boson mass matrices  $\tilde{M}_W^2, \tilde{M}_0^2$  are the following (in basis  $(W_L^{\mu\pm} = \frac{1}{\sqrt{2}}(W_{1L}^\mu \mp iW_{2L}^\mu), W_R^{\mu\pm} = \frac{1}{\sqrt{2}}(W_{1R}^\mu \mp iW_{2R}^\mu)$  and  $(W_{3L}^\mu, W_{3R}^\mu, B^\mu)$ , respectively)

$$\begin{aligned} \tilde{M}_W^2 &= \frac{g^2}{4} \begin{pmatrix} \kappa_+^2 & -4\kappa_1\kappa_2 \\ -4\kappa_1\kappa_2 & \kappa_+^2 + 2v_R^2 \end{pmatrix} \\ \tilde{M}_0^2 &= \begin{pmatrix} \frac{g^2}{2}\kappa_+^2 & -\frac{g^2}{2}\kappa_+^2 & 0 \\ -\frac{g^2}{2}\kappa_+^2 & \frac{g^2}{2}(\kappa_+^2 + 4v_R^2) & -4gg'v_R^2 \\ 0 & -4gg'v_R^2 & 4g'^2v_R^2 \end{pmatrix}. \end{aligned} \quad (27)$$

These mass matrices are diagonalized by the unitary transformation for charged gauge bosons

$$\begin{pmatrix} W_L^\pm \\ W_R^\pm \end{pmatrix} = \begin{pmatrix} \cos\xi & \sin\xi \\ -\sin\xi & \cos\xi \end{pmatrix} = \begin{pmatrix} W_1^\pm \\ W_2^\pm \end{pmatrix} \quad (28)$$

and by orthogonal transformation in neutral sector

$$\begin{aligned} \begin{pmatrix} W_{3L} \\ W_{3R} \\ B \end{pmatrix} &= \begin{pmatrix} c_w c & c_w s & s_w \\ -s_w s_m c - c_m s & -s_w s_m s + c_m c & c_w s_m \\ -s_w c_m c + s_m s & -s_w c_m s - s_m c & c_w c_m \end{pmatrix} \begin{pmatrix} Z_1 \\ Z_2 \\ A \end{pmatrix} \equiv \\ &\begin{pmatrix} x_1 & x_2 & x_3 \\ y_1 & y_2 & y_3 \\ v_1 & v_2 & v_3 \end{pmatrix} \begin{pmatrix} Z_1 \\ Z_2 \\ A \end{pmatrix} \end{aligned} \quad (29)$$

where

$$\begin{aligned} s(c)_w &\equiv \sin(\cos)\Theta, & s(c) &\equiv \sin(\cos)\phi; \\ c_m &\equiv \frac{\sqrt{\cos 2\Theta}}{\cos \Theta}, & s_m &\equiv \tan \Theta, \\ g &= \frac{e}{\sin \Theta}, & g' &= \frac{e}{\sqrt{\cos 2\Theta}} \end{aligned}$$

2. Fermions

The Yukawa interaction for leptons has the following form

$$L_{Yukawa} \equiv L_Y^B + L_Y^L + L_Y^R = -\bar{L}_L [h\phi + \tilde{h}\tilde{\phi}] L_R - \bar{L}_L C i\tau_2 h_L \Delta_L L_L - \bar{L}_R C i\tau_2 h_R \Delta_R L_R \quad (30)$$

and from left-right symmetry (23) we get

$$U_L^{\dagger} \tilde{m}_l U_R^l = m_l \quad (41)$$

where  $m_l$  is a diagonal, positive  $3 \times 3$  matrix and unitary matrices  $U_{L,R}^l$  yield the physical lepton fields  $\hat{l} = \hat{l}_L + \hat{l}_R$ ,

$$l_{L,R} = U_{L,R}^l \hat{l}_{L,R}. \quad (42)$$

The Yukawa interaction for quarks equal

$$L_{Yukawa}^q = \sum_i \bar{Q}_{iL} \left[ h^q \phi + \tilde{h}^q \tilde{\phi} \right] Q_{iR} + h.c. \quad (43)$$

Charge conservation does not allow for Majorana terms (Eq.30) to be present here.

After SSB we get

$$L_{mass}^q = -M_u \bar{u}_L u_R - M_d \bar{d}_L d_R \quad (44)$$

where

$$M_u = \frac{1}{\sqrt{2}} \left( h^q \kappa_1 + \tilde{h}^q \kappa_2 \right), \quad M_d = \frac{1}{\sqrt{2}} \left( \tilde{h}^q \kappa_1 + h^q \kappa_2 \right). \quad (45)$$

Defining physical states

$$u_{L,R} = V_{L,R}^u \hat{u}_{L,R}, \quad (46)$$

$$d_{L,R} = V_{L,R}^d \hat{d}_{L,R} \quad (47)$$

we have

$$m_u = (m_u, m_c, m_t)_{diag} = V_L^{u\dagger} M_u V_R^u, \quad (48)$$

$$m_d = (m_d, m_s, m_b)_{diag} = V_L^{d\dagger} M_d V_R^d. \quad (49)$$

### 3. Higgs particles

Minimalization of the Higgs potential gives us relation between physical and gauge Higgses, too  $\left( \kappa_{\pm} = \sqrt{\kappa_1^2 \pm \kappa_2^2} \right)$

$$\phi_0^1 = \frac{1}{\sqrt{2}\kappa_+} \left[ H_0^0 (\kappa_1 a_0 - \kappa_2 b_0) + H_1^0 (\kappa_1 a_1 - \kappa_2 b_1) + H_2^0 (\kappa_1 a_2 - \kappa_2 b_2) + i\kappa_1 \tilde{G}_1^0 - i\kappa_2 A_1^0 \right], \quad (50)$$

$$\phi_0^2 = \frac{1}{\sqrt{2}\kappa_+} \left[ H_0^0 (\kappa_2 a_0 + \kappa_1 b_0) + H_1^0 (\kappa_2 a_1 + \kappa_1 b_1) + H_2^0 (\kappa_2 a_2 + \kappa_1 b_2) - i\kappa_2 \tilde{G}_1^0 - i\kappa_1 A_1^0 \right], \quad (51)$$

$$\delta_L^0 = \frac{1}{\sqrt{2}} (H_3^0 + iA_2^0), \quad (52)$$

$$\delta_R^0 = \frac{1}{\sqrt{2}} (c_0 H_0^0 + c_1 H_1^0 + c_2 H_2^0 + iG_2^0), \quad (53)$$

The charged current Lagrangian (Eq.10)

$$L_{CC} = \frac{g}{\sqrt{2}} \bar{\nu} \gamma^\mu \left( P_L W_{L\mu}^+ + P_R W_{R\mu}^+ \right) l + h.c. \quad (63)$$

converted to the physical one is the following (Eqs.(39),(42),(28))

$$L_{CC} = \bar{N} \gamma^\mu \left( A_L^{(1)} P_L + A_R^{(1)} P_R \right) \hat{W}_{1\mu}^+ + \bar{N} \gamma^\mu \left( A_L^{(2)} P_L + A_R^{(2)} P_R \right) \hat{W}_{2\mu}^+ + h.c., \quad (64)$$

where

$$\begin{aligned} A_L^{(1)} &= \frac{e}{\sqrt{2} \sin \Theta} \cos \xi K_L, & A_R^{(1)} &= -\frac{e}{\sqrt{2} \sin \Theta} \sin \xi K_R, \\ A_L^{(2)} &= \frac{e}{\sqrt{2} \sin \Theta} \sin \xi K_L, & A_R^{(2)} &= \frac{e}{\sqrt{2} \sin \Theta} \cos \xi K_R, \end{aligned}$$

and  $K_L(K_R)$  are  $6 \times 3$  mixing matrices

$$K_L = U_L^\dagger U_L^l, \quad K_R = U_R^\dagger U_R^l. \quad (65)$$

Similarly the neutral current Lagrangian in the L-R model is given by

$$L_{NC} = \frac{e}{2 \sin \Theta_W \cos \Theta_W} [J_1^\mu Z_{1\mu} + J_2^\mu Z_{2\mu}] - e J_{em}^\mu A_\mu, \quad (66)$$

where  $J_{em}^\mu = \bar{l} \gamma^\mu l$  and neutral currents  $J_{1,2}^\mu$  are equal

$$J_i^\mu = \bar{l} \gamma^\mu [A_L^{il} P_L + A_R^{il} P_R] l + \bar{\nu} \gamma^\mu [A_L^{i\nu} \Omega_L P_L + A_R^{i\nu} \Omega_R P_R] \nu, \quad (67)$$

with

$$\begin{aligned} \Omega_L &= U_L^\dagger U_L, & \Omega_R &= U_R^\dagger U_R; \\ A_L^{1l} &= \cos \phi g_L^e + \sin \phi g_L^{\prime e}, & A_L^{1\nu} &= \cos \phi + \sin \phi g_L^{\prime e} \\ A_R^{1l} &= \cos \phi g_R^e + \sin \phi g_R^{\prime e}, & A_R^{1\nu} &= \sin \phi g_R^{\prime \nu}, \\ A_L^{2l} &= \cos \phi \left( -g_L^{\prime e} \right) + \sin \phi g_L^e, & A_L^{2\nu} &= \cos \phi \left( -g_L^{\prime e} \right) + \sin \phi, \\ A_R^{2l} &= \cos \phi \left( -g_R^{\prime e} \right) + \sin \phi g_R^e, & A_R^{2\nu} &= \cos \phi \left( -g_R^{\prime \nu} \right), \end{aligned} \quad (68)$$

and

$$\begin{aligned} g_L^e &= -1 + 2 \sin^2 \Theta, & g_L^{\prime e} &= -\frac{\sin^2 \Theta}{\sqrt{\cos 2\Theta}}, \\ g_R^e &= 2 \sin^2 \Theta, & g_R^{\prime e} &= \frac{1-3 \sin^2 \Theta}{\sqrt{\cos 2\Theta}}, & g_R^{\prime \nu} &= -\frac{\cos^2 \Theta}{\sqrt{\cos 2\Theta}}. \end{aligned}$$

## Quarks

The charged current Lagrangian for quarks can be written in a similar way. The only difference is connected with other mixing matrices

$$\begin{aligned}
L_g^{3,4} = & -ig \left\{ \partial^\mu W_{1\nu}^{-\nu} \left[ (\sin^2 \xi W_{1\mu}^+ - \cos \xi \sin \xi W_{2\mu}^+) (y_1 Z_{1\nu} + y_2 Z_{2\nu} + y_3 A_\nu) \right. \right. \\
& - (\sin^2 \xi W_{1\nu}^+ - \cos \xi \sin \xi W_{2\nu}^+) (y_1 Z_{1\mu} + y_2 Z_{2\mu} + y_3 A_\mu) \left. \right] - h.c. \\
& + \partial^\mu W_{2\nu}^{-\nu} \left[ (-\cos \xi \sin \xi W_{1\mu}^+ + \cos^2 \xi W_{2\mu}^+) (y_1 Z_{1\nu} + y_2 Z_{2\nu} + y_3 A_\nu) \right. \\
& - (-\cos \xi \sin \xi W_{1\nu}^+ + \cos^2 \xi W_{2\nu}^+) (y_1 Z_{1\mu} + y_2 Z_{2\mu} + y_3 A_\mu) \left. \right] - h.c. \left. \right\} \\
& - g^2 \left\{ [\sin^2 \xi W_1^{-\mu} W_{1\mu}^+ - \cos \xi \sin \xi (W_1^{+\mu} W_{2\mu}^- + W_1^{-\mu} W_{2\mu}^+) + \cos^2 \xi W_2^{+\mu} W_{2\mu}^-] \right. \\
& \times (y_1 Z_1^\nu + y_2 Z_2^\nu + y_3 A^\nu) (y_1 Z_{1\nu} + y_2 Z_{2\nu} + y_3 A_\nu) \\
& - [\sin^2 \xi W_1^{+\nu} W_{1\mu}^- - \cos \xi \sin \xi (W_2^{-\nu} W_{1\mu}^+ + W_2^{+\nu} W_{1\mu}^-) + \cos^2 \xi W_2^{+\nu} W_{2\mu}^-] \\
& \times (y_1 Z_1^\mu + y_2 Z_2^\mu + y_3 A^\mu) (y_1 Z_{1\nu} + y_2 Z_{2\nu} + y_3 A_\nu) \left. \right\} \\
& - ig \left\{ \partial^\mu (y_1 Z_1^\nu + y_2 Z_2^\nu + y_3 A^\nu) [\sin^2 \xi (-W_{1\mu}^+ W_{1\nu}^- + W_{1\mu}^- W_{1\nu}^+) \right. \\
& - \cos \xi \sin \xi (-W_{2\mu}^+ W_{1\nu}^- + W_{2\mu}^- W_{1\nu}^+ - W_{1\mu}^+ W_{2\nu}^- + W_{1\mu}^- W_{2\nu}^+) + \cos^2 \xi (-W_{2\mu}^+ W_{2\nu}^- + W_{2\mu}^- W_{1\nu}^+) \left. \right\} \\
& + \frac{1}{2} g^2 \left\{ \sin^4 \xi [W_1^{-\mu} W_{1\mu}^- W_1^{+\nu} W_{1\nu}^+ - W_1^{+\mu} W_{1\mu}^- W_1^{-\nu} W_{1\nu}^+] \right. \\
& - 2 \sin^3 \xi \cos \xi [W_1^{-\mu} W_{1\mu}^- W_1^{+\nu} W_{2\nu}^+ - W_1^{+\mu} W_{1\mu}^- W_1^{-\nu} W_{2\nu}^+ - W_1^{-\mu} W_{1\mu}^+ W_1^{+\nu} W_{2\nu}^- + W_1^{+\mu} W_{1\mu}^+ W_1^{-\nu} W_{2\nu}^-] \\
& + 4 \sin^2 \xi \cos^2 \xi \left[ 2W_1^{-\mu} W_{2\mu}^- W_1^{+\nu} W_{2\nu}^+ - W_1^{+\mu} W_{2\mu}^- W_1^{-\nu} W_{2\nu}^+ - \frac{1}{2} W_1^{+\mu} W_{2\mu}^- W_1^{+\nu} W_{2\nu}^- - \frac{1}{2} W_1^{-\mu} W_{2\mu}^+ W_1^{-\nu} W_{2\nu}^+ \right. \\
& \left. + \frac{1}{2} W_1^{-\mu} W_{1\mu}^- W_2^{+\nu} W_{2\nu}^+ - W_1^{+\mu} W_{1\mu}^- W_2^{-\nu} W_{2\nu}^+ + \frac{1}{2} W_1^{+\mu} W_{1\mu}^+ W_2^{-\nu} W_{2\nu}^- \right] \\
& - 2 \cos^3 \xi \sin \xi [W_1^{-\mu} W_{2\mu}^- W_2^{+\nu} W_{2\nu}^+ - W_1^{+\mu} W_{2\mu}^- W_2^{-\nu} W_{2\nu}^+ - W_1^{-\mu} W_{2\mu}^+ W_2^{+\nu} W_{2\nu}^- + W_1^{+\mu} W_{2\mu}^+ W_2^{-\nu} W_{2\nu}^-] \\
& + \cos^4 \xi [W_2^{-\mu} W_{2\mu}^- W_2^{+\nu} W_{2\nu}^+ - W_2^{+\mu} W_{2\mu}^- W_2^{-\nu} W_{2\nu}^+] \left. \right\} \\
& - ig \left\{ \partial^\mu W_{1\nu}^{-\nu} \left[ (\cos^2 \xi W_{1\mu}^+ + \cos \xi \sin \xi W_{2\mu}^+) (y_1 Z_{1\nu} + y_2 Z_{2\nu} + y_3 A_\nu) \right. \right. \\
& - (\cos^2 \xi W_{1\nu}^+ + \cos \xi \sin \xi W_{2\nu}^+) (y_1 Z_{1\mu} + y_2 Z_{2\mu} + y_3 A_\mu) \left. \right] - h.c. \\
& + \partial^\mu W_{2\nu}^{-\nu} \left[ (+\cos \xi \sin \xi W_{1\mu}^+ + \sin^2 \xi W_{2\mu}^+) (y_1 Z_{1\nu} + y_2 Z_{2\nu} + y_3 A_\nu) \right. \\
& - (+\cos \xi \sin \xi W_{1\nu}^+ + \sin^2 \xi W_{2\nu}^+) (y_1 Z_{1\mu} + y_2 Z_{2\mu} + y_3 A_\mu) \left. \right] - h.c. \left. \right\} \\
& - g^2 \left\{ [\cos^2 \xi W_1^{-\mu} W_{1\mu}^+ + \cos \xi \sin \xi (W_1^{+\mu} W_{2\mu}^- + W_1^{-\mu} W_{2\mu}^+) + \sin^2 \xi W_2^{+\mu} W_{2\mu}^-] \right. \\
& \times (y_1 Z_1^\nu + y_2 Z_2^\nu + y_3 A^\nu) (y_1 Z_{1\nu} + y_2 Z_{2\nu} + y_3 A_\nu) \\
& - [\cos^2 \xi W_1^{+\nu} W_{1\mu}^- + \cos \xi \sin \xi (W_2^{-\nu} W_{1\mu}^+ + W_2^{+\nu} W_{1\mu}^-) + \sin^2 \xi W_2^{+\nu} W_{2\mu}^-] \\
& \times (y_1 Z_1^\mu + y_2 Z_2^\mu + y_3 A^\mu) (y_1 Z_{1\nu} + y_2 Z_{2\nu} + y_3 A_\nu) \left. \right\}
\end{aligned}$$

$$\begin{aligned}
A_0 &= \frac{\sqrt{2}}{\kappa_-^2} \left( \kappa_1 \phi_2^0 - \kappa_2 \phi_1^{0*} \right), & B_0 &= \frac{\sqrt{2}}{\kappa_-^2} \left( \kappa_1 \phi_1^0 - \kappa_2 \phi_2^{0*} \right), \\
A^\pm &= \frac{\sqrt{2}}{\kappa_-^2} \left( \kappa_1 \phi_1^\pm + \kappa_2 \phi_2^\pm \right), & B^\pm &= \frac{\sqrt{2}}{\kappa_-^2} \left( \kappa_2 \phi_1^\pm + \kappa_1 \phi_2^\pm \right).
\end{aligned} \tag{78}$$

The right-handed triplet interaction with leptons is

$$-L_Y^R = \delta_R^0 \bar{\nu}_L^c h_R \nu_R - \frac{\delta_R^+}{\sqrt{2}} (\bar{\nu}_L^c h_R e_R + \bar{e}_L^c h_R \nu_R) - \delta_R^{++} \bar{e}_L^c h_R e_R + h.c., \tag{79}$$

where the first two parts are given by

$$\begin{aligned}
\delta_R^0 \bar{\nu}_L^c h_R \nu_R + h.c. &= -\frac{1}{2v_R} \sum_a \bar{N}_a \left( \sum_c m_c^N \left[ (\Omega_R)_{ca}^2 P_R \delta_R^0 + (\Omega_R^*)_{ca}^2 P_L \delta_R^{0*} \right] \right) N_a \\
&\quad - \frac{1}{v_R} \sum_{a>b} \bar{N}_a \left( \sum_c m_c^N \left[ (\Omega_R)_{cb} (\Omega_R)_{ca} P_R \delta_R^0 + (\Omega_R^*)_{cb} (\Omega_R^*)_{ca} P_L \delta_R^{0*} \right] \right) N_b
\end{aligned} \tag{80}$$

and

$$\begin{aligned}
-\frac{\delta_R^+}{\sqrt{2}} (\bar{\nu}_L^c h_R e_R + \bar{e}_L^c h_R \nu_R) + h.c. &= -\frac{1}{v_R} \sum_{a,l} \left\{ \bar{N}_a \left[ \sum_b (\Omega_R^*)_{ab} m_b^N (K_R)_{bl} \right] P_R e_l \delta_R^+ \right. \\
&\quad \left. + \bar{e}_l \left[ \sum_b (K_R^\dagger)_{lb} m_b^N (\Omega_R^*)_{ba} \right] P_L N_a \delta_R^- \right\}.
\end{aligned} \tag{81}$$

Since  $v_L = 0$ , the interaction of the left-handed triplet can not be simple obtained by taking  $R \rightarrow L$  in Eqs. (81,82).

To get this interaction we use relation  $h_L = h_R \neq 0$ . Then

$$\begin{aligned}
\delta_L^0 \bar{\nu}_R^c h_L \nu_L + h.c. &= \frac{1}{\sqrt{2}v_R} \sum_a \bar{N}_a \left[ X_{aa} \delta_L^0 P_L + X_{aa}^* \delta_L^{0*} P_R \right] N_a \\
&\quad + \frac{\sqrt{2}}{v_R} \sum_{a>b} \bar{N}_a \left[ X_{ab} \delta_L^0 P_L + X_{ab}^* \delta_L^{0*} P_R \right] N_b,
\end{aligned} \tag{82}$$

and

$$\begin{aligned}
&-\frac{\delta_L^+}{\sqrt{2}} (\bar{\nu}_R^c h_L e_L + \bar{e}_R^c h_L \nu_L) + h.c. = \\
&-\frac{1}{v_R} \delta_L^+ \sum_{a,l} \bar{N}_a \sum_b X_{ab} (K_L)_{bl} P_L e_l + \frac{1}{v_R} \delta_L^- \sum_{a,l} \bar{e}_l \sum_b (K_L^\dagger)_{lb} (X^*)_{ba} P_R N_a,
\end{aligned} \tag{83}$$

The matrix X is given by

$$X_{ab} = \sum_c \left( U_R^\dagger U_L \right)_{ac}^T m_c^N \left( U_R^\dagger U_L \right)_{cb} = X_{ba}. \tag{84}$$

The quark part of the Yukawa lagrangian is the following

$$\begin{aligned}
L_{GF} = & -\frac{1}{2\xi} \left[ \partial^\mu Z_{1\mu} - \xi \left( a_{11}^{ZG} \tilde{G}_1^o + b_{12}^{ZG} \tilde{G}_2^o \right) \right]^2 - \frac{1}{2\xi} \left[ \partial^\mu Z_{2\mu} - \xi \left( a_{21}^{ZG} \tilde{G}_1^o + b_{22}^{ZG} \tilde{G}_2^o \right) \right]^2 \\
& - \frac{1}{\xi} \left[ \partial^\mu W_{1\mu}^+ + i\xi \left( (ab)_{1R}^{WG} G_R^+ + a_{1L}^{WG} G_L^+ \right) \right] \times \left[ \partial^\mu W_{1\mu}^- - i\xi \left( (ab)_{1R}^{WG} G_R^- + a_{1L}^{WG} G_L^- \right) \right] \\
& - \frac{1}{\xi} \left[ \partial^\mu W_{2\mu}^+ + i\xi \left( (ab)_{2R}^{WG} G_R^+ + a_{2L}^{WG} G_L^+ \right) \right] \times \left[ \partial^\mu W_{2\mu}^- - i\xi \left( (ab)_{2R}^{WG} G_R^- + a_{2L}^{WG} G_L^- \right) \right]
\end{aligned} \tag{89}$$

where;

$$\begin{aligned}
a_{11}^{ZG} &= -\frac{g}{\sqrt{2}} \kappa_+^2 (x_1 - y_1), & a_{21}^{ZG} &= -\frac{g}{\sqrt{2}} \kappa_+^2 (x_2 - y_2) \\
b_{12}^{ZG} &= -v_R (g' v_1 - g y_1), & b_{22}^{ZG} &= -v_R (g' v_2 - g y_2) \\
(ab)_{1R}^{WG} &= s \left\{ \kappa_2 a_{2R} - \kappa_1 a_{1R} + \frac{g v_R}{\sqrt{2}} a_{RR} \right\} \\
(ab)_{2R}^{WG} &= -c \left\{ \kappa_2 a_{2R} - \kappa_1 a_{1R} - \frac{g v_R}{\sqrt{2}} a_{RR} \right\} \\
a_{1L}^{WG} &= s (\kappa_2 a_{2L} - \kappa_1 a_{1L}) \\
a_{2L}^{WG} &= -c (\kappa_2 a_{2L} - \kappa_1 a_{1L}).
\end{aligned} \tag{90}$$

We can see from this Lagrangian that Goldstone bosons  $\tilde{G}_{1,2}^0$  and  $\tilde{G}_{L,R}^\pm$  must be join to give the ‘true’ Goldstone bosons  $G_{1,2}^0$  and  $G_{1,2}^\pm$  ‘eaten’ by appropriate gauge bosons ( $Z_{1,2}^0$  and  $W_{1,2}^\pm$ , respectively). Only then we can get rid of unwanted bilinear terms in the Lagrangian<sup>1</sup>. So we can define new Goldstone fields using the ortogonal transformations

$$\begin{pmatrix} G_1^\pm \\ G_2^\pm \end{pmatrix} = \begin{pmatrix} \frac{(ab)_{1R}^{WG}}{M_{W_1}} & \frac{a_{1L}^{WG}}{M_{W_1}} \\ \frac{(ab)_{2R}^{WG}}{M_{W_2}} & \frac{a_{2L}^{WG}}{M_{W_2}} \end{pmatrix} \begin{pmatrix} G_R^\pm \\ G_L^\pm \end{pmatrix} \equiv \begin{pmatrix} \cos \psi_c & -\sin \psi_c \\ \sin \psi_c & \cos \psi_c \end{pmatrix} \begin{pmatrix} G_R^\pm \\ G_L^\pm \end{pmatrix} \tag{92}$$

$$\begin{pmatrix} G_1^o \\ G_2^o \end{pmatrix} = \begin{pmatrix} \frac{a_{11}^{ZG}}{M_{Z_1}} & \frac{b_{12}^{ZG}}{M_{Z_1}} \\ \frac{a_{21}^{ZG}}{M_{Z_2}} & \frac{b_{22}^{ZG}}{M_{Z_2}} \end{pmatrix} \begin{pmatrix} \tilde{G}_1^o \\ \tilde{G}_2^o \end{pmatrix} \equiv \begin{pmatrix} \cos \psi_n & \sin \psi_n \\ \sin \psi_n & -\cos \psi_n \end{pmatrix} \begin{pmatrix} \tilde{G}_1^o \\ \tilde{G}_2^o \end{pmatrix} \tag{93}$$

and then one gets

$$\begin{aligned}
L_{GF} = & -\frac{1}{2\xi} \left[ \partial^\mu Z_{1\mu} - \xi M_{Z_1} G_1^o \right]^2 - \frac{1}{2\xi} \left[ \partial^\mu Z_{2\mu} - \xi M_{Z_2} G_2^o \right]^2 \\
& - \frac{1}{\xi} \left[ \partial^\mu W_{1\mu}^+ + i\xi M_{W_1} G_1^+ \right] \left[ \partial^\mu W_{1\mu}^- - i\xi M_{W_1} G_1^- \right] \\
& - \frac{1}{\xi} \left[ \partial^\mu W_{2\mu}^+ + i\xi M_{W_2} G_2^+ \right] \left[ \partial^\mu W_{2\mu}^- - i\xi M_{W_2} G_2^- \right]
\end{aligned} \tag{94}$$

---

<sup>1</sup>Such situation takes place in all gauge models where more neutral and/or charged gauge bosons exist (e.g. in  $SU(2) \otimes U(1)_{Y'} \otimes U(1)_{Y'}$  or GUT models.

$$c_{L,R}^{\pm} = \frac{1}{\sqrt{2}}(c_{L,R}^1 \mp ic_{L,R}^2) \quad (96)$$

Because auxiliary fields  $B_{L,R}^3, B_{L,R}^{\pm}, B_B$  under BRS transformations give zero

$$\delta^{BRS} B_{L,R,B}^{3,\pm} = 0,$$

the F-P Lagrangian is explicitly as follow

$$\begin{aligned} L_{FP} = & \bar{c}_L^3 \delta^{BRS} \left\{ \partial^\mu W_{3L\mu} - \frac{ig\xi}{2\sqrt{2}} [\kappa_1(\phi_1^o - \phi_1^{o*}) - \kappa_2(\phi_2^o - \phi_2^{o*})] \right\} \\ & + \bar{c}_R^3 \delta^{BRS} \left\{ \partial^\mu W_{3R\mu} - \frac{ig\xi}{2} [\kappa(\phi_2^o - \phi_2^{o*}) - \kappa(\phi_1^o - \phi_1^{o*}) - 2v_R(\delta_R^o - \delta_R^{o*})] \right\} \\ & + \bar{c}^4 \delta^{BRS} \left[ \partial^\mu B_\mu - \frac{ig'v_R\xi}{\sqrt{2}}(\delta_R^o - \delta_R^{o*}) \right] + \bar{c}_L^- \delta^{BRS} \left\{ \partial^\mu W_{L\mu}^+ + \frac{ig\xi}{2} [\kappa_1\phi_2^+ - \kappa_2\phi_1^+] \right\} \\ & + \bar{c}_L^+ \delta^{BRS} \left\{ \partial^\mu W_{L\mu}^- - \frac{ig\xi}{2} [\kappa_1\phi_2^- - \kappa_2\phi_1^-] \right\} + \bar{c}_R^- \delta^{BRS} \left\{ \partial^\mu W_{R\mu}^+ + \frac{ig\xi}{2} [\kappa_1\phi_1^+ - \kappa_2\phi_2^+ - \sqrt{2}v_R\delta_R^+] \right\} \\ & + \bar{c}_R^+ \delta^{BRS} \left\{ \partial^\mu W_{R\mu}^- - \frac{ig\xi}{2} [\kappa_1\phi_1^- - \kappa_2\phi_2^- - \sqrt{2}v_R\delta_R^-] \right\} \end{aligned} \quad (97)$$

Putting for ghost fields  $c_{L,R}^{3\pm}, c^4$  the same transformations as for gauge bosons (Eqs.(2.1.2),(2.1.3)), namely

$$\begin{pmatrix} c_L^{\pm} \\ c_R^{\pm} \end{pmatrix} = \begin{pmatrix} \cos\xi & \sin\xi \\ -\sin\xi & \cos\xi \end{pmatrix} = \begin{pmatrix} c_1^{\pm} \\ c_2^{\pm} \end{pmatrix} \quad (98)$$

and

$$\begin{pmatrix} c_L^3 \\ c_R^3 \\ c^4 \end{pmatrix} = \begin{pmatrix} x_1 & x_2 & x_3 \\ y_1 & y_2 & y_3 \\ v_1 & v_2 & v_3 \end{pmatrix} \begin{pmatrix} c_1 \\ c_2 \\ c_0 \end{pmatrix} \quad (99)$$

we get all fields in physical terms. Then masses of ghost fields are

$$(m_{c_{1,2}^{\pm}})^2 = i\xi(m_{W_{1,2}^{\pm}})^2$$

$$(m_{c_{1,2}})^2 = i\xi(m_{Z_{1,2}})^2$$

$$m_{c_0} = 0. \quad (100)$$

Finally let's write propagators which come from the consider Lagrangian

- Ghost fields

$$i\Delta(p) = \frac{-1}{p^2 - \xi M_i^2 + i\varepsilon}, \quad \text{where } M_i = \begin{cases} M_{W_1} & \text{for } c_1^{\pm} \\ M_{W_2} & \text{for } c_2^{\pm} \\ M_{Z_1} & \text{for } c_1 \\ M_{Z_2} & \text{for } c_2 \end{cases} \quad (101)$$



# Renormalization procedure.

In this chapter we present definitions of renormalization constants on the mass shell scheme. The way how to calculate all counter terms for tadpoles, two and three point functions are given. Because unphysical particles do not appear in the external lines, we may impose any renormalization conditions for them thus we do not include them. Practically, it is convenient to use the minimal subtraction procedure (see e.g. [3]).

## IV RENORMALIZATION OF TADPOLES

Lorentz invariance prevents tadpoles for fields other than scalar ones. Thus if the diagram

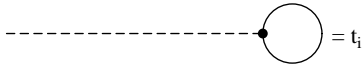

denotes tadpole  $t_i$  ( $i = H^0, H_1^0, H_2^0, H_3^0, A_1^0, A_2^0$ ) and the diagram

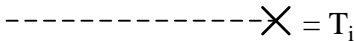

is an appropriate counter term  $T_i$  the renormalization conditions  $t_i + T_i = 0$  give renormalization constants  $T_i$ .

## V RENORMALIZATION CONDITIONS AND COUNTER TERMS FOR TWOPOINT FUNCTIONS

### A Denitions of the renormalization constants

All quantities below with (without) suffix 0 denote bare (renormalized) ones. Capital "IJ" (small "ij") indices represent up (down) fermions in the left and right handed doublets. For abbreviation we denote neutral physical Higgses ( $i = H^0, H_1^0, H_2^0, H_3^0, A_1^0, A_2^0$ ) using  $i, j$  indices (e.g.  $Z_{ij}^{\frac{1}{2}}$ 's in Eq.(...)), single charged Higgses  $H_{1,2}^{\pm}$  without ' $\pm$ ' prefix (e.g.  $Z_{H_1^+ H_2^+}^{\frac{1}{2}} \equiv Z_{H_1 H_2}^{\frac{1}{2}}$ ) and analogically we treat doubly charged Higgses (e.g.  $Z_{\delta_L^+ \delta_R^+}^{\frac{1}{2}} \equiv Z_{\delta_L \delta_R}^{\frac{1}{2}}$ ).

$$\begin{pmatrix} \circ^{\pm} \\ W_{1\mu}^{\pm} \\ \circ^{\pm} \\ W_{2\mu}^{\pm} \end{pmatrix} = \begin{pmatrix} Z_{W_1 W_1}^{\frac{1}{2}} & Z_{W_1 W_2}^{\frac{1}{2}} \\ Z_{W_2 W_1}^{\frac{1}{2}} & Z_{W_2 W_2}^{\frac{1}{2}} \end{pmatrix} \begin{pmatrix} W_{1\mu}^{\pm} \\ W_{2\mu}^{\pm} \end{pmatrix} \quad (107)$$

$$\begin{pmatrix} \circ^{\pm} \\ c_1^{\pm} \\ \circ^{\pm} \\ c_2^{\pm} \end{pmatrix} = \begin{pmatrix} \tilde{Z}_{W_1 W_1}^{\frac{1}{2}} & \tilde{Z}_{W_1 W_2}^{\frac{1}{2}} \\ \tilde{Z}_{W_2 W_1}^{\frac{1}{2}} & \tilde{Z}_{W_2 W_2}^{\frac{1}{2}} \end{pmatrix} \begin{pmatrix} c_1^{\pm} \\ c_2^{\pm} \end{pmatrix} \quad (108)$$

$$\overset{\circ}{c}_{1,2}^{\pm} = \bar{c}_{1,2}^{\pm} \quad (109)$$

$$\begin{aligned} \overset{\circ}{M}_{W_i}^2 &= M_{W_i}^2 + \delta M_{W_i}^2 \equiv G_{W_i}^2 M_{W_i}^2 & i = 1, 2 & \quad (127) \\ \overset{\circ}{M}_{Z_i}^2 &= M_{Z_i}^2 + \delta M_{Z_i}^2 \equiv G_{Z_i}^2 M_{Z_i}^2 & i = 1, 2 & \quad (128) \\ \overset{\circ}{M}_{G_i^0}^2 &= M_{G_i^0}^2 + \delta M_{G_i^0}^2 \equiv G_{G_i^0}^2 M_{G_i^0}^2 & i = 1, 2 & \quad (129) \\ \overset{\circ}{M}_i^2 &= M_i^2 + \delta M_i^2 \equiv G_i^2 M_i^2 & i = H^0, H_1^0, H_2^0, H_3^0, A_1^0, A_2^0 & \quad (130) \\ \overset{\circ}{M}_{G_i^\pm}^2 &= M_{G_i^\pm}^2 + \delta M_{G_i^\pm}^2 \equiv G_{G_i^\pm}^2 M_{G_i^\pm}^2 & i = 1, 2 & \quad (131) \\ \overset{\circ}{M}_{H_i^\pm}^2 &= M_{H_i^\pm}^2 + \delta M_{H_i^\pm}^2 \equiv G_{H_i^\pm}^2 M_{H_i^\pm}^2 & i = 1, 2 & \quad (132) \\ \overset{\circ}{M}_{\delta_L^{\pm\pm}}^2 &= M_{\delta_L^{\pm\pm}}^2 + \delta M_{\delta_L^{\pm\pm}}^2 \equiv G_{\delta_L}^2 M_{\delta_L}^2 & & \quad (133) \\ \overset{\circ}{M}_{\delta_R^{\pm\pm}}^2 &= M_{\delta_R^{\pm\pm}}^2 + \delta M_{\delta_R^{\pm\pm}}^2 \equiv G_{\delta_R}^2 M_{\delta_R}^2 & & \quad (134) \\ \overset{\circ}{m}_f^2 &= m_f^2 + \delta m_f^2 \equiv G_f^2 m_f^2 & f = \text{leptons, quarks.} & \quad (135) \end{aligned}$$

## B Renormalization conditions and counter terms

### 1. Gauge-bosons.

In all the following pictures in this section the diagram

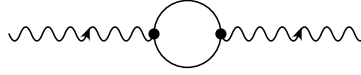

represents n-loop self-energy contribution, whereas



is an appropriate counter term. ‘ $k$ ’ stands for the particle momentum.

$$\begin{array}{c} W_{1\mu}^+ \\ \text{wavy line} \end{array} \text{---} \text{---} \text{---} \text{---} \text{---} \text{---} \text{---} \text{---} \text{---} \text{---} \begin{array}{c} W_{2\nu}^+ \\ \text{wavy line} \end{array} = \left( g_{\mu\nu} - \frac{k_\mu k_\nu}{k^2} \right) A^{W_1 W_2}(k^2) + \frac{k_\mu k_\nu}{k^2} B^{W_1 W_2}(k^2),$$

$$\begin{array}{c} W_{1\mu}^+ \\ \text{wavy line} \end{array} \text{---} \text{---} \text{---} \text{---} \text{---} \text{---} \text{---} \text{---} \text{---} \begin{array}{c} W_{2\nu}^+ \\ \text{wavy line} \end{array} =$$

$$\left( g_{\mu\nu} - \frac{k_\mu k_\nu}{k^2} \right) \left[ (M_{\tilde{W}_1}^2 + \delta M_{\tilde{W}_1}^2) Z_{\tilde{W}_1 W_1}^{\frac{1}{2}} Z_{\tilde{W}_1 W_2}^{\frac{1}{2}} + \right.$$

$$\left. (M_{\tilde{W}_2}^2 + \delta M_{\tilde{W}_2}^2) Z_{\tilde{W}_2 W_2}^{\frac{1}{2}} Z_{\tilde{W}_2 W_1}^{\frac{1}{2}} - k^2 \left( Z_{\tilde{W}_1 W_1}^{\frac{1}{2}} Z_{\tilde{W}_1 W_2}^{\frac{1}{2}} + Z_{\tilde{W}_2 W_2}^{\frac{1}{2}} Z_{\tilde{W}_2 W_1}^{\frac{1}{2}} \right) \right] +$$

$$\frac{k_\mu k_\nu}{k^2} \left[ (M_{\tilde{W}_1}^2 + \delta M_{\tilde{W}_1}^2) Z_{\tilde{W}_1 W_1}^{\frac{1}{2}} Z_{\tilde{W}_1 W_2}^{\frac{1}{2}} + (M_{\tilde{W}_2}^2 + \delta M_{\tilde{W}_2}^2) Z_{\tilde{W}_2 W_2}^{\frac{1}{2}} Z_{\tilde{W}_2 W_1}^{\frac{1}{2}} \right].$$

These equations allow us to calculate six renormalization constants (prime prefix in the renormalization conditions below means differentiation over  $k^2$ ).

Renormalization conditions	Renormalization constants
$\left. \begin{array}{l} A^{W_1}(M_{\tilde{W}_1}^2) = 0 \\ A^{W_1'}(M_{\tilde{W}_1}^2) = 0 \\ A^{W_2}(M_{\tilde{W}_2}^2) = 0 \\ A^{W_2'}(M_{\tilde{W}_2}^2) = 0 \\ A^{W_1 W_2}(M_{\tilde{W}_1}^2) = 0 \\ A^{W_1 W_2}(M_{\tilde{W}_2}^2) = 0 \end{array} \right\} \Rightarrow$	$Z_{\tilde{W}_1 W_1}^{\frac{1}{2}}, Z_{\tilde{W}_2 W_2}^{\frac{1}{2}}, \delta M_{\tilde{W}_1}^2 \\ Z_{\tilde{W}_1 W_2}^{\frac{1}{2}}, Z_{\tilde{W}_2 W_1}^{\frac{1}{2}}, \delta M_{\tilde{W}_2}^2.$

(136)

$$\begin{array}{c} Z_{1\mu} \\ \text{wavy line} \end{array} \text{---} \text{---} \text{---} \text{---} \text{---} \text{---} \text{---} \text{---} \text{---} \begin{array}{c} Z_{1\nu} \\ \text{wavy line} \end{array} = \left( g_{\mu\nu} - \frac{k_\mu k_\nu}{k^2} \right) A^{Z_1}(k^2) + \frac{k_\mu k_\nu}{k^2} B^{Z_1}(k^2),$$

$$\begin{array}{c} Z_{1\mu} \\ \text{wavy line} \end{array} \text{---} \text{---} \text{---} \text{---} \text{---} \text{---} \text{---} \text{---} \text{---} \begin{array}{c} Z_{1\nu} \\ \text{wavy line} \end{array} =$$

$$\left( g_{\mu\nu} - \frac{k_\mu k_\nu}{k^2} \right) \left[ (M_{\tilde{Z}_1}^2 + \delta M_{\tilde{Z}_1}^2) \left( Z_{\tilde{Z}_1 Z_1}^{\frac{1}{2}} \right)^2 + \right.$$

$$\left. (M_{\tilde{Z}_2}^2 + \delta M_{\tilde{Z}_2}^2) \left( Z_{\tilde{Z}_2 Z_1}^{\frac{1}{2}} \right)^2 - k^2 \left( \left( Z_{\tilde{Z}_1 Z_1}^{\frac{1}{2}} \right)^2 + \left( Z_{\tilde{Z}_2 Z_1}^{\frac{1}{2}} \right)^2 + \left( Z_{A Z_1}^{\frac{1}{2}} \right)^2 \right) \right] +$$

$$\frac{k_\mu k_\nu}{k^2} \left[ (M_{\tilde{Z}_1}^2 + \delta M_{\tilde{Z}_1}^2) \left( Z_{\tilde{Z}_1 Z_1}^{\frac{1}{2}} \right)^2 + (M_{\tilde{Z}_2}^2 + \delta M_{\tilde{Z}_2}^2) \left( Z_{\tilde{Z}_2 Z_1}^{\frac{1}{2}} \right)^2 \right].$$

$$\begin{array}{c} Z_{1\mu} \\ \text{wavy line} \end{array} \begin{array}{c} \text{circle} \\ \text{wavy line} \end{array} \begin{array}{c} A_\nu \\ \text{wavy line} \end{array} = \left( g_{\mu\nu} - \frac{k_\mu k_\nu}{k^2} \right) A^{Z_1 A}(k^2) + \frac{k_\mu k_\nu}{k^2} B^{Z_1 A}(k^2),$$

$$\begin{array}{c} Z_{1\mu} \\ \text{wavy line} \end{array} \begin{array}{c} \text{crossed circle} \\ \text{wavy line} \end{array} \begin{array}{c} A_\nu \\ \text{wavy line} \end{array} = \\ \left( g_{\mu\nu} - \frac{k_\mu k_\nu}{k^2} \right) \left[ (M_{Z_1}^2 + \delta M_{Z_1}^2) Z_{Z_1 Z_1}^{\frac{1}{2}} Z_{Z_1 A}^{\frac{1}{2}} + \right. \\ \left. (M_{Z_2}^2 + \delta M_{Z_2}^2) Z_{Z_2 Z_1}^{\frac{1}{2}} Z_{Z_2 A}^{\frac{1}{2}} - k^2 \left( Z_{Z_1 Z_1}^{\frac{1}{2}} Z_{Z_1 A}^{\frac{1}{2}} + Z_{Z_2 Z_1}^{\frac{1}{2}} Z_{Z_2 A}^{\frac{1}{2}} + Z_{AZ_1}^{\frac{1}{2}} Z_{AA}^{\frac{1}{2}} \right) \right] + \\ \frac{k_\mu k_\nu}{k^2} \left[ (M_{Z_1}^2 + \delta M_{Z_1}^2) Z_{Z_1 Z_1}^{\frac{1}{2}} Z_{Z_1 A}^{\frac{1}{2}} + (M_{Z_2}^2 + \delta M_{Z_2}^2) Z_{Z_2 Z_1}^{\frac{1}{2}} Z_{Z_2 A}^{\frac{1}{2}} \right].$$

$$\begin{array}{c} Z_{2\mu} \\ \text{wavy line} \end{array} \begin{array}{c} \text{circle} \\ \text{wavy line} \end{array} \begin{array}{c} A_\nu \\ \text{wavy line} \end{array} = \left( g_{\mu\nu} - \frac{k_\mu k_\nu}{k^2} \right) A^{Z_2 A}(k^2) + \frac{k_\mu k_\nu}{k^2} B^{Z_2 A}(k^2),$$

$$\begin{array}{c} Z_{2\mu} \\ \text{wavy line} \end{array} \begin{array}{c} \text{crossed circle} \\ \text{wavy line} \end{array} \begin{array}{c} A_\nu \\ \text{wavy line} \end{array} = \\ \left( g_{\mu\nu} - \frac{k_\mu k_\nu}{k^2} \right) \left[ (M_{Z_2}^2 + \delta M_{Z_2}^2) Z_{Z_2 Z_2}^{\frac{1}{2}} Z_{Z_2 A}^{\frac{1}{2}} + \right. \\ \left. (M_{Z_1}^2 + \delta M_{Z_1}^2) Z_{Z_1 Z_2}^{\frac{1}{2}} Z_{Z_1 A}^{\frac{1}{2}} - k^2 \left( Z_{Z_2 Z_2}^{\frac{1}{2}} Z_{Z_2 A}^{\frac{1}{2}} + Z_{Z_1 Z_2}^{\frac{1}{2}} Z_{Z_1 A}^{\frac{1}{2}} + Z_{AZ_2}^{\frac{1}{2}} Z_{AA}^{\frac{1}{2}} \right) \right] + \\ \frac{k_\mu k_\nu}{k^2} \left[ (M_{Z_2}^2 + \delta M_{Z_2}^2) Z_{Z_2 Z_2}^{\frac{1}{2}} Z_{Z_2 A}^{\frac{1}{2}} + (M_{Z_1}^2 + \delta M_{Z_1}^2) Z_{Z_1 Z_2}^{\frac{1}{2}} Z_{Z_1 A}^{\frac{1}{2}} \right].$$

Renormalization conditions

Renormalization constants

$$\left. \begin{array}{l} A^{Z_1}(M_{Z_1}^2) = 0, \quad A^{Z_1'}(M_{Z_1}^2) = 0, \\ A^{Z_2}(M_{Z_2}^2) = 0, \quad A^{Z_2'}(M_{Z_2}^2) = 0, \\ A^{Z_1 A}(M_{Z_1}^2) = 0, \quad A^{Z_1 A}(0) = 0, \\ A^{Z_2 A}(M_{Z_2}^2) = 0, \quad A^{Z_2 A}(0) = 0, \\ A^{Z_1 Z_2}(M_{Z_1}^2) = 0, \quad A^{Z_1 Z_2}(M_{Z_2}^2) = 0 \\ A^{A'}(0) = 0, \end{array} \right\} \Rightarrow \begin{array}{l} Z_{Z_1 Z_1}^{\frac{1}{2}}, Z_{Z_1 A}^{\frac{1}{2}}, Z_{Z_2 A}^{\frac{1}{2}}, Z_{AZ_1}^{\frac{1}{2}}, Z_{AZ_2}^{\frac{1}{2}}, Z_{AA}^{\frac{1}{2}}, \\ \delta M_{Z_1}^2, \delta M_{Z_2}^2, Z_{Z_1 Z_2}^{\frac{1}{2}}, Z_{Z_2 Z_1}^{\frac{1}{2}}, Z_{Z_2 Z_2}^{\frac{1}{2}}. \end{array} \quad (137)$$

$$\begin{array}{c} \text{H}_i^+ \\ \dashrightarrow \end{array} \begin{array}{c} \bullet \\ \circ \\ \bullet \end{array} \begin{array}{c} \text{H}_i^+ \\ \dashrightarrow \end{array} = F_{H_i H_i}(k^2), \quad i = 1, 2$$

$$\begin{array}{c} \text{H}_i^+ \\ \dashrightarrow \end{array} \begin{array}{c} \times \\ \dashrightarrow \end{array} \begin{array}{c} \text{H}_i^+ \\ \dashrightarrow \end{array} =$$

$$- (M_{H_i}^2 + \delta M_{H_i}^2) \left( Z_{H_i H_i}^{\frac{1}{2}} \right)^2 + k^2 \left( Z_{H_i H_i}^{\frac{1}{2}} \right)^2$$

$$- \left( M_{H_j}^2 + \delta M_{H_j}^2 \right) \left( Z_{H_j H_i}^{\frac{1}{2}} \right)^2 + k^2 \left( Z_{H_j H_i}^{\frac{1}{2}} \right)^2.$$

$$\begin{array}{c} \text{H}_i^+ \\ \dashrightarrow \end{array} \begin{array}{c} \bullet \\ \circ \\ \bullet \end{array} \begin{array}{c} \text{H}_j^+ \\ \dashrightarrow \end{array} = F_{H_i H_j}(k^2), \quad i, j = 1, 2, ; \quad i \neq j$$

$$\begin{array}{c} \text{H}_i^+ \\ \dashrightarrow \end{array} \begin{array}{c} \times \\ \dashrightarrow \end{array} \begin{array}{c} \text{H}_j^+ \\ \dashrightarrow \end{array} =$$

$$- (M_{H_i}^2 + \delta M_{H_i}^2) \left( Z_{H_i H_i}^{\frac{1}{2}} \right) \left( Z_{H_i H_j}^{\frac{1}{2}} \right) + k^2 \left( Z_{H_i H_i}^{\frac{1}{2}} \right) \left( Z_{H_i H_j}^{\frac{1}{2}} \right)$$

$$- \left( M_{H_j}^2 + \delta M_{H_j}^2 \right) \left( Z_{H_j H_j}^{\frac{1}{2}} \right) \left( Z_{H_j H_i}^{\frac{1}{2}} \right) + k^2 \left( Z_{H_j H_j}^{\frac{1}{2}} \right) \left( Z_{H_j H_i}^{\frac{1}{2}} \right).$$

In this case 6 renormalization constants is fixed.

Renormalization conditions      Renormalization constants

$$\left. \begin{array}{l} F_{H_i H_i}(M_{H_i}^2) = 0 \\ F'_{H_i H_i}(M_{H_i}^2) = 0 \\ F_{H_i H_j}(M_{H_i}^2) = 0 \\ F_{H_i H_j}(M_{H_j}^2) = 0 \end{array} \right\} \Rightarrow Z_{H_1 H_1}^{\frac{1}{2}}, Z_{H_2 H_2}^{\frac{1}{2}}, Z_{H_1 H_2}^{\frac{1}{2}}, Z_{H_2 H_1}^{\frac{1}{2}}, \delta M_{H_1}^2, \delta M_{H_2}^2 \quad (139)$$

Finally, 6 renormalization constants connected with doubly charged Higgses can be found.

$$\begin{array}{c} \text{i} \\ \longrightarrow \\ \text{---} \circ \text{---} \text{j} \end{array} = K_1^{ij}(k^2)1 + K_5^{ij}(k^2)\gamma^5 + K_\gamma^{ij}(k^2)\widehat{k} + K_5^{ij}\gamma(k^2)\widehat{k}\gamma^5,$$

$$\begin{array}{c} \text{i} \\ \longrightarrow \\ \text{---} \times \text{---} \text{j} \end{array} =$$

$$\begin{aligned} & \sum_a \left\{ 1 \left[ -\frac{1}{2}(Z_L^{\frac{1}{2}})^\dagger_{ia}(m_a + \delta m_a)(Z_R^{\frac{1}{2}})_{aj} - \right. \right. \\ & \left. \frac{1}{2}(Z_R^{\frac{1}{2}})^\dagger_{ia}(m_a + \delta m_a)(Z_L^{\frac{1}{2}})_{aj} \right] + \gamma^5 \left[ -\frac{1}{2}(Z_L^{\frac{1}{2}})^\dagger_{ia}(m_a + \delta m_a)(Z_R^{\frac{1}{2}})_{aj} + \right. \\ & \left. \frac{1}{2}(Z_R^{\frac{1}{2}})^\dagger_{ia}(m_a + \delta m_a)(Z_L^{\frac{1}{2}})_{aj} \right] + \widehat{k} \left[ \frac{1}{2}(Z_L^{\frac{1}{2}})^\dagger_{ia}(Z_L^{\frac{1}{2}})_{aj} + \frac{1}{2}(Z_R^{\frac{1}{2}})^\dagger_{ia}(Z_R^{\frac{1}{2}})_{aj} \right] + \\ & \left. \widehat{k}\gamma^5 \left[ -\frac{1}{2}(Z_L^{\frac{1}{2}})^\dagger_{ia}(Z_L^{\frac{1}{2}})_{aj} + \frac{1}{2}(Z_R^{\frac{1}{2}})^\dagger_{ia}(Z_R^{\frac{1}{2}})_{aj} \right] \right\}. \end{aligned}$$

Taking renormalization conditions

$i = j$  :

$$\begin{cases} K_1^{ii}(m_i^2) + m_i K_\gamma^{ii}(m_i^2) = 0 \\ K_5^{ii}(m_i^2) = 0 \\ K_{5\gamma}^{ii}(m_i^2) = 0 \\ \left[ \frac{\partial}{\partial k}(K_1^{ii}(k^2) + \widehat{k}K_\gamma^{ii}(k^2)) \right]_{\widehat{k}=m_i} = 0 \end{cases} \quad (141)$$

$i > j$  :

$$\begin{cases} K_1^{ij}(m_j^2) + m_j K_\gamma^{ij}(m_j^2) = 0 \\ K_5^{ij}(m_j^2) - m_j K_{5\gamma}^{ij}(m_j^2) = 0 \\ K_1^{ij}(m_i^2) + m_i K_\gamma^{ij}(m_i^2) = 0 \\ K_5^{ij}(m_i^2) + m_i K_{5\gamma}^{ij}(m_i^2) = 0 \end{cases} \quad (142)$$

78 renormalization constants can be found.

## VI RENORMALIZATION OF THE REMAINING PARAMETERS

### A Denitions of the renormalization constants

There are more free parameters in the Left-Right Symmetric Model than in the S.M.  $(\cos \varphi, \sin \xi, \Omega_{L,R}, K_{L,R})$ . Thus more renormalization condition must be introduced. We define the renormalization constants for remainig parameters as follow

where

$$(\delta Z_{L,R})_{ee} = (\delta Z_{L,R}^{\frac{1}{2}})_{ee} + (\delta Z_{L,R}^{\frac{1}{2}})_{ee}^\dagger \quad (153)$$

2. The renormalization constant  $\delta G_\xi$ .

One can determine the  $\delta G_\xi$  constant from the  $W_1\nu_i e$  vertex for example;

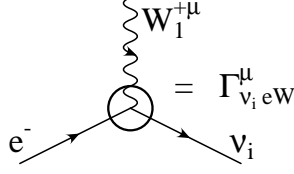

Renormalization condition

Renormalization constant

$$\bar{u}(m_e)\Gamma_{\nu_i e W_1}^\mu u(m_e) |_{k^\mu = M_{W_1}} = 0 \quad \Rightarrow \quad \delta G_\xi. \quad (154)$$

where

$$\Gamma_{\nu_i e W_1}^\mu = i e \gamma^\mu \left( \Gamma_{CT}^{\nu_i e W_1} + \Gamma_D^{\nu_i e W_1} \right) \quad (155)$$

and

$$\begin{aligned} \Gamma_{CT}^{\nu_i e W_1} = & \frac{\cos \xi}{\sqrt{2} \sin \Theta} \left\{ \left[ \delta Y + \delta Z_{W_1 W_1}^{\frac{1}{2}} - \delta G_\Theta - \delta G_\xi \frac{\sin^2 \xi}{\cos^2 \xi} \right] (K_L)_{Ie} + \frac{1}{2} \sum_A \left( (\delta Z_L^{\frac{1}{2}})_{IA} + (\delta Z_L^{\frac{1}{2}})_{IA}^\dagger \right) (K_L)_{Ae} \right. \\ & + \frac{1}{2} \sum_b \left( (\delta Z_L^{\frac{1}{2}})_{be} + (\delta Z_L^{\frac{1}{2}})_{be}^\dagger \right) (K_L)_{Ib} + Z_{W_2 W_1}^{\frac{1}{2}} \frac{\sin \xi}{\sqrt{2} \sin \Theta} (K_L)_{Ie} \left. \right\} P_L \\ & - \frac{\sin \xi}{\sqrt{2} \sin \Theta} \left\{ \left[ \delta Y + \delta Z_{W_1 W_1}^{\frac{1}{2}} - \delta G_\Theta + \delta G_\xi \right] (K_R)_{Ie} + \frac{1}{2} \sum_A \left( (\delta Z_R^{\frac{1}{2}})_{IA} + (\delta Z_R^{\frac{1}{2}})_{IA}^\dagger \right) (K_R)_{Ae} \right. \\ & + \frac{1}{2} \sum_b \left( (\delta Z_R^{\frac{1}{2}})_{be} + (\delta Z_R^{\frac{1}{2}})_{be}^\dagger \right) (K_R)_{Ib} + Z_{W_2 W_1}^{\frac{1}{2}} \frac{\cos \xi}{\sqrt{2} \sin \Theta} (K_R)_{Ie} \left. \right\} P_R \end{aligned} \quad (156)$$

3. The renormalization constants  $\delta G_\varphi, \delta G_\Theta$ .

To determine the  $\delta G_\varphi$  and  $\delta G_\Theta$  renormalization constants we exploit an additional vertex -  $Z_1 e^- e^-$ ;

Let us first consider the left handed part of the unrenormalized charged current interactions (for the right handed part all formulas are analogous) in the form

$$\left( L_{CC} \right)_{left} \overset{\circ}{\propto} \bar{N} \gamma^\mu P_L \overset{\circ}{K} l \quad (161)$$

which in the renormalized quantities reads

$$\begin{aligned} \bar{N}_L Z_L^{\frac{1}{2}\dagger} \gamma^\mu (K_L + \delta K_L) Z_L^{\frac{1}{2}} l_L &= \bar{N}_L \left( 1 + \frac{1}{2} \delta Z_L^\dagger \right) \gamma^\mu (K_L + \delta K_L) \left( 1 + \frac{1}{2} \delta Z_L^l \right) l_L \\ &= (J_L^\mu)_{CC} + (\delta J_L^\mu)_{CC} \end{aligned} \quad (162)$$

where

$$\begin{aligned} (\delta J_L^\mu)_{CC} &= \bar{N}_L \gamma^\mu \left( \frac{1}{2} \delta Z_L^\dagger K_L + \delta K_L + \frac{1}{2} K_L \delta Z_L^l \right) l_L \\ &= \bar{N}_L \gamma^\mu \left( \frac{1}{2} \delta Z_L^\dagger K_L + \delta K_L + \frac{1}{2} K_L \delta Z_L^l \right) l_L + \bar{N}_L \gamma^\mu \left( \frac{1}{4} \delta Z_L K_L - \frac{1}{4} \delta Z_L K_L \right) l_L \\ &\quad + \bar{N}_L \gamma^\mu \left( \frac{1}{4} K_L \delta Z_L^{\dagger\dagger} - \frac{1}{4} K_L \delta Z_L^{\dagger\dagger} \right) l_L. \end{aligned} \quad (163)$$

Using the formulas

$$K_L = U_L^\dagger U_L^l \quad (164)$$

$$U_L U_L^\dagger = I \quad (165)$$

$$U_L^l U_L^{\dagger l} = U_L^{\dagger l} U_L^l = I, \quad (166)$$

which are satisfied for the bar and renormalized quantities, for the one loop level we have

$$\begin{aligned} \overset{\circ}{U}_L^\dagger \overset{\circ}{U}_L^l &= \left( U_L^\dagger + \delta U_L^\dagger \right) \left( U_L^l + \delta U_L^l \right) = K_L + U_L^\dagger \delta U_L^l + \delta U_L^\dagger U_L^l = K_L + \delta U_L^\dagger U_L K_L + K_L U_L^{\dagger l} \delta U_L^l \\ &= K_L + \delta K_L \end{aligned} \quad (167)$$

and thus

$$\begin{aligned} (\delta J_L^\mu)_{CC} &= \bar{N}_L \gamma^\mu \left\{ \frac{1}{4} \left( \delta Z_L^\dagger + \delta Z_L \right) K_L + \frac{1}{4} K_L \left( \delta Z_L^l + \delta Z_L^{\dagger l} \right) \right\} l_L \\ &\quad + \bar{N}_L \gamma^\mu \left[ \frac{1}{4} \left( \delta Z_L^\dagger - \delta Z_L \right) + \delta U_L^\dagger U_L \right] K_L l_L + \bar{N}_L \gamma^\mu K_L \left[ \frac{1}{4} \left( \delta Z_L^l - \delta Z_L^{\dagger l} \right) + U_L^{\dagger l} \delta U_L^l \right] l_L. \end{aligned} \quad (168)$$

Requiring that the antihermitean part vanish (i.e. the terms in square brackets) we may fix  $\delta U_L^\dagger$  and  $\delta U_L$

$$\delta U_L^\dagger = -\frac{1}{4} \left( \delta Z_L^\dagger - \delta Z_L \right) U_L^\dagger \quad (169)$$

$$\delta U_L = -\frac{1}{4} U_L \left( \delta Z_L - \delta Z_L^\dagger \right). \quad (170)$$



# Renormalization of the $Z_1\nu_i\nu_j$ vertex.

## VII THE GENERAL SCHEME

Having definitions of renormalization constants we can go to the main part of our work i.e. to the renormalization of the  $Z_1\nu_i\nu_j$  vertex;

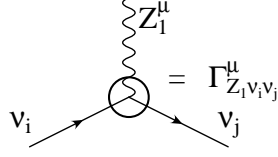

We can decompose the full  $Z_1\nu_i\nu_j$  vertex in the two components, to the counter term part and to the contributions from the diagrams

$$\Gamma_{Z_1\nu_i\nu_j}^\mu = ie\gamma^\mu \left( \Gamma_{CT}^{Z_1\nu_i\nu_j} + \Gamma_D^{Z_1\nu_i\nu_j} \right) \quad (179)$$

where

$$\Gamma_{CT}^{Z_1\nu_i\nu_j} \equiv (P_L(CT)_L + P_R(CT)_R). \quad (180)$$

The following bar Lagrangian contributes to the  $Z_1\nu_i\nu_j$  vertex

$$\begin{aligned} \mathring{L}_{Z_1\nu_i\nu_j} = \frac{i\mathring{e}}{2\sin\Theta\mathring{\cos}\Theta} \sum_{a,b} \left\{ \mathring{N}_a \gamma^\mu P_L \left( \mathring{A}_L^{1\nu} (\mathring{\Omega}_L)_{ab} - \mathring{A}_R^{1\nu} (\mathring{\Omega}_R)_{ba} \right) \mathring{N}_b \mathring{Z}_{1\mu} + \right. \\ \mathring{N}_a \gamma^\mu P_R \left( \mathring{A}_R^{1\nu} (\mathring{\Omega}_R)_{ab} - \mathring{A}_L^{1\nu} (\mathring{\Omega}_L)_{ba} \right) \mathring{N}_b \mathring{Z}_{1\mu} + \\ \mathring{N}_a \gamma^\mu P_L \left( \mathring{A}_L^{2\nu} (\mathring{\Omega}_L)_{ab} - \mathring{A}_R^{2\nu} (\mathring{\Omega}_R)_{ba} \right) \mathring{N}_b \mathring{Z}_{2\mu} + \\ \left. \mathring{N}_a \gamma^\mu P_R \left( \mathring{A}_R^{2\nu} (\mathring{\Omega}_R)_{ab} - \mathring{A}_L^{2\nu} (\mathring{\Omega}_L)_{ba} \right) \mathring{N}_b \mathring{Z}_{2\mu} \right\} \quad (181) \end{aligned}$$

where

$$\mathring{A}_L^{1\nu} = \mathring{\cos}\phi - \sqrt{1 - \mathring{\cos}^2\phi} \frac{\mathring{\sin}^2\Theta}{\sqrt{1 - 2\mathring{\sin}^2\Theta}} \quad (182)$$

$$\mathring{A}_R^{1\nu} = -\sqrt{1 - \mathring{\cos}^2\phi} \frac{1 - \mathring{\sin}^2\Theta}{\sqrt{1 - 2\mathring{\sin}^2\Theta}} \quad (183)$$

$$\mathring{A}_L^{2\nu} = \sqrt{1 - \mathring{\cos}^2\phi} + \mathring{\cos}\phi \frac{\mathring{\sin}^2\Theta}{\sqrt{1 - 2\mathring{\sin}^2\Theta}} \quad (184)$$

Analyzing the previous paragraphs it is easy to realize that expressions needed for the renormalizing  $Z_1\nu_i\nu_j$  vertex in the Left-Right Symmetric Model are much more complex than ones for the Standard Model. To have a good test if the method really works we have decided to check the cancellation of the infinity part in the  $Z_1\nu_i\nu_j$  vertex. In fact it was the most important task to do. If our calculations failed all work would be useless. We have made numerical calculations using the "Mathematica" program, proving that all infinities in the  $Z_1\nu_i\nu_j$  vertex really cancell. Since the full formulas (i.e. the finity and infinity part) for renormalization constants take too much room we don't write them explicitly in the article ( we plan to put all of them on the server). Here we show only the diagrams which contributes to the propagators and to the vertices used for the renormalization of the  $Z_1\nu_i\nu_j$  vertex;

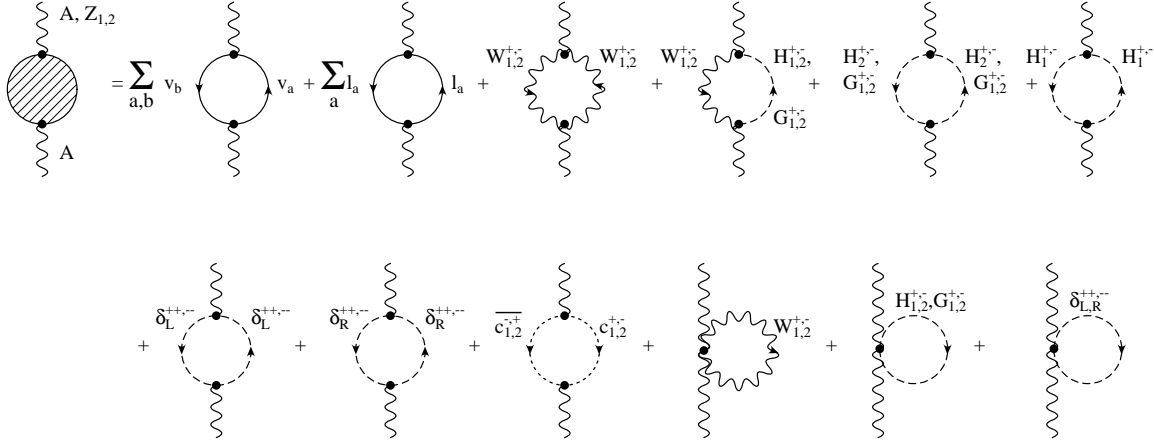

Fig.1

The  $A - A, Z_{1,2}$  bosons one loop self-energy diagrams. The summation is over the neutrino ( $\nu_a, \nu_b$ ) and the charged lepton flavors ( $l_a$ ).

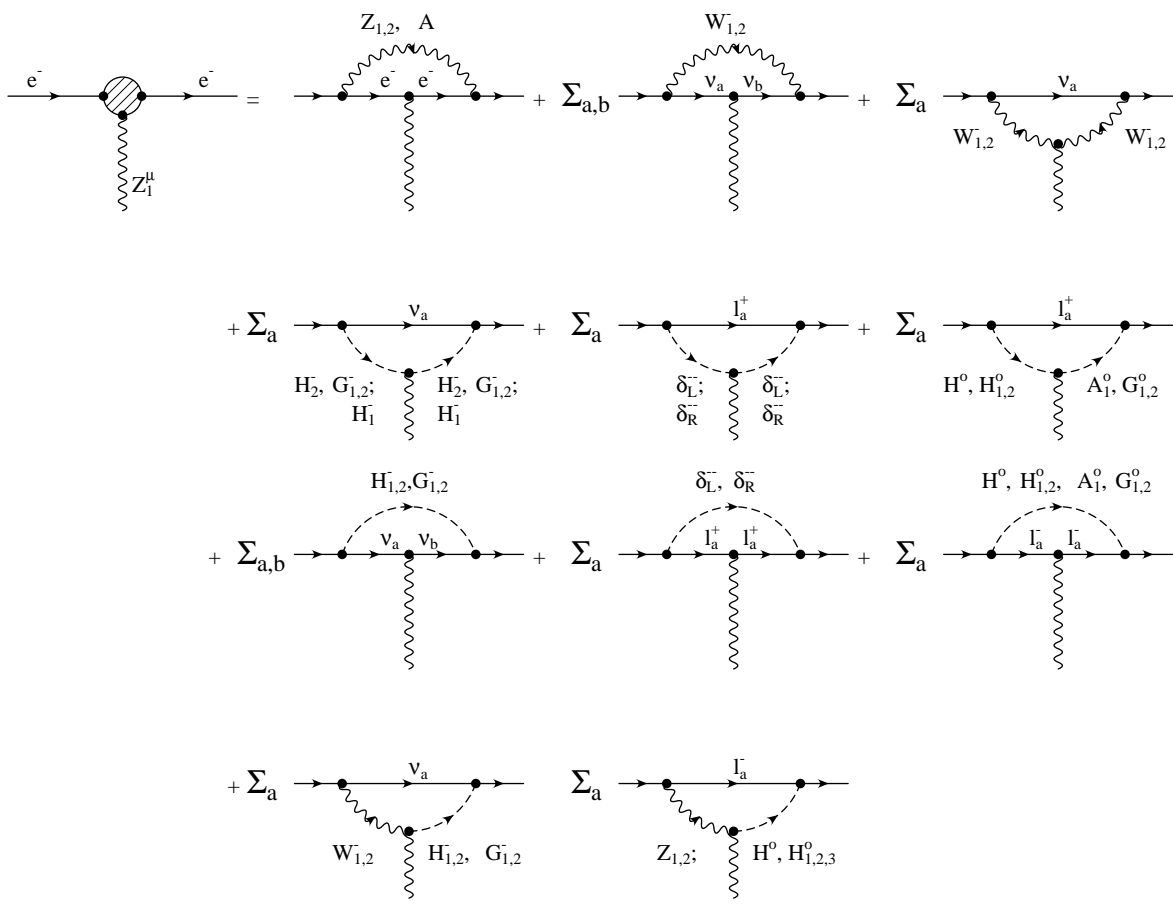

Fig.4

The one-loop diagrams for the  $Z_1 ee$  vertex.



# Renormalization of the left-right symmetric model\*

P. Duka, J.Gluza and M.Zrałek  
Department of Field Theory and Particle Physics  
Institute of Physics, University of Silesia  
Uniwersytecka 4, PL-40-007 Katowice, Poland

September 30, 1996

PACS number(s): 13.15.-f, 12.15.Cc,14.60.Gh

**Abstract**

s

---

\*This work was supported by Polish Committee for Scientific Researches under Grants Nos. 2252/2/91 and 2P30225206/93

with appropriate gauge boson transformations

$$\begin{aligned} \left(\frac{\vec{\tau}}{2}\vec{W}_{L,R}\right)'_{\mu} &= e^{-ig_{L,R}\frac{\vec{\tau}}{2}\vec{\Theta}(x)}\left(\frac{\vec{\tau}}{2}\vec{W}_{L,R}\right)_{\mu}e^{ig_{L,R}\frac{\vec{\tau}}{2}\vec{\Theta}(x)} \\ &\quad - \frac{1}{ig_{L,R}}e^{-ig_{L,R}\frac{\vec{\tau}}{2}\vec{\Theta}(x)}\partial_{\mu}\left(e^{ig_{L,R}\frac{\vec{\tau}}{2}\vec{\Theta}(x)}\right) \end{aligned} \quad (1.1.8)$$

$$B'_{\mu} = B_{\mu} - \frac{1}{ig}e^{-ig'Y\vec{\Theta}(x)}\partial_{\mu}\left(e^{ig'Y\vec{\Theta}(x)}\right). \quad (1.1.9)$$

Gauge transformations defined in Eqs.(1.1.4)-(1.1.9) allow in consistence way to build up two kinds of invariant interactions. The first one gives fermion-gauge interaction

$$L_f = \sum_{\Psi=Q,L}\bar{\Psi}_L\gamma^{\mu}\left(i\partial_{\mu} - g\frac{\vec{\tau}}{2}\vec{W}_{L\mu} - ig'\frac{Y}{2}B_{\mu}\right)\Psi_L + (L \rightarrow R). \quad (1.1.10)$$

The second one gives gauge-gauge interactions

$$L_g = -\frac{1}{4}W_{Li}^{\mu\nu}W_{Li\mu\nu} - \frac{1}{4}W_{Ri}^{\mu\nu}W_{Ri\mu\nu} - \frac{1}{4}B^{\mu\nu}B_{\mu\nu} \quad (1.1.11)$$

where

$$\begin{aligned} W_{1L,R}^{\mu\nu} &= \partial^{\mu}W_{1L,R}^{\nu} - \partial^{\nu}W_{1L,R}^{\mu} + g(W_{2L,R}^{\mu}W_{3L,R}^{\nu} - W_{3L,R}^{\mu}W_{2L,R}^{\nu}) \\ W_{2L,R}^{\mu\nu} &= \partial^{\mu}W_{2L,R}^{\nu} - \partial^{\nu}W_{2L,R}^{\mu} + g(W_{3L,R}^{\mu}W_{1L,R}^{\nu} - W_{1L,R}^{\mu}W_{3L,R}^{\nu}) \\ W_{3L,R}^{\mu\nu} &= \partial^{\mu}W_{3L,R}^{\nu} - \partial^{\nu}W_{3L,R}^{\mu} + g(W_{1L,R}^{\mu}W_{2L,R}^{\nu} - W_{2L,R}^{\mu}W_{1L,R}^{\nu}) \\ B^{\mu\nu} &= \partial^{\mu}B^{\nu} - \partial^{\nu}B^{\mu}. \end{aligned} \quad (1.1.12)$$

Gauge bosons  $W_{L,R}^{\mu}$ ,  $B^{\mu}$  are given in weak basis. Appropriate transformations to physical basis are given in Section 2. Until now fermion and gauge fields are massless - mass terms which could appear are not gauge invariant. To make them massive we introduce scalar fields - Higgs particles.

This Higgs sector (containing bidoublet  $\phi$  and triplets  $\Delta_{L,R}$ ) lead to appropriate gauge symmetry breaking by the chain

$$G = SU(2)_L \otimes SU(2)_R \otimes U(1)_{B-L} \xrightarrow{v_R} SU(2)_L \otimes U(1)_Y \xrightarrow{\kappa_1, \kappa_2, v_L} U(1)_{em}. \quad (1.2.8)$$

This will be shown in the next Section.

$\Delta_L \sim (3, 1, 2)$ ,  $\Delta_R \sim (1, 3, 2)$  and  $\phi \sim (\frac{1}{2}, \frac{1}{2}^*, 0)$  fields build the kinetic part of the Lagrangian

$$L = Tr [(D_\mu \Delta_L)^\dagger (D^\mu \Delta_L)] + Tr [(D_\mu \Delta_R)^\dagger (D^\mu \Delta_R)] + Tr [(D_\mu \phi)^\dagger (D^\mu \phi)]. \quad (1.2.9)$$

where

$$\begin{aligned} D_\mu \phi &= \partial_\mu \phi - ig_L W_{L\mu}^{\vec{\tau}} \frac{\vec{\tau}}{2} \phi + ig_R \phi \frac{\vec{\tau}}{2} W_{R\mu}^{\vec{\tau}}, \\ D_\mu \Delta_{L,R} &= \partial_\mu \Delta_{L,R} - ig_L \left[ \frac{\vec{\tau}}{2} W_{L\mu}^{\vec{\tau}}, \Delta_L \right] - ig_R \left[ \frac{\vec{\tau}}{2} W_{R\mu}^{\vec{\tau}}, \Delta_R \right] - ig' B_\mu \Delta_{L,R}. \end{aligned} \quad (1.2.10)$$

### 1.3 Higgs potential

Before spontaneous symmetry breaking the Lagrangian has the left-right symmetry specified by the transformation

$$\Psi_L \leftrightarrow \Psi_R, \quad \Delta_L \leftrightarrow \Delta_R \quad \text{and} \quad \phi \leftrightarrow \phi^\dagger \quad (1.3.1)$$

where  $\Psi_{L,R}$  are the column vectors containing the left-handed and right-handed leptons. We consider the most general Higgs potential ([?] and [?])

$$\begin{aligned} V = & - \mu_1^2 (Tr [\phi^\dagger \phi]) - \mu_2^2 (Tr [\tilde{\phi} \phi^\dagger] + Tr [\tilde{\phi}^\dagger \phi]) \\ & - \mu_3^2 (Tr [\Delta_L \Delta_L^\dagger] + Tr [\Delta_R \Delta_R^\dagger]) \end{aligned}$$

following inequalities can be obtained ( $\kappa_+ = \sqrt{\kappa_1^2 + \kappa_2^2}$ )

$$v_R \gg \kappa_+ \gg v_L. \quad (1.3.4)$$

## 2 Lagrangian in physical basis

### 2.1 Physical fields

#### Bosons

Masses of gauge bosons are obtained from the Lagrangian Eq.(1.1.10) (we assume that  $g_L = g_R$ )

The charged ( $W_L^{\mu\pm} = \frac{1}{\sqrt{2}}(W_{1L}^\mu \mp iW_{2L}^\mu)$ ,  $W_R^{\mu\pm} = \frac{1}{\sqrt{2}}(W_{1R}^\mu \mp iW_{2R}^\mu)$ ) and neutral ( $W_{3L}^\mu, W_{3R}^\mu, B^\mu$ ) gauge bosons mass matrices  $\tilde{M}_W^2, \tilde{M}_0^2$  are the following ( $v_L = 0$ )

$$\begin{aligned} \tilde{M}_W^2 &= \frac{g^2}{4} \begin{pmatrix} \kappa_+^2 & -4\kappa_1\kappa_2 \\ -4\kappa_1\kappa_2 & \kappa_+^2 + 2v_R^2 \end{pmatrix} \\ \tilde{M}_0^2 &= \begin{pmatrix} \frac{g^2}{2}\kappa_+^2 & -\frac{g^2}{2}\kappa_+^2 & 0 \\ -\frac{g^2}{2}\kappa_+^2 & \frac{g^2}{2}(\kappa_+^2 + 4v_R^2) & -4gg'v_R^2 \\ 0 & -4gg'v_R^2 & 4g'^2v_R^2 \end{pmatrix}. \end{aligned} \quad (2.1.1)$$

These mass matrices are diagonalized by the unitary transformation for charged gauge bosons

$$\begin{pmatrix} W_L^\pm \\ W_R^\pm \end{pmatrix} = \begin{pmatrix} \cos\xi & \sin\xi \\ -\sin\xi & \cos\xi \end{pmatrix} = \begin{pmatrix} W_{1L}^\pm \\ W_{2L}^\pm \end{pmatrix} \quad (2.1.2)$$

and by orthogonal transformation in neutral sector

$$\begin{aligned} \begin{pmatrix} W_{3L} \\ W_{3R} \\ B \end{pmatrix} &= \begin{pmatrix} c_w c & c_w s & s_w \\ -s_w s_m c - c_m s & -s_w s_m s + c_m c & c_w s_m \\ -s_w c_m c + s_m s & -s_w c_m s - s_m c & +c_w c_m \end{pmatrix} \begin{pmatrix} Z_1 \\ Z_2 \\ A \end{pmatrix} \equiv \\ &\begin{pmatrix} x_1 & x_2 & x_3 \\ y_1 & y_2 & y_3 \\ v_1 & v_2 & v_3 \end{pmatrix} \begin{pmatrix} Z_1 \\ Z_2 \\ A \end{pmatrix} \end{aligned} \quad (2.1.3)$$



with

$$M_D = h\kappa_1 + \tilde{h}\kappa_2^*, \quad M_R = 2h_R v_R, \quad M_L = 2h_L^* v_L^* = 0.$$

Using a transformation

$$n_R = U \hat{n}_R \tag{2.1.9}$$

such that  $U^T M U = \hat{M}$  is diagonal, positive mass matrix we get

$$L_{Mass} = -\frac{1}{2} \hat{n}_L^c \hat{M} \hat{n}_R + h.c. \equiv -\frac{1}{2} \bar{N} \hat{M} N, \tag{2.1.10}$$

with

$$N = \hat{n}_R + \hat{n}_L^c \equiv \hat{n}_R + C \tilde{\hat{n}}_R^T. \tag{2.1.11}$$

By an appropriate decomposition of the matrix U

$$U = \begin{bmatrix} U_L^* \\ U_R \end{bmatrix}, \tag{2.1.12}$$

where both matrices  $U_L$  and  $U_R$  have the dimension  $(3 \times 6)$ , the weak eigenfields  $\nu_{L,R}$  can be expressed through the mass eigenstates

$$\begin{aligned} \nu_L &= U_L \hat{n}_L^c \equiv U_L (P_L N), \\ \nu_R &= U_R \hat{n}_R \equiv U_R (P_R N), \end{aligned} \tag{2.1.13}$$

where

$$P_{L,R} = \frac{1}{2}(1 \mp \gamma_5).$$

The mass matrix for the charged leptons is given by

$$M_l = h\kappa_1 + \tilde{h}\kappa_2^*, \tag{2.1.14}$$

and is diagonalized by the biunitary transformation

$$U_L^{l\dagger} M_l U_R^l = \hat{M}_l \tag{2.1.15}$$

where  $\hat{M}_l$  is a diagonal, positive  $3 \times 3$  matrix and unitary matrices  $U_{L,R}^l$  yield the physical lepton fields  $\hat{l} = \hat{l}_L + \hat{l}_R$ ,

$$l_{L,R} = U_{L,R}^l \hat{l}_{L,R}. \tag{2.1.16}$$

$$\delta_L^0 = \frac{1}{\sqrt{2}} (H_3^0 + iA_2^0), \quad (2.1.26)$$

$$\delta_R^0 = \frac{1}{\sqrt{2}} (c_0 H_0^0 + c_1 H_1^0 + c_2 H_2^0 + iG_2^0), \quad (2.1.27)$$

$$\begin{aligned} \phi_1^+ &= \frac{\kappa_1}{\kappa_+ \sqrt{1 + \left(\frac{\kappa_-^2}{\sqrt{2}\kappa_+ v_R}\right)^2}} H_2^+ - \frac{\kappa_1}{\kappa_+ \sqrt{1 + \left(\frac{\sqrt{2}\kappa_+ v_R}{\kappa_-^2}\right)^2}} G_R^+ - \frac{\kappa_2}{\kappa_+} G_L^+, \\ &\equiv a_{12} H_2^+ + a_{1R} G_R^+ + a_{1L} G_L^+ \end{aligned} \quad (2.1.28)$$

$$\begin{aligned} \phi_2^+ &= \frac{\kappa_2}{\kappa_+ \sqrt{1 + \left(\frac{\kappa_-^2}{\sqrt{2}\kappa_+ v_R}\right)^2}} H_2^+ - \frac{\kappa_2}{\kappa_+ \sqrt{1 + \left(\frac{\sqrt{2}\kappa_+ v_R}{\kappa_-^2}\right)^2}} G_R^+ + \frac{\kappa_1}{\kappa_+} G_L^+, \\ &\equiv a_{22} H_2^+ + a_{2R} G_R^+ + a_{2L} G_L^+ \end{aligned} \quad (2.1.29)$$

$$\delta_L^+ = H_1^+, \quad (2.1.30)$$

$$\delta_R^+ = \frac{1}{\sqrt{1 + \left(\frac{\kappa_-^2}{\sqrt{2}\kappa_+ v_R}\right)^2}} G_R^+ + \frac{1}{\sqrt{1 + \left(\frac{\sqrt{2}\kappa_+ v_R}{\kappa_-^2}\right)^2}} H_2^+ \quad (2.1.31)$$

$$\equiv a_{RR} G_R^+ + a_{2R} H_2^+. \quad (2.1.32)$$

$G_{L,R}^\pm, G_{1,2}^0$  are Goldstone bosons,  $H_i^0$  ( $i=0,1,2,3$ ) are neutral scalars with  $J^{PC} = 0^{++}$ ,  $A_{1,2}^0$  are pseudoscalars with  $J^{PC} = 0^{+-}$  and  $H_{1,2}^\pm$  are single charged Higgs bosons. The doubly charged Higgs bosons are already physical. Constants  $a_i, b_i, c_i$  ( $i=0,1,2$ ) stands for elements of unitary matrix which diagonalize masses of part of neutral gauge Higgses (see []). Present experiments gives us bounds on masses of additional gauge bosons  $W_2$  and  $Z_2$  (see section 2.3) which are present in the model from which the following inequalities can be obtained

$$v_R \gg \kappa_+ \gg v_L$$

and then relations (4-11) can be simplify

$$\phi_1^0 \simeq \frac{1}{\kappa_+ \sqrt{2}} \left[ \kappa_1 H_0^0 - \kappa_2 H_1^0 + i\kappa_1 G_1^0 - i\kappa_2 A_1^0 \right], \quad (2.1.33)$$

$$\phi_2^0 \simeq \frac{1}{\kappa_+ \sqrt{2}} \left[ \kappa_2 H_0^0 + \kappa_1 H_1^0 - i\kappa_2 G_1^0 - i\kappa_1 A_1^0 \right], \quad (2.1.34)$$

where

$$\begin{aligned} A_L^{(1)} &= \frac{e}{\sqrt{2} \sin \Theta_W} \cos \xi K_L, & A_R^{(1)} &= -\frac{e}{\sqrt{2} \sin \Theta_W} \sin \xi e^{i\omega} K_R, \\ A_L^{(2)} &= \frac{e}{\sqrt{2} \sin \Theta_W} \sin \xi K_L, & A_R^{(2)} &= \frac{e}{\sqrt{2} \sin \Theta_W} \cos \xi e^{i\omega} K_R, \end{aligned}$$

and  $K_L(K_R)$  are  $6 \times 3$  mixing matrices

$$K_L = U_L^\dagger U_L^l, \quad K_R = U_R^\dagger U_R^l. \quad (2.2.3)$$

Similarly the neutral current Lagrangian in the L-R model is given by

$$L_{NC} = \frac{e}{2 \sin \Theta_W \cos \Theta_W} [J_1^\mu Z_{1\mu} + J_2^\mu Z_{2\mu}], \quad (2.2.4)$$

where two neutral currents  $J_{1,2}^\mu$  for leptons are equal

$$J_i^\mu = \bar{l} \gamma^\mu [A_L^{il} P_L + A_R^{il} P_R] l + \bar{\nu} \gamma^\mu [A_L^{i\nu} P_L + A_R^{i\nu} P_R] \nu, \quad (2.2.5)$$

where

$$\begin{aligned} A_L^{1l} &= \cos \phi g_L^e + \sin \phi g_L^{\prime e}, & A_L^{1\nu} &= \cos \phi + \sin \phi g_L^{\prime e} \\ A_R^{1l} &= \cos \phi g_R^e + \sin \phi g_R^{\prime e}, & A_R^{1\nu} &= \sin \phi g_R^{\prime \nu}, \\ A_L^{2l} &= \cos \phi (-g_L^{\prime e}) + \sin \phi g_L^e, & A_L^{2\nu} &= \cos \phi (-g_L^{\prime e}) + \sin \phi, \\ A_R^{2l} &= \cos \phi (-g_R^{\prime e}) + \sin \phi g_R^e, & A_R^{2\nu} &= \cos \phi (-g_R^{\prime \nu}), \end{aligned} \quad (2.2.6)$$

and

$$\begin{aligned} g_L^e &= -1 + 2 \sin^2 \Theta_W, & g_L^{\prime e} &= -\frac{\sin^2 \Theta_W}{\sqrt{\cos 2\Theta_W}}, \\ g_R^e &= 2 \sin^2 \Theta_W, & g_R^{\prime e} &= \frac{1 - 3 \sin^2 \Theta_W}{\sqrt{\cos 2\Theta_W}}, \\ g_R^{\prime \nu} &= -\frac{\cos^2 \Theta_W}{\sqrt{\cos 2\Theta_W}}. \end{aligned}$$

**Quarks**

and

$$\begin{aligned}
g_L^d &= -\cos^2 \Theta_W - \frac{\sin^2 \Theta_W}{3} & g_L'^d &= \frac{\sin^2 \Theta_W}{3\sqrt{\cos 2\Theta_W}}, \\
g_R^d &= \frac{2}{3}\sin^2 \Theta_W, & g_R'^d &= \sqrt{\cos 2\Theta_W} + \frac{\sin^2 \Theta_W}{3\sqrt{\cos 2\Theta_W}}, \\
g_R^u &= -\frac{4}{3}\sin^2 \Theta_W & g_R'^u &= -\sqrt{\cos 2\Theta_W} + \frac{\sin^2 \Theta_W}{3\sqrt{\cos 2\Theta_W}}, \\
g_L^u &= \frac{\sin^2 \Theta_W}{3\sqrt{\cos 2\Theta_W}}, & g_L'^u &= g_L'^d
\end{aligned}$$

### 2.3 Gauge-Gauge interactions

This Lagrangian is defined in Eq.(1.1.12) which can be written in physical basis taking into account Eqs.(2.1.2),(2.1.3).

### 2.4 Fermion - Higgs and Goldstone boson interactions

The lepton sector (Eq.(2.1.4)):

$$\begin{aligned}
& \bar{\nu}_L (h\phi_1^0 + \tilde{h}\phi_2^{0*}) \nu_R + h.c. = \\
& \sum_a \bar{N}_a \left\{ \left[ (\Omega_L)_{aa} m_a^N B_0 + \sum_l (K_L)_{al} (K_R^*)_{al} m_l A_0^* \right] P_R \right. \\
& + \left[ m_a^N (\Omega_L)_{aa} B_0^* + \sum_l (K_L^*)_{al} (K_R)_{al} m_l A_0 \right] P_L \left. \right\} N_a \\
& + \sum_{a>b} \bar{N}_a \left\{ \left[ ((\Omega_L)_{ac} m_c^N (\Omega_R)_{cb} + (\Omega_L)_{bc} m_c^N (\Omega_R)_{ca}) B_0 \right. \right. \\
& + \left. \left. \sum_l m_l ((K_L)_{al} (K_R^*)_{bl} + (K_L)_{bl} (K_R^*)_{al}) A_0^* \right] P_R \right. \\
& + \left[ ((\Omega_L)_{ac} m_c^N (\Omega_R)_{cb} + (\Omega_L)_{bc} m_c^N (\Omega_R)_{ca}) B_0^* \right. \\
& + \left. \left. \sum_l m_l ((K_L^*)_{bl} (K_R)_{al} + (K_L^*)_{al} (K_R)_{bl}) A_0 \right] P_L \left. \right\} N_b, \quad (2.4.1) \\
& \bar{\nu}_L (h\phi_1^+ - \tilde{h}\phi_2^+) e_R + \bar{e}_L (h\phi_2^- - \tilde{h}\phi_1^-) \nu_R + h.c. =
\end{aligned}$$

where the first two parts are given by

$$\begin{aligned}
& \delta_R^0 \bar{\nu}_L^c h_{R\nu R} + h.c. = \\
& - \frac{1}{2v_R} \sum_a \bar{N}_a \left( \sum_c m_c^N [(\Omega_R)_{ca}^2 P_R \delta_R^0 + (\Omega_R^*)_{ca}^2 P_L \delta_R^{0*}] \right) N_a \\
& - \frac{1}{v_R} \sum_{a>b} \bar{N}_a \left( \sum_c m_c^N [(\Omega_R)_{cb} (\Omega_R)_{ca} P_R \delta_R^0 + (\Omega_R^*)_{cb} (\Omega_R^*)_{ca} P_L \delta_R^{0*}] \right) N_b, \tag{2M_b6}
\end{aligned}$$

and

$$\begin{aligned}
& - \frac{\delta_R^+}{\sqrt{2}} (\bar{\nu}_L^c h_{R e_R} + \bar{e}_L^c h_{R\nu R}) + h.c. = \\
& - \frac{1}{v_R} \sum_{a,l} \left\{ \bar{N}_a \left[ \sum_b (\Omega_R^*)_{ab} m_b^N (K_R)_{bl} \right] P_R e_l \delta_R^+ \right. \\
& \left. + \bar{e}_l \left[ \sum_b (K_R^\dagger)_{lb} m_b^N (\Omega_R^*)_{ba} \right] P_L N_a \delta_R^- \right\}. \tag{2.4.7}
\end{aligned}$$

To get the interaction of the left-handed triplet the indices L(R) in the formulae (35) and (36) should be replaced by R(L) (if  $v_L \neq 0$ ). If the left handed triplet does not condensate ( $v_L = 0$ ) it will still interact with the leptons ( $h_L = h_R \neq 0$ ). Then to get its interaction with physical leptons we have to use the formulae

$$\begin{aligned}
& \delta_L^0 \bar{\nu}_R^c h_{L\nu L} + h.c. = \\
& \frac{1}{\sqrt{2}v_R} \sum_a \bar{N}_a [X_{aa} \delta_L^0 P_L + X_{aa}^* \delta_L^{0*} P_R] N_a \\
& + \frac{\sqrt{2}}{v_R} \sum_{a>b} \bar{N}_a [X_{ab} \delta_L^0 P_L + X_{ab}^* \delta_L^{0*} P_R] N_b, \tag{2.4.8}
\end{aligned}$$

and

$$\begin{aligned}
& - \frac{\delta_L^+}{\sqrt{2}} (\bar{\nu}_R^c h_{L e_L} + \bar{e}_R^c h_{L\nu L}) + h.c. = \tag{2.4.9} \\
& - \frac{1}{v_R} \delta_L^+ \sum_{a,l} \bar{N}_a \sum_b X_{ab} (K_L)_{bl} P_L e_l + \frac{1}{v_R} \delta_L^- \sum_{a,l} \bar{e}_l \sum_b (K_L^\dagger)_{lb} (X^*)_{ba} P_R N_a,
\end{aligned}$$

$$\begin{aligned}
& + W_{3R}^\mu \left[ \frac{\kappa_2}{\sqrt{2}} \left( (\partial_\mu \phi_2^0) - (\partial_\mu \phi_2^{0*}) \right) - \frac{\kappa_1}{\sqrt{2}} \left( (\partial_\mu \phi_1^0) - (\partial_\mu \phi_1^{0*}) \right) \right] \Big\} \\
& + \frac{ig}{2} \left\{ W_L^{\mu+} \left( \kappa_1 \partial_\mu \phi_2^- - \kappa_2 \partial_\mu \phi_1^- \right) - W_L^{\mu-} \left( \kappa_1 \partial_\mu \phi_2^+ - \kappa_2 \partial_\mu \phi_1^+ \right) \right. \\
& \left. + W_R^{\mu+} \left( \kappa_1 \partial_\mu \phi_1^- - \kappa_2 \partial_\mu \phi_2^- \right) - W_R^{\mu-} \left( \kappa_1 \partial_\mu \phi_1^+ - \kappa_2 \partial_\mu \phi_2^+ \right) \right\} \quad (3.1)
\end{aligned}$$

and

$$\begin{aligned}
L_2^{\Delta R} & = -ig' \frac{v_R}{\sqrt{2}} B^\mu \left[ \partial_\mu \delta_R^{0*} - \partial_\mu \delta_R^0 \right] + ig \frac{v_R}{\sqrt{2}} W_{3R}^\mu \left[ \partial_\mu \delta_R^{0*} - \partial_\mu \delta_R^0 \right] \\
& + ig \frac{v_R}{\sqrt{2}} \left[ W_R^{\mu-} \left( \partial_\mu \delta_R^+ \right) - W_R^{\mu+} \left( \partial_\mu \delta_R^- \right) \right]. \quad (3.2)
\end{aligned}$$

That is why we prepare appropriate gauge fixing lagrangian which causes that these bilinear terms are canceled.

In physical terms this lagrangian is read

$$\begin{aligned}
L_{GF} & = -\frac{1}{4\xi} \left\{ \left[ \partial^\mu Z_{1\mu} - 2\xi a_{11}^{ZG} G_1^o \right]^2 + \left[ \partial^\mu Z_{1\mu} - 2\xi b_{12}^{ZG} G_2^o \right]^2 \right. \\
& + \left[ \partial^\mu Z_{2\mu} - 2\xi a_{21}^{ZG} G_1^o \right]^2 + \left[ \partial^\mu Z_{2\mu} - 2\xi b_{22}^{ZG} G_2^o \right]^2 \\
& + 2 \left[ \partial^\mu W_{1\mu}^+ + 2\xi (ab)_{1R}^{WG} G_R^+ \right] \left[ \partial^\mu W_{1\mu}^- - 2\xi (ab)_{1R}^{WG} G_R^- \right] \\
& + 2 \left[ \partial^\mu W_{1\mu}^+ + 2\xi a_{1L}^{WG} G_L^+ \right] \left[ \partial^\mu W_{1\mu}^- - 2\xi a_{1L}^{WG} G_L^- \right] \\
& + 2 \left[ \partial^\mu W_{2\mu}^+ + 2\xi (ab)_{2R}^{WG} G_R^+ \right] \left[ \partial^\mu W_{2\mu}^- - 2\xi (ab)_{2R}^{WG} G_R^- \right] \\
& \left. + 2 \left[ \partial^\mu W_{2\mu}^+ + 2\xi a_{2L}^{WG} G_L^+ \right] \left[ \partial^\mu W_{2\mu}^- - 2\xi a_{2L}^{WG} G_L^- \right] \right\} \quad (3.3)
\end{aligned}$$

where

$$\begin{aligned}
(a_{11}^{ZG})^2 + (b_{12}^{ZG})^2 & = m_{Z_1}^2 & (a_{21}^{ZG})^2 + (b_{22}^{ZG})^2 & = m_{Z_2}^2 \\
((ab)_{1R}^{WG})^2 + (a_{1L}^{WG})^2 & = m_{W_1}^2 & ((ab)_{2R}^{WG})^2 + (a_{2L}^{WG})^2 & = m_{W_2}^2
\end{aligned} \quad (3.4)$$

where:

$$\begin{aligned}
a_{11}^{ZG} & = -\frac{g}{\sqrt{2}} \kappa_+^2 (x_1 - y_1), & a_{21}^{ZG} & = -\frac{g}{\sqrt{2}} \kappa_+^2 (x_2 - y_2) \\
b_{12}^{ZG} & = -v_R (g' v_1 - g y_1), & b_{22}^{ZG} & = -v_R (g' v_2 - g y_2)
\end{aligned} \quad (3.5)$$

$$\begin{aligned}
\delta^{BRS} \phi_1^+ &= -\frac{ig}{2}(\sqrt{2}c_R^+ \phi_1^o - c_{R3} \phi_1^+ - \sqrt{2}c_L^+ \phi_2^o - c_{L3} \phi_2^+) \\
\delta^{BRS} \phi_2^- &= -\frac{ig}{2}(\sqrt{2}c_R^- \phi_2^o + c_{R3} \phi_2^- - \sqrt{2}c_L^- \phi_2^o + c_{L3} \phi_2^-) \\
\delta^{BRS} \phi_2^o &= -\frac{ig}{2}(\sqrt{2}c_R^+ \phi_2^- - c_{R3} \phi_2^o - \sqrt{2}c_L^- \phi_1^+ + c_{L3} \phi_2^o) \\
\delta^{BRS} \delta_{R,L}^+ &= ig(\delta_{R,L}^o c_{R,L}^+ - \delta_{R,L}^{++} c_{R,L}^-) + ig' c^4 \delta_{R,L}^+ \\
\delta^{BRS} \delta_{R,L}^{++} &= -ig(\delta_{R,L}^+ c_{R,L}^+ - \delta_{R,L}^{++} c_{R,L3}^+) + ig' c^4 \delta_{R,L}^{++} \\
\delta^{BRS} \delta_{R,L}^o &= +ig \delta_{R,L}^+ c_{R,L}^- + ig' c^4 \delta_{R,L}^o - ig \delta_{R,L}^o c_{R,L3}^+,
\end{aligned}$$

and for gauge bosons

$$\begin{aligned}
\delta^{BRS} W_{L,R}^{3\mu} &= \partial^\mu c_{L,R}^3 + g(W_{L,R}^{1\mu} c_{L,R}^2 - W_{L,R}^{2\mu} c_{L,R}^1) \\
\delta^{BRS} W_{L,R}^{1,2\mu} &= \partial^\mu c_{L,R}^{1,2} + g(W_{L,R}^{2,3\mu} c_{L,R}^{3,1} - W_{L,R}^{3,1\mu} c_{L,R}^{2,3}) \\
\delta^{BRS} B^\mu &= \partial^\mu c^4
\end{aligned}$$

where similarly like for W bosons we have

$$c_{L,R}^\pm = \frac{1}{\sqrt{2}}(c_{L,R}^1 \mp i c_{L,R}^2) \quad (3.8)$$

Because auxiliary fields  $B_{L,R}^3, B_{L,R}^\pm, B_B$  under BRS transformations give zero

$$\delta^{BRS} B_{L,R,B}^{3,\pm} = 0,$$

the F-P Lagrangian is explicitly as follow

$$\begin{aligned}
L_{FP} &= \bar{c}_L^3 \delta^{BRS} \left\{ \partial^\mu W_{3L\mu} - \frac{ig\xi}{2\sqrt{2}} [\kappa_1(\phi_1^o - \phi_1^{o*}) - \kappa_2(\phi_2^o - \phi_2^{o*})] \right\} \\
&+ \bar{c}_R^3 \delta^{BRS} \left\{ \partial^\mu W_{3R\mu} - \frac{ig\xi}{2} [\kappa(\phi_2^o - \phi_2^{o*}) - \kappa(\phi_1^o - \phi_1^{o*}) - 2v_R(\delta_R^o - \delta_R^{o*})] \right\} \\
&+ \bar{c}^4 \delta^{BRS} \left[ \partial^\mu B_\mu - \frac{ig'v_R\xi}{\sqrt{2}}(\delta_R^o - \delta_R^{o*}) \right] \\
&+ \bar{c}_L^- \delta^{BRS} \left\{ \partial^\mu W_{L\mu}^+ + \frac{ig\xi}{2} [\kappa_1 \phi_2^+ - \kappa_2 \phi_1^+] \right\}
\end{aligned}$$

where

$$M_i = \begin{cases} M_{W_{1,2}} & \text{for } W_{1,2}^\pm \\ M_{Z_{1,2}} & \text{for } Z_{1,2} \\ 0 & \text{for } \textit{photon} \end{cases} \quad (3.15)$$

-for neutral and charged Higgs bosons

$$i\Delta(p) = \frac{i}{p^2 - M_H^2 + i\varepsilon} \quad (3.16)$$

-for neutral Nambu-Goldson particles

$$i\Delta(p) = \frac{i}{p^2 - 2\xi M_i^2 + i\varepsilon} \quad \textit{where } M_i = \begin{cases} (a_{11}^{ZG})^2 + (a_{21}^{ZG})^2 & \textit{for } G_1^0 \\ (b_{11}^{ZG})^2 + (b_{21}^{ZG})^2 & \textit{for } G_2^0 \end{cases} \quad (3.17)$$

- for charged Nambu-Goldson particles

$$i\Delta(p) = \frac{i}{p^2 + 2\xi M_i^2 + i\varepsilon} \quad \textit{where } M_i = \begin{cases} [(ab)_{1R}^{WG}]^2 + [(ab)_{2R}^{WG}]^2 & \textit{for } G_R^\pm \\ (a_{1L}^{WG})^2 + (a_{2L}^{WG})^2 & \textit{for } G_L^\pm \end{cases} \quad (3.18)$$



$$\overset{\circ}{M}_{W_{1,2}}^2 = M_{W_{1,2}}^2 + \delta M_{W_{1,2}}^2 \equiv G_W^2 M_W^2 \quad (4.1.15)$$

$$\overset{\circ}{M}_Z^2 = M_Z^2 + \delta M_Z^2 \equiv G_Z^2 M_Z^2 \quad (4.1.16)$$

$$\overset{\circ}{M}_H^2 = M_H^2 + \delta M_H^2 \equiv G_H^2 M_H^2 \quad (4.1.17)$$

$$\overset{\circ}{M}_f^2 = M_f^2 + \delta M_f^2 \equiv G_f^2 M_f^2 \quad (4.1.18)$$

$$\overset{\circ}{e} = Y e, \quad (4.1.19)$$

where quantities with (without) suffix 0 denote bare (renormalized) quantities, H (G) represents an arbitrary Higgs (Goldston) particle,  $M_f$  is the fermion mass, capital (small) indices "ij" represent top (bottom) fermions. In the near future we are going to calculate Z decay into two light neutrinos in one-loop approximation in the LR model, so the examples in this paragraph (for instance the renormalization constants) has been chosen according to this task. We use for our calculations on-shell renormalization framework which has been used by Aoki, Hioki, Kawabe, Konuma, Muta ( ).

## 4.2 Renormalization conditions and counter terms for two-point functions (proper self energies) of physical particles.

### 4.2.1 Gauge-bosons.

In all the following pictures in this section the diagram;

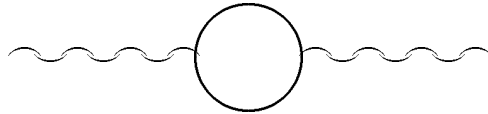

represent n-loop diagram, whereas shaped like this;



$$\begin{array}{c}
Z_{2\mu} \text{---} \bigcirc \text{---} A_\nu \\
= \left( g_{\mu\nu} - \frac{k_\mu k_\nu}{k^2} \right) A^{Z_2 A}(k^2) + \frac{k_\mu k_\nu}{k^2} B^{Z_2 A}(k^2),
\end{array}$$

$$\begin{array}{c}
Z_{2\mu} \text{---} \times \text{---} A_\nu \\
= \left( g_{\mu\nu} - \frac{k_\mu k_\nu}{k^2} \right) \left[ (M_{Z_2}^2 + \delta M_{Z_2}^2)(Z_{Z_2 Z_2}^{\frac{1}{2}} Z_{Z_2 A}^{\frac{1}{2}}) + \right. \\
(M_{Z_1}^2 + \delta M_{Z_1}^2)(Z_{Z_1 Z_2}^{\frac{1}{2}} Z_{Z_1 A}^{\frac{1}{2}}) - k^2((Z_{Z_2 Z_2}^{\frac{1}{2}} Z_{Z_2 A}^{\frac{1}{2}}) + \\
(Z_{Z_1 Z_2}^{\frac{1}{2}} Z_{Z_1 A}^{\frac{1}{2}}) + (Z_{AZ_2}^{\frac{1}{2}} Z_{AA}^{\frac{1}{2}})) \left. \right] + \frac{k_\mu k_\nu}{k^2} \left[ (M_{Z_2}^2 + \right. \\
\left. \delta M_{Z_2}^2)(Z_{Z_2 Z_2}^{\frac{1}{2}} Z_{Z_2 A}^{\frac{1}{2}}) + (M_{Z_1}^2 + \delta M_{Z_1}^2)(Z_{Z_1 Z_2}^{\frac{1}{2}} Z_{Z_1 A}^{\frac{1}{2}}) \right].
\end{array}$$

$$\begin{array}{c}
A_\mu \text{---} \bigcirc \text{---} A_\nu \\
= \left( g_{\mu\nu} - \frac{k_\mu k_\nu}{k^2} \right) A^A(k^2) + \frac{k_\mu k_\nu}{k^2} B^A(k^2),
\end{array}$$

$$\begin{array}{c}
A_\mu \text{---} \times \text{---} A_\nu \\
= \left( g_{\mu\nu} - \frac{k_\mu k_\nu}{k^2} \right) \left[ (M_{Z_1}^2 + \delta M_{Z_1}^2)(Z_{Z_1 A}^{\frac{1}{2}})^2 + \right. \\
f(M_{Z_2}^2 + \delta M_{Z_2}^2)(Z_{Z_2 A}^{\frac{1}{2}})^2 - k^2((Z_{Z_1 A}^{\frac{1}{2}})^2 + \\
(Z_{Z_2 A}^{\frac{1}{2}})^2 + (Z_{AA}^{\frac{1}{2}})^2) \left. \right] + \frac{k_\mu k_\nu}{k^2} \left[ (M_{Z_1}^2 + \delta M_{Z_1}^2) \right. \\
\left. (Z_{Z_1 A}^{\frac{1}{2}})^2 + (M_{Z_2}^2 + \delta M_{Z_2}^2)(Z_{Z_2 A}^{\frac{1}{2}})^2 \right].
\end{array}$$

Renormalization conditions

Renormalization constants

$$\left. \begin{array}{l}
A^{Z_1}(M_{Z_1}^2) = 0, \quad A^{Z_1}(M_{Z_1}^2) = 0, \\
A^A(0) = 0, \quad A^A(0) = 0, \\
A^{Z_1 A}(M_{Z_1}^2) = 0, \quad A^{Z_1 A}(0) = 0, \\
A^{Z_2 A}(M_{Z_2}^2) = 0, \quad A^{Z_2 A}(0) = 0.
\end{array} \right\} \Rightarrow Z_{Z_1 Z_1}^{\frac{1}{2}}, Z_{Z_1 A}^{\frac{1}{2}}, Z_{Z_2 A}^{\frac{1}{2}}, Z_{AZ_1}^{\frac{1}{2}}, Z_{AZ_2}^{\frac{1}{2}}, Z_{AA}^{\frac{1}{2}}, \\
\delta M_{Z_1}^2, \delta M_{Z_2}^2. \tag{4.2.1.2}$$

#### 4.2.2 Fermions.

$$\begin{array}{c}
i \text{---} \bigcirc \text{---} j \\
= K_1^{ij}(k^2)1 + K_5^{ij}(k^2)\gamma^5 + K_\gamma^{ij}(k^2)\hat{k} + K_5^{ij}\gamma(k^2)\hat{k}\gamma^5,
\end{array}$$

We show the  $W_1$  boson self-energy diagrams on figure 1. We use the following symbols; "number" is the number of diagrams and "number"nsp (csp) (dcsp) is the number of neutral (charged) (double-charged) scalar particles which contribute to the diagram. The renormalization constant  $\delta M_{W_1}^2$  is determined by:

$$\sum_{n=1}^{128} A_n^{W_1}(M_{W_1}^2) + \delta M_{W_1}^2 = 0. \quad (4.3.1.1)$$

From equation 4.3.1.1 one gets:

$$\begin{aligned} \delta M_{W_1}^2 = & - \sum_{m_{La}, m_{Lb}} iA_L^{(1)} A_L^{(1)+} \left[ \left( \frac{1}{\Pi^2} M_{W_1}^2 \right) \left( \frac{1}{6} C_{uv} + \text{Re} \int_0^1 dx (x-1) \ln D_2(m_{La}, m_{Lb}, x) \right) + \right. \\ & \left. \frac{1}{4\Pi^2} \left( - (m_{La}^2 + m_{Lb}^2) C_{uv} + 2\bar{m}^2(m_{La}, m_{Lb}) \text{Re} \int_0^1 dx \ln D_2(m_{La}, m_{Lb}, x) \right) \right] - \\ & \sum_{m_{Ra}, m_{Rb}} iA_R^{(1)} A_R^{(1)+} \left[ \left( \frac{1}{\Pi^2} M_{W_1}^2 \right) \left( \frac{1}{6} C_{uv} + \text{Re} \int_0^1 dx (x-1) \ln D_2(m_{Ra}, m_{Rb}, x) \right) + \right. \\ & \left. \frac{1}{4\Pi^2} \left( - (m_{Ra}^2 + m_{Rb}^2) C_{uv} + 2\bar{m}^2(m_{Ra}, m_{Rb}) \text{Re} \int_0^1 dx \ln D_2(m_{Ra}, m_{Rb}, x) \right) \right] - \\ & \sum_{m_{La}, m_{Lb}} iA_L^{(1)q} A_L^{(1)q+} \left[ \left( \frac{1}{\Pi^2} M_{W_1}^2 \right) \left( \frac{1}{6} C_{uv} + \text{Re} \int_0^1 dx (x-1) \ln D_2(m_{La}, m_{Lb}, x) \right) + \right. \\ & \left. \frac{1}{4\Pi^2} \left( - (m_{La}^2 + m_{Lb}^2) C_{uv} + 2\bar{m}^2(m_{La}, m_{Lb}) \text{Re} \int_0^1 dx \ln D_2(m_{La}, m_{Lb}, x) \right) \right] - \\ & \sum_{m_{Ra}, m_{Rb}} iA_R^{(1)q} A_R^{(1)q+} \left[ \left( \frac{1}{\Pi^2} M_{W_1}^2 \right) \left( \frac{1}{6} C_{uv} + \text{Re} \int_0^1 dx (x-1) \ln D_2(m_{Ra}, m_{Rb}, x) \right) + \right. \\ & \left. \frac{1}{4\Pi^2} \left( - (m_{Ra}^2 + m_{Rb}^2) C_{uv} + 2\bar{m}^2(m_{Ra}, m_{Rb}) \text{Re} \int_0^1 dx \ln D_2(m_{Ra}, m_{Rb}, x) \right) \right] - \\ & \frac{i}{16\Pi^2} g^2 \left\{ (\cos^2 \xi x_1 + \sin^2 \xi y_1)^2 \left[ \left( \frac{19}{6} M_{W_1}^2 + \frac{9}{2} (M_{W_1}^2 + M_{Z_1}^2) \right) C_{uv} + 3 \left( \frac{M_{W_1}^2 + M_{Z_1}^2}{2} - \frac{M_{W_1}^2}{6} \right) - \right. \right. \\ & \left. \left. \text{Re} \int_0^1 dx (9\bar{m}^2(M_{W_1}, M_{Z_1}) + M_{W_1}^2 (5 + 11x^2 - 11x)) \ln D_2(M_{W_1}, M_{Z_1}, x) \right] + \right. \\ & \left. \sin^2 \xi \cos^2 \xi (x_1 - y_1)^2 \left[ \left( \frac{19}{6} M_{W_1}^2 + \frac{9}{2} (M_{W_2}^2 + M_{Z_1}^2) \right) C_{uv} + 3 \left( \frac{M_{W_2}^2 + M_{Z_1}^2}{2} - \frac{M_{W_1}^2}{6} \right) - \right. \right. \\ & \left. \left. \text{Re} \int_0^1 dx (9\bar{m}^2(M_{W_2}, M_{Z_1}) + M_{W_1}^2 (5 + 11x^2 - 11x)) \ln D_2(M_{W_2}, M_{Z_1}, x) \right] + \right. \\ & \left. (\cos^2 \xi x_2 + \sin^2 \xi y_2)^2 \left[ \left( \frac{19}{6} M_{W_1}^2 + \frac{9}{2} (M_{W_1}^2 + M_{Z_2}^2) \right) C_{uv} + 3 \left( \frac{M_{W_1}^2 + M_{Z_2}^2}{2} - \frac{M_{W_1}^2}{6} \right) - \right. \right. \\ & \left. \left. \text{Re} \int_0^1 dx (9\bar{m}^2(M_{W_1}, M_{Z_2}) + M_{W_1}^2 (5 + 11x^2 - 11x)) \ln D_2(M_{W_1}, M_{Z_2}, x) \right] + \right. \\ & \left. \sin^2 \xi \cos^2 \xi (x_2 - y_2)^2 \left[ \left( \frac{19}{6} M_{W_1}^2 + \frac{9}{2} (M_{W_2}^2 + M_{Z_2}^2) \right) C_{uv} + 3 \left( \frac{M_{W_2}^2 + M_{Z_2}^2}{2} - \frac{M_{W_1}^2}{6} \right) - \right. \right. \\ & \left. \left. \text{Re} \int_0^1 dx (9\bar{m}^2(M_{W_2}, M_{Z_2}) + M_{W_1}^2 (5 + 11x^2 - 11x)) \ln D_2(M_{W_2}, M_{Z_2}, x) \right] + \right. \\ & \left. (\cos^2 \xi x_3 + \sin^2 \xi y_3)^2 \left[ \left( \frac{19}{6} M_{W_1}^2 + \frac{9}{2} (M_{W_1}^2 + 0) \right) C_{uv} + 3 \left( \frac{M_{W_1}^2 + 0}{2} - \frac{M_{W_1}^2}{6} \right) - \right. \right. \\ & \left. \left. \text{Re} \int_0^1 dx (9\bar{m}^2(M_{W_1}, 0) + M_{W_1}^2 (5 + 11x^2 - 11x)) \ln D_2(M_{W_1}, 0, x) \right] \right\} + \\ & \frac{i}{8\Pi^2} g^2 \left[ - (\sin^4 \xi + \cos^4 \xi) M_{W_1}^2 (3C_{uv} + 1 - 3 \ln M_{W_1}^2) - 2 \cos^2 \xi \sin^2 \xi M_{W_2}^2 \right. \\ & \left. (3C_{uv} + 1 - 3 \ln M_{W_2}^2) + (\cos^2 \xi x_1 + \sin^2 \xi y_1) M_{Z_1}^2 (3C_{uv} + 1 - 3 \ln M_{Z_1}^2) + \right. \\ & \left. (\cos^2 \xi x_2 + \sin^2 \xi y_2) M_{Z_2}^2 (3C_{uv} + 1 - 3 \ln M_{Z_2}^2) \right] + \end{aligned}$$

$$\begin{aligned}
& \left[ \left( \frac{g}{\sqrt{2}}(ia_{1RCG} - ia_{2RC A})\sin\xi + \frac{g}{\sqrt{2}}(-ia_{1RC A} + ia_{2RCG})\cos\xi \right)^2 \right. \\
& \quad \left. \left( -\frac{M_{W_1}^2}{3} \right) (C_{uv} + 1) - 2\text{Re} \int_0^1 dx D_2(0, 0, x) \ln D_2(0, 0, x) \right] + \\
& \left[ \left( \frac{g}{\sqrt{2}}(-ia_{1RC A} - ia_{2RCG})\sin\xi + \frac{g}{\sqrt{2}}(-ia_{1RCG} - ia_{2RC A})\cos\xi \right)^2 \right. \\
& \quad \left. \left( 0 + M_{A_1}^2 - \frac{M_{W_1}^2}{3} \right) (C_{uv} + 1) - 2\text{Re} \int_0^1 dx D_2(0, M_{A_1}, x) \ln D_2(0, M_{A_1}, x) \right] + \\
& \left[ \left( \frac{g}{\sqrt{2}}(a_{1LC10} - a_{2LC20})\sin\xi + \frac{g}{\sqrt{2}}(a_{1LC20} - a_{2LC10})\cos\xi \right)^2 \right. \\
& \quad \left. \left( 0 + M_{H^0}^2 - \frac{M_{W_1}^2}{3} \right) (C_{uv} + 1) - 2\text{Re} \int_0^1 dx D_2(0, M_{H^0}, x) \ln D_2(0, M_{H^0}, x) \right] + \\
& \left[ \left( \frac{g}{\sqrt{2}}(a_{1LC11} - a_{2LC21})\sin\xi + \frac{g}{\sqrt{2}}(a_{1LC21} - a_{2LC11})\cos\xi \right)^2 \right. \\
& \quad \left. \left( 0 + M_{H_1^0}^2 - \frac{M_{W_1}^2}{3} \right) (C_{uv} + 1) - 2\text{Re} \int_0^1 dx D_2(0, M_{H_1^0}, x) \ln D_2(0, M_{H_1^0}, x) \right] + \\
& \left[ \left( \frac{g}{\sqrt{2}}(a_{1LC12} - a_{2LC22})\sin\xi + \frac{g}{\sqrt{2}}(a_{1LC22} - a_{2LC12})\cos\xi \right)^2 \right. \\
& \quad \left. \left( 0 + M_{H_2^0}^2 - \frac{M_{W_1}^2}{3} \right) (C_{uv} + 1) - 2\text{Re} \int_0^1 dx D_2(0, M_{H_2^0}, x) \ln D_2(0, M_{H_2^0}, x) \right] + \\
& \left[ \left( \frac{g}{\sqrt{2}}(ia_{1LCG} - ia_{2LC A})\sin\xi + \frac{g}{\sqrt{2}}(-ia_{1LC A} + ia_{2LCG})\cos\xi \right)^2 \right. \\
& \quad \left. \left( -\frac{M_{W_1}^2}{3} \right) (C_{uv} + 1) - 2\text{Re} \int_0^1 dx D_2(0, 0, x) \ln D_2(0, 0, x) \right] + \\
& \left[ \left( \frac{g}{\sqrt{2}}(-ia_{1LC A} - ia_{2LCG})\sin\xi + \frac{g}{\sqrt{2}}(-ia_{1LCG} - ia_{2LC A})\cos\xi \right)^2 \right. \\
& \quad \left. \left( 0 + M_{A_1}^2 - \frac{M_{W_1}^2}{3} \right) (C_{uv} + 1) - 2\text{Re} \int_0^1 dx D_2(0, M_{A_1}, x) \ln D_2(0, M_{A_1}, x) \right] - \\
& \frac{g^2}{2} \sin\xi \left[ -a_{RR}^2 \frac{M_{W_1}^2}{3} + a_{R2}^2 \left( M_{H_2^+}^2 - \frac{M_{W_1}^2}{3} \right) - 2a_{RR}^2 \left( M_{\delta_{R^+}^2}^2 - \frac{M_{W_1}^2}{3} \right) - \right. \\
& \quad \left. 2a_{R2}^2 \left( M_{\delta_{R^+}^2}^2 + M_{H_2^+}^2 - \frac{M_{W_1}^2}{3} \right) \right] + \\
& \frac{g^2}{2} \cos\xi \left[ \left( M_{H_3^0}^2 + M_{H_1^+}^2 - \frac{M_{W_1}^2}{3} \right) - \left( M_{A_2}^2 + M_{H_1^+}^2 - \frac{M_{W_1}^2}{3} \right) + 2 \left( M_{H_1^+}^2 + M_{\delta_{L^+}^2}^2 - \frac{M_{W_1}^2}{3} \right) \right] \Bigg\} + \\
& \frac{i}{16\Pi^2} g^2 \left\{ \left[ \frac{1}{2}(a_{12}^2 + a_{22}^2) + \frac{1}{2}a_{22}a_{12}(\sin 2\xi) + 2a_{R2}^2 \sin^2 \xi \right] M_{H_2^+}^2 \left[ C_{uv} + 1 - \ln M_{H_2^+}^2 \right] + \right. \\
& 2\cos^2 \xi M_{H_1^+}^2 \left[ C_{uv} + 1 - \ln M_{H_1^+}^2 \right] + \\
& \cos^2 \xi M_{\delta_{L^+}^2}^2 \left[ C_{uv} + 1 - \ln M_{\delta_{L^+}^2}^2 \right] + \\
& \sin^2 \xi M_{\delta_{R^+}^2}^2 \left[ C_{uv} + 1 - \ln M_{\delta_{R^+}^2}^2 \right] + \\
& \left[ c_{10}c_{20}\sin 2\xi + \frac{1}{2}c_0^2\sin^2 \xi + \frac{1}{2}(c_{10}^2 + c_{20}^2) \right] M_{H^0}^2 \left[ C_{uv} + 1 - \ln M_{H^0}^2 \right] + \\
& \left[ c_{11}c_{21}\sin 2\xi + \frac{1}{2}c_1^2\sin^2 \xi + \frac{1}{2}(c_{11}^2 + c_{21}^2) \right] M_{H_1^0}^2 \left[ C_{uv} + 1 - \ln M_{H_1^0}^2 \right] + \\
& \left[ c_{12}c_{22}\sin 2\xi + \frac{1}{2}c_2^2\sin^2 \xi + \frac{1}{2}(c_{12}^2 + c_{22}^2) \right] M_{H_2^0}^2 \left[ C_{uv} + 1 - \ln M_{H_2^0}^2 \right] + \\
& \left. \left[ c_{ACG}\sin 2\xi + \frac{1}{2}(c_G^2 + c_A^2) \right] M_{A^0}^2 \left[ C_{uv} + 1 - \ln M_{A^0}^2 \right] \right\}
\end{aligned} \tag{4.3.1.2}$$

where;

$$C_{uv} \equiv \frac{2}{\varepsilon} - \gamma + \ln 4\pi\mu^2, \quad \gamma \equiv \text{Euler constant}, \tag{4.3.1.3}$$

$$D_2(m_1, m_2, x) \equiv m_1^2(1-x) + m_2^2x - k^2x(1-x) - i\varepsilon, \tag{4.3.1.4}$$

