

# Explaining Belle Data on $B \rightarrow K^{(*)}\nu\bar{\nu}$ Decays via Dark Photon Resonances

T.M. Aliev,<sup>1</sup> A. Elpe,<sup>1</sup> L. Selbuz,<sup>2</sup> and I. Turan<sup>1</sup>

<sup>1</sup>*Department of Physics, Middle East Technical University, Ankara 06800, Turkey.*

<sup>2</sup>*Department of Engineering Physics, Ankara University, TR06100 Ankara, Turkey.*

(Dated: March 31, 2025)

## Abstract

Belle II collaboration reported the first measurement on  $\text{Br}(B^+ \rightarrow K^+\nu\bar{\nu})$ , which lies  $2.7\sigma$  away from the Standard Model expectation. This result may be manifestation of new physics beyond the Standard Model. In present work, motivated by the Belle II measurement, we investigate the effect of a dark photon on the rare B meson decay  $B^+ \rightarrow K^+\nu\bar{\nu}$  and show that the  $\text{Br}(B^+ \rightarrow K^+\nu\bar{\nu})$  excess from Belle II over SM expectation explained by the appearance of the dark photon especially in resonances. We also derive constraints on various parameters of the Two-Higgs-Doublet Model extended with a dark abelian gauge group, in the light of measurement of the  $\text{Br}(B^+ \rightarrow K^+\nu\bar{\nu})$  by the Belle-II collaboration as well as the upper bound on  $\text{Br}(B^0 \rightarrow K^{*0}\nu\bar{\nu})$  decay, set by the Belle data. Our results indicate that there exist common region where both experimental results for a dark photon mass around 4.5 GeV with suitable values of the other parameters.

## I. INTRODUCTION

The observation of the Higgs boson at the CERN Large Hadron Collider [1, 2] completed the Standard Model (SM). However, this does not rule out the existence of physics beyond the SM; instead, it merely restricts its possible scale and strongly encourages the experimental search for it. New particles can be explored both directly through high-energy experiments and indirectly through low-energy precision frontier. Historically, indirect evidence for new particles has often come before their direct discoveries. Notably, the existence of the charm quark, the W boson, the top quark, and the Higgs boson was predicted based on indirect measurements such as Fermi interactions, kaon mixing, and electroweak precision observables. In this context, semi-leptonic B meson decays are especially useful for conducting indirect searches for new physics (NP) due to they exhibit distinct and clear experimental signatures.

The flavor-changing neutral transitions, such as  $b \rightarrow s\nu\bar{\nu}$  and  $b \rightarrow s\ell\bar{\ell}$ , where  $\ell$  represents a charged lepton, are highly suppressed in the SM due to the Glashow-Iliopoulos-Maiani (GIM) [3] mechanism making them powerful tool for new physics searches beyond the SM [4, 5]. Because in the SM the flavor-changing neutral current (FCNC) processes are forbidden at the tree level and take place only at loop level. Obviously these processes are inherently sensitive to any new physics. Rare semileptonic decays of mesons mediated by FCNC are one of the promising areas to observe indirect NP effects. The rare B meson decays with a neutrino pair in the final state,  $B \rightarrow K^*\nu\bar{\nu}$  [6–12] and  $B^+ \rightarrow K^+\nu\bar{\nu}$ , are cleanest of them to search for new physics, due to their well controlled theoretical uncertainty in the SM, and for this reason, are rather sensitive to NP beyond SM. Many beyond the SM (BSM) scenarios predict a significant deviation of  $\text{Br}(B^+ \rightarrow K^+\nu\bar{\nu})$  and  $\text{Br}(B \rightarrow K^*\nu\bar{\nu})$  with respect to their SM prediction and therefore those branching ratios can provide us with either a test of validity of a given model, or with a constraint acceptable scenario of physics BSM. Experimentally, BaBar and Belle imposed upper limits on the  $B \rightarrow K^*\nu\bar{\nu}$  decays and had a measurement of  $B \rightarrow K\nu\bar{\nu}$  branching ratios, which are a few times higher than the SM predictions [13–16]. Belle II was expected to achieve a measurement of the  $B^+ \rightarrow K^+\nu\bar{\nu}$ ,  $B^+ \rightarrow K^{*+}\nu\bar{\nu}$  and  $B \rightarrow K^*\nu\bar{\nu}$  branching ratios with a precision of about 10% [17].

Recently, using the dataset with an integrated luminosity of  $362fb^{-1}$ , the Belle II experiment announced the first  $3.5\sigma$  evidence for the charged decay mode  $B^+ \rightarrow K^+\nu\bar{\nu}$ ,

$\text{Br}(B^+ \rightarrow K^+\nu\bar{\nu})_{\text{BelleII}} = (2.3 \pm 0.7) \times 10^{-5}$  [18], showing a  $2.7\sigma$  excess over the SM prediction  $\text{Br}(B^+ \rightarrow K^+\nu\bar{\nu})_{\text{SM}} = (4.29 \pm 0.23) \times 10^{-6}$  [6–8] where the tree-level contribution mediated by  $\tau$  leptons has been subtracted [19]. If the results are taken at face value, the following conclusions can be drawn: either lepton flavor universality is violated at the (multi)-TeV scale, or NP effects may be involved. This result is intriguing as it may suggest not only the existence of NP in the  $b \rightarrow s\nu\bar{\nu}$  transitions but also the possible presence of new light states [20]. The possibility of explaining the excess reported by Belle II in terms of NP has been considered in many different scenarios [19–41]. Recently, research on these types of experimental signatures has intensified within the context of dark sectors.

The  $B^+ \rightarrow K^+\nu\bar{\nu}$  decay rate can be significantly influenced in models that introduce non-SM particles [18], like leptoquarks [42]. Additionally, the B meson might decay into a kaon and an invisible particle, such as an axion [43] or a dark-sector mediator [44]. There are other rare decays of B meson including  $\nu\bar{\nu}$  pair and as mentioned above one such channel would be  $B \rightarrow K^*\nu\bar{\nu}$  decay which involves the vector meson  $K^*$  in the final state while the kaon in  $B \rightarrow K\nu\bar{\nu}$  process is a scalar particle. The Belle search for this decay has shown no excess over the SM so that it is converted to an exclusion bound of  $1.8 \times 10^{-8}$  for  $\text{Br}(B \rightarrow K^*\nu\bar{\nu})$  [16].

In the last few years, The existence of dark sectors has emerged as a compelling theoretical framework. The simplest dark sector may be referred to as the dark photon model [45, 46], where a new abelian gauge boson is added to the particle content of the SM. Dark sectors generally contain one or more mediator particles that interact with the SM through a portal. The portal relevant for interactions between the dark sector and the SM depends on the mediator’s spin and parity. The portal can be a scalar, a pseudoscalar, a fermion, or a vector. The gauge and Lorentz symmetries of the SM significantly restrict the possible ways the mediator can couple to the SM. In particular, light dark sectors with masses ranging from few MeV to few GeV have triggered a lot of attention and the Belle II experiment is known highly sensitive to many such scenarios.

The dark photon scenario [45, 47, 48] has been extensively analyzed in the literature, mainly in its massive case, and is the focus of many ongoing experimental searches [46]. In the context of astrophysics and cosmology, massless dark photons have been studied as mechanisms for long-range interactions among dark matter components [49–53]. Additionally, massless dark photons have been employed to understand the Standard Model’s flavor

hierarchy problem, flavor-changing neutral currents, and phenomena in kaon physics [54–58].

Dark photon models can be classified into two separate types depending on whether the associated field quanta are massive or massless. These possibilities lead to distinctly different experimental signatures: a massless dark photon does not have tree-level couplings to any SM fermions, and thus can only interact with ordinary matter through operators of dimension higher than four [45, 46, 59]. In contrast, massive dark photons can interact with ordinary matter through a renormalizable dimension-four operator involving an arbitrarily small charge. These two categories are distinct since the massless case cannot be achieved as a limit of massive dark photon models.

In present work, we study the compatibility of the recent Belle II result for  $\text{Br}(B^+ \rightarrow K^+ \nu \bar{\nu})$  with new physics in the form of a Two-Higgs-Doublet Model extended with  $U(1)_D$ . The part of the parameter space that satisfies the  $\text{Br}(B^+ \rightarrow K^+ \nu \bar{\nu})$  constraint will be further checked against the  $\text{Br}(B^0 \rightarrow K^{*0} \nu \bar{\nu})$  bound, which would reduce the allowed space significantly. Our paper is organized as follows. After the Two-Higgs-Doublet Model extended with a dark gauge group is briefly outlined in Section II. We present the decay widths of  $B \rightarrow K^{(*)} \nu \bar{\nu}$  processes within the framework of  $U(1)_D$  extended Two-Higgs Doublet Models in Section III. The next section is devoted to the numerical analysis of branching ratios mentioned above. The last section contains our discussions and conclusions.

## II. $U(1)_D$ EXTENDED TWO-HIGGS DOUBLET MODELS

In this section we outline the basic elements of the theoretical framework and we refer to the references [60, 61] for further details. Then a numerical analysis of the process  $B \rightarrow K^{(*)} \nu \bar{\nu}$  will follow.

Although its definition is rather broad, dark sector physics can be effectively and systematically investigated by using specific portal interactions as a guide. Dark sectors typically contain one or more mediator particles that connect to the SM through a portal. The interactions between the SM and dark sector could be controlled through various portals, classified further based on types of particles involved. Vector portal, requiring a dark vector boson coupling with the SM particles through dimension-4 operators, is one of such commonly studied scenario.

The gauge group of the Abelian vector portal is  $U(1)_D$ ; the mediator originating from this

additional gauge group is a vector boson, known as the dark photon. Even though it is taken to be massive, the vector boson (dark photon) resembles the SM photon because it is based on a  $U(1)$  symmetry; however, unlike the photon, it mediates a new kind of fundamental force, known as the dark force, which might have some detectable effects at colliders as well as low energy with high luminosity experiments. The vector portal fundamentally involves an interaction through kinetic mixing between the SM  $U(1)_Y$  hypercharge field  $Y_\mu$  and the  $U(1)_D$  dark sector field  $X_\mu$ . This kinetic mixing interaction ( $\frac{1}{2} \sin\epsilon Y_{\mu\nu} X^{\mu\nu}$ ) is invariant under both the  $U(1)_Y$  and  $U(1)_D$  gauge groups. The strength of the coupling is defined by the kinetic mixing parameter  $\sin\epsilon$ , which is a free parameter. Since it behaves as a small perturbation to the SM, to be consistent with observations, it is generally expected to have a small value. The phenomenology of the vector portal represents a broad class of well-motivated models, including scenarios where the mediator preferentially couples to baryonic, leptonic, or baryon number minus lepton number (B-L) conserving currents.

In its original form, there exists only a non-zero mixing between the photon field and the dark vector field, which results in limited access to the SM fermions without involving any additional gauge symmetry. This picture can be extended if the dark vector field is a gauge field of a local  $U(1)$  symmetry under which the SM fields are charged. Indeed, baryon number minus lepton number ( $B - L$ ) is assigned to the SM fields plus right-handed neutrinos as the new charges, one can show that the theoretical framework with  $G_{\text{SM}} \times U(1)_D$  gauge symmetry would be free of gauge anomalies.

A popular way to extend the SM is through its scalar sector while keeping the dark sector minimal (specifically, assuming an Abelian dark gauge group  $U(1)_D$ ). This is achieved by introducing an additional  $SU(2)$  doublet, leading to the so-called Two Higgs Doublet Models (2HDM) [62]. In its general form, the 2HDM struggles with the FCNC problem. To resolve this issue, a discrete symmetry is typically required. Furthermore, neutrino masses, which are among the most important observational evidence for new physics, are typically not addressed in the 2HDM. In this study, a gauge solution will be employed to address the FCNC problem. The idea here is to obtain anomaly-free, conventional 2HDM scenarios without FCNC by adding an Abelian  $U(1)_D$  gauge group to the 2HDM ( $G_{\text{2HDM}} \otimes U(1)_D$ ). The particle content of the model will include right-handed neutrinos, which will not only address the neutrino mass issue but also make it possible to satisfy the new anomaly equations that arise in the 2HDM under the  $U(1)_D$  group. The details of the scenarios have been

extensively examined in previous studies [61, 63, 64]. We focus solely on the relevant part of the model which we need in present study. The Lagrangian of the considered model is

$$\begin{aligned} \mathcal{L} = & -\frac{1}{4}W_{3\mu\nu}W_3^{\mu\nu} - \frac{1}{4}Y_{\mu\nu}Y^{\mu\nu} - \frac{1}{4}X_{\mu\nu}^0X^{0\mu\nu} - \frac{1}{2}\sin\epsilon X_{\mu\nu}^0Y^{\mu\nu} + \frac{1}{2}m_X^2X_\mu^0X^{0\mu} \\ & + (D_\mu\phi_1)^\dagger(D^\mu\phi_1) + (D_\mu\phi_2)^\dagger(D^\mu\phi_2) + \sum_i \bar{f}_i i \not{D} f_i. \end{aligned} \quad (1)$$

Here  $X_\mu^0$  represents the gauge field of  $U(1)_D$  while  $Y_\mu$  and  $W_{3\mu}$  are the usual weak hypercharge field of  $U(1)_Y$  and the third of weak gauge fields, respectively.  $\phi_1$  and  $\phi_2$  are the usual scalar doublets under  $SU(2)_L$ .  $\sin\epsilon$  indicates the strength of the kinetic mixing between  $U(1)_Y$  and  $U(1)_D$ .  $m_X$  is the Stueckelberg mass parameter [60, 65] for the dark gauge field  $X_\mu^0$ .  $D_\mu = \partial_\mu - ig_W t^3 W_{3\mu} - ig_Y Y Y_\mu - ig_D Q'_D X_\mu^0 + \dots$  is the covariant derivative with  $t^3$ ,  $Y$  and  $Q'_D$  being the  $SU(2)_L$  generator, weak hypercharge and dark  $U(1)_D$  charges of the fields, respectively. Here  $g_W$ ,  $g_Y$  and  $g_D$  refer to the corresponding gauge coupling constants. In the literature, the Stueckelberg extension of the SM with and without kinetic mixing has been thoroughly analyzed [66, 67]. The two-Higgs doublet model, augmented by an additional  $U(1)$  gauge symmetry, has been examined in [68] by considering the Stueckelberg contribution to the mass terms.

Fields	$u_R$	$d_R$	$Q_L$	$L_L$	$e_R$	$\nu_R$	$\phi_2$	$\phi_1$
Dark Charges	$Q'_u$	$Q'_d$	$\frac{Q'_u+Q'_d}{2}$	$-\frac{3(Q'_u+Q'_d)}{2}$	$-(2Q'_u + Q'_d)$	$-(Q'_u + 2Q'_d)$	$\frac{Q'_u-Q'_d}{2}$	$\frac{5Q'_u+7Q'_d}{2}$
Model A	$\frac{1}{2}$	$-\frac{1}{2}$	0	0	$-\frac{1}{2}$	$\frac{1}{2}$	$\frac{1}{2}$	$-\frac{1}{2}$
Model B	$\frac{1}{2}$	$\frac{1}{2}$	0	0	$\frac{1}{2}$	$-\frac{1}{2}$	$-\frac{1}{2}$	$\frac{1}{2}$
Model C	$\frac{1}{4}$	$-\frac{1}{2}$	$-\frac{1}{8}$	$\frac{3}{8}$	0	$\frac{3}{4}$	$\frac{3}{8}$	$-\frac{9}{8}$
Model D	$\frac{1}{2}$	0	$\frac{1}{4}$	$-\frac{3}{4}$	-1	$-\frac{1}{2}$	$\frac{1}{4}$	$\frac{5}{4}$
Model E	0	$\frac{1}{2}$	$\frac{1}{4}$	$-\frac{3}{4}$	$-\frac{1}{2}$	-1	$-\frac{1}{4}$	$\frac{7}{4}$
Model F	$\frac{2}{3}$	$\frac{1}{3}$	$\frac{1}{2}$	$-\frac{3}{2}$	$-\frac{5}{3}$	$-\frac{4}{3}$	$\frac{1}{6}$	$\frac{17}{6}$
Model G	$-\frac{1}{6}$	$\frac{1}{3}$	$\frac{1}{12}$	$-\frac{1}{4}$	0	$-\frac{1}{2}$	$-\frac{1}{4}$	$\frac{3}{4}$
Model $B-L$	$\frac{1}{6}$	$\frac{1}{6}$	$\frac{1}{6}$	$-\frac{1}{2}$	$-\frac{1}{2}$	$-\frac{1}{2}$	0	1

Table I. Dark quantum charges of the fields under  $U(1)_D$ , adapted from ref. [61].

The comprehensive discussion of the scalar sector and the anomaly cancellation mechanisms of the model can be found in [61]. Certain relevant parts will be reiterated here.

For instance, the dark charge assignments of the SM fields that satisfy the anomaly conditions are provided in Table I. Since the original gauge basis in the neutral sector, i.e.,  $(Y_\mu, W_{3\mu}, X_\mu^0)$ , is not diagonal, the physical basis, denoted as  $(A_\mu, Z_\mu, A'_\mu)$ , can be derived through three successive rotations [60]. After performing the rotations, one can finally obtain eigenvalues corresponding to the mass squares of the photon ( $A_\mu$ ), the dark photon ( $A'_\mu$ ), and the electroweak neutral boson ( $Z_\mu$ ), respectively:

$$M_A^2 = 0, \quad (2)$$

$$M_{A'}^2 = m_X^2 \cos^2 \xi \sec^2 \epsilon + \frac{1}{4} g_D^2 v^2 \cos^2 \xi \sec^2 \epsilon \left[ \cos^2 \beta \left( Q_D^{\phi_1} \right)^2 + \sin^2 \beta \left( Q_D^{\phi_2} \right)^2 \right] \\ + g_D v m_{Z_0} \cos \xi \sec \epsilon \left( \cos^2 \beta Q_D^{\phi_1} + \sin^2 \beta Q_D^{\phi_2} \right) (\sin \xi - \cos \xi \sin \theta_W \tan \epsilon) \\ + m_{Z_0}^2 (\sin \xi - \cos \xi \sin \theta_W \tan \epsilon)^2, \quad (3)$$

$$M_Z^2 = m_X^2 \sin^2 \xi \sec^2 \epsilon + \frac{1}{4} g_D^2 v^2 \sin^2 \xi \sec^2 \epsilon \left[ \cos^2 \beta \left( Q_D^{\phi_1} \right)^2 + \sin^2 \beta \left( Q_D^{\phi_2} \right)^2 \right] \\ - g_D v m_{Z_0} \sin \xi \sec \epsilon \left( \cos^2 \beta Q_D^{\phi_1} + \sin^2 \beta Q_D^{\phi_2} \right) (\cos \xi + \sin \xi \sin \theta_W \tan \epsilon) \\ + m_{Z_0}^2 (\cos \xi + \sin \xi \sin \theta_W \tan \epsilon)^2. \quad (4)$$

### III. $B \rightarrow K^{(*)} \nu \bar{\nu}$ DECAY IN $U(1)_D$ -EXTENDED 2HDM

After describing the necessary ingredients of the theoretical framework in the previous section, we now delve into the details of the matrix element for the  $b \rightarrow s \nu \bar{\nu}$  transition within the  $U(1)_D$ -extended two-Higgs-doublet model. For convenience, we give a list of the vertex factors for fermion-fermion- $Z/A'$  interactions that are relevant to the  $B \rightarrow K^{(*)} \nu \bar{\nu}$  decays in Table II, according to the parameterization given by the following Lagrangian terms

$$\mathcal{L} \supset \bar{f} (C_V^f \gamma^\mu + C_A^f \gamma^\mu \gamma^5) f Z_\mu + \bar{f} (C_V^f \gamma^\mu + C_A^f \gamma^\mu \gamma^5) f A'_\mu. \quad (5)$$

The vertex factors of the models, namely Model A, B, C, D, E, F, G, and  $B-L$  (listed in Table I), can be read off from the entries in Table II by plugging the values of the corresponding charges  $Q'_u$  and  $Q'_d$ , given in Table I. By taking the appropriate limiting values,  $Q'_{u,d} \rightarrow 0$  and  $\epsilon \rightarrow 0$  ( $\xi \rightarrow 0$ ), the vertex factors in Table II can be reduced to their SM forms. In this limit, it is clear that all dark photon vertices vanish, as expected.

The  $b \rightarrow s$  transition happens at one-loop level, receiving contributions from the so-called self-energy diagrams, triangle diagrams involving  $Z$  and dark photon exchanges, as

Vertices	$C_V^f$	$C_A^f$
	$-\frac{g_D s_\xi (7Q'_d + 5Q'_u)}{8c_\epsilon} + \frac{e(c_\xi + s_\xi t_\epsilon s_W)}{4c_W s_W}$	$-\frac{g_D s_\xi (Q'_d - Q'_u)}{8c_\epsilon} - \frac{e(c_\xi + s_\xi t_\epsilon s_W)}{4c_W s_W}$
	$\frac{g_D s_\xi (Q'_d + 3Q'_u)}{8c_\epsilon} - \frac{ec_\xi (8s_W^2 - 3) + 5es_\xi t_\epsilon s_W}{12c_W s_W}$	$-\frac{g_D s_\xi (Q'_d - Q'_u)}{8c_\epsilon} - \frac{e(c_\xi + s_\xi t_\epsilon s_W)}{4c_W s_W}$
	$\frac{g_D s_\xi (3Q'_d + Q'_u)}{8c_\epsilon} + \frac{ec_\xi (4s_W^2 - 3) + es_\xi t_\epsilon s_W}{12c_W s_W}$	$\frac{g_D s_\xi (Q'_d - Q'_u)}{8c_\epsilon} + \frac{e(c_\xi + s_\xi t_\epsilon s_W)}{4c_W s_W}$
	$C_V^{f'}$	$C_A^{f'}$
	$-\frac{g_D c_\xi (7Q'_d + 5Q'_u)}{8c_\epsilon} - \frac{e(s_\xi - c_\xi t_\epsilon s_W)}{4c_W s_W}$	$-\frac{g_D c_\xi (Q'_d - Q'_u)}{8c_\epsilon} + \frac{e(s_\xi - c_\xi t_\epsilon s_W)}{4c_W s_W}$
	$\frac{g_D c_\xi (Q'_d + 3Q'_u)}{8c_\epsilon} + \frac{es_\xi (8s_W^2 - 3) - 5ec_\xi t_\epsilon s_W}{12c_W s_W}$	$-\frac{g_D c_\xi (Q'_d - Q'_u)}{8c_\epsilon} + \frac{e(s_\xi - c_\xi t_\epsilon s_W)}{4c_W s_W}$
	$\frac{g_D c_\xi (3Q'_d + Q'_u)}{8c_\epsilon} - \frac{es_\xi (4s_W^2 - 3) - ec_\xi t_\epsilon s_W}{12c_W s_W}$	$\frac{g_D c_\xi (Q'_d - Q'_u)}{8c_\epsilon} - \frac{e(s_\xi - c_\xi t_\epsilon s_W)}{4c_W s_W}$

Table II. The relevant fermion-fermion- $Z/A'$  vertex factors for  $B \rightarrow K^{(*)} \nu \bar{\nu}$  decays in the Two-Higgs Doublet Models extended with a dark  $U(1)_D$  group. A shorthand notation is used for the trigonometric expressions. For example,  $(s_\xi, t_\epsilon)$  stand for  $(\sin \xi, \tan \epsilon)$  and similar for the others.

well as box diagrams. At this point, two key observations are worth noting: (a) The model introduces right-handed neutrino currents, and (b) neither  $Z$  nor the dark photon contributes to the box diagrams. The contribution from diagrams involving  $Z$ -boson exchange can be expressed as

$$\mathcal{M}_Z = \frac{V_{tb} V_{ts}^* G_F \alpha_{em} m_W^2}{2\sqrt{2}\pi m_Z^2} (C_{LL}^Z \mathcal{O}_{LL} + C_{LR}^Z \mathcal{O}_{LR}), \quad (6)$$

while the matrix element for dark photon exchange takes the form

$$\mathcal{M}_{A'} = \frac{V_{tb} V_{ts}^* G_F \alpha_{em} m_W^2}{2\sqrt{2}\pi (m_{A'}^2 - q^2)} (C_{LL}^{A'} \mathcal{O}_{LL} + C_{LR}^{A'} \mathcal{O}_{LR}). \quad (7)$$

Here, the coefficients are defined as

$$C_{LL(R)}^Z = C_{LL(R)}^{TZ} + C_{LL(R)}^{SZ}, \quad (8)$$



$$C_{LL(R)}^{A'} = C_{LL(R)}^{TA'} + C_{LL(R)}^{SA'}, \quad (9)$$

where the superscripts  $T$  and  $S$  denote contributions from triangle and self-energy diagrams, respectively. Lastly, the matrix element for the box diagrams can be expressed as

$$\mathcal{M}^{\text{Box}} = \frac{V_{tb}V_{ts}^* G_F \alpha_{em} m_W^2}{2\sqrt{2}\pi} C_{LL}^{\text{Box}} \mathcal{O}_{LL} \quad (10)$$

Explicit expressions for these  $C$  coefficients are provided in Appendix A. The operators  $\mathcal{O}_{LL}$  and  $\mathcal{O}_{LR}$  correspond to the local ones

$$\begin{aligned} \mathcal{O}_{LL} &= \bar{s}\gamma_\mu(1 - \gamma_5)b \bar{\nu}\gamma_\mu(1 - \gamma_5)\nu, \\ \mathcal{O}_{LR} &= \bar{s}\gamma_\mu(1 - \gamma_5)b \bar{\nu}\gamma_\mu(1 + \gamma_5)\nu. \end{aligned}$$

Using the contributions at the quark level given in Eqs. (6), (7) and 10, the hadronic matrix element for the  $B \rightarrow K^{(*)}\nu\bar{\nu}$  decays can be calculated by sandwiching the quark current between the initial  $B$  meson and the final  $K^{(*)}$  meson states. The hadronic matrix elements appearing in  $B \rightarrow K^{(*)}\nu\bar{\nu}$  decays are parametrized in terms of form factors which are further classified as scalar, psudoscalar, vector, and axial vector.

The matrix elements for the  $B \rightarrow K^{(*)}$  transitions are

$$\begin{aligned} \langle K(p_K) | \bar{s}\gamma_\mu b | B(p_B) \rangle &= \left[ (p_B + p_K)_\mu - \frac{m_B^2 - m_K^2}{q^2} q_\mu \right] f_+(q^2) + \frac{m_B^2 - m_K^2}{q^2} q_\mu f_0(q^2), \\ \langle K^*(p_{K^*}, \varepsilon) | \bar{s}\gamma_\mu b | B(p_B) \rangle &= \epsilon_{\mu\nu\rho\sigma} \varepsilon^{*\nu} p_B^\rho p_{K^*}^\sigma \frac{2V(q^2)}{m_B + m_{K^*}}, \\ \langle K^*(p_{K^*}, \varepsilon) | \bar{s}\gamma_\mu \gamma_5 b | B(p_B) \rangle &= i\varepsilon^{*\nu} \left[ \eta_{\mu\nu} (m_B + m_{K^*}) A_1(q^2) - \frac{(p_B + p_{K^*})_\mu q_\nu}{m_B + m_{K^*}} A_2(q^2) \right. \\ &\quad \left. - q_\mu q_\nu \frac{2m_{K^*}}{q^2} (A_3(q^2) - A_0(q^2)) \right] \end{aligned}$$

where the scalar and vector form factors for the  $B \rightarrow K$  transition are  $f_0(q^2)$  and  $f_+(q^2)$  while the vector and axial form factors for  $B \rightarrow K^*$  are  $A_0(q^2)$ ,  $A_1(q^2)$ ,  $A_2(q^2)$ ,  $A_3(q^2)$ , and  $V(q^2)$ . Among these,  $f_0$ ,  $A_0$  and  $A_3$  do not contribute to  $B \rightarrow K^{(*)}\nu\bar{\nu}$  decays due to having negligible neutrino masses. The remaining set of form factors can be chosen as  $(f_+, A_1, A_{12}, V)$  after employing the following relation

$$A_2 = -\frac{(m_B + m_{K^*}) [A_1(m_B + m_{K^*}) (-m_B^2 + m_{K^*}^2 + q^2) + 16A_{12}m_B m_{K^*}^2]}{m_B^4 - 2m_B^2 (m_{K^*}^2 + q^2) + (m_{K^*}^2 - q^2)^2} \quad (11)$$

The differential decay widths for the exclusive decays  $B \rightarrow K\nu\bar{\nu}$  and  $B \rightarrow K^*\nu\bar{\nu}$  can be cast into the following compact forms:

$$\frac{d\Gamma(B \rightarrow K\nu\bar{\nu})}{dq^2} = \frac{1}{512\pi^3 m_B^3} f_+^2(q^2) (C_{LL}^2 + C_{LR}^2) \lambda^{3/2}, \quad (12)$$

$$\begin{aligned} \frac{d\Gamma(B \rightarrow K^*\nu\bar{\nu})}{dq^2} &= \frac{\lambda^{1/2} (C_{LL}^2 + C_{LR}^2)}{256\pi^3 m_B^3 (m_B + m_{K^*})^2} [\lambda q^2 V^2 + A_1^2 q^2 (m_B + m_{K^*})^4 \\ &\quad + 32A_{12}^2 m_B^2 m_{K^*}^2 (m_B + m_{K^*})^2], \end{aligned} \quad (13)$$

where  $\lambda(m_B^2, m_{K^*}^2, q^2) = m_B^4 + m_{K^*}^4 + q^4 - 2m_B^2 m_{K^*}^2 - 2m_B^2 q^2 - 2m_{K^*}^2 q^2$ , and

$$C_{LL(R)} = \frac{V_{tb} V_{ts}^* G_F \alpha_{em} m_W^2}{2\sqrt{2}\pi} \left( \frac{C_{LL(R)}^Z}{m_Z^2} + \frac{C_{LL(R)}^{A'}}{m_{A'}^2 - q^2} \right). \quad (14)$$

Here  $q^2 = (p_B - p_{K^*})^2$  and the explicit forms of the coefficients  $C_{LL(R)}^Z$  and  $C_{LL(R)}^{A'}$  are given in Appendix A. In the numerical study we demonstrate that treating the resonant production of the dark photon properly plays very important role to enhance the new physics effects in  $\text{Br}(B \rightarrow K^{(*)}\nu\bar{\nu})$ . The width effects can be placed with the use of the Breit–Wigner formula:

$$\frac{1}{q^2 - m_{A'}^2} \rightarrow \frac{1}{q^2 - m_{A'}^2 + i\Gamma_{A'} m_{A'}}, \quad (15)$$

where  $\Gamma_{A'}$  denotes the decay width of the dark photon into the relevant fermion pairs.

In the numerical analysis of both decays, the following  $z$ -parameterizations for the form factors ( $f_+, F_i = A_1, A_{12}, V$ ) are employed [8, 69]:

$$\begin{aligned} f_+(q^2) &= P_+(q^2) \sum_{k=0}^{N-1} a_k^+ \left[ z(q^2)^k - (-1)^{k-N} \frac{k}{N} z(q^2)^N \right], \\ F_i(q^2) &= P_i(q^2) \sum_k a_k^i [z(q^2) - z(0)]^k \end{aligned} \quad (16)$$

Here  $P_{i,+}(q^2) = (1 - q^2/M_{i,+}^2)^{-1}$  with  $M_+ = 5.4154$  GeV and the other mass parameters are

$$M_i = \begin{cases} 5.415 \text{ GeV} & F_i = V \\ 5.829 \text{ GeV} & F_i = A_1, A_{12}. \end{cases}$$

The  $z$ -function is defined

$$z(q^2) = \frac{\sqrt{t_+ - q^2} - \sqrt{t_+ - t_0}}{\sqrt{t_+ - q^2} + \sqrt{t_+ - t_0}} \quad (17)$$

where  $t_{\pm} = (m_B \pm m_{K^*})^2$  and  $t_0 = t_+ \left[ 1 - (1 - t_-/t_+)^{\frac{1}{2}} \right]$ . Lastly, the fit parameters  $a_k^{+,i}$  are used from Refs. [8] and [69].

#### IV. NUMERICAL ANALYSIS OF $B \rightarrow K^{(*)}\nu\bar{\nu}$

In light of the analytical calculations presented in the previous section, a numerical analysis is required to examine the selected models at the given sample points. More importantly, we need to explore the parameter space to determine whether there exist scenarios that simultaneously accommodate the  $\text{Br}(B \rightarrow K\nu\bar{\nu})$  [18] and  $\text{Br}(B \rightarrow K^*\nu\bar{\nu})$  [16] data from the Belle collaboration.

The model primarily includes the following five parameters:  $\tilde{Q}_R^u \equiv g_D Q'_u$ ,  $\tilde{Q}_R^d \equiv g_D Q'_d$ ,  $\sin \epsilon$ ,  $\tan \beta$ , and  $M_{A'}$ . At this point, we can make the observation that, since the gauge coupling  $g_D$  and the independent charges of the model ( $Q'_u$  and  $Q'_d$ ) enter the vertex factors and other relevant terms via the covariant derivative as a product, the above new parameters have been defined accordingly. The  $\tilde{Q}$  parameters can, in principle, be large, provided that they do not exceed the perturbative limit. However, in that regime, a light dark photon mass cannot be obtained, leading to no deviation from the Standard Model predictions for the  $B \rightarrow K\nu\bar{\nu}$  and  $B \rightarrow K^*\nu\bar{\nu}$  decays.

Another and perhaps the most important observation obtained from our analysis is that when performing the  $q^2$  integral, encountering the kinematic situation where  $q^2$  equals the mass of the dark photon allows the modification of the dark photon propagator in the relevant diagrams to incorporate the width effects. This modification enables deviations above the Standard Model values and, in particular, allows the explanation of the Belle data for the  $B \rightarrow K\nu\bar{\nu}$  decay.

The variation of the branching ratio of the  $B \rightarrow K\nu\bar{\nu}$  decay with respect to the mass of the dark photon mass is presented in Fig. 1. There is a lower limit on the mass of the dark photon, which can be determined by setting  $m_X$  to zero once a set of input values are chosen for the other parameters. For example, for the input values given in Fig. 1, the minimum value of mass that the dark photon can have is close to 70 MeV. In this calculation, it is also necessary to determine the decay width of the dark photon,  $\Gamma_{A'}$ , by incorporating new channels as the mass varies. The effects of these new channels can be seen in Fig. 1. On the other hand, it should be noted that the results presented here do not exhibit significant sensitivity to the parameters  $\sin \epsilon$  and  $\tan \beta$ .

Deviations from the Standard Model start to appear when the dark photon mass is around 5 GeV, and the results become compatible with Belle II data when the mass is approximately

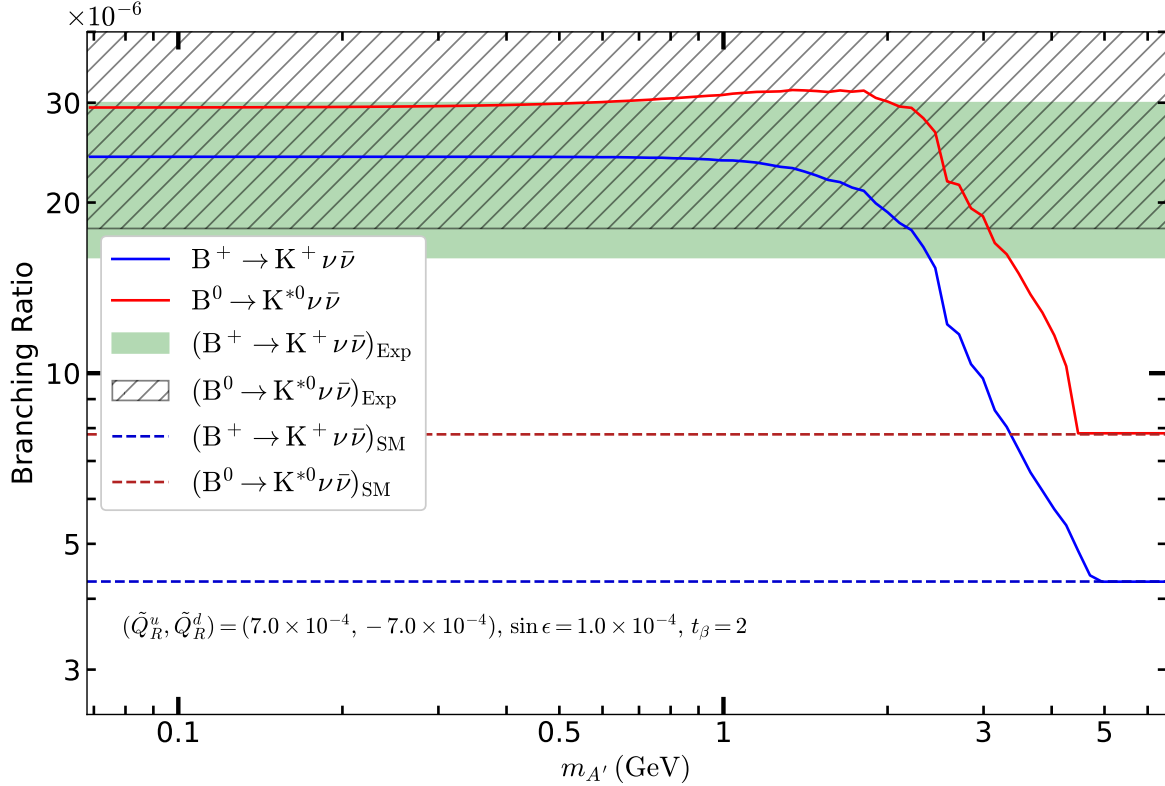

Figure 1. The branching ratios of  $B \rightarrow K^{(*)}\nu\bar{\nu}$  decays as a function of dark photon mass  $m_{A'}$  for representative values of the input variables. Belle II measurement [18] of  $\text{Br}(B^+ \rightarrow K^+\nu\bar{\nu})$  is displayed in green band while the exclusion region by  $\text{Br}(B^0 \rightarrow K^{*0}\nu\bar{\nu})$  from Belle data [16] is hatched. The SM values of both decays are also indicated in the figure.

2 GeV. However, when the mass drops below 1 GeV, the dependence on mass disappears. A similar behavior is observed for the  $B \rightarrow K^*\nu\bar{\nu}$  decay. Although the mass dependence occurs at a slightly lower value compared to the  $B \rightarrow K\nu\bar{\nu}$  decay, the branching ratio exceeds the experimental upper limit at around 3 GeV. Consequently, under the chosen input values there is no common parameter space that simultaneously satisfies both results.

In Fig. 2, we investigated whether a common solution region exists. The left panel shows that a common solution is only possible in the 4–5 GeV range and how the allowed region shrinks as the parameters vary. In the right panel, the parameter values that yield the largest possible region are given, and the common region has been scanned. As can be seen, the common solution region is quite small, but it is still possible to explain both sets of data. There is one important feature that needs to be noted here. Even if no excess events can be reported for  $B \rightarrow K^*\nu\bar{\nu}$  and the current upper limit decreases further, potentially even

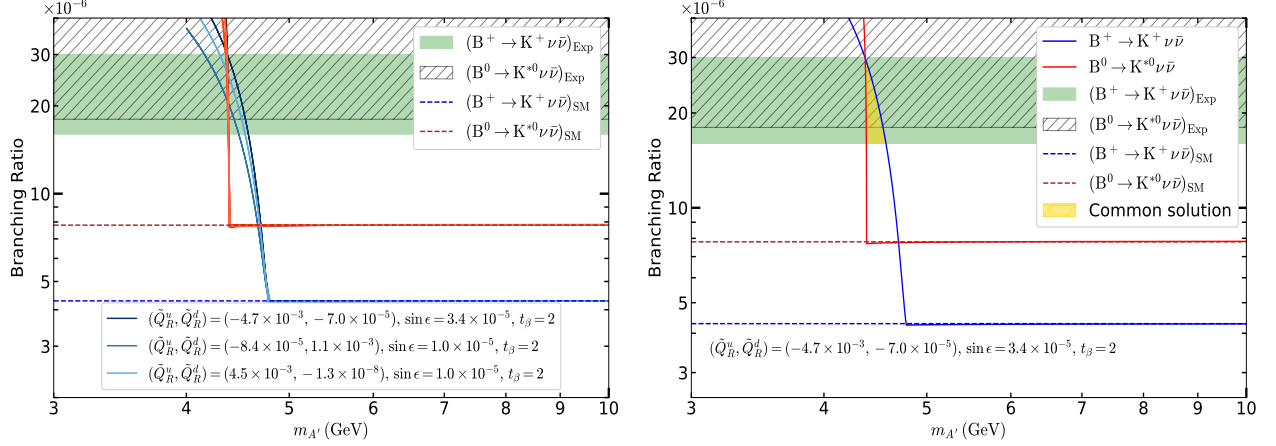

Figure 2. The branching ratios of  $B \rightarrow K^{(*)}\nu\bar{\nu}$  decays as a function of dark photon mass  $m_{A'}$  for three different values of the input variables (left panel) and for a scenario with a maximized allowed region (right panel). The Belle II measurement [18] of  $\text{Br}(B^+ \rightarrow K^+ \nu \bar{\nu})$  is displayed in green band while hatched region as the exclusion region determined by the upper bound of  $\text{Br}(B^0 \rightarrow K^0 \nu \bar{\nu})$  from Belle data [16]. The SM values of both decays are also indicated in figures. In the right panel, a maximized common solution region is highlighted.

reaching the SM value, the outcomes we have derived here will remain unaffected.

If we want to visualize the allowed regions from the  $\text{Br}(B \rightarrow K\nu\bar{\nu})$  measurement along with the excluded regions from the  $\text{Br}(B \rightarrow K^*\nu\bar{\nu})$  data in the  $(\tilde{Q}_R^d, \tilde{Q}_R^u)$  plane, we obtain Fig. 3. As seen in the figure, for the selected input values, there exists a narrow green-shaded region favored by  $\text{Br}(B \rightarrow K\nu\bar{\nu})$ , while the excluded region from  $\text{Br}(B \rightarrow K^*\nu\bar{\nu})$  does not overlap with it. To illustrate the new physics models selected as representative points in such a parameter space, we need to specify a value for  $g_D$ . As an example, we consider  $g_D = 5 \times 10^{-4}$  and  $g_D = 5 \times 10^{-3}$ . Particularly, for  $g_D = 5 \times 10^{-3}$ , some models lie within the green region, whereas for smaller values of  $g_D$ , all models can be excluded. We believe that the  $\text{Br}(B \rightarrow K^{(*)}\nu\bar{\nu})$  data significantly constrain the new physics parameter space and can play a decisive role in distinguishing between possible scenarios.

Finally, we generated a scatter plot in the  $B \rightarrow K\nu\bar{\nu}$  versus  $B \rightarrow K^*\nu\bar{\nu}$  plane. The following parameter ranges were considered:

$$\begin{aligned}
10^{-3} < \left| \tilde{Q}_R^{u,d} \right| < 10^3, & \quad 10^{-6} < \sin \epsilon < 10^{-2}, \\
1 < \tan \beta < 60, & \quad 10 \text{ MeV} < m_{A'} < 10 \text{ GeV}.
\end{aligned} \tag{18}$$

Under these conditions, Fig. 4 was obtained and as can be seen from the figure, neither

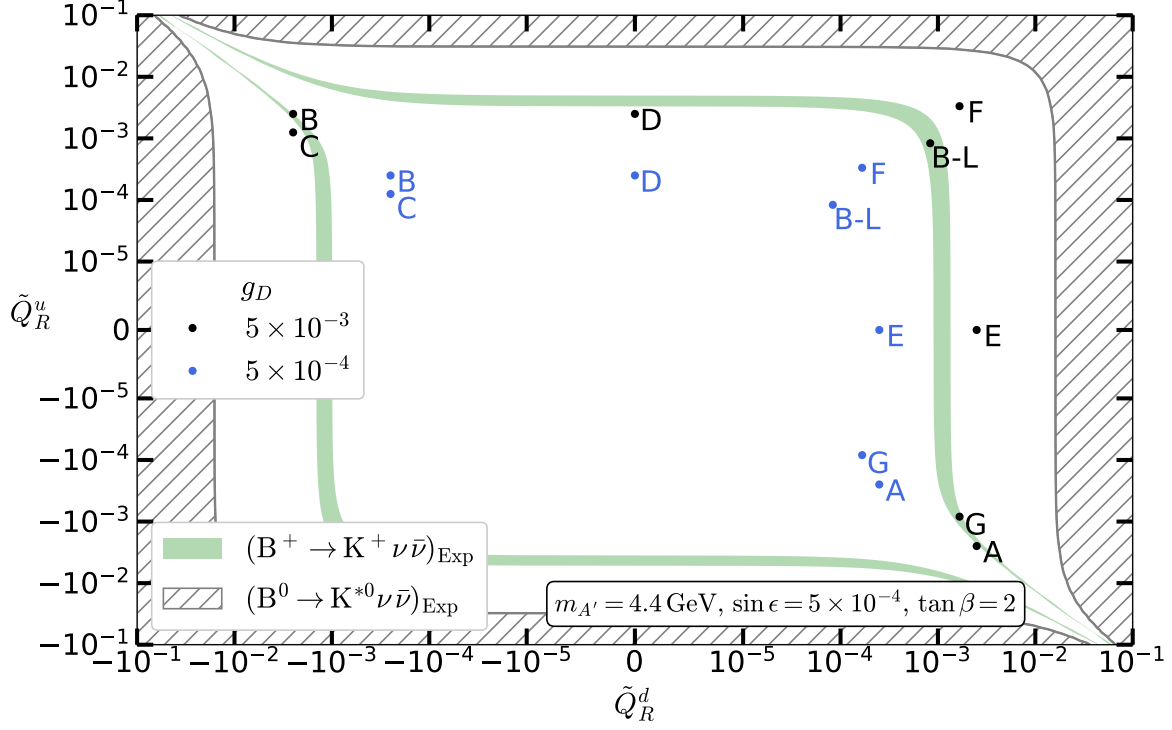

Figure 3. The Belle II measurement [18] of  $\text{Br}(B^+ \rightarrow K^+ \nu \bar{\nu})$  (thin green shaded area) and Belle data [16] for  $\text{Br}(B^0 \rightarrow K^{*0} \nu \bar{\nu})$  (gray hatched region for exclusion) are shown in the  $(\tilde{Q}_R^d, \tilde{Q}_R^u)$  plane for the favored dark photon mass. Points representing the models listed in Table I are marked for two different  $g_D$  values.

red nor blue points can enter the allowed region of  $B \rightarrow K \nu \bar{\nu}$  without going through the excluded region of  $B \rightarrow K^* \nu \bar{\nu}$ . Only the green points satisfy both conditions, indicating that the allowed mass range is  $4.3 \text{ GeV} < m_{A'} < 4.9 \text{ GeV}$  since the red (blue) points represent a scenario with  $m_{A'} \geq 4.9 \text{ GeV}$  ( $m_{A'} \leq 4.3 \text{ GeV}$ ). These results depend particularly on the values and signs of  $\tilde{Q}_R^u$  and  $\tilde{Q}_R^d$ . In the figure, scenarios with both  $\tilde{Q}_R^d$  and  $\tilde{Q}_R^u$  positive are encoded with light green points while the darker ones represent negative case for both of them. Parameters with opposite signs are indicated in dark green color. The green points that appear parallel to the  $B \rightarrow K \nu \bar{\nu}$  axis correspond to the region where the branching ratio of  $B \rightarrow K^* \nu \bar{\nu}$  is not yet affected by the dark photon, while the branching ratio of  $B \rightarrow K \nu \bar{\nu}$  increases rapidly. This region is also indicated in Fig. 2. Even though the overall solution space satisfying both constraints is rather small, it is seen that, out of 50,000 points generated under the conditions described above, relatively quite number of them fall into the desired region.

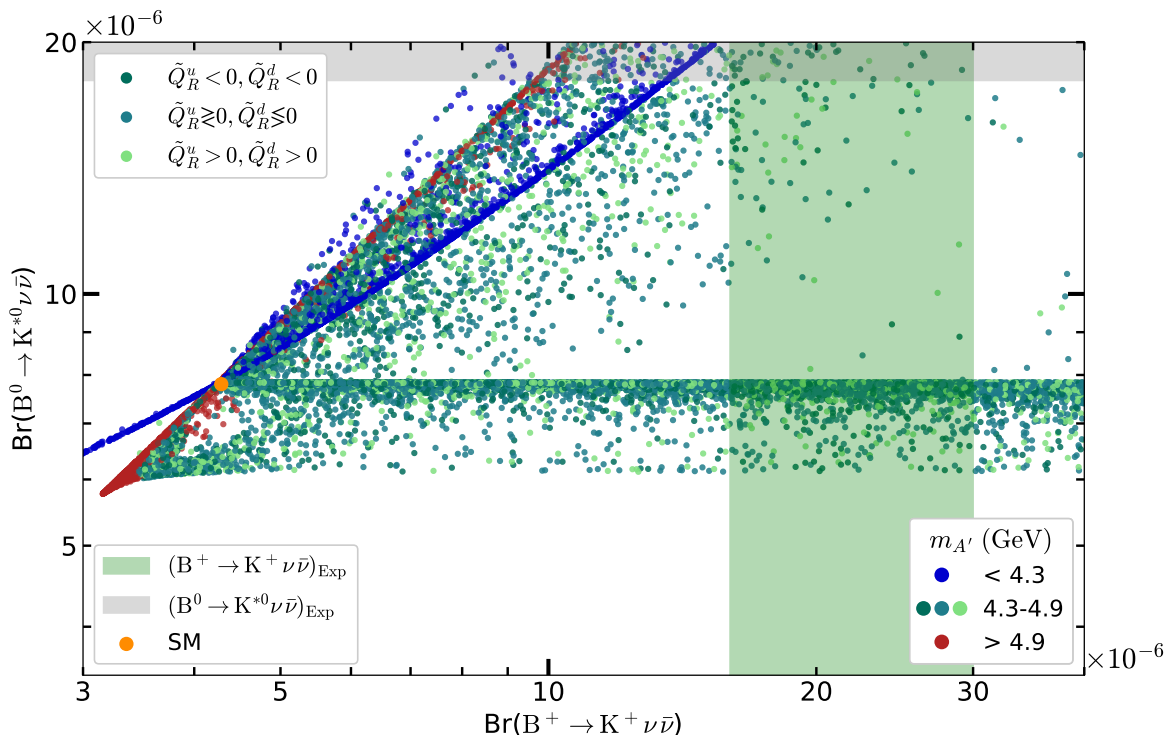

Figure 4. Scatter plot in  $(\text{Br}(B^+ \rightarrow K^+ \nu \bar{\nu}), \text{Br}(B \rightarrow K^* \nu \bar{\nu}))$  plane for various sign conventions of  $(\tilde{Q}_R^d, \tilde{Q}_R^u)$ . The red points represent a scenario with  $m_{A'} \geq 4.9$  GeV while the blue ones for  $m_{A'} \leq 4.3$  GeV. The remaining green dots (varying tones encoded with changing signs of  $(\tilde{Q}_R^d, \tilde{Q}_R^u)$  parameters) represent  $4.3 \text{ GeV} < m_{A'} < 4.9$  GeV.

## V. CONCLUSION

The recent Belle II measurement on rare  $B$  decay  $B^+ \rightarrow K^+ \nu \bar{\nu}$  showed a  $2.7\sigma$  deviation from the SM value, which can be seen a fertile ground for searching new physics. The Belle collaboration has additionally data on another rare  $B$  meson channel, namely  $B^0 \rightarrow K^{*0} \nu \bar{\nu}$ , and setting an upper bound  $1.8 \times 10^{-5}$  for the branching ratios of the decay. To test whether a new physics scenario in the form of a two-Higgs-Doublet Model extended in the gauge sector with an abelian dark gauge group  $U(1)_D$  would account for the discrepancy mentioned above as well as satisfying the exclusion bound for  $B^0 \rightarrow K^{*0} \nu \bar{\nu}$  decay. Both processes happen at one loop level whose Feynman diagrams can be classified as self-energy, triangle and box. The dark photon contributes only to self-energy and triangle diagrams. The matrix element of each diagram has been computed and expressed in terms of the Passarino-Veltman functions in Appendix A in the vanishing limit of the masses and momenta of the external particles. We have made extensive checks on our results to make sure that the total matrix element

is UV finite. Our analytical findings are further manipulated to carry loop integrals which could be tricky under the limit employed so that a comparison with the results available in the literature. We found full agreement in the Standard Model limit with the results given in [70–72].

Let us stress the following point one more time. The first important observation we have made is that the discrepancy between the Belle II data and the SM prediction for the decay  $B^+ \rightarrow K^+ \nu \bar{\nu}$  would not be elucidated by the existence of a dark photon unless the resonant contributions around  $q^2 = m_A^2$  are taken into account. Far from the resonance region, the dark photon contribution becomes much less significant and no deviation would be obtained from the SM values of both channels.

Even though satisfying either bound individually is rather easy to achieve strictly after the resonant contributions are manifested in the analytical level, finding a common parameter space which is good for both requires some further analysis. Our numerical study showed that while the exclusion data of  $B^0 \rightarrow K^{*0} \nu \bar{\nu}$  prefers a heavier dark photon scenario,  $B^+ \rightarrow K^+ \nu \bar{\nu}$  measurement would indicate very light dark photon options which can get as heavy as few GeV. The task is to seek for a common mass region which lays in the overlapped portion of the parameter space. As shown in the figures, for reasonable values of the other parameters of the model  $(\tilde{Q}_R^u, \tilde{Q}_R^d, \sin \epsilon, \tan \beta)$ , a dark photon with a 4–5 GeV mass would explain both. Even though the sensitivity of our results is not much affected by the parameters  $\sin \epsilon$  or  $\tan \beta$ , the values of the other two parameters  $\tilde{Q}_R^u$  and  $\tilde{Q}_R^d$  are playing more essential role. On the other hand, our scatter plot would prove that the overlapping region for the mass of the dark photon does not shift much and remains in the 4–5 GeV range. Another important feature seen from the figures that even if no excess can be reported for the  $\text{Br}(B^0 \rightarrow K^{*0} \nu \bar{\nu})$  channel and the existing upper limit value decreases further, even dropping to the SM value, the results we have obtained here will not be affected by this. Current bounds already pin down the allowed range of the dark photon mass in particular and future improvements to reduce the errors further in the  $B^+ \rightarrow K^+ \nu \bar{\nu}$  decay will tighten up the allowed region more and will determine whether a common solution would still be possible or not.



## ACKNOWLEDGMENTS

This study was supported by Scientific and Technological Research Council of Turkey (TUBITAK) under the Grant Number 124F237. The authors thank to TUBITAK for their supports.

### Appendix A: Explicit Expressions of the Coefficients for $C_{LL}$ and $C_{LR}$

In this Appendix we present the explicit expressions of the coefficients  $C_{LL}$  and  $C_{LR}$  computed from the triangle, self energy and box diagrams<sup>1</sup>. Before presenting these expressions for customary we introduce following short handed notations:

$$\begin{aligned}
 x &= m_t^2/m_W^2, \quad y = m_e^2/m_W^2, \quad g_D^e = g_D/e, \\
 \begin{bmatrix} C_L^\nu \\ C_L^{\nu'} \end{bmatrix} &= \frac{1}{4} \begin{bmatrix} \sin \xi \\ \cos \xi \end{bmatrix} (2 \tan \epsilon \sec \theta_w - 3g_D^e(Q_d^R + Q_u^R) \sec \epsilon) + \begin{bmatrix} \cos \xi \\ -\sin \xi \end{bmatrix} \csc 2\theta_w, \\
 \begin{bmatrix} C_R^\nu \\ C_R^{\nu'} \end{bmatrix} &= \frac{1}{2} g_D^e \begin{bmatrix} \sin \xi \\ \cos \xi \end{bmatrix} (2Q_d^R + Q_u^R) \sec \epsilon, \\
 \begin{bmatrix} C_L^u \\ C_L^d \end{bmatrix} &= \frac{1}{12} [\sin \xi (3g_D^e(Q_d^R + Q_u^R) \sec \epsilon - 2 \tan \epsilon \sec \theta_w) + \cos \xi (\pm 6 \cot \theta_w - 2 \tan \theta_w)], \\
 \begin{bmatrix} C_R^u \\ C_R^d \end{bmatrix} &= \frac{1}{6} \left( 3g_D^e \begin{bmatrix} Q_u^R \\ Q_d^R \end{bmatrix} \sin \xi \sec \epsilon + \begin{bmatrix} -4 \\ 2 \end{bmatrix} (\cos \xi \tan \theta_w + \sin \xi \tan \epsilon \sec \theta_w) \right), \\
 \begin{bmatrix} C_L^{ru} \\ C_L^{rd} \end{bmatrix} &= \frac{1}{12} [\cos \xi (3g_D^e(Q_d^R + Q_u^R) \sec \epsilon - 2 \tan \epsilon \sec \theta_w) + \sin \xi (\mp 6 \cot \theta_w + 2 \tan \theta_w)], \\
 \begin{bmatrix} C_R^{ru} \\ C_R^{rd} \end{bmatrix} &= \frac{1}{6} \left( 3g_D^e \begin{bmatrix} Q_u^R \\ Q_d^R \end{bmatrix} \cos \xi \sec \epsilon + \begin{bmatrix} -4 \\ 2 \end{bmatrix} (-\sin \xi \tan \theta_w + \cos \xi \tan \epsilon \sec \theta_w) \right), \\
 \begin{bmatrix} G^{WGZ} \\ G^{WGA'} \end{bmatrix} &= \sin \beta \csc \theta_w \left( \begin{bmatrix} \sin \xi \\ -\cos \xi \end{bmatrix} (g_D^e(Q_d^R - Q_u^R) \sec \epsilon + 2 \tan \epsilon \sec \theta_w) + 2 \begin{bmatrix} \cos \xi \\ \sin \xi \end{bmatrix} \tan \theta_w \right), \\
 \begin{bmatrix} G^{GGZ} \\ G^{GGA'} \end{bmatrix} &= \frac{1}{4} \begin{bmatrix} \sin \xi \\ \cos \xi \end{bmatrix} (g_D^e(Q_d^R - Q_u^R) \sec \epsilon + 2 \tan \epsilon \sec \theta_w) + \frac{1}{2} \begin{bmatrix} \cos \xi \\ -\sin \xi \end{bmatrix} (1 - \cot^2 \theta_w).
 \end{aligned}$$

<sup>1</sup> After computing each diagram, we checked the SM limits, whenever relevant, and found agreement with the results available in the literature. Additionally, the  $UV$  finiteness of the overall result has been confirmed after especially the factor of 1/2 taken into account [70].

## 1. Triangle Z Diagrams

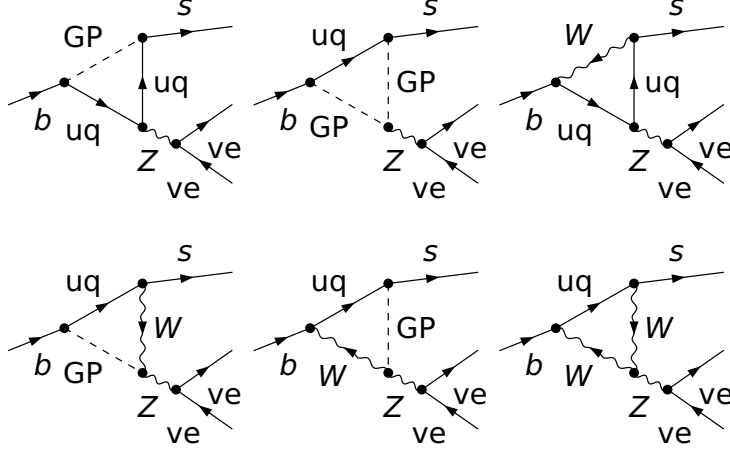

Figure 5. Triangle  $Z$  diagrams relevant for  $b \rightarrow s\nu\bar{\nu}$ . Only one neutrino generation is shown.

Total result obtained from the triangle diagrams in Fig. 5 for the  $Z$  boson exchange<sup>2</sup> is

$$\mathcal{M}_Z^{\text{Tri}} = \frac{V_{tb}V_{ts}^*G_F\alpha_{em}m_W^2}{2\sqrt{2}\pi(m_Z^2 - q^2)} (C_{LL}^{TZ}\mathcal{O}_{LL} + C_{LR}^{TZ}\mathcal{O}_{LR}) \quad (\text{A1})$$

where

$$\begin{aligned} C_{LL}^{TZ} = C_L^\nu \left\{ \right. & \left[ + C_0(0, 0, 0; m_W^2, m_W^2, m_W^2)4m_W^2 \cos \xi \cot \theta_W \right. \\ & - C_0(0, 0, 0; m_W^2, m_t^2, m_t^2)2m_t^2 (C_L^u x + 2C_R^u) \\ & - C_0(0, 0, 0; m_t^2, m_W^2, m_W^2)\frac{2m_t^2}{\pi} (G^{WGZ} \sin \theta_W + 2\pi \cos \xi \cot \theta_W) \\ & - C_{00}(0, 0, 0; m_W^2, m_W^2, m_W^2)16 \cos \xi \cot \theta_W \\ & + C_{00}(0, 0, 0; m_W^2, m_t^2, m_t^2)4(2C_L^u + C_R^u x) \\ & + C_{00}(0, 0, 0; m_t^2, m_W^2, m_W^2)4 (G^{GGZ} x - 2 \cos \xi \cot \theta_W) \\ & \left. + 4 \cos \xi \cot \theta_W - (4C_L^u + C_R^u x) \right] - (m_t \rightarrow 0) \left. \right\} \quad (\text{A2}) \end{aligned}$$

and

$$C_{LR}^{TZ} = C_R^\nu \left\{ \right. \left[ + C_0(0, 0, 0; m_W^2, m_W^2, m_W^2)4m_W^2 \cos \xi \cot \theta_W \right.$$

<sup>2</sup> Here and in the forthcoming diagrams, “GP” represents charged Goldstone boson, “uq” for up type quarks, and “Ap” for the dark photon.

$$\begin{aligned}
& - C_0(0, 0, 0; m_W^2, m_t^2, m_t^2) 2m_t^2 (C_L^u x + 2C_R^u) \\
& - C_0(0, 0, 0; m_t^2, m_W^2, m_W^2) \frac{2m_t^2}{\pi} (G^{WGZ} \sin \theta_W + 2\pi \cos \xi \cot \theta_W) \\
& - C_{00}(0, 0, 0; m_W^2, m_W^2, m_W^2) 16 \cos \xi \cot \theta_W \\
& + C_{00}(0, 0, 0; m_W^2, m_t^2, m_t^2) 4(2C_L^u + C_R^u x) \\
& + C_{00}(0, 0, 0; m_t^2, m_W^2, m_W^2) 4(G^{GGZ} x - 2 \cos \xi \cot \theta_W) \\
& + 4 \cos \xi \cot \theta_W - (4C_L^u + C_R^u x) \Big] - (m_t \rightarrow 0) \Big\}. \tag{A3}
\end{aligned}$$

## 2. Triangle $A'$ Diagrams

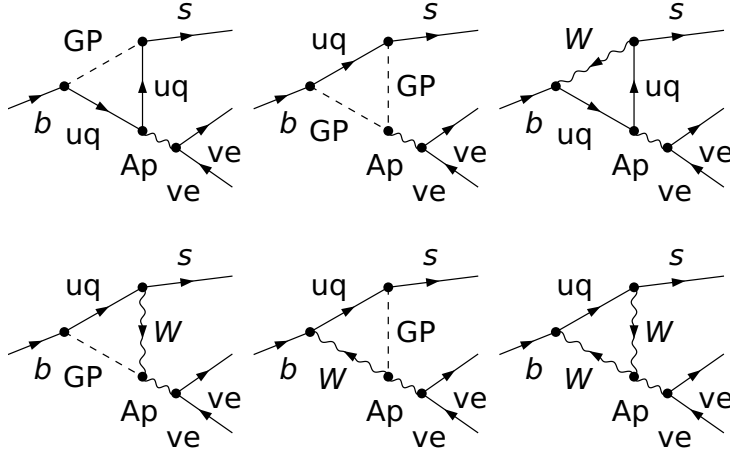

Figure 6. Triangle  $A'$  diagrams relevant for  $b \rightarrow s\nu\bar{\nu}$ . Only one neutrino generation is shown.

The matrix element obtained from the triangle diagrams in Fig. 6 the dark photon exchange is:

$$\mathcal{M}_{A'}^{\text{Tri}} = \frac{V_{tb}V_{ts}^* G_F \alpha_{em} m_W^2}{2\sqrt{2}\pi(m_{A'}^2 - q^2)} \left( C_{LL}^{TA'} \mathcal{O}_{LL} + C_{LR}^{TA'} \mathcal{O}_{LR} \right) \tag{A4}$$

where

$$\begin{aligned}
C_{LL}^{TA'} = C_L^{\nu\nu} \Bigg\{ & \left[ - C_0(0, 0, 0; m_W^2, m_W^2, m_W^2) 4m_W^2 \sin \xi \cot \theta_W \right. \\
& - 2C_0(0, 0, 0; m_W^2, m_t^2, m_t^2) 2m_t^2 (2C_R^u + C_L^u x) \\
& + C_0(0, 0, 0; m_t^2, m_W^2, m_W^2) \frac{2m_t^2}{\pi} \left( G^{WGA'} \sin \theta_W + 2\pi \sin \xi \cot \theta_W \right) \\
& \left. + C_{00}(0, 0, 0; m_W^2, m_W^2, m_W^2) 16 \sin \xi \cot \theta_W \right]
\end{aligned}$$

$$\begin{aligned}
& + C_{00}(0, 0, 0; m_W^2, m_t^2, m_t^2)4(2C'_L{}^u + C'_R{}^u x) \\
& + C_{00}(0, 0, 0; m_t^2, m_W^2, m_W^2)4 \left( G^{GGA'} x - 2 \sin \xi \cot \theta_W \right) \\
& - 4 \sin \xi \cot \theta_W - (4C'_L{}^u + C'_R{}^u x) \Big] - (m_t \rightarrow 0) \Big\} \tag{A5}
\end{aligned}$$

and

$$\begin{aligned}
C_{LR}^{TA'} = C'_R{}^\nu \Big\{ & \left[ - C_0(0, 0, 0; m_W^2, m_W^2, m_W^2)4m_W^2 \sin \xi \cot \theta_W \right. \\
& - 2C_0(0, 0, 0; m_W^2, m_t^2, m_t^2)2m_t^2(2C'_R{}^u + C'_L{}^u x) \\
& + C_0(0, 0, 0; m_t^2, m_W^2, m_W^2)\frac{2m_t^2}{\pi} \left( G^{WGA'} \sin \theta_W + 2\pi \sin \xi \cot \theta_W \right) \\
& + C_{00}(0, 0, 0; m_W^2, m_W^2, m_W^2)16 \sin \xi \cot \theta_W \\
& + C_{00}(0, 0, 0; m_W^2, m_t^2, m_t^2)4(2C'_L{}^u + C'_R{}^u x) \\
& + C_{00}(0, 0, 0; m_t^2, m_W^2, m_W^2)4 \left( G^{GGA'} x - 2 \sin \xi \cot \theta_W \right) \\
& \left. - 4 \sin \xi \cot \theta_W - (4C'_L{}^u + C'_R{}^u x) \right] - (m_t \rightarrow 0) \Big\} \tag{A6}
\end{aligned}$$

### 3. Self energy $Z$ and $A'$ Diagrams

Finally we present the self energy diagrams due to the  $Z$  and dark photon  $A'$  exchange.

#### a. Self energy $Z$ :

Using the Feynman diagrams in Fig. 7, the result for the self energy diagram contributions due to the  $Z$  boson exchange becomes

$$\mathcal{M}_Z^{\text{Self}} = \frac{V_{tb}V_{ts}^*G_F \alpha_{em} m_W^2}{2\sqrt{2}\pi(m_Z^2 - q^2)} (C_{LL}^{SZ}\mathcal{O}_{LL} + C_{LR}^{SZ}\mathcal{O}_{LR}) \tag{A7}$$

where

$$C_{LL}^{SZ} = 2C'_L{}^\nu C_L^d \left\{ \left[ B_1(0; m_t^2, m_W^2)(2 + x) + 1 \right] - (m_t \rightarrow 0) \right\} \tag{A8}$$

and

$$C_{LR}^{SZ} = 2C'_R{}^\nu C_L^d \left\{ \left[ B_1(0; m_t^2, m_W^2)(2 + x) + 1 \right] - (m_t \rightarrow 0) \right\} \tag{A9}$$

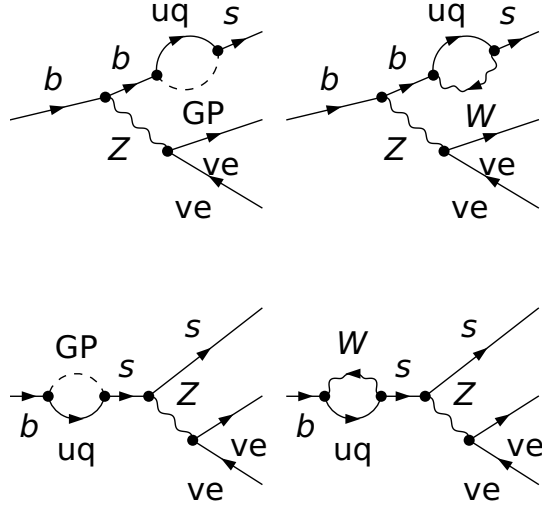

Figure 7. Self energy  $Z$  diagrams relevant for  $b \rightarrow s\nu\bar{\nu}$ . Only one neutrino generation is shown.

*b. Self energy  $A'$ :*

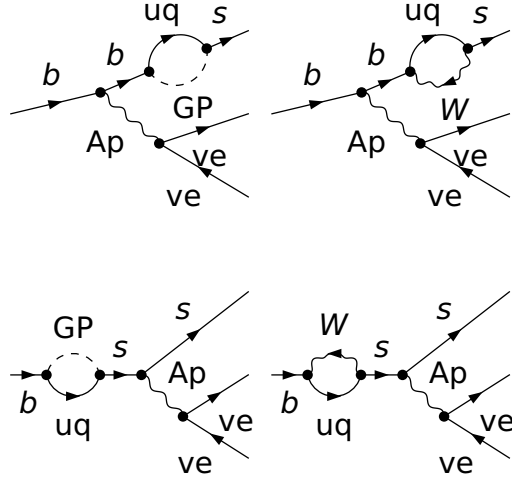

Figure 8. Self energy  $A'$  diagrams relevant for  $b \rightarrow s\nu\bar{\nu}$ . Only one neutrino generation is shown.

The result for the self energy diagram contributions due to the dark photon  $A'$  exchange, computed from the diagrams in Fig. 8 is

$$\mathcal{M}_{A'}^{\text{Self}} = \frac{V_{tb}V_{ts}^*G_F\alpha_{em}m_W^2}{2\sqrt{2}\pi(m_{A'}^2 - q^2)} \left( C_{LL}^{SA'} \mathcal{O}_{LL} + C_{LR}^{SA'} \mathcal{O}_{LR} \right) \quad (\text{A10})$$

where

$$C_{LL}^{SA'} = 2C_L^{\nu\nu}C_L^{\prime d} \left\{ \left[ B_1(0; m_t^2, m_W^2)(2+x) + 1 \right] - (m_t \rightarrow 0) \right\} \quad (\text{A11})$$

and

$$C_{LR}^{SA'} = 2C_R^{\nu\nu} C_L^d \left\{ \left[ B_1(0; m_t^2, m_W^2)(2+x) + 1 \right] - (m_t \rightarrow 0) \right\} \quad (\text{A12})$$

#### 4. Box Diagrams

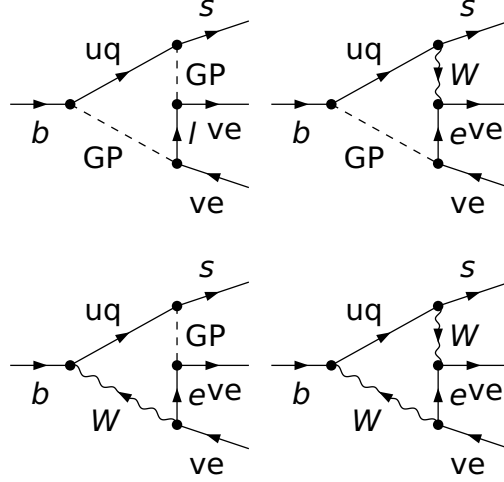

Figure 9. Box diagrams relevant for  $b \rightarrow s\nu\bar{\nu}$ . Only one neutrino generation is shown.

Finally, the box diagram amplitude from Fig. 9 is

$$\mathcal{M}^{\text{Box}} = \frac{V_{tb}V_{ts}^* G_F \alpha_{em} m_W^2}{2\sqrt{2}\pi} C_{LL}^{\text{Box}} \mathcal{O}_{LL} \quad (\text{A13})$$

where

$$C_{LL}^{\text{Box}} = \left[ -2D_0(0, 0, 0, 0, 0, 0; m_t^2, m_W^2, m_e^2, m_W^2) m_W^2 xy + D_{00}(0, 0, 0, 0, 0, 0; m_t^2, m_W^2, m_e^2, m_W^2)(16 + xy) \right] - (m_t \rightarrow 0) \quad (\text{A14})$$

It should be noted that the dark photon do not contribute to the box diagrams. The one-loop integral expressions  $B_i$ ,  $C_0$ ,  $C_{00}$ ,  $D_0$ , and  $D_{00}$  are the standard Passarino-Veltman functions and they are defined by using the convention in [73].

---

[1] G. Aad *et al.* (ATLAS), Observation of a new particle in the search for the Standard Model Higgs boson with the ATLAS detector at the LHC, Phys. Lett. B **716**, 1 (2012), arXiv:1207.7214 [hep-ex].

- [2] S. Chatrchyan *et al.* (CMS), Observation of a New Boson at a Mass of 125 GeV with the CMS Experiment at the LHC, *Phys. Lett. B* **716**, 30 (2012), arXiv:1207.7235 [hep-ex].
- [3] S. L. Glashow, J. Iliopoulos, and L. Maiani, Weak Interactions with Lepton-Hadron Symmetry, *Phys. Rev. D* **2**, 1285 (1970).
- [4] D. London and J. Matias, *B* Flavour Anomalies: 2021 Theoretical Status Report, *Ann. Rev. Nucl. Part. Sci.* **72**, 37 (2022), arXiv:2110.13270 [hep-ph].
- [5] B. Capdevila, A. Crivellin, and J. Matias, Review of semileptonic B anomalies, *Eur. Phys. J. ST* **1**, 20 (2023), arXiv:2309.01311 [hep-ph].
- [6] W. Altmannshofer, A. J. Buras, D. M. Straub, and M. Wick, New strategies for New Physics search in  $B \rightarrow K^* \nu \bar{\nu}$ ,  $B \rightarrow K \nu \bar{\nu}$  and  $B \rightarrow X_s \nu \bar{\nu}$  decays, *JHEP* **04**, 022, arXiv:0902.0160 [hep-ph].
- [7] A. J. Buras, J. Girrbach-Noe, C. Niehoff, and D. M. Straub,  $B \rightarrow K^{(*)} \nu \bar{\nu}$  decays in the Standard Model and beyond, *JHEP* **02**, 184, arXiv:1409.4557 [hep-ph].
- [8] D. Bečirević, G. Piazza, and O. Sumensari, Revisiting  $B \rightarrow K^{(*)} \nu \bar{\nu}$  decays in the Standard Model and beyond, *Eur. Phys. J. C* **83**, 252 (2023), arXiv:2301.06990 [hep-ph].
- [9] T. Felkl, S. L. Li, and M. A. Schmidt, A tale of invisibility: constraints on new physics in  $b \rightarrow s \nu \nu$ , *JHEP* **12**, 118, arXiv:2111.04327 [hep-ph].
- [10] R. Bause, H. Gisbert, M. Golz, and G. Hiller, Interplay of dineutrino modes with semileptonic rare B-decays, *JHEP* **12**, 061, arXiv:2109.01675 [hep-ph].
- [11] T. E. Browder, N. G. Deshpande, R. Mandal, and R. Sinha, Impact of  $B \rightarrow K \nu \bar{\nu}$  measurements on beyond the Standard Model theories, *Phys. Rev. D* **104**, 053007 (2021), arXiv:2107.01080 [hep-ph].
- [12] D. Bečirević, S. Fajfer, N. Košnik, and L. Pavičić, Right-handed interactions in puzzling *B*-decays, *Phys. Lett. B* **861**, 139285 (2025), arXiv:2410.23257 [hep-ph].
- [13] P. del Amo Sanchez *et al.* (BaBar), Search for the Rare Decay  $B \rightarrow K \nu \bar{\nu}$ , *Phys. Rev. D* **82**, 112002 (2010), arXiv:1009.1529 [hep-ex].
- [14] O. Lutz *et al.* (Belle), Search for  $B \rightarrow h^{(*)} \nu \bar{\nu}$  with the full Belle  $\Upsilon(4S)$  data sample, *Phys. Rev. D* **87**, 111103 (2013), arXiv:1303.3719 [hep-ex].
- [15] J. P. Lees *et al.* (BaBar), Search for  $B \rightarrow K^{(*)} \nu \bar{\nu}$  and invisible quarkonium decays, *Phys. Rev. D* **87**, 112005 (2013), arXiv:1303.7465 [hep-ex].
- [16] J. Grygier *et al.* (Belle), Search for  $B \rightarrow h \nu \bar{\nu}$  decays with semileptonic tagging at Belle, *Phys.*

- Rev. D **96**, 091101 (2017), [Addendum: Phys.Rev.D 97, 099902 (2018)], arXiv:1702.03224 [hep-ex].
- [17] W. Altmannshofer *et al.* (Belle-II), The Belle II Physics Book, PTEP **2019**, 123C01 (2019), [Erratum: PTEP 2020, 029201 (2020)], arXiv:1808.10567 [hep-ex].
- [18] I. Adachi *et al.* (Belle-II), Evidence for  $B^+ \rightarrow K^+ \nu \bar{\nu}$  decays, Phys. Rev. D **109**, 112006 (2024), arXiv:2311.14647 [hep-ex].
- [19] E. Gabrielli, L. Marzola, K. M  ursepp, and M. Raidal, Explaining the  $B^+ \rightarrow K^+ \nu \bar{\nu}$  excess via a massless dark photon, Eur. Phys. J. C **84**, 460 (2024), arXiv:2402.05901 [hep-ph].
- [20] W. Altmannshofer, A. Crivellin, H. Haigh, G. Inguglia, and J. Martin Camalich, Light new physics in  $B \rightarrow K^{(*)} \nu \bar{\nu}$  ?, Phys. Rev. D **109**, 075008 (2024), arXiv:2311.14629 [hep-ph].
- [21] L. Allwicher, D. Becirevic, G. Piazza, S. Rosauero-Alcaraz, and O. Sumensari, Understanding the first measurement of  $B(B \rightarrow K \nu \bar{\nu})$ , Phys. Lett. B **848**, 138411 (2024), arXiv:2309.02246 [hep-ph].
- [22] R. Bause, H. Gisbert, and G. Hiller, Implications of an enhanced  $B \rightarrow K \nu \bar{\nu}$  branching ratio, Phys. Rev. D **109**, 015006 (2024), arXiv:2309.00075 [hep-ph].
- [23] D. McKeen, J. N. Ng, and D. Tuckler, Higgs portal interpretation of the Belle II  $B^+ \rightarrow K^+ \nu \bar{\nu}$  measurement, Phys. Rev. D **109**, 075006 (2024), arXiv:2312.00982 [hep-ph].
- [24] K. Fridell, M. Ghosh, T. Okui, and K. Tobioka, Decoding the  $B \rightarrow K \nu \nu$  excess at Belle II: Kinematics, operators, and masses, Phys. Rev. D **109**, 115006 (2024), arXiv:2312.12507 [hep-ph].
- [25] T. Felkl, A. Giri, R. Mohanta, and M. A. Schmidt, When energy goes missing: new physics in  $b \rightarrow s \nu \nu$  with sterile neutrinos, Eur. Phys. J. C **83**, 1135 (2023), arXiv:2309.02940 [hep-ph].
- [26] Z. S. Wang, H. K. Dreiner, and J. Y. G  nther, The decay  $B \rightarrow K \nu \bar{\nu}$  at Belle II and a massless bino in R-parity-violating supersymmetry, Eur. Phys. J. C **85**, 66 (2025), arXiv:2309.03727 [hep-ph].
- [27] X.-G. He, X.-D. Ma, and G. Valencia, Revisiting models that enhance  $B^+ \rightarrow K^+ \nu \bar{\nu}$  in light of the new Belle II measurement, Phys. Rev. D **109**, 075019 (2024), arXiv:2309.12741 [hep-ph].
- [28] A. Datta, D. Marfatia, and L. Mukherjee,  $B \rightarrow K \nu \bar{\nu}$ , MiniBooNE and muon  $g - 2$  anomalies from a dark sector, Phys. Rev. D **109**, L031701 (2024), arXiv:2310.15136 [hep-ph].
- [29] S.-Y. Ho, J. Kim, and P. Ko, Recent  $B^+ \rightarrow K^+ \nu \bar{\nu}$  excess and muon  $g-2$  illuminating light dark sector with Higgs portal, Phys. Rev. D **111**, 055029 (2025), arXiv:2401.10112 [hep-ph].



- [30] F.-Z. Chen, Q. Wen, and F. Xu, Correlating  $B \rightarrow K^{(*)}\nu\bar{\nu}$  and flavor anomalies in SMEFT, Eur. Phys. J. C **84**, 1012 (2024), arXiv:2401.11552 [hep-ph].
- [31] B.-F. Hou, X.-Q. Li, M. Shen, Y.-D. Yang, and X.-B. Yuan, Deciphering the Belle II data on  $B \rightarrow K\nu\bar{\nu}$  decay in the (dark) SMEFT with minimal flavour violation, JHEP **06**, 172, arXiv:2402.19208 [hep-ph].
- [32] X.-G. He, X.-D. Ma, M. A. Schmidt, G. Valencia, and R. R. Volkas, Scalar dark matter explanation of the excess in the Belle II  $B^+ \rightarrow K^++$  invisible measurement, JHEP **07**, 168, arXiv:2403.12485 [hep-ph].
- [33] P. D. Bolton, S. Fajfer, J. F. Kamenik, and M. Novoa-Brunet, Signatures of light new particles in  $B \rightarrow K^{(*)}E_{\text{miss}}$ , Phys. Rev. D **110**, 055001 (2024), arXiv:2403.13887 [hep-ph].
- [34] A. J. Buras, J. Harz, and M. A. Mojahed, Disentangling new physics in  $K \rightarrow \pi\nu\bar{\nu}$  and  $B \rightarrow K(K^*)\nu\bar{\nu}$  observables, JHEP **10**, 087, arXiv:2405.06742 [hep-ph].
- [35] W. Altmannshofer and S. Roy, A joint explanation of the  $B \rightarrow \pi K$  puzzle and the  $B \rightarrow K\nu\bar{\nu}$  excess, (2024), arXiv:2411.06592 [hep-ph].
- [36] D. Marzocca, M. Nardecchia, A. Stanzione, and C. Toni, Implications of  $B \rightarrow K\nu\bar{\nu}$  under rank-one flavor violation hypothesis, Eur. Phys. J. C **84**, 1217 (2024), arXiv:2404.06533 [hep-ph].
- [37] Q.-Y. Hu, Are the new particles heavy or light in  $b \rightarrow sE_{\text{miss}}?$ , (2024), arXiv:2412.19084 [hep-ph].
- [38] L. Allwicher, M. Bordone, G. Isidori, G. Piazza, and A. Stanzione, Probing third-generation New Physics with  $K \rightarrow \pi\nu\nu^-$  and  $B \rightarrow K^{(*)}\nu\nu^-$ , Phys. Lett. B **861**, 139295 (2025), arXiv:2410.21444 [hep-ph].
- [39] A. Berezhnoy and D. Melikhov,  $B \rightarrow K^*M_X$  vs  $B \rightarrow KM_X$  as a probe of a scalar-mediator dark matter scenario, EPL **145**, 14001 (2024), arXiv:2309.17191 [hep-ph].
- [40] L. Calibbi, T. Li, L. Mukherjee, and M. A. Schmidt, Is Dark Matter the origin of the  $B \rightarrow K\nu\bar{\nu}$  excess at Belle II?, (2025), arXiv:2502.04900 [hep-ph].
- [41] J.-P. Lee, New physics effects in  $R(K^{(*)})$ ,  $B_s \rightarrow \mu^+\mu^-$ , and  $B^+ \rightarrow K^+\nu\bar{\nu}$ , (2025), arXiv:2502.06370 [hep-ph].
- [42] D. Bečirević, I. Doršner, S. Fajfer, N. Košnik, D. A. Faroughy, and O. Sumensari, Scalar leptoquarks from grand unified theories to accommodate the  $B$ -physics anomalies, Phys. Rev. D **98**, 055003 (2018), arXiv:1806.05689 [hep-ph].

- [43] J. Martin Camalich, M. Pospelov, P. N. H. Vuong, R. Ziegler, and J. Zupan, Quark Flavor Phenomenology of the QCD Axion, *Phys. Rev. D* **102**, 015023 (2020), arXiv:2002.04623 [hep-ph].
- [44] A. Filimonova, R. Schäfer, and S. Westhoff, Probing dark sectors with long-lived particles at BELLE II, *Phys. Rev. D* **101**, 095006 (2020), arXiv:1911.03490 [hep-ph].
- [45] B. Holdom, Two  $U(1)$ 's and Epsilon Charge Shifts, *Phys. Lett. B* **166**, 196 (1986).
- [46] M. Fabbrichesi, E. Gabrielli, and G. Lanfranchi, *The physics of the dark photon—a primer*, Springer Briefs in Physics (Springer, Cham, [2021] ©2021).
- [47] P. Fayet, On the Search for a New Spin 1 Boson, *Nucl. Phys. B* **187**, 184 (1981).
- [48] P. Fayet, Extra  $U(1)$ 's and New Forces, *Nucl. Phys. B* **347**, 743 (1990).
- [49] B.-A. Gradwohl and J. A. Frieman, Dark matter, long range forces, and large scale structure, *Astrophys. J.* **398**, 407 (1992).
- [50] L. Ackerman, M. R. Buckley, S. M. Carroll, and M. Kamionkowski, Dark Matter and Dark Radiation, *Phys. Rev. D* **79**, 023519 (2009), arXiv:0810.5126 [hep-ph].
- [51] J. Fan, A. Katz, L. Randall, and M. Reece, Dark-Disk Universe, *Phys. Rev. Lett.* **110**, 211302 (2013), arXiv:1303.3271 [hep-ph].
- [52] R. Foot and S. Vagnozzi, Dissipative hidden sector dark matter, *Phys. Rev. D* **91**, 023512 (2015), arXiv:1409.7174 [hep-ph].
- [53] J. T. Acuña, M. Fabbrichesi, and P. Ullio, Phenomenological consequences of an interacting multicomponent dark sector, *Phys. Rev. D* **102**, 083009 (2020), arXiv:2005.04146 [hep-ph].
- [54] E. Gabrielli and M. Raidal, Exponentially spread dynamical Yukawa couplings from non-perturbative chiral symmetry breaking in the dark sector, *Phys. Rev. D* **89**, 015008 (2014), arXiv:1310.1090 [hep-ph].
- [55] E. Gabrielli, L. Marzola, and M. Raidal, Radiative Yukawa Couplings in the Simplest Left-Right Symmetric Model, *Phys. Rev. D* **95**, 035005 (2017), arXiv:1611.00009 [hep-ph].
- [56] A. M. Sirunyan *et al.* (CMS), Search for dark photons in Higgs boson production via vector boson fusion in proton-proton collisions at  $\sqrt{s} = 13$  TeV, *JHEP* **03**, 011, arXiv:2009.14009 [hep-ex].
- [57] E. Gabrielli, B. Mele, M. Raidal, and E. Venturini, FCNC decays of standard model fermions into a dark photon, *Phys. Rev. D* **94**, 115013 (2016), arXiv:1607.05928 [hep-ph].
- [58] M. Fabbrichesi, E. Gabrielli, and B. Mele, Hunting down massless dark photons in kaon

- physics, Phys. Rev. Lett. **119**, 031801 (2017), arXiv:1705.03470 [hep-ph].
- [59] B. A. Dobrescu, Massless gauge bosons other than the photon, Phys. Rev. Lett. **94**, 151802 (2005), arXiv:hep-ph/0411004.
- [60] A. Elpe, E. Akyumuk, T. M. Aliev, L. Selbuz, and I. Turan, Constraining nonminimal dark sector scenarios with the COHERENT neutrino scattering data, Phys. Rev. D **107**, 075022 (2023), arXiv:2212.06861 [hep-ph].
- [61] M. D. Campos, D. Cogollo, M. Lindner, T. Melo, F. S. Queiroz, and W. Rodejohann, Neutrino Masses and Absence of Flavor Changing Interactions in the 2HDM from Gauge Principles, JHEP **08**, 092, arXiv:1705.05388 [hep-ph].
- [62] T. D. Lee, A Theory of Spontaneous T Violation, Phys. Rev. D **8**, 1226 (1973).
- [63] H.-S. Lee and M. Sher, Dark Two Higgs Doublet Model, Phys. Rev. D **87**, 115009 (2013), arXiv:1303.6653 [hep-ph].
- [64] M. Lindner, F. S. Queiroz, W. Rodejohann, and X.-J. Xu, Neutrino-electron scattering: general constraints on  $Z'$  and dark photon models, JHEP **05**, 098, arXiv:1803.00060 [hep-ph].
- [65] E. C. G. Stueckelberg, Interaction energy in electrodynamics and in the field theory of nuclear forces, Helv. Phys. Acta **11**, 225 (1938).
- [66] D. Feldman, Z. Liu, and P. Nath, The Stueckelberg  $Z$ -prime Extension with Kinetic Mixing and Milli-Charged Dark Matter From the Hidden Sector, Phys. Rev. D **75**, 115001 (2007), arXiv:hep-ph/0702123.
- [67] B. Kors and P. Nath, A Stueckelberg extension of the standard model, Phys. Lett. B **586**, 366 (2004), arXiv:hep-ph/0402047.
- [68] G. Panotopoulos and P. Tuzon, The physics of a new gauge boson in a Stueckelberg extension of the two-Higgs-doublet model, JHEP **07**, 039, arXiv:1102.5726 [hep-ph].
- [69] A. Bharucha, D. M. Straub, and R. Zwicky,  $B \rightarrow V\ell^+\ell^-$  in the Standard Model from light-cone sum rules, JHEP **08**, 098, arXiv:1503.05534 [hep-ph].
- [70] M. B. Voloshin,  $K_L \rightarrow \mu^+\mu^-$  Decay and  $(n\lambda Z)$  Vertex in the Weinberg-Salam Model, Sov. J. Nucl. Phys. **24**, 422 (1976).
- [71] T. Inami and C. S. Lim, Effects of Superheavy Quarks and Leptons in Low-Energy Weak Processes  $K_L \rightarrow \mu\bar{\mu}$ ,  $K^+ \rightarrow \pi^+\nu\bar{\nu}$  and  $K^0 \leftrightarrow \bar{K}^0$ , Prog. Theor. Phys. **65**, 297 (1981), [Erratum: Prog.Theor.Phys. 65, 1772 (1981)].
- [72] X.-G. Wang and A. W. Thomas, Dark photon effect on the rare kaon decay, J. Phys. G **50**,

085001 (2023), arXiv:2301.08367 [hep-ph].

- [73] T. Hahn and M. Perez-Victoria, Automatized one loop calculations in four-dimensions and D-dimensions, Comput. Phys. Commun. **118**, 153 (1999), arXiv:hep-ph/9807565.