

A linearly-implicit energy preserving scheme for geometrically nonlinear mechanics based on non-canonical Hamiltonian formulations

Andrea Brugnoli¹, Denis Matignon², and Joseph Morlier¹

¹ICA, Université de Toulouse, ISAE–SUPAERO, INSA, CNRS, MINES ALBI, UPS, Toulouse, France

²Fédération ENAC ISAE-SUPAERO ONERA, Université de Toulouse, Toulouse, France

Abstract

This work presents a novel formulation and numerical strategy for the simulation of geometrically nonlinear structures. First, a non-canonical Hamiltonian (Poisson) formulation is introduced by including the dynamics of the stress tensor. This framework is developed for von-Kármán nonlinearities in beams and plates, as well as finite strain elasticity with Saint-Venant material behavior. In the case of plates, both negligible and non-negligible membrane inertia are considered. For the former case the two-dimensional elasticity complex is leveraged to express the dynamics in terms of the Airy stress function. The finite element discretization employs a mixed approach, combining a conforming approximation for displacement and velocity fields with a discontinuous stress tensor representation. A staggered, linear implicit time integration scheme is proposed, establishing connections with existing explicit-implicit energy-preserving methods. The stress degrees of freedom are statically condensed, reducing the computational complexity to solving a system with a positive definite matrix. The methodology is validated through numerical experiments on the Duffing oscillator, a von-Kármán beam, and a column undergoing finite strain elasticity. Comparisons with fully implicit energy-preserving method and the explicit Newmark scheme demonstrate that the proposed approach achieves superior accuracy while maintaining energy stability. Additionally, it enables larger time steps compared to explicit schemes and exhibits computational efficiency comparable to the leapfrog method.

Keywords: geometrically-nonlinear mechanics, geometric numerical integration, exact energy conservation, Hamiltonian dynamics, mixed finite elements

1 Introduction

In mechanics, nonlinearities may arise from material behavior, contact and friction phenomena, or large deformations and displacements, in which case they are referred to as geometrical nonlinearities [1]. These nonlinearities occur in many real-world engineering applications [2] such as aeronautics [3, 4], wind energy systems [5], musical acoustics [6, 7] or microelectromechanical devices [8, 9]. The accurate time-domain simulation of geometrically nonlinear systems is an essential tool for their analysis and design, widely employed across various disciplines, including computer animation [10], sound synthesis [11], system identification [12] and control [13].

When dealing with flexible structures, spatial discretization is required to obtain a system of ordinary differential equations (ODEs). In the context of musical acoustics finite difference methods are typically used [14], because they yield diagonal mass matrices after spatial discretization and this feature can be exploited to develop fast time integration schemes [15]. However, implementing finite difference methods for complex geometrical domains is challenging and their application to general three-dimensional elasticity is limited to the linear case [16]. For nonlinear elasticity problems, the finite element method remains the most widely used approach [17].

The time integration of the resulting ODEs is typically performed using finite difference methods, with the Newmark method being the most well-known [18]. Its success is attributed to its

variational properties, meaning that it originates from discrete variational principles and thus inherits many desirable properties, such as symplecticity and momentum preservation [19]. A specific instance of the Newmark method, the implicit midpoint method, also preserves energy when applied to linear systems; however, this property does not extend to the nonlinear case. To achieve exact energy preservation in geometrically nonlinear problems, the stress tensor should not be evaluated at the midpoint but instead computed as an average between the current and next time instants, as shown in [20]. This approach is a special case of the discrete gradient method [21, 22] and leads to an implicit scheme that requires a root-finding method, such as Newton’s method.

In recent years, exact energy-preserving schemes that require solving only a linear system have been developed. The first of these methods, known as invariant energy quadratisation (IEQ) approaches, was initially applied to phase-field models [23]. The method was further developed and simplified in [24], where a spatially distributed field was replaced by a single scalar variable. For this reason, it is referred to as the scalar auxiliary variable (SAV) method. This framework was later extended to Hamiltonian systems [25], particularly in the context of mechanical models in acoustics. The authors consider a finite difference discretization in space and diagonal mass matrices. Thanks to this assumption, the scheme can be made fully explicit using the Sherman-Morrison inversion theorem [26]. The methodology was further enhanced to higher-order accuracy and extended to systems with multiple first integrals in [27], utilizing a finite element variational discretization in time. However, this strategy is implicit and therefore computationally demanding.

This work builds upon and extends the preliminary ideas introduced in [28], serving a dual purpose. First, geometrically nonlinear models are formulated in a non-canonical Hamiltonian form (also known as the Poisson formulation) by considering the dynamics of the stress tensor. Second, a discretization strategy employing mixed finite elements and a linear implicit time integration scheme is presented. The Poisson formulation is detailed for von Kármán-type nonlinearities in beams and plates (preliminary results can be found in [29, 30]), as well as for finite strain elasticity with Saint-Venant material behavior. For plates, both the cases of negligible and non-negligible membrane inertia are considered. In the former case, the two-dimensional elasticity complex—first developed by Kröner in the context of linear-elastic dislocation theory [31]—is leveraged to express the dynamics in terms of the Airy stress function [2]. The Poisson formulation for finite strain elasticity has already been detailed in [32] within the framework of port-Hamiltonian systems. The finite element discretization employs a conforming approximation of the displacement and velocity fields, along with a discontinuous approximation of the stress tensor. This discontinuous space must be carefully chosen to accurately capture geometrically nonlinear effects. The time integration scheme is a staggered version of the method proposed in [25], and the connection between these two approaches is established. The degrees of freedom associated with the stress variable can be statically condensed at the discrete time level, reducing the problem to solving a system involving a positive definite matrix to compute the velocity field at the next time step.

The methodology is tested on the Duffing oscillator, the vibration of a von Kármán beam, and the bending of a column in finite strain elasticity. It is compared against the exact energy-preserving method by Simo [20], that corresponds to a discrete gradient method, and the explicit central difference Newmark method (also known as the Störmer-Verlet or leapfrog scheme). The proposed method exhibits higher accuracy when measuring the error relative to the exact solution of the Duffing oscillator. Furthermore, it is energy stable, allowing for a larger time step than the explicit Newmark method. When applied to flexible structures, the scheme demonstrates computational efficiency comparable to the leapfrog method. However, mass lumping strategies—which would significantly enhance the efficiency of the leapfrog method—are not considered in this work. Nonetheless, the present approach can be further optimized through appropriate numerical linear algebra techniques when mass lumping is incorporated. Based on the numerical experiments, Table 1 highlights the advantages and limitations of each method.

The paper is structured as follows. Section 2 details the noncanonical Hamiltonian formulation, first for a finite dimensional nonlinear oscillator, then in a more abstract framework that is specialized to the aforementioned models. Then the space and time discretizations are addressed in Sec. 3. Numerical results are presented in Sec. 4. Finally, perspectives are given and conclusions are drawn in Sec. 5.

Method	Accuracy	Stability	Efficiency
Discrete Gradient	✓	✓	✗
Linear Implicit	✓	✓	✓
Leapfrog	✓	✗	✓

Table 1: Comparison of time integration methods for geometrically nonlinear mechanics

2 A non-canonical Hamiltonian structure for geometrical nonlinear mechanics

Geometrically nonlinear problems in continuum mechanics can be framed in a general non-canonical Hamiltonian structure. This statement will be motivated through several examples in mechanics. For this sake of clarity, a one degree of freedom geometrical nonlinear oscillator is first considered. Then an abstract formulation is introduced. Then examples from continuum mechanics justifying the abstract formulation are considered.

2.1 An introductory finite dimensional example

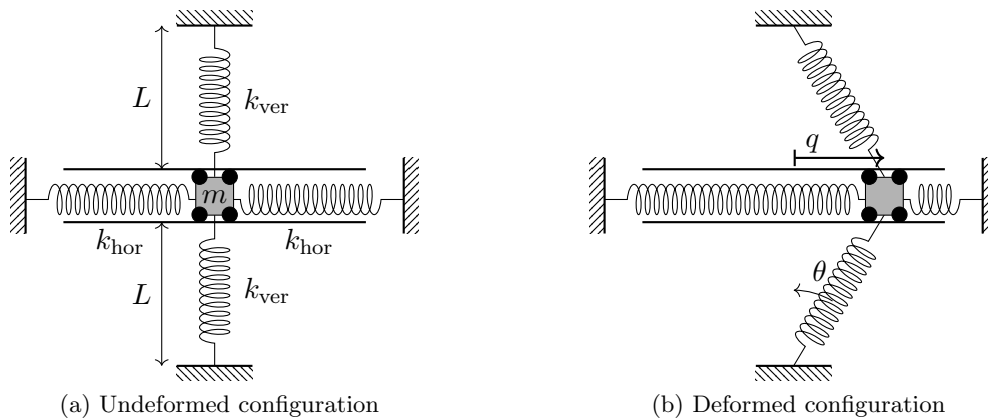

Figure 1: Geometrically nonlinear oscillations of a sliding mass

Consider a mass sliding frictionless in an horizontal plane. The mass is attached to two horizontal and two vertical springs whose material behavior is linear and given by the stiffness k_{hor} and k_{ver} respectively. In the undeformed configuration the two springs have length L and (cf. Fig. 1). Denoting by q the horizontal displacement of the mass, the equations of motion are

$$m\ddot{q} = -2k_{\text{hor}}q - 2k_{\text{ver}}\delta \sin(\theta), \quad (1)$$

In this expression $\delta = \sqrt{L^2 + q^2} - L$ is the elongation of the vertical springs and $\sin \theta = \frac{q}{\sqrt{L^2 + q^2}}$. Given the Hooke law $\sigma_{\text{hor}} = k_{\text{hor}}q$, $\sigma_{\text{ver}} = k_{\text{ver}}\delta$ and introducing the velocity v , the total energy of the system is given by the quadratic form

$$\begin{aligned} H &= \frac{1}{2}m\dot{q}^2 + \frac{1}{2}2k_{\text{hor}}^{-1}\sigma_{\text{hor}}^2 + \frac{1}{2}2k_{\text{ver}}^{-1}\sigma_{\text{ver}}^2 \\ &= \frac{1}{2} \begin{pmatrix} v \\ \sigma_{\text{hor}} \\ \sigma_{\text{ver}} \end{pmatrix}^{\top} \begin{bmatrix} m & 0 & 0 \\ 0 & 2k_{\text{hor}}^{-1} & 0 \\ 0 & 0 & 2k_{\text{ver}}^{-1} \end{bmatrix} \begin{pmatrix} v \\ \sigma_{\text{hor}} \\ \sigma_{\text{ver}} \end{pmatrix}. \end{aligned}$$

The time derivative of the elongation of the vertical springs is given by

$$\dot{\delta} = \frac{q}{\sqrt{L^2 + q^2}}\dot{q} = \sin(\theta)\dot{q}.$$

The dynamics (1) can therefore be rewritten as a first order system using the horizontal displace-

ment of the mass q , its velocity v and the axial stresses σ_{hor} , σ_{ver} in the following way

$$\begin{aligned}\dot{q} &= \mathbf{e}_1^\top \mathbf{x}, \\ \mathbf{H}\dot{\mathbf{x}} &= \mathbf{J}(q)\mathbf{x},\end{aligned}$$

where $\mathbf{e}_1 = [1 \ 0]^\top$ is the first element of the Euclidean canonical basis, $\mathbf{x} = [v \ \sigma_{\text{hor}} \ \sigma_{\text{ver}}]^\top$ and

$$\mathbf{H} = \text{Diag} \begin{bmatrix} m \\ 2k_{\text{hor}}^{-1} \\ 2k_{\text{ver}}^{-1} \end{bmatrix}, \quad \mathbf{J} = \begin{bmatrix} 0 & -2 & -2 \sin \theta \\ 2 & 0 & 0 \\ 2 \sin \theta & 0 & 0 \end{bmatrix}. \quad (2)$$

The matrix $\mathbf{H} = \mathbf{H}^\top > 0$ is symmetric positive definite, whereas the matrix $\mathbf{J} = -\mathbf{J}^\top$ is skew-symmetric. The energy is given by the quadratic form

$$H = \frac{1}{2} \mathbf{x}^\top \mathbf{H} \mathbf{x}.$$

At the price of adding additional variables, the dynamics can be rewritten in this special form. This has important consequences at the numerical level, as it will be shown in section (3.2). The system can be approximated by considering a Taylor expansion

$$(L^2 + q^2)^{-1/2} = \frac{1}{L} - \frac{q^2}{2L^3} + \frac{3q^4}{8L^5} + \mathcal{O}(q^6).$$

If only the quadratic term is retained, then the Duffing oscillator [33] is obtained

$$m\ddot{q} = -2k_{\text{hor}}q - k_{\text{ver}}\frac{q^3}{L^2}. \quad (3)$$

The Hamiltonian form for the Duffing oscillator arise from the linearization of the matrix \mathbf{J} in system (2.1)

$$\begin{aligned}\dot{q} &= v, \\ \text{Diag} \begin{bmatrix} m \\ 2k_{\text{hor}}^{-1} \\ 2k_{\text{ver}}^{-1} \end{bmatrix} \begin{pmatrix} \dot{v} \\ \dot{\sigma}_{\text{hor}} \\ \dot{\sigma}_{\text{ver}} \end{pmatrix} &= \begin{bmatrix} 0 & -2 & -\frac{2q}{L} \\ 2 & 0 & 0 \\ \frac{2q}{L} & 0 & 0 \end{bmatrix} \begin{pmatrix} v \\ \sigma_{\text{hor}} \\ \sigma_{\text{ver}} \end{pmatrix}.\end{aligned} \quad (4)$$

2.2 A general abstract framework

The previous discussion is instrumental to illustrate that geometrically nonlinear models in mechanics may be written using a total Lagrangian formulation in the following abstract non-canonical Hamiltonian form

$$\begin{aligned}\partial_t \mathbf{q} &= \mathbf{v}, \\ \begin{bmatrix} \rho & 0 \\ 0 & \mathbf{C} \end{bmatrix} \frac{\partial}{\partial t} \begin{pmatrix} \mathbf{v} \\ \mathbf{S} \end{pmatrix} &= \begin{bmatrix} 0 & -\mathcal{L}^*(\mathcal{D}\mathbf{q}) \\ \mathcal{L}(\mathcal{D}\mathbf{q}) & 0 \end{bmatrix} \begin{pmatrix} \mathbf{v} \\ \mathbf{S} \end{pmatrix}.\end{aligned} \quad (5)$$

Parameters ρ and \mathbf{C} are related to the density and compliance of the material (in general the latter is a fourth order symmetric tensor), \mathbf{q} represents a generalized coordinate (or displacement), \mathbf{v} is the velocity field, \mathbf{S} a stress-like variable. Furthermore \mathcal{L} is an (unbounded) differential operator, that depends on $\mathcal{D}\mathbf{q}$, where \mathcal{D} is a differential operator associated to a deformation measure. When $\mathcal{D}\mathbf{q}$ is regarded as a parameter, the notation $\mathcal{L}^*(\mathcal{D}\mathbf{q})$ stands for the (formal) adjoint of $\mathcal{L}(\mathcal{D}\mathbf{q})$, characterized by the relation

$$(\mathbf{S}, \mathcal{L}(\mathcal{D}\mathbf{q})\mathbf{v})_\Omega = (\mathcal{L}^*(\mathcal{D}\mathbf{q})\mathbf{S}, \mathbf{v})_\Omega, \quad \forall \mathbf{S}, \forall \mathbf{v}, \quad (6)$$

where $(\mathbf{f}, \mathbf{g})_\Omega = \int_\Omega \mathbf{f} \cdot \mathbf{g} \, d\Omega$ denotes the inner product of two (generally vector-valued) functions over the domain $\Omega \subset \mathbb{R}^d$. For this equation to be true the fields need to satisfy appropriate homogeneous boundary conditions that will be prescribed precisely in the following examples. Because of (6), the operator

$$\mathcal{J}(\mathcal{D}\mathbf{q}) := \begin{bmatrix} 0 & -\mathcal{L}^*(\mathcal{D}\mathbf{q}) \\ \mathcal{L}(\mathcal{D}\mathbf{q}) & 0 \end{bmatrix},$$

is formally skew-adjoint, meaning that

$$(\boldsymbol{\alpha}, \mathcal{J}(\mathcal{D}\mathbf{q})\boldsymbol{\beta})_\Omega = -(\mathcal{J}^*(\mathcal{D}\mathbf{q})\boldsymbol{\alpha}, \boldsymbol{\beta})_\Omega, \quad \forall \boldsymbol{\alpha}, \forall \boldsymbol{\beta}.$$

Because of this property the energy

$$H = \frac{1}{2}(\mathbf{v}, \rho \mathbf{v})_\Omega + \frac{1}{2}(\mathbf{S}, \mathbf{C}\mathbf{S})_\Omega, \quad (7)$$

is conserved, i.e. $\dot{H} = 0$. System (5) can be written compactly as follows

$$\begin{aligned} \partial_t \mathbf{q} &= \mathbf{v}, \\ \mathcal{H} \partial_t \mathbf{x} &= \mathcal{J}(\mathbf{q}) \mathbf{x}. \end{aligned} \quad (8)$$

with $\mathbf{x} = (\mathbf{v} \ \mathbf{S})^\top$ and $\mathcal{H} = \text{Diag}[\rho \ \mathbf{C}]$. This system can be deduced from the Euler-Lagrange equations arising from the following kinetic and potential energies

$$T = \frac{1}{2} \int_\Omega \rho \left\| \frac{\partial \mathbf{q}}{\partial t} \right\|^2 d\Omega, \quad V = \frac{1}{2} \int_\Omega \mathbf{E} : \mathbf{K} \mathbf{E} d\Omega.$$

The parameter $\mathbf{K} = \mathbf{C}^{-1}$ is related to the stiffness tensor and relates stress and strain tensors $\mathbf{S} = \mathbf{K}\mathbf{E}$. The strain $\mathbf{E} = \mathbf{E}(\mathcal{D}\mathbf{q})$ is a nonlinear function of $\mathcal{D}\mathbf{q}$. Formulation (8) is completely local and require the specification of the boundary conditions for the overall motion. These will be specified in the following examples.

2.3 Von Kármán beams

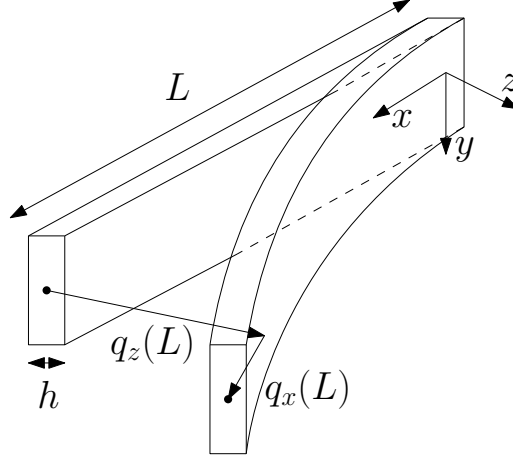

Figure 2: Notation for the kinematic fields of the beam.

The von Kármán model for thin plates is built upon two main geometrical assumptions:

- the out of plane deflection is comparable to the thickness;
- the squares of axial stretching terms are negligible compared to the square of rotations.

This two assumptions imply that the quadratic term responsible for the bending membrane coupling are retained in the expression of the axial deformation

$$\varepsilon = \frac{\partial q_x}{\partial x} + \frac{1}{2} \left(\frac{\partial q_z}{\partial x} \right)^2 - z \frac{\partial^2 q_z}{\partial x^2},$$

where q_x , q_z are the horizontal and vertical displacements cf. Fig. 2. The axial strain and the (linearized) curvature are given by

$$\varepsilon_a := \frac{\partial q_x}{\partial x} + \frac{1}{2} \left(\frac{\partial q_z}{\partial x} \right)^2, \quad \kappa := \frac{\partial^2 q_z}{\partial x^2}.$$

Consider the kinetic and potential energy

$$\begin{aligned} T &= \frac{1}{2} \int_0^L \rho A \left\{ \left(\frac{\partial q_x}{\partial t} \right)^2 + \left(\frac{\partial q_z}{\partial t} \right)^2 \right\} dx, \\ V &= \frac{1}{2} \int_0^L \{ EA \varepsilon_a^2 + EI \kappa^2 \} dx. \end{aligned}$$

The Euler-Lagrange equations obtained by the principle of least-action are given by

$$\begin{aligned}\rho A \partial_{tt} q_x &= \partial_x N, \\ \rho A \partial_{tt} q_z &= -\partial_{xx}^2 M + \partial_x (N \partial_x q_z).\end{aligned}$$

where the axial and bending stress resultant have been introduced

$$N := EA \varepsilon_a, \quad M := EI \kappa.$$

The time derivative of the stress variables gives

$$\begin{aligned}C_a \partial_t N &= \partial_x v_x + (\partial_x q_z) \partial_x v_z, \\ C_b \partial_t M &= \partial_{xx} v_z,\end{aligned}$$

where the bending compliance $C_b = (EI)^{-1}$ has been introduced. By including the dynamics of these variables the Hamiltonian formulation (8) is obtained [29], where the state and operators take the following specific form

$$\begin{aligned}\mathbf{x} &:= (v_x \quad v_z \quad N \quad M)^\top, \\ \mathcal{H} &:= \text{Diag} [\rho A \quad \rho A \quad C_a \quad C_b]^\top, \\ \mathcal{J}(q_z) &:= \begin{bmatrix} 0 & 0 & \partial_x & 0 \\ 0 & 0 & \partial_x (\circ \partial_x q_z) & -\partial_{xx}^2 \\ \partial_x & (\partial_x q_z) \partial_x \circ & 0 & 0 \\ 0 & \partial_{xx}^2 & 0 & 0 \end{bmatrix}.\end{aligned}$$

Given a splitting of the boundary $\partial\Omega = \Gamma_q \cup \Gamma_\sigma$, the boundary conditions are given by

$$\begin{aligned}q_x|_{\Gamma_q} &= 0, & N|_{\Gamma_\sigma} &= 0, \\ q_z|_{\Gamma_q} &= 0, & (N \partial_x q_z - \partial_x M)|_{\Gamma_\sigma} &= 0, \\ \partial_x q_z|_{\Gamma_q} &= 0, & M|_{\Gamma_\sigma} &= 0,\end{aligned}$$

Remark 1. *The aforementioned boundary conditions describe a clamped-free beam. Simply supported boundary conditions may also be considered. Imagine then a splitting of a the form $\partial\Omega = \Gamma_q \cup \Gamma_\sigma \cup \Gamma_{ss}$, then the simply supported boundary conditions on Γ_{ss} are*

$$q_x|_{\Gamma_{ss}} = 0, \quad q_z|_{\Gamma_{ss}} = 0, \quad M|_{\Gamma_{ss}} = 0.$$

For this example, the operator $\mathcal{L}(\partial_x q_z)$ and its adjoint are given by

$$\begin{aligned}\mathcal{L}(\partial_x q_z) &= \begin{bmatrix} \partial_x & (\partial_x q_z) \partial_x \circ \\ 0 & \partial_{xx}^2 \end{bmatrix}, \\ \mathcal{L}^*(\partial_x q_z) &= - \begin{bmatrix} \partial_x & 0 \\ \partial_x (\circ \partial_x q_z) & -\partial_{xx}^2 \end{bmatrix}.\end{aligned}$$

2.4 Von Kármán plate model

This model is the two dimensional extension of the previous one and it is built on the same geometrical assumptions. This means that the strain tensor $\varepsilon \in \mathbb{R}_{\text{sym}}^{2 \times 2}$, takes the following simplified expression

$$\varepsilon = \text{def}(\mathbf{q}_m) + \frac{1}{2} \text{grad } q_z \otimes \text{grad } q_z - z \text{Hess } q_z. \quad (9)$$

In this equation $\text{def} := \frac{1}{2}(\nabla + \nabla^\top)$, which stands for *deformation*, is the symmetric gradient and corresponds to the infinitesimal strain tensor in linear elasticity, and \otimes is the dyadic product of the two vectors, i.e. $\mathbf{a} \otimes \mathbf{b} = \mathbf{a} \mathbf{b}^\top$ where $\mathbf{a}, \mathbf{b} \in \mathbb{R}^2$ are column vectors and Hess denotes the Hessian operator. The displacement vector \mathbf{q} has been split into the membrane displacement $\mathbf{q}_m = (q_x \quad q_y)^\top$ and the out of plane component q_z . Again the strain tensor can be split into the membrane strain and the (linearized) curvature

$$\varepsilon_m = \text{def}(\mathbf{q}_m) + \frac{1}{2} \text{grad } q_z \otimes \text{grad } q_z, \quad \kappa = \text{Hess } q_z.$$

2.4.1 Full model

The following model has been presented in a concise manner in [30]. The wording full refers to the fact that both the membrane and bending behavior are considered in this model. Given a two dimensional domain $\Omega \subset \mathbb{R}^2$, the kinetic and potential energy are

$$T = \frac{1}{2} \int_{\Omega} \rho h \left\{ \left\| \frac{\partial \mathbf{q}_m}{\partial t} \right\|^2 + \left(\frac{\partial q_z}{\partial t} \right)^2 \right\} d\Omega,$$

$$V = \frac{1}{2} \int_{\Omega} \{ \boldsymbol{\varepsilon}_m : \mathbf{K}_m \boldsymbol{\varepsilon}_m + \boldsymbol{\kappa} : \mathbf{K}_b \boldsymbol{\kappa} \} d\Omega,$$

where h is the plate thickness and \mathbf{K}_m , \mathbf{K}_b are fourth order tensors representing the membrane and bending stiffness. The contraction of two matrices is denoted as $\mathbf{A} : \mathbf{B} = \sum_{i,j=1}^n A_{ij} B_{ij}$. In the case of an isotropic homogeneous material in plane stress condition, their action on a symmetric second order tensor $\mathbf{S} \in \mathbb{R}_{\text{sym}}^{2 \times 2}$ takes the following form

$$\mathbf{K}_m(\mathbf{S}) = Eh\boldsymbol{\Phi}(\mathbf{S}), \quad \mathbf{K}_b = \frac{Eh^3}{12}\boldsymbol{\Phi}(\mathbf{S}).$$

where $\boldsymbol{\Phi} : \mathbb{R}_{\text{sym}}^{2 \times 2} \rightarrow \mathbb{R}_{\text{sym}}^{2 \times 2}$ is the following map between symmetric tensor

$$\boldsymbol{\Phi}(\mathbf{S}) = \frac{1}{1-\nu^2} \{ (1-\nu)\mathbf{S} + \nu \mathbf{I}_2 \text{tr}(\mathbf{S}) \}.$$

The membrane and bending stresses are given by $\mathbf{N} = \mathbf{K}_m \boldsymbol{\varepsilon}_m$, $\mathbf{M} = \mathbf{K}_b \boldsymbol{\kappa}$ respectively. The Euler-Lagrange equations for this model are

$$\rho h \partial_{tt} \mathbf{q}_m = \text{Div } \mathbf{N},$$

$$\rho h \partial_{tt} q_z = -\text{div Div } \mathbf{M} + \text{div}(\mathbf{N} \text{grad } q_z),$$

where the divergence of a tensor $\mathbf{A} \in \mathbb{R}^{d \times d}$ is defined row-wise as $[\text{Div } \mathbf{A}]_i = \sum_{j=1}^d \partial_j A_{ij}$. The time derivative of the strain tensors gives

$$\mathbf{C}_m \partial_t \mathbf{N} = \text{def } \mathbf{v}_m + \text{sym}(\text{grad } q_z \otimes \text{grad } v_z),$$

$$\mathbf{C}_b \partial_t \mathbf{M} = \text{Hess } v_z,$$

where $\mathbf{C}_m = \mathbf{K}_m^{-1}$, $\mathbf{C}_b = \mathbf{K}_b^{-1}$ and sym is the symmetrization operator. Consequently the dynamics assumes the same form as in (8), with state and operators taking the following specific form

$$\mathbf{x} := (v_x \quad v_z \quad N \quad M)^\top,$$

$$\mathcal{H} := \text{Diag} [\rho h \quad \rho h \quad \mathbf{C}_m \quad \mathbf{C}_b]^\top,$$

$$\mathcal{J}(q_z) := \begin{bmatrix} 0 & 0 & \text{Div} & 0 \\ 0 & 0 & \mathcal{C}(q_z) & -\text{div Div} \\ \text{def} & -\mathcal{C}^*(q_z) & 0 & 0 \\ 0 & \text{Hess} & 0 & 0 \end{bmatrix}, \quad (10)$$

where the operator $\mathcal{C}(q_z)(\cdot) : L^2(\Omega, \mathbb{R}_{\text{sym}}^{2 \times 2}) \rightarrow L^2(\Omega)$ acting on symmetric tensors is defined by

$$\mathcal{C}(q_z)(\mathbf{N}) = \text{div}(\mathbf{N} \text{grad } q_z).$$

We are going to show in Proposition 1 that its adjoint is given by

$$\mathcal{C}(q_z)^*(\cdot) = -\text{sym}[\text{grad}(\cdot) \otimes \text{grad}(q_z)].$$

The kinematic boundary conditions are applied on Γ_q whereas the dynamic boundary conditions are applied on Γ_σ ($\partial\Omega = \Gamma_q \cup \Gamma_\sigma$)

$$\mathbf{q}_m|_{\Gamma_q} = 0, \quad \mathbf{N}\mathbf{n}|_{\Gamma_\sigma} = 0,$$

$$q_z|_{\Gamma_q} = 0, \quad \gamma_{\perp\perp,1}\mathbf{M} + (\mathbf{N}\mathbf{n})^\top \text{grad } q_z|_{\Gamma_\sigma} = 0,$$

$$\partial_{\mathbf{n}} q_z|_{\Gamma_q} = 0, \quad \mathbf{n}^\top \mathbf{M}\mathbf{n}|_{\Gamma_\sigma} = 0,$$

where \mathbf{n} is the outward normal vector and $\gamma_{\perp\perp,1}\mathbf{M} = -\mathbf{n}^\top \text{div } \mathbf{M} - \partial_{\mathbf{s}}(\mathbf{n}^\top \mathbf{M}\mathbf{s})|_{\partial\Omega}$ is the effective shear force at the boundary (\mathbf{s} is the tangent vector at the boundary).

Proposition 1. *In this case, the differential operator and its adjoint read*

$$\begin{aligned}\mathcal{L}(\text{grad } q_z) &= \begin{bmatrix} \text{def} & \text{sym}(\text{grad } q_z \otimes \text{grad } \circ) \\ 0 & \text{Hess} \end{bmatrix}, \\ \mathcal{L}^*(\text{grad } q_z) &= - \begin{bmatrix} \text{Div} & 0 \\ \text{div}(\circ \text{grad } q_z) & -\text{div Div} \end{bmatrix}.\end{aligned}$$

Proof. The fact that def is the adjoint of $-\text{Div}$ acting on symmetric tensors is known, see e.g. [34]. Moreover, the proof that div Div and Hess are adjoint operators is given in [34]. Consider a smooth scalar field $u \in C_0^\infty(\Omega)$ and a smooth symmetric tensor field $\mathbf{N} \in C_0^\infty(\Omega, \mathbb{R}_{\text{sym}}^{2 \times 2})$ with compact support. The formal adjoint of $\mathcal{C}(q_z)(\cdot)$ satisfies the relation

$$(u, \mathcal{C}(q_z)(\mathbf{N}))_{L^2(\Omega)} = (\mathcal{C}(q_z)^*(u), \mathbf{N})_{L^2(\Omega, \mathbb{R}_{\text{sym}}^{2 \times 2})}.$$

The adjoint is deduced by the following computation

$$\begin{aligned}(u, \mathcal{C}(q_z)(\mathbf{N}))_\Omega &= (u, \text{div}(\mathbf{N} \text{grad } q_z))_\Omega, \\ &= (-\text{grad } u, \mathbf{N} \text{grad } q_z)_\Omega, \\ &= (-\text{grad } u \otimes \text{grad } q_z, \mathbf{N})_\Omega, \\ &= (-\text{sym}(\text{grad } u \otimes \text{grad } q_z), \mathbf{N})_\Omega.\end{aligned}$$

The first equality follows from integration by parts, the second by the dyadic product properties and the third by the symmetry of \mathbf{N} . This means

$$\mathcal{C}(q_z)^*(\cdot) = -\text{sym}[\text{grad}(\cdot) \otimes \text{grad}(q_z)],$$

leading to the final result. \square

2.4.2 Von Kármán plate in Airy form

Consider now the case of negligible membrane inertia. This means that the following constraint is imposed on the membrane stress tensor

$$\text{Div } \mathbf{N} = 0.$$

To simplify the problems the mathematical structure of the elasticity complex is exploited. For the reader convenience, the notation for the differential operators and the main results for the two dimensional elasticity complex are resumed in Appendix A and B respectively. For a simply connected two-dimensional domain the elasticity complex (27) is exact and the Airy stress potential can be used to deduced the membrane stress as

$$\mathbf{N} = \text{Air } \varphi.$$

This expression can be used to simplify the dynamics. In particular the bending-membrane coupling term can be simplified as follows

$$\begin{aligned}\text{div}(\mathbf{N} \text{grad } q_z) &= \text{div}(\text{Air } \varphi \text{grad } q_z), \\ &= \text{Div}(\text{Air } \varphi) \cdot \text{grad } q_z + \text{Air } \varphi : \text{Hess } q_z, \\ &= \text{Air } \varphi : \text{Hess } q_z,\end{aligned}$$

since $\text{Div Air} \equiv 0$. As it is customary in the literature, the last term is denoted using the the following bilinear operator

$$\begin{aligned}\mathcal{B}(f, g) &:= \text{Air } f : \text{Hess } g \\ &= (\partial_{22}f)(\partial_{11}g) + (\partial_{11}f)(\partial_{22}g) - 2(\partial_{12}f)(\partial_{12}g).\end{aligned}$$

The following properties of this bilinear form have been proven in [35]

- Symmetry: $\mathcal{B}(f, g) = \mathcal{B}(g, f)$;
- Self-adjointness: $(\mathcal{B}(f, g), h)_\Omega = (g, \mathcal{B}(f, h))_\Omega$ (function f is here regarded as a parameter).

The expression of the membrane strain still contains the contribution of the in-plane displacement

$$\mathbf{C}_m \text{Air } \varphi = \text{def } \mathbf{q} + \frac{1}{2} \text{grad } q_z \otimes \text{grad } q_z.$$

The idea is to exploit the relation $\text{rot Rot def} = 0$ from complex (28) to eliminate the membrane bending coupling.

$$\text{rot Rot } \mathbf{C}_m \text{Air } \varphi = \frac{1}{2} \text{rot Rot}(\text{grad } q_z \otimes \text{grad } q_z).$$

Notice that $\text{Air}^* = \text{rot Rot}$ (see Appendix A), so the operator $\text{rot Rot } \mathbf{C}_m \text{Air} = \text{Air}^* \mathbf{C}_m \text{Air}$ is self-adjoint. A little algebra provides

$$\text{rot Rot}(\text{grad } q_z \otimes \text{grad } q_z) = -\mathcal{B}(q_z, q_z).$$

So the Airy potential is related to the out of plane displacement via

$$(\text{Air}^* \mathbf{C}_m \text{Air}) \varphi = -\frac{1}{2} \mathcal{B}(q_z, q_z). \quad (11)$$

If the material is isotropic, the above relation simplifies into

$$\nabla^2 q_z = -\frac{Eh}{2} \mathcal{B}(q_z, q_z),$$

where ∇^2 is the bi-Laplacian. For the sake of generality, a generic compliance tensor is considered. The derivative in time of Equation (11) provides the dynamics of the Airy potential φ

$$(\text{Air}^* \mathbf{C}_m \text{Air}) \frac{\partial \varphi}{\partial t} = -\mathcal{B}(q_z, v_z),$$

where the symmetry and bilinearity of \mathcal{B} has been exploited. The von-Kármán plate can then be put in Hamiltonian form considering all the aforementioned simplification as in (8) with

$$\begin{aligned} \mathbf{x} &:= (v_z \quad \varphi \quad \mathbf{M}), \\ \mathcal{H} &:= \text{Diag} [\rho h \quad \text{Air}^* \mathbf{C}_m \text{Air} \quad \mathbf{C}_b], \\ \mathcal{J} &:= \begin{bmatrix} 0 & \mathcal{B}(q_z, \circ) & -\text{div Div} \\ -\mathcal{B}(q_z, \circ) & 0 & 0 \\ \text{Hess} & 0 & 0 \end{bmatrix}. \end{aligned} \quad (12)$$

Since the operator \mathcal{B} is self adjoint, the dynamics is ruled by a skew-adjoint operators as in the previous case. A self adjoint differential operator takes the place of an algebraic energy matrix. The differential operator and its adjoint read

$$\begin{aligned} \mathcal{L}(\text{Air } q_z) &= \begin{bmatrix} -\mathcal{B}(q_z, \circ) \\ \text{Hess} \end{bmatrix}, \\ \mathcal{L}^*(\text{Air } q_z) &= -[\mathcal{B}(q_z, \circ) \quad -\text{div Div}]. \end{aligned}$$

2.5 Finite strain elasticity

In geometrically nonlinear elasticity different tensors may be used to describe deformations. In this article we focus on the Green-Lagrange tensor

$$\mathbf{E} := \frac{1}{2}(\mathbf{F}^\top \mathbf{F} - \mathbf{I}), \quad \mathbf{F} := \mathbf{I} + \text{grad } \mathbf{q}.$$

where $[\text{grad } \mathbf{q}]_{ij} = \partial_j q_i$ is the gradient of a vector defined row-wise. The kinetic and potential energies are given by

$$\begin{aligned} T &= \frac{1}{2} \int_{\Omega} \rho \left\| \frac{\partial \mathbf{q}}{\partial t} \right\|^2 d\Omega, \\ V &= \frac{1}{2} \int_{\Omega} \int_{\Omega} \mathbf{E} : \mathbf{K} \mathbf{E} d\Omega. \end{aligned}$$

For the potential energy a Saint-Venant material model has been used. It is well known that this material exhibits numerical instabilities under compressive loading [36]. Nevertheless it remains of

interest in many applications as it can be computed under severe real time limitations. The Euler Lagrange equations and then given

$$\rho \partial_{tt} \mathbf{q} = \text{Div}(\mathbf{F}\mathbf{S}),$$

where $\mathbf{S} = \mathbf{K}\mathbf{E}$ is the second Piola stress tensor. By introducing the dynamical equation for the second Piola stress tensor, the Hamiltonian structure of the equations can be highlighted [32]:

$$\begin{aligned} \partial_t \mathbf{q} &= \mathbf{v}, \\ \begin{bmatrix} \rho & 0 \\ 0 & \mathbf{C} \end{bmatrix} \frac{\partial}{\partial t} \begin{pmatrix} \mathbf{v} \\ \mathbf{S} \end{pmatrix} &= \begin{bmatrix} 0 & \text{Div}(\mathbf{F} \circ) \\ \text{sym}(\mathbf{F}^\top \nabla \circ) & 0 \end{bmatrix} \begin{pmatrix} \mathbf{v} \\ \mathbf{S} \end{pmatrix}, \end{aligned}$$

$\mathbf{C} := \mathbf{K}^{-1}$ is the compliance tensor. The boundary conditions are

$$\mathbf{q}|_{\Gamma_q} = 0, \quad \mathbf{F}\mathbf{S}\mathbf{n}|_{\Gamma_\sigma} = 0.$$

The differential operator and its adjoint read

$$\begin{aligned} \mathcal{L}(\text{grad } \mathbf{q}) &= \text{sym}(\mathbf{F}^\top \text{grad } \circ), \\ \mathcal{L}^*(\text{grad } \mathbf{q}) &= -\text{Div}(\mathbf{F} \circ). \end{aligned}$$

3 Linearly implicit energy-preserving integration

We here consider a mixed finite element discretization strategy together with a time integration method to preserve the energy of the system. First we detail the space discretization methodology. The general procedure is first explained using the abstract formulation, and then specialized for the two models considered in the numerical examples, i.e. the von-Kármán beam model and finite strain elasticity. Next the time integration is discussed.

3.1 Semi-discretization in space with mixed finite element

To explain the discretization in space, we consider the abstract problem 8. The idea is to consider a weak formulation and integrate by parts the second line. Variables are then discretized via a suitable finite element space. The discrete abstract problem in weak form is: find $\mathbf{q}_h, \mathbf{v}_h \in V_h$, $\mathbf{S} \in W_h$ such that

$$\begin{aligned} \partial_t \mathbf{q}_h &= \mathbf{v}_h, \\ (\psi, \rho \partial_t \mathbf{v}_h)_\Omega &= -(\mathcal{L}(\mathcal{D}\mathbf{q}_h)\psi, \mathbf{S}_h)_\Omega, \\ (\Psi, \mathbf{C} \partial_t \mathbf{S}_h)_\Omega &= +(\Psi, \mathcal{L}(\mathcal{D}\mathbf{q}_h)\mathbf{v}_h)_\Omega, \end{aligned} \tag{13}$$

for all $\psi \in V_h$ and $\Psi \in W_h$. If the problem were linear (meaning that the operator \mathcal{L} would not depend on the displacement), then one could consider spaces V_h, W_h that would respect the inclusion $\mathcal{L}V_h \subset W_h$. In this way the second line of the system (13) would be satisfied pointwise. This is clearly not true in a nonlinear context. So a choice will be made in order to enrich the polynomial space for the stress, so that the nonlinear terms can be faithfully represented. Once a finite element basis has been selected, the weak formulation is converted in the following algebraic system

$$\begin{aligned} \dot{\mathbf{q}} &= \mathbf{v}, \\ \begin{bmatrix} \mathbf{M}_\rho & 0 \\ 0 & \mathbf{M}_C \end{bmatrix} \frac{d}{dt} \begin{pmatrix} \mathbf{v} \\ \mathbf{s} \end{pmatrix} &= \begin{bmatrix} 0 & -\mathbf{L}^\top(\mathbf{q}) \\ \mathbf{L}(\mathbf{q}) & 0 \end{bmatrix} \begin{pmatrix} \mathbf{v} \\ \mathbf{s} \end{pmatrix}. \end{aligned}$$

or more compactly in the following form

$$\begin{aligned} \dot{\mathbf{q}} &= \mathbf{v}, \\ \mathbf{H}\dot{\mathbf{x}} &= \mathbf{J}(\mathbf{q})\mathbf{x}. \end{aligned} \tag{14}$$

The energy of the system is given by $H = \frac{1}{2}\mathbf{x}^\top \mathbf{H}\mathbf{x}$, in complete analogy with the non linear oscillator example.

3.1.1 Von-Kármán beam

The physical domain for this example is an interval $\Omega = [0, L]$. Denote by E a generic element in a mesh \mathcal{I}_h . For this example the space V_h contains two finite element spaces, the longitudinal and

vertical deflections/velocities. These are discretized using linear and cubic (Hermite) polynomials respectively [17]

$$\begin{aligned} V_h &= \text{CG}_1 \times \text{Her}, \\ \text{CG}_1 &:= \{v_h \in C^0([0, L]), v_h|_E \in \mathbb{P}_1, \forall E \in \mathcal{I}_h\}, \\ \text{Her} &:= \{v_h \in C^1([0, L]), v_h|_E \in \mathbb{P}_3, \forall E \in \mathcal{I}_h\}, \end{aligned}$$

where CG_1 is the linear Lagrange space and Her is the space of Hermite polynomials. The space W_h contains the axial and bending stress resultant. These are discretized using quartic and linear discontinuous shape functions respectively

$$\begin{aligned} W_h &= \text{DG}_4 \times \text{DG}_1, \\ \text{DG}_k &= \{v_h|_E \in \mathbb{P}_k, \forall E \in \mathcal{I}_h\}, \end{aligned} \tag{15}$$

where DG_k is the Discontinuous Galerkin of order k . The quartic choice is due to the fact that the axial stress is proportional to the square power of the derivative of the vertical displacement

$$N = EA \left(\partial_x q_x + \frac{1}{2} (\partial_x q_z)^2 \right).$$

Since the vertical displacement is discretized via Hermite cubic polynomial, its squared derivative is a continuous quartic polynomial. Selecting a discontinuous quartic polynomial guarantees a correct representation of the axial stress, while choosing a smaller discretization space would lead to locking phenomena. The weak formulation for this problem then becomes: find $v_{x,h} \in \text{CG}_1$, $(q_{z,h}, v_{z,h}) \in \text{Her}$, $N_h \in \text{DG}_4$, $M_h \in \text{DG}_1$ such that

$$\begin{aligned} \partial_t q_{z,h} &= v_{z,h}, \\ (\psi_x, \rho A \partial_t v_{x,h})_\Omega &= -(\partial_x \psi_x, N_h)_\Omega, \\ (\psi_z, \rho A \partial_t v_{z,h})_\Omega &= -(\partial_x \psi_z \partial_x q_{z,h}, N_h)_\Omega \\ &\quad -(\partial_{xx} \psi_z, M_h)_\Omega, \\ (\psi_N, C_a \partial_t N_h)_\Omega &= +(\psi_N, \partial_x q_z^h \partial_x v_z^h)_\Omega \\ &\quad +(\psi_N, \partial_x v_{x,h})_\Omega, \\ (\psi_M, C_b \partial_t M_h)_\Omega &= +(\psi_M, \partial_{xx} v_z^h)_\Omega, \end{aligned} \tag{16}$$

for all $\psi_x \in \text{CG}_1$, $\psi_z \in \text{Her}$, $\psi_N \in \text{DG}_0$, $\psi_M \in \text{DG}_1$. The algebraic system arising from the finite element discretization as the same form as in (14) with $\mathbf{x} := (\mathbf{v}_x^\top \mathbf{v}_z^\top \mathbf{n}^\top \mathbf{m}^\top)^\top$ and

$$\begin{aligned} \mathbf{H} &:= \text{Diag} \begin{bmatrix} \mathbf{M}_{\rho A} \\ \mathbf{M}_{\rho A} \\ \mathbf{M}_{C_a} \\ \mathbf{M}_{C_b} \end{bmatrix}, \\ \mathbf{J} &:= \begin{bmatrix} 0 & 0 & -\mathbf{D}_{\partial_x}^\top & 0 \\ 0 & 0 & -\mathbf{L}^\top(\mathbf{q}_z) & -\mathbf{D}_{\partial_{xx}}^\top \\ \mathbf{D}_{\partial_x} & \mathbf{L}(\mathbf{q}_z) & 0 & 0 \\ 0 & \mathbf{D}_{\partial_{xx}} & 0 & 0 \end{bmatrix}. \end{aligned}$$

3.1.2 Finite strain elasticity

Denote with T a generic cell of the computational mesh \mathcal{T}_h . For finite strain displacement and velocity are discretized using Lagrange polynomial of order 1. The stress is instead discretized using a tensor-valued symmetric discontinuous space of polynomial degree 0

$$\begin{aligned} V_h &= \text{CG}_1(\mathbb{R}^d), \\ W_h &= \text{DG}_0(\mathbb{R}_{\text{sym}}^{d \times d}) = \{\mathbf{S}_h|_T \in [\mathbb{P}_0]_{\text{sym}}^{d \times d}, \forall T \in \mathcal{T}_h\}. \end{aligned}$$

where $d = \{2, 3\}$ is the geometric dimension of the problem. The resulting discrete formulation reads

$$\begin{aligned} \partial_t \mathbf{q}_h &= \mathbf{v}_h, \\ (\boldsymbol{\psi}, \rho \partial_t \mathbf{v}_h)_\Omega &= -(\text{sym}(\mathbf{F}^\top \text{grad } \boldsymbol{\psi}), \mathbf{S}_h)_\Omega, \\ (\boldsymbol{\Psi}, \mathbf{C} \partial_t \mathbf{S}_h)_\Omega &= +(\boldsymbol{\Psi}, \text{sym}(\mathbf{F}^\top \text{grad } \mathbf{v}_h))_\Omega, \end{aligned}$$

for all $\boldsymbol{\psi} \in V_h$ and $\boldsymbol{\Psi} \in W_h$. The ordinary differential equation arising from the discretization has the same form as (14).

3.2 Time integration method

For the time integration the combination of two well known symplectic methods is considered: the Störmer-Verlet (or leapfrog) scheme and the implicit midpoint method. These schemes are particular instances of the Newmark method in structural mechanics. Consider the following system

$$\begin{aligned}\dot{\mathbf{q}} &= \mathbf{v}, \\ \mathbf{M}\dot{\mathbf{v}} &= \mathbf{f}(\mathbf{q}).\end{aligned}$$

If $\mathbf{f}(\mathbf{q}) = -\nabla_{\mathbf{q}}V$, then the system represents a canonical Hamiltonian formulation. The Störmer-Verlet method (also called leapfrog method, central difference or explicit Newmark in mechanics) can be then written in the following form

$$\begin{aligned}\frac{\mathbf{q}_{n+\frac{1}{2}} - \mathbf{q}_{n-\frac{1}{2}}}{\Delta t} &= \mathbf{v}_n, \\ \mathbf{M}\frac{(\mathbf{v}_{n+1} - \mathbf{v}_n)}{\Delta t} &= \mathbf{f}(\mathbf{q}_{n+\frac{1}{2}}).\end{aligned}$$

To start the iterations, the first value for the velocity is obtained via a second order Taylor approximation

$$\mathbf{q}_{\frac{1}{2}} = \mathbf{q}_0 + \frac{\Delta t}{2}\mathbf{v}_0 + \frac{1}{8}\Delta t^2\mathbf{a}_0, \quad \mathbf{a}_0 := \mathbf{M}^{-1}\mathbf{f}(\mathbf{q}_0). \quad (17)$$

The implicit midpoint method applied to a generic ODE of the form $\dot{\mathbf{x}} = \mathbf{g}(\mathbf{x})$ gives

$$\frac{\mathbf{x}_{n+1} - \mathbf{x}_n}{\Delta t} = \mathbf{g}\left(\mathbf{x}_{n+\frac{1}{2}}\right),$$

with $\mathbf{x}_{n+\frac{1}{2}} := (\mathbf{x}_{n+1} + \mathbf{x}_n)/2$. The idea is to apply these two methods together to the special form given by system (14), leading to the following relations

$$\begin{aligned}\frac{\mathbf{q}_{n+\frac{1}{2}} - \mathbf{q}_{n-\frac{1}{2}}}{\Delta t} &= \mathbf{v}_n, \\ \mathbf{H}\frac{(\mathbf{x}_{n+1} - \mathbf{x}_n)}{\Delta t} &= \mathbf{J}(\mathbf{q}_{n+\frac{1}{2}})\frac{(\mathbf{x}_{n+1} + \mathbf{x}_n)}{2}\end{aligned} \quad (18)$$

The initial position $\mathbf{q}_{n+\frac{1}{2}}$ is again computed via a second order Taylor as in (17).

Proposition 2. *The discrete energy*

$$H_n := \frac{1}{2}\mathbf{x}_n^\top \mathbf{H}\mathbf{x}_n$$

is conserved by the scheme.

Proof. This is shown by considering the scalar multiplication of the second equation by $\mathbf{x}_{n+\frac{1}{2}}$

$$\mathbf{x}_{n+\frac{1}{2}}^\top \mathbf{H}\frac{(\mathbf{x}_{n+1} - \mathbf{x}_n)}{\Delta t} = \mathbf{x}_{n+\frac{1}{2}}^\top \mathbf{J}(\mathbf{q}_{n+\frac{1}{2}})\mathbf{x}_{n+\frac{1}{2}} = 0,$$

by the skew-symmetry of $\mathbf{J}(\mathbf{q}_{n+1})$. This implies

$$\mathbf{x}_{n+1}^\top \mathbf{H}\mathbf{x}_{n+1} = \mathbf{x}_n^\top \mathbf{H}\mathbf{x}_n, \quad \text{i.e. } H_{n+1} = H_n. \quad (19)$$

□

Proposition 3. *The discrete dynamics (18) can be rewritten in a recursive form as follows*

$$\begin{pmatrix} \mathbf{q}_{n+\frac{1}{2}} \\ \mathbf{x}_{n+1} \end{pmatrix} = \begin{bmatrix} \mathbf{I} & \Delta t \mathbf{B} \\ 0 & \text{Cay}\left(\frac{\Delta t}{2}\mathbf{H}^{-1}\mathbf{J}\right) \end{bmatrix} \begin{pmatrix} \mathbf{q}_{n-\frac{1}{2}} \\ \mathbf{x}_n \end{pmatrix}, \quad \text{with.} \quad (20)$$

where $\mathbf{B}\mathbf{x}_n := \mathbf{v}_n$ and the Cayley transform have been introduced

$$\text{Cay}(\mathbf{M}) := (\mathbf{I} - \mathbf{M})^{-1}(\mathbf{I} + \mathbf{M}).$$

Proof. Consider system (18) and the recursion rule for \mathbf{x}

$$\left[\mathbf{H} - \frac{\Delta t}{2} \mathbf{J}(\mathbf{q}_{n+\frac{1}{2}}) \right] \mathbf{x}_{n+1} = \left[\mathbf{H} - \frac{\Delta t}{2} \mathbf{J}(\mathbf{q}_{n+\frac{1}{2}}) \right] \mathbf{x}_n.$$

The matrix $\left[\mathbf{H} - \frac{\Delta t}{2} \mathbf{J}(\mathbf{q}_{n+\frac{1}{2}}) \right]$ is invertible. To prove this, consider the Cholesky factorization $\mathbf{H} = \mathbf{C}^\top \mathbf{C}$. Then it holds

$$\mathbf{C}^\top \mathbf{C} - \frac{\Delta t}{2} \mathbf{J}(\mathbf{q}_{n+\frac{1}{2}}) = \mathbf{C}^\top \left[\mathbf{I} - \frac{\Delta t}{2} \mathbf{C}^{-\top} \mathbf{J}(\mathbf{q}_{n+\frac{1}{2}}) \mathbf{C}^{-1} \right] \mathbf{C}.$$

The matrix $\mathbf{C}^{-\top} \mathbf{J}(\mathbf{q}_{n+\frac{1}{2}}) \mathbf{C}^{-1}$ is skew-symmetric. Therefore $\mathbf{I} - \frac{\Delta t}{2} \mathbf{C}^{-\top} \mathbf{J}(\mathbf{q}_{n+\frac{1}{2}}) \mathbf{C}^{-1}$ is invertible and consequently $\mathbf{H} - \frac{\Delta t}{2} \mathbf{J}(\mathbf{q}_{n+\frac{1}{2}})$ since it is the product of three invertible matrices. The state transition matrix $\mathbf{x}_{n+1} = \mathbf{A}(\mathbf{q}_{n+\frac{1}{2}}) \mathbf{x}_n$ is then obtained as

$$\begin{aligned} \mathbf{A}(\mathbf{q}_{n+\frac{1}{2}}) &:= \left[\mathbf{H} - \frac{\Delta t}{2} \mathbf{J}(\mathbf{q}_{n+\frac{1}{2}}) \right]^{-1} \left[\mathbf{H} - \frac{\Delta t}{2} \mathbf{J}(\mathbf{q}_{n+\frac{1}{2}}) \right], \\ &= \text{Cay} \left(\frac{\Delta t}{2} \mathbf{H}^{-1} \mathbf{J}(\mathbf{q}_{n+\frac{1}{2}}) \right). \end{aligned}$$

where the equality follows from factorizing \mathbf{H} from both terms and using the inverse of the product. \square

The the energy conservation (19) is then rewritten as

$$\|\mathbf{x}\|_{\mathbf{H}} = \|\text{Cay} \left(\mathbf{H}^{-1} \mathbf{J}(\mathbf{q}_{n+\frac{1}{2}}) \right) \mathbf{x}\|_{\mathbf{H}},$$

where $\|\mathbf{x}\|_{\mathbf{H}} := \mathbf{x}^\top \mathbf{H} \mathbf{x}$ is the norm induced by the positive definite symmetric matrix \mathbf{H} . This means that the Cayley transform of $\mathbf{H}^{-1} \mathbf{J}$ is a unitary matrix in the \mathbf{H} norm and therefore has eigenvalues lying on the unit circle. Given its block upper triangular structure, the spectrum of $\mathbf{A}(\mathbf{q}_{n+\frac{1}{2}})$ combines the spectrum of \mathbf{I} and $\text{Cay} \left(\frac{\Delta t}{2} \mathbf{H}^{-1} \mathbf{J}(\mathbf{q}_{n+\frac{1}{2}}) \right)$. Therefore all its eigenvalues lie on the unit circle.

3.3 Static condensation

Since the finite element space for the stress variable is discontinuous, the associated mass matrix is block-diagonal. To speed up the solver, this variable can be statically condensed. In the following the midpoint values of the velocity and stress are denoted by

$$\mathbf{v}_{n+\frac{1}{2}} := \frac{\mathbf{v}_{n+1} + \mathbf{v}_n}{2}, \quad \mathbf{s}_{n+\frac{1}{2}} := \frac{\mathbf{s}_{n+1} + \mathbf{s}_n}{2}.$$

From system (18), the velocity and stress discrete system reads

$$\mathbf{M}_\rho \frac{(\mathbf{v}_{n+1} - \mathbf{v}_n)}{\Delta t} = -\mathbf{L}^\top(\mathbf{q}_{n+\frac{1}{2}}) \mathbf{s}_{n+\frac{1}{2}}, \quad (21)$$

$$\mathbf{M}_C \frac{(\mathbf{s}_{n+1} - \mathbf{s}_n)}{\Delta t} = +\mathbf{L}(\mathbf{q}_{n+\frac{1}{2}}) \mathbf{v}_{n+\frac{1}{2}}. \quad (22)$$

The expression of the midpoint value for the stress $\mathbf{s}_{n+\frac{1}{2}}$ is given by

$$\mathbf{s}_{n+\frac{1}{2}} = \mathbf{s}_n + \frac{\Delta t}{2} \mathbf{M}_C^{-1} \mathbf{L}(\mathbf{q}_{n+\frac{1}{2}}) \mathbf{v}_{n+\frac{1}{2}},$$

Replacing this value into (21) leads to

$$\begin{aligned} \mathbf{M}_\rho \frac{(\mathbf{v}_{n+1} - \mathbf{v}_n)}{\Delta t} &= -\frac{\Delta t}{2} \mathbf{K}(\mathbf{q}_{n+\frac{1}{2}}) \mathbf{v}_{n+\frac{1}{2}} \\ &\quad - \mathbf{L}^\top(\mathbf{q}_{n+\frac{1}{2}}) \mathbf{s}_n \end{aligned}$$

where $\mathbf{K}(\mathbf{q}_{n+\frac{1}{2}}) := \mathbf{L}^\top(\mathbf{q}_{n+\frac{1}{2}})\mathbf{M}_C^{-1}\mathbf{L}(\mathbf{q}_{n+\frac{1}{2}})$. The time integration recursion is then expressed as: given $(\mathbf{q}_{n-\frac{1}{2}}, \mathbf{v}_n, \mathbf{s}_n)$, the values for the next time step $(\mathbf{q}_{n+\frac{1}{2}}, \mathbf{v}_{n+1}, \mathbf{s}_{n+1})$ are given by

$$\begin{aligned} \mathbf{q}_{n+\frac{1}{2}} &= \mathbf{q}_{n-\frac{1}{2}} + \Delta t \mathbf{v}_n, \\ \left[\mathbf{M}_\rho + \frac{\Delta t^2}{4} \mathbf{K} \right] \mathbf{v}_{n+1} &= \left[\mathbf{M}_\rho - \frac{\Delta t^2}{4} \mathbf{K} \right] \mathbf{v}_n - \Delta t \mathbf{L}^\top \mathbf{s}_n, \\ \mathbf{s}_{n+1} &= \mathbf{s}_n + \Delta t \mathbf{M}_C^{-1} \mathbf{L} \frac{(\mathbf{v}_{n+1} + \mathbf{v}_n)}{2}. \end{aligned} \quad (23)$$

where the explicit dependence of matrices \mathbf{L} , \mathbf{K} from $\mathbf{q}_{n+\frac{1}{2}}$ has been suppressed for simplicity.

3.4 Connection with the scalar auxiliary variable approach

The scalar auxiliary variable approach has been first introduced in [24] in the context of gradient flows and then extended to the case of Hamiltonian dynamics in [25]. Therein the authors apply the approach to Hamiltonian system with diagonal mass matrix, thus obtaining a scheme that is both computationally efficient and energy stable. To illustrate the connection with the scalar auxiliary method and the present framework consider a separable Hamiltonian system in canonical form

$$\begin{bmatrix} \mathbf{I} & 0 \\ 0 & \mathbf{M} \end{bmatrix} \frac{d}{dt} \begin{pmatrix} \mathbf{q} \\ \mathbf{v} \end{pmatrix} = \begin{bmatrix} 0 & \mathbf{I} \\ -\mathbf{I} & 0 \end{bmatrix} \begin{pmatrix} \nabla_{\mathbf{q}} V \\ \mathbf{v} \end{pmatrix}.$$

The dynamics is written in terms of the velocity instead of the linear momentum to avoid taking the inverse of the mass matrix in a finite element formulation. Assume that the potential energy is positive $V \geq 0$ (as in the case of continuum mechanics). The non negativity condition allows writing the potential energy as

$$V = \frac{1}{2} \xi^2.$$

The gradient of the potential can then be written in terms of ξ as

$$\nabla_{\mathbf{q}} V = \xi \nabla_{\mathbf{q}} \xi$$

The chain rule provides

$$\dot{\xi} = (\nabla_{\mathbf{q}} \xi)^\top \dot{\mathbf{q}} = (\nabla_{\mathbf{q}} \xi)^\top \mathbf{v}$$

The dynamics can then be rewritten in terms of $\mathbf{q}, \mathbf{v}, \xi$ in non-canonical Hamiltonian form as follows

$$\begin{aligned} \dot{\mathbf{q}} &= \mathbf{v}, \\ \begin{bmatrix} \mathbf{M} & 0 \\ 0 & 1 \end{bmatrix} \frac{d}{dt} \begin{pmatrix} \mathbf{v} \\ \xi \end{pmatrix} &= \begin{bmatrix} 0 & -\mathbf{g}(\mathbf{q}) \\ \mathbf{g}(\mathbf{q})^\top & 0 \end{bmatrix} \begin{pmatrix} \mathbf{v} \\ \xi \end{pmatrix}, \end{aligned}$$

where $\mathbf{g}(\mathbf{q}) = \nabla_{\mathbf{q}} \xi$. Notice that the system can be rewritten as follows

$$\begin{aligned} \dot{\mathbf{q}} &= \mathbf{v}, \\ \mathbf{H} \dot{\mathbf{x}} &= \mathbf{J}(\mathbf{q}) \mathbf{x}, \quad \mathbf{x} := [\mathbf{v}^\top \ \xi]^\top, \end{aligned}$$

and the total energy is given by $H = \frac{1}{2} \mathbf{x}^\top \mathbf{H} \mathbf{x}$. This is in complete analogy with the non-canonical formulation presented in the present work. In [25, Sec. 3.3] the time integration is presented as follows

$$\begin{aligned} \frac{\mathbf{q}_{n+1} - \mathbf{q}_n}{\Delta t} &= \mathbf{v}_{n+\frac{1}{2}}, \\ \mathbf{M} \frac{\mathbf{v}_{n+\frac{1}{2}} - \mathbf{v}_{n-\frac{1}{2}}}{\Delta t} &= -\mathbf{g}(\mathbf{q}_n) \frac{(\xi_{n+\frac{1}{2}} + \xi_{n-\frac{1}{2}})}{2}, \\ \xi_{n+\frac{1}{2}} - \xi_{n-\frac{1}{2}} &= +\mathbf{g}(\mathbf{q}_n)^\top \frac{(\mathbf{q}_{n+1} + \mathbf{q}_{n-1})}{2}. \end{aligned}$$

By the first line it holds

$$\frac{\mathbf{q}_{n+1} + \mathbf{q}_{n-1}}{2\Delta t} = \frac{\mathbf{v}_{n+\frac{1}{2}} + \mathbf{v}_{n-\frac{1}{2}}}{2}.$$

Therefore the scheme is equivalently rewritten as follows

$$\begin{aligned} \frac{\mathbf{q}_{n+1} - \mathbf{q}_n}{\Delta t} &= \frac{\mathbf{v}_{n+1} + \mathbf{v}_n}{2}, \\ \mathbf{H} \frac{(\mathbf{x}_{n+\frac{1}{2}} - \mathbf{x}_{n-\frac{1}{2}})}{\Delta t} &= \mathbf{J}(\mathbf{q}_n) \frac{\mathbf{x}_{n+\frac{1}{2}} + \mathbf{x}_{n-\frac{1}{2}}}{2}. \end{aligned}$$

This recursion is simply a staggered version of (18).

4 Numerical results

In this section, we test the proposed methodology for three different cases:

- the Duffing oscillator;
- vibrations of a von-Kármán beam;
- bending of a column in finite strain elasticity.

The linearly implicit scheme is compared against the Störmer-Verlet method and the exact energy conserving scheme presented in [20]. The former scheme is symplectic, energy preserving only in an approximate sense and explicit, thus it requires the fulfillment of a CFL-like condition. The latter method is implicit and exactly energy preserving and unconditionally stable. It requires however an iterative procedure to solve the resulting nonlinear system. To illustrate the idea behind the latter method, consider the weak formulation for finite strain elasticity

$$\begin{aligned} \partial_t \mathbf{q} &= \mathbf{v}, \\ (\boldsymbol{\psi}, \rho \partial_t \mathbf{v})_\Omega &= -(\text{grad } \boldsymbol{\psi}, \mathbf{F}(\mathbf{q})\mathbf{S}(\mathbf{q}))_\Omega, \end{aligned}$$

for all $\boldsymbol{\psi} \in V$. The semi-discretization in time using the implicit energy conserving scheme is then written as follows

$$\begin{aligned} \frac{\mathbf{q}_{n+1} - \mathbf{q}_n}{\Delta t} &= \mathbf{v}_{n+1/2}, \\ (\boldsymbol{\psi}, \rho \frac{\mathbf{v}_{n+1} - \mathbf{v}_n}{\Delta t})_\Omega &= -(\text{grad } \boldsymbol{\psi}, \mathbf{F}(\mathbf{q}_{n+\frac{1}{2}})\widehat{\mathbf{S}}_{n+\frac{1}{2}})_\Omega, \end{aligned}$$

where

$$\mathbf{v}_{n+1/2} := \frac{\mathbf{v}_{n+1} + \mathbf{v}_n}{2}, \quad \mathbf{q}_{n+1/2} := \frac{\mathbf{q}_{n+1} + \mathbf{q}_n}{2}$$

are the midpoint evaluation of the velocity and the displacement. On the other hand it is not the stress of the average configuration that one should use to obtain an exact energy conservation, but rather the average of the stress

$$\widehat{\mathbf{S}}_{n+1/2} = \mathbf{K} \frac{\mathbf{E}(\mathbf{q}_{n+1}) + \mathbf{E}(\mathbf{q}_n)}{2}.$$

This scheme corresponds to a discrete gradient integrator when only geometrical nonlinearities are considered [22].

For the test of convergence the error are computed using an L^2 norm in time. The L^2 space norm is replaced by the Euclidian inner product for simplicity

$$\begin{aligned} \text{Error } \mathbf{q} &= \sqrt{\sum_{n=0}^{N_t} \Delta t \|\mathbf{q}_n - \mathbf{q}_{\text{ref}}(t=n\Delta t)\|^2}, \\ \text{Error } \mathbf{v} &= \sqrt{\sum_{n=0}^{N_t} \Delta t \|\mathbf{v}_n - \mathbf{v}_{\text{ref}}(t=n\Delta t)\|^2} \end{aligned}$$

The reference solution may be an exact solution or a solution computed using a leapfrog method with time step $\Delta t_{\text{ref}} = \Delta t_{\text{base}}/2^7$ where Δt_{base} is the time step for the coarsest simulation. The finite element library FIRE Drake [37] is used for the numerical investigation. The FIRE Drake component Slate [38] is used to implement the static condensation and the local solvers for stress reconstruction.

4.1 The Duffing oscillator

The presented scheme is compared with the exact solution of the unforced and undamped Duffing oscillator, the dynamics of which is ruled by the ODE

$$\ddot{q} = -\alpha q - \beta q^3.$$

Notice the this ODE is equivalent to system (3) with

$$\alpha = 2k_{\text{hor}}/m, \quad \beta = k_{\text{ver}}/(mL^2).$$

Parameter	Value
α	10
β	5
q_0	10
T	2π
T_{end}	$\frac{\sqrt{\alpha + \beta q_0^2}}{100} T$
Δt_{base}	$\frac{1}{100} T$

Table 2: Parameters for the Duffing oscillator

For the initial conditions we consider

$$q(t=0) = q_0, \quad v(t=0) = 0$$

The analytic solution is given by the following expression

$$\begin{aligned} q(t) &= q_0 \text{cn}(\omega_0 t; k^2), \\ v(t) &= -\omega_0 q_0 \text{sn}(\omega_0 t; k^2) \text{dn}(\omega_0 t; k^2), \end{aligned}$$

where

$$\omega_0 := \sqrt{\alpha + \beta q_0^2}, \quad k^2 := \frac{\beta q_0^2}{2(\alpha + \beta q_0^2)},$$

and $\text{cn}(z; m)$, $\text{sn}(z; m)$ $\text{dn}(z; m)$ are the Jacobi elliptic functions of argument z and parameter m . The parameters for the simulation are reported in table 2, where T_{end} is final simulation time and Δt the time step for the simulation. The convergence plot against the exact solution is presented in Fig. 3. It can be noticed that the all methods exhibit a second order convergence. However the linear implicit method is much more precise than both the discrete gradient and leapfrog method.

In Fig. 4 the error with respect to the exact energy is shown. One can notice that the leapfrog method only approximately conserves the energy where the discrete gradient and linear implicit method preserve it up to machine precision. Concerning the total computational time, reported in Fig. 5, the linear implicit method stays in between the leapfrog and discrete gradient methods. In this example, however, there is no mass matrix coming from a finite element discretization, so it is natural that a fully explicit method is by one order of magnitude faster.

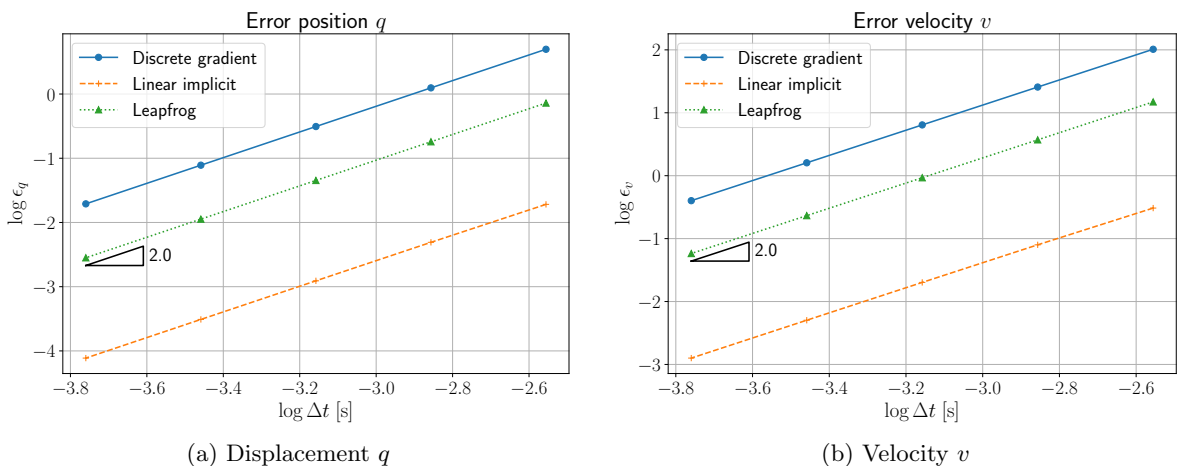

Figure 3: Convergence rate for the Duffing oscillator

4.2 Vibrations of a von-Kármán beam

In this section the free vibration of a geometrically nonlinear beam are analyzed. The actual values for the literal that will appear hereafter are reported in Table 3. The beam has length L and square

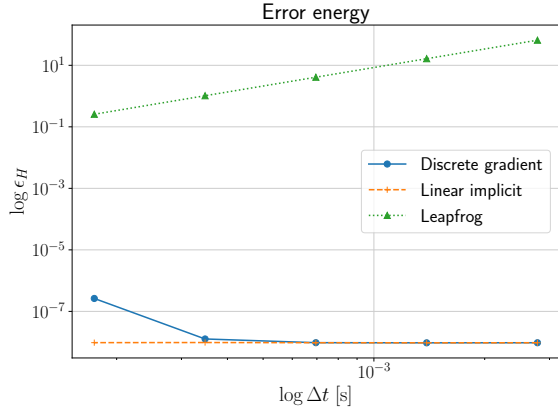

Figure 4: Energy error for the Duffing oscillator

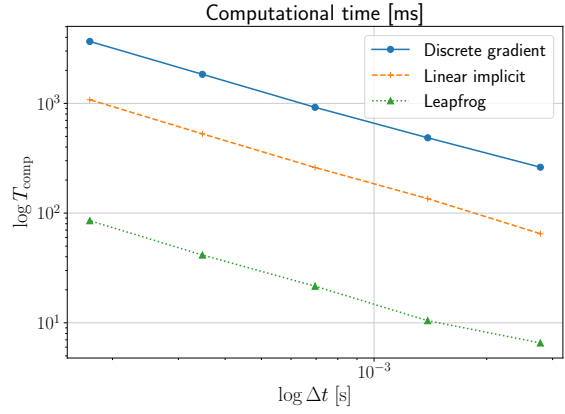

Figure 5: Computational time for Duffing

Parameter	Value
ρ	2700 [kg/m ³]
E	70 [GPa]
L	1 [m]
d	2 [mm]
$A_x = A_z$	0.1d
N_{el}	50
$T_{1,\text{bending}}$	$2 \frac{L^2}{\pi} \sqrt{\frac{EI}{\rho d^2}}$
Δt_{base}	$\frac{1}{8} \left(\frac{L}{N_{\text{el}}} \right)^2 \sqrt{\frac{EI}{\rho d^2}}$
T_{end}	0.1 $T_{1,\text{bending}}$

Table 3: Parameters for the von-Kármán beam

cross section of size h . As boundary conditions, a free condition is considered for the traction and the vertical displacement is set to zero

$$\begin{aligned} N(x = 0, t) &= N(x = L, t) = 0, \\ q_z(x = 0, t) &= q_z(x = L, t) = 0. \end{aligned}$$

For the initial conditions, we consider initial displacement given by the first mode of vibration for both the axial and vertical displacement, and zero velocities

$$\begin{aligned} q_x(x, t = 0) &= A_x \cos\left(\frac{\pi x}{L}\right), \\ q_z(x, t = 0) &= A_z \sin\left(\frac{\pi x}{L}\right). \end{aligned}$$

The beam is discretized using $N_{\text{el}} = 50$ finite elements. The total simulation time is taking to be one-tenth of the period of the first bending mode, i.e. $T_{\text{end}} = 0.1 T_{1,\text{bending}}$. The time step for the coarsest simulation is taken to be $\Delta t_{\text{base}} = \frac{1}{4} \Delta t_{\text{CFL}}$ where

$$\Delta t_{\text{CFL,bend}} = \frac{1}{2} \left(\frac{L}{N_{\text{el}}}\right)^2 \sqrt{\frac{EI}{\rho h^2}}$$

is the minimum time step for stability in finite difference simulations (in space and time) for bending of beams, cf. [14, Chapter 5].

Given the nonlinear coupling, the axial and bending dynamics interact in an intricate way and the reference solution, obtained using the leapfrog method with a time step $\Delta t_{\text{ref}} = \Delta t_{\text{base}}/2^7$, is reported. It can be noticed that the horizontal displacement keeps follows the first modal shape even if the temporal evolution is noisy. On the hand the vertical displacement modal shape turns into a noisy response in the second half of the simulation that completely masks the modal shape. The time convergence of the different variables with respect to the reference solution is reported in Fig. 7. It can be noticed that all methods converge with a second order convergence and the discrete gradient and linear implicit integrators have identical precision. The leapfrog method is unstable for the time step Δt_{base} as the axial dynamics is way faster than the bending one and thus requires a time step of the order of $\Delta t_{\text{CFL,ax}} = \frac{L}{N_{\text{el}}} \sqrt{\frac{E}{\rho}}$. Since the reference solution is computed with the leapfrog method, it is not surprising that this method achieves a better performance. For what concerns the energy conservation in Fig. 8 the mean of the energy different between two time steps is reported. The proposed linearly implicit method respects energy conservation to machine precision. The discrete gradient method respects energy conservation but not as accurately, probably because of tolerances settings in the Newton method to compute the nonlinear solution. The computational time taken by the three methods is reported in Fig. 9. No static condensation is applied as the system to be solved is rather small and no noticeable improvements are obtained. Since now mass matrices are included in the formulation the different methods take comparable time for the same time step. Of course the considering mass lumping strategies would be of substantial help for the leapfrog method, but also for the linearly implicit method, since a conjugate gradient method would be much more effective when preconditioning with the (lumped) mass matrix [39]. The incorporation of mass lumping strategies is not considered in the present contribution.

4.3 Finite strain elasticity

Non symmetrical oscillations of a column are considered in this test. The example is taken from [40] and the only difference with respect to the simulation therein is the fact that a Saint-Venant constitutive model is considered here instead of a neo-Hookean one. The geometry and reference frame are reported in Fig. 11 and distances are reported in meters. The column is considered clamped at its base and the initial conditions are taken to be

$$\mathbf{q}(\mathbf{x}, t) = \mathbf{0}, \quad \mathbf{v}(\mathbf{x}, t) = \left(\frac{5}{3}z \quad 0 \quad 0\right)^\top \text{ [m/s]}$$

The mesh is divided into $6 \times 6 \times 36$ cubes each composed of 6 tetrahedral, leading to a mesh size of $h = 1/6$ [m]. The total simulation time is taken to be $T_{\text{end}} = 0.5$ [s] and the time step for the coarsest simulation is $\Delta t_{\text{base}} = h/c_l$, where c_l is the speed of propagation of longitudinal waves in the solid (ignoring nonlinear effects), reported in Table 10, together with the actual value of the

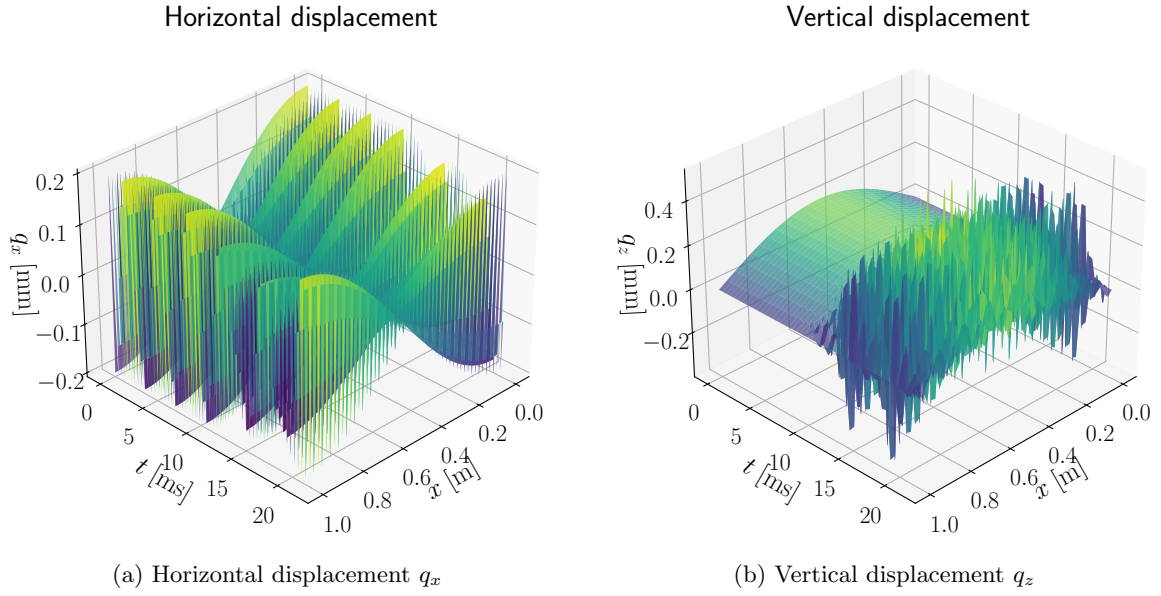

Figure 6: Reference solution obtained using the Leapfrog integrator with a time step $\Delta t/2^7$

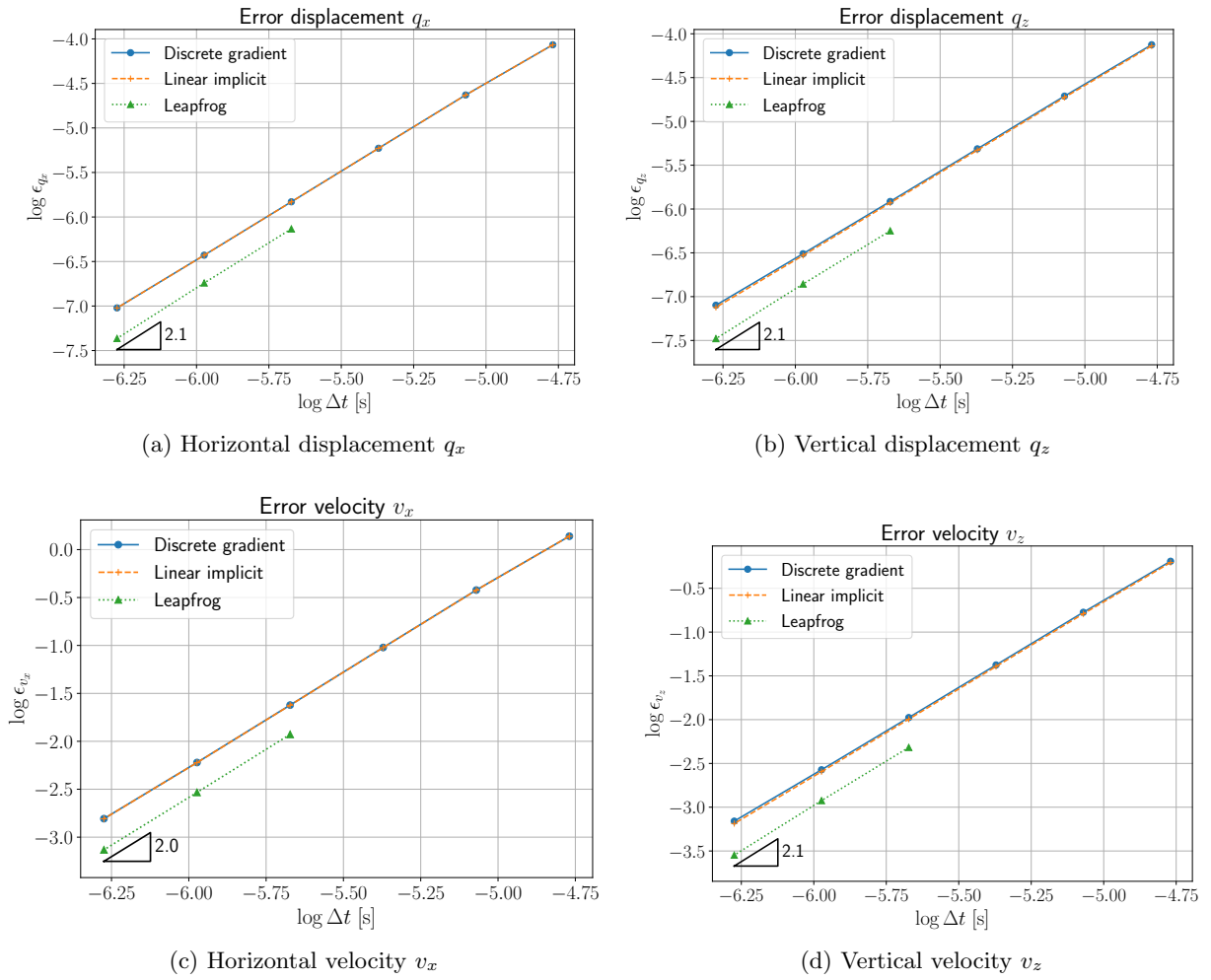

Figure 7: Convergence rate for q_x, q_z, v_x, v_z in the von-Kármán beam

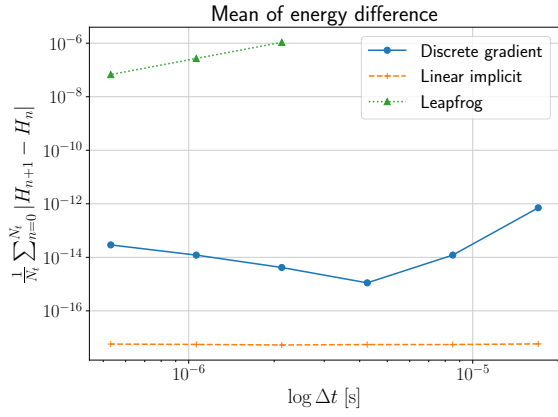

Figure 8: Mean of $|H_{n+1} - H_n|$ for the von-Kármán beam

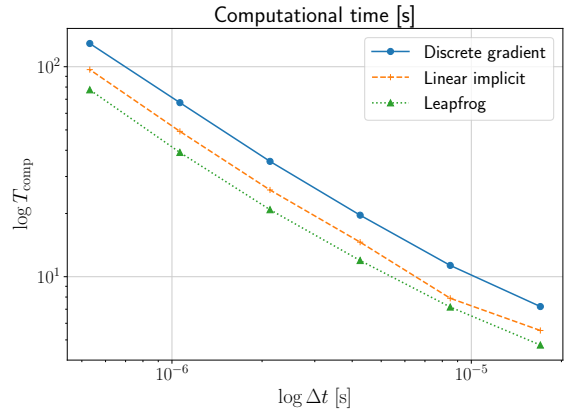

Figure 9: Computational time for the von-Kármán beam

Parameter	Value
ρ	1100 [kg/m ³]
E	17 [MPa]
ν	0.3
μ	$\frac{E}{2(1+\nu)}$
λ	$\frac{E\nu}{(1-2\nu)(1+\nu)}$
κ	$\lambda + \frac{2}{3}\mu$
c_l	$\sqrt{\frac{\kappa + 4/3\mu}{\rho}}$
Δt_{base}	h/c_l
T_{end}	0.5 [s]

Figure 10: Parameters for the finite strain elasticity problem

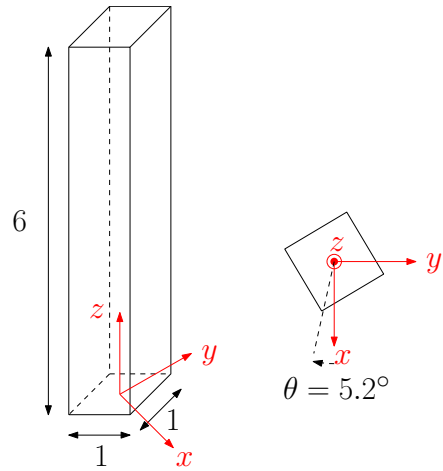
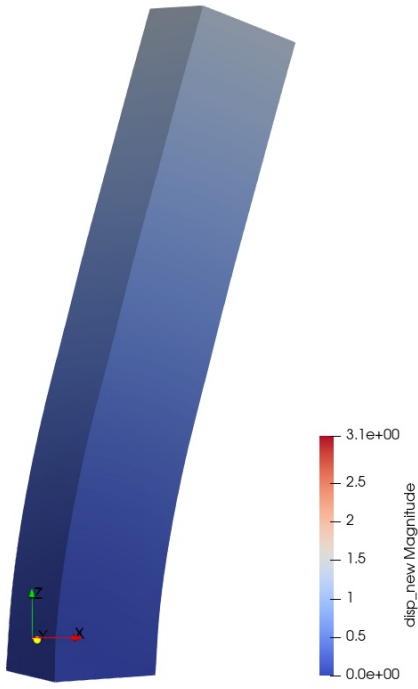
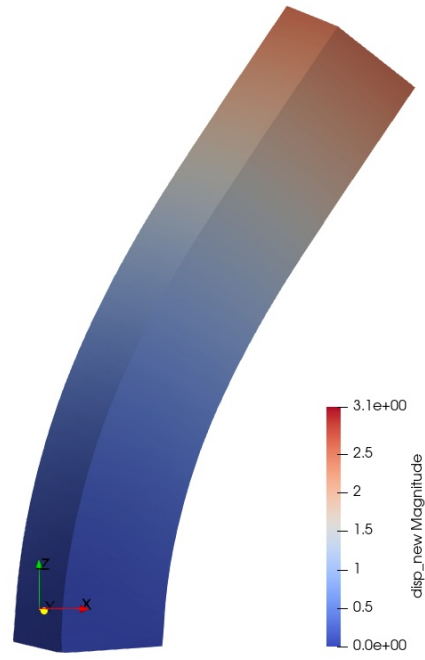

Figure 11: Geometry for the finite strain elasticity problem



(a) $t = \frac{1}{4}T_{\text{end}}$



(b) $t = \frac{1}{2}T_{\text{end}}$

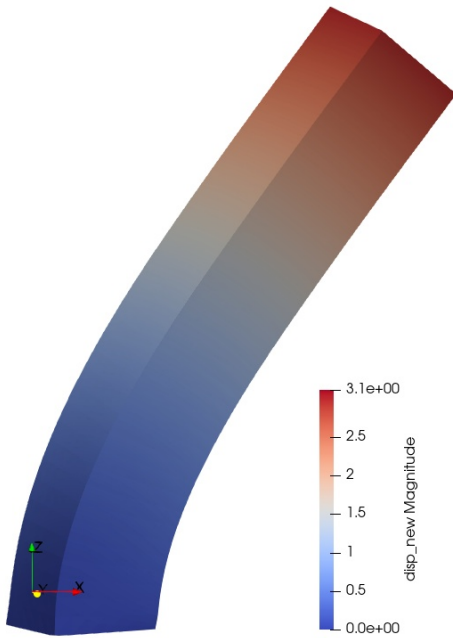

(c) $t = \frac{3}{4}T_{\text{end}}$

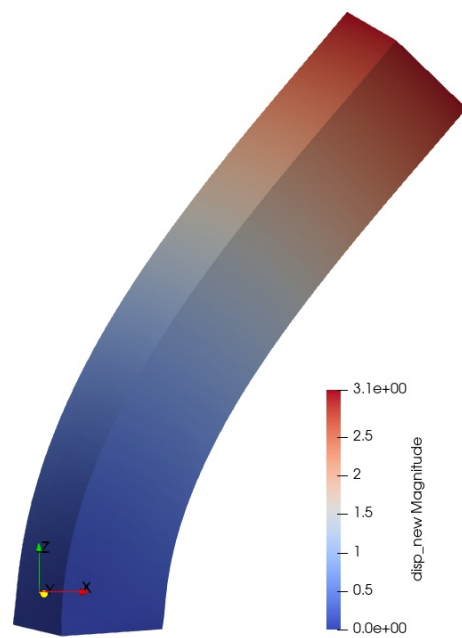

(d) $t = T_{\text{end}}$

Figure 12: Screenshots of solution for finite strain elasticity

physical parameters.

Snapshots of the simulation at different time instants are reported in Fig. 12. The snapshots are computed via the leapfrog method with a time step $\Delta t_{\text{ref}} = \Delta t_{\text{base}}/2^7$. This is also considered to be the reference solution for the convergence rates, reported in Fig. 13. The accuracy for the discrete gradient and the linearly implicit method is again comparable and the leapfrog method is again unstable for the coarsest time step and requires $\Delta t < 0.25\Delta t_{\text{base}}$ to be stable. The mean of the energy difference between adjacent time steps is reported in Fig. 14. The energy conservation is verified for the linearly implicit method and discrete gradient, where the leapfrog is much less accurate in this respect. The computational time is reported in Fig. 15. For this example the system to be solved is in the order of 5000 degrees of freedom and the leapfrog method is only 2 to 3 faster than the linear implicit method. The discrete gradient is one order of magnitude slower than the leapfrog method.

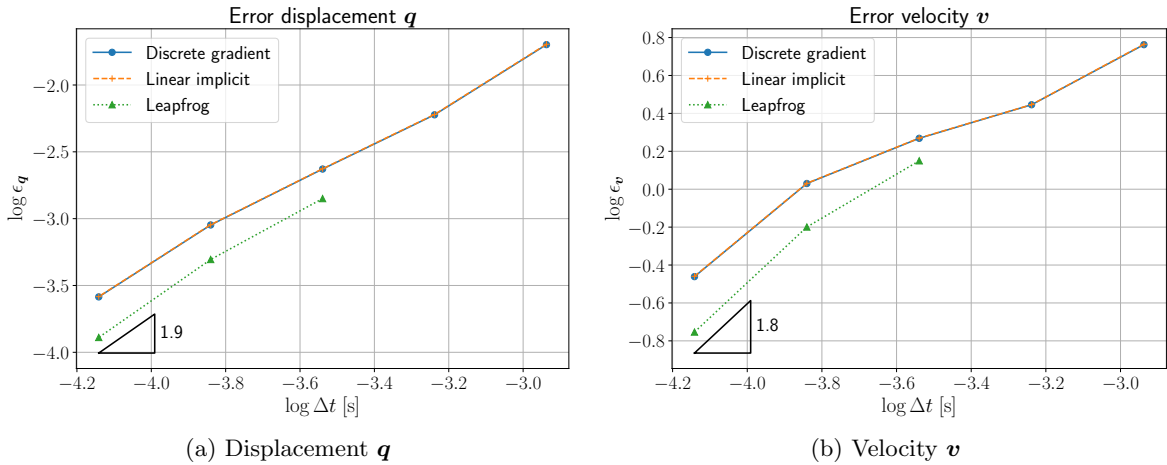

Figure 13: Convergence rate for \mathbf{q} , \mathbf{v} in finite strain elasticity

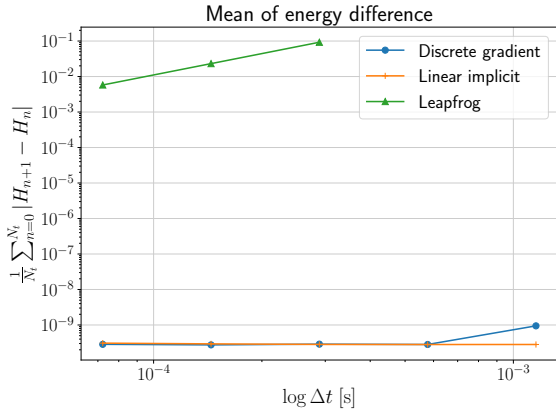

Figure 14: Mean of $|H_{n+1} - H_n|$ for the finite strain elasticity problem

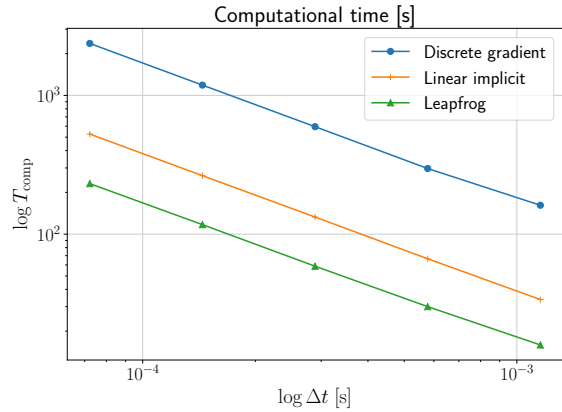

Figure 15: Computational time for finite strain elasticity problem

5 Conclusion

In this contribution we have presented a general framework to recast geometrically nonlinear problems into a non-canonical Hamiltonian formulation. The procedure is detailed for moderate rotations of beams and plates described by von-Kármán nonlinearities and for finite strain elasticity. The methodology is readily applicable to general geometrically nonlinear problems arising in continuum mechanics, like rods, beams, plates, shells and solid mechanics. The non-canonical Hamiltonian structure can be readily discretized by mixed finite elements where the stress field is an additional unknown of the problem. The finite element space used for its approximation needs

to be rich enough in order to accurately describe the geometrically nonlinear effects. Since this variable is discretized using a discontinuous space it can be statically condensed at the discrete time level. The time discretization combines the Störmer Verlet and implicit midpoint methods to achieve an exact energy conservation without requiring the solution of a nonlinear system. It is shown that the time integration strategy is essentially analogous to the one proposed in [25] in the context of the scalar auxiliary variable method. The method exhibits higher accuracy than both the leapfrog and discrete gradient methods when the error is measured against an analytical solution. However, additional tests are required to verify this assertion. The scheme is more efficient than the discrete gradient scheme as it does not require the solution of a nonlinear system and the linear system arising from discrete time is always solvable. As highlighted in the different examples, it is more stable than the leapfrog method, even though generally slower. The numerical results indicate that the methodology is a valid alternative to established time integration strategy in the context of nonlinear elasticity. Future developments may include linear algebra strategies to make the method computationally more efficient. Furthermore, a finite elements and finite differences coupling may be exploited to leverage the intrinsic advantages of the two methods.

Code Availability

The code used for the present work is hosted at:

<https://github.com/a-brugnoli/hamiltonian-geometrically-nonlinear-elasticity/tree/main>

Acknowledgments

The first author would like to thank Jeremy Bleyer for pointing out the possibility of statically condensed the stress variable.

References

- [1] Walter Lacarbonara. *Nonlinear structural mechanics: theory, dynamical phenomena and modeling*. Springer Science & Business Media, New York, NY, 2013.
- [2] Cyril Touzé, Alessandra Vizzaccaro, and Olivier Thomas. Model order reduction methods for geometrically nonlinear structures: a review of nonlinear techniques. *Nonlinear Dynamics*, 105(2):1141–1190, 2021. ISSN 1573-269X. doi: 10.1007/s11071-021-06693-9. URL <https://doi.org/10.1007/s11071-021-06693-9>.
- [3] M.J. Patil and D.H. Hodges. On the importance of aerodynamic and structural geometrical nonlinearities in aeroelastic behavior of high-aspect-ratio wings. *Journal of Fluids and Structures*, 19(7):905–915, 2004. ISSN 0889-9746. doi: 10.1016/j.jfluidstructs.2004.04.012.
- [4] G. Kerschen, M. Peeters, J. C. Golinval, and C. Stéphan. Nonlinear modal analysis of a full-scale aircraft. *Journal of Aircraft*, 50(5):1409–1419, 2013. doi: 10.2514/1.C031918.
- [5] D. I. Manolas, V. A. Riziotis, and S. G. Voutsinas. Assessing the importance of geometric nonlinear effects in the prediction of wind turbine blade loads. *Journal of Computational and Nonlinear Dynamics*, 10(4):041008, 07 2015. ISSN 1555-1415. doi: 10.1115/1.4027684.
- [6] Antoine Chaigne, Cyril Touzé, and Olivier Thomas. Nonlinear vibrations and chaos in gongs and cymbals. *Acoustical Science and Technology*, 26(5):403–409, 2005. doi: 10.1250/ast.26.403.
- [7] Marguerite Jossic, Olivier Thomas, Vivien Denis, Baptiste Chomette, Adrien Mamou-Mani, and David Roze. Effects of internal resonances in the pitch glide of chinese gongs. *The Journal of the Acoustical Society of America*, 144(1):431–442, 07 2018. ISSN 0001-4966. doi: 10.1121/1.5038114.
- [8] A. Lazarus, O. Thomas, and J.-F. Deü. Finite element reduced order models for nonlinear vibrations of piezoelectric layered beams with applications to NEMS. *Finite Elements in Analysis and Design*, 49(1):35–51, 2012. ISSN 0168-874X. doi: 10.1016/j.finel.2011.08.019. Analysis and Design of MEMS/NEMS.

- [9] Giorgio Gobat, Valentina Zega, Patrick Fedeli, Luca Guerinoni, Cyril Touzé, and Attilio Frangi. Reduced order modelling and experimental validation of a MEMS gyroscope test-structure exhibiting 1:2 internal resonance. *Scientific Reports*, 11(1):16390, Aug 2021. ISSN 2045-2322. doi: 10.1038/s41598-021-95793-y.
- [10] Florence Bertails, Basile Audoly, Marie-Paule Cani, Bernard Querleux, Frédéric Leroy, and Jean-Luc Lévêque. Super-helices for predicting the dynamics of natural hair. *ACM Transactions on Graphics (TOG)*, 25(3):1180–1187, 2006.
- [11] Stefan Bilbao. *Numerical sound synthesis: finite difference schemes and simulation in musical acoustics*. John Wiley & Sons, Hoboken, New Jersey, 2009.
- [12] Shobhit Jain and George Haller. How to compute invariant manifolds and their reduced dynamics in high-dimensional finite element models. *Nonlinear dynamics*, 107(2):1417–1450, 2022.
- [13] Marc Artola, Andrew Wynn, and Rafael Palacios. Modal-based nonlinear model predictive control for 3-d very flexible structures. *IEEE Transactions on Automatic Control*, 67(5):2145–2160, 2021.
- [14] Stefan Damian Bilbao. *Wave and scattering methods for the numerical integration of partial differential equations*. PhD thesis, Stanford University, 2001.
- [15] Michele Ducceschi and Stefan Bilbao. Simulation of the geometrically exact nonlinear string via energy quadratisation. *Journal of Sound and Vibration*, 534:117021, 2022. ISSN 0022-460X. doi: 10.1016/j.jsv.2022.117021.
- [16] Konstantin Lipnikov, Gianmarco Manzini, and Mikhail Shashkov. Mimetic finite difference method. *Journal of Computational Physics*, 257:1163–1227, 2014. ISSN 0021-9991. doi: 10.1016/j.jcp.2013.07.031.
- [17] René De Borst, Mike A Crisfield, Joris JC Remmers, and Clemens V Verhoosel. *Nonlinear finite element analysis of solids and structures*. John Wiley & Sons, Hoboken, New Jersey, 2012.
- [18] Nathan M. Newmark. A method of computation for structural dynamics. *Journal of the Engineering Mechanics Division*, 85(EM3):67–94, 1959. doi: 10.1061/JMCEA3.0000098.
- [19] C. Kane, J. E. Marsden, M. Ortiz, and M. West. Variational integrators and the Newmark algorithm for conservative and dissipative mechanical systems. *International Journal for Numerical Methods in Engineering*, 49(10):1295–1325, 2000. doi: 10.1002/1097-0207(20001210)49:10<1295::AID-NME993>3.0.CO;2-W.
- [20] J. C. Simo and N. Tarnow. The discrete energy-momentum method. conserving algorithms for nonlinear elastodynamics. *Zeitschrift für angewandte Mathematik und Physik ZAMP*, 43(5):757–792, Sep 1992. ISSN 1420-9039. doi: 10.1007/BF00913408.
- [21] Robert I. McLachlan, G. R. W. Quispel, and Nicolas Robidoux. Geometric integration using discrete gradients. *Philosophical Transactions of the Royal Society of London. Series A: Mathematical, Physical and Engineering Sciences*, 357(1754):1021–1045, 1999. doi: 10.1098/rsta.1999.0363.
- [22] Marlon Franke, Felix Zählinger, Moritz Hille, Rogelio Ortigosa, Peter Betsch, and Antonio J. Gil. A novel mixed and energy-momentum consistent framework for coupled nonlinear thermo-electro-elastodynamics. *International Journal for Numerical Methods in Engineering*, 124(10):2135–2170, 2023. doi: 10.1002/nme.7209.
- [23] Xiaofeng Yang. Linear, first and second-order, unconditionally energy stable numerical schemes for the phase field model of homopolymer blends. *Journal of Computational Physics*, 327:294–316, 2016. ISSN 0021-9991. doi: 10.1016/j.jcp.2016.09.029.
- [24] Jie Shen, Jie Xu, and Jiang Yang. The scalar auxiliary variable (SAV) approach for gradient flows. *Journal of Computational Physics*, 353:407–416, 2018. ISSN 0021-9991. doi: 10.1016/j.jcp.2017.10.021.

- [25] Stefan Bilbao, Michele Ducceschi, and Fabiana Zama. Explicit exactly energy-conserving methods for Hamiltonian systems. *Journal of Computational Physics*, 472:111697, 2023. ISSN 0021-9991. doi: 10.1016/j.jcp.2022.111697.
- [26] Jack Sherman and Winifred J Morrison. Adjustment of an inverse matrix corresponding to a change in one element of a given matrix. *The Annals of Mathematical Statistics*, 21(1): 124–127, 1950.
- [27] Boris D Andrews and Patrick E Farrell. High-order conservative and accurately dissipative numerical integrators via auxiliary variables. *arXiv preprint arXiv:2407.11904*, 2024.
- [28] Andrea Brugnoli, Denis Matignon, and Joseph Morlier. Exact energy-conserving and linear discretization scheme for geometrically non-linear models. In *16ème Colloque National en Calcul de Structures*, 2024. URL <https://csma2024.sciencesconf.org/500821/document>.
- [29] Andrea Brugnoli, Ramy Rashad, Federico Califano, Stefano Stramigioli, and Denis Matignon. Mixed finite elements for port-Hamiltonian models of von Kármán beams. *IFAC-PapersOnLine*, 54(19):186–191, 2021. doi: 10.1016/j.ifacol.2021.11.076. 7th IFAC Workshop on Lagrangian and Hamiltonian Methods for Nonlinear Control LHMNC 2021.
- [30] Andrea Brugnoli and Denis Matignon. A port-Hamiltonian formulation for the full von-Kármán plate model. In *10th European Nonlinear Dynamics Conference (ENOC)*, Lyon, France, July 17–22 2022. URL <https://enoc2020.sciencesconf.org/340801/document>.
- [31] Ekkehart Kröner. Allgemeine Kontinuumstheorie der Versetzungen und Eigenspannungen. *Archive for Rational Mechanics and Analysis*, 4(1):273–334, Jan 1959. ISSN 1432-0673. doi: 10.1007/BF00281393.
- [32] Tobias Thoma, Paul Kotyczka, and Herbert Egger. On the velocity-stress formulation for geometrically nonlinear elastodynamics and its structure-preserving discretization. *Mathematical and Computer Modelling of Dynamical Systems*, 30(1):701–720, 2024. doi: 10.1080/13873954.2024.2397486.
- [33] S.H. Strogatz. *Nonlinear Dynamics and Chaos: With Applications to Physics, Biology, Chemistry, and Engineering*. CRC Press, Boca Raton, FL, USA, 2 edition, 2018. ISBN 9780429961113.
- [34] Andrea Brugnoli, Daniel Alazard, Valérie Pommier-Budinger, and Denis Matignon. Port-Hamiltonian formulation and symplectic discretization of plate models part II: Kirchhoff model for thin plates. *Applied Mathematical Modelling*, 75:961–981, 2019.
- [35] Stefan Bilbao. A family of conservative finite difference schemes for the dynamical von Kármán plate equations. *Numerical Methods for Partial Differential Equations*, 24(1):193–216, 2008. doi: 10.1002/num.20260.
- [36] Eftychios Sifakis and Jernej Barbic. FEM simulation of 3D deformable solids: a practitioner’s guide to theory, discretization and model reduction. In *ACM SIGGRAPH 2012 Courses*, SIGGRAPH ’12, New York, NY, USA, 2012. Association for Computing Machinery. ISBN 9781450316781. doi: 10.1145/2343483.2343501.
- [37] F. Rathgeber, D.A. Ham, L. Mitchell, M. Lange, F. Luporini, A.T.T. McRae, G.T. Bercea, G.R. Markall, and P.H.J. Kelly. Firedrake: automating the finite element method by composing abstractions. *ACM Transactions on Mathematical Software (TOMS)*, 43(3):24, 2017. doi: 10.1145/2998441.
- [38] T. H. Gibson, L. Mitchell, D. A. Ham, and C. J. Cotter. Slate: extending Firedrake’s domain-specific abstraction to hybridized solvers for geoscience and beyond. *Geoscientific Model Development*, 13(2):735–761, 2020. doi: 10.5194/gmd-13-735-2020.
- [39] A. J. Wathen. Preconditioning. *Acta Numerica*, 24:329–376, 2015. doi: 10.1017/S0962492915000021.
- [40] Guglielmo Scovazzi, Brian Carnes, Xianyi Zeng, and Simone Rossi. A simple, stable, and accurate linear tetrahedral finite element for transient, nearly, and fully incompressible solid dynamics: a dynamic variational multiscale approach. *International Journal for Numerical Methods in Engineering*, 106(10):799–839, 2016. doi: 10.1002/nme.5138.

A Two-dimensional differential operators

Let $\mathbb{V} = \mathbb{R}^2$, $\mathbb{M} = \mathbb{R}^{2 \times 2}$, $\mathbb{S} = \text{sym}(\mathbb{M})$. The rotation of a vector $\mathbf{v} = (v_1 \ v_2)^\top$ is denoted by

$$\begin{pmatrix} v_1 \\ v_2 \end{pmatrix}^\perp := \begin{pmatrix} v_2 \\ -v_1 \end{pmatrix}, \quad \mathbf{v}^\perp = \mathbf{J}\mathbf{v}, \quad \mathbf{J} = \begin{pmatrix} 0 & 1 \\ -1 & 0 \end{pmatrix}.$$

The curl operator of a scalar function provides a vector given by

$$\text{curl } v = \begin{pmatrix} \partial_2 v \\ -\partial_1 v \end{pmatrix} = (\text{grad } v)^\perp = \mathbf{J} \text{grad } v.$$

For a vector $\mathbf{v} = (v_1 \ v_2)^\top$ the $\text{rot} : C^\infty(\mathbb{V}) \rightarrow C^\infty(\mathbb{R})$ operator reads

$$\text{rot } \mathbf{v} = \frac{\partial v_2}{\partial x_1} - \frac{\partial v_1}{\partial x_2} = \text{div } \mathbf{v}^\perp = \text{div}(\mathbf{J}\mathbf{v}).$$

The curl and rot operators are adjoint operators i.e. for vanishing boundary conditions of either variable it holds

$$\begin{aligned} (\mathbf{u}, \text{curl } v)_\Omega &= \int_\Omega \{u_1 \partial_2 v - u_2 \partial_1 v\} d\Omega, \\ &= \int_\Omega (-\partial_2 u_1 + \partial_1 u_2) v d\Omega, \\ &= (\text{rot } \mathbf{u}, v)_\Omega. \end{aligned} \tag{24}$$

When applied to a vector $\mathbf{v} = (v_1 \ v_2)^\top$ the curl operator gives a matrix

$$\text{curl } \mathbf{v} = \begin{bmatrix} \partial_2 v_1 & -\partial_1 v_1 \\ \partial_2 v_2 & -\partial_1 v_2 \end{bmatrix}.$$

The divergence of a matrix is defined row-wise as

$$\text{Div } \mathbf{M} = \begin{pmatrix} \partial_1 M_{11} + \partial_2 M_{12} \\ \partial_1 M_{21} + \partial_2 M_{22} \end{pmatrix}.$$

The rot operator applied to a matrix is defined by

$$\text{Rot } \mathbf{M} = \begin{pmatrix} \partial_1 M_{12} - \partial_2 M_{11} \\ \partial_1 M_{22} - \partial_2 M_{21} \end{pmatrix}.$$

Thus the rot and div operators for matrices are related by $\text{Rot } \mathbf{M} = \text{Div}(\mathbf{M}\mathbf{J}^\top)$. Not surprisingly, the curl operator for vectors and the rot operator for matrices are adjoint operators, i.e. for vanishing boundary conditions

$$(\mathbf{M}, \text{curl } \mathbf{v})_\Omega = (\text{Rot } \mathbf{M}, \mathbf{v})_\Omega. \tag{25}$$

The $\text{Air} : C^\infty(\mathbb{R}) \rightarrow C^\infty(\mathbb{S})$ operator (applied to a scalar function) is then defined as

$$\text{Air } v = \text{curl curl } v = \begin{bmatrix} \partial_{22} v & -\partial_{12} v \\ -\partial_{12} v & \partial_{11} v \end{bmatrix}.$$

Given $\mathbf{S} \in \mathbb{S}$, and from Eqs. (24) and (25) the adjoint of the $\text{Air} = \text{curl curl}$ operator can then be obtained as $\text{Air}^* = \text{rot rot}$

$$\begin{aligned} (\mathbf{S}, \text{Air } v)_\Omega &= (\mathbf{S}, \text{curl curl } v)_\Omega \\ &= (\text{rot } \mathbf{S}, \text{curl } v)_\Omega \\ &= (\text{rot Rot } \mathbf{S}, v)_\Omega. \end{aligned}$$

The rot Rot operator can be seen as a rotated double divergence

$$\text{rot Rot } \mathbf{S} = \text{div Div}(\mathbf{J}\mathbf{S}\mathbf{J}^\top). \tag{26}$$

B Elasticity complex in \mathbb{R}^2

A complex is a sequence of vector spaces connected by differential operators such that the composition of two consecutive operators vanishes. In two dimension, the elasticity complex simplifies into two complex. The first one is the Airy complex

$$\mathbb{P}_1 \xrightarrow{\mathcal{C}} C^\infty \xrightarrow{\text{Air}} C^\infty \otimes \mathbb{S} \xrightarrow{\text{Div}} C^\infty \otimes \mathbb{V} \quad (27)$$

where $\mathbb{P}_1 := \mathbb{R} + \mathbf{x}^\perp \cdot \mathbb{R}^2$ is the space of first order polynomial. The second complex, i.e. the adjoint of the Airy complex, is given by the rot Rot complex

$$\mathbf{RM} \xrightarrow{\mathcal{C}} C^\infty \otimes \mathbb{V} \xrightarrow{\text{def}} C^\infty \otimes \mathbb{S} \xrightarrow{\text{rot Rot}} C^\infty \quad (28)$$

where $\mathbf{RM} = \mathbb{R}^2 + \mathbf{x}^\perp \mathbb{R}$ is the space of rigid body motion. The rot Rot is the adjoint of the Air operator. The key property of a complex in this case reads

$$\text{Div Air} \equiv 0, \quad \text{rot Rot def} \equiv 0.$$