

Improved Fine-Tuning of Large Multimodal Models for Hateful Meme Detection

Jingbiao Mei, Jinghong Chen, Guangyu Yang, Weizhe Lin, Bill Byrne

Department of Engineering

University of Cambridge

Cambridge, United Kingdom, CB2 1PZ

{jm2245, jc2124, gy266, wl356, wjb31}@cam.ac.uk

Abstract

Hateful memes have become a significant concern on the Internet, necessitating robust automated detection systems. While large multimodal models have shown strong generalization across various tasks, they exhibit poor generalization to hateful meme detection due to the dynamic nature of memes tied to emerging social trends and breaking news. Recent work further highlights the limitations of conventional supervised fine-tuning for large multimodal models in this context. To address these challenges, we propose Large Multimodal Model Retrieval-Guided Contrastive Learning (LMM-RGCL), a novel two-stage fine-tuning framework designed to improve both in-domain accuracy and cross-domain generalization. Experimental results on six widely used meme classification datasets demonstrate that LMM-RGCL achieves state-of-the-art performance, outperforming agent-based systems such as VPD-PALI-X-55B. Furthermore, our method effectively generalizes to out-of-domain memes under low-resource settings, surpassing models like GPT-4o.

This paper contains content for demonstration purposes that may be disturbing for some readers.

1 Introduction

The rise of social media has led to a surge in hateful content, notably in the form of memes. Manual detection is infeasible due to the vast amount of content and psychological risks for human moderators. Consequently, hateful meme detection systems have attracted considerable research interest (Kiela et al., 2021; Liu et al., 2022; Prakash et al., 2023; Shah et al., 2024).

Previous studies focus on supervised settings, fine-tuning neural networks with in-domain training data (Pramanick et al., 2021b; Kumar and Nandakumar, 2022; Burbi et al., 2023; Lin et al., 2024). However, real-world challenges arise as memes

continuously evolve with social trends and breaking news. This creates an out-of-domain generalization gap where these systems often fail to recognize new hate patterns (Cao et al., 2024). Frequent re-training becomes impractical given daily content generation rates and associated annotation requirements. These challenges highlight the need for generalizable detection methods that perform well on in-domain examples while maintaining robustness in low-resource, out-of-domain scenarios (Huang et al., 2024).

While large language models (LLMs) have demonstrated strong generalization across various tasks (OpenAI, 2023), recent studies indicate that vanilla Large Multimodal Models (LMMs) struggle with hateful meme detection, both in-domain and out-of-domain (Mei et al., 2024; Huang et al., 2024; Hee et al., 2024; Cao et al., 2024). Notably, Mei et al. (2024) found that fine-tuned CLIP (Radford et al., 2021) outperforms supervised fine-tuned (SFT) LMMs such as LLaVA-13B (Liu et al., 2023b) and Flamingo-80B (Alayrac et al., 2022), thus exposing shortcomings in standard SFT approaches for LMMs. Additionally, they showed that LMMs exhibit poor cross-domain generalization: for instance, a LLaVA model fine-tuned on the HatefulMemes dataset (Kiela et al., 2021) (focusing on racist, sexist, and religion-based hate speech) fails to generalize to HarMeme (Pramanick et al., 2021a), which targets COVID-related political memes. In addition, Huang et al. (2024) observed that hateful meme detection remains challenging for in-context learning framework in LMMs, suggesting that innovative approaches are needed to make better use of few-shot meme examples.

To address these challenges, we propose **Large Multimodal Model Retrieval-Guided Contrastive Learning (LMM-RGCL)**, a two-stage fine-tuning framework designed to improve both in-domain and out-of-domain hateful meme

detection. The first stage, **Joint Multimodal Fine-tuning**, rapidly adapts the LMM to the hateful meme detection task by integrating language modeling loss with cross-entropy loss for the classifier. The second stage, **RGCL Fine-tuning**, learns to discriminate between retrieved positive and negative examples, improving both classification and retrieval capabilities by aligning representations of semantically similar meme pairs. After LMM-RGCL fine-tuning, the learned embedding space enables retrieval-based KNN majority voting, improving classification performance on previously unseen examples. We show that this approach makes better use of few-shot meme examples than in-context learning. LMM-RGCL enables Qwen2VL-7B (Wang et al., 2024) to achieve state-of-the-art performance on six popular meme classification datasets, surpassing larger agent-based systems such as VPD-PALI-X 55B (Hu et al., 2024). Additionally, we show that LMM-RGCL fine-tuned models exhibit significantly stronger generalization to unseen meme datasets compared to standard SFT. Under low-resource settings, Qwen2VL-7B, using the retrieval-based KNN classifier, surpasses models such as GPT-4o (OpenAI, 2024a) and LOREHM with LLaVA-34B (Liu et al., 2023a). Our contributions are:

1. We propose a novel two-stage fine-tuning framework, LMM-RGCL, which integrates joint multimodal fine-tuning with an RGCL fine-tuning phase. This approach optimizes both classification and retrieval capabilities for hateful meme detection.
2. We demonstrate that LMM-RGCL achieves state-of-the-art performance on six widely used meme classification datasets, outperforming larger agent-based systems that rely on standard supervised fine-tuning.
3. We show that LMM-RGCL significantly improves generalization to unseen meme datasets, offering a comprehensive solution for both in-domain and out-of-domain hateful meme detection. To our knowledge, this is the first system to attain state-of-the-art results in both scenarios.

2 Related Work

2.1 Hateful Meme Detection

Most existing approaches to hateful meme detection use supervised learning. Early systems (Zhu,

2020; Muennighoff, 2020) fine-tuned object detection-based vision-language models such as OSCAR (Li et al., 2020), and UNITER (Chen et al., 2020), which utilize Faster R-CNN (Ren et al., 2015)-based object detectors (Anderson et al., 2018; Zhang et al., 2021).

More recently, research has shifted toward CLIP (Radford et al., 2021) for its end-to-end simplicity and stronger multimodal alignment. Numerous studies have fine-tuned models based on CLIP using different modality fusion mechanisms (Pramanick et al., 2021b; Kumar and Nandakumar, 2022; Shah et al., 2024). Other works incorporate caption models into the CLIP-based feature fusion network to further enhance performance (Burbi et al., 2023; Cao et al., 2023; Ji et al., 2024). Additionally, contrastive learning techniques have been explored to address confounding factors in meme classification (Lippe et al., 2020; Mei et al., 2024).

While LMMs such as Flamingo (Alayrac et al., 2022) have shown promise in hateful meme detection via SFT, fine-tuning strategies for LMMs remain underexplored relative to CLIP-based approaches. In fact, Mei et al. (2024) demonstrated that fine-tuned CLIP models can outperform much larger LMMs, highlighting the need for specialized fine-tuning methods. In this work, we propose a novel fine-tuning approach for LMMs to improve their effectiveness in hateful meme detection.

2.2 Low resource hateful meme detection

Low-resource hateful meme detection has received relatively little attention, despite its growing importance in real-world deployments that require out-of-domain generalization. In this setting, an initially trained model is deployed to a new domain without gradient updates, relying only on demonstration examples for inference (Huang et al., 2024). Hee et al. (2024) utilized text similarity-based few-shot examples to help LMMs generalize to unseen memes. Similarly, Hu et al. (2024) and Huang et al. (2024) explored agent-based LMM systems with few-shot learning for out-of-domain settings. However, Huang et al. (2024) observed that in-context learning is less effective for meme classification compared to other tasks, highlighting the need for more effective strategies to use demonstration examples. In contrast, we use a retrieval-based majority voting scheme for classifying unseen memes and find that it makes more effective use of demonstration examples than conventional

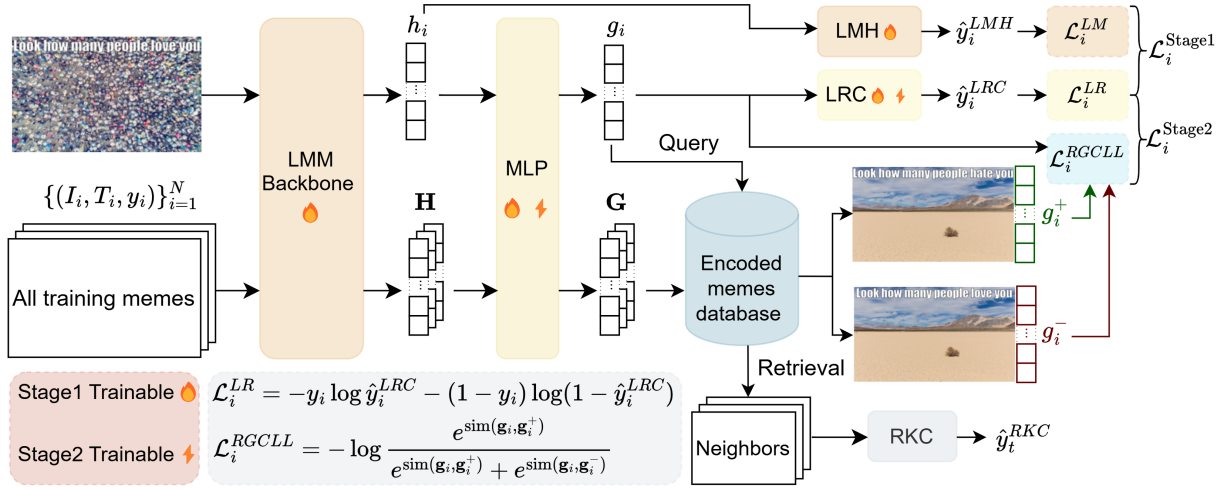

Figure 1: Architecture of LMM-RGCL. We decompose the LMM into two components: the LMM Backbone and the LM Head (LMH). For each training example i , the last hidden state \mathbf{h}_i is fed to the LMH to obtain the LM loss \mathcal{L}_i^{LM} . \mathbf{h}_i is also fed to a trainable multilayer perceptron (MLP) to generate an embedding \mathbf{g}_i for use as a retrieval query and as a feature for the Logistic Regression Classifier (LRC) to compute the cross entropy loss \mathcal{L}_i^{LR} . During training, pseudo-gold and hard negative examples are retrieved from the encoded meme database \mathbf{G} for computing the contrastive loss \mathcal{L}_i^{RGCLL} . At inference, the same process retrieves the K nearest neighbors for Retrieval-based KNN Classification (RKC), which predicts the label \hat{y}_t^{RKC} for an inference example t .

in-context learning.

3 LMM-RGCL Methodology

3.1 Preliminaries

Problem Statement Hateful memes datasets are defined as $\{(I_i, T_i, y_i)\}_{i=1}^N$, where $I_i \in \mathbb{R}^{C \times H \times W}$ is the image portion of the meme in pixels; T_i is the caption overlaid on the meme; $y_i \in \{0, 1\}$ is the label, where 0 stands for benign, 1 for hateful.

Large Multimodal Models Some prior work in using LMMs for hateful meme detection has approached the problem via text generation, where the LMM takes a meme (I_i, T_i) as an input to predict a single token label $\hat{y}_i^{LMH} \in \{\text{“benign”}, \text{“hateful”}\}$ (Lin et al., 2024; Huang et al., 2024). We refer to the final linear layer of the LMM as the LM Head (LMH), which maps hidden representations to a probability distribution over the vocabulary via a softmax function. For meme classification, the LMH decodes the hidden state of the last token and generates the output label. This contrasts with approaches based on CLIP, which train Logistic Regression Classifiers (LRC) on encoder CLS tokens (Kumar and Nandakumar, 2022; Mei et al., 2024).

3.2 LMM-RGCL Framework

Architecture As illustrated in Figure 1, LMM-RGCL integrates an LMM with two additional

trainable components: a Multilayer Perceptron (MLP) that projects the LMM final hidden state \mathbf{h}_i into an embedding \mathbf{g}_i for use in classification and retrieval; and an LRC operating on \mathbf{g}_i . Figure 1 shows how the architecture supports multiple fine-tuning and inference modes.

Retrieval During training, FAISS-based (Johnson et al., 2021) nearest neighbor search retrieves pseudo-gold positive (Mei et al., 2024) and hard negative examples (Schroff et al., 2015) for contrastive learning from the encoded meme database \mathbf{G} . At inference, FAISS is used to retrieve neighbors for the Retrieval-based KNN Classifier (RKC).

Inference modes Figure 1 shows three different classifiers: LMH, LRC, and RKC. For pre-trained and SFT LMMs, we report LMH results following prior work (Section 3.1). For LMM-RGCL models, we report the LRC results, unless otherwise specified. Section 4.5 presents a detailed comparison of the three inference modes.

3.3 Stage 1: Joint Multimodal Fine-tuning

In stage 1, the LMM is fine-tuned via Low-Rank Adaptation (Hu et al., 2022), which applies trainable low-rank matrices to the model while freezing its original weights. The MLP and LRC are updated simultaneously. We optimize the joint loss

for each training example i :

$$\mathcal{L}_i^{\text{Stage1}} = \mathcal{L}_i^{LM} + \mathcal{L}_i^{LR}, \quad (1)$$

where \mathcal{L}_i^{LM} is the language modeling objective used in SFT. In the context of meme classification, the model is trained to predict a single target token $s(y_i)$:

$$s(y_i) = \begin{cases} \text{“benign”} & \text{if } y_i = 0 \\ \text{“hateful”} & \text{if } y_i = 1 \end{cases}. \quad (2)$$

\mathcal{L}_i^{LM} is computed as the negative log-likelihood of generating the correct target token, conditioned on the input image and text:

$$\mathcal{L}_i^{LM} = -\log p(\hat{y}_i^{LMH} = s(y_i) \mid I_i, T_i) \quad (3)$$

The \mathcal{L}_i^{LR} is the binary cross-entropy loss applied to the LRC prediction \hat{y}_i^{LRC} :

$$\mathcal{L}_i^{LR} = -y_i \log \hat{y}_i^{LRC} - (1 - y_i) \log(1 - \hat{y}_i^{LRC}) \quad (4)$$

Jointly optimizing the language modeling loss \mathcal{L}_i^{LM} with the cross-entropy loss \mathcal{L}_i^{LR} allows the LMM to rapidly adapt to the hateful meme detection task.

3.4 Stage 2: RGCL Fine-tuning

In stage 2, the LMM is frozen; only the MLP and LRC are fine-tuned to refine retrieval-aligned representations. Stage 2 jointly optimizes:

$$\mathcal{L}_i^{\text{Stage2}} = \mathcal{L}_i^{RGCLL} + \mathcal{L}_i^{LR}, \quad (5)$$

where \mathcal{L}_i^{LR} is defined in Eq. 4, and \mathcal{L}_i^{RGCLL} is the Retrieval-Guided Contrastive Learning Loss.

To compute \mathcal{L}_i^{RGCLL} , we retrieve pseudo-gold positive and hard negative examples from the training set. Specifically, for a given sample i with embedding \mathbf{g}_i , we use FAISS (Johnson et al., 2021) to perform the nearest neighbor search between \mathbf{g}_i and every other target embedding $\mathbf{g}_j \in \mathbf{G}$ from the training set. The encoded meme database \mathbf{G} is updated every 100 steps during fine-tuning.

Pseudo-gold positive examples are same-label examples that have high similarity scores with \mathbf{g}_i , while hard negative examples are opposite-label examples that have high similarity scores. We denote the embedding of the pseudo-gold positive example and hard negative example as \mathbf{g}_i^+ and \mathbf{g}_i^- , respectively. \mathcal{L}_i^{RGCLL} is then computed as:

$$\begin{aligned} \mathcal{L}_i^{RGCLL} &= L(\mathbf{g}_i, \mathbf{g}_i^+, \mathbf{g}_i^-) \\ &= -\log \frac{e^{\text{sim}(\mathbf{g}_i, \mathbf{g}_i^+)}}{e^{\text{sim}(\mathbf{g}_i, \mathbf{g}_i^+)} + e^{\text{sim}(\mathbf{g}_i, \mathbf{g}_i^-)}}, \end{aligned} \quad (6)$$

where $\text{sim}(\cdot, \cdot)$ denotes the cosine similarity function. Stage 2 fine-tuning explicitly aligns the representations of semantically similar meme pairs, thereby improving the generalization of LMMs to distribution shifts in unseen datasets.

3.5 Retrieval Based KNN Classification

In addition to the LMH and LRC, RKC is used specifically for out-of-domain meme classification. For a test meme t , we retrieve K similar memes within the embedding space from the meme database \mathbf{G} . We perform similarity-weighted majority voting to obtain the prediction:

$$\hat{y}_t^{RKC} = \sigma\left(\sum_{k=1}^K \bar{y}_k \cdot \text{sim}(g_k, g_t)\right), \quad (7)$$

where $\sigma(\cdot)$ is the sigmoid function and

$$\bar{y}_k := \begin{cases} 1 & \text{if } y_k = 1 \\ -1 & \text{if } y_k = 0 \end{cases}. \quad (8)$$

Additionally, to enable RKC on pretrained or SFT LMMs that do not incorporate an MLP, we use the last hidden state \mathbf{h}_i for the nearest neighbor search. The results are provided in Appendix D.

4 Experiments

We evaluate the performance of our systems on six popular meme classification datasets: **Hateful-Memes** (Kiela et al., 2021), **HarMeme** (Pramanick et al., 2021a), **MAMI** (Fersini et al., 2022), **Harm-P** (Pramanick et al., 2021b), **MultiOFF** (Suryawan-shi et al., 2020) and **PrideMM** (Shah et al., 2024). These datasets encompass varying definitions of harmful content (hateful, offensive, or targeted harassment) across different sociopolitical contexts. A detailed description and statistics are in Appendix A.

For HatefulMemes, HarMeme, and MAMI, we report the Area Under the Receiver Operating Characteristic Curve (AUC) and Accuracy (Acc) in line with previous studies (Kumar and Nandakumar, 2022; Cao et al., 2023; Mei et al., 2024; Cao et al., 2024). For Harm-P, MultiOFF, and PrideMM, we report Accuracy and F1 score consistent with the literature (Pramanick et al., 2021b; Mei et al., 2024; Shah et al., 2024; Lin et al., 2024). Implementation details, including hyperparameters, and statistical significance test procedures are detailed in Appendix B.

Model	HatefulMemes		HarMeme		MAMI		Harm-P		MultiOFF		PrideMM		
	AUC	Acc.	AUC	Acc.	AUC	Acc.	Acc.	F1	Acc.	F1	Acc.	F1	
Best prior results	VPD-55B		ISSUES		Pro-Cap		ExplainHM		RGCL		MemeCLIP		
	89.2	80.8	92.8	81.6	83.8	73.6	<u>90.7</u>	<u>90.7</u>	67.1	58.1	76.1	75.1	
<i>Supervised fine-tuned CLIP-based Classifiers</i>													
1	CLIP	79.8	72.0	82.6	76.8	77.7	68.4	80.6	80.3	62.4	48.1	72.4	72.3
2	MOMENTA	69.2	61.3	86.3	80.5	81.7	72.1	89.8	88.3	-	-	72.2	71.8
3	HateCLIPper	85.5	76.1	89.7	84.8	87.2	74.8	87.6	86.9	62.4	54.8	75.5	74.1
4	RGCL	87.0	78.8	91.8	87.0	89.4	78.4	89.9	89.5	67.1	58.1	76.3	76.5
<i>Large Multimodal Models</i>													
5	LLaVA-1.5-7B												
	w/ zero-shot	63.7	57.6	71.4	48.6	67.6	58.3	61.6	46.4	59.6	51.7	63.4	65.6
6	w/ few-shot	63.4	57.2	73.4	59.6	68.1	62.7	53.5	52.2	38.9	56.0	62.1	64.0
7	w/ SFT	85.2	78.7	91.4	79.1	86.0	73.9	82.8	82.8	67.8	57.8	73.2	76.0
8	w/ LMM-RGCL	<u>89.7</u>	<u>80.9</u>	93.5	88.2	91.2	<u>79.7</u>	89.6	89.3	<u>70.9</u>	<u>63.6</u>	78.1	78.7
	p-value	$9.8e^{-3}$	$3.5e^{-3}$	$1.2e^{-2}$	$8.5e^{-3}$	$4.4e^{-3}$	$6.2e^{-3}$	$2.5e^{-3}$	$1.6e^{-3}$	$6.1e^{-3}$	$4.6e^{-3}$	$5.6e^{-3}$	$8.9e^{-3}$
9	Qwen2VL-2B												
	w/ zero-shot	64.8	54.2	61.1	56.7	67.2	51.0	53.9	21.8	63.1	36.3	57.8	53.3
10	w/ few-shot	61.7	59.1	62.1	65.8	64.8	58.8	53.0	51.6	67.1	44.9	55.4	54.3
11	w/ SFT	84.0	76.2	90.2	82.5	77.7	68.6	80.3	79.7	66.4	54.5	73.7	74.2
12	w/ LMM-RGCL	88.4	79.1	92.9	87.7	89.3	79.4	88.9	88.7	68.5	61.8	76.0	76.7
	p-value	$4.2e^{-3}$	$4.8e^{-3}$	$9.1e^{-3}$	$7.6e^{-3}$	$6.5e^{-4}$	$1.9e^{-4}$	$9.3e^{-4}$	$1.1e^{-3}$	$2.0e^{-2}$	$7.7e^{-3}$	$7.1e^{-3}$	$8.3e^{-3}$
13	Qwen2VL-7B												
	w/ zero-shot	71.9	63.2	64.8	64.1	76.2	58.5	55.5	22.9	63.4	35.9	65.3	62.9
14	w/ few-shot	71.5	63.8	71.5	67.2	73.4	66.1	55.6	65.2	64.4	54.7	69.1	56.6
15	w/ SFT	86.3	78.6	91.8	85.9	82.6	72.4	85.9	86.3	67.8	55.5	75.1	74.9
16	w/ LMM-RGCL	91.1	82.1	<u>93.2</u>	<u>88.1</u>	<u>90.4</u>	79.9	91.6	91.1	71.1	64.8	78.1	<u>78.4</u>
	p-value	$8.7e^{-4}$	$2.4e^{-3}$	$3.5e^{-2}$	$1.6e^{-2}$	$2.5e^{-3}$	$2.6e^{-3}$	$6.3e^{-3}$	$8.6e^{-3}$	$1.3e^{-2}$	$5.9e^{-3}$	$9.2e^{-3}$	$7.2e^{-3}$

Table 1: Comparison with baseline systems under supervised settings. For large multimodal models, we report the pre-trained models zero-shot and few-shot performance (using 4-shot evaluation), along with a comparison between SFT and LMM-RGCL. Additionally, for each LMM, we provide the p -value from significance testing between SFT and LMM-RGCL. All p -values are below 0.05. Best performance is highlighted in **bold**; second-best is underlined.

4.1 Comparing LMM-RGCL to Baseline Systems under Supervised Settings

Table 1 presents the performance of baseline systems under supervised fine-tuning settings. We compare LMM-RGCL against a range of strong baselines: the best prior models for each dataset¹; supervised fine-tuned CLIP-based classifiers; and Large Multimodal Models (LMMs). All models are fine-tuned and evaluated for each dataset separately.

CLIP-based Classifiers We compare the performance of fine-tuned CLIP (Radford et al., 2021) model with three other fine-tuning methods for CLIP-based systems: MOMENTA (Pramanick et al., 2021b), HateCLIPper (Kumar and Nandakumar, 2022) and RGCL (Mei et al., 2024).

Large Multimodal Models We experiment with three LMMs from two model families: LLaVA-1.5-7B (Liu et al., 2023a), Qwen2VL-2B and Qwen2VL-7B (Wang et al., 2024). We report the performance of these LMMs in the following settings: pre-trained models with zero-shot and few-

shot prompts using the LMH; SFT LMMs using the LMH; and classification using LRC under the LMM-RGCL fine-tuning framework.

Best Prior Models Visual Program Distillation (VPD) (Hu et al., 2024) and ExplainHM (Lin et al., 2024) are LLM agent-based systems. The remaining state-of-the-art models, including ISSUES (Burbi et al., 2023), Pro-Cap (Cao et al., 2023), RGCL (Mei et al., 2024) and MemeCLIP (Shah et al., 2024), are based on fine-tuning CLIP-based vision and language models. Detailed descriptions of these methods are provided in Appendix C.

Observation 1: Fine-tuned CLIP-based classifiers outperform baseline LMMs.

As shown in Table 1, RGCL (#4) achieves the highest performance among CLIP-based classifiers, surpassing standard fine-tuned CLIP (#1) by approximately 10% across multiple datasets. On 5 out of 6 datasets, RGCL performs better than, or on par with, all three SFT LMMs (#7, #11, #15).

Observation 2: In-context learning exhibits limited efficacy for meme classification.

We compare the zero-shot (#5, #9, #13) and few-shot (#6, #10, #14) performance of the pre-trained

¹From a recent paper (Nguyen and Ng, 2024); some datasets have been updated with the new best results.

Evaluated on Model		HatefulMemes		HarMeme		MAMI		Harm-P		MultiOFF		PrideMM	
		AUC	Acc.	AUC	Acc.	AUC	Acc.	Acc.	F1	Acc.	F1	Acc.	F1
<i>Low resourced systems</i>													
1	GPT-4o	-	65.0	-	67.2	-	62.9	52.4	5.6	63.1	15.4	58.0	25.8
2	Mod-Hate	64.5	58.0	73.4	69.5	67.4	61.0	-	-	-	-	-	-
3	LOREHM	-	<u>65.6</u>	-	73.7	-	<u>75.4</u>	-	-	-	-	-	-
<i>Systems fine-tuned under cross-dataset settings</i>													
Fine-tuning set		HarMeme		HatefulMemes									
4	RGCL	69.9	66.9	64.3	61.1	67.8	62.4	56.4	57.1	53.7	45.1	59.8	61.5
	LLaVA-1.5-7B												
5	SFT + zero-shot	63.8	59.4	61.9	48.5	69.1	61.1	55.2	28.7	62.8	32.5	58.1	53.3
6	SFT + few-shot	63.1	56.4	69.9	52.8	65.5	50.1	55.6	49.6	56.0	38.9	48.5	55.3
7	LMM-RGCL + RKC	<u>74.2</u>	65.2	89.5	81.9	<u>80.0</u>	74.5	67.3	67.8	62.4	51.7	68.8	67.7
	Qwen2VL-2B												
8	SFT + zero-shot	64.1	59.7	61.3	52.2	66.4	57.3	53.5	20.3	62.3	29.3	56.4	59.0
9	SFT + few-shot	61.3	53.8	57.4	65.0	73.8	66.0	56.9	55.5	53.7	42.4	55.4	60.9
10	LMM-RGCL + RKC	70.9	62.8	86.0	78.4	74.8	72.3	63.4	66.0	<u>63.4</u>	53.4	<u>69.0</u>	<u>69.1</u>
	Qwen2VL-7B												
11	SFT + zero-shot	71.1	64.1	63.0	55.2	71.1	61.9	54.7	21.5	63.1	29.7	64.5	63.6
12	SFT + few-shot	72.3	60.6	67.2	62.4	73.4	66.0	56.4	64.9	62.0	<u>53.7</u>	55.4	60.9
13	LMM-RGCL + RKC	77.1	69.3	<u>88.8</u>	<u>81.7</u>	81.4	75.6	<u>64.5</u>	<u>66.4</u>	63.8	55.6	69.3	69.3

Table 2: Comparing out-of-domain meme classification performance under low-resource settings. For systems fine-tuned under cross-dataset settings, models are fine-tuned on HarMeme and evaluated on the HatefulMemes dataset. For the remaining evaluation datasets, models are fine-tuned on the HatefulMemes dataset. For LMMs, we compare the SFT models using zero-shot and in-context learning with the LMM-RGCL fine-tuned models using RKC. Few-shot examples (4-shot) and RKC examples are drawn from the training split of each evaluation dataset. #2 and #3 are taken from the original paper. Best performance is highlighted in **bold**; second-best is underlined.

LMMs. Our findings indicate that, unlike in some other tasks, in-context learning does not benefit meme classification, which is consistent with previous results (Hee et al., 2024; Huang et al., 2024). HarMeme is the only dataset where few-shot systems consistently outperform zero-shot systems. On Harm-P and MultiOFF, although the accuracies of zero-shot and few-shot remain comparable, the few-shot experiments yield a significant gain in F1 score. This improvement is due to a more balanced precision and recall after providing demonstration examples to the system.

Observation 3: LMM-RGCL outperforms all strong baseline systems across six datasets

For the six datasets and the three LMMs, fine-tuning with LMM-RGCL significantly improves performance over SFT (Table 1: #7, #8; #11, #12; #15, #16). Statistical significance tests between LMM-RGCL and SFT further confirm this, with all p -values below 0.05. Notably, as indicated in #16, Qwen2VL-7B fine-tuned with LMM-RGCL outperforms VPD-PaLI-X-55B on HatefulMemes. Moreover, LMM-RGCL improves upon RGCL with gains of over 4% in AUC and 3% in accuracy on HatefulMemes. These gains show LMM-RGCL’s effectiveness in improving LMMs

for meme classification over SFT.

4.2 Comparing LMM-RGCL with Baseline Systems under Low-Resource Settings

Online hate speech is constantly evolving, posing a challenge to systems as the distribution of memes encountered in the wild departs from that of the training data. To simulate real-world deployment constraints, we evaluate systems on out-of-domain examples under low-resource settings where gradient updates are prohibited and only demonstration examples are available (Huang et al., 2024; Hee et al., 2024; Cao et al., 2024).

We adopt a cross-dataset evaluation protocol similar to Mei et al. (2024): models fine-tuned on **HarMeme** are evaluated on **HatefulMemes**, while models trained on **HatefulMemes** are evaluated on all other datasets. This protocol simulates a scenario in which a trained meme classification system is deployed to evaluate trending memes. Few-shot and RKC examples are drawn from the training split of each of the target evaluation datasets to avoid test set contamination.

We compare LMM-RGCL fine-tuned LMM with the RKC against the following systems: SFT LMMs with zero-shot and few-shot prompting us-

ing LMH; GPT-4o (OpenAI, 2024a); specialized low-resource systems (LOREHM (Huang et al., 2024), Mod-hate (Cao et al., 2024)). For GPT-4o, the token likelihood is not accessible to compute the AUC score. For Mod-Hate and LOREHM, we report the results from the original papers.

Observation 1: Fine-tuning on one memes classification dataset does not help LMMs to improve generalization on other meme classification datasets

Cross-domain fine-tuned LMMs show no consistent improvements over pre-trained LMMs for either zero-shot or few-shot prompting. Qwen2VL-7B zero-shot (#11 in Table 2) matches its SFT model performance (#13 in Table 1) on HatefulMemes and PrideMM but has performance degradation on the remaining four datasets.

Observation 2: In-context learning remains ineffective for SFT LMMs

As shown in Table 2 #6, #9 and #12, the few-shot approach remains similarly ineffective after LMMs are fine-tuned on different domains of hateful meme datasets, offering no significant gains over the SFT zero-shot models (Table 2 #5, #8, #11). In Section 4.4, we further compare the number of shots for in-context learning and find that adding more shots does not improve performance.

Observation 3: LMM-RGCL fine-tuned LMMs with RKC inference mode outperforms baseline methods

LMM-RGCL fine-tuned LMMs using RKC outperform the baseline SFT LMMs in both zero-shot and few-shot settings under the same cross-dataset fine-tuning settings. Notably, LMM-RGCL trained Qwen2VL-7B with RKC improves over the baseline SFT few-shot model by 21.6% in AUC and 19.3% in accuracy on HarMeme (Table 2 #11-13). The ablation study in Section 4.4, which varies the number of top k for RKC, further demonstrates that RKC uses demonstration examples more effectively than the few-shot in-context learning framework. Additionally, we compare RKC results for pre-trained and SFT LMMs in Appendix D.

Observation 4: LMM-RGCL trained LMMs with RKC inference outperform other low resource methods

Compared to GPT-4o, our LMM-RGCL fine-tuned Qwen2VL-7B with RKC achieves 14.5% higher accuracy on HarMeme and 11.3% higher accuracy on PrideMM. When compared to other low-resource methods using similar open-source LMMs, our

LMM-RGCL fine-tuned LLaVA-1.5-7B with RKC matches the performance of LOREHM on the HatefulMemes dataset. Notably, LOREHM uses a much larger LLaVA-1.6-34B within an agent-based framework. Furthermore, our method outperforms LOREHM by 8.2% in accuracy on HarMeme, highlighting our methods’ effectiveness under low-resource settings.

4.3 Effects of Two-Stage Fine-tuning

We assess the impact of each stage in the two-stage LMM-RGCL fine-tuning process. As shown in Table 3a and Table 3b, omitting either stage results in performance losses under both supervised and cross-dataset settings. Excluding Stage 1 results in the largest performance drop, particularly because the Large Multimodal Model (LMM) backbone remains frozen during Stage 2.

Mode	HatefulMemes		HarMeme	
	AUC	Acc.	AUC	Acc.
LMM-RGCL	91.1	82.1	93.2	88.1
<i>w/o Stage 1</i>	84.4	74.2	90.1	85.6
<i>w/o Stage 2</i>	90.2	81.4	92.0	86.2
<i>Combined stages</i>	88.9	77.8	90.2	83.4

(a) Supervised settings, see Table 1 for detailed settings

Mode	HatefulMemes		HarMeme	
	AUC	Acc.	AUC	Acc.
LMM-RGCL	77.1	69.3	88.8	81.7
<i>w/o Stage 1</i>	72.0	62.1	84.9	78.1
<i>w/o Stage 2</i>	74.4	66.7	86.3	78.7
<i>Combined stages</i>	72.2	65.3	87.5	80.2

(b) Cross-dataset settings, see Table 2 for detailed settings

Table 3: Ablation study of LMM-RGCL two-stage fine-tuning framework on Qwen2VL-7B, evaluating the impact of Stage 1 Joint Multimodal Fine-tuning and Stage 2 RGCL Fine-tuning. For ‘combined stages’, we jointly optimize the three loss objectives from both stages in a single training process.

When stage 2 is omitted, the performance loss in supervised settings is less severe than in cross-dataset settings. We attribute this to the use of contrastive loss in Stage 2, which explicitly optimizes retrieval capabilities by aligning representations of semantically similar meme pairs. This alignment enhances robustness to distribution shifts in unseen datasets.

For ‘combined stages’, we jointly optimize the objectives for both stages:

$$\mathcal{L}_i^{\text{Combined}} = \mathcal{L}_i^{\text{RGCLL}} + \mathcal{L}_i^{\text{LR}} + \mathcal{L}_i^{\text{LM}}. \quad (9)$$

It yields suboptimal results, with performance drops of 2.2% AUC on HatefulMemes and 3.0% AUC on HarMeme under supervised settings. These results show that the two-stage fine-tuning approach effectively mitigates the optimization conflict between task adaptation in stage 1 and representation alignment in stage 2. Furthermore, since the LMM remains trainable under this combined loss objective, updating the encoded meme database incurs significantly higher computational costs compared to the two-stage fine-tuning approach, where the LMM is frozen in stage 2. This separation of fine-tuning stages enables more efficient training while preserving strong performance. Additional details on training time are provided in Appendix B.

For each stage, we perform an ablation study by removing individual loss objectives during fine-tuning. Our results indicate that each term is essential for optimal performance. Detailed results are provided in Appendix E.

4.4 Numbers of Shots and Neighbors

We ablate the effects of varying the number of shots for few-shot in-context learning and varying the number of top K nearest neighbors for RKC.

Figure 2 demonstrates that increasing the number of in-context examples for LMMs does not consistently yield performance improvements over the zero-shot setting, and in some cases even causes loss. These findings suggest that merely adding more shots does not necessarily improve performance, which is consistent with findings from Huang et al. (2024).

Figure 2 shows that as the number of nearest neighbors K for RKC increases, the performance continues to increase for both AUC and accuracy, plateauing at around $K = 20$. The consistent improvement in performance indicates that RKC trained with LMM-RGCL utilizes demonstration examples more effectively than the standard in-context learning framework.

4.5 Comparing Different Inference Modes

Table 4 compares Qwen2VL-7B fine-tuned with LMM-RGCL using the three classifiers. Our results indicate that under supervised settings, the differences among the three inference modes are minimal. However, under cross-dataset settings, there is a significant disparity in generalization performance. Notably, RKC outperforms both LMH

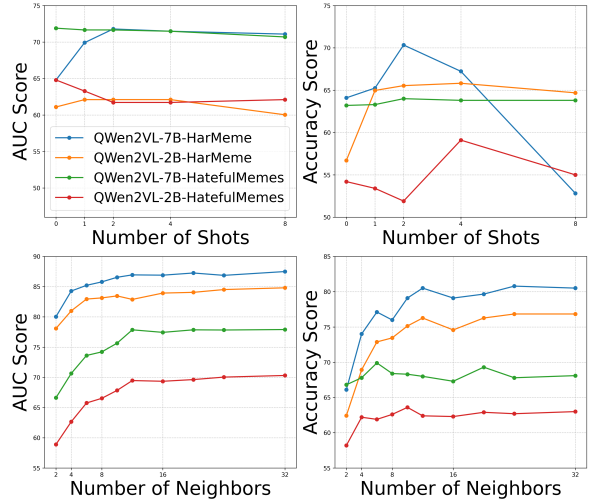

Figure 2: Effects of increasing number of shots for in-context learning with pre-trained LMM and effects of increasing top K nearest neighbors for RKC trained with LMM-RGCL

and LRC, underscoring its superior effectiveness in handling out-of-domain examples.

Inference Mode	HatefulMemes		HarMeme	
	AUC	Acc.	AUC	Acc.
LMH	90.2	81.9	92.8	88.0
LRC	91.1	82.1	93.2	88.1
RKC	90.8	81.8	93.2	88.0

(a) Supervised settings, see Table 1 for detailed settings

Inference Mode	HatefulMemes		HarMeme	
	AUC	Acc.	AUC	Acc.
LMH	70.2	64.3	64.5	60.3
LRC	59.5	55.4	57.9	52.2
RKC	77.1	69.3	88.8	81.7

(b) Cross-dataset settings, see Table 2 for detailed settings

Table 4: Comparing different inference modes using LMM-RGCL fine-tuned Qwen2VL-7B. RKC shows much better out-of-domain generalization compared to other inference modes.

5 Conclusion

We propose LMM-RGCL, a two-stage fine-tuning framework designed to improve LMM performance on hateful meme classification, addressing the ineffectiveness of standard SFT. Our approach effectively improves both in-domain accuracy and cross-domain generalization. State-of-the-art performance across six meme classification datasets demonstrates the effectiveness of LMM-RGCL.

Limitations

Hate speech is described using various terminologies, including online harassment, online aggression, cyberbullying, and harmful speech. The United Nations Strategy and Plan of Action on Hate Speech acknowledges that definitions of hate speech can be controversial and subject to debate (Nderitu, 2020). Similarly, the UK Online Harms White Paper highlights that certain harms may be insufficiently defined (Woodhouse, 2022).

We acknowledge that the definition of hate speech can be subjective and varies across different cultural and legal contexts. To this end, we evaluate our methods on six widely used meme classification datasets, allowing for generalization across different definitions of hate speech. As the discourse on defining hate speech evolves, we align our research with this ongoing process and plan to incorporate new datasets as they become available.

In our error analysis, we find that the system is unable to recognize subtle visual details in memes. Enhancing image understanding through a more powerful vision encoder could further improve performance, which we leave for future work.

Ethical Statement

Reproducibility. Detailed experimental setups, implementation specifics, and hyperparameter settings are provided in Appendix B to ensure reproducibility. The source code will be released upon publication.

Usage of Datasets. The datasets used in this study—HatefulMemes, HarMeme, MAMI, HarmP, MultiOFF, and PrideMM—were curated for research purposes to combat online hate speech. We strictly adhere to the terms of use established by the dataset authors.

Societal benefits. Hateful meme detection systems, like LMM-RGCL, can be used to automatically detect hateful content online, contributing significantly to reducing online hate speech. By reducing hate speech, fostering safer digital environments, and supporting human content moderators, these systems can make a significant impact on online communication and safety. We believe these benefits are both substantial and essential in the broader effort to create a more secure and respectful digital space.

Intended use. We intend to enforce strict access controls for model release. The model will be available only to researchers who agree to our terms of use, which explicitly state that the system is designed solely for the detection and prevention of hateful speech. Its use for any purposes that promote, condone, or encourage hate speech or harmful content is strictly prohibited.

Misuse Potential. Although our system is not inherently designed to induce bias, training on existing datasets such as HatefulMemes may inadvertently propagate existing biases towards certain individuals, groups, or entities (Pramanick et al., 2021b). To mitigate the risk of unfair moderation resulting from these dataset-induced biases, it is essential to incorporate human oversight into the moderation process if deployed.

Deployment consideration. Cultural differences and subjective topics introduce biases in moderating online hate speech. Expressions that may seem benign to some can be deeply offensive to others. Our RKC inference mode relies on retrieving examples that generalize well across various domains, allowing the creation of multiple retrieval sets tailored to diverse cultural sensitivities without requiring retraining. However, before deploying such systems, it is crucial to carefully evaluate dataset annotations, particularly when addressing cultural differences and subjective interpretations. Key factors include data curation guidelines, potential annotator biases, and the inherently context-dependent definitions of hate speech. These considerations are essential to ensuring the system is deployed responsibly and effectively across varied cultural contexts.

Environmental Impact Training large-scale models is computationally intensive and contribute to global warming due to heavy GPU/TPU usage. However, our approach mitigates this issue by fine-tuning LMMs using quantized LoRA, a parameter-efficient method. As a result, our system can be trained in under four hours on a single GPU, significantly reducing both training time and computational cost compared to full-scale LMM fine-tuning. Furthermore, since our method generalizes across different domains without requiring retraining, it further minimizes computational overhead.

References

- Jean-Baptiste Alayrac, Jeff Donahue, Pauline Luc, Antoine Miech, Iain Barr, Yana Hasson, Karel Lenc, Arthur Mensch, Katherine Millican, Malcolm Reynolds, Roman Ring, Eliza Rutherford, Serkan Cabi, Tengda Han, Zhitao Gong, Sina Samangooei, Marianne Monteiro, Jacob L. Menick, Sebastian Borgeaud, Andy Brock, Aida Nematzadeh, Sahand Sharifzadeh, Miłkołaj Bińkowski, Ricardo Barreira, Oriol Vinyals, Andrew Zisserman, and Karén Simonyan. 2022. [Flamingo: a visual language model for few-shot learning](#). *Advances in Neural Information Processing Systems*, 35:23716–23736.
- Peter Anderson, Xiaodong He, Chris Buehler, Damien Teney, Mark Johnson, Stephen Gould, and Lei Zhang. 2018. [Bottom-up and top-down attention for image captioning and visual question answering](#). In *2018 IEEE/CVF Conference on Computer Vision and Pattern Recognition*, page 6077–6086.
- Giovanni Burbi, Alberto Baldrati, Lorenzo Agnolucci, Marco Bertini, and Alberto Del Bimbo. 2023. [Mapping memes to words for multimodal hateful meme classification](#). In *2023 IEEE/CVF International Conference on Computer Vision Workshops (ICCVW)*, pages 2824–2828.
- Rui Cao, Ming Shan Hee, Adriel Kuek, Wen-Haw Chong, Roy Ka-Wei Lee, and Jing Jiang. 2023. [Procap: Leveraging a frozen vision-language model for hateful meme detection](#). In *Proceedings of the 31st ACM International Conference on Multimedia*, MM '23, page 5244–5252. Association for Computing Machinery.
- Rui Cao, Roy Ka-Wei Lee, Wen-Haw Chong, and Jing Jiang. 2022. [Prompting for multimodal hateful meme classification](#). In *Proceedings of the 2022 Conference on Empirical Methods in Natural Language Processing*, pages 321–332, Abu Dhabi, United Arab Emirates. Association for Computational Linguistics.
- Rui Cao, Roy Ka-Wei Lee, and Jing Jiang. 2024. [Modularized networks for few-shot hateful meme detection](#). In *Proceedings of the ACM Web Conference 2024*, WWW '24, page 4575–4584. Association for Computing Machinery.
- Yen-Chun Chen, Linjie Li, Licheng Yu, Ahmed El Kholy, Faisal Ahmed, Zhe Gan, Yu Cheng, and Jingjing Liu. 2020. [UNITER: UNiversal Image-TExt Representation Learning](#), volume 12375 of *Lecture Notes in Computer Science*, page 104–120. Springer International Publishing, Cham.
- Wenliang Dai, Junnan Li, Dongxu Li, Anthony Meng Huat Tiong, Junqi Zhao, Weisheng Wang, Boyang Li, Pascale Fung, and Steven Hoi. 2023. [Instructblip: Towards general-purpose vision-language models with instruction tuning](#). (arXiv:2305.06500). ArXiv:2305.06500 [cs].
- DeepSeek-AI. 2025. [Deepseek-r1: Incentivizing reasoning capability in llms via reinforcement learning](#). (arXiv:2501.12948). ArXiv:2501.12948 [cs].
- Tim Dettmers, Artidoro Pagnoni, Ari Holtzman, and Luke Zettlemoyer. 2023. [Qlora: Efficient fine-tuning of quantized llms](#). (arXiv:2305.14314). ArXiv:2305.14314 [cs].
- Elisabetta Fersini, Francesca Gasparini, Giulia Rizzi, Aurora Saibene, Berta Chulvi, Paolo Rosso, Alyssa Lees, and Jeffrey Sorensen. 2022. [Semeval-2022 task 5: Multimedia automatic misogyny identification](#). In *Proceedings of the 16th International Workshop on Semantic Evaluation (SemEval-2022)*, page 533–549, Seattle, United States. Association for Computational Linguistics.
- Ming Shan Hee, Aditi Kumaresan, and Roy Ka-Wei Lee. 2024. [Bridging modalities: Enhancing cross-modality hate speech detection with few-shot in-context learning](#). In *Proceedings of the 2024 Conference on Empirical Methods in Natural Language Processing*, page 7785–7799, Miami, Florida, USA. Association for Computational Linguistics.
- Edward J Hu, Yelong Shen, Phillip Wallis, Zeyuan Allen-Zhu, Yuanzhi Li, Shean Wang, Lu Wang, and Weizhu Chen. 2022. [LoRA: Low-rank adaptation of large language models](#). In *International Conference on Learning Representations*.
- Yushi Hu, Otilia Stretcu, Chun-Ta Lu, Krishnamurthy Viswanathan, Kenji Hata, Enming Luo, Ranjay Krishna, and Ariel Fuxman. 2024. [Visual program distillation: Distilling tools and programmatic reasoning into vision-language models](#). In *2024 IEEE/CVF Conference on Computer Vision and Pattern Recognition (CVPR)*, page 9590–9601, Seattle, WA, USA. IEEE.
- Jianzhao Huang, Hongzhan Lin, Liu Ziyang, Ziyang Luo, Guang Chen, and Jing Ma. 2024. [Towards low-resource harmful meme detection with lmm agents](#). In *Proceedings of the 2024 Conference on Empirical Methods in Natural Language Processing*, page 2269–2293, Miami, Florida, USA. Association for Computational Linguistics.
- Junhui Ji, Xuanrui Lin, and Usman Naseem. 2024. [Capalign: Improving cross modal alignment via informative captioning for harmful meme detection](#). In *Proceedings of the ACM Web Conference 2024*, page 4585–4594, Singapore Singapore. ACM.
- Jeff Johnson, Matthijs Douze, and Hervé Jégou. 2021. [Billion-scale similarity search with gpus](#). *IEEE Transactions on Big Data*, 7(3):535–547.
- Douwe Kiela, Hamed Firooz, Aravind Mohan, Vedanuj Goswami, Amanpreet Singh, Pratik Ringshia, and Davide Testuggine. 2021. [The hateful memes challenge: Detecting hate speech in multimodal memes](#). (arXiv:2005.04790). ArXiv:2005.04790 [cs].
- Gokul Karthik Kumar and Karthik Nandakumar. 2022. [Hate-CLIPper: Multimodal hateful meme classification based on cross-modal interaction of CLIP features](#). In *Proceedings of the Second Workshop on*

- NLP for Positive Impact (NLP4PI)*, pages 171–183, Abu Dhabi, United Arab Emirates (Hybrid). Association for Computational Linguistics.
- Xiujun Li, Xi Yin, Chunyuan Li, Pengchuan Zhang, Xiaowei Hu, Lei Zhang, Lijuan Wang, Houdong Hu, Li Dong, Furu Wei, Yejin Choi, and Jianfeng Gao. 2020. *Oscar: Object-Semantics Aligned Pre-training for Vision-Language Tasks*, volume 12375 of *Lecture Notes in Computer Science*, page 121–137. Springer International Publishing, Cham.
- Hongzhan Lin, Ziyang Luo, Wei Gao, Jing Ma, Bo Wang, and Ruichao Yang. 2024. *Towards explainable harmful meme detection through multimodal debate between large language models*. In *Proceedings of the ACM Web Conference 2024*, WWW '24, page 2359–2370, New York, NY, USA. Association for Computing Machinery.
- Phillip Lippe, Nithin Holla, Shantanu Chandra, Santhosh Rajamanickam, Georgios Antoniou, Ekaterina Shutova, and Helen Yannakoudakis. 2020. *A multimodal framework for the detection of hateful memes*. (arXiv:2012.12871). ArXiv:2012.12871 [cs].
- Chen Liu, Gregor Geigle, Robin Krebs, and Iryna Gurevych. 2022. *Figmemes: A dataset for figurative language identification in politically-opinionated memes*. In *Proceedings of the 2022 Conference on Empirical Methods in Natural Language Processing*, page 7069–7086, Abu Dhabi, United Arab Emirates. Association for Computational Linguistics.
- Haotian Liu, Chunyuan Li, Yuheng Li, and Yong Jae Lee. 2023a. *Improved baselines with visual instruction tuning*. (arXiv:2310.03744). ArXiv:2310.03744 [cs].
- Haotian Liu, Chunyuan Li, Qingyang Wu, and Yong Jae Lee. 2023b. *Visual instruction tuning*. (arXiv:2304.08485). ArXiv:2304.08485 [cs].
- Jingbiao Mei, Jinghong Chen, Weizhe Lin, Bill Byrne, and Marcus Tomalin. 2024. *Improving hateful meme detection through retrieval-guided contrastive learning*. In *Proceedings of the 62nd Annual Meeting of the Association for Computational Linguistics (Volume 1: Long Papers)*, pages 5333–5347, Bangkok, Thailand. Association for Computational Linguistics.
- Niklas Muennighoff. 2020. *Vilio: State-of-the-art visio-linguistic models applied to hateful memes*. (arXiv:2012.07788). ArXiv:2012.07788 [cs].
- Wairimu Nderitu. 2020. *United nations strategy and plan of action on hate speech*.
- Khoi P. N. Nguyen and Vincent Ng. 2024. *Computational meme understanding: A survey*. In *Proceedings of the 2024 Conference on Empirical Methods in Natural Language Processing*, page 21251–21267, Miami, Florida, USA. Association for Computational Linguistics.
- OpenAI. 2023. *Gpt-4 technical report*. (arXiv:2303.08774). ArXiv:2303.08774 [cs].
- OpenAI. 2024a. *Gpt-4o system card*. (arXiv:2410.21276). ArXiv:2410.21276 [cs].
- OpenAI. 2024b. *Openai o1 system card*. (arXiv:2412.16720). ArXiv:2412.16720 [cs].
- Nirmalendu Prakash, Ming Shan Hee, and Roy Ka-Wei Lee. 2023. *Totaldefmeme: A multi-attribute meme dataset on total defence in singapore*. In *Proceedings of the 14th Conference on ACM Multimedia Systems, MMSys '23*, page 369–375, New York, NY, USA. Association for Computing Machinery.
- Shraman Pramanick, Dimitar Dimitrov, Rituparna Mukherjee, Shivam Sharma, Md. Shad Akhtar, Preslav Nakov, and Tanmoy Chakraborty. 2021a. *Detecting harmful memes and their targets*. In *Findings of the Association for Computational Linguistics: ACL-IJCNLP 2021*, pages 2783–2796, Online. Association for Computational Linguistics.
- Shraman Pramanick, Shivam Sharma, Dimitar Dimitrov, Md. Shad Akhtar, Preslav Nakov, and Tanmoy Chakraborty. 2021b. *Momenta: A multimodal framework for detecting harmful memes and their targets*. In *Findings of the Association for Computational Linguistics: EMNLP 2021*, page 4439–4455, Punta Cana, Dominican Republic. Association for Computational Linguistics.
- Alec Radford, Jong Wook Kim, Chris Hallacy, Aditya Ramesh, Gabriel Goh, Sandhini Agarwal, Girish Sastry, Amanda Askell, Pamela Mishkin, Jack Clark, Gretchen Krueger, and Ilya Sutskever. 2021. *Learning transferable visual models from natural language supervision*. In *Proceedings of the 38th International Conference on Machine Learning*, page 8748–8763. PMLR.
- Shaoqing Ren, Kaiming He, Ross Girshick, and Jian Sun. 2015. *Faster r-cnn: Towards real-time object detection with region proposal networks*. In *Advances in Neural Information Processing Systems*, volume 28. Curran Associates, Inc.
- Florian Schroff, Dmitry Kalenichenko, and James Philbin. 2015. *Facenet: A unified embedding for face recognition and clustering*. In *2015 IEEE Conference on Computer Vision and Pattern Recognition (CVPR)*, page 815–823. ArXiv:1503.03832 [cs].
- Siddhant Bikram Shah, Shuvam Shiwakoti, Maheep Chaudhary, and Haohan Wang. 2024. *Memeclip: Leveraging clip representations for multimodal meme classification*. In *Proceedings of the 2024 Conference on Empirical Methods in Natural Language Processing*, page 17320–17332, Miami, Florida, USA. Association for Computational Linguistics.
- Shardul Suryawanshi, Bharathi Raja Chakravarthi, Michael Arcan, and Paul Buitelaar. 2020. *Multimodal meme dataset (multioff) for identifying offensive content in image and text*. In *Proceedings of the Second*

Workshop on Trolling, Aggression and Cyberbullying, page 32–41, Marseille, France. European Language Resources Association (ELRA).

Peng Wang, Shuai Bai, Sinan Tan, Shijie Wang, Zhihao Fan, Jinze Bai, Keqin Chen, Xuejing Liu, Jialin Wang, Wenbin Ge, Yang Fan, Kai Dang, Mengfei Du, Xuancheng Ren, Rui Men, Dayiheng Liu, Chang Zhou, Jingren Zhou, and Junyang Lin. 2024. [Qwen2-vl: Enhancing vision-language model’s perception of the world at any resolution](#). (arXiv:2409.12191). ArXiv:2409.12191 [cs].

John Woodhouse. 2022. [Regulating online harms](#). *UK Parliament*.

Pengchuan Zhang, Xiujun Li, Xiaowei Hu, Jianwei Yang, Lei Zhang, Lijuan Wang, Yejin Choi, and Jianfeng Gao. 2021. [Vinvl: Revisiting visual representations in vision-language models](#). page 5579–5588.

Ron Zhu. 2020. [Enhance multimodal transformer with external label and in-domain pretrain: Hateful meme challenge winning solution](#). (arXiv:2012.08290). ArXiv:2012.08290 [cs].

Yongshuo Zong, Ondrej Bohdal, and Timothy Hospedales. 2024. [Vl-icl bench: The devil in the details of benchmarking multimodal in-context learning](#). *arXiv preprint arXiv:2403.13164*.

A Dataset details and statistics

Table 5 shows the data split for our evaluation datasets.

HatefulMemes (Kiela et al., 2021) Released by Meta in 2020, HatefulMemes contains 12,000 memes annotated as hateful or benign by trained experts. This benchmark dataset synthesizes memes targeting religion, race, disability, and gender. It includes confounder examples where the benign memes are generated by altering either the image or text to challenge models’ ability in multimodal reasoning.

HarMeme and Harm-P HarMeme is a dataset containing approximately 3,000 memes centered on COVID-19 related political memes. A companion dataset, Harm-P (Pramanick et al., 2021b), contains around 3,000 memes related to US politics. Although the original HarMeme was later renamed Harm-C in subsequent work, we adhere to its original name following previous studies (Cao et al., 2022). In HarMeme, memes are annotated into three classes: very harmful, partially harmful, and harmless. Consistent with prior work (Cao et al., 2022; Pramanick et al., 2021b), we merge the very

harmful and partially harmful categories into a single hateful class, while treating harmless memes as benign.

MAMI (Fersini et al., 2022) The MAMI dataset focuses on detecting misogynistic memes sourced from various social media platforms, including Twitter and Reddit, as well as meme creation and sharing websites, and even anti-women websites and forums. It contains annotation for two tasks: (1) binary classification of misogyny and (2) categorization of misogyny types. In this work, we address the binary task of identifying whether a meme is misogynistic.

MultiOFF (Suryawanshi et al., 2020) MultiOFF consists of memes gathered from Reddit, Facebook, Twitter, and Instagram, curated specifically for the detection of offensive content. Notably, the training set is extremely small, containing fewer than 500 meme examples. We use this dataset to evaluate the applicability of our methods under ultra low-resource conditions.

PrideMM (Shah et al., 2024) PrideMM contains LGBTQ+-themed memes annotated for four tasks: hate speech detection, hate target identification, topical stance classification, and humor detection. In this work, we use the hate speech classification annotations for hateful meme detection.

Datasets	Train		Test	
	#Benign	#Hate	#Benign	#Hate
HatefulMemes	5450	3050	500	500
HarMeme	1949	1064	230	124
MAMI	4500	4500	500	500
Harm-P	1534	1486	173	182
MultiOFF	258	187	58	91
PrideMM	2581	2482	260	247

Table 5: Statistical summary of HatefulMemes and HarMeme datasets

To access the Facebook HatefulMemes dataset, one must follow the license from Facebook². HarMeme and Harm-P are distributed for research purposes only, without a license for commercial use. MultiOFF is licensed under CC-BY-NC. MAMI is under Apache License 2.0. There is no specified license for PrideMM.

²<https://hatefulmemeschallenge.com/#download>

B Experiment Setup and Implementation Details

Environment. PyTorch 2.5.1, CUDA 12.4, Huggingface Transformer 4.45.0 and Python 3.10.12 were used for implementing the experiments. FAISS (Johnson et al., 2021) vector similarity search library with version faiss-gpu 1.7.2 was used to perform dense retrieval. All the reported metrics were computed by TorchMetrics 1.0.1.

Implementation Details. We use QLoRA (Detmers et al., 2023) to fine-tune all LMMs, as our experiments show that LoRA and QLoRA perform similarly on this task while significantly outperforming full-parameter fine-tuning. The details for fine-tuning are covered in Appendix B.1. All reported metrics were based on the mean of five runs with different seeds. For statistical significance testing, each model is run five times with different random seeds. For baseline models, we strictly follow the settings specified in their original papers.

Implementation environment. We conducted our experiments on a workstation equipped with NVIDIA RTX 3090 was used for the experiments. The full parameter fine-tuning experiments were carried out on 4 A100-80GB-SXM GPUs.

Run time The run time for LMM-RGCL two-stage fine-tuning on the HatefulMemes dataset is approximately 4 hours on a single RTX 3090, which is comparable to SFT.

To optimize efficiency in stage 2, we pre-extract the final hidden states from the frozen LMM and store them on disk before training, avoiding redundant LMM computations. This reduces the stage 2 training time to approximately 10 minutes.

In our ablation study, we examine the performance impact of merging the two-stage loss into a single fine-tuning stage. Since the LMM remains trainable in this setting, we cannot precompute and store the frozen LMM features, leading to significantly higher computational costs. This approach requires approximately 12 hours to complete fine-tuning on a single RTX 3090.

For full-parameter fine-tuning, training takes 6 hours on 4 A100-80G.

B.1 LLaVA and Qwen2VL experiments

We freeze the vision module throughout fine-tuning, following the standard LMM fine-tuning

protocol. For prompt formatting, we adhere to InstructBLIP (Dai et al., 2023). For LLaVA few-shot experiments, since LLaVA is not explicitly trained to support in-context learning, we follow the procedure outlined by Zong et al. (2024) to enable few-shot learning on LLaVA. For fine-tuning LLaVA (Liu et al., 2023b,a), we follow the original hyperparameters setting³ for fine-tuning on downstream tasks for both the SFT and LMM-RGCL stage 1 fine-tuning.

For Qwen2VL fine-tuning, we employ the officially recommended fine-tuning library LLaMA-Factory 0.9.1⁴ with official hyperparameter settings for downstream tasks in both the SFT and LMM-RGCL stage 1 fine-tuning. For few-shot learning with Qwen2VL, we follow the official multi-round conversation prompt format to ensure consistency with the model’s intended usage.

B.2 Hyperparameters for MLP and Stage 2 Fine-tuning

The default hyperparameters for the MLP and the stage 2 RGCL fine-tuning are shown in Table 6. The modeling hyperparameters are based on RGCL’s setting (Mei et al., 2024). With this configuration of hyperparameters, the number of trainable parameters is about 5 million.

Modelling hyperparameter	Value
Projection dimension of MLP	1024
Number of layers in the MLP	2
Optimizer	AdamW
Maximum epochs	30
Batch size	64
Learning rate	0.0001
Weight decay	0.0001
Gradient clip value	0.1
RGCL hyperparameter	Value
# hard negative examples	1
# pseudo-gold positive examples	1
Similarity metric	Cosine similarity
Loss function	NLL
Top-K for RKC	20

Table 6: Default hyperparameter values

C Baseline Methods

- **Visual Programming Distillation (VPD)** (Hu et al., 2024) builds an agentic LMM framework by fine-tuning the model’s ability

³<https://github.com/haotian-liu/LLaVA>

⁴<https://github.com/hiyouga/LLaMA-Factory>

to use external tools (e.g., writing and executing programs). VPD fine-tunes PaLI-X 55B, achieving state-of-the-art performance on the HatefulMemes dataset.

- **ISSUES** (Burbi et al., 2023) employs text inversion along with several projection layers and a feature combiner to enhance the pre-trained CLIP encoder, yielding state-of-the-art results on the HarMeme dataset.
- **RGCL** (Mei et al., 2024) learns hate-aware vision and language representations through a contrastive learning objective applied to a pre-trained CLIP encoder, achieving state-of-the-art performance on the MultiOFF dataset.
- **ExplainHM** (Lin et al., 2024) fine-tunes three LLMs arranged as two debaters (arguing whether a meme is hateful) and one judge (summarizing the debaters’ points) to both explain and classify hateful memes.
- **Pro-Cap** (Cao et al., 2023) employs prompting techniques to guide pre-trained vision-language models in generating image captions that reflect hateful content. These generated captions are then combined with textual information to improve hateful meme detection.
- **MemeCLIP** (Shah et al., 2024) utilizes CLIP features along with feature adapters to mitigate overfitting and employs a cosine classifier to address class imbalance.
- **MOMENTA** (Pramanick et al., 2021b) leverages trainable fusion layers—such as Cross-Modal Attention Fusion—to integrate multimodal features extracted by CLIP for improved hateful meme detection.
- **HateCLIPper** (Kumar and Nandakumar, 2022) explores various strategies to align and fuse the visual and textual modalities in CLIP-based encoders, enhancing their performance on challenging hateful meme cases.
- **LOREHM** (Huang et al., 2024) adopts an agent-based LMM framework that leverages few-shot in-context learning and self-improvement capabilities for low-resource hateful meme detection.
- **Mod-Hate** (Cao et al., 2024) trains a suite of LoRA modules and utilizes few-shot demonstration examples to train a module composer,

which assigns weights to the LoRA modules for effective low-resource hateful meme detection.

D Comparing RKC and In-Context Learning under different Fine-tuning Schemes

In this section, we compare the performance of the RKC inference mode against few-shot in-context learning for pre-trained LMMs, SFT LMMs, and LMMs fine-tuned using our proposed LMM-RGCL framework under the cross-dataset setting. As shown in Table 7, RKC consistently outperforms the few-shot in-context learning approach across all LMM variants, indicating that RKC makes better use of demonstration examples. Furthermore, LMM-RGCL fine-tuned LMMs with RKC outperform SFT LMMs with RKC, highlighting the advantages of our fine-tuning strategy.

Model	Mode	HatefulMemes		HarMeme	
		AUC	Acc.	AUC	Acc.
Pre-trained	Few-shot	71.5	63.8	71.5	67.2
Pre-trained	RKC	74.5	64.5	80.1	72.4
SFT	Few-shot	72.3	60.6	67.2	62.4
SFT	RKC	75.8	67.1	84.5	75.4
LMM-RGCL	Few-shot	70.8	63.5	73.2	68.1
LMM-RGCL	RKC	77.1	69.3	88.8	81.7

Table 7: Comparing Pre-trained, SFT and LMM-RGCL systems with few-shot learning and RKC with Qwen2VL-7B under cross-dataset settings. See Table 2

E Ablation study on the loss function

Table 8 shows the results when each loss objective is removed from different stages of fine-tuning. Notably, when the cross-entropy loss is removed in stage 1 for the logistic regression component, the LRC fails to train properly via backpropagation, resulting in performance that is equivalent to random guessing. Consequently, we exclude this case from our comparison. Overall, we observe that removing any loss function from the fine-tuning objective leads to a significant drop in performance, highlighting the importance of each loss term in optimizing the model.

F Case Analysis

F.1 Comparing SFT and LMM-RGCL Predictions

Table 9 presents examples where our LMM-RGCL method successfully corrects prediction errors

Mode	HatefulMemes		HarMeme	
	AUC	Acc.	AUC	Acc.
LMM-RGCL	91.1	82.1	93.2	88.1
w/o \mathcal{L}^{LM} in stage 1	88.4	79.6	90.9	85.1
w/o \mathcal{L}^{RGCLL} in stage 2	90.2	81.2	91.9	86.4
w/o \mathcal{L}^{LR} in stage 2	89.2	80.6	91.6	87.2

(a) Supervised settings, see Table 1

Mode	HatefulMemes		HarMeme	
	AUC	Acc.	AUC	Acc.
LMM-RGCL	77.1	69.3	88.8	81.7
w/o \mathcal{L}^{LM} in stage 1	75.4	66.6	87.3	81.1
w/o \mathcal{L}^{RGCLL} in stage 2	73.8	64.3	82.9	76.5
w/o \mathcal{L}^{LR} in stage 2	76.4	67.9	86.9	80.6

(b) Cross-dataset settings, see Table 2

Table 8: Ablation study of LMM-RGCL two-stage fine-tuning framework on Qwen2VL-7B, evaluating the impact of removing any of the loss objectives.

made by the SFT model on Qwen2VL-7B. Cases 1-4 involve hateful memes, while Cases 5-6 are benign memes that the SFT model misclassified, primarily due to poor multimodal alignment. These examples require a deep, joint understanding of both the image and text, a challenge that our LMM-RGCL effectively addresses. For example, in Case 2, the model needs to use its understanding of Japanese culture and associate this knowledge with the visual cues in the image.

F.2 Error Analysis

In Table 10, we present examples where LMM-RGCL was unable to correct errors made by the baseline SFT model. In the first case, the model struggles with the nuanced visual understanding required to interpret the disabled body of the swimmer. Additionally, these examples demand complex reasoning to assess the hatefulness of the memes. Interpreting such nuanced meanings remains a challenge for current models. However, we anticipate that the advanced reasoning capabilities of emerging systems like OpenAI-o1 (OpenAI, 2024b) and DeepSeek-R1 (DeepSeek-AI, 2025) will help address these limitations.

G AI Assistance

Our coding work was assisted by Github Copilot. OpenAI ChatGPT was only used in proofreading and spell-checking. We claim that the content presented in this paper was fully original.







	Case 1	Case 2	Case 3
Meme			
Ground Truth	#Hateful	#Hateful	#Hateful
SFT	#Benign	#Benign	#Benign
LMM-RGCL	#Hateful	#Hateful	#Hateful
	Case 4	Case 5	Case 6
Meme			
Ground Truth	#Hateful	#Benign	#Benign
SFT	#Benign	#Hateful	#Hateful
LMM-RGCL	#Hateful	#Benign	#Benign

Table 9: Visualization of cases from SFT Qwen2VL-7B and LMM-RGCL Qwen2VL-7B Models on the Hateful-Memes Dataset. Case 5 contains an insect in the meme; we applied a blurring filter to obscure it.

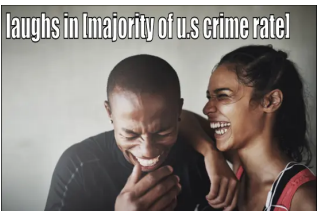

	Case 1	Case 2	Case 3
Meme			
Ground Truth	#Hateful	#Hateful	#Hateful
SFT	#Benign	#Benign	#Benign
LMM-RGCL	#Benign	#Benign	#Benign

Table 10: The error cases of SFT Qwen2VL-7B and LMM-RGCL Qwen2VL-7B models on HatefulMemes dataset