

Astromer 2

Cristobal Donoso-Oliva^{1,3,5}, Ignacio Becker^{2,7}, Pavlos Protopapas², Guillermo Cabrera-Vives^{1,3,4,5,6}, Martina Cádiz-Leyton^{1,3}, and Daniel Moreno-Cartagena^{1,3}

¹ Department of Computer Science, Universidad de Concepción, Edmundo Larenas 219, Concepción, Chile

² John A. Paulson School of Engineering and Applied Science, Harvard University, Cambridge, MA, 02138

³ Center for Data and Artificial Intelligence, Universidad de Concepción, Edmundo Larenas 310, Concepción, Chile

⁴ Millennium Institute of Astrophysics (MAS), Nuncio Monseñor Sotero Sanz 100, Of. 104, Providencia, Santiago, Chile

⁵ Millennium Nucleus on Young Exoplanets and their Moons (YEMS), Chile

⁶ Heidelberg Institute for Theoretical Studies, Heidelberg, Baden-Württemberg, Germany

⁷ Department of Computer Science, Pontificia Universidad Católica de Chile, Macul, Santiago 7820436, Chile

Received November xx, 2024

ABSTRACT

Context. Foundational models have emerged as a powerful paradigm within the deep learning field. Their capacity relies on the ability to learn robust representations from large-scale datasets and generalize to diverse downstream applications, such as classification. In this paper, we present Astromer 2, a foundational model designed for extracting light curve embeddings.

Aims. We introduce Astromer 2, an enhanced iteration of our self-supervised model for light curve analysis. This paper highlights the advantages of its pre-trained embeddings, compares its performance with that of its predecessor, Astromer 1, and provides a detailed empirical analysis of its capabilities, offering deeper insights into the model's representations.

Methods. Astromer 2 is pretrained on 1.5 million single-band light curves from the MACHO survey using a self-supervised learning task that predicts randomly masked observations within sequences. Fine-tuning on a smaller labeled dataset allows us to assess its performance in classification tasks. The quality of the embeddings is measured by the F1 score of an MLP classifier trained on Astromer-generated embeddings.

Results. Our results demonstrate that Astromer 2 significantly outperforms Astromer 1 across all evaluated scenarios, including limited datasets of 20, 100, and 500 samples per class. The use of weighted per-sample embeddings, which integrate intermediate representations from Astromer's attention blocks, is particularly impactful. Notably, Astromer 2 achieves a 15% improvement in F1 score on the ATLAS dataset compared to prior models, showcasing robust generalization to new datasets. This enhanced performance, especially with minimal labeled data, underscores the potential of Astromer 2 for more efficient and scalable light curve analysis.

Key words. Representation Learning – Light Curves – Foundational Models

1. Introduction

Light curve analysis is a cornerstone in astronomy for characterizing stellar objects (Deb & Singh 2009). By analyzing the time-series data of luminosity variations, astronomers can extract statistical features that enable classification and identification tasks (Richards et al. 2011).

Although traditional methods show success (Sánchez-Sález et al. 2021; Chaini et al. 2024), the advent of foundational models presents fresh opportunities to gain insights into cosmic variability. Foundational models are deep neural networks trained using self-supervised techniques on extensive datasets (Bommasani et al. 2021; Awais et al. 2023). These models acquire a thorough grasp of their domain, allowing for the creation of versatile representations applicable to various downstream tasks.

Classical techniques rely on manually engineered features (Debosscher et al. 2007; Nun et al. 2015), which may introduce biases or fail to capture intricate patterns (Pantoja et al. 2022). Foundational models, by processing large volumes of data, have the potential to reveal novel, precise structures in the data. However, this gain in representational power comes at the expense of reduced interpretability.

In 2023, we introduced Astromer, a self-supervised model designed to extract general-purpose embeddings from light curves (Donoso-Oliva, C. et al. 2023). Trained on 1.5 million light curves, Astromer demonstrated consistent improvements in classification tasks compared to models trained directly on labeled datasets.

Other foundational models in astronomy, such as those employing contrastive learning (Lanusse et al. 2023; Rizhko & Bloom 2024; Parker et al. 2024), integrate multiple data modalities to create richer and more complex representations. While multi-modal learning is a promising avenue, it introduces additional complexity in model training and interpretation (Wang et al. 2024).

Astromer, by contrast, focuses solely on single-modality light curve data, leveraging its temporal structure without requiring alignment or integration steps across modalities. Instead of contrastive learning, Astromer employs magnitude imputation to handle missing values in time series, resulting in a simpler, yet highly effective model that achieves state-of-the-art performance without incurring high computational costs.

In this paper, we present Astromer 2, an improved version of our original model. For consistency, we use the same dataset from our initial publication and compare our latest model in classification task. Additionally, we delve into the embed-

ding vectors and attention weights to better understand the model’s capabilities and performance as used in other works (Martínez-Galarza et al. 2021).

In this work, Sect. 2 describes the main characteristics of the original version of Astromer, namely Astromer 1. Section 3 introduces the improvements to the model. Sections 4 and 5 describe the data and the main results of this work, respectively. Finally, Sect. 6 outlines the main findings and conclusions.

2. Astromer 1

The initial version of Astromer (Donoso-Oliva, C. et al. 2023) adapted the BERT text model from natural language processing (Devlin et al. 2018). While both light curves and text are sequential data, light curves pose a unique challenge due to the inherent irregularities in their sampling. Moreover, instead of a discrete vocabulary, we work with continuous magnitudes for each token.

Despite the differences between BERT and Astromer, the high-level approach to training remains similar, as it leverages a self-supervised task. Specifically, we employ a masking strategy that obscures portions of the light curve, allowing the model to predict the missing magnitudes. This technique, inspired by BERT’s word masking in sentences, enables the model to learn meaningful representations without relying on human-annotated labels.

This section revisits the pipeline previously introduced in Astromer 1. While much of the content has been explained before, we present it here with a more refined and clearer explanation for enhanced understanding.

2.1. Data preparation

Astromer uses single-band light curves $\{x_i\}_{i=0}^{N-1}$ with N as the number of samples. Each sample is represented as a set of tuples $x_i = \{(t_l, m_l, e_l)\}_{l=0}^{L_i-1}$. Here, t_l denotes the observation time in modified Julian date (MJD), m_l represents the magnitude, and e_l corresponds to the magnitude uncertainty. The maximum number of observations L_i varies across samples, resulting in a variable-length dataset.

We fixed a maximum length of 200 observations to create the network’s input. During pretraining, we sample different windows of 200 observations per epoch, allowing the model to see most of the light curve sequence in small, fixed chunks. Shorter light curves are zero-padded to a fixed length of 200 observations.

After constructing the windows, we normalize their values. Specifically, we subtract $\bar{x}_i = (\bar{t}, \bar{m}, \bar{e})$ the mean value of each light curve, producing zero-mean samples with non-scaled amplitude. Our experiments have shown that this normalization step is essential for the model to converge effectively. Other options may be insufficient to produce valuable embeddings.

2.2. Input Embedding

Unlike language models, Astromer does not have a fixed vocabulary of tokens. Instead, the input consists of a sequence of continuous magnitude values, each paired with its corresponding observation time in MJD. We do not consider the uncertainties in Astromer’s input.

To create a single input embedding, we transform each time and magnitude scalar into vectors. To encode observation times, we apply an adapted positional encoder (PE) that scales the angular frequencies ω_j using the observation time t_l , capturing the

irregular sampling in the temporal representation.

$$\text{PE}_{j,t_l} = \begin{cases} \sin(t_l \cdot \omega_j) & j \text{ is even} \\ \cos(t_l \cdot \omega_j) & j \text{ is odd} \end{cases} \quad (1)$$

In Eq. 1, $j \in [0, \dots, d_{pe} - 1]$, where $d_{pe} = 256$ is the PE dimensionality and ω_j is the angular frequency defined as,

$$\omega_j = \frac{1}{1000^{2j/d_{pe}}}. \quad (2)$$

For the magnitudes, we linearly project each magnitude value into a vector of size $d_{pe} = 256$. The weights used to transform magnitudes are initialized from a Normal distribution and subsequently learned during training. This shared set of weights is applied across all observations.

The final input embedding $X \in \mathbb{R}^{L \times 256}$ is the sum of the PE and transformed magnitudes, $X = \text{PE} + \mathbf{m}\mathbf{W}^T$, where $\mathbf{m} \in \mathbb{R}^{L \times 1}$ is the magnitudes vector and $\mathbf{W} \in \mathbb{R}^{256 \times 1}$ are the weights for transforming scalars into vectors.

2.3. Probed and Masking

The key to Astromer learning a good representation is to pre-train it to predict unseen observations along the light curve sequence. The probed subset consists of magnitudes designated for the model to predict. However, these values are excluded when calculating attention weights. We randomly select 50% of the total observations per window to constitute the probed subset. This subset is denoted by a binary mask vector, where the 1’s correspond to the probed magnitudes, and zero otherwise.

In the self-attention mechanism, the attention weights for the probed subset are set to zero using masking. This design encourages the model to leverage the surrounding context to predict the probed magnitudes. During inference, however, masking is not applied. To prevent the model from over-relying on the masked observations during training, we adopt the following strategy. We assign 10% of visible observations and 10% of random observations in the probed subset. As a result, the actual masked portion is reduced to 30%, while the probed subset still corresponds to the initial 50%. This approach mitigates the risk of the model learning a direct identity mapping and improves its robustness to noise. Figure 1 illustrates the composition of the final subsets, with the probed subset size fixed at 50% of the observations.

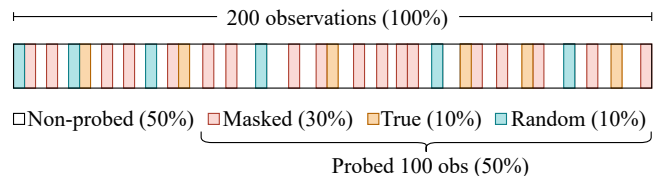

Fig. 1: Observation subsets. In our pretraining strategy, 50% of the observations are designated as probed. The probed subset is evaluated in the loss function to optimize Astromer’s parameters. Its composition emphasizes predicting hidden elements (with 30% masked overall) while mitigating the risk of the model over-relying on the masked observations (10% visible and 10% with random magnitudes). This approach ensures the model pays attention to current observations without overfitting to them.

2.4. Encoder

The encoder comprises a sequence of attention blocks connected in series. The first block processes the input embeddings described in Sect. 2.2 and a binary mask matrix that specifies which observations to exclude from the attention mechanism. Subsequent blocks take as input the output of the preceding attention block as shown in Fig. 2.

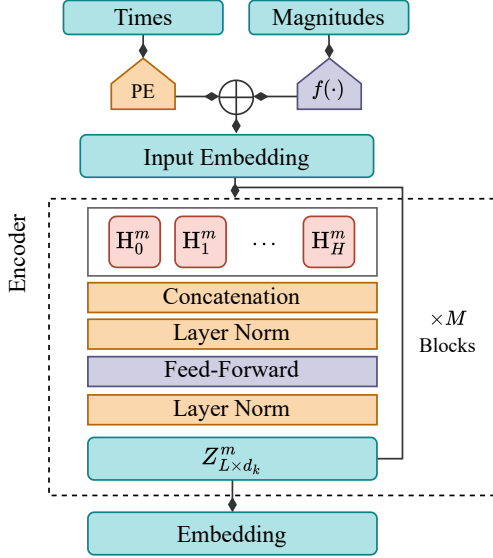

Fig. 2: Astromer 1 architecture diagram. The input embedding is the sum of PEs for times and linearly transformed magnitudes. In Astromer 1, the encoder comprises $M = 2$ blocks with $H = 4$ attention heads, each having 64 units. The outputs of the attention heads are concatenated and processed through a feed-forward network. The final embedding is derived from the output of the last attention block.

Astromer 1 has two attention blocks, each containing four heads with 64 units. The outputs of the heads are concatenated, normalized, and combined through a fully connected layer, one hidden layer of 128 units, and a hyperbolic tangent activation.

Within each head, the attention values are computed from the similarity matrix derived using the Query (Q), Key (K), and Value (V) matrices, normalized by the square root of $d_k = 256$, the model's embedding size. Note that Q, K, and V come from a linear transformation of the input embedding and have different values for each head and block.

$$\begin{aligned} Q &= XW_{\text{query}}^T & K &= XW_{\text{key}}^T & V &= XW_{\text{value}}^T \\ W_{\text{att}} &= \text{Softmax}\left(\frac{QK^T - \infty M}{\sqrt{d_k}}\right) \\ Z &= W_{\text{att}}V \end{aligned} \quad (3)$$

In Eq. 3, the mask matrix M prevents the masked subset of probed observations from contributing to the attention values. When $M = 1$, the argument of the softmax function is effectively negative infinity, resulting in a zero attention weight.

In Astromer 1, the output of the last block serves as the final embedding. This matrix has two functions: reconstructing magnitudes during pretraining and serving as the embedding for downstream tasks.

2.5. Pretraining Task

We pretrain the model to predict the magnitudes of the probed subset in each input sequence. This is achieved by passing the output embedding from the last attention block, through a fully connected network with no hidden layers or activation. The result is a vector of estimated magnitudes, $\hat{x} \in \mathbb{R}^{200 \times 1}$, providing the reconstruction for each time point according to its related embedding.

We constraint the loss function to compute the root-mean-square error on the probed subset only:

$$\mathcal{Loss} = \sqrt{\frac{1}{N-1} \sum_{i=0}^{N-1} \sum_{l=0}^{L-1} m_{il}(x_{il} - \hat{x}_{il})^2}. \quad (4)$$

In Eq. 4, N represents the number of training samples, and $L = 200$ represents the length of the windows. Thus, the masking vector m_i selectively includes errors from the probed subset.

3. Astromer 2

Astromer 2 incorporates features that were not included in the initial version due to resource and time constraints. While Astromer 1 served as a proof of concept for generating effective embeddings, Astromer 2 builds on this foundation, introducing iterative enhancements to optimize performance at each stage.

Building upon the foundation of Astromer 1 discussed in Sect. 2, this section is dedicated solely to the enhancements that distinguish the principal features of Astromer 2. Fig. 3 shows a visual representation of the updated architecture of Astromer 2.

3.1. Input embedding

The process for creating the input embedding for Astromer 2 remains the same as in the initial version. However, we replace the magnitudes targeted for masking with a trainable token that is zero-initialized and shared across all samples.

While the contribution of masked tokens is zero after the attention weight calculation, adding a mask token to replace the actual magnitude allows the model to recognize which tokens are masked, which can be helpful during training. We also avoid potential information leaks that could arise from the all-to-all computation within the similarity matrix.

3.2. Encoder

The encoder of Astromer 2 has a significantly larger number of parameters, increasing from 661 505 to 5 432 129. An eight fold increase. This growth is due to the inclusion of six attention blocks, with each block containing four heads and 64 units. Additionally, we have incorporated a dropout layer after the self-attention calculation, as depicted in Fig. 3.

3.3. Pretraining task

Like Astromer 1, we use the root-mean-square error as the loss function. In Astromer 2, however, the losses are scaled based on observational uncertainties. These uncertainties are normalized to a range of 0 to 1, and their reciprocals are used as weights. Incorporating this scaling term into the error calculation enhances

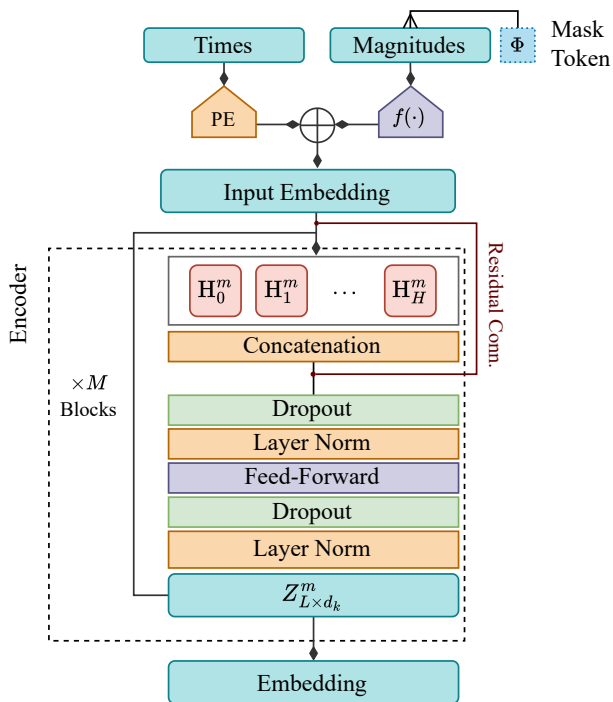

Fig. 3: Astromer 2 Architecture. The primary difference from its predecessor is the input layer, where a trainable MASK token is appended to observations designated as [MASK] during pre-training. The magnitude vector is subsequently projected into a higher-dimensional space matching the PE dimensionality via a fully connected layer without activation. We generalize over H , the number of heads and M the number of layers. Note that the final embedding Z corresponds to the output from the last attention layer. It contains vectors of size Md_k , where d_k is the size of the head for each l -th observation in the input.

performance compared to Astromer 1.

$$\mathcal{L}_{oss} = \sqrt{\frac{1}{N-1} \sum_{i=0}^{N-1} \sum_{l=0}^{L-1} \frac{m_{il}}{e_{il}} (x_{il} - \hat{x}_{il})^2}. \quad (5)$$

In Eq. 5, $e_{il} \neq 0$ denotes the observation uncertainty associated with step l in window i .

4. Data Sources

In this section, we introduce our training data, including unlabeled light curves for pretraining and labeled samples for the downstream classification task.

4.1. Unlabeled data - MACHO

The MACHO project (Alcock et al. 1993) aimed to detect Massive Compact Halo Objects (MACHO) to find evidence of dark matter in the Milky Way halo by searching for gravitational microlensing events. Light curves were collected from 1992 to 1999, producing light curves of more than a thousand observations (Alcock et al. 1999) in bands B and R. The observed sky was subdivided into 403 fields. Each field was constructed by observing a region of the sky or tile. The resulting data is available

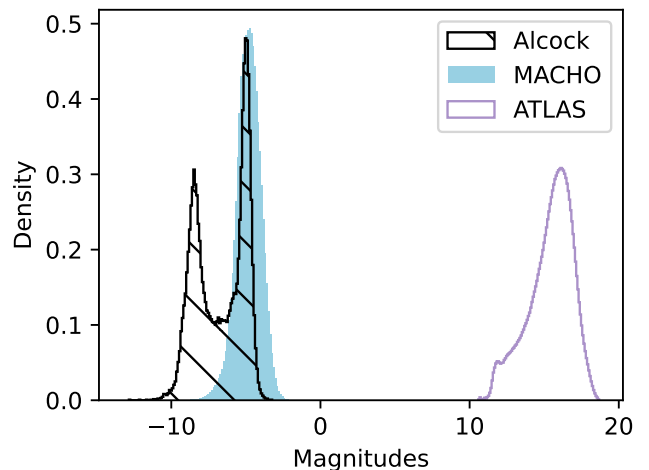

Fig. 4: Magnitude distributions for the MACHO, Alcock, and ATLAS datasets. The plotted magnitudes reflect their original values as reported in the datasets; however, they are normalized during training, eliminating the differences in their mean positions. The Alcock catalog exhibits multimodality. In contrast, the ATLAS magnitudes show significant more variation, as they originate from a different survey.

in a public repository¹ which contains millions of light curves in bands B and R.

We selected a subset of fields 1, 101, 102, 103, and 104 containing 1 454 792 light curves for training. Similarly, we select field 10 for testing, with a total of 74 594 light curves. MACHO observed in both bands simultaneously, therefore having two magnitudes associated with each MJD. Since we are looking to improve on Astromer 2, we maintain the single band input. The light curves from this dataset that exhibited Gaussian noise characteristics were removed based on the criteria: $|\text{Kurtosis}| > 10$, $|\text{Skewness}| > 1$, and $\text{Std} > 0.1$. Additionally, we excluded observations with negative uncertainties (indicative of faulty measurements) or uncertainties greater than one (to maintain photometric quality). Outliers were also removed by discarding the 1st and 99th percentiles for each light curve. This additional filtering does not affect the total number of samples but reduces the number of observations when the criteria were applied.

4.2. Labeled data

To ensure a fair comparison with Astromer 1, we used the same sample selection from the MACHO (hereafter referred to as Alcock; Alcock et al. 2003) and the Asteroid Terrestrial-impact Last Alert System (hereafter referred to as ATLAS; Heinze et al. 2018) labeled catalogs. The former has a similar magnitude distribution, whereas the latter differs, as shown in Fig. 4.

4.2.1. Alcock

For labeled data, we use the catalog of variable stars from Alcock et al. (2003), which contains labels for a subset of the MACHO light curves originating from 30 fields from the Large Magellanic Cloud. This labeled data will be used to train and evaluate the performance of the different embeddings on the classification task.

¹ https://macho.nci.org.au/macho_photometry

Table 1: Alcock catalog distribution.

Tag	Class Name	# of sources
Cep_0	Cepheid type I	1182
Cep_1	Cepheid type II	683
EC	Eclipsing binary	6824
LPV	Long period variable	3046
RRab	RR Lyrae type ab	7397
RRc	RR Lyrae type c	1762
Total		20 894

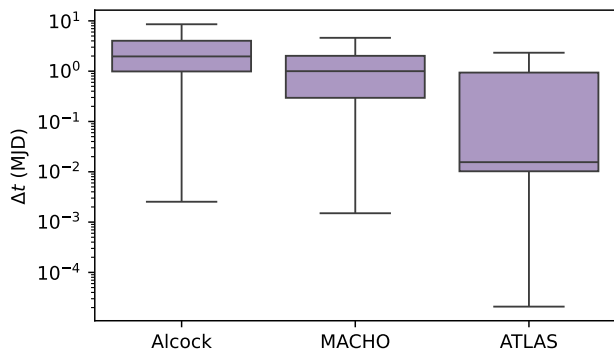

Fig. 5: Distributions of consecutive observation time differences (Δt) for the Alcock, MACHO, and ATLAS datasets. The box-plots illustrate the variability in observation cadences across the datasets. The Alcock and MACHO datasets show relatively consistent sampling with narrower distributions, while the ATLAS dataset exhibits a broader range of Δt , reflecting more diverse observation intervals. The y-axis is shown on a logarithmic scale to highlight differences across several orders of magnitude

The selected data comprises 20 894 light curves, which are categorized into six classes: Cepheid variables pulsating in the fundamental (Cep_0) and first overtone (Cep_1), Eclipsing Binaries (EC), Long Period Variables (LPV), RR Lyrae ab and c (RRab and RRc, respectively). Table 1 summarizes the number of samples per class. We note that the catalog used is an updated version, as described in Donoso-Oliva, C. et al. (2023).

Figure 4 compares the magnitude distributions between the Alcock and MACHO datasets. The former exhibits a bimodal distribution, which aligns with the fact that it represents a subset of the light curves from MACHO fields, while the latter encompasses light curves from only five fields.

Similarly, we compare the distribution of time differences between consecutive observations (Δt). Figure 5 shows similar distributions, with comparable ranges and means of three and four days for MACHO and Alcock, respectively.

4.3. ATLAS

The Asteroid Terrestrial-impact Last Alert System (ATLAS; Tonry et al. 2018) is a survey developed by the University of Hawaii and funded by NASA. Operating since 2015, ATLAS has a global network telescopes, primarily focused on detecting asteroids and comets that could potentially threaten Earth. Observing in c (blue), o (orange), and t (red) filters.

The variable star dataset used in this work was presented by Heinze et al. (2018) and includes 4.7 million candidate variable objects, included in the labeled and unclassified objects, as well as a dubious class. According to their estimates, this class is pre-

dominantly composed of 90% instrumental noise and only 10% genuine variable stars.

We analyze 141 376 light curves from the ATLAS dataset, as detailed in Table 2. These observations, measured in the o pass-band, have a median cadence of ~ 15 minutes, which is significantly shorter than the typical cadence in the MACHO dataset. This substantial difference poses a challenge for the model, as it must adapt to such a distinct temporal distribution.

Table 2: ATLAS catalog distribution.

Tag	Class Name	# of sources
CB	Close Binaries	80 218
DB	Detached Binary	28 767
Mira	Mira	7 370
Pulse	RR Lyrae, δ -Scuti, Cepheids	25 021
Total		141 376

As done in Donoso-Oliva, C. et al. (2023) and to standardize the labels with other datasets, we combine detached eclipsing binaries identified by full or half periods into the close binaries (CB) category and similarly merge detached binaries (DB). However, objects with labels derived from Fourier analysis are excluded, as these classifications do not directly align with astrophysical categories.

4.4. MACHO vs ATLAS

Figures 4 and 5 illustrate the distributional differences between the unlabeled MACHO dataset and the labeled subsets discussed earlier. While the magnitudes show a notable shift between MACHO and ATLAS, our training strategy normalizes the light curves to a zero mean. As a result, the relationships between observations take precedence over the raw magnitude values. Consequently, we do not expect a substantial performance drop when transitioning between datasets. However, for Δt , the smaller values of Δt present a significant challenge, as the model must extrapolate and account for fast variations to capture short-time information effectively. We evidence this in our first results from Astromer 2, where the F1 score on the ATLAS dataset was lower compared to MACHO when having fewer labels for classification.

5. Results

The pretraining task of reconstructing the probed magnitudes is an essential component that allows the model to learn meaningful representations. Reconstructing probed magnitudes can be evaluated as a downstream regression task on labeled datasets, where the model’s ability to predict the magnitudes can be assessed. Here we evaluate the potential of the representation in terms of regression.

Figure 6 shows the learning curves from the pretraining of Astromer 2. The training took approximately 3 days using 4 A5000 GPUs. The model achieved 0.73 R2 with a root mean squared error (RMSE) of 0.113 on the probed subset. Astromer 1 had an RMSE of 0.148, making Astromer 2 0.035 better in terms of reconstruction error.

5.1. Downstream setup

Similar to Astromer 1, this work evaluates the embeddings across various scenarios, while controlling the number of sam-

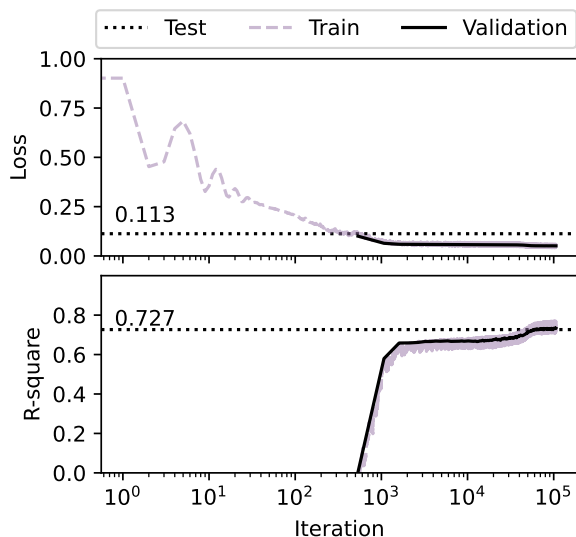

Fig. 6: Training and validation learning curves from the pretraining of Astromer 2. The dotted line represents the evaluation on the test set.

ples per class (SPC). When there are few SPC, the quality of the embeddings becomes crucial, as they must capture fundamental features that enable the model to make predictions based solely on the shape of the light curves, without relying on additional information.

Using the labeled datasets, we construct three training scenarios with limited data by randomly sampling 20, 100, and 500 SPC to assess performance on downstream tasks. When the number of available labels is insufficient, sampling is performed with replacement. To account for variability in our experiments, we generate three folds for each scenario. To ensure fairness across scenarios, we evaluate all models on a shared 3-fold test dataset consisting of 1000 SPC per fold. Hence, the models trained on 20, 100, and 500 SPC were evaluated against this common dataset.

In the initial stage of the downstream pipeline, we performed finetuning. This involves loading the pretrained weights and adapting the encoder parameters to the target domain. Finetuning followed the same pretraining setup, predicting a random probed subset containing 50% of the magnitudes per sequence.

5.2. Finetuning

Figure 7 presents the RMSE results for each scenario. The reported values are calculated across the total number of observations without masking, allowing for a fair comparison as the error could be biased by the random masking selection. As shown in Fig. 7, finetuning the model on the Alcock dataset does not result in significant improvements, indicating that the pretrained model already captures most of the relevant information, despite the out-of-distribution modality discussed in Sect. 4.4. In contrast, finetuning on ATLAS leads to a notable improvement. Specifically, with 100 SPC, we observe a 23% reduction in RMSE compared to the pretrained model. However, the performance improvement between 100 and 500 SPC is minimal, with only small variations.

The most computationally intensive scenario takes approximately three minutes to finetune, which is significantly faster than the days required for pretraining. While the time for MA-

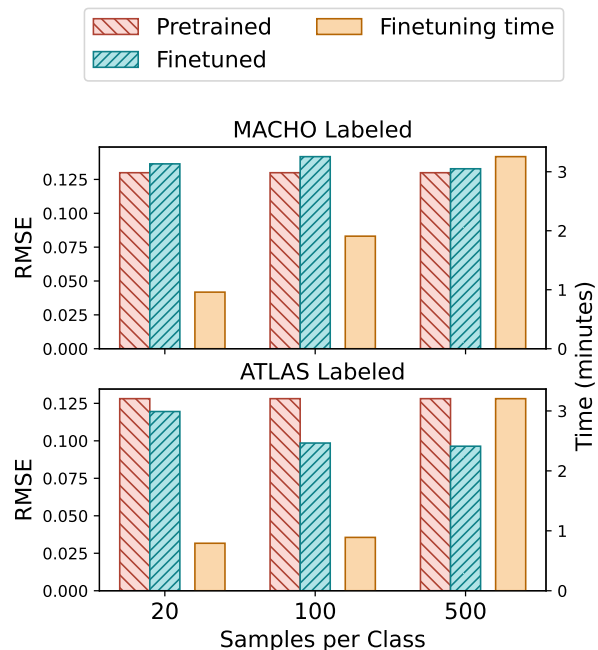

Fig. 7: [Left y-axis] Reconstruction error (dashed bars) measured by RMSE. [Right y-axis] Elapsed finetuning time in minutes. The x-axis represents each downstream scenario with training data of 20, 100, and 500 SPC.

CHO increases with more samples, in ATLAS, we observe almost no variation between 20 and 100 SPC. This is because MACHO samples are longer than ATLAS samples, resulting in a more substantial increase in the number of windows as the number of SPC grows. This explains the more significant rise in computing time when going from 20 to 100 MACHO SPC.

5.3. Visualizing reconstruction

To gain insight into Astromer’s representations, we visualize the attention values after finetuning. Figure 8 presents two examples showing the mean attention weights from each attention head, along with the mean across all attention heads. For visualization purposes, light curves associated with the average between heads were folded; however, Astromer does not receive folded inputs during processing. We display only the first attention block, as it is more intuitive. This contrasts with intermediate layers, where attention is computed over abstract embeddings. Figures 8 and 9 show that each attention head focuses on different parts of the sequence. In particular, attention appears to focus most strongly at maximum and minimum brightness points suggesting these are key features for reconstruction.

5.4. Classification

Evaluating classification performance is crucial for assessing the overall effectiveness of Astromer, as it serves as a common benchmark for evaluating the quality of embeddings. After finetuning on labeled subsets of 20, 100, and 500 SPC, the encoder is frozen, meaning its weights are no longer updated

Astromer is used to extract the representation, which is fed to another classifier model. The same labeled data is used to train a classifier. In this setup, only the classifier section receives label-

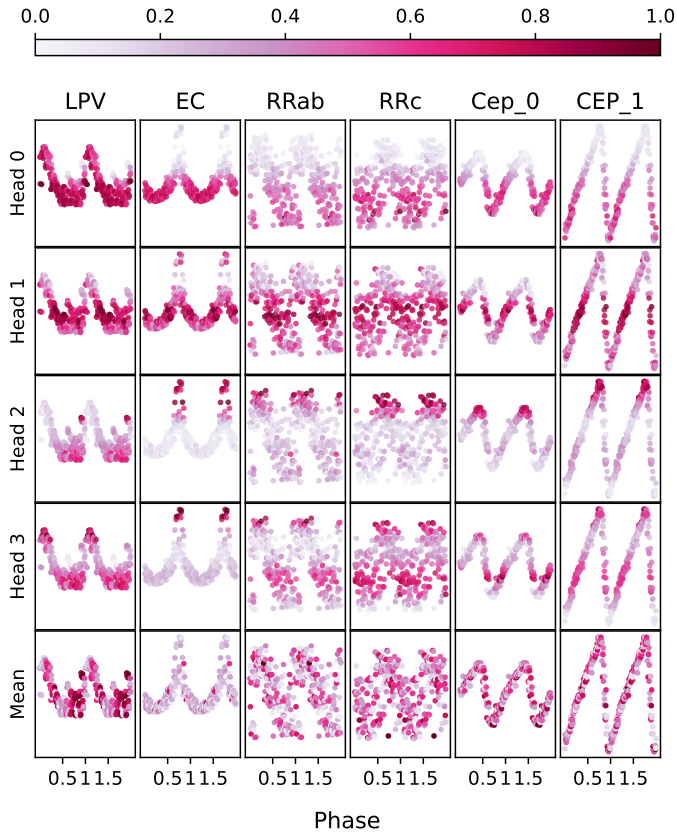

Fig. 8: Average attention per head for a random sample from each class of the Alcock dataset. The light curves were folded for better visualization. The final plot represents the mean across all attention heads. The top bar shows the normalized attention value, with higher values indicating better attention.

based gradients, while the encoder focuses exclusively on capturing dependencies between observations.

Per-sample embeddings were generated by averaging the attention vectors from the encoder, with trainable parameters $\gamma_0, \dots, \gamma_m$ weighting the outputs of each block. The resulting embedding is then passed through a feed-forward network consisting of three hidden layers with 1024, 512, and 256 units, respectively, each using ReLU activation. A fully connected layer without activation predicts the final label, as shown in Figure 10.

Figure 11 presents the F1 scores for the Alcock dataset across different scenarios. For comparison, it also includes F1 scores from Astromer 1, evaluated on the same dataset, using both weighted per-sample embeddings (v0) and non-weighted embeddings as detailed in Donoso-Oliva, C. et al. (2023).

The improvements are most pronounced when evaluating classification performance on the ATLAS dataset. As depicted in Fig. 12, the new version of Astromer exhibits a significant advantage in generalizing to other datasets. With just 20 SPC, Astromer achieves a F1-score improvement of over 15%. Thus, Astromer’s performance with 20 SPC surpasses the results previously reported 500 SPC.

Weighted per-sample embeddings play a critical role by allowing the model to use intermediate representations instead of depending exclusively on the final one. During pretraining, the encoder focuses on reconstructing magnitudes from the last em-

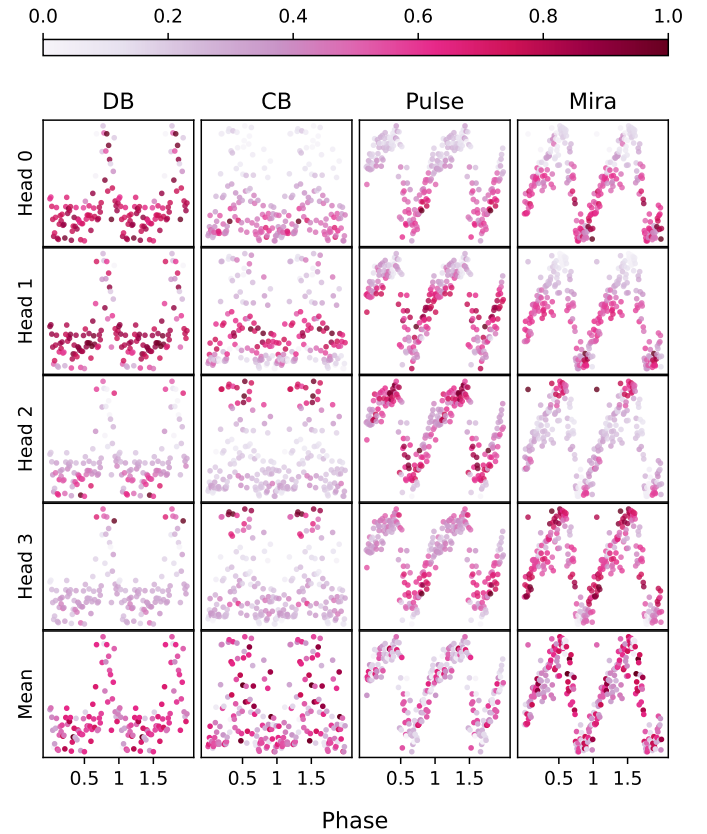

Fig. 9: Analogous to Figure 8, but showing results for ATLAS.

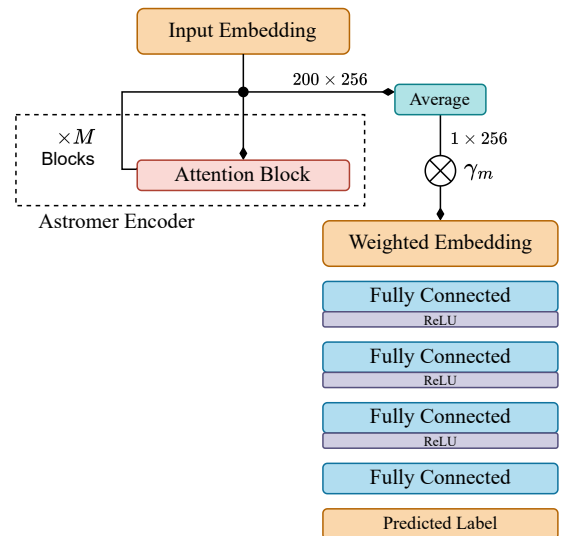

Fig. 10: Classifier architecture used in Astromer 2. The input is a weighted embedding, and the classifier consists of a feed-forward network with three hidden layers and ReLU activation.

bedding, which could result in representations tailored to the reconstruction task rather than optimized for discrimination.

To examine the role of intermediate embeddings, we plot the gamma parameters after training the classifier on both the Alcock and ATLAS datasets. As shown in Fig. 13, the weights assigned to intermediate embeddings are higher than those for the

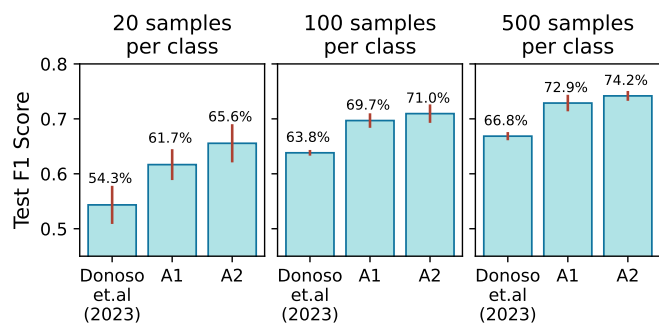

Fig. 11: Classification results on the MACHO-labeled test dataset. The x-axis labels represent the encoder architectures used. For a fair comparison, both Astromer 1 (A1) and Astromer 2 (A2) employ the same classifier, which uses the weighted average embedding. In contrast, the results for Donoso-Oliva, C. et al. (2023) are based on a classifier trained using the average embedding from the last block, as detailed in our previous publication.

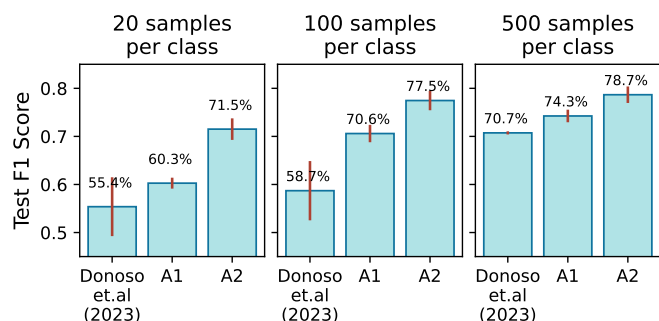

Fig. 12: Classification results on the ATLAS labeled test dataset. The description and methodology are consistent with those provided in Figure 11.

initial or final ones. This disparity becomes more pronounced as the number of training samples increases.

In Figures 14 and 15, we present t-SNE projections of the embeddings associated with the first fold of the test set. These projections are computed from the average output of each attention block. Each output consists of a set of 200×256 vectors, which we reduce to a single 1×256 vector by averaging.

The first thing to notice is that there is evidence that Astromer properly separates classes in both the Alcock and ATLAS datasets. Recall that these embeddings were trained solely on light curve reconstruction, without any information about the labels.

Classes are separated in different ways depending on the block. For both Alcock and ATLAS, the first block does not seem to separate classes at all, while other blocks exhibit better discrimination. This aligns with the γ parameters we introduced to weight each block's output during classifier training (see Figure 13).

Alternatively, we can observe the effect of class separation in the confusion matrices in Figures 16 and 17. Specifically, for the Alcock dataset, the main confusion occurs between RR Lyrae types ab and c. A similar pattern is observed in the projection of Figure 14, where the blue (RRab) and purple (RRc) points are mixed together. In ATLAS, there is an *Other* class, which can be particularly confusing for the model. As observed in Figure

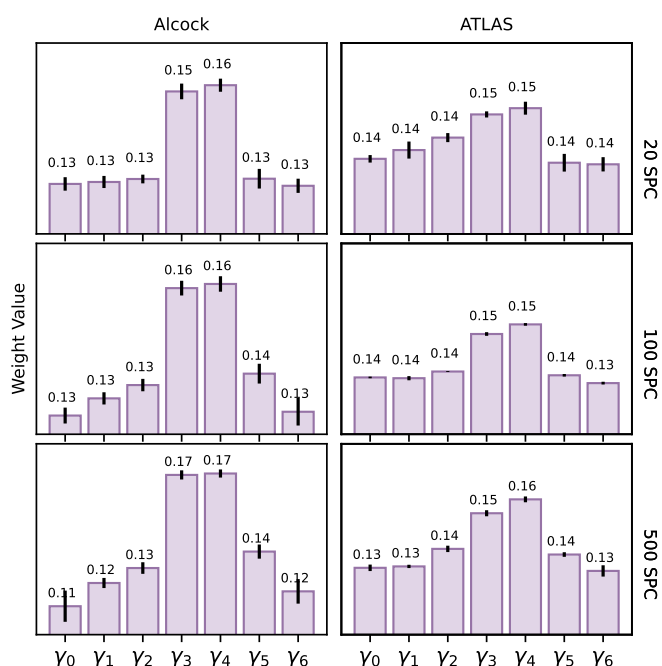

Fig. 13: Values of the trainable parameters that scale the contribution of intermediate embeddings. γ_0 represents the weight of the input embedding, while $\gamma_1, \dots, \gamma_6$ correspond to the weights for the outputs of the attention blocks. These weights are optimized during the training of the classifier.

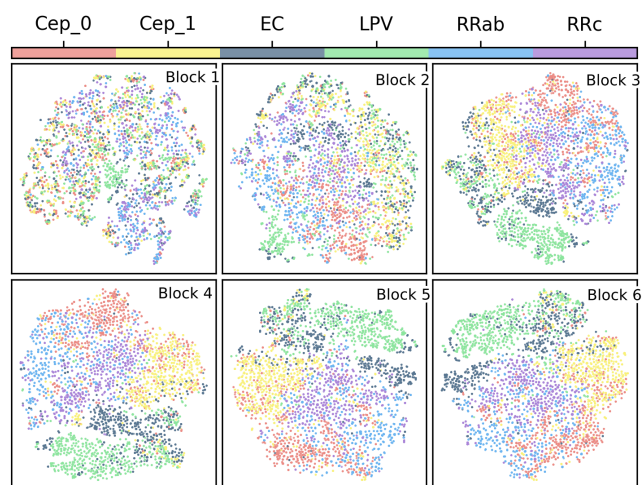

Fig. 14: t-SNE projection (perplexity=30 and learning rate=1000) of MACHO embeddings. Each plot visualizes the output of each attention block from Astromer 2.

15, the blue points corresponding to the *Other* class are sparsely distributed in the embedding space.

6. Conclusion

This paper presents the updated version of Astromer, a self-supervised model designed to extract general-purpose embeddings from light curve data. We demonstrate that Astromer 2 outperforms its predecessor, Astromer 1, across multiple scenarios, including both the Alcock and ATLAS datasets. The key improvements in classification performance, especially when

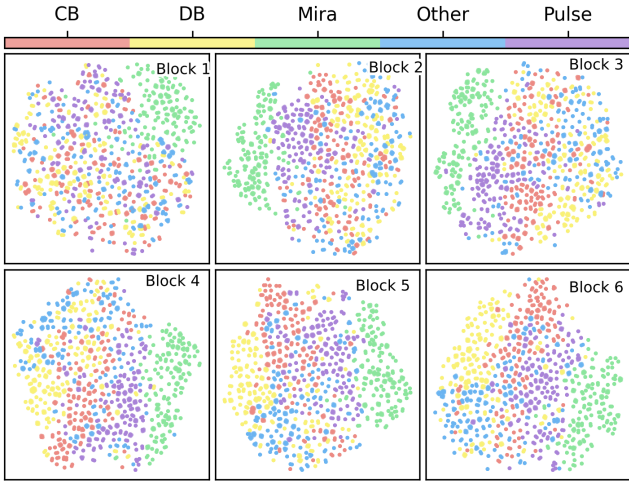

Fig. 15: t-SNE projection (perplexity=30 and learning rate=1000) of ATLAS embeddings. Each plot visualizes the output of each attention block from Astromer 2.

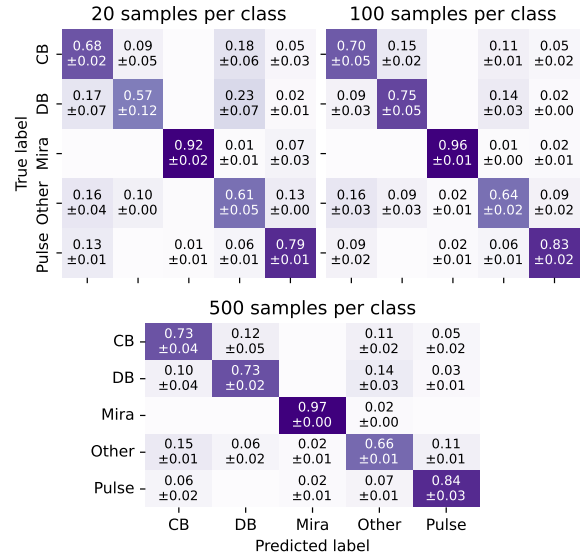

Fig. 17: Similar to Figure 16 but with ATLAS.

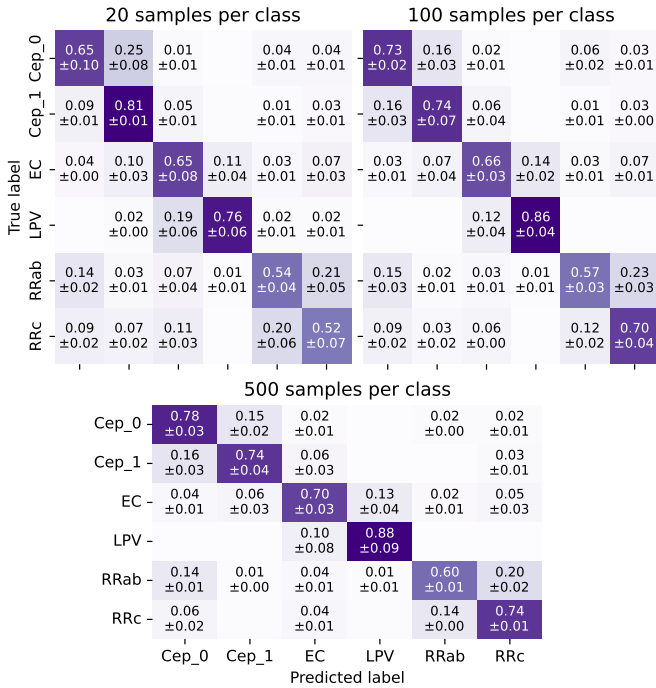

Fig. 16: Confusion matrices for the test set of the Alcock dataset, evaluated on classifiers trained with 20, 100, and 500 samples per class, following our methodology.

trained with limited labeled samples, highlight the informative power of the embeddings in discriminating between different classes.

The results show that Astromer 2 achieves significant gains in F1 score, especially with small training sets, underscoring the effectiveness of the weighted per-sample embeddings and the model's ability to generalize across different datasets. The analysis of attention weights further reveals that intermediate embeddings contribute meaningfully to the model's performance, focusing more on certain parts of the input data during the classification task.

These findings confirm the potential of Astromer as a robust tool for light curve analysis, showing that self-supervised learning can provide valuable insights into astronomical data. Future directions may explore the integration of multi-modal data and more complex attention mechanisms, though the simplicity and efficiency of the current approach remain significant advantages. Future work on Astromer will focus on incorporating multiband data, either as an additional feature embedding or by directly constraining the embedding space. Additionally, we plan to train Astromer on the entire survey, bringing in more data during pre-training and potentially capturing more informative representations.

7. Ethical and Practical Considerations

Large-scale models require significant computational resources, highlighting the need for optimization. According to Lannelongue et al. (2021), training Astromer 2 resulted in 32.29 kg of CO₂ emissions, which is equivalent to a 195.96 km trip in a passenger car.

To mitigate this environmental impact, we provide pre-trained weights in our repository, enabling users to build upon our model without the need for full retraining. If you have new data, we encourage you to share your pre-trained models as a pull request in our repository.

Code, weights, and data can be found in our official organization: <https://github.com/astromer-science>. Additionally, we provide a website with user practical information <https://www.stellardnn.org/projects/astromer/index.html>.

References

- Alcock, C., Akerlof, C. W., Allsman, R. A., et al. 1993, *Nature*, 365, 621
- Alcock, C., Allsman, R., Alves, D., et al. 2003, *VizieR Online Data Catalog*, II/247
- Alcock, C., Allsman, R. A., Alves, D. R., et al. 1999, *PASP*, 111, 1539
- Awais, M., Naseer, M., Khan, S., et al. 2023, arXiv preprint arXiv:2307.13721
- Bommasani, R., Hudson, D. A., Adeli, E., et al. 2021, arXiv preprint arXiv:2108.07258
- Chaini, S., Mahabal, A., Kembhavi, A., & Bianco, F. B. 2024, *Astronomy and Computing*, 100850

- Deb, S. & Singh, H. P. 2009, *A&A*, 507, 1729
- Debosscher, J., Sarro, L. M., Aerts, C., et al. 2007, *Astronomy & Astrophysics*, 475, 1159
- Devlin, J., Chang, M.-W., Lee, K., & Toutanova, K. 2018, arXiv preprint arXiv:1810.04805
- Donoso-Oliva, C., Becker, I., Protopapas, P., et al. 2023, *A&A*, 670, A54
- Heinze, A., Tonry, J. L., Denneau, L., et al. 2018, *The Astronomical Journal*, 156, 241
- Lannelongue, L., Grealey, J., & Inouye, M. 2021, *Advanced science*, 8, 2100707
- Lanusse, F., Parker, L. H., Golkar, S., et al. 2023, in *NeurIPS 2023 AI for Science Workshop*
- Martínez-Galarza, J. R., Bianco, F. B., Crake, D., et al. 2021, *Monthly Notices of the Royal Astronomical Society*, 508, 5734
- Nun, I., Protopapas, P., Sim, B., et al. 2015, arXiv preprint arXiv:1506.00010
- Pantoja, R., Catelan, M., Pichara, K., & Protopapas, P. 2022, *MNRAS*, 517, 3660
- Parker, L., Lanusse, F., Golkar, S., et al. 2024, *Monthly Notices of the Royal Astronomical Society*, 531, 4990
- Richards, J. W., Starr, D. L., Butler, N. R., et al. 2011, *ApJ*, 733, 10
- Rizhko, M. & Bloom, J. S. 2024, in *Neurips 2024 Workshop Foundation Models for Science: Progress, Opportunities, and Challenges*
- Sánchez-Sáez, P., Reyes, I., Valenzuela, C., et al. 2021, *The Astronomical Journal*, 161, 141
- Tonry, J. L., Denneau, L., Heinze, A. N., et al. 2018, *Publications of the Astronomical Society of the Pacific*, 130, 064505
- Wang, J., Jiang, H., Liu, Y., et al. 2024, arXiv preprint arXiv:2408.01319