

Multilayered Intelligent Reflecting Surface for Long-Range Underwater Acoustic Communication

Yu Luo*, Lina Pu†, Aijun Song‡

*Department of Electrical and Computer Engineering, Mississippi State University, Mississippi State, MS, 39759

†Department of Computer Science, University of Alabama, Tuscaloosa, AL 35487

‡Department of Electrical and Computer Engineering, University of Alabama, Tuscaloosa, AL 35487

Email: yu.luo@ece.msstate.edu, lina.pu@ua.edu, song@eng.ua.edu

Abstract— This article introduces a multilayered acoustic reconfigurable intelligent surface (ML-ARIS) architecture designed for the next generation of underwater communications. ML-ARIS incorporates multiple layers of piezoelectric material in each acoustic reflector, with the load impedance of each layer independently adjustable via a control circuit. This design increases the flexibility in generating reflected signals with desired amplitudes and orthogonal phases, enabling passive in-phase and quadrature (IQ) modulation using a single acoustic reflector. Such a feature enables precise beam steering, enhancing sound levels in targeted directions while minimizing interference in surrounding environments. Extensive simulations and tank experiments were conducted to verify the feasibility of ML-ARIS. The experimental results indicate that implementing IQ modulation with a multi-layer structure is indeed practical in real-world scenarios, making it possible to use a single reflection unit to generate reflected waves with high-resolution amplitudes and phases.

Index Terms—Acoustic reconfigurable intelligent surface (ARIS), multilayer structure, in-phase and quadrature (IQ) modulation, underwater acoustic communication.

I. INTRODUCTION

Recent advancements in reconfigurable intelligent surfaces (RIS) have attracted significant attention for their potential to enhance the performance of radio communication systems [1], [2]. These surfaces utilize a large array of elements, which can be electronically adjusted to actively control the phase, amplitude, and polarization of incoming signals. This capability allows for precise steering of reflected waves toward designated receivers while minimizing interference in specified zones. As a result, RF-RIS promises to boost signal strength, expand coverage, and streamline interference management in the next generation of wireless networks [3].

The passive operation of RIS offers superior power conservation compared to active communication systems, making it highly sustainable for extreme environments, such as underwater settings where battery replacement is impractical. However, existing RIS research predominantly focuses on radio frequency (RF) communications, which face significant range limitations in aquatic settings due to substantial absorption losses in water [4].

As a result, acoustic communication has been the principal method for mid-range and long-range underwater communication. Due to the fundamental differences between RF and acoustic signals, current RF-RIS designs are unsuitable for direct application in underwater acoustic RIS (UA-RIS). Currently, only a few studies explored the design of UA-RIS [5], [6], highlighting a significant opportunity for advancements and breakthroughs in the field.

Our field experiments have confirmed the potential of UA-RIS to enhance the range and data rate of underwater acoustic

communications [7]. Nevertheless, transitioning UA-RIS from theory concepts to practical application still needs to overcome a series of unique challenges:

- a) **Varying impedance of acoustic reflector:** The impedance of piezoelectric materials like lead zirconate titanate (PZT) varies with frequency, water depth, temperature, and acoustic wave angle, unlike RF reflectors, which depend only on frequency. Therefore, the matching circuit for acoustic reflectors must be electronically reconfigurable to adapt to these environmental changes.
- b) **Low frequency of acoustic signal:** Acoustic signals in underwater communication are typically below 100 kHz, challenging traditional phase-shifting methods that use varactors, which don't provide enough capacitance variation. This necessitates developing new phase-shifting mechanisms for UA-RIS to effectively control wave reflection.
- c) **Size and weight constraint:** Unlike RF-RIS, which can accommodate thousands of reflection unit cells on a printed circuit board (PCB), acoustic reflectors need to be larger and heavier to resonate with mechanical waves at low frequencies. This constraint significantly reduces the number of reflecting units in UA-RIS, requiring innovative designs to maximize directional gain with fewer units.

To address these challenges, we introduce a multilayered acoustic reconfigurable intelligent surface (ML-ARIS) featuring a stacked architecture to enable flexible acoustic reflection. In ML-ARIS, the reflector comprises multiple stacked PZT disks, each with independently adjustable load impedance via a control circuit. This design increases the flexibility in generating reflected signals with desired amplitudes and orthogonal phases. By programming the control circuit, the superposed wave from each reflector can have any desired phase and amplitude. Consequently, ML-ARIS can execute passive in-phase and quadrature (IQ) modulation on a single acoustic reflector, enabling precise beam steering and significantly boosting wave intensity toward targeted areas.

Unlike multi-bit coding RF-RIS, which typically produces a very limited number of phase shift states and lacks control over the strength of the reflected signal [8], [9], ML-ARIS with IQ modulation can generate a high-resolution reflection coefficient. Consequently, ML-ARIS is capable of performing advanced array processing methods such as robust capon beamforming (RCB) and minimum variance distortionless response (MVDR). These techniques enhance the intensity of reflected waves in targeted directions while mitigating unintended interference in surrounding environments.

In addition to the multilayer structure, an enhanced match-

ing network is implemented to address the varying impedance of piezoelectric materials in dynamic environments. This network features a three-tier subnetwork architecture, with each tier comprising a high-pass L-type matching circuit. The interconnection between the tiers is managed by a microcontroller (MCU), allowing adaptation to changes in the reflector's impedance caused by temperature fluctuations and the incident angle of acoustic waves. To ensure optimal performance, the tiers operate in a cascaded manner rather than independently. The parameters of all components in the matching circuit, including capacitance and inductance, are determined by solving an optimization problem.

We conducted extensive experiments in a tank environment, as well as simulations using the COMSOL platform, to evaluate the performance of ML-ARIS around 28 kHz and 41 kHz. The tests demonstrated that with the proposed matching circuit, the magnitude of the reflection coefficient at the target load remains below 0.15 as the water temperature ranges from 9°C to 22°C and the acoustic signal frequency varies between 27.5 kHz and 28.5 kHz at different water depths. Both the simulation and tank experiment results confirm that the stacked architecture with IQ modulation can effectively manipulate the amplitude and phase of reflected waves on a single reflection unit. Compared to multi-bit coding schemes, ML-ARIS with IQ modulation generates significantly lower side lobes in the reflected beam, enabling more devices to share the acoustic channel without causing interference issues. In particular, our work makes three key contributions:

- a) A multilayer structure-based ARIS is proposed for underwater acoustic communications. ML-ARIS enables IQ modulation on each reflector, allowing for creation of reflected signal with tailored amplitude and phase, enabling precise beam steering through advanced array processing.
- b) We introduce a specialized matching network to accommodate variations in the reflector's impedance caused by environmental changes. This ensures consistent impedance matching along the transmission line, crucial for accurate IQ modulation.
- c) Both tank experiments and COMSOL-based simulations are conducted to assess the feasibility of ML-ARIS. The results validate that the stacked architecture effectively controls the reflected wave, significantly boosting signal strength in targeted directions and minimizing interference.

The remainder of this paper is organized as follows: Section II presents the related work on RIS. Section III motivates the structure of multilayered UA-RIS. The hardware design of ML-ARIS is detailed in Section IV. Section V addresses strategies for enhancing the performance of the matching circuit. Finally, in Section VI, we evaluate the performance of the proposed UA-RIS through simulation and experimental validation. Section VII concludes our work.

II. RELATED WORK

In recent years, extensive research has been undertaken to optimize RF-RIS performance, address implementation challenges, and explore its applicability across diverse communication scenarios. For instance, in [10], three distinct free-space path loss models were developed. These models analyze the relationship between the path loss in RIS-assisted wireless communications and variables such as the distances to the RIS,

the RIS size, and the radiation patterns of reflected waves. Their models are validated through experiments with three fabricated RIS, which paves the way for future theoretical insights and practical innovations in the field of RF-RIS.

The work presented in [11] investigates the energy efficiency of RIS-assisted communication systems. By simultaneously optimizing the transmitter power and the phase shifts of RIS elements, their theoretical analysis suggests that an RIS-assisted network could achieve up to 300% higher energy efficiency compared to conventional multi-antenna amplify-and-forward relaying systems, without compromising quality of service. Additionally, [12] discusses deployment strategies for RIS in millimeter-wave (mmWave) multi-cell networks. The study introduces environment-aware algorithms to optimize RIS placement, enhancing coverage and capacity while mitigating the signal blockages typical in mmWave communications.

In [13] a survey of RF-RIS hardware development is provided. The survey highlights the challenges and innovations in designing cost-effective RIS elements. The role of metamaterials and programmable metasurfaces in achieving dynamic control over EM waves is emphasized. Specific techniques for achieving flexible phase shifts using varactor diodes are examined in [14], [15], and [16]. These works involve placing a varactor diode at the radiating edge of a patch antenna and adjusting its reverse voltage to electronically control the RIS's phase response, allowing for a broad tunable phase control while maintaining a high reflection efficiency.

Currently, only a limited number of studies have investigated the application of RIS techniques in underwater environments. For instance, the research presented in [17] demonstrates the feasibility of using backscattered signals for long-distance passive communications. In this work, a Van Atta array is constructed to automatically align the direction of reflected acoustic waves with the incident waves. By switching the load of each reflector between short and open circuit states, the polarization of the reflected wave is toggled. Consequently, the strength of the received signal, which is the superposition of emitted and reflected waves, exhibits variations. Sea experiments indicate that the Van Atta backscatter array can achieve a round-trip communication range exceeding 300 meters with a bit error rate (BER) of 10^{-3} .

In [5], the enhancement of communication performance using UA-RIS is examined. The design for each reflection unit incorporates a piezoelectric coil positioned between two metal plates, with the resonant frequency adjusted by the reverse voltage applied to a varactor. Meanwhile, [6] explores the design of UA-RIS capable of responding to a wide range of frequencies. This work addresses two specific types of dispersion: element dispersion within each piezoelectric reflector and array dispersion throughout the acoustic RIS. By counteracting these dispersions, the directivity of the reflected waves becomes frequency-independent, allowing wideband signals to achieve uniform beam patterns across various frequency components. The efficacy of this new architecture is validated through Bellhop and COMSOL simulators.

III. MOTIVATION OF MULTILAYERED UA-RIS

This section presents the motivation for our work. We begin by discussing the importance of simultaneously manipulating both the amplitude and phase of reflected waves in UA-RIS

applications. Afterward, the inherent challenges in achieving flexible reflection control are clarified. Finally, we briefly review our previous solution for implementing such control and highlight its limitations.

A. Necessity of Flexible Reflection Control

The underwater acoustic channel is a precious resource. It is essential not only for manmade facilities but also for marine animals that rely on acoustic signals for hunting, communication, and navigation [18]. However, the absorption attenuation of sound signals increases significantly with frequency, limiting the available bandwidth for mid-range and long-range acoustic applications to just tens of kilohertz. As the number of marine facilities increases, efficiently utilizing the underwater channel without causing harm to surrounding environments presents a critical challenge for future acoustic systems.

To meet the above objective, it is crucial to design RIS-assisted underwater acoustic communication systems that not only optimize signal strength at the main lobe but also minimize interference from side lobes. The typical 1-bit and 2-bit coding schemes used in RF-RIS may fall short, as the phase resolution of RIS elements is a significant determinant of system performance. According to array processing principles [19], an RIS with arbitrary reflection coefficients can increase the directional gain of the reflected wave by approximately 23.46% (~ 0.9 dB) over a 2-bit coding RIS and diminish side lobe interference by around 50% (~ 3 dB).

Allowing flexible control over reflection coefficients also enhances the degrees of freedom (DoF) of UA-RIS, enabling advanced array processing methods that significantly improve the performance of underwater acoustic communication networks. For example, the MCDR can be deployed to create nulls in specific directions, thereby preventing eavesdroppers from intercepting information from the reflected signals. Additionally, the recursive least squares (RLS) algorithm can be used to precisely direct reflected beams towards multiple users, allowing several devices at different locations to simultaneously receive data from the same sender.

B. Challenges of Flexible Reflection Control

In RF-RIS, each unit can flexibly control the phase of the reflection coefficient by adjusting the load reactance. This is accomplished by integrating varactor diodes into the load and modifying the reverse bias voltage applied to the varactor's p-n junction [16], [20]. However, this approach is impractical for UA-RIS due to the low frequencies associated with acoustic signals. Specifically, the reflection coefficient, denoted as Γ , in a transmission line is defined as:

$$\Gamma = \frac{Z_L - Z_0}{Z_L + Z_0}, \quad (1)$$

where Z_L represents the load impedance, and Z_0 is the characteristic impedance of the transmission line, typically 50Ω in RF systems.

Based on the above equation, if a reflector is designed to adjust the phase of Γ from -45° to -90° , the load impedance should change from $-j121 \Omega$ to $-j50 \Omega$, where j represents the imaginary part of the impedance contributed by the reactive components. In this scenario, if an RF-RIS operates at the 2.4 GHz frequency band, the capacitance of the load capacitor

needs to vary from 0.55 pF to 1.33 pF. This range falls within the capability of many commercial varactor diodes [21], [22]. In contrast, if the frequency is reduced to 25 kHz for long-distance acoustic communication, the required capacitance of the load capacitor must change from 52 nF to 128 nF to achieve the same phase adjustment. This range significantly exceeds the capabilities of most varactor diodes, which typically have capacitance values below 1 nF.

C. Previous Solution of Flexible Reflection Control

In our previous work [7], we introduced an IQ modulation-based RIS for synthesizing acoustic waves with customizable amplitude and phase. That approach required generating in-phase and quadrature components using two distinct reflectors, which significantly reduced performance relative to the multilayer structure proposed in this paper. In the following, we provide a detailed comparison of the two methods.

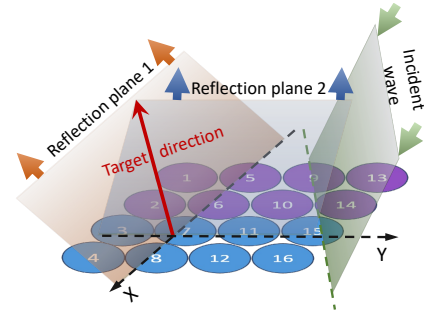

Figure 1: IQ modulation implemented with separated reflectors.

Fig. 1 illustrates the IQ modulation scheme from [7]. In this configuration, two adjacent reflectors sharing the same Y-coordinate are paired. For example, reflector 5 is paired with reflector 6. When paired, these reflectors collectively act as a single reflector on reflection plane 1. This is possible because their projected positions along the Y-axis are aligned, ensuring that positional differences do not introduce additional phase shifts on that plane. During operation, the paired reflectors produce orthogonal reflection coefficients, allowing the synthesis of reflected waves with arbitrary phase waves on plane 1 through appropriate adjustments of the amplitude ratio between these orthogonal components.

Using the above approach, two groups of reflectors indicated by purple and blue in Fig. 1 are formed. Each group consists of four reflector pairs, forming four collective reflectors along the Y-axis. These collective reflectors can generate any desired amplitude and phase of the reflection coefficients. By varying the phase differences among neighboring collective reflectors, the angle of reflection plane 1 can be effectively altered.

D. Disadvantages of Previous Work

In an ideal scenario, the reflected wave would be superposed along a single line oriented toward the target, rather than spread over a plane. As illustrated in Fig. 1, this is achieved by configuring two sets of linear arrays along the X and Y axis to form two reflection planes. The intersection of these planes defines the directivity of this two-dimensional array.

However, for the UA-RIS proposed in our previous research [7], all reflection coefficients are determined solely by the

angle of the reflection plane 1 and the incident wave, leaving no additional DoF to establish a second reflection plane. Implementing such an additional plane would require pairing reflectors along the X-axis and Y-axis simultaneously, which is not feasible under that design. As a result, performing IQ modulation with separate reflectors can only achieve one-dimensional gain, offering no directivity improvement in the orthogonal dimension. For an $N \times N$ array, this reduces the performance to that of $N/2$ independent linear arrays, each with N acoustic reflectors.

To improve the performance of UA-RIS, a new structure is needed to flexibly control the phase and the amplitude of reflected waves. The criteria for this structure are: (a) The design should achieve optimal or near-optimal main lobe gain and side lobe suppression, approaching the performance of an ideal two-dimensional RIS. (b) It should readily adapt to varying environmental conditions, such as variation in intensity and angle of the incident wave, temperature changes, and deployment depths, thereby expanding the application range of UA-RIS. (c) The new structure should be economically feasible, enabling large-scale deployment.

IV. HARDWARE ARCHITECTURE

This section outlines the hardware design of the UA-RIS. The multilayer structure of the acoustic reflector is introduced first. Subsequently, we present the circuit designed to generate in-phase and quadrature-reflected waves for effective IQ modulation.

A. Multilayered Acoustic Reflector

In ML-ARIS, we leverage the acoustic coupling property inherent in mechanical waves to implement IQ modulation within a single reflector. This property facilitates the transfer of mechanical vibrations across the medium, enabling energy propagation into subsequent layers. Unlike electromagnetic fields, where a conventional RF reflector acts as a conductive boundary that prevents wave penetration beyond the initial layer, the multilayer structure proposed in this work is specific to UA-RIS and fundamentally differs from existing solutions developed for EM-based applications.

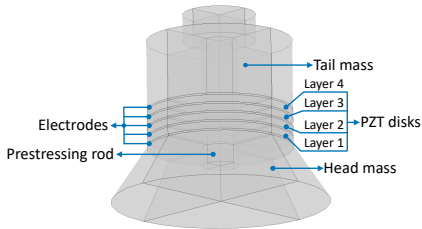

Figure 2: The structure of a multilayered acoustic reflector.

The structure of the acoustic reflector designed for the ML-ARIS system is illustrated in Fig. 2. This reflector employs a Tonpilz-style configuration to achieve efficient electroacoustic conversion in the mid-frequency band. Within the reflector, a head mass composed of aluminum alloy promotes effective oscillation along the central axis while minimizing stress on other components. A stack of PZT ceramic disks is sandwiched between the head and back masses, serving as the core elements that control the reflected waves. To enhance acoustic

coupling efficiency, the PZT stack is held under a constant compressive preload by a prestressing rod. At the rear, a tail mass reflects backward-traveling vibrations, ensuring that the reflected waves propagate forward.

It should be noted that, unlike conventional Tonpilz-type acoustic transducers where piezoelectric disks are connected in parallel, each PZT disk in the ML-ARIS reflector is isolated by insulating materials and operates independently. By adjusting the load impedance of the control circuit associated with each disk, both the phase and amplitude of the reflected wave can be manipulated individually. This design offers a level of control flexibility unattainable with standard transducers.

B. Control Circuit Design

Fig. 3 illustrates the control circuit developed for a two-layer acoustic reflector. The system employs two identical load networks, each composed of four primary subnetworks: a matching network, a resistive network, a capacitive network, and an inductive network. The TCA9555 I/O extender, interfacing with the ATmega256RFR2 MCU via the I²C protocol, governs the configuration of each load network. This arrangement enables precise manipulation of both the phase and amplitude of the waves reflected by the corresponding PZT disk, thereby facilitating effective IQ modulation.

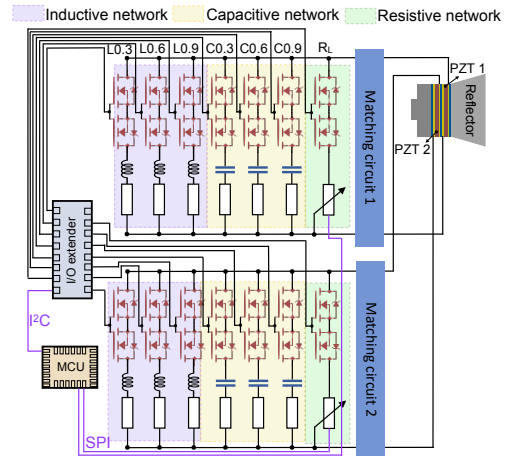

Figure 3: Control circuit of a two-layer acoustic reflector.

The matching network aligns the PZT disk impedance to a specified real value Z_0 , adapting environmental variations as will be detailed in Section V. The resistive network, which includes an AD8403AR50 programmable potentiometer, provides the in-phase component required for IQ modulation. When the pair of n-type MOS (NMOS) transistors in the resistive network is activated by the I/O extender, the potentiometer is engaged with the matching circuit. Under these conditions, the reflection coefficient of PZT disk 1 is given by

$$\Gamma = \frac{R_L - Z_0}{R_L + Z_0}, \quad (2)$$

where R_L represents the resistance of the programmable potentiometer and $Z_0 = 1 \text{ k}\Omega$ is the characteristic impedance chosen for our circuit design. Here, Z_0 is significantly higher than 50Ω used in typical RF systems to accommodate the wiper resistance of the programmable potentiometer. Further details can be found in our previous work [7].

As indicated by (2), when the load is a resistive component, Γ is a real number, then the phases of the reflected and incident waves will be identical or reverse. By adjusting R_L through programming the potentiometer, we can dynamically manipulate the amplitude of the in-phase component.

The capacitive and inductive networks are designed to generate the quadrature component for IQ modulation. Each sub-network comprises three stages. Connecting different stages of the subnetwork to the matching circuit yields a reflection coefficient with a consistent phase of -90° (capacitive load) or 90° (inductive load) and three selectable amplitudes increasing stepwise from 0.3 to 0.9.

C. How IQ Modulation Works with ML-ARIS

Consider an incident wave represented by $\cos(\omega t + \phi_{in})$, where ω is the angular frequency, t is time, and ϕ_{in} is the initial phase of the incident wave. The desired reflected wave is given by $A_r \cos(\omega t + \phi_{in} + \phi_r)$, with $A_r \in [0, 1]$ and $\phi_r \in [-\pi, \pi]$ denoting the amplitude and phase shift of the reflected wave, respectively. Using trigonometric identities, the reflected wave can be expressed as

$$\begin{aligned} & A_r \cos(\omega t + \phi_{in} + \phi_r) \\ &= A_r \cos \phi_r \cos(\omega t + \phi_{in}) - A_r \sin \phi_r \sin(\omega t + \phi_{in}) \\ &= A_r \cos \phi_r \cos(\omega t + \phi_{in}) + A_r \sin \phi_r \cos\left(\omega t + \phi_{in} + \frac{\pi}{2}\right). \end{aligned} \quad (3)$$

As indicated in (3), the first term is the in-phase component, maintaining the same phase as the incident wave, while the second term is the quadrature component, which introduces a -90° phase shift relative to the incident wave.

For the two-layer acoustic reflector shown in Fig. 3, the resistive network of the first PZT disk is activated to produce the in-phase component. From (2), the resistance of the potentiometer is set as

$$R_L = \left(\frac{1 + A_r \cos \phi_r}{1 - A_r \cos \phi_r} \right) Z_0. \quad (4)$$

To generate the quadrature component, the capacitive or inductive network of the second PZT disk is enabled. Specifically, if $\sin \phi_r \geq 0$, the inductive network is activated; otherwise, the capacitive network is used. Finally, the subnetwork stage that reproduces the amplitude of the reflective wave most close to $A_r \sin \phi_r$ is connected to the matching circuit.

Using the aforementioned method, the PZT disks within the acoustic reflector can produce two orthogonal waves with adjustable amplitudes. These waves are then combined in water, forming a spherical wave with a prescribed phase and magnitude for beam steering.

It should be noted that in a conventional Tonpitz-style acoustic transmitter, multiple PZT disks are connected in parallel and driven by the same electrical signal, resulting in uniform mechanical deformation across all disks. In contrast, for the multilayered reflector proposed here, the mechanical deformation varies among layers because the phases of the electric fields reflected by the load networks of adjacent PZT disks are orthogonal. Consequently, in practical implementations, the reflection signals generated within different layers exhibit a certain degree of coupling rather than being entirely independent. The influence of this coupling on the accuracy of the reflected waves will be examined through simulations and tank experiments, as detailed in Section VI.

V. ENHANCED MATCHING NETWORK

This section introduces an enhanced matching network designed to improve the adaptability of ML-ARIS across various environments. Initially, we analyze the necessity for a new matching network, followed by a detailed explanation of a simplified circuit model for underwater acoustic reflectors. Subsequently, we present the architecture of the new matching network and explore the methods employed to optimize its performance under diverse conditions.

A. Necessity for a New Matching Network

In RF-IRS systems, the impedance of the reflector changes exclusively with frequency. Under these conditions, a wide-band matching circuit proves highly effective in aligning the impedance of the reflector with that of the load. However, for underwater acoustic reflectors constructed from PZT material, the impedance changes not only with frequency but also in response to temperature of the water, incident angle, and deployment depth. To ensure efficient operation of the ML-ARIS across various application scenarios, the matching circuit must be wide-band and adaptable to environmental changes.

1) *Water temperature & depth:* In Fig. 4, an Agilent E5071C vector network analyzer (VNA) is employed to investigate how the impedance of a PZT disk varies with signal frequency and water temperature. The structure of the reflector used in the test has been introduced in Fig. 2. The resonate frequencies of all disks are around 28.2 kHz at 20°C. In the figure, the symbols R and X denote the real and imaginary components of the impedance at the first PZT disk, respectively.

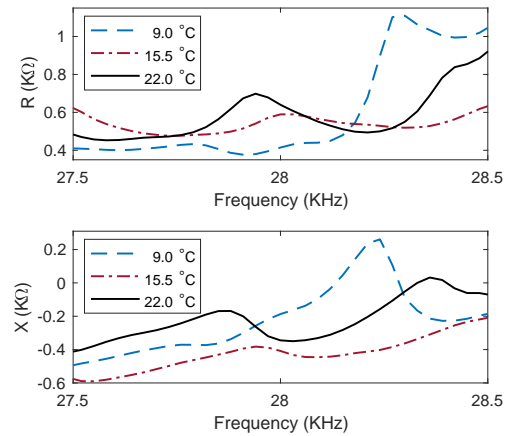

Figure 4: Impedance variation of PZT disk 1 with frequency and temperature.

As illustrated in Fig. 4, both R and X exhibit substantial changes at the resonant frequency with varying temperatures. For instance, at a water temperature of 9°C and a signal frequency of 28.2 kHz, R is $678\ \Omega$ and X is $142\ \Omega$. As the temperature rises to 22°C , R decreases to $494\ \Omega$, and X shifts to $-247\ \Omega$. As a result, with the water temperature rising from 9°C to 22°C , the magnitude of the PZT disk impedance at 28.2 kHz increases by 20%, and the reactance of the impedance transitions from capacitive to inductive.

In addition to the variation of temperature, the impedance of the PZT material also changes with water depth. Specifically, the capacitance of PZT, which depends on their geometry and

dielectric properties, is particularly sensitive to these changes. Increased water depth results in heightened pressure, which imposes mechanical stress on the material. This stress compresses the thickness of the material, consequently increasing its capacitance, which in turn leads to a reduction in the imaginary component of the impedance.

2) *Incident angle*: For a typical RF-RIS operating in free space, the direction of incoming waves does not significantly alter the electrical reflector's input impedance. In contrast, for an acoustic reflector in an underwater environment, the impedance varies noticeably with the incident angle due to changes in boundary conditions and how sound couples into or out of the piezoelectric material at different angles.

Moreover, the variation in impedance with incident angle may differ across the individual PZT layers. This phenomenon can be validated through a COMSOL multiphysics simulator. Specifically, in the simulation, a reflector comprising four PZT layers is constructed. Each layer measures $6\text{ cm} \times 0.48\text{ cm}$ and is separated by an acrylic plastic layer 0.2 mm in thickness. The incident signal is a monochromatic plane wave with a frequency of 41 kHz and an intensity of 1 Pa .

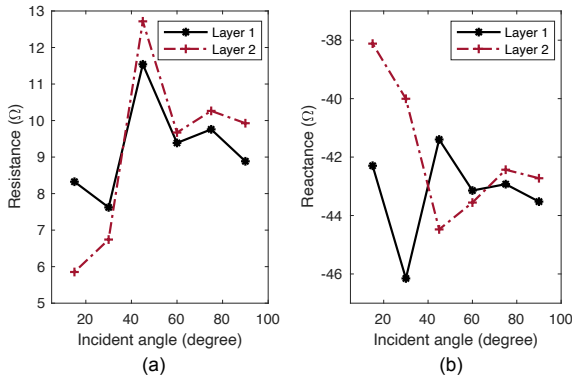

Figure 5: Impedances of PZT layers under varying incident angles of acoustic waves: (a) Resistance component. (b) Reactance component.

In Fig. 5, we vary the direction of incoming waves and measure the resistance and reactance for the first two layers of the PZT stack. The impedance in this figure is calculated from the ratio of the open-circuit voltage to the short-circuit current induced by the incoming waves. As illustrated, both the resistance and reactance of the PZT impedance demonstrate non-monotonic variations with changes in the incident angle. For example, at an incident angle of 90° , the resistance and reactance for PZT layer 1 are $8.9\ \Omega$ and $-43.5\ \Omega$, respectively. When the incident angle is reduced to 45° , the resistance increases to $11.5\ \Omega$, a 29.2% increase from the initial value. Reducing the angle further to 30° , the reactance decreases to $-46.1\ \Omega$, a 6% reduction from the 90° incident angle.

For PZT layer 2, at an incident angle of 90° , the resistance and reactance are $9.9\ \Omega$ and $-42.7\ \Omega$, respectively. Changing the angle to 45° leads to an increase in resistance to $12.7\ \Omega$, marking a 28.3% rise from the 90° situation. When the angle is further decreased to 30° , the reactance rises to $-38.1\ \Omega$, showing a 9.7% increase compared to the 90° scenario.

The variation in impedance across different layers arises from distinct acoustic boundary conditions and coupling effects. For instance, the first layer of the PZT stack is in direct contact with water, while the second layer faces the

first PZT disk. In this configuration, the refraction, reflection, and scattering of sound waves at the interface between these layers depend on the incident angle. Moreover, in a multilayer stack, the upper layers encounter the incoming wave directly, whereas deeper layers receive a wave that has already been modified by the preceding layers. As a result, the stress distribution among different layers is inconsistent, particularly when the incident wave is not perpendicular to the reflector.

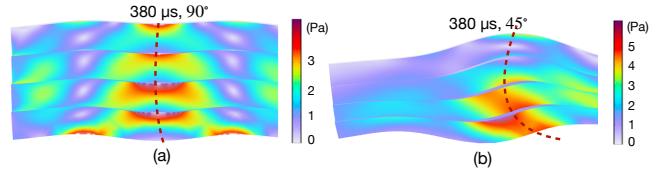

Figure 6: Stress variation across 4 layers of the PZT stack, measured at $380\ \mu\text{s}$. (a) Incident angle: 90° . (b) Incident angle: 45° .

In Fig. 6, we present the stress distribution across four layers of the PZT stack when stimulated by monochromatic plane waves incident from two different directions at $380\ \mu\text{s}$. The mechanical wave propagation speed in PZT material is approximately 3900 m/s , and the total thickness of the four-layer stack corresponds to about 0.2 wavelengths. Under these conditions, it can be reasonably assumed that the mechanical wavefront reaches all layers simultaneously. The red dashed line in the figure indicates the maximum instantaneous stress within the stack. As shown in the figure, when the incident angle is 90° , the stress distribution across different layers is similar, and the red dashed line appears nearly straight. However, when the incident angle decreases to 45° , the stress distribution differs significantly among the layers, causing the red dashed line to form a pronounced arc.

According to the aforementioned analysis, traditional wide-band matching circuits built for RF-RIS are inadequate for handling impedance variations across diverse environmental conditions. This is because their impedance matching depends exclusively on frequency, preventing adaptation to changes in the impedance of an acoustic reflector at any specific frequency. Consequently, for efficient operation in dynamic underwater environments, developing a new matching network is essential for ML-ARIS.

B. Circuit Model of Acoustic Reflector

To design the new matching circuit, it is essential to first develop a circuit model for the PZT disk. Let us denote the impedance of the disk at frequency f as $Z_R(f)$, which can be modeled using electro-acoustic analogies [23]. As shown in Fig. 7, the left part of the model describes the dielectric characteristics of the PZT material, with R_E and C_E indicating the dielectric loss resistance and capacitance of the dielectric plates, respectively. Electrical energy is converted into mechanical energy through a coil transformer with a turns ratio of ϕ . The right side of the model depicts the mechanical behavior of the reflector, where R_M represents the mechanical loss, L_m and C_m express the dynamic mass and elasticity of the reflector. Z_{rad} is the radiating impedance determined by the geometry of the radiator.

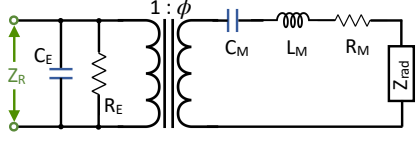

Figure 7: Electrical equivalent to a PZT disk.

Let Z_S be the equivalent impedance of the secondary winding, where

$$Z_S = R_M + j(2\pi f L_M - \frac{1}{2\pi f C_M}) + Z_{rad}. \quad (5)$$

Consequently, the total impedance of the PZT disk can be derived by

$$Z_R = \frac{R_E}{1 + (2\pi f C_E R_E)^2} - j \frac{2\pi f C_E R_E^2}{1 + (2\pi f C_E R_E)^2} + \phi^2 Z_S. \quad (6)$$

Near the resonance frequency, the inductive and capacitive reactances of Z_p in (6) cancel out each other, thus only the resistance of Z_S being reflected onto the primary winding. Additionally, the dielectric loss resistance (R_E) is typically large for underwater acoustic reflectors with high Q-factors, making $2\pi f C_E R_E$ much greater than 1. Under these conditions, the expression for Z_R can be simplified as follows:

$$Z_R \approx \frac{1}{R_E (2\pi f C_E)^2} + \text{Re}'(Z_S) - j \frac{1}{2\pi f C_E}, \quad (7)$$

where $\text{Re}'(Z_S) = \phi^2 \text{Re}(Z_S)$.

As analyzed in Section V-A, the impedance of a PZT disk at any given frequency is not static but varies with environments. Consequently, the resistance and capacitance described in (7) become variables influenced by factors such as water temperature and pressure. Under specific environmental conditions, a VNA or LCR meter can be used to scan Z_R across various frequencies. Subsequently, a non-linear least squares fitting process can be employed to calculate R_E , C_E , and $\text{Re}'(Z_S)$. As the environment transitions from condition 1 to condition m , a set of Z_R can be recorded.

C. Impedance Estimation

As outlined in Section V-B, \mathbf{Z}_R is discrete and can represent the impedance of the PZT reflector in only a limited number of environmental conditions, which is inadequate for designing a matching circuit. Consequently, it is necessary to refine the model of Z_R to approximate the variation in the reflector's impedance across different frequencies and arbitrary environmental conditions.

In \mathbf{Z}_R , let $Z_R^{max}(f_r)$ be the element with the maximum magnitude at the resonate frequency f_r . The parameters used in (7) to fit $Z_R^{max}(f)$ are represented by R_E^α , C_E^α , and $[\text{Re}'(Z_S)]^\alpha$. In contrast, the impedance with the maximum magnitude at f_r is represented by $Z_R^{min}(f_r)$; the parameters used to fit $Z_R^{min}(f)$ are denoted as R_E^β , C_E^β , and $[\text{Re}'(Z_S)]^\beta$, where $R_E^\alpha < R_E^\beta$, $C_E^\alpha < C_E^\beta$, and $[\text{Re}'(Z_S)]^\alpha > [\text{Re}'(Z_S)]^\beta$.

We now discretize R_E , C_E , and $[\text{Re}'(Z_S)]$ into N_d equally spaced values, ranging between their respective minimum and maximum values. The i -th value in this series is represented

as R_E^i , C_E^i , and $[\text{Re}'(Z_S)]^i$, respectively, calculated using the following method:

$$\begin{cases} R_E^i = R_E^\beta - \frac{(i-1) \times (R_E^\beta - R_E^\alpha)}{N_d - 1}, \\ C_E^i = C_E^\beta - \frac{(i-1) \times (C_E^\beta - C_E^\alpha)}{N_d - 1}, \\ [\text{Re}'(Z_S)]^i = [\text{Re}'(Z_S)]^\beta + \frac{(i-1) \times ([\text{Re}'(Z_S)]^\alpha - [\text{Re}'(Z_S)]^\beta)}{N_d - 1}, \end{cases} \quad (8)$$

where $i = 1, \dots, N_d$.

Based on (8) and the simplified circuit model described in (7), a set of impedances, which is denoted by $\mathbf{Z}'_R = \{Z_R^1(f), \dots, Z_R^{N_d}(f)\}$, can be obtained. We consider \mathbf{Z}'_R as an extension of \mathbf{Z}_R , representing a preliminary estimation of the reflector's impedance under various environmental conditions. In Section V-D, we will explore the development of an enhanced matching network tailored to \mathbf{Z}'_R . This new network aims to accommodate impedance variations of the PZT disk over a broad range, thus improving the performance of ML-ARIS in dynamic underwater environments.

D. Design of Enhanced Matching Network

1) *Architecture*: In Fig. 8, we illustrate the architecture of the enhanced matching circuit developed for the first layer of the PZT stack in one of the acoustic reflectors. This circuit features a three-tier subnetwork structure, each tier consisting of a high-pass L-type matching circuit. The interconnection between tiers is managed by NMOS transistors SW_1 and SW_2 , which are controlled by the MCU. It is crucial to note that, the operation of the tiers is not independent but cascaded; for instance, activating tier i requires that tiers 1 through $i-1$ also be activated to achieve the optimal performance.

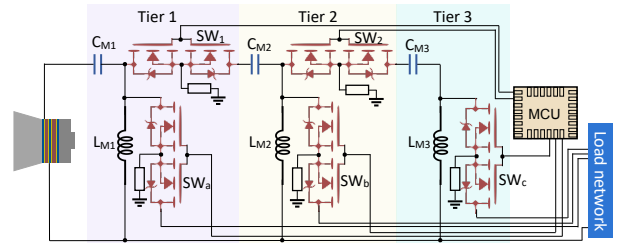

Figure 8: Architecture of the enhanced matching circuit.

In the enhanced matching network, the connection of each tier to the load network is controlled by electronic switches SW_a , SW_b , and SW_c . At any given time, only one switch is active, linking the designated subnetwork to the load. For example, to engage tier-2 to the load, SW_1 is first activated to establish a connection through tier-1 to the PZT disk, followed by activating SW_b to directly link tier-2 to the load.

During operation, each tier in the matching network is cascaded with previous tiers to align with the PZT disk impedance within a specified range. To facilitate the automatic switching of the output tier in response to changes in the reflector's impedance, the MCU periodically connects the digital potentiometer (AD8403AR10, as illustrated in Fig. 3) to the load network and sets its resistance to Z_0 specified

in Section IV-C. Upon detecting the preamble of the acoustic signal, the matching network is sequentially linked into the circuit tier by tier. The closer a tier's output impedance matches Z_0 , the higher the power delivered from the incident signal to the potentiometer. Therefore, when transitioning between tiers of the matching network, the MCU measures the average voltage at the potentiometer using the internal analog-to-digital converter (ADC). It then selects the tier that generates the maximum voltage on the potentiometer for impedance matching.

Next, we will elaborate on the optimization of parameters in each tier of the matching network, ensuring that the characteristic impedance of the transmission line remains consistently at Z_0 , unaffected by variations in the impedance within dynamic underwater environments.

2) *Optimization*: When the load impedance is Z_0 , assume the desired reflection coefficient of each layer in ML-ARIS remains zero throughout the frequency range from f_L to f_H under different environmental conditions. In tier i of the matching circuit, the capacitance and inductance are designated as C_{M_i} and L_{M_i} , respectively. The impedance from the PZT disk to tier i of the matching circuit at frequency f is expressed as $Z_{M_i}(f)$.

For a 3-tier matching circuit, we set $N_d = 9$ in (7). Initially, tier-1 is optimized to align with the first three impedance values from $Z_R^1(f)$ to $Z_R^3(f)$ in \mathbf{Z}'_R . Subsequently, tier-2 joints in to optimize for the middle three impedance values in \mathbf{Z}'_R , specifically $Z_R^4(f)$, $Z_R^5(f)$, and $Z_R^6(f)$. Once the configurations for tier-1 and tier-2 are established, tier-3 collaborates with them to address the final three impedance values in \mathbf{Z}'_R : $Z_R^7(f)$, $Z_R^8(f)$, and $Z_R^9(f)$.

According to Fig. 8, the output impedance of tier-1 is expressed as follows:

$$Z_{M_1}^i(f) = \left(Z_R^i(f) - j \frac{1}{2\pi f C_{M_1}} \right) \parallel j2\pi f L_{M_1}, \quad (9)$$

where the symbol " \parallel " represents the parallel connection. Then, we can formulate the following optimization problem to determine the inductance (L_{M_1}) and capacitance (C_{M_1}) in tier-1 of the matching circuit:

$$\begin{aligned} \mathbf{P1} \quad & \arg \min_{C_{M_1}, L_{M_1}} \sum_{i=1}^3 \sum_{f=f_L}^{f_H} \left| \frac{Z_0 - Z_{M_1}^i(f)}{Z_0 + Z_{M_1}^i(f)} \right|^3, \\ \text{s.t.} \quad & \mathbf{C1:} \quad C_{M_1} > 0, \\ & \mathbf{C2:} \quad L_{M_1} > 0. \end{aligned} \quad (10)$$

In the optimization problem **P1**, the primary component of the objective function is the cube of the magnitude of the reflection coefficient at the load impedance Z_0 . The goal of the optimization is to minimize the sum of these values when the PZT disk impedances are $Z_R^1(f)$, $Z_R^2(f)$, and $Z_R^3(f)$ across the target frequency range. Cubing the cost function can amplify the impact of larger errors more significantly than smaller ones. Consequently, deviations of the reflection coefficient from zero are penalized more severely than they would be under the original cost function, thus focusing on reducing larger discrepancies.

In our design, the simulated annealing algorithm [24] is employed to address the optimization problem described above.

By solving for C_{M_1} and L_{M_1} from (10), $Z_{M_1}^i(f)$ can be obtained through (9). Subsequently, the output impedance for tier-2 is derived using $Z_{M_1}^i(f)$, and an optimization problem analogous to **P1** is formulated to determine C_{M_2} and L_{M_2} . This step aims to minimize the reflection coefficients associated with the impedances $Z_R^4(f)$, $Z_R^5(f)$, and $Z_R^6(f)$. Repeating this methodology, $Z_{M_3}^i(f)$ is calculated based on $Z_{M_2}^i(f)$. From here, C_{M_3} and L_{M_3} are determined to optimize the reflection coefficients for the PZT disk impedances at $Z_R^7(f)$, $Z_R^8(f)$, and $Z_R^9(f)$.

VI. PERFORMANCE EVALUATION

This section validates the feasibility of ML-ARIS through simulation and experimentation. Initially, we test the accuracy of the circuit model developed for the PZT reflector. Subsequently, the performance of the enhanced matching circuit is assessed. We then present experimental results from both tank and lake environments, which confirm the operational viability of the system in real-world applications.

A. Verification of IQ Modulation with Multilayered Structure

1) *Experimental settings*: In Fig. 9, tank experiments are performed to validate the feasibility of IQ modulation using ML-ARIS. In the tests, two BTech Acoustic BT-2RCL [25] omnidirectional acoustic transducers serve as the transmitter and receiver, respectively. The transmitter is driven by a Siglent 1062X arbitrary waveform generator emitting a burst sinusoidal signal consisting of 2,500 cycles. The frequency and peak-to-peak voltage of the source signal are 43.8 kHz and 20 V, respectively. The receiver is connected to a PicoScope 4224A oscilloscope for data acquisition.

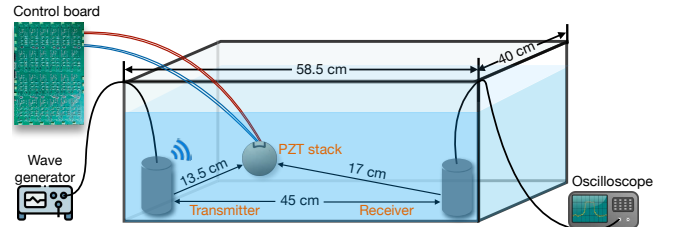

Figure 9: Settings of tank tests.

The reflectors consist of two PZT-4 disks separated by a polyethylene terephthalate (PET) film. The sound wave propagation speed in the disk is approximately 3900 m/s; each PZT disk measures $\phi 49.2 \text{ mm} \times 2.7 \text{ mm}$ and resonates near 44 kHz. The matching network and load states of the reflectors are controlled by the circuit board shown in Fig. 3.

2) *Preprocessing*: In the tank test, the received signals consist of a mixture of three components: (a) the direct wave, (b) waves reflected by the reflector one or more times, and (c) other multipath signals that do not interact with the reflector, where (a) and (c) dominate the received signal. To examine the amplitude and phase generated by the reflected wave, component (b) needs to be separated from the received signal.

To achieve the above objective, we model two reference signals recorded by the receiver as follows:

$$\begin{cases} r_{opop}(t) = \mathcal{A}(t) + \sum_{k=1}^M \left(B_1^{op} e^{j\phi_1^{op}} + B_2^{op} e^{j\phi_2^{op}} \right) s(t - \tau_k), \\ r_{shsh}(t) = \mathcal{A}(t) + \sum_{k=1}^M \left(B_1^{sh} e^{j\phi_1^{sh}} + B_2^{sh} e^{j\phi_2^{sh}} \right) s(t - \tau_k), \end{cases} \quad (11)$$

where $r_{opop}(t)$ and $r_{shsh}(t)$ represent the received signals when the two PZT disks are in open-circuit and short-circuit status, respectively. The term $s(t)$ is the original transmission signal and $\mathcal{A}(t) = \sum_{i=0}^N A_i e^{j\psi_i} s(t - \tau_i)$, where A_i , ψ_i , and τ_i denote the amplitude, phase, and propagation delay of the channel coefficients associated with the direct wave ($i=0$) and the i th multipath signal ($i > 0$) that do not interact with the reflector. The parameters B_1^{op} and ϕ_1^{op} specify the amplitude and phase, respectively, of the wave reflected by the first PZT layer under open-circuit status, while B_2^{op} and ϕ_2^{op} represent those for the second PZT layer.

In (11), only waves undergoing a single reflection from the reflector are considered, because signals undergoing multiple reflections experience significant attenuation and thus have a negligible impact on the received signal. According to the definition of the reflection coefficient presented in (1), under ideal conditions, $B_1^{op} = B_2^{op} = 1$, $\phi_1^{op} = \phi_2^{op} = 0$, and $\phi_1^{sh} = \phi_2^{sh} = \pi$. In this scenario,

$$\mathcal{A}(t) = \frac{r_{opop}(t) + r_{shsh}(t)}{2}. \quad (12)$$

From (11), it can be observed that $\mathcal{A}(t)$ does not depend on the reflector's load status in a stable acoustic environment. Therefore, the waves reflected by the reflector for any load status can be extracted from the received signal using two reference signals. For instance, if the loads of the first and second layers of the PZT stack are $C_{0.6}$ and R_L , respectively, the received signal is denoted by $r_{C_{0.6}R_L}(t)$, while the signal reflected by the PZT stack is given by

$$\mathcal{B}_{C_{0.6}R_L}(t) = \sum_{k=1}^M \left(B_1^{C_{0.6}} e^{j\phi_1^{C_{0.6}}} + B_2^{R_L} e^{j\phi_2^{R_L}} \right) s(t - \tau_k). \quad (13)$$

Based on (12), $\mathcal{B}_{C_{0.6}R_L}(t)$ can be calculated as follows:

$$\begin{aligned} \mathcal{B}_{C_{0.6}R_L}(t) &= r_{C_{0.6}R_L}(t) - \mathcal{A}(t) \\ &= r_{C_{0.6}R_L}(t) - \frac{r_{opop}(t) + r_{shsh}(t)}{2}. \end{aligned} \quad (14)$$

The expression in (14) is used to extract the signal reflected by the reflector in a multipath environment from experimental measurements. For performance evaluation, the theoretical result of the reflected wave, $\mathcal{B}_{C_{0.6}R_L}^*(t)$, is also needed. According to the circuit design presented in Fig. 3, under ideal conditions,

$$\begin{cases} B_1^{C_{0.6}} e^{j\phi_1^{C_{0.6}}} = 0.6 e^{-j\frac{\pi}{2}}, \\ B_2^{R_L} e^{j\phi_2^{R_L}} = \frac{R_L - Z_0}{R_L + Z_0}, \end{cases} \quad (15)$$

where $Z_0 = 1 \text{ k}\Omega$ is the characteristic impedance introduced in

(2). Substituting (15) into (13), $\mathcal{B}_{C_{0.6}R_L}^*(t)$ is available:

$$\mathcal{B}_{C_{0.6}R_L}^*(t) = \left[0.6 e^{-j\frac{\pi}{2}} + \left(\frac{R_L - Z_0}{R_L + Z_0} \right) \right] \sum_{k=1}^M s(t - \tau_k). \quad (16)$$

A comparison of $\mathcal{B}_{C_{0.6}R_L}(t)$ with $\mathcal{B}_{C_{0.6}R_L}^*(t)$ enables evaluating the accuracy of the amplitude and phase of the reflected wave. For convenience, we first normalize $\mathcal{B}_{C_{0.6}R_L}(t)$ and $\mathcal{B}_{C_{0.6}R_L}^*(t)$ through $\mathcal{B}_{opop}(t)$. Here, $\mathcal{B}_{opop}(t)$ represents the signal reflected by the PZT stack when both layers are in open-circuit status, i.e., $\mathcal{B}_{opop}(t) = \sum_{k=1}^M \left(B_1^{op} e^{j\phi_1^{op}} + B_2^{op} e^{j\phi_2^{op}} \right) s(t - \tau_k)$, which can be obtained experimentally as follows:

$$\mathcal{B}_{opop}(t) = \frac{r_{opop}(t) - r_{shsh}(t)}{2} = 2 \sum_{k=1}^M s(t - \tau_k). \quad (17)$$

According to the (16) and (17), the normalized $\mathcal{B}_{C_{0.6}R_L}^*(t)$ can be expressed as follows:

$$\frac{\mathcal{B}_{C_{0.6}R_L}^*(t)}{\mathcal{B}_{opop}(t)} = 0.3 e^{-j\frac{\pi}{2}} + \frac{R_L - Z_0}{2(R_L + Z_0)} \quad (18)$$

Finally, when the load status of the two layers are $C_{0.6}$ and R_L , the accuracy of the reflected signal generated by the multilayer reflector in a multipath environment can be estimated by the difference between $\mathcal{B}_{C_{0.6}R_L}^*(t)/\mathcal{B}_{opop}(t)$, calculated by (18), with $\mathcal{B}_{C_{0.6}R_L}(t)/\mathcal{B}_{opop}(t)$, obtained experimentally via (14). This methodology can be applied to analyze the amplitude and phase of the reflection signals for arbitrary load status in the multilayered acoustic reflector.

3) *Experimental results:* In Fig. 10, we present example waveforms collected during the tank experiment. These results are used to calculate the phase and amplitude of the reflected signals when loads of the two layers on the PZT stack are $C_{0.9}$ and R_{2k} , respectively.

As shown in Fig. 10(a), the beginnings and ends of the two reference waves exhibit significant fluctuations due to the multipath effect. Once all multipath signals have arrived at the receiver, the combined signal stabilizes between 15 ms and 45 ms. Additionally, it is evident from the figure that changing the load impedance of the reflector significantly affects the strength of the received signal.

Fig. 10(b) illustrates the waveform of $\mathcal{A}(t)$, which includes the direct wave and the multiple signals that do not interact with the reflector. As described in (12), $\mathcal{A}(t)$ is computed as half the sum of the two reference waves shown in Fig. 10(a). In Fig. 10(c), we display the waves reflected by the PZT stack under two different load conditions, where $\mathcal{B}_{C_{0.9}R_{2k}}(t)$ and $\mathcal{B}_{opop}(t)$ are obtained from the two reference waveforms through the expressions introduced in (14) and (17), respectively.

To demonstrate the difference between the two reflected signals, Fig. 10(d) provides a partially enlarged view of the area within the yellow dotted frame in Fig. 10(c). In this figure, let $\Delta\phi_{C_{0.9}R_{2k}}$ denote the phase difference between $\mathcal{B}_{opop}(t)$ and $\mathcal{B}_{C_{0.9}R_{2k}}(t)$. Experimental results indicate that the average $\Delta\phi_{C_{0.9}R_{2k}}$ measured is -37.9° and the amplitude ratio of $\mathcal{B}_{C_{0.9}R_{2k}}(t)$ and $\mathcal{B}_{opop}(t)$ is 0.51.

Figs. 11 and 12 show the phases and amplitudes of the normalized reflected waves generated by the PZT stack under

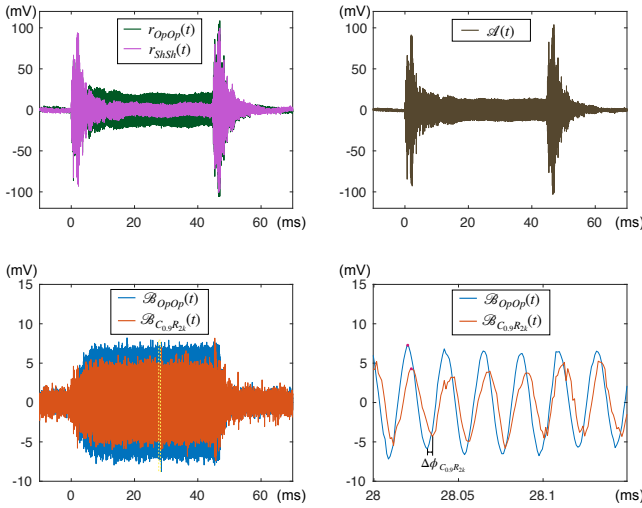

Figure 10: Waveforms collected in the tank test.

different load conditions. These figures include results from three tank tests. In each test, the position of the reflector was altered while maintaining other experimental settings constant to evaluate the consistency of the reflected signal. In both figures, the theoretical results are represented by a straight line, computed using the methods described in (18) with different load impedances at each layer, while the experimental values are obtained via the approach introduced in (14).

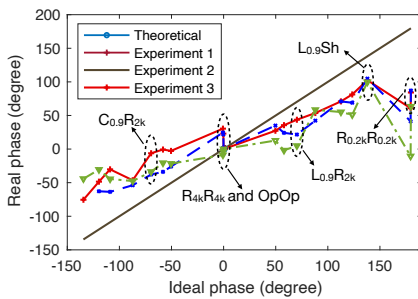

Figure 11: Phases of reflected waves measured in tank tests.

The experimental results demonstrate that the multilayered acoustic reflector successfully generates reflected waves with flexible amplitudes and phases, although the actual results deviate from the theoretical values to some extent. For instance, when loads of the first and second layers of the PZT stack are $C_{0.9}$ and $R_L = 2\text{ k}\Omega$, respectively (marked as $C_{0.9}R_{2k}$ in the figure), the theoretical value of the normalized reflected wave is given by

$$\frac{\mathcal{B}_{C_{0.9}R_{2k}}^*(t)}{\mathcal{B}_{OpOp}(t)} = 0.45 e^{-j\frac{\pi}{2}} + \frac{2000 - 1000}{2(2000 + 1000)}. \quad (19)$$

According to (19), the phase and amplitude of the normalized $\mathcal{B}_{C_{0.9}R_{2k}}^*$ are -69.7° and 0.48, respectively. However, as illustrated in Figs. 11 and 12, the average phase of reflected waves measured through three experiments is -25.9° , and the average amplitude is 0.56.

Moreover, when the loads of the two layers on the PZT stack are $L_{0.9}$ and short-circuit (marked as $L_{0.9}Sh$ in the figure), the theoretical phase and amplitude of the reflected wave are 138° and 0.67, respectively. By contrast, the average phase of

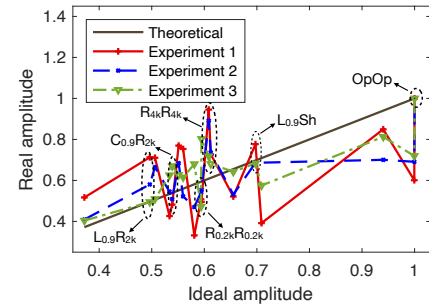

Figure 12: Normalized amplitudes of reflected waves measured in tank tests.

reflected waves obtained from the tank tests is 102.4° , and the average amplitude is 0.71.

From the tank test, it can be observed that both the amplitude and phase of the reflected wave deviate from their theoretical values, primarily due to three factors: (a) The complex acoustic environment in tank tests, particularly the multipath effect, and limited propagation distance. Multiple reflections by the reflectors cannot be neglected and lead to discrepancies between (11) and the actual received signal. (b) Theoretical calculations assume a constant characteristic impedance of $1\text{ k}\Omega$. However, the impedances of the matching circuit and the PZT disks vary with changes in the environment, causing deviations from the theoretical predictions. (c) Mechanical coupling effects, in which the vibration of one PZT disk influences another. This complex interaction was not accounted for in the model, thereby reducing the accuracy of the signal estimation.

B. Performance of ML-ARIS

1) *Simulation settings:* The simulation is conducted on the COMSOL multiphysics simulator. The reflector comprises 4 PZT-4 layers; only the first two layers are used for IQ modulation, while the remaining two remain in an open-circuit condition. Each PZT disk measures $\phi 60\text{ mm} \times 4\text{ mm}$. A monochromatic plane wave with a sound pressure of 1 Pa at 41.1 kHz serves as the signal source. Both the reflector and the water medium are surrounded by a perfect matching layer (PML) to mitigate multipath effects.

To enhance the accuracy, the simulation is structured into the following five steps:

- a) Measure the ratio of open-circuit voltage to short-circuit current for each PZT disk under monochromatic plane waves to determine its impedance.
- b) Based on the impedance values obtained in step (a), construct the matching circuit.
- c) Add a load behind the matching circuit and then measure the load voltage under the monochromatic plane wave.
- d) Using the load voltage measured in step (c) and the reflection coefficient of the target load at each layer of the PZT stack, calculate the reflected voltage.
- e) Deactivate the monochromatic plane waves and apply the reflected voltage obtained in step (c) to each PZT layer's matching circuit. Record the resulting pressure waveform, which represents the signal reflected by the reflector under the specified load conditions.

2) *Simulation results of single reflector*: Figs. 13 and 14 display the phases and amplitudes of the normalized reflected waves obtained from the simulation under various load conditions, respectively. Three measurement probes scattered in the tank are deployed to capture the reflected signal.

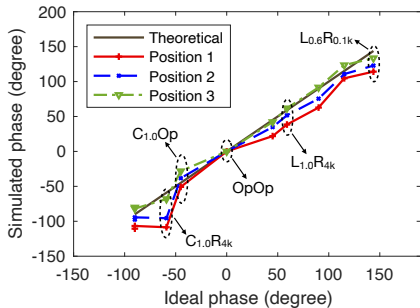

Figure 13: Phases of reflected waves measured in simulations.

A comparison of Figs. 13 and 14 with Figs. 11 and 12 shows that both the phase and amplitude measured in the simulation correspond more closely with the theoretical results than those from the tank experiments. This improved accuracy is attributed to the use of PML that minimizes multipath effects, thus approximating an anechoic pool environment. Additionally, the five steps in the simulation effectively isolate the incident waves from the reflected waves, eliminating interference from direct waves on the received signal.

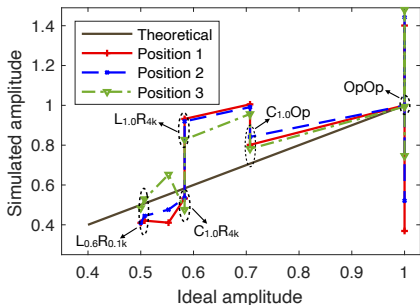

Figure 14: Normalized amplitudes of reflected waves measured in simulations.

3) *Simulation results of reflector array*: Fig. 15 depicts the reflected beams generated by an ML-ARIS comprising 8 reflectors under a monochromatic plane wave. The simulation configures the spacing between adjacent reflectors to be 2λ , where $\lambda=3.65$ cm corresponds to the wavelength of the plane wave at 41.1 kHz. We placed a total of 72 virtual probes, marked as red squares, evenly around a circle to measure the pressure of the reflected wave, with each probe 75 cm from the center of the ML-ARIS. The incident monochromatic plane wave is eliminated in the figure through the five-step simulation process previously described.

In the simulation, the ML-ARIS is configured to generate directional gain at 45° in the water through the IQ modulation. The optional status of the load network is the same as the circuit used in the tank experiments. As shown in the figure, the reflected beam exhibits significant directivity in the direction around 35° . In addition, a grating lobe near 155° can be observed as the distance between reflectors in ML-ARIS exceeds one wavelength.

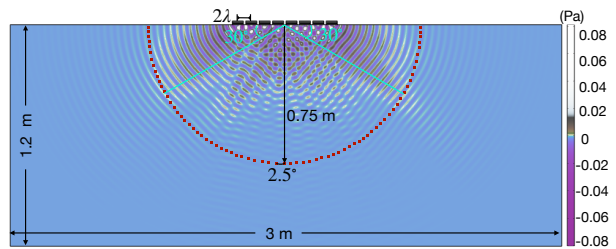

Figure 15: Reflected beams from an ML-ARIS of 8 reflectors.

Note that the absolute pressure of the reflected wave shown in Fig. 15 is small because only a small fraction of the acoustic energy propagates into the PZT due to the acoustic impedance mismatch between the water and the reflector's head mass. In practical applications, this issue can be addressed by incorporating multiple matching layers between the head mass and the water as those used in medical [26] or sonar imaging [27] to reduce the significant reflection at the bare boundary.

In the simulation, the ML-ARIS is programmed to generate directional gain at 45° in water using IQ modulation, with the load network configuration detailed in Table I. As shown in the figure, the reflected beam exhibits pronounced directivity near 30° , representing a 15° deviation from the preset value. This discrepancy occurs because the probe lies within the near field,¹ preventing the ML-ARIS from being approximated as a point source of negligible volume and the signals generated by each acoustic reflector must be treated as spherical waves rather than plane waves. Furthermore, a grating lobe emerges at approximately 155° , resulting from the reflector spacing exceeding one wavelength.

Table I: Load configurations for different coding schemes.

		R1	R2	R3	R4	R5	R6	R7	R8
IQ	L1	Op	800Ω	2.8kΩ	1.1k	280Ω	19.4Ω	Sh	9.4k
	L2	1k	L06	C10	L10	C10	L03	1k	C06
1-bit	L1	Sh	Sh	Op	Sh	Op	Sh	Sh	Op
2-bit	L1	Op	Sh	C10	L10	C10	Op	Sh	C10

It is important to note that the absolute pressure of the reflected wave, as shown in Fig. 15, is low because only a small portion of the acoustic energy penetrates the PZT, primarily due to the acoustic impedance mismatch between the water and the reflector's head mass. In practical applications, this challenge can be mitigated by incorporating multiple matching layers between the head mass and the water, similar to those employed in medical [26] or sonar imaging [27], to significantly reduce the reflection at the bare boundary.

In Fig. 16, we compare the reflected beams generated by the ML-ARIS under various coding schemes. The configuration is identical to that in Fig. 15, and the beam amplitude is normalized to the maximum pressure collected by the probes. Each coding scheme is designed to produce a main lobe at 45° , with the corresponding load configurations provided in Table I. For the 1-bit and 2-bit coding schemes, orthogonal synthesis of the reflected signals is not required; hence, only the first layer of the PZT stack is connected to the load network, while the remaining layers are left open-circuited.

¹ $L = 2D^2/\lambda$, where L denotes the boundary between the near field and far field, and D is the dimension of the ML-ARIS.

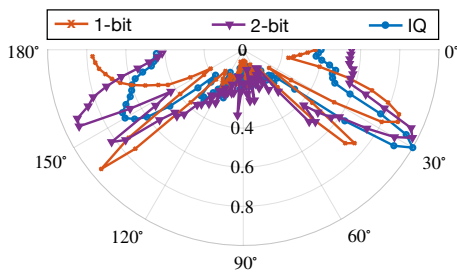

Figure 16: Comparison of reflected beam generated by different coding methods.

From Fig. 16, it can be observed that due to near-field effects, the main lobes of all three beams are deflected to 30° , yielding a 15° deviation from the theoretical expectation. Moreover, the side lobe of reflected beam with IQ modulation is substantially lower than that of the 1-bit and 2-bit coding schemes. For example, the normalized amplitude of the first side lobe under IQ modulation is only 0.26 at 47.5° , compared with 0.52 at 45° for 2-bit coding and 0.74 at 40° for 1-bit coding. Furthermore, the sound pressure of the main lobe under IQ modulation remains strong, with normalized amplitudes of 1 compared to 0.97, and 0.86 for 1-bit, and 2-bit coding schemes, respectively.

VII. CONCLUSION

In this paper, a multilayered reconfigurable intelligent surfaces is proposed for underwater acoustic networks. The stacked architecture enables each individual reflector to generate a reflected wave with flexible amplitude and phase via IQ modulation. Compared with the multi-bit coding RIS commonly employed in terrestrial communications, the proposed ML-ARIS achieves higher-precision beam steering while minimizing interference to the surrounding environment. To ensure efficient operation in complex ocean settings, an enhanced matching network is also developed to maintain a stable output impedance under varying water temperatures and RIS deployment depths.

The performance of the enhanced matching circuit and the multilayered acoustic reflector is evaluated through both tank experiments and COMSOL simulations around 28 kHz and 41 kHz. The results verify the effectiveness of the ML-ARIS in manipulating the phase and amplitude of the reflected wave to support advanced array processing algorithms. This capability positions ML-ARIS as a promising technology to improve the communication range and data rate for future underwater acoustic networks.

REFERENCES

- [1] M. Ahmed, S. Raza, A. A. Soofi, F. Khan, W. U. Khan, S. Z. U. Abideen, F. Xu, and Z. Han, "Active reconfigurable intelligent surfaces: expanding the frontiers of wireless communication-a survey," *IEEE Communications Surveys & Tutorials*, 2024.
- [2] H. Yang, S. Kim, H. Kim, S. Bang, Y. Kim, S. Kim, K. Park, D. Kwon, and J. Oh, "Beyond limitations of 5G with RIS: field trial in a commercial network, recent advances, and future directions," *IEEE Communications Magazine*, 2023.
- [3] Q. Wu, B. Zheng, C. You, L. Zhu, K. Shen, X. Shao, W. Mei, B. Di, H. Zhang, E. Basar *et al.*, "Intelligent surfaces empowered wireless network: recent advances and the road to 6G," *Proceedings of the IEEE*, 2024.
- [4] A. Shaw, A. Al-Shamma'a, S. Wylie, and D. Toal, "Experimental investigations of electromagnetic wave propagation in seawater," in *European Microwave Conference*. IEEE, 2006, pp. 572–575.
- [5] Z. Sun, H. Guo, and I. F. Akyildiz, "High-data-rate long-range underwater communications via acoustic reconfigurable intelligent surfaces," *IEEE Communications Magazine*, vol. 60, no. 10, pp. 96–102, 2022.
- [6] H. Wang, Z. Sun, H. Guo, P. Wang, and I. F. Akyildiz, "Designing acoustic reconfigurable intelligent surface for underwater communications," *IEEE Transactions on Wireless Communications*, 2023.
- [7] Y. Luo, L. Pu, and A. Song, "Experimental study of underwater acoustic reconfigurable intelligent surfaces with in-phase and quadrature modulation," *arXiv*, no. arXiv:2411.12906, 2024.
- [8] J. Kim, J. Kim, J. H. Oh, S.-H. Wi, and J. Oh, "Rotated feed-combined reconfigurable transmit RIS with disparate deployment of 1-bit hybrid units for B5G/6G," *IEEE Transactions on Antennas and Propagation*, vol. 71, no. 6, pp. 5457–5462, 2023.
- [9] L. Zhang, Z. X. Wang, R. W. Shao, J. L. Shen, X. Q. Chen, X. Wan, Q. Cheng, and T. J. Cui, "Dynamically realizing arbitrary multi-bit programmable phases using a 2-bit time-domain coding metasurface," *IEEE Transactions on Antennas and Propagation*, vol. 68, no. 4, pp. 2984–2992, 2019.
- [10] W. Tang, M. Z. Chen, X. Chen, J. Y. Dai, Y. Han, M. Di Renzo, Y. Zeng, S. Jin, Q. Cheng, and T. J. Cui, "Wireless communications with reconfigurable intelligent surface: path loss modeling and experimental measurement," *IEEE transactions on wireless communications*, vol. 20, no. 1, pp. 421–439, 2020.
- [11] C. Huang, A. Zappone, G. C. Alexandropoulos, M. Debbah, and C. Yuen, "Reconfigurable intelligent surfaces for energy efficiency in wireless communication," *IEEE transactions on wireless communications*, vol. 18, no. 8, pp. 4157–4170, 2019.
- [12] Y. Ren, R. Zhou, X. Teng, S. Meng, M. Zhou, W. Tang, X. Li, C. Li, and S. Jin, "On deployment position of ris in wireless communication systems: Analysis and experimental results," *IEEE Wireless Communications Letters*, 2023.
- [13] M. Jian, G. C. Alexandropoulos, E. Basar, C. Huang, R. Liu, Y. Liu, and C. Yuen, "Reconfigurable intelligent surfaces for wireless communications: overview of hardware designs, channel models, and estimation techniques," *Intelligent and Converged Networks*, vol. 3, no. 1, pp. 1–32, 2022.
- [14] L. Boccia, F. Venneri, G. Amendola, and G. Di Massa, "Application of varactor diodes for reflectarray phase control," in *IEEE Antennas and Propagation Society International Symposium*, vol. 3. IEEE, 2002, p. 132.
- [15] X. Tan, Z. Sun, J. M. Jornet, and D. Pados, "Increasing indoor spectrum sharing capacity using smart reflect-array," in *2016 IEEE International Conference on Communications (ICC)*. IEEE, 2016, pp. 1–6.
- [16] X. Pei, H. Yin, L. Tan, L. Cao, Z. Li, K. Wang, K. Zhang, and E. Bjornson, "Ris-aided wireless communications: prototyping, adaptive beamforming, and indoor/outdoor field trials," *IEEE Transactions on Communications*, vol. 69, no. 12, pp. 8627–8640, 2021.
- [17] A. Eid, J. Rademacher, W. Akbar, P. Wang, A. Allam, and F. Adib, "Enabling long-range underwater backscatter via Van Atta acoustic networks," in *Proceedings of the ACM SIGCOMM Conference*. ACM, 2023, pp. 1–19.
- [18] Y. Luo, L. Pu, M. Zuba, Z. Peng, and J.-H. Cui, "Challenges and opportunities of underwater cognitive acoustic networks," *IEEE Transactions on Emerging Topics in Computing*, vol. 2, no. 2, pp. 198–211, 2014.
- [19] H. L. Van Trees, *Optimum array processing: part IV of detection, estimation, and modulation theory*. John Wiley & Sons, 2002.
- [20] S. Abeywickrama, R. Zhang, Q. Wu, and C. Yuen, "Intelligent reflecting surface: practical phase shift model and beamforming optimization," *IEEE Transactions on Communications*, vol. 68, no. 9, pp. 5849–5863, 2020.
- [21] NTE Electronics Inc., *NTE618 varactor silicon tuning diode for AM radio*, NTE Electronics Inc., Bloomfield, NJ, USA, March 2012.
- [22] ZETEX Semiconductors, *830 series silicon 25V hyperabrupt varactor diodes*, ZETEX Semiconductors, Zetex Technology Park, Chadderton Oldham, UK, January 2007.
- [23] X. Lurton, *An introduction to underwater acoustics: principles and applications*. Springer Science & Business Media, 2002.
- [24] P. J. Van Laarhoven, E. H. Aarts, P. J. van Laarhoven, and E. H. Aarts, *Simulated annealing*. Springer, 1987.
- [25] B. Acoustics, "BT-2RCL acoustic transducer," BTech Acoustics LLC, 2024, [Accessed: September, 2024]. [Online]. Available: <https://www.btechacoustics.com/products/bt-2rcl>
- [26] J. F. Dias and M. S. Seyed-Bolorforosh, "Method for making integrated matching layer for ultrasonic transducers," Apr. 1996, US Patent 5,511,296.
- [27] J. Bian, Y. Wang, Z. Liu, M. Shen, H. Zhao, Y. Sun, and J. Zhu, "Ultra-wideband underwater acoustic transducer with a gradient impedance matching layer," *Applied Acoustics*, vol. 175, p. 107789, 2021.