

Cruise Control: Dynamic Model Selection for ML-Based Network Traffic Analysis

Johann Hugon

École Normale Supérieure de Lyon

Anthony Busson

Université Lyon 1

Paul Schmitt

University of Hawaii, Manoa

Francesco Bronzino

École Normale Supérieure de Lyon

ABSTRACT

Modern networks increasingly rely on machine learning models for real-time insights, including traffic classification, application quality of experience inference, and intrusion detection. However, existing approaches prioritize prediction accuracy without considering deployment constraints or the dynamism of network traffic, leading to potentially suboptimal performance. Because of this, deploying ML models in real-world networks with tight performance constraints remains an open challenge.

In contrast with existing work that aims to select an optimal candidate model for each task based on offline information, we propose an online, system-driven approach to dynamically select the best ML model for network traffic analysis. To this end, we present *Cruise Control*, a system that pre-trains several models for a given task with different accuracy-cost tradeoffs and selects the most appropriate model based on lightweight signals representing the system’s current traffic processing ability. Experimental results using two real-world traffic analysis tasks demonstrate *Cruise Control*’s effectiveness in adapting to changing network conditions. Our evaluation shows that *Cruise Control* improves median accuracy by 2.78% while reducing packet loss by a factor of four compared to offline-selected models.

1 INTRODUCTION

Machine learning (ML) is rapidly becoming an indispensable tool for network traffic analysis tasks, demonstrating superior accuracy and robustness compared to traditional heuristic-based methods [7, 28, 37], as ML models excel at discovering complex relationships between network traffic and critical events occurring across different network layers. Consequently, the networking community has increasingly developed sophisticated ML models to assist with essential tasks such as traffic classification [6, 19, 30, 31, 34], Quality of Experience (QoE) inference [9, 23, 24, 35], intrusion detection [4, 20, 21], and numerous other critical network analysis functions [7, 28, 37]. However, the effective deployment of ML models in real-world operational networks presents considerable challenges due to fundamental differences between training environments and operational networks.

Existing ML models designed for networking applications primarily concentrate on traffic classification tasks, aiming to categorize network flows into well-defined categories. For example, in the context of video quality inference, a model can be trained to categorize flows according to video stream quality metrics, *e.g.*, video resolution or startup delay [9, 23, 24, 35]. The development of these models typically follows a two-phase approach, predominantly conducted offline. Initially, labeled data is collected from a controlled setting. The labeled data are subsequently used to train and evaluate various models based on their predictive performance. Historically, the primary goal of such evaluation has focused on selecting models that maximize prediction metrics—such as accuracy or F1 score—often without adequately considering the practical environment where the models will be deployed. Unfortunately, real-world model deployment demands a more comprehensive approach that involves considerations extending beyond the model alone. Ultimately, production settings introduce constraints and timescales that only loosely relate to a single inference outcome.

To overcome this limitation, recent work has focused on strategies to extend ML model evaluation beyond accuracy to also consider system constraints such as latency [39], CPU [8], and memory [19]. However, these solutions focus on the static deployment of a single model, selected *a priori*, during runtime. This approach has inherent limitations, as the evaluation of system constraints and model accuracy frequently occur in isolation, creating a critical disconnect that fails to capture the intricate interdependence between model performance and system characteristics. What appears to be an optimal model in a controlled, static environment may quickly become ineffective when deployed in real-world networks. Moreover, the contextual specificity of network systems means that a high-performing model in one environment cannot be universally applied. Each network environment presents unique characteristics—varying topologies, traffic profiles, bandwidth constraints, and operational conditions—that render a one-size-fits-all approach ineffective. Consequently, evaluations that do not account for these nuanced, instance-specific variables provide a misleading representation of a model’s true potential, ultimately compromising the

reliability and adaptability of machine learning solutions in networking environments.

This paper seeks to overcome these limitations by proposing a paradigm shift: in contrast with previous work that has aimed to develop new strategies to design an optimal candidate model based on offline information, we argue in favor of an online, system-driven approach to dynamically select the best model from a pool of candidates. Our approach is motivated by the observation that a deployed ML system has access to the most accurate information about its current capabilities and the traffic it is processing. Of course, shifting to such approach requires tackling new challenges. First, our system must be able to select from a pool of models that present different accuracy-cost tradeoffs. To do so the system must be able to pre-train a pool of models with varying feature sets and evaluate their performance under different network conditions. Second, the system must be able to dynamically adapt to changing network conditions, ensuring that the selected model remains optimal under varying traffic loads. The goal is to maximize both model accuracy and system efficiency, ensuring that the system can effectively characterize traffic as network conditions evolve.

To address these challenges, we present `Cruise Control`, a system design that enables the dynamic selection of the most appropriate ML model for network traffic analysis for evolving network conditions. In particular, we make the following contributions:

- (1) **System design (Section 3):** Building on previous work [39], `Cruise Control` pre-trains offline a set of Pareto-front-optimal models with different accuracy-cost tradeoffs. Online, `Cruise Control` monitors lightweight signals (*i.e.*, packet loss) to evaluate its current ability to process traffic and dynamically selects the most appropriate model based on the system’s current capabilities and the observed traffic. This approach allows the system to adapt to changing network conditions, ensuring that the selected model remains optimal under varying traffic loads.
- (2) **Implementation and evaluation (Section 4):** We implement `Cruise Control` and evaluate its performance for two real world traffic analysis tasks: video quality inference and traffic classification. Our results show that `Cruise Control` effectively adapts to changing network conditions, selecting the most appropriate model for the observed traffic and system capabilities. Compared to existing approaches that aim to select an optimal candidate model for each task based on offline information, `Cruise Control` reduces packet loss by a factor of 4 while maintaining equivalent or better median accuracy.

We believe our approach to dynamic model selection paves the way for promising exploration in the path to widespread adoption of machine learning solutions for network traffic analysis. To stimulate further research and innovation in this direction, we release the source code for `Cruise Control`¹ to the community, encouraging others to build upon our initial proposal.

2 CONTEXT AND MOTIVATION

In this section we discuss current approaches to deploying ML models in network monitoring and identify challenges that they currently face when deployed on operational networks.

2.1 ML-Based Traffic Analysis

Internet Service Providers (ISPs) must be able to accurately characterize traffic that they serve in order to ensure that their users receive the best possible service. However, this task is becoming increasingly difficult due to multiple factors, including traffic volume (*i.e.*, relentlessly increasing network speeds) and opacity (*i.e.*, widespread adoption of encryption). As such, conventional monitoring approaches are becoming inadequate [43] as they struggle to cope with modern Internet traffic characteristics. To address these challenges, network operators and researchers have turned to ML-based solutions [3, 7, 36], which have been successfully applied to various network monitoring tasks, from traffic classification to quality of service inference [26]. For example, while encryption makes direct measurement of application layer performance such as video streaming quality metrics impossible, ML models are able to accurately infer these metrics from encrypted network flows, providing crucial insights into user experience [9, 17, 23, 25, 27].

The typical ML-based traffic analysis pipeline follows a structured approach: First, raw network traffic is captured and undergoes preliminary processing, including operations such as header parsing, flow tracking, and data reassembly. The second stage focuses on feature extraction, where statistical computations and information encoding prepare the data for model input. Finally, the processed features are fed into an ML model to perform the target inference task. Traditionally, ML pipeline performance is evaluated during training, with the goal of generating a model with the highest accuracy (*e.g.*, F1 score). However, a significant gap exists between the creation of models and their deployment in operational network environments as the conventional approach overlooks crucial real-world complexities that are absent in the training pipeline.

ML deployments must operate in real-time and thus are subject to systems-related constraints such as the ability to extract packets from the network, compute features, and make

¹The source code will be made available upon paper acceptance.

inferences at line rates. Recent work [8, 19, 39] has highlighted that the choice of which features to compute—potentially even more than the selection of the model itself—can significantly affect a measurement system’s ability to gather the necessary information for effective model execution. Complicating things further, the dynamic nature of network traffic means that load can vary significantly over time, making it difficult to predict the computational demands of an ML pipeline at any given time or deployment location. The outcome of these factors is that models that perform well in offline training and testing environments may become unusable (*e.g.*, due to packet loss when the pipeline cannot process traffic quickly enough) in real-world deployments. A naïve solution to this problem is to simply create and deploy models using features with low computational complexity, allowing for processing overhead. However, this approach can impose an unnecessary ceiling on model accuracy [8] (*e.g.*, a model with higher accuracy could be deployed when there is less traffic, and a model with lower accuracy when there is more). Thus, there is an opportunity for a new approach that holistically considers model accuracy as well as system performance in inherently dynamic network environments.

2.2 The Need for Dynamic Adaptation

To illustrate the intrinsic relationship between traffic dynamics on model accuracy, we perform a small experiment using a typical ML-based traffic analysis task: video resolution inference from encrypted traffic [9, 23, 24, 35]. We base our experiment on models developed in previous work by Bronzino *et al.* [9], where the authors evaluate several feature sets and models to infer video quality. These feature sets map to different layers of the network stack including: *Network*: basic network flow features (*e.g.*, throughput in/out, packet counts in/out), *Transport*: end-to-end latency and packet retransmission information (*e.g.*, RTT, retransmission in/out), and *All*: combined features from network, transport, and application layers (*e.g.*, video segment sizes, time between video segments). These different feature sets result in three models with varying accuracy for the same task.

We evaluate the ability of an ML-based measurement system to process traffic for these three models. As in the rest of the paper, we measure the ability of an ML system to support a given model by analyzing whether the system can successfully compute the features necessary for the model execution, *i.e.*, the feature set, without packet loss. For this experiment, we implement the different feature sets using Retina [38], a state-of-the-art feature extraction system. Retina enables users to efficiently compute features for subsets of parsed flows. However, changing the feature set in Retina requires a full system reboot, a process that can take several seconds. We

deploy the system on a server equipped with a 100 Gbps network interface and evaluate its performance using real-world traffic traces. Specifically, we use three 10-minute traces derived from a one-hour trace collected at Equinix Chicago [12]. These traces are scaled to represent different traffic regimes throughout a typical day, using ratios inspired by Feldmann *et al.* [16]. We use Cisco’s TRex [2] to adjust the traces to reflect night ($\times 0.2$), noon ($\times 1.0$), and evening ($\times 1.6$) traffic volumes by scaling the number of packets and flows in the original trace. Additional details about the testbed setup are provided in Section 4.

Figure 1 shows the throughput for the three periods of the day. Each point represents the amount of packets processed per second by the system. The achieved throughputs when extracting the feature sets are represented by blue circles, orange squares, and green triangles respectively, while the black line represents the load. The number of dropped packets is inferred from the difference between the input traffic and throughput. The accuracy of each model is indicated in the legend. Figure 1a shows that the throughputs align with the input traffic load, indicating successful processing without packet loss for all feature sets. Figure 1b shows that the *All* feature set results in loss, while the other two are able to process traffic without loss. Figure 1c shows that the system can process traffic without loss only for the *Network* feature set, the set that is least computationally expensive (and least accurate).

Certainly, packet loss due to system saturation will affect ML model accuracy unpredictably and should, thus, be minimized. In systems designed to serve a single model during runtime, the *Network* feature set should be selected as it is the only one for which the system can process traffic without loss. This disqualifies the model using the *Transport* feature set, which is more accurate and would be deployable for two-thirds of the day without loss, and the model using the *All* feature set that could be deployed at night. In this context, the capacity of the system that processes traffic becomes a key element to ensure the accuracy of the ML models. This experiment shows inefficiencies in model accuracy and system performance due to static model selection and the need to avoid packet losses. To achieve efficiency gains in model accuracy and system performance, dynamic system adaptation to network load is required.

3 CRUISE CONTROL

In this section, we present Cruise Control, a proof-of-concept system designed for network traffic analysis tasks using machine learning. Offline, Cruise Control builds a pool of Pareto-optimal models with different accuracy-cost trade-offs. Online, Cruise Control monitors lightweight signals to evaluate its current ability to process traffic and dynamically

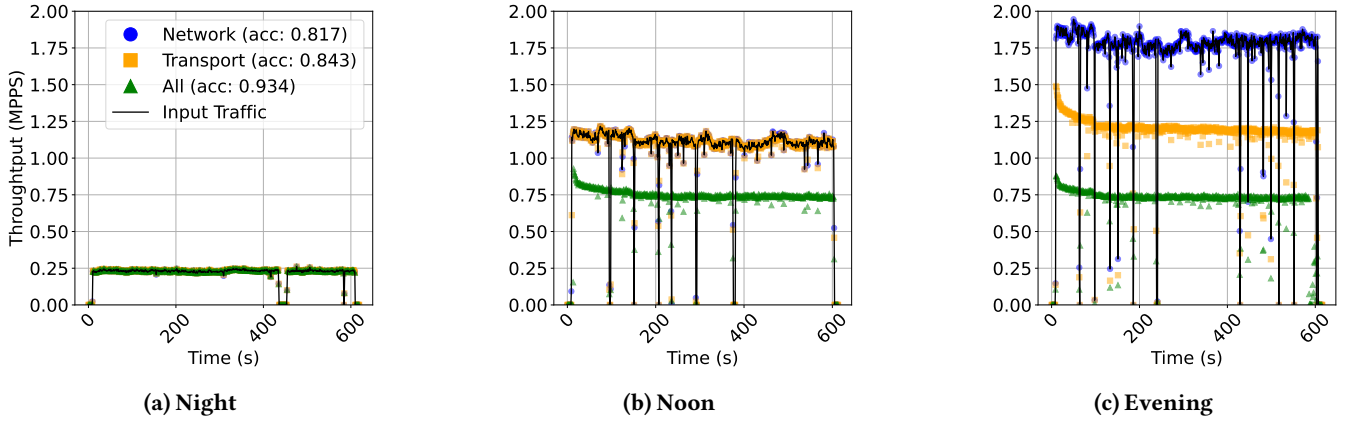

Figure 1: Comparison of the impact of three different video quality inference models across different times of day.

selects the most accurate model (*i.e.*, the feature sets to compute) based on the system’s current processing capabilities and the observed traffic. We begin this section by presenting the overall design goals of Cruise Control. We then describe the details of Cruise Control’s architecture, including the offline feature profiling and the adaptive processing pipeline.

3.1 Design Goals

The core objective for Cruise Control is to support the deployment of multiple model alternatives for any given task, dynamically selecting the optimal model at any point in time to maximize accuracy while minimizing packet loss. Guided by these overarching principles, we define the following design goals for the system:

Design Goal 1: Coarse yet Effective Representation of Feature Costs. Enabling the deployment of a diverse set of models for traffic analysis requires a robust understanding of relationships between the costs of collecting model features, the model’s accuracy, and the system’s capacity to support such collection under varying network conditions. However, selecting an optimal model without prior knowledge of its deployment environment is challenging, as numerous factors can affect a system’s ability to process captured traffic. Further, reliance on offline data can result in suboptimal performance. To address these challenges, our goal is to design a system that minimizes the amount of information required to characterize the cost of a given model, while still offering an effective representation of the trade-offs between model accuracy and system capacity. Cruise Control achieves this goal by constructing a pool of models that are Pareto-optimal across two key dimensions: (a) the CPU cycles required for per-feature cost computation, and (b) the model accuracy for

a given set of features. The methodology for building this pool of models offline is detailed in Section 3.2.

Design Goal 2: Lightweight Monitoring to Inform Model Selection. Selecting the best model under varying network conditions requires accurate information about the system’s current state and its interaction with the surrounding environment. However, monitoring or profiling these conditions can introduce additional overhead, potentially degrading system performance and causing packet loss. Despite these challenges, the monitored data must still provide sufficient detail to enable the system to make informed and timely decisions. Therefore, our goal is to achieve an optimal balance between information granularity, incurred overhead, and the level of detail necessary for characterizing current system performance. To achieve this goal, Cruise Control relies exclusively on lightweight signals, such as packet loss, as inputs to its model selection algorithm. The details of the proposed algorithm are presented in Section 3.3.

Design Goal 3: Rapid and Efficient Model Switching. Dynamically changing between models requires a system able to adapt its configuration on-the-fly. However, existing state-of-the-art systems (*e.g.*, Retina [38]) only support static configurations and require a system restart to substitute the features to collect. Moreover, cold booting these systems often requires several seconds, during which they fail to keep up with traffic demands, leading to packet loss and, consequently, decreased accuracy. Our goal is to design a system capable of near-instantaneous adaptation, allowing it to seamlessly adjust to evolving conditions while maintaining high performance and minimal disruption. Cruise Control implements an efficient packet processing pipeline that exploits state-of-the-art components and data structures to efficiently switch between computed feature sets and export them for model consumption. Section 3.4 presents the packet pipeline.

3.2 Offline Feature Profiling

The offline phase of `Cruise Control` is responsible for building a pool of models where each model is characterized both in terms of its accuracy and the costs related to computing its features. This allows us to construct a Pareto front for the pool that represents models with the most efficient trade-offs between accuracy and cost. By narrowing the set of candidate models to only those that are Pareto-optimal, we reduce the number of models to consider during the online phase. The Pareto front also naturally provides a sorted ranking of the models based on their accuracy and cost, which is used to define possible steps (*i.e.*, the possible models to switch to from the current one) in the online process.

Methodology. To derive the pool of candidate models, we build on the work first presented by Wan *et al.* [39]. We begin from a list of all possible unitary features that are used as input for potential target models. For each feature we estimate the number of CPU cycles² required to extract each of them. CPU cycles are an easy metric to compute that can be easily obtained through modern software architectures. For example, to estimate CPU costs, we can use the DPDK[1] function `rte_rdtsc()`, which returns the value of the TSC register. This register counts the number of CPU cycles since its last reset. By comparing the TSC register value before and after feature extraction, we can accurately determine the CPU cycles required for each feature set with high precision. Additionally, the CPU cost of computing the aggregate feature set for a model can be estimated by summing its component features. While this provides a rough estimate of the cost of collecting all features required by a model, it provides a simple yet effective strategy to rank models based on their cost. For each feature set, we then associate its corresponding model accuracy. As the feature sets relevant to our solution must form an increasing accuracy-complexity sequence, we retain those that form the Pareto front. This leads to a significantly smaller number of feature sets ranging from the least costly / least accurate to the most costly / most accurate.

Example. As an example, we again consider the video quality inference task previously studied in Section 2.2. We define 10 unitary features across the three feature sets presented by Bronzino *et al.* [9]. Note that while the list of features in the original paper is larger than ours, we aggregate features that use the same information to be computed (*e.g.*, different statistical representations of the same feature). We experimentally evaluate the CPU cost for the 1023 possible feature combinations. For each combination, we calculate the median CPU cycle cost of the measurements. In addition, we train and evaluate models for each feature set to obtain their accuracy

²CPU cost is used as an example metric for assigning cost to a feature. Other potential systems-related costs, such as memory, are not considered in this work.

values. Each feature set can then be represented as a (cost, accuracy) tuple as shown in Figure 2. In this figure, configurations closer to the top left corner are preferable as they represent higher accuracy with lower CPU cost. The number of features present in each feature set is denoted by color. We compute the Pareto front to identify the most relevant feature sets, as shown by the highlighted diamonds. We then filter out five configurations with very small accuracy gains (less than 0.001) to avoid unnecessary overhead for little benefit at runtime. This methodology allows us to reduce the number of possible feature sets from 1023 to only nine. We list the obtained feature sets in Table 1. These feature sets are labeled as mX , where X represents the index of the feature set ordered by accuracy, with $m1$ being the least accurate (and least computationally expensive) feature set.

3.3 Dynamic Model Selection

The online phase of `Cruise Control` consists of two key components, illustrated in Figure 3: the *Model Selection* module and the *Feature Computation* module. The Model Selection module gathers metrics to monitor system performance and determines the set of features to be collected for the target model. The Feature Computation module handles packet processing, connection reassembly, feature extraction, and the computation of statistical features required for ML model execution. Section 3.4 provides a detailed description of the Feature Computation module, while the remainder of this section focuses on the Model Selection module.

The Model Selection module takes the pool of feature sets derived during the offline phase and determines which model to use based on the ongoing load experienced by the system. Unfortunately, many challenges lie behind this task. First, monitoring the system’s state cannot rely on heavy profiling that might itself cause increased system load and lead to packet loss. Second, the system must implement an intelligent algorithm capable of both detecting whether the system is overloaded, thus triggering selection of a more lightweight feature set, as well as whether the system has resources to spare, thus triggering a switch to a more complex feature set. We solve the first challenge by solely relying on a lightweight signal, *i.e.*, packet loss, to monitor the system’s state. This task is done by a dedicated Monitor that serves as the primary component of the Model Selection and tracks the state of the `rx_queues` used to receive packets from the NIC. In particular, we monitor the `rx_miss` counter, which counts the number of packets dropped by the hardware due to the queues being full.

We tackle the second challenge by designing an algorithm that leverages detected losses—or their absence—to determine whether to switch between models. Analogous to congestion control mechanisms used in TCP algorithms, `Cruise`

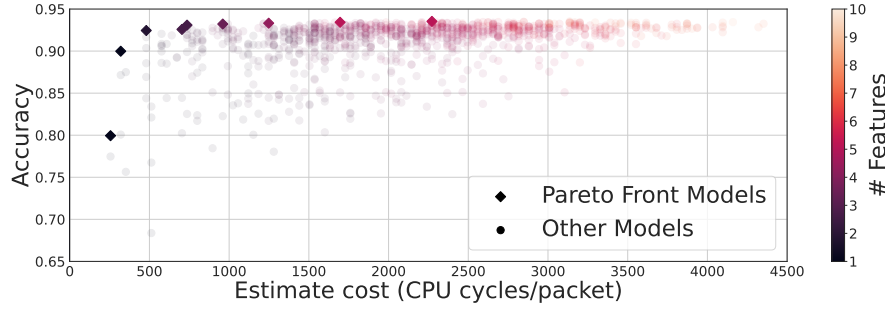
Figure 2: Streaming video quality model Pareto front.

Model #	Cost	Accuracy
<i>m9</i>	2272	0.935
<i>m8</i>	1696	0.934
<i>m7</i>	1248	0.933
<i>m6</i>	960	0.932
<i>m5</i>	736	0.931
<i>m4</i>	704	0.926
<i>m3</i>	480	0.924
<i>m2</i>	320	0.900
<i>m1</i>	256	0.799

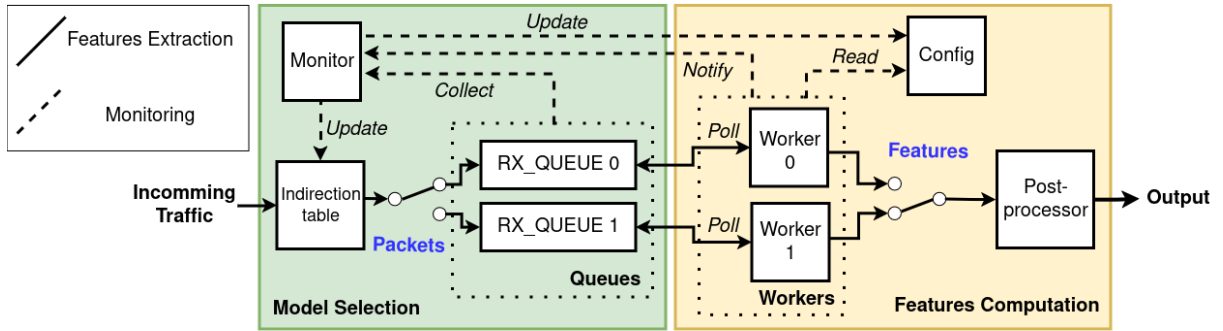
Table 1: Ranked models.

Figure 3: Cruise Control system overview. We show a simplified representation of the architecture with only one worker and one backup worker. More details on multi-core support are discussed in Section 4.

Control rapidly downgrades to a simpler model when a loss is detected and cautiously explores more complex models when no losses occur. A detailed description of the algorithm follows.

Methodology. We propose the algorithm outlined in Algorithm 1 to select a feature set based on the system’s state. It is important to note that Cruise Control is not tied to this specific algorithm, and alternatives could be employed. The candidate feature sets to compute are indexed in increasing order of complexity, with the currently selected set represented by the variable m_i . To prevent system saturation, the algorithm continuously monitors for packet drops (line 7). When loss is detected, m_i is adjusted using a multiplicative decrease (dec_factor), selecting a feature set with lower CPU cost. Conversely, the algorithm periodically increases m_i to explore more complex feature sets, doing so every mon_window seconds (line 10). This approach is inspired by the Additive Increase Multiplicative Decrease (AIMD) mechanism [13] implemented in TCP congestion control algorithms, wherein complexity is incrementally increased until the system reaches capacity, while significant reductions are applied in response to packet drops. While AIMD may not be required for single-task systems, we envision that it may be required to ensure convergence towards resource fairness for systems that deploy

multiple models simultaneously. We leave this exploration for future work.

Algorithm 1 Feature set selection algorithm

- 1: **mon_window**: Time window for monitoring metrics
 - 2: m_i : Index of the current candidate features set
 - 3: n_drops : Dropped packets since the last cycle
 - 4: dec_factor : Decrease factor used when a drop occurs
 - 5:
 - 6: **loop**
 - 7: **if** $n_drops > 0$ **then**
 - 8: $m_i \leftarrow \lceil m_i * dec_factor \rceil$
 - 9: **else**
 - 10: **if** $t_since_last_update \geq mon_window$ **then**
 - 11: $m_i \leftarrow m_i + 1$
 - 12: $t_since_last_update \leftarrow 0$
 - 13: **end if**
 - 14: **end if**
 - 15: **end loop**
-

For the algorithm to work effectively, the mon_window and dec_factor parameters must be carefully tuned based on model accuracy requirements and the specific use case. A high mon_window value would result in a more stable system,

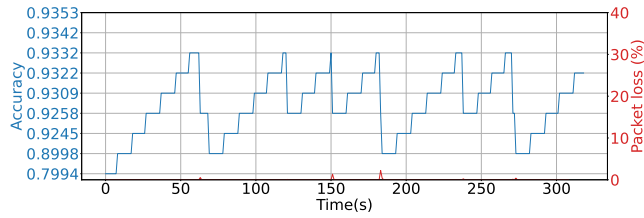

Figure 4: Timeseries of Cruise Control model selection algorithm. The blue line represents the selected feature set, while the red line shows the number of dropped packets over time.

causing Cruise Control to switch to more complex feature sets more gradually. Conversely, a low *mon_window* value enables the system to quickly increase the current feature set but increases the risk of more frequent saturation. The *dec_factor* determines the number of feature sets skipped when a drop is detected. A high *dec_factor* minimizes the likelihood of subsequent losses by selecting a feature set with significantly reduced complexity, though this may come at the cost of reduced accuracy. At each change, the monitor updates the feature set used by the Workers, as illustrated in Figure 3.

Example. To demonstrate the behavior of this algorithm in a practical scenario, we run Cruise Control using a sample traffic trace: the first five minutes of the CAIDA dataset previously utilized [12]. The results are presented in Figure 4. Each horizontal line in the figure represents a feature set shown in Table 1. The accuracy of each corresponding model is shown on the left y-axis, with candidate sets spanning accuracy values from 0.7994 (*m1*) to 0.9353 (*m9*). The blue line illustrates the feature set selected by Cruise Control over time, while the red line (right y-axis) represents the number of dropped packets observed every second.

From the figure, we observe an initial phase where Cruise Control quickly increases the complexity of the computed feature sets, transitioning to more accurate models. After 63 seconds, the system detects packet losses, prompting the algorithm to rapidly downgrade to a less complex feature set. In this example, with *dec_factor* set to 0.5, the algorithm switches from the feature set with index 6 to index 3. When a second drop occurs at 69 seconds, the system further reduces complexity, falling back to index 1. It is important to note that these changes occur immediately upon detection of packet drops by the monitor, rather than at each *mon_window* interval. The *mon_window* value is used exclusively for incrementing to more complex feature sets.

3.4 Dynamic Feature Computation

Once incoming packets are received by the NIC, they are processed by the Feature Computation module, which extracts

the features required by the selected model, aggregates them, and prepares them for consumption by the model. The Feature Computation module consists of two primary components: Workers and a Post-Processor. The Workers handle feature extraction directly from incoming packets based on the feature set by the Model Selection module. Periodically, the Post-Processor aggregates these features and exports them for use by the model.

Packet processing pipeline. Workers operate on dedicated CPU cores and perform feature extraction tasks, including packet filtering, pre-processing (e.g., header parsing), and basic feature computations (e.g., calculating flow throughput or packet counters). Cruise Control leverages multi-core architectures to parallelize packet processing across two dimensions. First, each Worker processes a subset of the traffic. To account for features that depend on entire connections rather than individual packets, all packets belonging to a given network flow are processed by the same Worker. This is achieved using Receive Side Scaling (RSS). Second, a backup Worker is instantiated to handle load while the primary Worker performs feature post-processing and export tasks. The mapping between connections and Workers is managed through an indirection table (illustrated in Figure 3), which routes packets to the appropriate Worker. Further details on this mechanism are discussed later in the section. Additionally, we integrate flow filters to ensure that only packets from relevant connections are forwarded to the Workers. These filters can be implemented in either hardware or software, depending on the capabilities of the network interface card. More details on the filtering mechanism are provided in Section 4.

Each Worker maintains a dedicated hashmap to store the necessary data for monitored network flows. Each hashmap entry contains the set of features computed for a specific connection, along with the required flow state information. When a new packet enters the pipeline, it is directed to the corresponding Worker and processed according to the logic outlined in Figure 5. If the packet belongs to a new flow, the Worker first determines which features need to be computed. It consults the shared configuration, which is continuously updated by the Model Selection module (see Figure 3). This configuration dynamically specifies the required features. Based on this information, the Worker initializes and allocates the necessary data structures, which are then cached for future packets from the same connection. For packets from known connections, the Worker accesses the pre-existing structures associated with the connection, updates relevant counters, extracts header information, and stores the data required for the previously requested features. Since the selected features are determined during the processing of the connection’s first packet, the Worker does not need to repeatedly access the configuration. This design choice ensures consistency

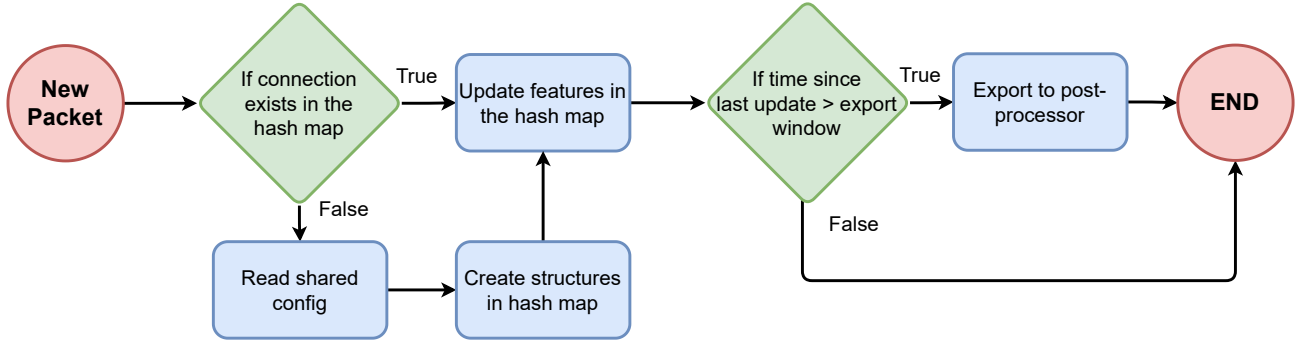

Figure 5: Diagram of the Worker workflow.

in feature computation for the duration of a network flow. However, this approach comes with a trade-off: it limits the system’s ability to quickly adapt to changes in the selected features. Nevertheless, this trade-off is necessary to maintain consistency, as certain features rely on historical data to be accurately computed (e.g., packet interarrival time distributions or video segment size distributions).

Feature export. Periodically, `Cruise Control` exports the computed features from the Workers to the Post-Processor. The Post-Processor, itself running on a dedicated core, collects the features extracted by the Workers, computes statistical features, and formats the output for the machine learning model. The interval between two exports is referred to as the *export_window*. The act of exporting collected features is often overlooked in existing work that emphasizes feature extraction [19, 39]. However, this operation can be resource-intensive, incurring significant CPU overhead and memory transfers, yet it is essential for passing data to the ML model. To perform the export, incoming traffic processing on a Worker must be temporarily halted to clear the hashmap storing the features. During this time, Workers are unable to process incoming traffic, potentially leading to significant packet drops if precautions are not taken. In our experiments, we observed that this export process can take several seconds to complete.

To mitigate these losses, we exploit concurrent redundancy to implement a solution in `Cruise Control`. When `Cruise Control` starts, a companion second Worker is created for every instantiated Worker, as shown in Figure 3. When a Worker needs to export its data, it notifies the Monitor, which updates the indirection table to redirect traffic to the companion Worker. This allows the exporting Worker to process its data uninterrupted. Once the export is complete, the Worker is designated as a backup, ready to handle traffic during the next export cycle. At each *export_window*, the Worker clears its hashmap and sends the collected data to the Post-Processor. The *export_window* interval depends on the specific use case

and the hardware capabilities, particularly the available memory. A shorter *export_window* requires less memory but introduces significant overhead, even with this solution. Conversely, a longer *export_window* reduces overhead but risks memory saturation and may be unsuitable if features must be delivered to ML models at smaller intervals.

4 EVALUATION

Here we present a proof-of-concept implementation of `Cruise Control` and evaluate its performance using two use cases: streaming video quality inference (Section 4.2) and service recognition (Section 4.3). These two use cases allow us to illustrate the effects of tunable parameters in `Cruise Control` and to compare its performance in terms of accuracy and loss rates versus static models.

4.1 Prototype Implementation and Testbed

Software prototype. We implement `Cruise Control` in Rust to leverage its features for ensuring memory and thread safety while utilizing modern packet processing frameworks to maximize packet processing efficiency. To handle high speed traffic, `Cruise Control` bypasses the kernel to avoid bottlenecks caused by the network stack [11, 40] using the Intel Data Plane Development Kit (DPDK) [1]. DPDK allows NIC to offload packets to a dedicated CPU core’s memory space without interruption by using Direct Memory Access (DMA). Further, DPDK implements RSS to distribute the connection across multiple CPU cores. We leverage this capability to share the connections between multiple CPU cores and to swap traffic from one core to another when a worker needs to export its hashmap to the post-processor. We leverage `Retina`’s filtering features [38] to provide an easy to extend Rust API to build upon. Our filter checks whether the packets match a set of rules depending on the use case, allowing us to discard irrelevant traffic before reaching our processing pipeline. In

total, our prototype implementation was ~3300 lines of Rust code.

In all experiments, we set Cruise Control to use two Workers, with only one active at a given time to simplify our analysis. The architecture is reflected in Figure 3. The capacity of Cruise Control could be extended to use more workers; however, additional analysis would be required to determine potential bottlenecks related to parallelism. We leave this for future work.

Hardware environment. Our testbed consists of two identical servers, each equipped with dual 16-core AMD EPYC 7343 processors and a 100GbE Intel E810 NIC. Both servers are connected to a shared 100Gb Ethernet switch. One server is dedicated to traffic generation using Cisco’s TRex [2], which replays real network traffic from capture files. This traffic is sent to the switch, where it is mirrored to the second server running Cruise Control. The testbed simulates a realistic environment in which a network operator monitors traffic on a specific span port. It is worth noting that the use of AMD CPUs precludes leveraging Intel’s Data Direct I/O Technology (DDIO), which facilitates direct transfers from the NIC to the CPU cache.

Network traffic. To mimic realistic traffic conditions, we use a one-hour trace collected at Equinix Chicago in 2016 [12]. The selected trace is a traffic capture available upon request from the CAIDA’s website (20160121). Throughout the trace, the throughput remains relatively constant, with an average rate of approximately 10 Gbps. In our analysis, we use packets per second (PPS) to express traffic load rather than Gbps, as Cruise Control processes only packet headers, making its performance independent of payload size. The trace’s rate fluctuates between 1 MPPS and 1.2 MPPS. To simulate varying traffic rates in our experiments, we adjust the inter-packet time using TRex. As with the experiment discussed in Section 2, we use three different traffic profiles: noon, evening, and night. The noon profile is used as the base profile, with the evening profile scaled by a factor of 1.6 and the night profile scaled by a factor of 0.2. Note that there are random gaps in the trace of approximately 1 second, likely due to artifacts during capture.

4.2 Use Case: Inferring Streaming Video Quality

The first use case we explore with Cruise Control focuses on inferring streaming video quality. For this, we use the feature sets identified along the Pareto front from the example presented in Section 3.

Cruise Control performance under varying traffic loads. To evaluate Cruise Control’s ability to adapt to evolving traffic loads, we use the three traffic profiles (noon, evening, and night) described above. The transitions between traffic

profiles are purposefully abrupt to assess Cruise Control’s responsiveness to sudden changes in traffic load. We compare Cruise Control’s performance against static system configurations using the different potential models. These baselines emulate the behavior of current state-of-the-art systems, which select a model at runtime and maintain it throughout deployment without adjustment.

To evaluate the loss and accuracy improvements achieved by Cruise Control, we present Figure 6a, where the model coordinates are defined by their accuracy (y-axis) and packet loss rates (x-axis). Orange circles represent static configurations, while a blue square denotes Cruise Control. Since Cruise Control dynamically employs multiple feature sets over time, its accuracy varies. We depict its median accuracy along with the first and third quartiles. In this figure, the optimal configuration would lie in the top-left corner, representing maximum accuracy with no packet loss. As shown, all static feature sets beyond $m2$ incur packet loss rates exceeding 9%, rendering them unsuitable for practical deployment. In contrast, Cruise Control achieves a loss rate of only 0.37% while matching the median accuracy of $m3$. Notably, $m2$, which might be selected in a static deployment to avoid unacceptable loss rates, results in a higher loss rate (1.57%) than Cruise Control and delivers lower accuracy (a 0.025 difference in median accuracy).

We further dig into this result and explore the reasons behind the packet losses. Figure 7 shows a timeseries of the traffic profile (7a), as well as various timeseries representing system behavior for both Cruise Control (7d) and two representative static configurations (7b and 7c). The figures show the model accuracy (in blue / left y-axis) and packet losses (in red / right y-axis) over the duration of the experiment. We observe that with $m3$ static feature set there are only a few drops during the ‘noon’ traffic profile (up to 600 seconds) at the time of the exports. For the ‘evening’ traffic profile (600-1200 seconds), the system is unable to compute $m3$ for all the packets leading to significant packet loss. Finally, the traffic is processed without loss for the final 10 minutes corresponding to the ‘night’ profile. We plot the average accuracy of $m2$ and $m3$ as horizontal blue lines at 0.899 and 0.9245, respectively. However, the accuracy of static configurations becomes unpredictable when packet loss occurs due to the randomness of the loss. This is particularly noticeable when the traffic speed reaches the higher rate between 600s and 1200s, where $m2$ experiences roughly 5% loss and $m3$ experiences 15%.

In comparison, Cruise Control dynamically changes the model used over time. As shown in Figure 7d, Cruise Control steps through the models defined by the Pareto front to reach the most accurate ones during the first 10 minutes and, when losses occur, steps down to less complex models. At 600 seconds when the traffic rate increases we observe a burst of packet loss, triggering Cruise Control to adjust down to the least accurate (and least costly) model $m1$. This model is

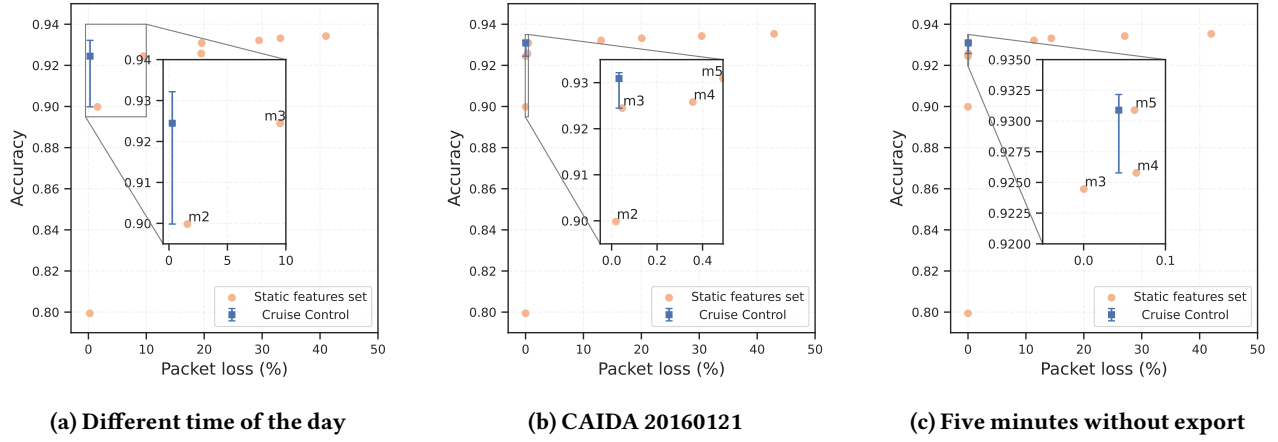

Figure 6: Video streaming quality inference features extraction across three different network profiles.

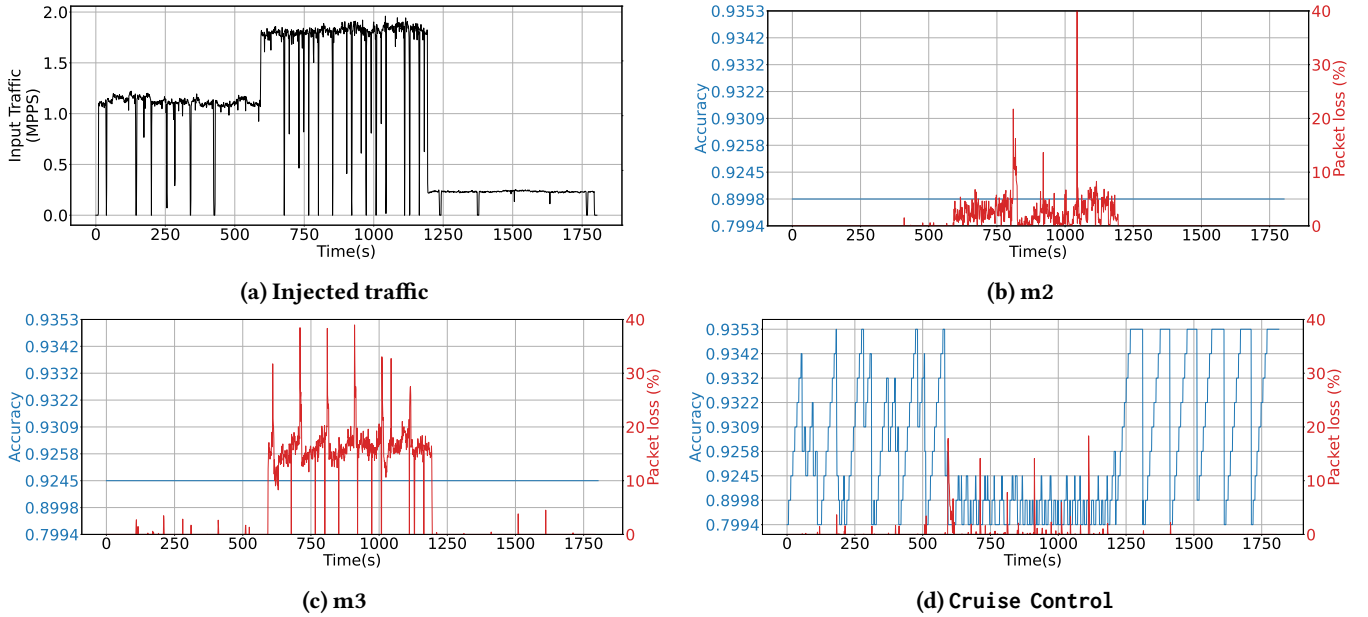

Figure 7: Timeseries for static feature sets and Cruise Control

able to process the traffic without loss. At 1200 seconds, the traffic rate decreases and Cruise Control once again steps back to the most accurate model. This experiment demonstrates the ability of Cruise Control to adapt to changing load while minimizing loss compared to the static configuration. Whereas Cruise Control introduces some variability in accuracy, it is able to avoid and respond to packet loss. Additionally, during times where the system has excess processing capacity, Cruise Control is able to achieve higher accuracy compared with the static configuration.

Sensitivity analysis: Impact of *mon_window* parameter. We next evaluate the impact that the *mon_window* parameter has on system performance. *mon_window* is a key parameter

for Cruise Control as it controls the pace at which the model selector will switch toward more complex configurations if packet losses are not observed. An aggressive behavior, might cause excessive losses. Conversely, a conservative approach might limit the model accuracy achieved by the system. We run ten experiments on a single 1-hour CAIDA traffic trace, which allows us to evaluate Cruise Control over a long period with realistic operator traffic. The traffic rate is approximately 1.1 MPPS (4.2×10^9 packets for the duration of the trace). For each experiment, we vary the *mon_window* to study the impact on the performance. Table 2 compiles the percentage of packet loss and the median accuracy results. As displayed, both packet loss and accuracy decrease when

<i>mon_window</i>	1	2	3	4	5	6	7	8	9	10
Packet loss (%)	0.107	0.074	0.050	0.048	0.043	0.038	0.034	0.033	0.036	0.031
Accuracy	0.932	0.931	0.931	0.931	0.931	0.931	0.931	0.931	0.926	0.926

Table 2: Summary of the experimental results

mon_window increases as Cruise Control dwells longer on a model / feature set before switching. For this particular use case and traces, the ideal choice is a *mon_window* of eight seconds offering the ideal balance of accuracy and packet loss. We envision a similar experiment could be conducted for any use case to determine the optimal *mon_window* value in a production environment.

Given the results of our *mon_window* experiment we run the same experiments for the static feature sets. Figure 6b shows Cruise Control again performs comparatively well for this realistic scenario. Cruise Control loses a small percentage of packets, approximately the same as the static features set *m3* (about 0.05%), but provides the same median accuracy as *m5* that losses 4.90% of the packets. This results highlights the impact of *mon_window* on both accuracy and packet loss.

Sensitivity analysis: Impact of feature export. Finally, we evaluate the impact that a key component of our system has on packet losses shown above. In particular, to ensure that the previous results are not an artifact generated by our export mechanisms that switches across separate Workers, we run a short experiment scaled down according to the amount of RAM. This experiment only includes five minutes of traffic, with all features kept in RAM. By doing so, we avoid any overheads related to hashmap transfer to the post-processor. The results are shown in Figure 6c. As shown, the behavior of Cruise Control is consistent with the previous experiment. We observe that, in this experiment, Cruise Control has slightly more packet loss than *m3*, as it remains at 0% while Cruise Control results in 0.043% loss. However, *m4* and *m5* experience 0.062% and 0.064% loss, respectively while Cruise Control results in a median accuracy equal to *m5*. This experiment again highlights the advantage of Cruise Control over static configurations, as we observe a significant advantage in terms of accuracy, with a small penalty in terms of packet losses.

4.3 Use Case: Service Recognition

For the second use case, we focus on service recognition, one of the most studied traffic analysis tasks [5, 42]. In this task, models are designed to determine the service to which a given network flow belongs. Accurate service recognition is a critical aspect of modern network management, supporting

essential functions such as performance monitoring (*i.e.*, identifying multiple flows associated with a single application), quality of service (*i.e.*, flows pertaining to a streaming service must first be correctly categorized), and security (*i.e.*, identifying attack-related traffic flows). The widespread adoption of encryption has made this process increasingly challenging. The encryption process renders packet payload data less informative for identification purposes after the initial TLS handshake [22, 34]. Consequently, by developing a system capable of identifying network flows using only a few initial packets, we can potentially minimize computational overhead and enhance the system’s connection processing capacity. In the following section, we concentrate on the initial 10 packets of each connection.

Offline feature selection. We again apply the methodology to discover the Pareto front as the previous use case. First, we run a set of experiments to estimate the number of CPU cycles of six unitary features and their 63 combinations. These six features are obtained from the same set of as previous use case, without the four features that relate to video segment identification (which are specific to the video inference use case). We also consider the use of raw headers (IP/TCP) as a feature. Raw headers have been recently adopted as a data representation that, combined with deep learning models, enables more detailed and accurate traffic identification [18, 34]. As there are no calculations to extract raw headers, this feature’s complexity is rather low. However, its collection is more memory intensive, but this is not taken into account in our features’ cost estimation. Raw headers therefore offer high precision at low cost³. The resulting Pareto front is shown in Figure 8 and Table 3. Among the 63 feature sets, three are finally selected. The raw headers feature set is represented as model *m3*.

Cruise Control Performance under varying traffic loads.

We evaluate Cruise Control’s performance using the experimental setup described in Section 4.2. Figure 9a illustrates the relationship between achieved accuracy and packet loss across the different traffic profiles. Of note, the system experiences consistently lower packet loss rates for all models compared to the previous use case. This improvement stems from the simplified analysis required by the new use case, which focuses solely on processing the first 10 packets of

³Based on our use of CPU cycles as the cost metric. A cost metric based on memory usage could also be used. We leave this for future exploration.

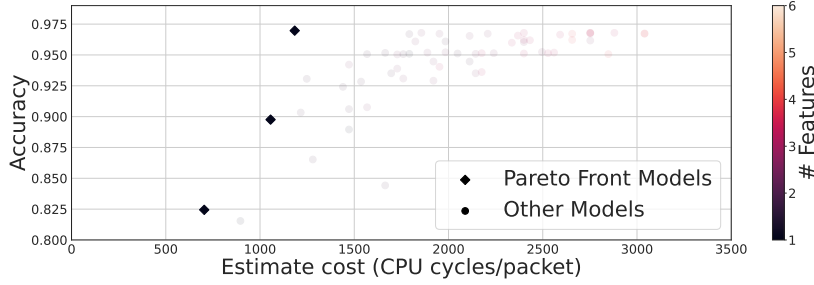
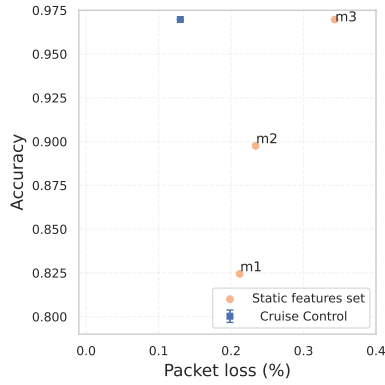

Figure 8: Service recognition model Pareto front.

Model #	Cost	Accuracy
<i>m3</i>	1184	0.97
<i>m2</i>	1056	0.90
<i>m1</i>	704	0.82

Table 3: Ranked models.



(a) Different time of the day

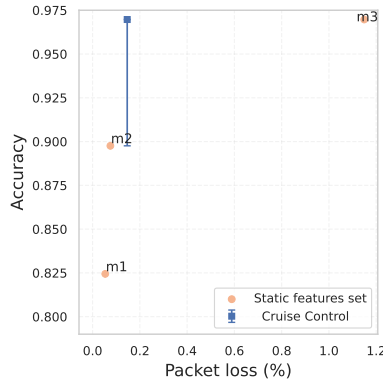

(b) CAIDA 20160121

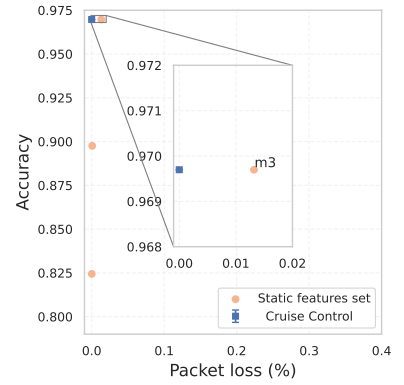

(c) 5 minutes without export

Figure 9: Service recognition features extraction across three different network load

each network connection. From the figure we also observe that even with lower overall losses, Cruise Control is again able to achieve both higher accuracy and less packet losses compared to the static configurations.

Sensitivity analysis. We run the same experiments as in the previous use case to evaluate the impact of the *mon_window* (Figure 9b) parameter on the system’s performance, as well as the impact of the export phase on system performance (Figure 9c). In the first experiment, we observe the same behavior as in the first use case, with accuracy and drops that decrease with larger *mon_window*. We do not present the results here, as they are consistent with the previous use case. In particular, the value that maximizes accuracy while reducing drop is once again eight seconds (with 0.147% packet loss and 0.97 accuracy respectively).

For the second experiment, we observe that the system experiences no packet loss for all models except for *m3*, which is due to a spike in packet drops at startup. We investigate the nature of the losses and observe that most drops occur when features are exported from the Workers to the Post-processor. This result highlights how, for this scenario, only

higher traffic loads (*i.e.*, the ‘evening’ traffic profile in our experiments) can lead to packet losses. Overall, Cruise Control consistently outperforms the static configurations across both performance metrics.

5 RELATED WORK

System for extracting features from network traffic.

Network feature extraction has been a dynamic research area for decades, with systems designed to derive meaningful insights from traffic. Recent advancements focus on high-speed network traffic processing. For example, PacketMill [15] optimizes software for 100Gb/s throughput, Enso [33] introduces a streaming abstraction for improved efficiency, and Retina [38] uses multilayered filtering and streamlined feature extraction for relevant network flows. However, these solutions rely on static configurations that can lead to sub-optimal performance under changing network conditions. In contrast, Cruise Control introduces a dynamic configuration framework that adapts to varying network loads in real time, offering a more flexible approach.

Constraint-aware ML model creation. Neglecting system constraints during model training can significantly impact

inference time, causing packet loss that affects ML model performance. To address this, Traffic Refinery [8] proposes techniques to explore and mitigate data representation technical debt, but it requires manual intervention. In contrast, CATO [39] performs automated, end-to-end optimization of the traffic analysis pipeline, but it’s offline and requires model selection online. Another line of work explores deploying in-network inference within programmable network devices [29, 41] to exploit high-speed processing capabilities. However, this faces limitations due to restricted command and extraction capabilities. They struggle to support complex operations, constraining model features and sophistication.

Dynamic model selection. Only a limited number of studies explore dynamic model selection for traffic analysis. pForest [10] considers multiple machine learning models and dynamically switches between them based on the number of packets arriving in a flow. Similarly, Jiang et al. [19] investigate dynamic selection from a pool of classifiers, each with varying feature requirements, enabling trade-offs between classification speed and memory consumption. However, their work primarily focuses on estimating memory usage costs. In contrast, Cruise Control highlights the critical role of CPU cycles and tailors model selection to optimize computational performance, addressing a broader range of system efficiency considerations.

Outside of the traffic analysis, adaptive model selection has been explored to handle varying load profiles. Clipper [14] integrates multiple machine learning frameworks, enabling dynamic model selection to balance accuracy and latency in prediction-serving applications. Similarly, INFaaS [32] dynamically optimizes model selection by choosing the most suitable variant from a predefined set, guided by high-level requirements such as performance, cost, or accuracy. In contrast, Cruise Control extends this concept to network traffic analysis, introducing a fully dynamic adaptation mechanism that continuously adjusts to fluctuations in system performance and network load.

6 DISCUSSION AND CONCLUSION

Cruise Control opens several directions for future research.

Multiple workers. As discussed in Section 4, we limit the evaluation to a single active worker at a time for simplicity in analysis. However, Cruise Control can scale without requiring a dedicated backup core for each new worker, as synchronicity is managed by the monitor. This scalability was taken into consideration during the development of the proof-of-concept, which includes several optimizations, such as the use of thread-local hashmaps. Consequently, we expect

Cruise Control to achieve high throughput with minimal overhead. We plan to evaluate this in future work.

Multiple ML tasks. While this paper focuses on deploying a single ML task, a real-world deployment would likely involve multiple tasks simultaneously. Serving multiple task pipelines simultaneously will necessarily lead to considering the intersection between the feature sets as well as interactions between Cruise Control pipelines as they independently adapt to observed conditions on the same system. We believe this could be an area that is ripe for new research moving forward.

Complexity estimation. As mentioned in Section 3.2, considering only CPU cycles to represent system capacity can lead to performance problems depending on the environment where Cruise Control is deployed. We believe that including more metrics (e.g., in-use memory) in the estimation could lead to a more representative Pareto front. However, the complexity of the estimation could increase significantly, and we plan to investigate this in future work. Further, our current solution focuses exclusively on extracting features from network traffic, leaving model execution beyond its scope. In future work, we aim to incorporate the complexity of the ML model itself, which could offer a more accurate representation of the system’s overall capabilities.

Monitor additional system metrics. This work uses packet loss as the primary metric for detecting system behavior. Our goal was to develop a simple yet effective solution, and this straightforward approach delivers clear benefits, as demonstrated in the paper. However, it also limits the complexity of the decisions made. We believe that incorporating additional metrics into the monitoring process could enable more fine-grained dynamic selection and further enhance the system’s performance.

Conclusion. In this work, we introduce Cruise Control, a system that dynamically selects target ML models for traffic analysis tasks at runtime, without requiring user intervention. Cruise Control leverages lightweight signals to adapt to changing network conditions and the system’s available resources. We detail the design of Cruise Control and evaluate it across two use cases, demonstrating its advantages under varying traffic configurations. We believe the presented approach has the potential to inspire new research directions, advancing the deployment of machine learning-based tasks in operational networks. To encourage further exploration and innovation, we are releasing Cruise Control as an open-source project.

REFERENCES

- [1] 2023. Data Plane Development Kit. <https://www.dpdk.org/>.
- [2] 2023. TRex, Realistic Traffic Generator. <https://trex-tgn.cisco.com>.

- [3] Mahmoud Abbasi, Amin Shahraki, and Amir Taherkordi. 2021. Deep Learning for Network Traffic Monitoring and Analysis (NTMA): A Survey. *Computer Communications* 170 (2021), 19–41. <https://doi.org/10.1016/j.comcom.2021.01.021>
- [4] Zeeshan Ahmad, Adnan Shahid Khan, Cheah Wai Shiang, Johari Abdullah, and Farhan Ahmad. 2021. Network intrusion detection system: A systematic study of machine learning and deep learning approaches. *Transactions on Emerging Telecommunications Technologies* 32, 1 (2021), e4150.
- [5] Iman Akbari, Mohammad A. Salahuddin, Leni Ven, Noura Limam, Raouf Boutaba, Bertrand Mathieu, Stephanie Moteau, and Stephane Tuffin. 2021. A Look Behind the Curtain: Traffic Classification in an Increasingly Encrypted Web. *Proc. ACM Meas. Anal. Comput. Syst.* 5, 1, Article 04 (Feb. 2021), 26 pages. <https://doi.org/10.1145/3447382>
- [6] Laurent Bernaille, Renata Teixeira, and Kavé Salamati. 2006. Early Application Identification. In *International Conference on Emerging Networking Experiments and Technologies (CoNEXT)*.
- [7] Raouf Boutaba, Mohammad A. Salahuddin, Noura Limam, Sara Ayoubi, Nashid Shahriar, Felipe Estrada-Solano, and Oscar M. Caicedo. 2018. A comprehensive survey on machine learning for networking: evolution, applications and research opportunities. In *Journal of Internet Services and Applications*.
- [8] Francesco Bronzino et al. 2022. Traffic refinery: Cost-aware data representation for machine learning on network traffic. In *ACM SIGMETRICS 2022*.
- [9] Francesco Bronzino, Paul Schmitt, Sara Ayoubi, Guilherme Martins, Renata Teixeira, and Nick Feamster. 2019. Inferring Streaming Video Quality from Encrypted Traffic: Practical Models and Deployment Experience. In *Proceedings of the ACM on Measurement and Analysis of Computing Systems*.
- [10] Coralie Busse-Grawitz, Roland Meier, Alexander Dietmüller, Tobias Bühler, and Laurent Vanbever. 2022. pForest: In-Network Inference with Random Forests. arXiv:1909.05680 [cs.NI] <https://arxiv.org/abs/1909.05680>
- [11] Qizhe Cai, Shubham Chaudhary, Midhul Vuppapapati, Jaehyun Hwang, and Rachit Agarwal. 2021. Understanding host network stack overheads. In *Proceedings of the 2021 ACM SIGCOMM 2021 Conference (Virtual Event, USA) (SIGCOMM '21)*. Association for Computing Machinery, New York, NY, USA, 65–77. <https://doi.org/10.1145/3452296.3472888>
- [12] CAIDA. 2016. CAIDA Anonymized Internet Traces 2016 Dataset. https://www.caida.org/data/passive/passive_2016_dataset.xml Access restricted to approved researchers.
- [13] Dah-Ming Chiu and Raj Jain. 1989. Analysis of the increase and decrease algorithms for congestion avoidance in computer networks. *Computer Networks and ISDN Systems* 17, 1 (1989), 1–14. [https://doi.org/10.1016/0169-7552\(89\)90019-6](https://doi.org/10.1016/0169-7552(89)90019-6)
- [14] Daniel Crankshaw, Xin Wang, Giulio Zhou, Michael J. Franklin, Joseph E. Gonzalez, and Ion Stoica. 2017. Clipper: A Low-Latency Online Prediction Serving System. arXiv:1612.03079 [cs.DC] <https://arxiv.org/abs/1612.03079>
- [15] Alireza Farshin, Tom Barrette, Amir Roozbeh, Gerald Q. Maguire Jr., and Dejan Kostić. 2021. PacketMill: toward per-Core 100-Gbps networking. In *Proceedings of the 26th ACM International Conference on Architectural Support for Programming Languages and Operating Systems (Virtual, USA) (ASPLOS '21)*. Association for Computing Machinery, New York, NY, USA, 1–17. <https://doi.org/10.1145/3445814.3446724>
- [16] Anja Feldmann, Oliver Gasser, Franziska Lichtblau, Enric Pujol, Ingmar Poesse, Christoph Dietzel, Daniel Wagner, Matthias Wichtlhuber, Juan Tapiador, Narseo Vallina-Rodriguez, Oliver Hohlfeld, and Georgios Smaragdakis. 2020. The Lockdown Effect: Implications of the COVID-19 Pandemic on Internet Traffic. In *Proceedings of the ACM Internet Measurement Conference (IMC '20)*. ACM, 1–18. <https://doi.org/10.1145/3419394.3423658>
- [17] Craig Gutterman, Katherine Guo, Sarthak Arora, Trey Gilliland, Xiaoyang Wang, Les Wu, Ethan Katz-Bassett, and Gil Zussman. 2020. Requet: Real-Time QoE Metric Detection for Encrypted YouTube Traffic. *ACM Trans. Multimedia Comput. Commun. Appl.* 16, 2s, Article 71 (July 2020), 28 pages. <https://doi.org/10.1145/3394498>
- [18] Jordan Holland, Paul Schmitt, Nick Feamster, and Prateek Mittal. 2021. New Directions in Automated Traffic Analysis. In *Proceedings of the 2021 ACM SIGSAC Conference on Computer and Communications Security (Virtual Event, Republic of Korea) (CCS '21)*. Association for Computing Machinery, New York, NY, USA, 3366–3383. <https://doi.org/10.1145/3460120.3484758>
- [19] Xi Jiang, Shinan Liu, Saloua Naama, Francesco Bronzino, Paul Schmitt, and Nick Feamster. 2023. AC-DC: Adaptive Ensemble Classification for Network Traffic Identification. arXiv:2302.11718 [cs.NI] <https://arxiv.org/abs/2302.11718>
- [20] Ansam Khraisat, Iqbal Gondal, Peter Vamplew, and Joarder Kamruzzaman. 2019. Survey of intrusion detection systems: techniques, datasets and challenges. *Cybersecurity* 2 (12 2019). <https://doi.org/10.1186/s42400-019-0038-7>
- [21] Hongyu Liu and Bo Lang. 2019. Machine Learning and Deep Learning Methods for Intrusion Detection Systems: A Survey. *Applied Sciences* 9, 20 (Jan. 2019), 4396. <https://doi.org/10.3390/app9204396> Number: 20 Publisher: Multidisciplinary Digital Publishing Institute.
- [22] Shinan Liu, Ted Shaowang, Gerry Wan, Jeewon Chae, Jonatas Marques, Sanjay Krishnan, and Nick Feamster. 2024. ServeFlow: A Fast-Slow Model Architecture for Network Traffic Analysis. arXiv:2402.03694 [cs.NI] <https://arxiv.org/abs/2402.03694>
- [23] Tarun Mangla, Emir Halepovic, Mostafa Ammar, and Ellen Zegura. 2018. emimic: Estimating http-based video qoe metrics from encrypted network traffic. In *2018 Network Traffic Measurement and Analysis Conference (TMA)*. IEEE, 1–8.
- [24] Tarun Mangla, Emir Halepovic, Mostafa Ammar, and Ellen Zegura. 2019. Using session modeling to estimate HTTP-based video QoE metrics from encrypted network traffic. *IEEE Transactions on Network and Service Management* 16, 3 (2019), 1086–1099.
- [25] M. Hammad Mazhar and Zubair Shafiq. 2018. Real-time Video Quality of Experience Monitoring for HTTPS and QUIC. In *IEEE INFOCOM Conference on Computer Communications*.
- [26] M. Sajid Mushtaq, Brice Augustin, and Abdelhamid Mellouk. 2012. Empirical study based on machine learning approach to assess the QoS/QoE correlation. In *2012 17th European Conference on Networks and Optical Communications*. 1–7. <https://doi.org/10.1109/NOC.2012.6249939>
- [27] Raza Ul Mustafa, Md Tariqul Islam, Christian Rothenberg, and Pedro Henrique Gomes. 2023. EFFECTOR: DASH QoE and QoS Evaluation Framework For Encrypted Video Traffic. In *NOMS 2023-2023 IEEE/IFIP Network Operations and Management Symposium*. 1–8. <https://doi.org/10.1109/NOMS56928.2023.10154448>
- [28] Thuy T.T. Nguyen and Grenville Armitage. 2008. A comprehensive survey on machine learning for networking: evolution, applications and research opportunities. In *IEEE Communications Surveys & Tutorials*.
- [29] Ricardo Parizotto, Bruno Loureiro Coelho, Diego Cardoso Nunes, Israat Haque, and Alberto Schaeffer-Filho. 2023. Offloading Machine Learning to Programmable Data Planes: A Systematic Survey. *ACM Comput. Surv.* 56, 1, Article 18 (Aug. 2023), 34 pages. <https://doi.org/10.1145/3605153>
- [30] Julien Piet, Dubem Nwoji, and Vern Paxson. 2023. GGFASST: Automating Generation of Flexible Network Traffic Classifiers. In *Proceedings of the ACM SIGCOMM 2023 Conference*. 850–866.
- [31] Shahbaz Rezaei, Bryce Kroencke, and Xin Liu. 2019. Large-scale Mobile App Identification Using Deep Learning. In *IEEE Access*.

- [32] Francisco Romero, Qian Li, Neeraja J. Yadwadkar, and Christos Kozyrakis. 2021. INFaaS: Automated Model-less Inference Serving. In *2021 USENIX Annual Technical Conference (USENIX ATC 21)*. USENIX Association, 397–411. <https://www.usenix.org/conference/atc21/presentation/romero>
- [33] Hugo Sadok, Nirav Atre, Zhipeng Zhao, Daniel S. Berger, James C. Hoe, Aurojit Panda, Justine Sherry, and Ren Wang. 2023. Enso: A Streaming Interface for NIC-Application Communication. In *17th USENIX Symposium on Operating Systems Design and Implementation (OSDI 23)*. USENIX Association, Boston, MA, 1005–1025. <https://www.usenix.org/conference/osdi23/presentation/sadok>
- [34] Tal Shapira and Yuval Shavitt. 2021. FlowPic: A Generic Representation for Encrypted Traffic Classification and Applications Identification. In *IEEE Transactions on Network and Service Management*.
- [35] Taveesh Sharma, Tarun Mangla, Arpit Gupta, Junchen Jiang, and Nick Feamster. 2023. Estimating WebRTC Video QoE Metrics Without Using Application Headers. In *ACM SIGCOMM Internet Measurement Conference (IMC)*. Montreal, Canada, 1–12.
- [36] Meng Shen, Ke Ye, Xingtong Liu, Liehuang Zhu, Jiawen Kang, Shui Yu, Qi Li, and Ke Xu. 2023. Machine Learning-Powered Encrypted Network Traffic Analysis: A Comprehensive Survey. *IEEE Communications Surveys & Tutorials* 25, 1 (2023), 791–824. <https://doi.org/10.1109/COMST.2022.3208196>
- [37] Jayveer Singh and Manisha Nene. 2013. A survey on machine learning techniques for intrusion detection systems. In *International Journal of Advanced Research in Computer and Communication Engineering*.
- [38] Gerry Wan, Fengchen Gong, Tom Barbette, and Zakir Durumeric. 2022. Retina: Analyzing 100GbE Traffic on Commodity Hardware. In *Proceedings of the ACM SIGCOMM 2022 Conference (Amsterdam, Netherlands) (SIGCOMM '22)*. Association for Computing Machinery, New York, NY, USA, 530–544. <https://doi.org/10.1145/3544216.3544227>
- [39] Gerry Wan, Shinan Liu, Francesco Bronzino, Nick Feamster, and Zakir Durumeric. 2024. CATO: End-to-End Optimization of ML-Based Traffic Analysis Pipelines. arXiv:2402.06099 [cs.NI] <https://arxiv.org/abs/2402.06099>
- [40] Xiaoban Wu, Peilong Li, Yongyi Ran, and Yan Luo. 2018. Network measurement for 100 GbE network links using multicore processors. *Future Gener. Comput. Syst.* 79, P1 (feb 2018), 180–189. <https://doi.org/10.1016/j.future.2017.04.038>
- [41] Zhaoqi Xiong and Noa Zilberman. 2019. Do Switches Dream of Machine Learning? Toward In-Network Classification. In *Proceedings of the 18th ACM Workshop on Hot Topics in Networks (Princeton, NJ, USA) (HotNets '19)*. Association for Computing Machinery, New York, NY, USA, 25–33. <https://doi.org/10.1145/3365609.3365864>
- [42] Baris Yamansavascular, M. Amac Guvensan, A. Gokhan Yavuz, and M. E. Karsligil. 2017. Application identification via network traffic classification. In *2017 International Conference on Computing, Networking and Communications (ICNC)*. 843–848. <https://doi.org/10.1109/ICCNC.2017.7876241>
- [43] Jiuxing Zhou, Wei Fu, Wei Hu, Zhihong Sun, Tao He, and Zhihong Zhang. 2024. Challenges and Advances in Analyzing TLS 1.3-Encrypted Traffic: A Comprehensive Survey. *Electronics* 13, 20 (2024). <https://doi.org/10.3390/electronics13204000>