

EQUIVARIANT \mathbb{Q} -SLICENESS OF STRONGLY INVERTIBLE KNOTS

ALESSIO DI PRISA AND OĞUZ ŞAVK

ABSTRACT. We introduce and study the notion of equivariant \mathbb{Q} -sliceness for strongly invertible knots. On the constructive side, we prove that every *Klein amphichiral knot*, which is a strongly invertible knot admitting a *compatible* negative amphichiral involution, is equivariant \mathbb{Q} -slice in a single \mathbb{Q} -homology 4-ball, by refining Kawauchi's construction and generalizing Levine's uniqueness result. On the obstructive side, we show that the equivariant version of the classical Fox-Milnor condition, proved recently by the first author in [DP24], also obstructs equivariant \mathbb{Q} -sliceness. We then introduce the equivariant \mathbb{Q} -concordance group and study the natural maps between concordance groups as an application. We also list some open problems for future study.

1. INTRODUCTION

A knot $K \subset S^3$ is called *invertible* if K is isotopic to its reverse $-K$. Similarly, K is said to be *negative amphichiral* if K is isotopic to the reverse of its mirror image $-\overline{K}$. When the isotopy maps ρ and τ are further chosen to be involutions (see §2.1), the pairs (K, ρ) and (K, τ) are called *strongly invertible* and *strongly negative amphichiral*, respectively.

The search for sliceness notions for strongly invertible and strongly negative amphichiral knots dates back to the nineteen-eighties. In his influential article [Sak86], Sakuma introduced the notion of *equivariant sliceness* for strongly invertible knots, by requiring them to bound equivariant disks smoothly and properly embedded in B^4 . Cochran and Kawauchi first observed the \mathbb{Q} -sliceness for the figure-eight knot and the $(2, 1)$ -cable of the figure-eight knot, respectively, in the sense that these knots bound disks smoothly properly embedded in some \mathbb{Q} -homology 4-balls. Kawauchi's observation appeared in an unpublished note [Kaw80], and Cochran used the earlier work of Fintushel and Stern [FS84], which was never published. Later, Kawauchi [Kaw09] proved his famous characterization result, showing that every strongly negative amphichiral knot is \mathbb{Q} -slice. See §1.2 for more details.

The main objective of this article is to merge the concepts of equivariant sliceness and \mathbb{Q} -sliceness and to introduce the study of equivariant \mathbb{Q} -sliceness. We call a strongly invertible knot (K, ρ) *equivariant \mathbb{Q} -slice* if K bounds an equivariant disk smoothly properly embedded in a \mathbb{Q} -homology 4-ball (see §2.2).

1.1. Fundamentals. Combining these two notions leads us to study the relations between knot symmetries and introduce a specific type of symmetry, which we call *Klein amphichirality*. A *Klein amphichiral* knot $K \subset S^3$ is a triple (K, ρ, τ) such that the strongly invertible involution ρ and strongly negative amphichiral involution τ commute with each other. This explains the motivation behind the name (see §2.2 for more details), since the maps ρ and τ together generate the *Klein four group* (*Vierergruppe* in German) in the symmetry group of the knot:

$$V = \mathbb{Z}/2\mathbb{Z} \times \mathbb{Z}/2\mathbb{Z} \leq \text{Sym}(S^3, K).$$

Our first theorem provides a refinement of Kawauchi's characterization of the \mathbb{Q} -sliceness of strongly negative amphichiral knots. Kawauchi constructed a \mathbb{Q} -homology 4-ball Z_K in which (K, τ) is slice a priori depending on the given knot. However, Levine [Lev23] surprisingly proved that such manifolds Z_K are actually all diffeomorphic to a single \mathbb{Q} -homology ball Z , called the *Kawauchi manifold*. Moreover, our theorem also extends Levine's crucial result to the equivariant case, showing that the pairs (Z, ρ_K) , corresponding to a \mathbb{Q} -homology 4-ball for a Klein amphichiral knot (K, ρ, τ) , is also unique.

Theorem A. Let (K, ρ, τ) be a Klein amphichiral knot. Then (K, ρ) is equivariant \mathbb{Q} -slice. In fact, (K, ρ) bounds a slice disk in the Kawauchi manifold Z which is invariant under an involution ρ_K of Z , extending ρ . Moreover, the involution ρ_K does not depend on (K, ρ, τ) up to conjugacy in $\text{Diff}(Z)$, where $\text{Diff}(Z)$ denotes the group of diffeomorphisms of Z .

Inspired by the earlier work of Cochran, Franklin, Hedden, and Horn [CFHH13], we provide a fundamental obstruction, which was already shown in [DP24] to obstruct equivariant sliceness. It is an equivariant and rational version of the Fox-Milnor condition, which plays a key role in comparing the notions of \mathbb{Q} -sliceness and equivariant \mathbb{Q} -sliceness. It is sufficient to obstruct well-known strongly invertible \mathbb{Q} -slice knots being equivariant \mathbb{Q} -slice, including the figure-eight knot, (see §2.5 for more details).

Theorem B. If (K, ρ) is equivariant \mathbb{Q} -slice, then its Alexander polynomial $\Delta_K(t)$ is a square.

Note that every Klein amphichiral knot is clearly *strongly positive amphichiral*, i.e., isotopic to its mirror image via an involution. Furthermore, it is well known from the classical result of Hartley and Kawauchi [HK79] that the Alexander polynomial of a strongly positive amphichiral knot is square. Therefore, it is interesting to compare Theorem A with Theorem B, see Problem A.

1.2. Applications. Using our main theorems in §1.1, we further investigate the natural maps between concordance groups. To do so, we introduce the *equivariant \mathbb{Q} -concordance group* $\tilde{\mathcal{C}}_{\mathbb{Q}}$ (see §2.3) by analyzing the equivariant \mathbb{Q} -concordance classes of strongly invertible knots.

Recall that two knots in S^3 are said to be *concordant* if they cobound a smoothly properly embedded annulus in $S^3 \times [0, 1]$. The set of oriented knots modulo concordance forms a countable abelian group, namely the *concordance group* \mathcal{C} , under the operation induced by connected sum. The trivial element in \mathcal{C} is formed by the concordance class of the unknot. The knots lying in this concordance class are the so-called *slice knots*, and they bound smoothly properly embedded disks in B^4 . The concordance group and the notion of sliceness were defined in the seminal work of Fox and Milnor [FM66]. Since then, they have been very central objects of active research in knot theory and low-dimensional topology, see the survey articles [Liv05, Hom17, Şav24]. Cha's monograph [Cha07] systemically elaborated the \mathbb{Q} -concordance of knots and the *\mathbb{Q} -concordance group* $\mathcal{C}_{\mathbb{Q}}$. Recently, there has been a great deal of interest in these concepts as well, see [KW18, Mil22, HKPS22, Lev23, Lee24].

In [Sak86], Sakuma introduced the *equivariant concordance group* $\tilde{\mathcal{C}}$ by studying strongly invertible knots under equivariant connected sum. It is again known to be countable, but until the recent work of the first author [DP23] and his joint work with Framba [DPF23b], the structure of $\tilde{\mathcal{C}}$ was completely mysterious. Unlike \mathcal{C} , it turns out that $\tilde{\mathcal{C}}$ is non-abelian and in fact non-solvable. The comprehensive study of $\tilde{\mathcal{C}}$ and its invariants have been the subjects of various recent articles [Wat17, BI22, DMS23, HHS23, MP23].

Considering four concordance groups and their natural maps, we therefore have the following commutative diagram. Since two concordant (resp. equivariant concordant) knots are \mathbb{Q} -concordant (resp. equivariant \mathbb{Q} -concordant), we have the surjective maps ψ and Ψ . Moreover, \mathfrak{f} and $\mathfrak{f}_{\mathbb{Q}}$ are both *forgetful* maps, forgetting the additional structures.

$$\begin{array}{ccc} \tilde{\mathcal{C}} & \xrightarrow{\Psi} & \tilde{\mathcal{C}}_{\mathbb{Q}} \\ \mathfrak{f} \downarrow & & \downarrow \mathfrak{f}_{\mathbb{Q}} \\ \mathcal{C} & \xrightarrow{\psi} & \mathcal{C}_{\mathbb{Q}} \end{array}$$

Using the new characterization in Theorem A, we show that the kernel of the map Ψ has a rich algebraic structure. Our constructions use certain Klein amphichiral Turk's head knots $J_n = Th(3, n)$, which are defined as the braid closures of the 3-braids $(\sigma_1 \sigma_2^{-1})^n$ (see [DPS24] and §2.4 for more details). For the obstructions, we rely on the moth polynomials introduced in the recent work of Framba and the first author [DPF23a] and on the application of Milnor invariants to equivariant concordance, as described in [DPF23b].

Theorem C. There exists a nonabelian subgroup \mathcal{J} of $\text{Ker}(\Psi)$ such that its abelianization \mathcal{J}^{ab} is isomorphic to \mathbb{Z}^∞ . Moreover, the image of \mathcal{J} under \mathfrak{f} is a 2-torsion subgroup of \mathcal{C} .

Using the fundamental obstruction in Theorem B, we are able to prove another interesting result about equivariant knots. Here, the constructive part follows from Cha's result (see §2.5).

Theorem D. There exists a subgroup \mathcal{K} of $\text{Ker}(\mathfrak{f}_{\mathbb{Q}})$ which surjects onto $(\mathbb{Z}/2\mathbb{Z})^\infty$.

Previously, the other maps in the above diagram have been studied extensively. In [Cha07], Cha showed that $\text{Ker}(\psi)$ has a $(\mathbb{Z}/2\mathbb{Z})^\infty$ subgroup, generated by non-slice amphichiral knots, containing the figure-eight knot (see §2.5). Recently, Hom, Kang, Park, and Stoffregen [HKPS22] proved that $(2n-1, 1)$ -cables of the figure-eight knot for $n \geq 2$ generate a \mathbb{Z}^∞ subgroup in $\text{Ker}(\psi)$.

On the other hand, Livingston [Liv83] (cf. [Kim23]) proved that the map \mathfrak{f} is not surjective, exhibiting knots which are not concordant to their reverses. This result was later improved in the work of Kim and Livingston [KL22], by showing the existence of topologically slice knots which are not concordant to their reverses. More recently, Kim [Kim23] showed the existence of knots that are not \mathbb{Q} -concordant to their reverses, showing that also the map $\mathfrak{f}_{\mathbb{Q}}$ is not surjective.

Potential counterexamples to the slice-ribbon conjecture based on certain cables of \mathbb{Q} -slice knots were recently eliminated by the work of Dai, Kang, Mallick, Park, and Stoffregen [DKM⁺22]. The core example was the $(2, 1)$ -cable of the figure-eight knot $K = 4_1$, denoted by $K_{2,1}$. Their strategy for obstructing the sliceness of a knot K was to show that its double branched cover bounds no equivariant homology 4-ball, remembering the data of the branching involution. This is closely related to the doubling construction (see §2.4) by means of the Montesinos trick which provides the diffeomorphism $\Sigma_2(K_{2,1}) \cong S_{+1}^3(K \# \bar{K})$. More precisely, this diffeomorphism identifies the branching involution on $\Sigma_2(K_{2,1})$ with the involution on surgered manifold $S_{+1}^3(K \# \bar{K})$, induced from the strong inversion on $K \# \bar{K}$. More obstructions were recently obtained by Kang, Park, and Taniguchi [KPT24].

Both \mathbb{Q} -slice and strongly invertible knots have been the subject of interesting constructions of 3- and 4-manifolds. For example, \mathbb{Q} -slice knots were used to exhibit Brieskorn spheres, which bound \mathbb{Q} -homology 4-balls but not \mathbb{Z} -homology 4-balls, see the articles by Akbulut and Larson [AL18] and the second author [Sav20]. Another instance was the work of Dai, Hedden, and Mallick [DHM23], which used strongly invertible slice knots to produce infinite families of new corks. More recently, Dai, Mallick, and Stoffregen [DMS23] provided a new detection of exotic pairs of smooth disks in B^4 by relying on strong inversions of slice knots in S^3 .

1.3. Open Problems. Finally, we would like to list some basic open problems for the future study of the new group $\tilde{\mathcal{C}}_{\mathbb{Q}}$ and the behavior of its elements. The first problem aims to measure the difference between Theorem A and Theorem B.

Problem A. Is every equivariant \mathbb{Q} -slice knot equivariant concordant to a Klein amphichiral knot?

The second problem concerns the structure of $\tilde{\mathcal{C}}_{\mathbb{Q}}$, and we expect affirmative answers to both.

Problem B. Is $\tilde{\mathcal{C}}_{\mathbb{Q}}$ non-abelian? Is $\tilde{\mathcal{C}}_{\mathbb{Q}}$ non-solvable?

The other problem is about the potential complexity of equivariant \mathbb{Q} -slice knots. Following the paper of Boyle and Issa [BI22], recall that given a strongly invertible knot (K, ρ) , the *equivariant 4-genus* \tilde{g}_4 of K is the minimal genus of an orientable, smoothly properly embedded surface $S \subset B^4$ with boundary K for which ρ extends to an involution $\tilde{\rho} : (B^4, S) \rightarrow (B^4, S)$. Previously, using Casson-Gordon invariants, Miller [Mil22] proved that there are \mathbb{Q} -slice knots with arbitrarily large g_4 , namely the classical smooth 4-genus.

Problem C. Are there equivariant \mathbb{Q} -slice knots with arbitrarily large \tilde{g}_4 ?

Theorem B provides a first obstruction to equivariant \mathbb{Q} -sliceness, which can be seen as a first *algebraic concordance* obstruction in this setting. We would like to ask whether it is possible to define other obstructions and invariants, similar to the ones obtained in [Lev69a, Lev69b, Cha07, DP24]. See also Remark 5.

Problem D. Can we define a notion of equivariant algebraic \mathbb{Q} -concordance?

The knot Floer theoretic invariants have had several important applications to the study of knot concordance, see Hom's surveys [Hom17, Hom23] for more details. The two famous invariants $-\tau$ and ϵ are also known to be \mathbb{Q} -concordance invariants. More recently, Dai, Mallick, and Stoffregen [DMS23] also provided several equivariant concordance invariants using knot Floer homology. As a final problem, we would like to ask:

Problem E. Can we define equivariant \mathbb{Q} -concordance invariants using knot Floer homology?

Organization. In §2, we study equivariant \mathbb{Q} -concordances in the broad perspective. We review symmetries of knots and introduce the notion of Klein amphichirality in §2.1. Then, in §2.2, we prove Theorem A. Next, we introduce the equivariant \mathbb{Q} -concordance group in §2.3. In §2.4, we construct equivariant \mathbb{Q} -slice knots by using Klein amphichiral Turk's head knots. Finally, we prove Theorem B in §2.5, and give examples of non-equivariant \mathbb{Q} -slice knots. We close the section by proving Theorem D. In §3, we particularly work on the obstructions. After discussing preliminary notions such as weighted graphs, Gordon-Litherland forms, and moth polynomials, we show independence of certain equivariant \mathbb{Q} -slice knots in $\tilde{\mathcal{C}}$. We finally prove Theorem C.

Acknowledgements. Our project has started during the events Winter Braids XIII in Montpellier and Between the Waves 4 in Besse, so we would like to thank the organizers of both meetings. We are grateful to Leonardo Ferrari for the useful discussions on hyperbolic knot symmetries.

2. EQUIVARIANT \mathbb{Q} -SLICENESS AND \mathbb{Q} -CONCORDANCE

2.1. Symmetries of Knots and Klein Amphichirality. Following Kawachi's book [Kaw96, §10], we consider the following important symmetries of knots. Furthermore, we use the resolution of the Smith conjecture [Wal69, MB84] to identify the fixed point set of a given involution, denoted by $\text{Fix}(\cdot)$. We also set the notation $\text{Diff}(\cdot)$ (resp. $\text{Diff}^+(\cdot)$) for the group of diffeomorphisms (resp. orientation-preserving diffeomorphisms) of a manifold, and $\text{Diff}^-(\cdot) \doteq \text{Diff}(\cdot) \setminus \text{Diff}^+(\cdot)$, i.e., the set of orientation-reversing diffeomorphisms of a manifold.

Definition 2.1. A knot K in S^3 is said to be:

- *invertible* if there is a map $\rho \in \text{Diff}^+(S^3)$ such that $\rho(K) = -K$. If ρ is further an involution, then (K, ρ) is called *strongly invertible*. In this case, we have $\text{Fix}(\rho) = S^1$ and $\text{Fix}(\rho) \cap K = S^0$. Moreover, the knots (K, ρ) and (K', ρ') are called *equivalent* if there is a map $f \in \text{Diff}^+(S^3)$ such that $f(K) = K'$ and $f \circ \rho \circ f^{-1} = \rho'$.
- *negative amphichiral* if there is a map $\tau \in \text{Diff}^-(S^3)$ such that $\tau(K) = -K$. If τ is further an involution, (K, τ) is called *strongly negative amphichiral*. In this case, we have either $\text{Fix}(\tau) = S^0$ or $\text{Fix}(\tau) = S^2$.
- *positive amphichiral* if there is a map $\delta \in \text{Diff}^-(S^3)$ such that $\delta(K) = K$. If δ is further an involution, then (K, δ) is called *strongly positive amphichiral*. In this case, we have $\text{Fix}(\tau) = S^0$.
- *n-periodic* if there is a map $\theta \in \text{Diff}^+(S^3)$ such that $\theta(K) = K$, $\text{Fix}(\theta) \cap K = \emptyset$ and θ is period of n , i.e., n is the minimal number so that $\theta^n = \text{id} \in \text{Diff}^+(S^3)$. If $\text{Fix}(\theta) = S^1$ (resp. $\text{Fix}(\theta) = \emptyset$), then we say that (K, θ) is *cyclically periodic* (resp. *freely periodic*).

In order to compare the symmetries of knots in our new context, we introduce the following crucial notion.

Definition 2.2. A knot K in S^3 is said to be *Klein amphichiral* if there exist two involutions $\rho, \tau : S^3 \rightarrow S^3$ such that

- (K, ρ) is strongly invertible,
- (K, τ) is strongly negative amphichiral,
- $\rho \circ \tau = \tau \circ \rho$.

The *symmetry group* of a knot K in S^3 , which is denoted by $\text{Sym}(S^3, K)$, is defined to be the mapping class group of the knot exterior $S^3 \setminus \nu(K)$, see [Kaw96, §10.6]. Denote by $\text{Sym}^+(S^3, K)$

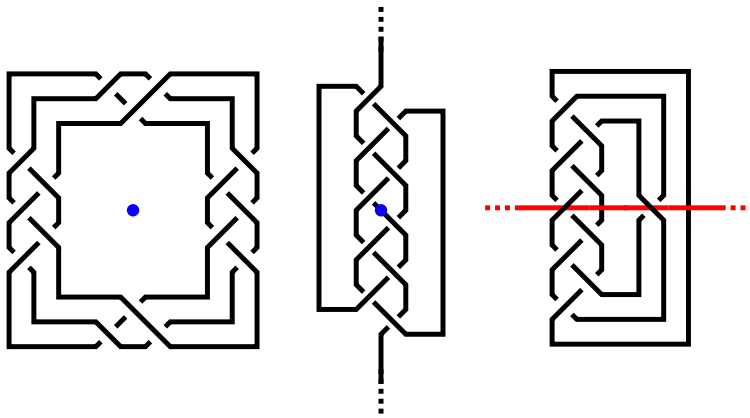

FIGURE 1. From left to right: strongly positive amphichiral, strongly negative amphichiral and strongly invertible symmetries on 10_{123} . In the first two cases, the involution is given by the π -rotation around the blue dot composed with the reflection along the plane of the diagram. The third symmetry is given by the π -rotation around the red axis.

the subgroup consisting of orientation-preserving maps. Observe that since the maps τ and ρ of a Klein amphichiral knot commute, they together generate the *Klein four group*

$$V = \mathbb{Z}/2\mathbb{Z} \times \mathbb{Z}/2\mathbb{Z},$$

hence the composition map $\tau \circ \rho$ is a strongly positive amphichiral involution for K . See Figure 2 for an example of a Klein amphichiral knot.

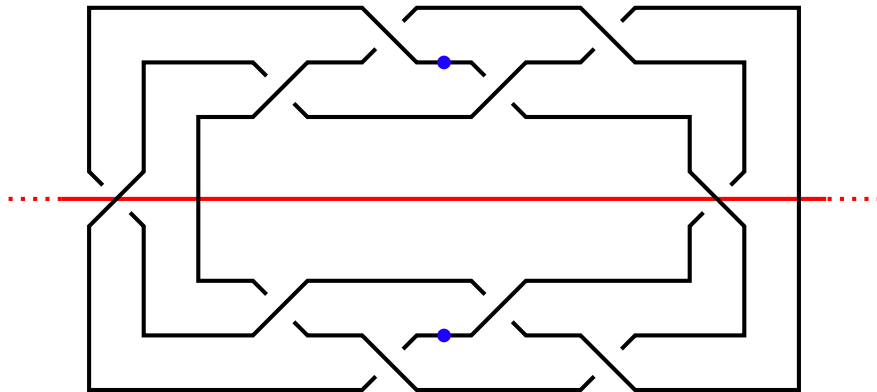

FIGURE 2. Klein amphichiral symmetry on 10_{123} : ρ is given by a π -rotation around the red axis, while τ is the point reflection around the two blue points.

Notice that there exist two distinct types of Klein amphichiral symmetries, distinguished by the fixed point set of τ :

- (1) $\text{Fix}(\tau) \cong S^2$, which forces $K = J\#J^{-1}$ for some DSI knot J ,
- (2) $\text{Fix}(\tau) \cong S^0$.

In the first case, K is clearly equivariant slice, which we will regard as the trivial case. Therefore, we will always assume that the symmetry falls in the second case.

Remark 1. The recent work of Boyle, Rouse, and Williams [BRW23] provided a classification result for symmetries of knots in S^3 . In their terminology, a Klein amphichiral knot corresponds to a D_2 -symmetric knot of type SNASI-(1).

A knot K is called *hyperbolic* if the knot complement $S^3 \setminus \nu(K)$ admits a complete metric of constant curvature -1 and finite volume. Now, we recall the following proposition relating the symmetries of hyperbolic knots with their symmetry groups.

Proposition 2.3. *Let K be a hyperbolic, invertible, and negative amphichiral knot in S^3 . Suppose that $\text{Sym}(S^3, K) = D_{2m}$ with m odd, where D_n is the dihedral group with $2n$ elements. Then K admits a unique strongly invertible involution ρ (up to equivalence, see §2.4) and a strongly negative amphichiral involution τ such that (K, ρ, τ) is Klein amphichiral.*

Proof. Let K be a hyperbolic, invertible and negative amphcheiral knot in S^3 . Since K is a hyperbolic knot, by the work of Kawachi [Kaw79, Lemma 1], we have a pair of strongly negative amphichiral and strongly invertible involutions $\tau, \rho \in \text{Sym}(S^3, K)$ for the knot K . As K is both strongly negative amphichiral and strongly invertible, we know that $\text{Sym}(S^3, K) = D_{2m}$ for some m , due to the result of Kodama and Sakuma [KS92, Lemma 1.1].

Now, assume that $\text{Sym}(S^3, K) = D_{2m} = \langle s, t \mid t^{2m} = s^2 = 1, sts = t^{-1} \rangle$ with m odd. It is a well-known fact that the involutions of D_{2m} split into three conjugacy classes, namely $\{t^m\}$, $\{st^{2i}\}_{0 \leq i < m}$ and $\{st^{2i+1}\}_{0 \leq i < m}$. Since τ and ρ are, respectively, orientation reversing and preserving, they are not conjugate. If one of them corresponds to t^m , which is central, then they commute. Otherwise, they lie respectively in $\{st^{2i}\}_{0 \leq i < m}$ and $\{st^{2i+1}\}_{0 \leq i < m}$ (or vice versa). By changing ρ and τ with some conjugates, we can suppose $\tau = st$ and $\rho = st^{2i}$ so that $2i \equiv 1 \pmod{m}$ (which exists since m is odd). It is now easy to check that $\rho \circ \tau = \tau \circ \rho = t^m$, where t^m is a strongly positive amphichiral involution. Therefore, (K, ρ, τ) is Klein amphichiral. \square

Now we fix a standard model for the Klein amphichiral symmetry. To do so, we can think of $S^3 = \{(z, w) \in \mathbb{C}^2 \mid |z|^2 + |w|^2 = 1\}$. Now consider ρ and τ to be the following involutions

$$\begin{aligned} \rho : S^3 &\rightarrow S^3, & (z, w) &\mapsto (-z, w), \\ \tau : S^3 &\rightarrow S^3, & (z, w) &\mapsto (\bar{z}, -w). \end{aligned}$$

so that

$$(\rho \circ \tau)(z, w) = (-\bar{z}, -w) = (\tau \circ \rho)(z, w).$$

According to [BRW23], up to conjugation in $\text{Diff}^+(S^3)$, we can always suppose that the Klein amphichiral symmetry is given by the action of ρ and τ above. Then the fixed point sets of these involutions are given by

$$\begin{aligned} \text{Fix}(\rho) &= \{(0, w) \mid w \in S^1\}, \\ \text{Fix}(\tau) &= \{(\pm 1, 0)\}, \\ \text{Fix}(\rho \circ \tau) &= \{(\pm i, 0)\}. \end{aligned}$$

Let N_ρ , N_τ , and $N_{\rho\circ\tau}$ be small equivariant tubular neighbourhoods of $\text{Fix}(\rho)$, $\text{Fix}(\tau)$, and $\text{Fix}(\rho \circ \tau)$, respectively. Then we have:

- $N_\rho \cong D^2 \times S^1$ and $\rho|_{N_\rho} = (-\text{id}_{D^2}, \text{id}_{S^1})$,
- $N_\rho \cap K = \{(t \cdot z_i, w_i) \mid t \in [-1, 1]\}$ for some $z_0, z_1, w_0, w_1 \in S^1$,
- $N_\tau \cong B_1^3 \sqcup B_{-1}^3$, where $B_{\pm 1}^3$ is a small ball centered at ± 1 and $\tau|_{B_{\pm 1}^3} = -\text{id}$,
- $B_{\pm 1}^3 \cap K = \{t \cdot p \mid t \in [-1, 1]\}$ for some $p \in S^2$,
- $N_{\rho\circ\tau} \cap K = \emptyset$.

Let $Y = S^3 \setminus \text{int}(N_\rho \cup N_\tau \cup N_{\rho\circ\tau})$. Observe that Y is simply a solid torus with four small balls removed and that $K \cap Y$ consists of four arcs: two of the arcs connect ∂N_ρ to ∂B_1^3 and the other two connect ∂N_ρ to ∂B_{-1}^3 , see Figure 3.

Define $\bar{Y} = Y/V$ to be the quotient of Y by the action of V . It is not difficult to see that \bar{Y} is a non-orientable 3-manifold with boundary, whose boundary components are given as follows: In particular, one can see that $\bar{Y} \cong (\mathbb{RP}^2 \times I) \natural (\mathbb{RP}^2 \times I)$.

- a Klein bottle, which is the image of the toric boundary component of Y , denoted by A ,
- two \mathbb{RP}^2 's, which are the images of ∂N_τ and $\partial N_{\rho\circ\tau}$, respectively. Denote the image of N_τ by B .

In particular, one can see that $\bar{Y} \cong (\mathbb{RP}^2 \times I) \natural (\mathbb{RP}^2 \times I)$. Now, denote the image of $K \cap Y$ in \bar{Y} by \bar{K} . Then \bar{K} is a simple properly embedded arc in \bar{Y} starting at A and ending in B , see Figure 4.

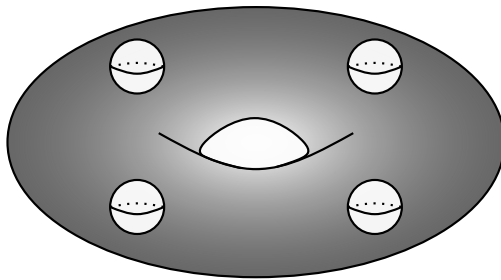
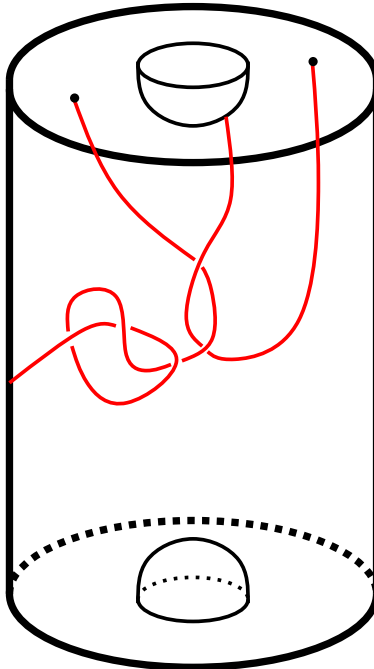
FIGURE 3. The manifold Y , given by removing the fixed point sets.FIGURE 4. The quotient manifold \bar{Y} . Both the upper and lower punctured disks are glued to themselves by $-\text{id}$. In red, there is an example of an arc \bar{K} going from the Klein bottle boundary component to one \mathbb{RP}^2 boundary component.

Define now

$$\pi_1(\bar{Y}, A, B) = \{\gamma : [0, 1] \rightarrow \bar{Y} \mid \gamma(0) \in A, \gamma(1) \in B\} / \text{homotopy}.$$

Notice that every class in $\pi_1(\bar{Y}, A, B)$ can be represented by a simple properly embedded arc. Observe that any homotopy between two properly embedded arcs in \bar{Y} connecting A to B is lifted to an equivariant homotopy in Y . This can be closed up to an equivariant homotopy between the corresponding Klein amphichiral knots in S^3 in the following way. Let γ_t be the lift of the homotopy at time t . Then γ_t is given by four proper arcs in Y invariant under the action of V . We extend the homotopy over N_ρ and N_τ following the local models described above. Observe that $\gamma_t \cap \partial N_\rho$ is given by 4 points: $(z_0, w_0), (-z_0, w_0), (z_1, w_1), (-z_1, w_1) \in S^1 \times S^1$. We connect then the components of γ_t by adding the arcs $(s \cdot z_0, w_0)$ and $(s \cdot z_1, w_1)$, $s \in [-1, 1]$ inside N_ρ .

Similarly, consider the intersection $\gamma_t \cap \partial N_\tau$, which is given by four points $p, -p \in \partial B_{+1}^3$ and $q, -q \in \partial B_{-1}^3$. Then the components of γ_t are connected by adding the arcs $\{s \cdot p\}_{s \in [-1, 1]} \subset B_{+1}^3$ and $\{s \cdot q\}_{s \in [-1, 1]} \subset B_{-1}^3$. In this way, we obtain an equivariant homotopy of Klein amphichiral knots in S^3 .

We can sum up the discussion above in the following lemma:

Lemma 2.4. *The natural map*

$$\{\text{Klein amphichiral knots}\}/\text{equivariant homotopy} \longrightarrow \pi_1(\overline{Y}, A, B)$$

is a bijection.

In order to prove the refinement of Levine's theorem given in Theorem A, the essential ingredient is the following lemma.

Lemma 2.5. *Every Klein amphichiral knot can be turned into the standard Klein amphichiral unknot by a finite number of V -equivariant crossing changes.*

Proof. Let K_0 and K_1 be two Klein amphichiral knots, and let $\overline{K_0}$ and $\overline{K_1}$ be the corresponding arcs in \overline{Y} . Suppose that there exists a homotopy $\overline{K_t}$, $t \in [0, 1]$ between $\overline{K_0}$ and $\overline{K_1}$. Then up to a small perturbation, we can suppose that $\overline{K_t}$ is a simple properly embedded arc connecting A to B for all $t \in [0, 1]$ except for finitely many times, for which $\overline{K_t}$ has a point of double transverse self-intersection.

Let K_t , $t \in [0, 1]$ be the corresponding homotopy between K_0 and K_1 . Then for all t , we have that K_t is a Klein amphichiral knot, except at finitely many times, for which it has some points of double transverse self-intersection. Such double points either arise from the double points of $\overline{K_t}$ or they might come from the closing up procedure of the homotopy described above. Using the notation in the discussion above, for example, it might happen that $w_0 = w_1$, leading to a new double point inside N_ρ during the homotopy.

Thus, it suffices to show that $\pi_1(\overline{Y}, A, B)$ consists of a single point. For this purpose, pick two points $p \in A$ and $q \in B$, and consider the set

$$\pi_1(\overline{Y}, p, q) = \{\gamma : [0, 1] \rightarrow \overline{Y} \mid \gamma(0) = p, \gamma(1) = q\}/\text{homotopy}.$$

Notice that since A and B are connected, the natural map

$$\iota : \pi_1(\overline{Y}, p, q) \rightarrow \pi_1(\overline{Y}, A, B)$$

induced by the inclusion is surjective. Observe then that

- both $\pi_1(A, p)$ and $\pi_1(B, q)$ act on $\pi_1(\overline{Y}, p, q)$ by pre-composition and post-composition, respectively,
- the image of a class under ι is not changed by the action of $\pi_1(A, p)$ and $\pi_1(B, q)$.

This reduces our argument to show that the combined action of $\pi_1(A, p)$ and $\pi_1(B, q)$ is transitive on $\pi_1(\overline{Y}, p, q)$, which is a consequence of the following two facts:

- $\pi_1(\overline{Y}, p)$ acts transitively on $\pi_1(\overline{Y}, p, q)$ by pre-composition,
- $\pi_1(\overline{Y}) = \langle \pi_1(A), \pi_1(B) \rangle$.

Therefore, $\pi_1(\overline{Y}, A, B) = \{*\}$, as we desired. \square

2.2. The Equivariant \mathbb{Q} -Slice Knots. An *equivariant \mathbb{Q} -slice slice knot* is a strongly invertible knot (K, ρ_K) in S^3 that bounds a disk D smoothly properly embedded in a \mathbb{Q} -homology 4-ball (a 4-manifold having the \mathbb{Q} -homology of B^4) with an orientation preserving involution $\rho : W \rightarrow W$ such that

$$\partial D = K, \quad \rho|_{\partial W = S^3} = \rho_K, \quad \text{and} \quad \rho(D) = D,$$

cf. the conditions (3) and (4) below.

Recall that Kawachi's famous result [Kaw09, §2] provided a characterization for \mathbb{Q} -slice knots, showing that every strongly negative amphichiral knot is \mathbb{Q} -slice. Now, we prove an equivariant refinement of Kawachi's theorem by proving that every Klein amphichiral knot is equivariant \mathbb{Q} -slice. This is essentially the first half of Theorem A.

Proof of Theorem A, the 1st half. Consider the product extension of ρ and τ on $S^3 \times [0, 1]$, which we will still denote them using the same letters.

Let X_K be the 4-manifold obtained from $S^3 \times [0, 1]$ by attaching a 0-framed 2-handle along $K \subset S^3 \times \{1\}$. We can find a $\langle \rho, \tau \rangle$ -invariant neighbourhood $N(K) \cong S^1 \times D^2$ of K such that

- $\rho(z, w) = (\bar{z}, \bar{w})$, for $(z, w) \in S^1 \times D^2$,

- $\tau(z, w) = (\bar{z}, -w)$ for $(z, w) \in S^1 \times D^2$.

Therefore, we can extend ρ and τ over the 2-handle $D^2 \times D^2$ by using the obvious extensions of the formulas above. Denote the core disk of the 2-handle by $D = D^2 \times \{0\}$. Observe in particular that $\rho(D) = D$.

Let $S_0^3(K)$ be the 0-surgery of K . Notice that the restriction of τ on the $S_0^3(K)$ component of ∂X_K is fixed-point free and orientation-reversing. Therefore, we can glue X_K to itself by identifying $x \sim \tau(x)$ for all $x \in S_0^3(K)$, and obtain an oriented 4-manifold Z_K with $\partial Z_K = S^3$, namely the Kawauchi manifold.

Let D' be the disk obtained by gluing the product cylinder $K \times [0, 1]$ with D . In [Kaw09, Lemma 2.3, Theorem 1.1], Kawauchi proves that D' is a slice disk for K in Z_K , and Z_K is a \mathbb{Q} -homology 4-ball.

Finally, since ρ and τ commute, the action of ρ on X_K induces an involution ρ_{Z_K} on Z_K such that $\rho_{Z_K}(D') = D'$. This shows that D' is actually an equivariant slice disk for (K, ρ) in Z_K . Therefore, (K, ρ) is equivariantly \mathbb{Q} -slice in the Kawauchi manifold $Z_K = Z$. \square

Due to its construction, a priori the Kawauchi manifold Z seems to depend on the strongly negative amphichiral knot. However, Levine [Lev23] proved that Z is a unique manifold in the sense that all strongly negative amphichiral knots bound smooth disks in Z . Our proof extends Levine's theorem to the equivariant case by showing that every Klein amphichiral knot (K, ρ, τ) bounds an equivariant disk in (V, ρ_K) , where ρ_K is an involution extending ρ . This is the remaining part of Theorem A.

Proof of Theorem A, the 2nd half. Observe that Levine's original proof [Lev23] has three main ingredients: a 5-dimensional handlebody argument, an equivariant unknotting theorem of Boyle and Chen [BC24, Proposition 3.12], and the equivariant isotopy extension theorem of Kankaanrinta [Kan07, Theorem 8.6].

The first and last ingredients are essentially the same for our extended argument. In this setting, the second ingredient is simply replaced by Lemma 2.5. \square

2.3. The Equivariant \mathbb{Q} -Concordance Group. A *direction* on a given strongly invertible knot (K, ρ) is a choice of oriented *half-axis* h , i.e. the choice of an oriented connected component of $\text{Fix}(\rho) \setminus K$. We will call a triple (K, ρ, h) a *directed strongly invertible knot* (a *DSI knot* in short).

We say that two DSI knots (K_0, ρ_0, h_0) and (K_1, ρ_1, h_1) are *equivariantly isotopic* if there exists $\varphi \in \text{Diff}^+(S^3)$ such that $\varphi(K_0) = K_1$, $\varphi \circ \rho_0 = \rho_1 \circ \varphi$ and $\varphi(h_0) = h_1$ as oriented half-axes. Given two DSI knots (K_0, ρ_0, h_0) and (K_1, ρ_1, h_1) , we may form *equivariant connected sum* operation $\tilde{\#}$, introduced by Sakuma [Sak86, §1]. This yields a potentially new DSI knot $(K_0 \tilde{\#} K_1, \rho_0 \tilde{\#} \rho_1, h_0 \tilde{\#} h_1)$ whose oriented half-axis starts from the tail of the half-axis for K_0 and ends at the head of the half-axis for K_1 , see Figure 5.

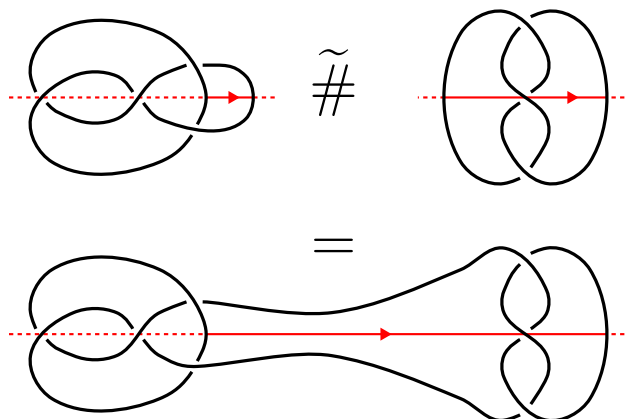

FIGURE 5. An example of equivariant connected sum.

Let (K_0, ρ_0, h_0) and (K_1, ρ_1, h_1) be two DSI knots in S^3 . We call (K_0, ρ_0, h_0) and (K, ρ_1, h_1) *equivariant \mathbb{Q} -concordant* and denote it by

$$(K_0, \rho_0, h_0) \sim_{\mathbb{Q}} (K, \rho_1, h_1)$$

if there is a pair of smooth manifolds (W, A) satisfying the following conditions:

- (1) W is a \mathbb{Q} -homology cobordism from S^3 to itself, i.e., $H_*(W; \mathbb{Q}) \cong H_*(S^3 \times [0, 1]; \mathbb{Q})$,
- (2) A is a submanifold of W with $A \cong S^1 \times [0, 1]$ and $\partial A \cong -(K_0) \cup K_1$,
- (3) There is an involution $\rho_W : W \rightarrow W$ that extends ρ_0 and ρ_1 , and has $\rho_W(A) = A$,
- (4) Denote by F the fixed-point surface of ρ_W . Then the half-axes h_0, h_1 lie in the same boundary component of $F - A$ and their orientations induce the same orientation on $F - A$.

Remark 2. Observe that if W as above is not a $\mathbb{Z}/2\mathbb{Z}$ -homology cobordism then $\text{Fix}(\rho_W)$ might not be an annulus. This implies that the equivariant \mathbb{Q} -sliceness for a directed strongly invertible knot is not equivalent to the equivariant \mathbb{Q} -sliceness of its *butterfly link* (see Definition 3.9) or *moth link* (see [DPF23b, Definition 5.2]), contrary to the non-rational case, as proved in [BI22, Proposition 4.2] and [DPF23b, Proposition 5.4]. As a consequence, several invariants obtained from these links, such as the butterfly and moth polynomial, do not automatically vanish for equivariant \mathbb{Q} -slice knots (compare with the computations in Section 3.2).

As a natural extension of the equivariant concordance group $\tilde{\mathcal{C}}$ defined by Sakuma [Sak86, §4] (see also Boyle and Issa [BI22, §2]), we introduce the *equivariant \mathbb{Q} -concordance group* $\tilde{\mathcal{C}}_{\mathbb{Q}}$ as

$$\tilde{\mathcal{C}}_{\mathbb{Q}} \doteq \left(\left\{ \text{DSI knots in } S^3 \right\} / \sim_{\mathbb{Q}}, \tilde{\#} \right).$$

We have the following main properties:

- The operation is induced by the equivariant connected sum $\tilde{\#}$.
- The identity element is the equivariant \mathbb{Q} -concordance class of the unknot $(U, \rho_U, h_U)^1$, see Figure 6.
- The inverse element for (K, ρ, h) is given by axis-inverse of the mirror of K , i.e., $(\bar{K}, \rho, -h)$.

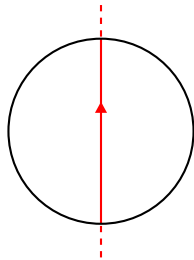

FIGURE 6. The DSI unknot.

2.4. A Construction for Equivariant \mathbb{Q} -Slice Knots. In this subsection, we construct examples of equivariant \mathbb{Q} -slice knots. We now introduce the first family of examples which are obtained by using the following doubling argument.

Given an oriented knot K , its *double* $\tau(K)$ is the DSI knot obtained by $K \# r(K)$, (where $r(K)$ is the *reverse* of K , i.e. the same knot but oppositely oriented) with the involution ρ that exchanges K and $r(K)$ (namely the π -rotation around the vertical axis in Figure 7. The direction on $\tau(K)$ is given as follows: the connected sum can be performed by a suitable band move along a grey band B where $\text{Fix}(\rho) \cap B$ is the half-axis h . Here, h is oriented as the portion of B lying on K .

As proven by Boyle and Issa [BI22, §2], τ defines an injective homomorphism $\tau : \mathcal{C} \rightarrow \tilde{\mathcal{C}}$. The same argument actually shows that τ also induces a homomorphism $\tau_{\mathbb{Q}} : \mathcal{C}_{\mathbb{Q}} \rightarrow \tilde{\mathcal{C}}_{\mathbb{Q}}$ (not necessarily injective), which fits into the following commutative diagram

¹The unknot U in S^3 has a unique strong inversion, see [Sak86, Definition 1.1, Lemma 1.2].

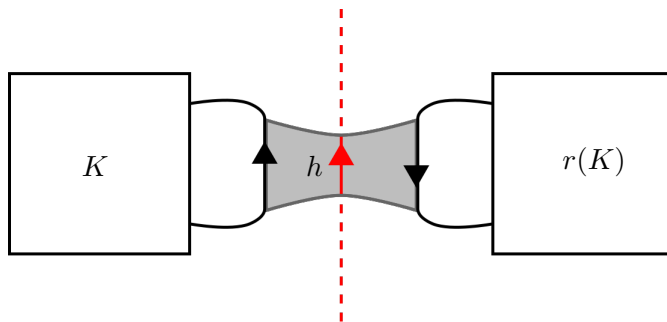
 FIGURE 7. The DSI knot $\mathfrak{r}(K)$ with the solid chosen half-axis.

$$\begin{array}{ccc} \mathcal{C} & \xrightarrow{\mathfrak{r}} & \tilde{\mathcal{C}} \\ \downarrow \psi & & \downarrow \Phi \\ \mathcal{C}_{\mathbb{Q}} & \xrightarrow{\mathfrak{r}_{\mathbb{Q}}} & \tilde{\mathcal{C}}_{\mathbb{Q}} \end{array}$$

Therefore, the first family of DSI knots are trivial in the sense that they lie in the $\text{Ker}(\Phi)$ and are simply given by the image of $\text{Ker}(\psi)$ under \mathfrak{r} .

It is known that the algebraic structure of $\text{Ker}(\psi)$ is very complicated. In particular, $\text{Ker}(\psi)$ contains a $\mathbb{Z}^{\infty} \oplus (\mathbb{Z}/2\mathbb{Z})^{\infty}$ subgroup due to the work of Cha [Cha07] and Hom, Kang, Park, and Stoffregen [HKPS22].

At the moment, the structure of $\tilde{\mathcal{C}}$ is quite mysterious. The first author proves that $\tilde{\mathcal{C}}$ is non-abelian [DP23] and together with Framba that $\tilde{\mathcal{C}}$ is also non-solvable [DPF23b]. He also observes in [DP24, Corollary 1.16] that the equivariant concordance group splits as the following direct sum

$$\tilde{\mathcal{C}} = \text{Ker}(\mathfrak{b}) \oplus \mathfrak{r}(\mathcal{C}),$$

where $\text{Ker}(\mathfrak{b})$ is the subgroup of $\tilde{\mathcal{C}}$ formed by DSI knots K such that their 0-butterfly links $L_b^0(K)$ (see Definition 3.9 and [BI22]) have slice components (but they are not necessarily slice as links).

Now, we construct the non-trivial examples of equivariant \mathbb{Q} -slice knots in S^3 . Let

$$\mathcal{J} = \{n \in \mathbb{N} \mid n > 1 \text{ and } n \not\equiv 0 \pmod{3}\}.$$

We can write

$$\mathcal{J} = \mathcal{J}_{\text{even}} \sqcup \mathcal{J}_{\text{odd}} = \{n \in \mathcal{J} \mid n \text{ is even}\} \sqcup \{n \in \mathcal{J} \mid n \text{ is odd}\}.$$

Definition 2.6. For $n \in \mathcal{J}$, the Turk's head knots $J_n = \text{Th}(3, n)$ are defined as the 3-braid closures

$$J_n \doteq \widehat{(\sigma_1 \sigma_2^{-1})^n},$$

where a single 3-braid $\sigma_1 \sigma_2^{-1}$ is depicted as follows:

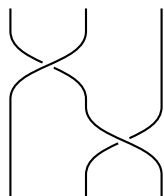

The Turk's head knots J_n are known to be alternating, cyclically n -periodic, fibered, hyperbolic, prime, strongly invertible, strongly negative amphichiral, see our recent survey paper [DPS24].

Using Knotinfo [LM24] and Knotscape [HT24], we can identify the Turk's head knots J_n with small number of crossings. In particular, we have

$$J_2 = 4_1, \quad J_4 = 8_{18}, \quad J_5 = 10_{123}, \quad J_7 = 14_{a19470}, \quad \text{and}, \quad J_8 = 16_{a275159}.$$

We will need the following three important properties of J_n . Their symmetry groups were computed by Sakuma and Weeks [SW95, Proposition I.2.5]. The recent work of AlSukaiti and Chbili [AC24, Corollary 3.5, Proposition 5.1] provided their determinants and the roots of their Alexander polynomials. For more references, one can consult our recent survey [DPŞ24].

(1) For a fixed value of n , we have

$$\mathrm{Sym}(S^3, J_n) \cong D_{2n},$$

where $D_m \cong \mathbb{Z}/m\mathbb{Z} \rtimes \mathbb{Z}/2\mathbb{Z}$ denotes the dihedral group of $2m$ elements.

(2) Let L_k denote the k^{th} Lucas number.² Then we have

$$\det(J_n) = \Delta_{J_n}(-1) = L_{2n} - 2.$$

(3) The roots of the Alexander polynomial $\Delta_{J_n}(t)$ are of the form:

$$z = -\frac{1}{2} \left(2 \cos \left(\frac{2k}{n} \pi \right) - 1 \pm \sqrt{\left(2 \cos \left(\frac{2k}{n} \pi \right) - 1 \right)^2 - 4} \right),$$

with $1 \leq k \leq \lfloor n/2 \rfloor$.

In the following proposition, we explicitly determine the number of strong inversions for the Turk's head knots J_n .

Proposition 2.7. *The Turk's head knot J_n has at most two inequivalent (i.e. not conjugate in $\mathrm{Sym}^+(S^3, J_n)$) strong inversions, say ρ_1 and ρ_2 . In particular,*

- if $n \in \mathcal{J}_{\mathrm{odd}}$, then the strong inversion is unique and J_n is Klein amphichiral,
- if $n \in \mathcal{J}_{\mathrm{even}}$, then J_n has exactly two inequivalent strong inversions, which are conjugated by an element of $\mathrm{Sym}(S^3, J_n)$.

Proof. According to [Sak86, Proposition 3.4] J_n admits at most two inequivalent strong inversion, since it is invertible, amphichiral and hyperbolic. More precisely, Sakuma proved that the followings are equivalent:

- J_n admits a period 2 symmetry,
- ρ_1 and ρ_2 are not equivalent.

Since by property 1 we have $\mathrm{Sym}(S^3, J_n) \cong D_{2n}$ and n is odd, we know that we only have three conjugacy classes of involutions in $\mathrm{Sym}(S^3, J_n)$. By Proposition A these classes are exactly given by a strongly inversion ρ and a strongly negative and positive amphichiral involutions τ and δ . In particular, J_n cannot admit a period 2 symmetry (cf. [KS92, p. 332]). In Figure 8 we can explicitly see that the maps τ and ρ commute. Therefore, ρ is the unique strong inversion.

On the other hand, if n is even, then J_n admits an obvious a period 2 symmetry, which can be seen, for example from the braid description in Definition 2.6. Therefore, ρ_1 and ρ_2 are inequivalent strong inversions. \square

Remark 3. We fix here the choice of direction on J_n for n odd. We will always consider J_n as a DSI knot with the involution ρ given by the π -rotation around the red axis in Figure 8 and the chosen half-axis h is the bounded one in the figure, oriented from left to right. In the following, we will omit to recall these choices. Observe that the strongly negative amphichiral involution τ (see 8) maps the DSI knot (J_n, ρ, h) to $(\overline{J_n}, \rho, -h')$, where $-h'$ is the complementary half-axis endowed with the opposite orientation. Therefore, while in general these choices would be relevant for the computations in Section 3, in this specific case, changing the DSI structure would change the invariants computed in Section 3 at most by a sign.

Corollary 2.8. *If $n \in \mathcal{J}_{\mathrm{odd}}$, then the Turk's head knots J_n are equivariant \mathbb{Q} -slice.*

Proof. We know that J_n is always strongly negative amphichiral. Since $n \in \mathcal{J}_{\mathrm{odd}}$, by Proposition 2.7, the knots (J_n, ρ, τ) are all Klein amphichiral. Then from Theorem A we know that (J_n, ρ) is equivariantly \mathbb{Q} -slice. \square

²The Lucas numbers are defined recursively as $L_0 = 2, L_1 = 1$, and $L_k = L_{k-1} + L_{k-2}$ for $k \geq 2$.

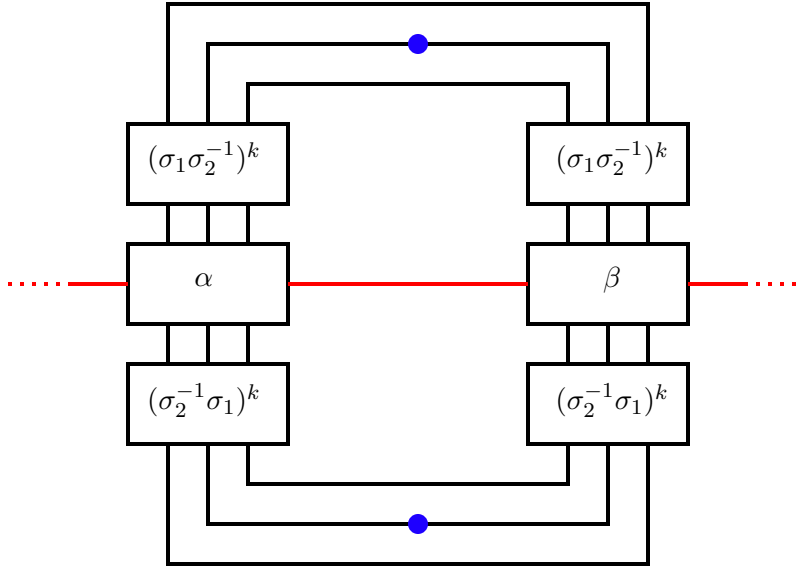

FIGURE 8. The Turk's head knot J_n for n odd. If $n = 4k + 1$ then $\alpha = \sigma_1$ and $\beta = \sigma_2^{-1}$, while for $n = 4k - 1$ we have $\alpha = \sigma_2$ and $\beta = \sigma_1^{-1}$. Its Klein amphichiral symmetry is represented in Figure 2.

Remark 4. Let $\gcd(p, q) = 1$. If p and q are both odd integers, then the Turk's head knots $Th(p, q)$ are strongly invertible and strongly negative amphichiral, see [DPS24, §3.4]. A positive answer to [DPS24, Conjecture B] would also prove that the knots $Th(p, q)$ are all equivariant \mathbb{Q} -slice.

2.5. An Obstruction for Equivariant \mathbb{Q} -Slice Knots. In this subsection, we prove an equivariant rational version of the classical Fox-Milnor condition, which is a generalization of the result by Cochran, Franklin, Hedden, and Horn [CFHH13]. Here, we normalize the Alexander polynomial of a knot K such that

$$\Delta_K(1) = 1 \quad \text{and} \quad \Delta_K(t) = \Delta_K(t^{-1}).$$

Now, we prove Theorem B, claiming that the Alexander polynomial of an equivariant \mathbb{Q} -slice knot must be square.

Proof of Theorem B. Let (K, ρ) be an equivariant \mathbb{Q} -slice knot with a slice disk $D \subset Z$ in a \mathbb{Q} -homology 4-ball Z and let ρ be an involution on Z extending ρ_K such that $\rho(D) = D$. Let $Z_D = Z \setminus N(D)$ be the equivariant slice disk exterior, where $N(D)$ is a ρ -invariant tubular neighborhood of D . Denote the inclusion of the boundary by $i : \partial Z_D \cong S_0^3(K) \rightarrow Z_D$.

Since $H_1(Z_D; \mathbb{Q}) = H_1(S^1 \times B^3; \mathbb{Q})$, we have $H_1(Z_D; \mathbb{Z})/\text{torsion} \cong \mathbb{Z}$. Let

$$\phi : \pi_1(Z_D) \rightarrow \mathbb{Z}$$

be the projection map on the homology modulo torsion. Given a space X and a map $\epsilon : \pi_1(X) \rightarrow \mathbb{Z} = \langle t \rangle$ we denote by $H_*(X, \epsilon)$ the integral homology of X twisted by ϵ , which is naturally a $\mathbb{Z}[t^{\pm 1}]$ -module. By [CFHH13, Proposition 4.6], the order of $H_1(S_0^3(K), \phi \circ i)$ is $\Delta_K(t^n)$ where n is the complexity of the slice disk, i.e., the absolute value of the element represented by a meridian of D in $H_1(Z_D; \mathbb{Z})/\text{torsion} \cong \mathbb{Z}$. Let M be the kernel of

$$i_* : H_1(S_0^3(K), \phi \circ i) \rightarrow H_1(Z_D, \phi),$$

and denote its order by $f(t)$. Then, by using [CFHH13, Proposition 4.5], we see that $\Delta_K(t^n) = f(t)f(t^{-1})$. Now, observe that $\phi \circ \rho_* = (-id) \circ \phi$ as follows:

$$\begin{array}{ccc} \pi_1(Z_D) & \xrightarrow{\phi} & \mathbb{Z} \\ \rho_* \downarrow & & \downarrow -id \\ \pi_1(Z_D) & \xrightarrow{\phi} & \mathbb{Z} \end{array}$$

Therefore the order of $\rho(M)$ is $f(t^{-1})$. Since the inclusion map i is ρ -equivariant we have that $\rho(M) = M$, hence $f(t) = f(t^{-1})$. Hence $\Delta_K(t^n)$ is a square. In turn, this implies that $\Delta_K(t)$ is also a square. \square

Using the equivariant Fox-Milnor condition in Theorem B, we now prove that the other half of the knots J_n are not trivial in $\tilde{\mathcal{C}}_{\mathbb{Q}}$.

Proposition 2.9. *If $n \in \mathcal{J}_{\text{even}}$, then the Turk's head knots J_n are not equivariant \mathbb{Q} -slice.*

Proof. It is a well-known fact that Lucas numbers satisfy the following equality:

$$(L_n)^2 = L_{2n} + (-1)^n \cdot 2.$$

If $n \in \mathcal{J}_{\text{even}}$, then $\det(J_n) = L_{2n} - 2 = (L_n)^2 - 2$ by the identity (2). Since the determinant is not a perfect square, for an arbitrary n , J_n is not equivariant \mathbb{Q} -slice by Theorem B. \square

Generalizing Kirby calculus argument by Fintushel and Stern [FS84], in [Cha07, Theorem 4.14] Cha exhibits a family of infinitely many \mathbb{Q} -slice knots K_n in S^3 , depicted in Figure 9. Since the knots K_n are clearly strongly negative amphichiral (see [Cha07, Figure 5]), Cha's result can be reproven by Kawauchi's characterization. Note that K_1 is the figure-eight knot.

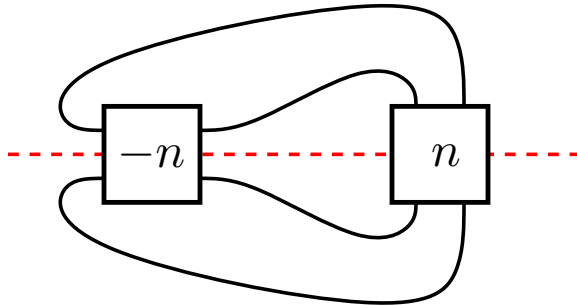

FIGURE 9. The knots K_n . The square box with the integer n (resp. $-n$) represents the right-handed (resp. the left-handed) n full twists. The strong inversion is the π -rotation around the dashed axis.

Now, we are ready to prove Theorem D, showing that Cha's knots K_n are also not equivariant \mathbb{Q} -slice.

Proof of Theorem D. Assume that K_n is equivariant \mathbb{Q} -slice for each $n \geq 1$. By [Cha07, Theorem 4.14]), we know that

$$\Delta_{K_n}(t) = -n^2 t^{-1} + 2n^2 + 1 - n^2 t.$$

Then we get

$$\det(K_n) = \Delta_{K_n}(-1) = 4n^2 + 1 = (2n^2)^2 + 1.$$

Then, by Theorem B, the determinant must be a square, which is a contradiction. Therefore, the knots K_n are not equivariant \mathbb{Q} -slice.

Let H be the subgroup of $\tilde{\mathcal{C}}_{\mathbb{Q}}$ spanned by K_n for $n \geq 1$ (fix any choice of strong inversion and direction on K_n). Let $K = \#^{a_1} K_{n_1} \# \dots \#^{a_l} K_{n_l}$, where the equivariant connected sum is taken with respect to any ordering of the knots.

Since the polynomials $\Delta_{K_n}(t)$ are quadratic, it is not difficult to check that they are pairwise coprime. Therefore, $\Delta_K(t)$ is a square if and only if $a_i = 0 \pmod{2}$ for $i = 1, \dots, l$. Hence, the group H surjects onto $(\mathbb{Z}/2\mathbb{Z})^\infty$. \square

Remark 5. One can easily check by using the so-called *equivariant signature jumps homomorphism* $\tilde{J}_\lambda : \tilde{\mathcal{C}} \rightarrow \mathbb{Z}$ introduced in [DP24, Definition 6.1] and by applying [DP24, Theorem 6.9] that the knots K_n span a subgroup of $\tilde{\mathcal{C}}$ which surjects onto \mathbb{Z}^∞ . As the classical Levine-Tristram signatures provide invariants of \mathbb{Q} -concordance (see [CK02]), we expect the maps \tilde{J}_λ to factor through $\tilde{\mathcal{C}}_{\mathbb{Q}}$. This would prove that the subgroup $H \subset \tilde{\mathcal{C}}_{\mathbb{Q}}$ described in the proof of Theorem D would actually surject onto \mathbb{Z}^∞ . Compare with Problem D.

3. PROOF OF THEOREM C

In this section, we recall some preliminary notions and we prove the intermediate results needed in order to prove Theorem C.

3.1. Weighted Graphs, Spanning Trees and Gordon-Litherland form. In this subsection, we recall some useful results about the Gordon-Litherland form and graph theory.

Definition 3.1. A *weighted graph* $\Gamma = (V, E)$ is a simple graph with vertex set V and edges E with the additional data of a *weight* $\lambda_e = \lambda_{ij} = \lambda_{ji} \in \mathbb{R}$, if there exists $e \in E$ connecting $i, j \in V$. If two vertices are not connected by an edge the weight is understood to be zero. We associate a *Laplacian matrix* $\mathcal{L}(\Gamma)$ for each weighted graph by letting

$$\mathcal{L}(\Gamma)_{i,j} = \begin{cases} -\lambda_{ij} & \text{if } i \neq j \\ \sum_{k \neq i} \lambda_{ik} & \text{if } i = j. \end{cases}$$

In the following, we will denote by $\mathcal{L}(\Gamma; i)$ the square matrix obtained from $\mathcal{L}(\Gamma)$ by removing the i -th column and row.

Definition 3.2. Let $\Gamma = (V, E)$ be a weighted graph. A *spanning tree* of G is subgraph $T = (V_T, E_T)$ of Γ such that

- T is a tree,
- the vertex set of T is equal to V .

We denote the *weight* of T by

$$w(T) = \prod_{e \in E_T} \lambda_e.$$

Finally, we define the (*weighted*) *number of spanning trees* of Γ as

$$\mathcal{T}(\Gamma) = \sum_{T \subset \Gamma \text{ spanning tree}} w(T).$$

Theorem 3.3. [Tut01, Theorem VI.29] *Let $\Gamma = (V, E)$ be a weighted graph. Then for every $i \in V$, we have*

$$\det(\mathcal{L}(\Gamma; i)) = \mathcal{T}(\Gamma).$$

Theorem 3.4. [HJ85, Theorem 6.1.1 (Gershgorin's Theorem)] *Let $A = (a_{i,j})$ be a $n \times n$ square complex matrix, and denote by $R_i(A) = \sum_{j \neq i} |a_{i,j}|$. Then the eigenvalues of A are contained in the following set*

$$\bigcup_i \{z \in \mathbb{C} \mid |z - a_{i,i}| \leq R_i(A)\}.$$

Definition 3.5. Let $A = (a_{i,j})$ be as above. We say that A is *dominant diagonal* if for every $1 \leq i \leq n$ we have

$$|a_{i,i}| \geq R_i(A).$$

Moreover, if there exist i such that $|a_{i,i}| > R_i(A)$ then we say that A is *strongly dominant diagonal*.

Corollary 3.6. *If $A = (a_{i,j})$ is a symmetric matrix and strongly dominant diagonal matrix with positive entries on the diagonal then A is positive definite.*

Example 3.1. Let $\Gamma = (V, E)$ be a connected and weighted graph such that $\lambda_e > 0$ for every $e \in E$. Then for every $i \in V$ the matrix $\mathcal{L}(\Gamma; i)$ is strongly dominant diagonal and all the diagonal entries are positive, hence $\mathcal{L}(\Gamma; i)$ is positive definite.

Definition 3.7. Let $\Gamma = (V, E)$ be a weighted graph. Given an edge $e \in E$ we denote by $\Gamma \setminus e = (V, E \setminus e)$ the weighted graph obtained from Γ by *edge deletion* of e . Let i, j be the endpoints of e . We define $\Gamma/e = (\bar{V}, \bar{E})$ as the graph obtained from Γ by *edge contraction* of e , where

- $\bar{V} = V/i \sim j$,
- if $e \in E$ has endpoints $h, k \in V \setminus \{i, j\}$ then $e \in \bar{E}$ with the same label,
- for every $h \in V \setminus \{i, j\}$ there is an edge $e \in \bar{E}$ joining $[i \sim j]$ to h of weight $\lambda_e = \lambda_{ih} + \lambda_{jh}$.

Theorem 3.8 ([Tut04]). *Let $\Gamma = (V, E)$ be a weighted graph. Then for every $e \in E$, we have*

$$\mathcal{T}(\Gamma) = \mathcal{T}(\Gamma \setminus e) + \lambda_e \cdot \mathcal{T}(\Gamma/e).$$

3.1.1. *Gordon-Litherland Form.* Let $L \subset S^3$ be a link and let $D \subset S^2$ be a connected diagram for L . Recall that by coloring $S^2 \setminus D$ in a checkerboard fashion, we determine two spanning surfaces for L . Denote by F the surface given by the black coloring.

Then, we can describe the *Gordon-Litherland form* conveniently in terms of a weighted graph $\Gamma = (V, E)$ associated with F , as follows. See [GL78] for more details. Let V be the set of white regions of D . Given two white regions R_1, R_2 , we have an edge e connecting them if they share at least one crossing of D . The label of e is given by the sum over all the crossing of D shared by R_1 and R_2 of $+1$ for a right-handed half-twist and -1 for a left-handed half-twist (see Figure 10).

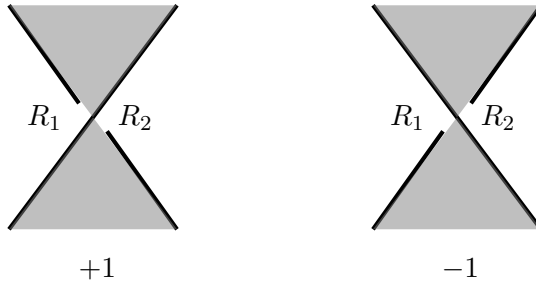

FIGURE 10. Sign convention for the crossings.

Then, for any $R \in V$ the matrix $\mathcal{L}(\Gamma; R)$ represents the Gordon-Litherland form of F . In particular, the determinant of the link L is given by the absolute value of $\det(\mathcal{L}(\Gamma; R)) = \mathcal{T}(\Gamma)$.

3.2. **Butterfly and Moth Links.** We are now going to recall the definition of *n-butterfly link* that is defined by the first author in [DP23] as a generalization of the *butterfly link* introduced by Boyle and Issa in [BI22].

Definition 3.9. Let (K, ρ, h) be a DSI knot. Take a ρ -invariant band B , containing the half-axis h , which attaches to K at the two fixed points. Performing a band move on K along B produces a 2-component link, which has a natural semi-orientation induced by the unique semi-orientation on K . The linking number between the components of the link depends on the number of twists of the band B . Then, the *n-butterfly link* $L_b^n(K)$, is the 2-component 2-periodic link (i.e. the involution ρ exchanges its components) obtained from such a band move on K , so that the linking number between its components is n .

Remark 6. In order to avoid confusion, we want to remark that the definition of $L_b^n(K)$ given in Definition 3.9 above actually coincide with the definition of $\widehat{L}_b^{-n}(K)$ given in [DP23, Definition 1.9]. We choose to use a different notation to improve readability.

In [DPF23a], Framba and the first author associate with a DSI knot the so called *moth link* which we are now going to recall (see [DPF23a, Definition 5.2] for details).

Definition 3.10. Let (K, ρ, h) be a DSI knot and let B be the invariant band giving the 0-butterfly link $L_b^0(K)$, as in Definition 3.9. Observe that we can undo the band move on B by attaching another invariant band B^* on $L_b^0(K)$. Then we define the *moth link* $L_m(K)$ as the *strong fusion* (see [Kai92]) of $L_b^0(K)$ along the band B^* .

Now, the *moth polynomial* of (K, ρ, h) is defined as the Kojima-Yamasaki eta-function (see [KY79]) of the moth link of K .

Proposition 3.11. [DPF23a, Proposition 5.6] *The moth polynomial induces a group homomorphism*

$$\begin{aligned} \eta_m : \widetilde{\mathcal{C}} &\rightarrow \mathbb{Q}(t) \\ K &\mapsto \eta(L_m(K))(t). \end{aligned}$$

Proposition 3.12. [DPF23a, Proposition 5.7] *The moth polynomial of a DSI knot K can be computed by the following formula:*

$$\eta_m(K)(t) = \frac{\nabla_{L_b^0(K)}(z)}{z\nabla_K(z)},$$

where $\nabla_L(z)$ is the Conway polynomial of a (semi)-oriented link L and $z = i(2 - t - t^{-1})^{1/2}$.

Remark 7. In the following, we will regard the moth polynomial as a group homomorphism

$$\eta_m : \tilde{\mathcal{C}} \rightarrow \mathbb{Q}(z)$$

defined by the formula in Proposition 3.12.

Lemma 3.13. *Let K be a DSI knot. Then for any $p, q \in \mathbb{Z}$*

$$\nabla_K(z) | \nabla_{L_b^p(K)}(z) \iff \nabla_K(z) | \nabla_{L_b^q(K)}(z).$$

Proof. Let $p \in \mathbb{Z}$ be any integer. It is sufficient to prove that

$$\nabla_K(z) | \nabla_{L_b^p(K)}(z) \iff \nabla_K(z) | \nabla_{L_b^{p+1}(K)}(z).$$

In order to do so we can apply the skein relation for the Conway polynomial as indicated in Figure 11 to obtain

$$\nabla_{L_b^{p+1}(K)}(z) = \nabla_{L_b^p(K)}(z) + z\nabla_K(z).$$

□

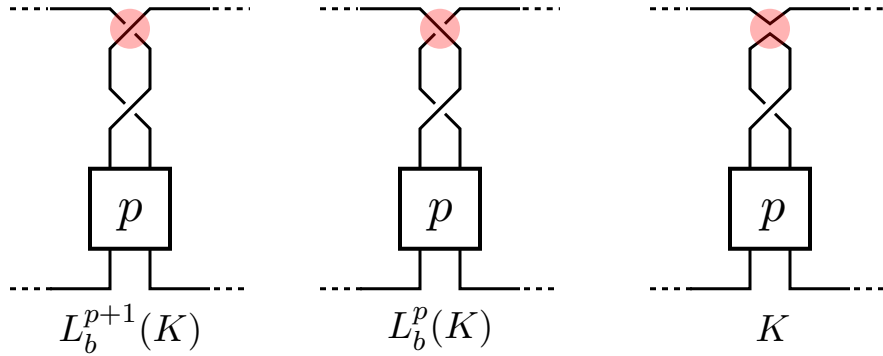

FIGURE 11. The three terms appearing in the skein relation. The box denotes p full twists.

Corollary 3.14. *Let K be a DSI knot and let $\eta_m(K)(z) = f(z)/g(z)$, where $f(z), g(z) \in \mathbb{Z}[z]$ are coprime polynomials. Suppose that for some $p \in \mathbb{Z}$ we have that $\det(K)$ does not divide $\det(L_b^p(K))$. Then $\deg g(z) > 0$ and $g(z) | \nabla_K(z)$.*

Proof. Recall that for a link L we have that $\det(L) = |\nabla_L(-2i)|$. Since $\det(K)$ does not divide $\det(L_b^p(K))$, it follows that $\nabla_K(z)$ does not divide $\nabla_{L_b^p(K)}(z)$. Hence, by Lemma 3.13, $\nabla_K(z)$ does not divide $\nabla_{L_b^0(K)}(z)$ either. The proof follows by observing that $z | \nabla_{L_b^0(K)}(z)$, since $L_b^0(K)$ is a link with more than one component. □

We are now going to use the moth polynomial to prove the main result of this section.

Remark 8. In [Sak86] Sakuma introduced an equivariant concordance invariant $\eta_{(K, \rho)}$ obtained by taking the Kojima-Yamasaki eta-function of a certain link associated with (K, ρ) . However, thanks to the symmetries of J_n and [Sak86, Proposition 3.4], we know that Sakuma's eta-polynomial always vanishes for J_n , $n \in \mathcal{J}_{\text{odd}}$.

Lemma 3.15. *Let $n \in \mathcal{J}_{\text{odd}}$. Then there exists $p \in \mathbb{Z}$ such that*

$$\frac{\det(L_b^p(J_n))}{\det(J_n)} \text{ is not an integer.}$$

Proof. Let F_n be the spanning surface for J_n depicted in Figure 12, where $n = 2k + 1$.

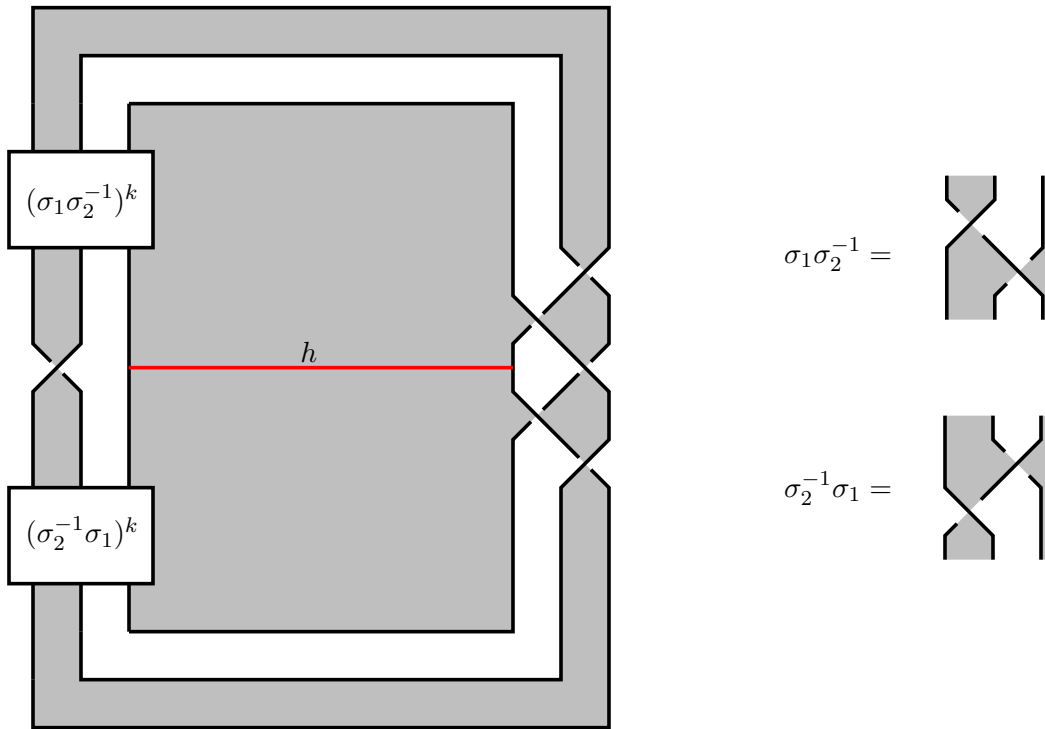

FIGURE 12. The spanning surface F_n for J_n

Observe that by cutting F_n along the half-axis h , we get a spanning surface \overline{F}_n for the p -butterfly link of J_n for some $p \in \mathbb{Z}$. We are now going to show that

$$(1) \quad 2 \det(J_n) < \det(L_b^p(J_n)) < 4 \det(J_n),$$

which is sufficient, since $\det(J_n)$ is odd, while $\det(L_b^p(J_n))$ is even, hence it cannot be that

$$\det(L_b^p(J_n)) = 3 \det(J_n).$$

Let Γ_n (see Figure 13) be the graph associated with F_n (see Section 3.1.1). The corresponding

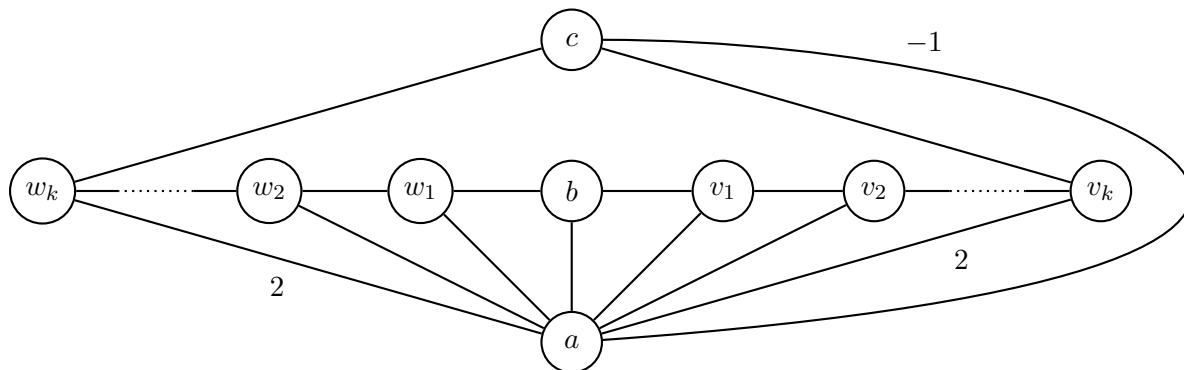

FIGURE 13. The graph associated with F_n .

graph $\overline{\Gamma}_n$ for \overline{F}_n is easily obtained from Γ_n by identifying the vertices b and c . Recall that from Theorem 3.3 and the discussion in Section 3.1.1, we have

$$(2) \quad \det(J_n) = \mathcal{T}(\Gamma_n) \quad \text{and} \quad \det(L_p(J_n)) = \mathcal{T}(\overline{\Gamma}_n).$$

Denote by $\Gamma_n(x)$ be the graph obtained by adding an edge e with label x between b and c to Γ_n . Applying Theorem 3.8 to the edge e of $\Gamma_n(x)$, we get

$$(3) \quad \mathcal{T}(\Gamma_n(x)) = \mathcal{T}(\Gamma_n) + x\mathcal{T}(\overline{\Gamma_n}).$$

Using (2) and (3), we can see that the inequalities (1) are equivalent to showing that

$$\mathcal{T}(\Gamma_n(-1/4)) > 0 \quad \text{and} \quad \mathcal{T}(\Gamma_n(-1/2)) < 0.$$

Observe now that the matrix $\mathcal{L}(\Gamma_n(-1/4); a)$ (see Section 3.1) is positive definite: multiplying by 3 both the row and column corresponding to the vertex c we get a dominant diagonal matrix with positive diagonal entries, which has all positive eigenvalues by Gershgorin Theorem. Hence $\mathcal{T}(\Gamma_n(-1/4)) = \det(\mathcal{L}(\Gamma_n(-1/4); a)) > 0$.

On the other hand, it is not difficult to see that $\mathcal{L}(\Gamma_n(-1/2); a)$ has an inertia $(n, 1, 0)$ i.e. it is nonsingular and it has n positive eigenvalues and 1 negative eigenvalue. Removing the column and row corresponding to c we get a positive definite matrix by Gershgorin Theorem, hence $\mathcal{L}(\Gamma_n(-1/2); a)$ has at least n positive eigenvalues. However, $\mathcal{L}(\Gamma_n(-1/2); a)$ has at least (and hence exactly) one negative eigenvalue: the restriction to the subspace spanned by the vertices c, b, v_k, w_k is given by

$$\begin{pmatrix} 1/2 & 1/2 & -1 & -1 \\ 1/2 & 5/2 & 0 & 0 \\ -1 & 0 & 4 & 0 \\ -1 & 0 & 0 & 4 \end{pmatrix}$$

which has negative determinant. In particular, $\mathcal{T}(\Gamma_n(-1/2)) = \det(\mathcal{L}(\Gamma_n(-1/2); a)) < 0$. □

Proposition 3.16. *Let $\mathcal{F} \subset \mathcal{J}_{\text{odd}}$ be an infinite family such that if $m, n \in \mathcal{F}$ and $n \neq m$ then m and n are coprime. Let $J_{\mathcal{F}}$ be the subgroup of $\tilde{\mathcal{C}}$ generated by $\{J_n \mid n \in \mathcal{F}\}$. Then*

$$J_{\mathcal{F}}^{ab} = J_{\mathcal{F}} / [J_{\mathcal{F}}, J_{\mathcal{F}}] \cong \mathbb{Z}^{\infty}.$$

Proof. We prove that $\{\eta_m(J_n)(z) \mid n \in \mathcal{F}\}$ are \mathbb{Z} -linearly independent in $\mathbb{Q}(z)$. If $\gcd(p, q) = 1$, by the property (3), the sets of roots of the Alexander polynomials of J_p and J_q do not intersect, hence $\Delta_{J_p}(t)$ and $\Delta_{J_q}(t)$ are coprime polynomials. This in turns implies that the Conway polynomials $\nabla_{J_p}(t)$ and $\nabla_{J_q}(t)$ are coprime. Then the linear independence follows by the use of Lemma 3.15 and Corollary 3.14. □

3.3. String links and Milnor invariants. In [DPF23b] Framba and the first author used the close relation between strongly invertible knots and *string links* to prove that the equivariant concordance group $\tilde{\mathcal{C}}$ is not solvable. In particular, they considered a homomorphism

$$\tilde{\mathcal{C}} \xrightarrow{\varphi \circ \pi} \mathcal{C}(2),$$

where $\mathcal{C}(2)$ is the *concordance group of string links on 2 strings*, introduced in [LD88] (see [DPF23b, Section 3] for details), and they proved that $\tilde{\mathcal{C}}$ is not solvable by using Milnor invariants for string links (see [HL98]).

We now use a similar approach in order to prove that two given knots in $\tilde{\mathcal{C}}$ do not commute: we determine their image in $\mathcal{C}(2)$ and then we compute the Milnor invariants of their commutator to show that it is nontrivial. For details, one can consult [DPF23b].

Lemma 3.17. *The commutator between J_5 and J_7 is not equivariantly slice.*

Proof. Following the procedure described in [DPF23b, Remark 4.5], we determine the image of $[J_5, J_7] = J_5 \# J_7 \# J_5^{-1} \# J_7^{-1}$ in $\mathcal{C}(2)$, depicted in Figure 14.

Using the computer program `stringcmp` [TKS13], we find out that $\varphi \circ \pi([J_5, J_7])$ has nontrivial Milnor invariants. The first nontrivial invariant is in degree 6. In Figure 14, we also report the input data needed to run `stringcmp`, which codifies the longitudes of the two components of the string link. □

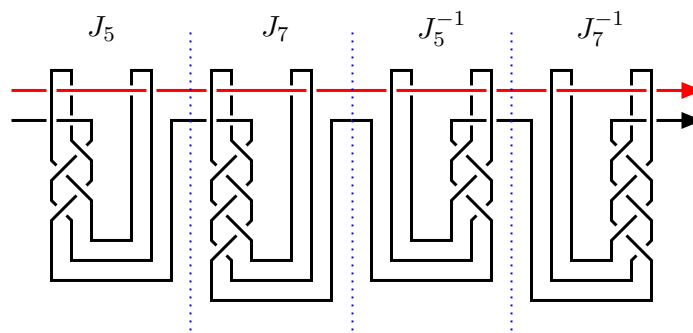

11: 30 26 51 43 65 61 84 76
 12: 30 34 35 4 24 4 22 27 51 47 46 7 56 53 37 7 39 42 64 69 11 67 11 56 57 61
 85 88 16 90 74 71 16 81 80 76

FIGURE 14. The 2-string link representing $\varphi \circ \pi([J_5, J_7])$.

Proof of Theorem C. Let \mathcal{J} be the subgroup of $\tilde{\mathcal{C}}$ generated by $\{J_p \mid p \geq 5 \text{ prime}\}$. By Proposition 3.16, we know that $\mathcal{J}^{ab} \cong \mathbb{Z}^\infty$. Moreover, it is spanned by negative amphichiral knots, therefore $\mathfrak{f}(\mathcal{J}) \subset \mathcal{C}$ is 2-torsion. Finally, by Lemma 3.17, we know that \mathcal{J} is not abelian. \square

REFERENCES

- [AC24] Mark E. AlSukaiti and Nafaa Chbili, *Alexander and Jones polynomials of weaving 3-braid links and Whitney rank polynomials of Lucas lattice*, Heliyon **10** (2024), no. 7, e28945. (Cited on page 12.)
- [AL18] Selman Akbulut and Kyle Larson, *Brieskorn spheres bounding rational balls*, Proc. Amer. Math. Soc. **146** (2018), no. 4, 1817–1824. MR 3754363 (Cited on page 3.)
- [BC24] Keegan Boyle and Wenzhao Chen, *Negative amphichiral knots and the half-Conway polynomial*, Rev. Mat. Iberoam. **40** (2024), no. 2, 581–622. MR 4717098 (Cited on page 9.)
- [BI22] Keegan Boyle and Ahmad Issa, *Equivariant 4-genera of strongly invertible and periodic knots*, J. Topol. **15** (2022), no. 3, 1635–1674. MR 4461855 (Cited on pages 2, 3, 10, 11, and 16.)
- [BRW23] Keegan Boyle, Nicholas Rouse, and Ben Williams, *A classification of symmetries of knots*, Preprint (2023), arXiv:2306.04812. (Cited on pages 5 and 6.)
- [CFHH13] Tim D. Cochran, Bridget D. Franklin, Matthew Hedden, and Peter D. Horn, *Knot concordance and homology cobordism*, Proc. Amer. Math. Soc. **141** (2013), no. 6, 2193–2208. MR 3034445 (Cited on pages 2 and 13.)
- [Cha07] Jae Choon Cha, *The structure of the rational concordance group of knots*, Mem. Amer. Math. Soc. **189** (2007), no. 885, x+95. MR 2343079 (Cited on pages 2, 3, 11, and 14.)
- [CK02] Jae Choon Cha and Ki Hyoung Ko, *Signatures of links in rational homology spheres*, Topology **41** (2002), no. 6, 1161–1182. MR 1923217 (Cited on page 14.)
- [DHM23] Irving Dai, Matthew Hedden, and Abhishek Mallick, *Corks, involutions, and Heegaard Floer homology*, J. Eur. Math. Soc. (JEMS) **25** (2023), no. 6, 2319–2389. MR 4592871 (Cited on page 3.)
- [DKM⁺22] Irving Dai, Sungkyung Kang, Abhishek Mallick, JungHwan Park, and Matthew Stoffregen, *The (2, 1)-cable of the figure-eight knot is not smoothly slice*, Preprint (2022), arXiv:2207.14187. (Cited on page 3.)
- [DMS23] Irving Dai, Abhishek Mallick, and Matthew Stoffregen, *Equivariant knots and knot Floer homology*, J. Topol. **16** (2023), no. 3, 1167–1236. MR 4638003 (Cited on pages 2, 3, and 4.)
- [DP23] Alessio Di Prisa, *The equivariant concordance group is not abelian*, Bull. Lond. Math. Soc. **55** (2023), no. 1, 502–507. MR 4568356 (Cited on pages 2, 11, and 16.)
- [DP24] ———, *Equivariant algebraic concordance of strongly invertible knots*, Journal of Topology **17** (2024), no. 4, e70006. (Cited on pages 1, 2, 3, 11, and 14.)
- [DPF23a] Alessio Di Prisa and Giovanni Framba, *A new invariant of equivariant concordance and results on 2-bridge knots*, Preprint (2023), arXiv:2303.08794, to appear in Algebr. Geom. Topol. (Cited on pages 2, 16, and 17.)
- [DPF23b] ———, *Solvability of concordance groups and Milnor invariants*, Preprint (2023), arXiv:2312.02058. (Cited on pages 2, 10, 11, and 19.)
- [DPŞ24] Alessio Di Prisa and Oğuz Şavk, *Turk’s head knots and links: a survey*, Preprint (2024), arXiv:2409.20106. (Cited on pages 2, 11, 12, and 13.)
- [FM66] Ralph H. Fox and John W. Milnor, *Singularities of 2-spheres in 4-space and cobordism of knots*, Osaka Math. J. **3** (1966), 257–267. MR 211392 (Cited on page 2.)

- [FS84] Ronald Fintushel and Ronald J. Stern, *A μ -invariant one homology 3-sphere that bounds an orientable rational ball*, Four-manifold theory (Durham, N.H., 1982), Contemp. Math., vol. 35, Amer. Math. Soc., Providence, RI, 1984, pp. 265–268. MR [780582](#) (Cited on pages [1](#) and [14](#).)
- [GL78] C. McA. Gordon and R. A. Litherland, *On the signature of a link*, Invent. Math. **47** (1978), no. 1, 53–69. MR [500905](#) (Cited on page [16](#).)
- [HHS23] Mikami Hirasawa, Ryota Hiura, and Makoto Sakuma, *Invariant Seifert surfaces for strongly invertible knots*, Essays in geometry—dedicated to Norbert A’Campo, IRMA Lect. Math. Theor. Phys., vol. 34, EMS Press, Berlin, 2023, pp. 325–349. MR [4631272](#) (Cited on page [2](#).)
- [HJ85] Roger A. Horn and Charles R. Johnson, *Matrix analysis*, Cambridge University Press, Cambridge, 1985. MR [832183](#) (Cited on page [15](#).)
- [HK79] Richard Hartley and Akio Kawachi, *Polynomials of amphicheiral knots*, Math. Ann. **243** (1979), no. 1, 63–70. MR [543095](#) (Cited on page [2](#).)
- [HKPS22] Jennifer Hom, Sungkyung Kang, JungHwan Park, and Matthew Stoffregen, *Linear independence of rationally slice knots*, Geom. Topol. **26** (2022), no. 7, 3143–3172. MR [4540903](#) (Cited on pages [2](#), [3](#), and [11](#).)
- [HL98] Nathan Habegger and Xiao-Song Lin, *On link concordance and Milnor’s $\bar{\mu}$ invariants*, Bull. London Math. Soc. **30** (1998), no. 4, 419–428. MR [1620841](#) (Cited on page [19](#).)
- [Hom17] Jennifer Hom, *A survey on Heegaard Floer homology and concordance*, J. Knot Theory Ramifications **26** (2017), no. 2, 1740015, 24. MR [3604497](#) (Cited on pages [2](#) and [4](#).)
- [Hom23] ———, *Homology cobordism, knot concordance, and Heegaard Floer homology*, ICM—International Congress of Mathematicians. Vol. 4. Sections 5–8, EMS Press, Berlin, 2023, pp. 2740–2766. MR [4680339](#) (Cited on page [4](#).)
- [HT24] Jim Hoste and Morwen Thistlethwaite, *Knotscape*, URL: <https://web.math.utk.edu/~morwen/knotscape.html>, Last accessed: December 2024. (Cited on page [11](#).)
- [Kai92] Uwe Kaiser, *Strong band sum and dichromatic invariants*, Manuscripta Math. **74** (1992), no. 3, 237–251. MR [1149761](#) (Cited on page [16](#).)
- [Kan07] Marja Kankaanrinta, *Equivariant collaring, tubular neighbourhood and gluing theorems for proper Lie group actions*, Algebr. Geom. Topol. **7** (2007), 1–27. MR [2289802](#) (Cited on page [9](#).)
- [Kaw79] Akio Kawachi, *The invertibility problem on amphicheiral excellent knots*, Proc. Japan Acad. Ser. A Math. Sci. **55** (1979), no. 10, 399–402. MR [559040](#) (Cited on page [6](#).)
- [Kaw80] ———, *The (1,2)-cable of the figure eight knot is rationally slice*, Unpublished note (1980), [available here](#). (Cited on page [1](#).)
- [Kaw96] ———, *A survey of knot theory*, Birkhäuser Verlag, Basel, 1996, Translated and revised from the 1990 Japanese original by the author. MR [1417494](#) (Cited on page [4](#).)
- [Kaw09] ———, *Rational-slice knots via strongly negative-amphicheiral knots*, Commun. Math. Res. **25** (2009), no. 2, 177–192. MR [2554510](#) (Cited on pages [1](#), [8](#), and [9](#).)
- [Kim23] Taehee Kim, *Knot reversal and rational concordance*, Bull. Lond. Math. Soc. **55** (2023), no. 3, 1210–1221. MR [4599109](#) (Cited on page [3](#).)
- [KL22] Taehee Kim and Charles Livingston, *Knot reversal acts non-trivially on the concordance group of topologically slice knots*, Selecta Math. (N.S.) **28** (2022), no. 2, Paper No. 38, 17. MR [4363837](#) (Cited on page [3](#).)
- [KPT24] Sungkyung Kang, JungHwan Park, and Masaki Taniguchi, *Cables of the figure-eight knot via real Frøyshov invariants*, Preprint (2024), [arXiv:2405.09295](https://arxiv.org/abs/2405.09295). (Cited on page [3](#).)
- [KS92] Kouzi Kodama and Makoto Sakuma, *Symmetry groups of prime knots up to 10 crossings*, Knots 90 (Osaka, 1990), de Gruyter, Berlin, 1992, pp. 323–340. MR [1177431](#) (Cited on pages [6](#) and [12](#).)
- [KW18] Min Hoon Kim and Zhongtao Wu, *On rational sliceness of Miyazaki’s fibered, -amphicheiral knots*, Bull. Lond. Math. Soc. **50** (2018), no. 3, 462–476. MR [3829733](#) (Cited on page [2](#).)
- [KY79] Sadayoshi Kojima and Masayuki Yamasaki, *Some new invariants of links*, Invent. Math. **54** (1979), no. 3, 213–228. MR [553219](#) (Cited on page [16](#).)
- [LD88] Jean-Yves Le Dimet, *Cobordisme d’enlacements de disques*, Mém. Soc. Math. France (N.S.) (1988), no. 32, ii+92. MR [971415](#) (Cited on page [19](#).)
- [Lee24] Jaewon Lee, *Obstructing two-torsion in the rational knot concordance group*, Preprint (2024), [arXiv:2406.12761](https://arxiv.org/abs/2406.12761). (Cited on page [2](#).)
- [Lev69a] J. Levine, *Invariants of knot cobordism*, Invent. Math. **8** (1969), 98–110; addendum, ibid. **8** (1969), 355. MR [253348](#) (Cited on page [3](#).)
- [Lev69b] ———, *Knot cobordism groups in codimension two*, Comment. Math. Helv. **44** (1969), 229–244. MR [246314](#) (Cited on page [3](#).)
- [Lev23] Adam Simon Levine, *A note on rationally slice knots*, New York J. Math. **29** (2023), 1363–1372. MR [4689111](#) (Cited on pages [1](#), [2](#), and [9](#).)
- [Liv83] Charles Livingston, *Knots which are not concordant to their reverses*, Quart. J. Math. Oxford Ser. (2) **34** (1983), no. 135, 323–328. MR [711524](#) (Cited on page [3](#).)
- [Liv05] ———, *A survey of classical knot concordance*, Handbook of knot theory, Elsevier B. V., Amsterdam, 2005, pp. 319–347. MR [2179265](#) (Cited on page [2](#).)

- [LM24] Charles Livingston and Allison H. Moore, *Knotinfo: Table of knot invariants*, URL: knotinfo.math.indiana.edu, Last accessed: December 2024. (Cited on page 11.)
- [MB84] John W. Morgan and Hyman Bass, *The Smith conjecture*, Pure and Applied Mathematics, vol. 112, Academic Press, Inc., Orlando, FL, 1984, Papers presented at the symposium held at Columbia University, New York, 1979. MR [758459](#) (Cited on page 4.)
- [Mil22] Allison N. Miller, *Amphichiral knots with large 4-genus*, Bull. Lond. Math. Soc. **54** (2022), no. 2, 624–634. MR [4453695](#) (Cited on pages 2 and 3.)
- [MP23] Allison N. Miller and Mark Powell, *Strongly invertible knots, equivariant slice genera, and an equivariant algebraic concordance group*, J. Lond. Math. Soc. (2) **107** (2023), no. 6, 2025–2053. MR [4598178](#) (Cited on page 2.)
- [Sak86] Makoto Sakuma, *On strongly invertible knots*, Algebraic and topological theories (Kinosaki, 1984), Kinokuniya, Tokyo, 1986, pp. 176–196. MR [1102258](#) (Cited on pages 1, 2, 9, 10, 12, and 17.)
- [Şav20] Oğuz Şavk, *More Brieskorn spheres bounding rational balls*, Topology Appl. **286** (2020), 107400, 10. MR [4179129](#) (Cited on page 3.)
- [Şav24] ———, *A survey of the homology cobordism group*, Bull. Amer. Math. Soc. (N.S.) **61** (2024), no. 1, 119–157. MR [4678574](#) (Cited on page 2.)
- [SW95] Makoto Sakuma and Jeffrey Weeks, *Examples of canonical decompositions of hyperbolic link complements*, Japan. J. Math. (N.S.) **21** (1995), no. 2, 393–439. MR [1364387](#) (Cited on page 12.)
- [TKS13] Y. Takabatake, T. Kuboyama, and H. Sakamoto, *StringCMP: Faster calculation for Milnor invariant*, Available at <https://github.com/tkbtksms/stringcmp>, 2013. (Cited on page 19.)
- [Tut01] W. T. Tutte, *Graph theory*, Encyclopedia of Mathematics and its Applications, vol. 21, Cambridge University Press, Cambridge, 2001, With a foreword by Crispin St. J. A. Nash-Williams, Reprint of the 1984 original. MR [1813436](#) (Cited on page 15.)
- [Tut04] WT Tutte, *Graph-polynomials*, Advances in Applied Mathematics **32** (2004), no. 1-2, 5–9. (Cited on page 16.)
- [Wal69] Friedhelm Waldhausen, *Über Involutionen der 3-Sphäre*, Topology **8** (1969), 81–91. MR [236916](#) (Cited on page 4.)
- [Wat17] Liam Watson, *Khovanov homology and the symmetry group of a knot*, Adv. Math. **313** (2017), 915–946. MR [3649241](#) (Cited on page 2.)

SCUOLA NORMALE SUPERIORE, 56126 PISA, ITALY

Email address: alessio.diprisa@sns.it

URL: <https://sites.google.com/view/alessiodiprisa>

CNRS AND LABORATORIE DE MATHÉMATIQUES JEAN LERAY, NANTES UNIVERSITÉ, 44322 NANTES, FRANCE

Email address: oguz.savk@cnrs.fr

URL: <https://sites.google.com/view/oguzsavk>