

Communication Backbone Reconfiguration with Connectivity Maintenance

Leonardo Santos, Caio C. G. Ribeiro, and Douglas G. Macharet

Abstract—The exchange of information is key in applications that involve multiple agents, such as search and rescue, military operations, and disaster response. In this work, we propose a simple and effective trajectory planning framework that tackles the design, deployment, and reconfiguration of a communication backbone by reframing the problem of networked multi-agent motion planning as a manipulator motion planning problem. Our approach works for backbones of variable configurations both in terms of the number of robots utilized and the distance limit between each robot. While research has been conducted on connection-restricted navigation for Multi-Robot Systems (MRS) in the last years, the field of manipulators is arguably more developed both in theory and practice. Hence, our methodology facilitates practical applications built on top of widely available motion planning algorithms and frameworks for manipulators.

Index Terms—Networked Robots, Motion Planning for Multiple Mobile Robots, Cooperating Robots.

I. INTRODUCTION

Multi-Robot Systems (MRS) have been studied in a variety of applications, such as mapping [1], target tracking [2], warehouse management [3] and search and rescue [4]. A particularly compelling application of MRS entails leveraging groups of mobile robots as relays to establish *ad hoc* networks when communication infrastructure is not available. These systems allow a robot to collect information and then transmit it through a chain of relay robots to the base station. This capability is fundamental in disaster response scenarios [5], where robots are used to collect and transmit information to human rescuers. We consider the scenario of a leader robot sending information to the next robot in line, which then passes it along to the subsequent robots until it reaches a base station.

We address the problem of backbone reconfiguration with connectivity maintenance. This involves two key components: first, determining the endpoint locations of the relay robots to form a *backbone* that connects a designated *leader robot* to a *base station*; second, navigating the robots to these positions to establish the computed backbone. Given the high cost of robotic assets, we also optimize for the minimum number of robots required to complete the operation efficiently. In scenarios featuring intermittent connectivity [6], each robot can individually compute its path, under the assumption that continuous connection is unnecessary during transit. In our

This work was supported by CAPES/Brazil - Finance Code 001, CNPq/Brazil, and FAPEMIG/Brazil.

The authors are with the Computer Vision and Robotics Laboratory (VeRLab), Department of Computer Science, Universidade Federal de Minas Gerais, MG, Brazil. E-mails: leohmcs@ufmg.br, caioconti@ufmg.br, doug@dcc.ufmg.br



Figure 1: Illustration of a backbone reconfiguration with a different number of robots. The initial configuration is at the bottom, and the new one is shown at the top. The leader robot is depicted in black, and relay robots in orange. Planned trajectories (blue arrows), are guaranteed by construction to keep the backbone connected throughout the trajectories execution.

work, we address the more complex case where sustained end-to-end connectivity is required at all times, focusing on line-of-sight connectivity. Therefore, the robots' trajectories must be planned collectively to ensure network continuity during movement, and not only in the final backbone (see Fig. 1).

We determine the robots' final positions using a visibility graph, post-processed to utilize the minimum number of relay robots. Next, to maintain network connectivity during movement, we adopt the virtual structure concept [7], modeling the MRS as a two-dimensional, linearly connected network. This approach allows us to apply any single-robot planning algorithm to efficiently plan coordinated paths for the entire robot team. However, the virtual structure framework does not accommodate a variable number of robots or adjustable inter-robot distances. To address these limitations, we expand the state space to three dimensions, plan the trajectory in 3D, and then project the solution back into the 2D space. The 3D structure maintains its shape while allowing adjustments to the number of robots and their distances in 2D. By treating the 3D structure as a robotic manipulator, we can apply inverse kinematics and manipulator planning algorithms to generate the trajectory in 3D, indirectly solving the 2D multi-robot navigation problem while maintaining line-of-sight connectivity.

In summary, the main contributions of this paper are:

- 1) A complete framework to solve both the network configuration calculation (relay robots endpoint locations) and the networked MRS path planning problem;
- 2) A new modeling that allows to use standard single-robot planners in a linearly connected MRS, with built-in guarantees for maintaining line-of-sight connectivity.

II. RELATED WORK

The problem of planning robot trajectories while maintaining connectivity to a base station has been studied in both wired [8] and wireless [9] networks. Given the physical limitations of wired connections, such as entanglement, we focus on the wireless case. Also, there are two main approaches to modeling wireless networks. One uses realistic communication models based on statistical methods [10], while the other assumes that two robots are connected if they are within a threshold distance and have line-of-sight [11]. Although more conservative, the latter approach is simpler and only requires a workspace map, providing reliable results for our application.

Deploying networked robot systems becomes challenging when there are obstacles in the environment. In this scenario, Stump *et al.* [12] propose a framework capable of deploying and redeploying a set of router robots using a polygonal map decomposition, considering intermittent connectivity. Santos *et al.* [13] propose a graph-based approach considering Steiner trees for deployment of a set of router robots, not considering reconfiguration for the case where clients' positions may change. Wang *et al.* [14] also tackle the problem of connecting a single robot to a base station via an end-to-end network of router robots, but they do not guarantee connectivity while the robots are moving to their final destinations. Our work extends these approaches by ensuring continuous connectivity of the relay robots, during initial deployment and reconfiguration, specially while they are moving to new positions.

In order to guarantee connectivity during reconfiguration, we must solve a communication-restricted planning problem. In this context, Banfi *et al.* [15] propose planning algorithms for exploration in communication-restricted environments based on a line-of-sight model; however, they consider recurrent or periodic, not online connectivity. Online connectivity maintenance with a fixed base station has been addressed by Pei *et al.* [16], where they propose a centralized algorithm that runs on the base station to solve a variant of the Minimum Steiner Tree Problem. Global connectivity maintenance in MRS has been successfully achieved by control frameworks proposed by Luo *et al.* [17]. An advantage of our methodology over these works is the reduced complexity of implementation, leveraging widely available motion planning resources for manipulators, thus facilitating applications.

In this work, we propose a centralized approach for online connectivity maintenance considering backbones of varying sizes. To the best of our knowledge, this is the first work to tackle the communication-restricted trajectory planning for multi-robot systems considering a manipulator formulation.

III. PROBLEM FORMULATION

Given a fully-known static planar environment \mathcal{E} , a set of n mobile robots $\mathcal{R} = \{r_1, r_2, \dots, r_n\}$, and a leader robot r_l . The robots work as *routers*, relaying messages over the network between a base station and the leader robot, and they have a communication radius of at most $c_{r,i}$ meters (which can be different for each robot i).

Next, we define some concepts used throughout the text.

Definition 1. Communication backbone: An end-to-end ad hoc wireless network formed by mobile robots able to work as routers. The backbone will be used to connect a single leader robot r_l to a fixed based station.

Definition 2. Backbone configuration: A set of Cartesian coordinates in \mathbb{R}^2 that defines the positions of each robot of the backbone, according to a given frame.

Definition 3. Backbone adaptation: The step of planning a valid trajectory for each robot in the backbone in order to change it from a start configuration to a target one.

Definition 4. Robot connectivity: Two robots are considered connected if the distance between them is less or equal to a given communication radius c_r and they have direct visibility to each other.

Definition 5. Valid backbone trajectory. A backbone trajectory is considered valid if every robot in the backbone is connected to its neighbors during the entire trajectory.

Problem 1 (Communication Backbone Reconfiguration with Connectivity Maintenance). Given a leader robot r_l that can freely move on the environment and a set of mobile routers \mathcal{R} . The goal is to sequentially design and deploy a communication backbone that guarantees the leader robot is constantly connected to a fixed base station while it is traversing the environment. The backbone must use a minimal set of routers and minimize the path distance cost during its adaptation.

IV. METHODOLOGY

Our method comprises two main components (Fig. 2). The first one assesses whether the target is reachable with the available number of relay robots. If so, it then determines the minimum number of relay robots required and their goal positions within the workspace to establish a communication backbone between the base station and the leader robot once it reaches its target position. According to Def. 2, this is what we call determining the *backbone configuration*.

The second component is responsible for planning paths for the leader and all robots that are part of the backbone, so that they navigate from their current to target positions keeping the leader connected to the base station at all time. This component receives the goal backbone configuration as input, compute the inverse kinematics (IK) of the virtual structure that corresponds to this configuration, and then plan the paths from the current configurations to the goal configurations. The robots that are not part of the backbone are sent back to the base station (where they can be recharged, for instance).

In a typical mission, these two components run sequentially. The only input is the target position for the leader, and the outputs are the trajectories to each robot, which are then executed using an external trajectory following module. Once all robots navigate through their assigned trajectories and the leader reaches the target, the system waits until a new target position is received and starts the pipeline again.

A. Robot arm modeling

We tackle the backbone design and deployment problem as a manipulator planning problem. In other words, we indirectly

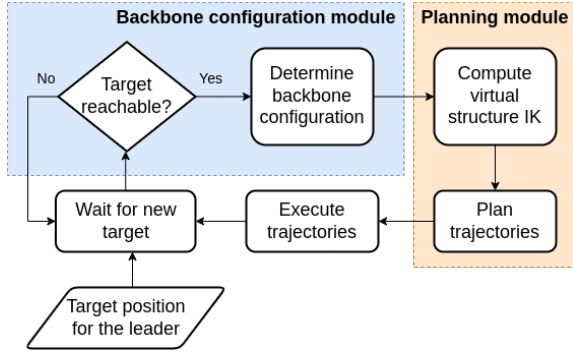

Figure 2: Outline of the full pipeline.

plan for the robots of the backbone by planning for a virtual structure [7] that represents it. Thus, the first step is to model the robot arm for which the planning will be performed, which depends only on the communication radius and the maximum number of robots in the team.

Our methodology uses a three-dimensional arm modeled as follows. Each robot will be represented by a *universal joint* to allow motion with 2 Degrees of Freedom (DoF), and the base station is mapped to the base link. Hence, each robot in the team must have a fixed index assigned to it from the beginning, which will define its two neighbors and which joint corresponds to it. The link connecting two of these joints represents the wireless connection of the respective robots. Consequently, according to Def. 4, we map a loss of connection into a link collision, satisfying the visibility connection constraints while planning. In networked multi-agent path planning, it is allowed - and desirable - that the distances between neighbors vary as long as they respect the communication radius. To that end, the trajectory of each robot is taken as the projection of the corresponding joint on the ground plane along the arm trajectory. Using the orthogonal projection of the joints as the robots' positions allows the distance d between connected robots r_i, r_j to vary by changing the pitch angle of the joint θ while the link length L is kept constant, as shown in Fig. 3. The value of θ is calculated using the backbone configuration as input to an inverse kinematics algorithm described in Sec. IV-C.

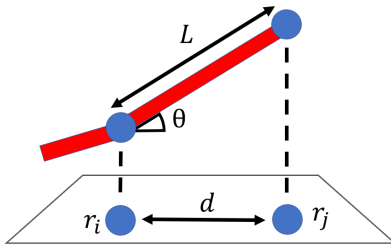
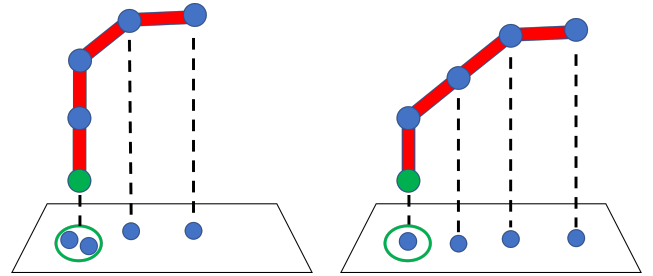

Figure 3: Manipulator draw in perspective as if the z -axis was parallel to the page to demonstrate that the 3D manipulator approach solves the fixed distance limitation by varying θ .

To ensure that the distance between neighbor robots is never greater than the communication radius - which would disconnect them - we make L equal to c_r . That way, we ensure

that neighbor robots are always within the connection radius of each other, satisfying the connection constraint.

The 3D formulation shown above also allows planning trajectories between backbones composed of a different number of robots. Since we take the orthogonal projection of a position in space as the robots' positions, it is enough to make the (x, y) position of the joints correspondent to the robots that are not needed in the backbone the same as the base's position, which is easily achieved by setting the pitch angle to 0° as shown in Fig. 4. Note that the backbone configuration may not include all available robots, but the manipulator configuration always does. Besides, by using only universal joints, we are able to cover all valid backbone configurations in the sense that, for all possible backbone configurations, given the network and number of robots parameters, there is an arm configuration in which the projection corresponds to this configuration.



(a) This configuration uses 2 out of 4 robots in the backbone and sends the other two to the base station. (b) This configuration uses 3 out of 4 robots in the backbone and sends the other one to the base station.

Figure 4: Backbone configurations composed by a different number of robots without changing the robot arm model. The base station is represented by the green base joint, and the robots are represented by the blue joints.

B. Backbone deployment

The definition of the target backbone configuration (see Def. 2) is independent of the planning pipeline. Therefore, it is possible to use external algorithms as long as they respect the visibility constraint, such as [18]. Nonetheless, we propose a solution for that task in Alg. 1, which leans on the visibility network modeling adopted in this work. Function `DilateObstacles` in Alg. 1 dilates the obstacles to avoid collisions, and function `VisGraphPath` calculates the shortest path between two points using a visibility graph, returning an array of nodes containing (x, y) positions.

C. Trajectory planning

The main contribution of this paper is the formulation of backbone planning problems as a manipulator planning problem. To plan the backbone trajectory, it is necessary to calculate the arm inverse kinematics corresponding to a given backbone configuration. The arm configuration must be such that each joint's projection on the ground plane corresponds to its associated robot position in the backbone. That way, given a backbone configuration, the planner can calculate the trajectory between the current virtual arm configuration (the

Algorithm 1 Backbone deployment

Input occupancy map, base station positions, leader's goal**Output** backbone configuration

```
1:  $\mathcal{M} \leftarrow \text{DilateObstacles}(\text{occupancy map})$ 
2:  $G_l \leftarrow$  leader's goal position
3:  $R \leftarrow$  base station position  $\triangleright$  Reference point
4:  $B \leftarrow \{\}$   $\triangleright$  Backbone array
5:  $S_p \leftarrow \text{VisGraphPath}(\mathcal{M}, G_l, R)$   $\triangleright$  Path array
6: for node in  $S_p$  do
7:   if  $\|R - \text{node}\| > c_R - \delta$  then  $\triangleright \delta$  is a constant
8:      $b_n \leftarrow R + \frac{R - \text{node}}{\|R - \text{node}\|} (c_R - \delta)$ 
9:     Append  $b_n$  to  $B$ 
10:     $R \leftarrow \text{node}$ 
11:   else
12:     Append node to  $B$ 
13:      $R \leftarrow \text{node}$ 
14:   end if
15: end for
16: return  $B$ 
```

current backbone configuration) to the target arm configuration (the target backbone configuration). The inverse kinematics algorithm is given by Alg. 2. Since both positive and negative z would result in the same projected point, we chose to always use the positive z -height.

Algorithm 2 Inverse kinematics from backbone

Require: the backbone is connected

```
1:  $B \leftarrow$  backbone configuration
2:  $N \leftarrow$  team size  $\triangleright$  Number of robots available
3:  $c_R \leftarrow \{c_{R,0}, \dots, c_{R,N}\}$   $\triangleright$  Connection radius
4:  $K \leftarrow \{\}$   $\triangleright$  Angles for all (universal) joints
5:  $i \leftarrow 1$   $\triangleright$  Index of the current robot; 0 is the base
6: while  $i \leq N$  do
7:    $(x_i, y_i) \leftarrow B[i]$ 
8:   Transform  $(x_i, y_i)$  to previous joint's frame
9:    $d = \|(x_i, y_i)\|$ 
10:  if  $d = 0$  then
11:     $(\theta, \psi) \leftarrow (0, 0)$ 
12:  else if  $x_i = 0$  then
13:     $\theta \leftarrow \arccos \frac{d}{c_R[i]}$ 
14:     $\psi \leftarrow \arcsin \frac{y_i}{d}$ 
15:  else
16:     $\theta \leftarrow \text{sign}(x_i) \arccos \frac{d}{c_R[i]}$ 
17:     $\psi \leftarrow \text{sign}(x_i) \arccos \frac{y_i}{d}$ 
18:  end if
19:  Append  $(\theta, \psi)$  to  $K$ 
20:   $i = i + 1$ 
21: end while
```

Since the robots are moving in 2D and the planning is being performed in 3D, we must modify the 2D map to avoid valid arm configurations that map to invalid backbone configurations as shown in Fig. 5. If H is the arm's height in a full-vertical pose and $\mathcal{C}_{obs,2D}$ is the set of obstacles in the 2D map, the set of obstacles $\mathcal{C}_{obs,3D}$ in the 3D map in which planning

is performed is obtained by the Cartesian product $\mathcal{C}_{obs,3D} = \mathcal{C}_{obs,2D} \times [0, H]$.

This is a sufficient condition because it guarantees the arm projection will never intersect any obstacle since it will never be able to move above the obstacles.

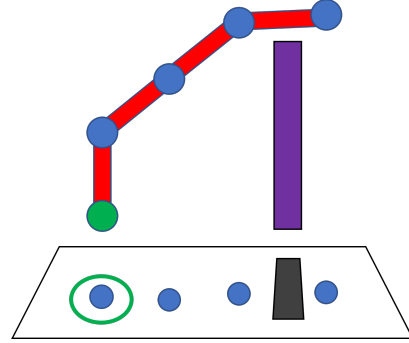

Figure 5: Example in which the manipulator configuration is valid, but the backbone configuration is not, because the arm is above the obstacle. The 3D obstacle is depicted in purple, and the 2D obstacle in gray.

Once we are able to calculate the arm inverse kinematics from the backbone configuration and modify the 2D map to perform planning in 3D, the backbone planning problem *completely* becomes a manipulator motion planning problem, and we can directly use any planner available in the literature. To avoid infeasible manipulator configurations, we assume all robots start at the base station and compute the initial manipulator pose using Alg. 2. Once the plan is computed for the manipulator, we compute the forward kinematics for every trajectory point and take each joint's (x, y) positions to get the backbone trajectory. Importantly, we are able to reduce planning complexity by planning only for the subset of the joints corresponding to the robots used; *i.e.*, we can disregard the joints corresponding to the robots that remain in the base station during reconfiguration. Optionally, one can use trajectory optimizers to potentially improve the solutions. Note that any solution will be valid according to Def. 5 because the inter-robot distance can never be greater than the virtual manipulator link's length. The planning pipeline is summarized in Fig. 6.

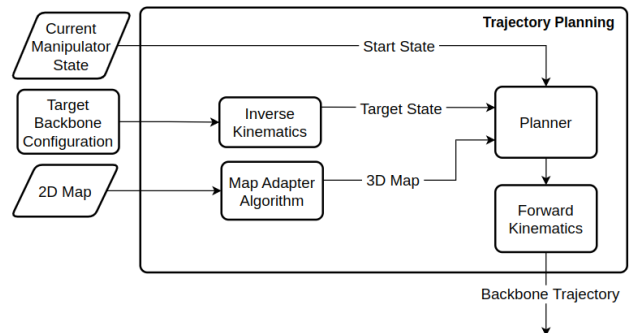

Figure 6: Diagram detailing the trajectory planning process.

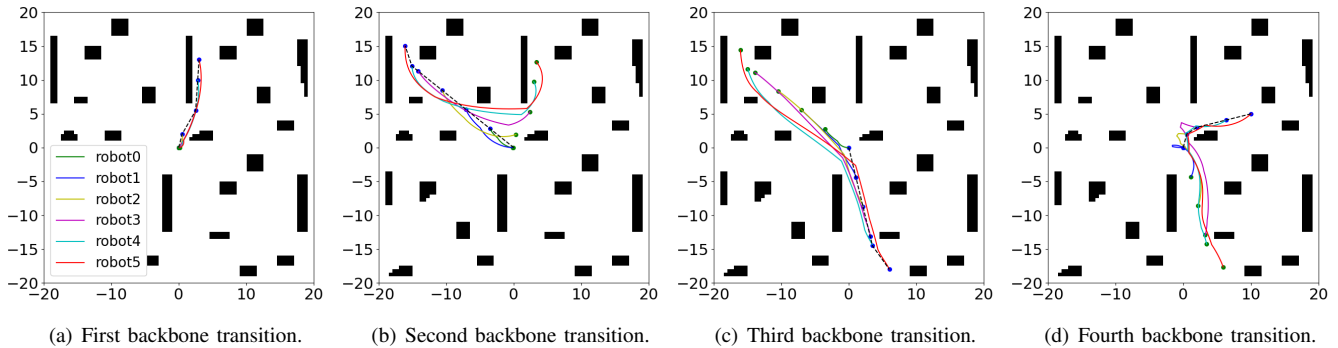

Figure 7: Example trajectories where *robot5* is the leader. The initial backbone configuration of each sequence is the final backbone configuration of the previous one (see video: https://youtu.be/j_qRqNqv9Y). The green dots are the initial positions of the robots, and the blue dots are their goals. The backbone is shown as the black dashed line.

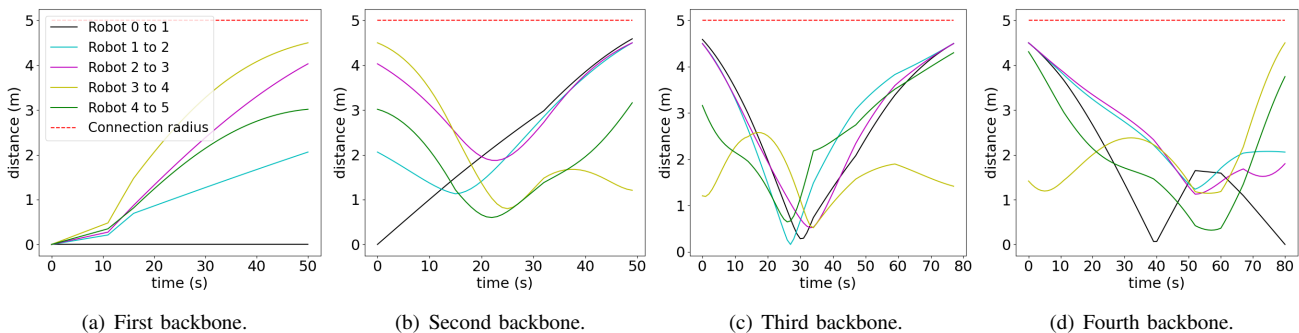

Figure 8: Distance between neighbors along the trajectories. The red dashed line represents the communication radius.

V. EXPERIMENTS

The simulation framework was implemented in Python 3.8 using ROS Noetic and MoveIt! [19]. Simulations were run in Ubuntu 20.04. The planner parameters are shown in Tab. I; and were tuned empirically to achieve a good trade off between planning time and distance cost for multi-robot systems of up to 10 robots.

Table I: Planner parameters for the illustrative example.

Parameter	Value
Planner	BiTRRT [20]
Maximum planning time for one attempt	20s
Maximum attempts within planning time	200

A. Illustrative example

Let us first consider an illustrative example to visualize the property of planning between backbones with different numbers of robots and sizes and intuitively evaluate the trajectories. For that, we randomly chose four different positions for the leader using an uniform distribution, each position resulting in a different backbone. All robots started at the base station at the origin. The planned trajectories, shown in Fig. 7, are the least costly among a maximum of 200 solutions computed within the limit of 20 seconds. If the planner can't find a

solution in 20 seconds, it restarts for another batch of (at most) 200 attempts in 20 seconds.

In Fig. 8 we show that the planned trajectories respect the communication distance, thus maintaining the backbone connected. In this case, we used a safety gap of 0.5 meters, therefore, the maximum allowed distance between neighbors was 4.5 meters. Fig. 8 also shows that our approach might generate colliding trajectories, which must be addressed by reactive obstacle avoidance in trajectory tracking, such as proposed by Rezende *et al.* [21].

B. Quantitative analysis

The map used for the quantitative analysis is shown in Fig. 9. It is an extended version of the map shown in Fig. 7 that allows for backbones with more than six robots - given the communication radius of 5 meters, it would be unlikely to have backbones of 7 robots or more in a 40m x 40m map with the base at the origin.

Similarly to Sec. V-A, we randomly chose 10 positions for the leader using an uniform distribution. To evaluate the impact of the planner's probabilistic nature on the methodology, we calculated trajectories for each position 4 times.

Fig. 10 shows the average time needed to plan the trajectories for different team sizes. Because our approach is centralized, it does not scale well with the number of robots. However, as we are directly applying the planning algorithm

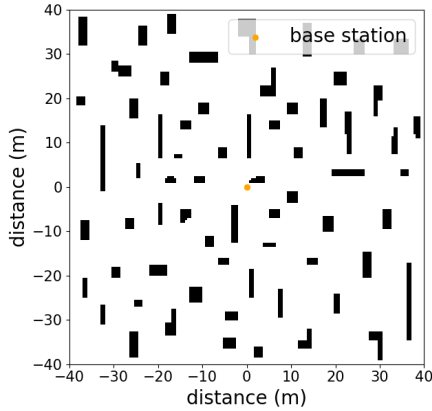

Figure 9: Map used in the quantitative analysis.

with no modifications, we still preserve the asymptotic optimality. This is a common and expected trade-off between centralized and decentralized approaches.

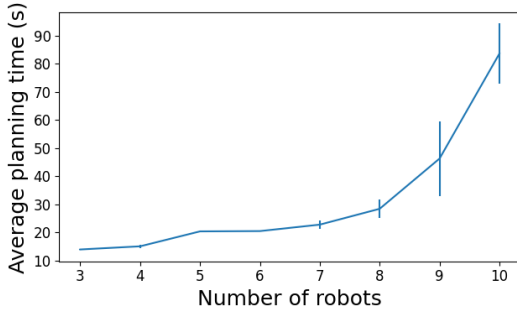

Figure 10: Average planning time over 10 planned trajectories. The error bar shows the standard deviation over 4 trials.

Finally, since we argue simplicity is a major advantage of our methodology, we compare the performance to an equivalently simple approach used in [13], which is to navigate the robots over the backbone. A drawback of this approach is that the team cannot move simultaneously because they lose communication if a robot does not wait for its neighbors in one of the nodes of the backbone. As Fig. 11 shows, because our method allows the robots to move simultaneously, we are able to finish the mission (visit all positions assigned to the leader) 80% faster for teams of 10 robots - a critical advantage in disaster response operations. We assumed the robots navigate at a maximum velocity of 0.5 m/s.

C. Hardware experiment

We also evaluated the approach with a real robot deployment in an obstacle-free scenario. Snapshots of the execution are shown in Fig. 12 and a video is available online¹.

The robotic platform was developed in-house for experiments with swarm robotics [22], and we used a top-view camera for global localization with a tag detection method.

¹<https://youtu.be/Yj-UzMRdQbI>

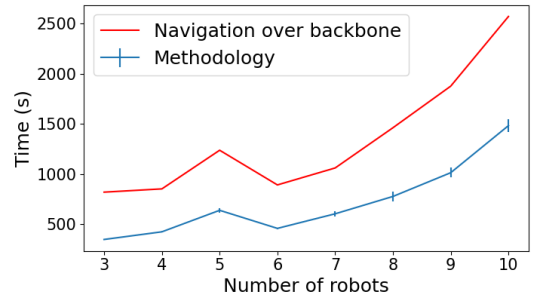

Figure 11: Mission execution time using the simple, but rigid, navigation over the backbone versus our methodology. The error bar shows the deviation over 4 trials.

The scenario has $1.78\text{m} \times 1.40\text{m}$, and the network radius was set as 30 cm. Each robot was controlled individually using the the kinematic controller proposed in [23] and deviated from the other robots in a reactive way.

As Fig. 12 shows, the robots started at the base, then, established a communication backbone for the leader at $p_1 = (-0.6, -0.5)$. Then, a new backbone at $p_2 = (-0.6, 0.3)$ was required, and the system accompanied the leader keeping it connected to the base.

VI. CONCLUSION AND FUTURE WORK

In this paper, we tackled the problem of planning paths for mobile multi-robot systems with connectivity maintenance requirements. We reformulated this problem as a manipulator planning problem and showed that we could use techniques already consolidated in that field for planning problems involving linearly networked MRS. We validated our proposal in different scenarios with small and medium-sized teams. Due to its centralized nature, however, the methodology's performance tends to degrade as the size of the team increases.

In future work, we intend to extend these ideas to design an online planner, where the backbone must provide communication to a moving client (leader robot) considering the end-effector is constantly moving and to include kinematics restrictions during planning to avoid colliding trajectories. Additionally, we also plan to evaluate the use of heterogeneous teams, *e.g.*, with aerial and ground vehicles.

REFERENCES

- [1] J. Banfi, A. Quattrini Li, I. Rekleitis, F. Amigoni, and N. Basilico, "Strategies for coordinated multirobot exploration with recurrent connectivity constraints," *Autonomous Robots*, vol. 42, no. 4, pp. 875–894, 2018. DOI: <https://doi.org/10.1007/s10514-017-9652-y>.
- [2] H. Van Nguyen, H. Rezatofghi, B.-N. Vo, and D. C. Ranasinghe, "Multi-objective multi-agent planning for jointly discovering and tracking mobile objects," in *Proceedings of the AAAI Conference on Artificial Intelligence*, vol. 34, pp. 7227–7235, 2020. DOI: <https://doi.org/10.1609/aaai.v34i05.6213>.
- [3] C. C. Ribeiro, L. H. dos Santos, and D. G. Macharet, "Collaborative ugv/uav path planning for inventory management in warehouses," in *2022 Latin American Robotics Symposium (LARS), 2022 Brazilian Symposium on Robotics (SBR), and 2022 Workshop on Robotics in Education (WRE)*, pp. 121–126, IEEE, 2022. DOI = 10.1109/LARS/SBR/WRE56824.2022.9995748.
- [4] D. S. Drew, "Multi-agent systems for search and rescue applications," *Current Robotics Reports*, vol. 2, pp. 189–200, 2021. DOI=<https://doi.org/10.1007/s43154-021-00048-3>.

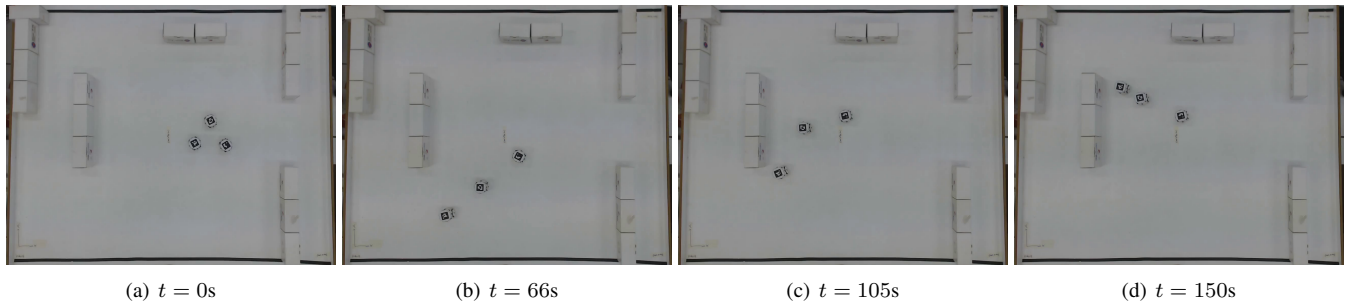

Figure 12: Real-world proof-of-concept execution in an obstacle-free environment. Video: <https://youtu.be/Yj-UzMRdQbI>

- [5] J. P. Queralta, J. Taipalmaa, B. C. Pullinen, V. K. Sarker, T. N. Gia, H. Tenhunen, M. Gabbouj, J. Raitoharju, and T. Westerlund, "Collaborative multi-robot search and rescue: Planning, coordination, perception, and active vision," *IEEE Access*, vol. 8, pp. 191617–191643, 2020. DOI=10.1109/ACCESS.2020.3030190.
- [6] Y. Kantaros, M. Guo, and M. M. Zavlanos, "Temporal logic task planning and intermittent connectivity control of mobile robot networks," *IEEE Transactions on Automatic Control*, vol. 64, no. 10, pp. 4105–4120, 2019. DOI=10.1109/TAC.2019.2893161.
- [7] M. A. Lewis and K.-H. Tan, "High precision formation control of mobile robots using virtual structures," *Autonomous Robots*, vol. 4, pp. 387–403, Oct 1997. DOI=10.1023/A:1008814708459.
- [8] D. Shapovalov and G. A. S. Pereira, "Tangle-Free Exploration with a Tethered Mobile Robot," *Remote Sensing*, vol. 12, no. 23, 2020. DOI=10.3390/rs12233858.
- [9] M. A. Hsieh, A. Cowley, V. Kumar, and C. J. Taylor, "Maintaining network connectivity and performance in robot teams," *Journal of Field Robotics*, vol. 25, no. 1-2, pp. 111–131, 2008. DOI=<https://doi.org/10.1002/rob.20221>.
- [10] A. Ghaffarkhah and Y. Mostofi, "Communication-aware motion planning in mobile networks," *IEEE Transactions on Automatic Control*, vol. 56, no. 10, pp. 2478–2485, 2011. DOI=10.1109/TAC.2011.2164033.
- [11] P. Yang, R. A. Freeman, G. J. Gordon, K. M. Lynch, S. S. Srinivasa, and R. Sukthankar, "Decentralized estimation and control of graph connectivity for mobile sensor networks," *Automatica*, vol. 46, no. 2, pp. 390–396, 2010. DOI=<https://doi.org/10.1016/j.automatica.2009.11.012>.
- [12] E. Stump, N. Michael, V. Kumar, and V. Isler, "Visibility-based deployment of robot formations for communication maintenance," in *2011 IEEE International Conference on Robotics and Automation*, pp. 4498–4505, 2011. DOI=10.1109/ICRA.2011.5980179.
- [13] E. R. S. Santos and M. A. M. Vieira, "Fast and Parallel Wireless Communication Backbone Deployment with Networked Robots," in *19th International Conference on Advanced Robotics (ICAR)*, pp. 272–277, 2019. DOI=10.1109/ICAR46387.2019.8981573.
- [14] S. Wang, B. Krishnamachari, and N. Ayanian, "The optimism principle: A unified framework for optimal robotic network deployment in an unknown obstructed environment," in *2015 IEEE/RSJ International Conference on Intelligent Robots and Systems*, pp. 2578–2584, 2015. DOI=10.1109/IROS.2015.7353728.
- [15] J. Banfi, A. Q. Li, N. Basilico, I. Rekleitis, and F. Amigoni, "Asynchronous multirobot exploration under recurrent connectivity constraints," in *2016 IEEE International Conference on Robotics and Automation (ICRA)*, pp. 5491–5498, 2016. DOI=10.1109/ICRA.2016.7487763.
- [16] Y. Pei, M. W. Mutka, and N. Xi, "Coordinated multi-robot real-time exploration with connectivity and bandwidth awareness," in *2010 IEEE International Conference on Robotics and Automation*, pp. 5460–5465, 2010. DOI=10.1109/ROBOT.2010.5509803.
- [17] W. Luo, S. Yi, and K. Sycara, "Behavior mixing with minimum global and subgroup connectivity maintenance for large-scale multi-robot systems," in *2020 IEEE International Conference on Robotics and Automation (ICRA)*, pp. 9845–9851, IEEE, 2020. DOI=10.1109/ICRA40945.2020.9197429.
- [18] E. R. S. stump2011visibility and M. A. M. Vieira, "Autonomous wireless backbone deployment with bounded number of networked robots," in *IEEE/RSJ International Conference on Intelligent Robots and Systems (IROS)*, pp. 3740–3746, 2014. DOI=10.1109/IROS.2014.6943087.
- [19] D. Coleman, I. Sucas, S. Chitta, and N. Correll, "Reducing the barrier to entry of complex robotic software: a moveit! case study," *arXiv preprint arXiv:1404.3785*, 2014. DOI=<https://doi.org/10.48550/arXiv.1404.3785>.
- [20] D. Devaurs, T. Siméon, and J. Cortés, "Enhancing the transition-based rrt to deal with complex cost spaces," in *2013 IEEE International Conference on Robotics and Automation*, pp. 4120–4125, 2013. DOI=10.1109/ICRA.2013.6631158.
- [21] A. M. C. Rezende, V. M. Goncalves, and L. C. A. Pimenta, "Constructive time-varying vector fields for robot navigation," *IEEE Transactions on Robotics*, vol. 38, no. 2, pp. 852–867, 2022. DOI=10.1109/TRO.2021.3093674.
- [22] P. A. F. Rezeck, H. Azpurua, and L. Chaimowicz, "HeRo: An open platform for robotics research and education," in *2017 Latin American Robotics Symposium (LARS) and 2017 Brazilian Symposium on Robotics (SBR)*, pp. 1–6, 2017. DOI=10.1109/SBR-LARS-R.2017.8215317.
- [23] J. P. Desai, J. Ostrowski, and V. Kumar, "Controlling formations of multiple mobile robots," in *Proceedings. 1998 IEEE International Conference on Robotics and Automation (Cat. No. 98CH36146)*, vol. 4, pp. 2864–2869, IEEE, 1998. DOI=10.1109/ROBOT.1998.680621.