

ON $\mathbb{Z}/2\mathbb{Z}$ PERMUTATION GAUGING

ZHENGWEI LIU AND YUZE RUAN

ABSTRACT. We explicitly construct a (unitary) $\mathbb{Z}/2\mathbb{Z}$ permutation gauging of a (unitary) modular category \mathcal{C} . In particular, the formula for the modular data of the gauged theory is provided in terms of modular data of \mathcal{C} , which provides positive evidence of the reconstruction program. Moreover as a direct consequence, the formula for the fusion rules is derived, generalizing the results in [14]. Our construction explicitly shows the genus-0 data of the gauged theory contains higher genus data of the original theory. As applications, we obtain an identity for the modular data that does not come from modular group relations, and we prove that representations of the symmetric mapping class group (associated to closed surfaces) coming from weakly group theoretical modular categories have finite images.

1. INTRODUCTION

Given a unitary modular category \mathcal{C} , one may ask if it can be realized as the representation category for certain nice conformal field theory (known as the reconstruction program). One possible way to approach this question is to build and verify the analogy between conformal field theory and the modular category theory. The permutation orbifolds are important types of constructions in conformal field theory [7][28][3]. Given a completely rational conformal net or a C_2 co-finite vertex operator algebra, one considers the fix point theory under the permutation action on the n -fold tensor product of the original theory. In [28], many detailed structures have been worked out, for example, the S -matrix is established when the permutation group is $S_2 = \mathbb{Z}/2\mathbb{Z}$ (also see [3] and [7]). Therefore the problems of an analogous detailed construction in the category side become extremely interesting.

It turns out the analogous framework in the category side is called permutation gauging [34]. The general gauging is a two-step process: given a modular category \mathcal{C} and a categorical action of a finite group G , the first step is to extend \mathcal{C} to a G -crossed braided category (with a G -action) then the second step is applying the G -equivariantization to obtain a new modular category [13]. While the equivariantization can always be done, the group extension has obstructions and choices that can be abstractly characterized by certain group cohomological data [16]. For the special case, when we start with the n -fold Deligne tensor product $\mathcal{C}^{\boxtimes n}$ and the action given by permuting the tensor factors, the extension and the whole process will be called permutation extension and permutation gauging respectively. The abstract existence of such gauged theory is shown in [18], however, the detailed structures for the extension and equivariantization are wide open.

There are few related works in this direction, In [4], the authors give a topological construction of the permutation extensions which are only weakly rigid, and they directly show the rigidity of the $\mathbb{Z}/2\mathbb{Z}$ case by working out the detailed structures (fusion rules, associativity, etc). In [32], the authors

construct the m -interval Jones-Wassermann subfactors and prove the self-duality of them, which gives rise to certain subcategory of the permutation extension. In [14], the authors calculate the fusion rules for the $\mathbb{Z}/2\mathbb{Z}$ -gauged theory when \mathcal{C} is unpointed and conjecture the validity in general.

In this paper, we completely settle the case when $G = \mathbb{Z}/2\mathbb{Z}$. In particular, the modular data of the gauged theory is explicitly calculated which turns out to coincide with those in [3], [7] and [28]. As a direct consequence, the formula for the fusion rules is derived, generalizing the results in [14].

More specifically, given a (unitary) modular category \mathcal{C} , inspired by the techniques developed in [32], we construct a (shaded) planar algebra whose n -box space is given by $Cf(n, \mathcal{Z}) := \text{Hom}_{\mathcal{C}^{\boxtimes 2}}(1, \otimes_{i=1}^n \gamma Z_{2i-2} \boxtimes Z_{2i-1})$, where $\gamma = \bigoplus_{X \in \text{irr}(\mathcal{C})} X \boxtimes \bar{X}$ and $Z_i \in \text{obj}(\mathcal{C})$. The tangle actions are defined only involving the categorical data of \mathcal{C} . Our first main theorem is the following,

Theorem 1.1. *The planar algebra is self dual, moreover it can be lifted to an unshaded planar algebra with $\mathbb{Z}/2\mathbb{Z}$ action and braiding (Definition 2.3).*

All structures of this unshaded planar algebra are constructed explicitly. Therefore by taking the category of projections we prove,

Theorem 1.2. *We obtain a $\mathbb{Z}/2\mathbb{Z}$ -graded (unitary) fusion category \mathcal{D} with a $\mathbb{Z}/2\mathbb{Z}$ -crossed braiding. Moreover, the projections in the odd part are given by a single cap labeled by V for $V \in \text{obj}(\mathcal{C})$, we denote them by $\{\hat{V}\}_{V \in \text{obj}(\mathcal{C})}$, we have*

- \hat{V} is minimal $\Leftrightarrow V$ is simple.
- $\hat{V}X \boxtimes Y = X \boxtimes Y\hat{V} = \widehat{VXY}$
- $\hat{V}\hat{W} = \hat{W}\hat{V} = \bigoplus_{X \in \text{irr}(\mathcal{C})} XV \boxtimes XW$.

The $\mathbb{Z}/2\mathbb{Z}$ action ρ acts on objects by $\rho(\hat{V}) = \hat{V}$ and $\rho(X \boxtimes Y) = Y \boxtimes X$

In addition, this theorem generalizes the partial result in [32] that the 2-interval Jones-Wassermann subfactor is self-dual.

The key idea of the proof is to relate the certain Fourier pairing (see Figure 1 and [32, Sec. 2.3]) with the $\mathbb{Z}/2\mathbb{Z}$ braiding structures. Our next main result describes the relation among those braidings.

Theorem 1.3. $T_k \in \text{End}(Cf(n, \mathcal{Z}))$ ($0 \leq k \leq 2n - 2$) satisfy the following relations

$$\begin{aligned} T_k T_{k+2} &= T_{k+2} T_k, \\ T_{k+1} T_k T_{k+1} &= \eta^{(-1)^k} T_k T_{k+1} T_k, \\ (T_{2n-2} T_{2n-1} \cdots T_1 T_0)^{2n} &= \left(\prod_{k=0}^{2n-1} \theta_{\mathbb{Z}_k}^{\frac{1}{2}} \right) Id, \\ (T_0 T_1 \cdots T_{2n-2} T_{2n-2} \cdots T_1 T_0)^2 &= \theta_{\mathbb{Z}_0}^2 Id. \end{aligned}$$

In particular, if we use the same setting as in [32], then the braidings on the n -box space give a unitary projective representation of symmetric mapping class group of genus $n - 1$, where the hyperelliptic involution maps to the $\mathbb{Z}/2\mathbb{Z}$ action. Moreover in this case, we show the representations are equivalent to ones coming from Reshetikhin-Turaev Topological Quantum Field Theory associated to

the closed surfaces, see Theorem 8.2. In particular, when $n = 2$, they give the well-known projective representation of $\mathrm{SL}_2(\mathbb{Z})$. Hence, our results interpret the twisted/untwisted correspondence [3][21].

As a result, the whole planar algebra contains the higher genus data of the original theory, which allows us to derive many interesting identities in modular categories by simple isotopies in the planar algebra. In particular, we obtain one non-modular-group-relation identity, see Proposition 6.6 generalizing the self-duality of 6j-symbols[30]. Moreover, we have the following obstruction (indeed, infinitely many obstructions by keep doing $\mathbb{Z}/2\mathbb{Z}$ permutation gauging see Remark 6.2) for modular category realization of S -matrix.

$$(1) \quad \mathrm{Det}|_{\Lambda}(S^{\otimes 6}P - I^{\otimes 6}) = 0.$$

Where P is the composition of a permutation matrix permuting the tensor factors by the cycle (16)(25)(34) and $C^{\otimes 3} \times I^{\otimes 3}$ (C is the charge conjugation matrix). $\mathrm{Det}|_{\Lambda}$ is the determinant of the matrix restricted in subspace Λ spanned by admissible colours (see Theorem 6.7). We expect one can derive more obstructions using the whole planar algebra structure.

Next, we examine the corresponding equivariantization theory $\mathcal{D}^{\mathbb{Z}/2\mathbb{Z}}$ and obtain the modular data in terms of the modular data of the original modular category \mathcal{C} ,

Theorem 1.4. *Let S', S^{eq} denote the S (unnormalized) matrix for \mathcal{C} and the gauged theory $\mathcal{D}^{\mathbb{Z}/2\mathbb{Z}}$ respectively. We have S^{eq} is symmetric, unitary and*

$$\begin{aligned} S_{(XY),(ZW)}^{eq} &= 2(S'_{X,Z}S'_{Y,W} + S'_{X,W}S'_{Y,Z}) \\ S_{(XY),(Z,\epsilon)}^{eq} &= 2S'_{X,Z}S'_{Y,Z} \\ S_{(X,\epsilon_1),(Y,\epsilon_2)}^{eq} &= (S'_{X,Y})^2 \\ S_{(XY),(\hat{Z},\epsilon)}^{eq} &= 0 \\ S_{(X,\epsilon_1),(\hat{Y},\epsilon_2)}^{eq} &= \epsilon_1\delta^2 S'_{X,Y} \\ S_{(\hat{X},\epsilon_1),(\hat{Y},\epsilon_2)}^{eq} &= \epsilon_1\epsilon_2\eta^{-1}\theta_X^{1/2}\theta_Y^{1/2}(S'T^2S')_{X,Y} \end{aligned}$$

Our results coincide with those in [3], [7] and [28], which are in the setting of conformal field theory. In particular, we obtain the formulas for the fusion rules which generalize the result in [14] to any modular category \mathcal{C} .

Finally, as an application to the Property F conjecture [35], we show

Theorem 1.5. *the symmetric mapping class group representations (associated with closed surfaces) for weakly group theoretical modular categories have finite images.*

The structure of the paper is as follows. In section 2 we review the preliminaries of unitary modular categories, the gauging process and planar algebras. In section 3, we discuss the lifting problem of a shaded planar algebra to an unshaded planar algebra and provide a sufficient condition using certain braiding structures on the even part of the planar algebras. In section 4, we define the generalized configuration spaces $Cf(n, \mathcal{Z})$, the operations among them and check the compatibility among these operations. In section 5, we prove Theorem 1.1 and 1.2. In section 6, we give some applications, and in particular, we prove Theorem 1.3 and derive many identities among modular data and beyond,

including the identity 1. In section 7, we examine the equivariantization theory and prove Theorem 1.4. Finally, In section 8, we prove Theorem 1.5, and discuss some questions and future directions.

ACKNOWLEDGEMENT

The authors would like to thank Y. Kawahigashi, I. Runkel, F. Xu for discussions and E. Rowell for useful comments on the preprint. This work was supported by Beijing Municipal Science & Technology Commission [Z221100002722017 to Z.L. and Y.R.]; Beijing National Science Foundation Key Programs [Z220002 to Z.L.]; China's National Key R&D Programmes [2020YFA0713000 to Z.L.].

2. SOME BACKGROUND

2.1. Preliminaries of modular category. We assume the readers are familiar with the notion of unitary modular categories and the corresponding graphic calculus for them. One may refer to [15][2][37] for more details.

Let \mathcal{C} be a unitary modular category, now we fix some notation and review some useful graphic calculus identities in \mathcal{C} .

2.1.1. Notations.

- \dashv : the dual functor, \bar{X} , \bar{f} ,
- \dagger : Involutive antilinear contravariant endofunctor from the unitary structure,
- d_X : quantum dimension of the object X ,
- μ : global dimension of \mathcal{C} , $\mu = \dim(\mathcal{C}) = \sum_{V \in \text{irr}(\mathcal{C})} d_V^2$,
- δ : the positive square root of μ ,
- Ω : the Kirby colour $\sum_{V \in \text{irr}(\mathcal{C})} d_V V$,
- θ_X^\pm : the twist for X ,
- $\theta_X^{\pm 1/2}$: We pick a family of square root of twists, such that $\theta_V^{1/2} = \overline{\theta_V^{1/2}}$ for $V \in \text{irr}(\mathcal{C})$ and define $\theta_{V \oplus W}^{1/2} = \theta_V^{1/2} Id_V \oplus \theta_W^{1/2} Id_W$. In particular, $\theta_V^{1/2} = \overline{\theta_V^{1/2}}$.
- p^\pm : $p^\pm = \sum_{V \in \text{irr}(\mathcal{C})} \theta_V^\pm d_V^2$, $p^+ p^- = \mu$,
- η : $\eta = \frac{p^+}{\delta}$, $\eta^{-1} = \frac{p^-}{\delta}$.

Next we introduce some graphic notations. The diagrams are read from top to bottom.

- The positive (negative) twists are denoted by the unfilled (filled) circle. We also denote The corresponding square root of the twists by unfilled (filled) diamond symbol for simplicity.

$$\begin{array}{cccc} \begin{array}{c} \circ \\ | \\ X \end{array} =: \theta_X & \begin{array}{c} \bullet \\ | \\ X \end{array} =: \theta_X^{-1} & \begin{array}{c} \diamond \\ | \\ X \end{array} =: \theta_X^{1/2} & \begin{array}{c} \blacklozenge \\ | \\ X \end{array} =: \theta_X^{-1/2} \end{array}$$

- If the trivial object $1 \in X$ with multiplicity one, We use the unfilled square attached to the end of a strand(labeled by X) to denote the projection $X \mapsto 1$ or the inclusion $1 \mapsto X$.

$$\begin{array}{c} X \\ | \\ \square \end{array} := X \mapsto 1 \quad \begin{array}{c} \square \\ | \\ X \end{array} := 1 \mapsto X$$

- the \dagger structure is given by the vertical reflection.

2.1.2. *Graphic calculus identities.* We use the red colored strands to indicate the strand is colored by Ω .

- Twist property: $\theta_{X \otimes Y} = c_{Y,X} c_{X,Y} \theta_X \otimes \theta_Y$.

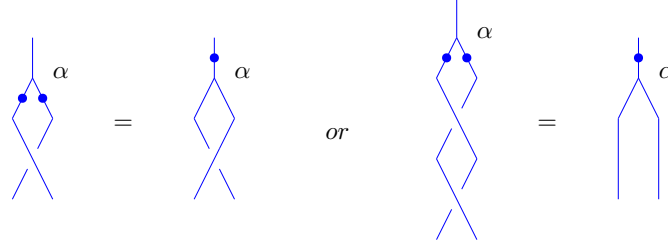

- Cutting property of Ω .

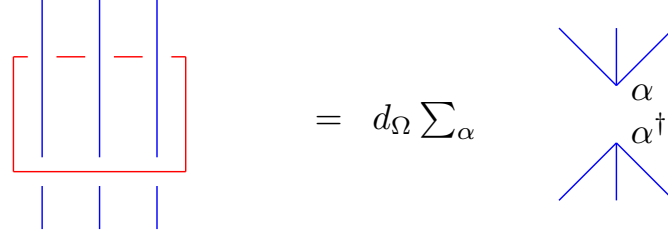

- Handle slide property of Ω

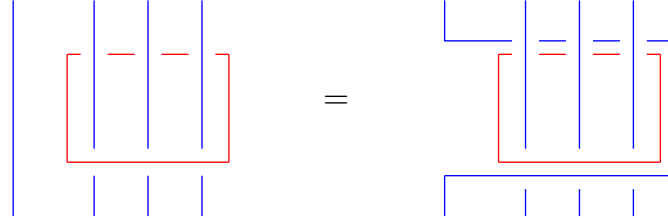

2.2. **Preliminaries of gauging process.** We refer to [40, Appendix 5], [13, Sec. 4] and [10] for more details on the (unitary) G -crossed braided fusion category

Definition 2.1. A (unitary) G -crossed braided fusion category \mathcal{C}_G^\times is a (unitary) fusion category with

- (Unitary) action of G on \mathcal{C}_G^\times .
- Faithful G -grading $\mathcal{C}_G^\times = \bigoplus_{g \in G} \mathcal{C}_g$.
- G -braiding: (unitary) natural isomorphisms

$$c_{X,Y} : X \otimes Y \rightarrow g(Y) \otimes X, \quad g \in G, X \in \mathcal{C}_g, Y \in \mathcal{C}_G^\times,$$

- Compatibility: 1. $g(\mathcal{C}_h) = \mathcal{C}_{ghg^{-1}}, \forall g, h \in G$,
2. $g(c_{X,Y}) = c_{g(X),g(Y)}, \forall g, h \in G$,
3. some coherence, for example see [13, Def. 4.41]

Definition 2.2. Let \mathcal{C} be a fusion category, G be a finite group acting on \mathcal{C} . For any $g \in G$ let $\rho_g \in \underline{\text{End}(\mathcal{C})}$ be the corresponding action, and for any $g, h \in G$ let $\gamma_{g,h}$ be the isomorphism $\rho_g \circ \rho_h \cong \rho_{gh}$. The equivariantization of \mathcal{C} is a category \mathcal{C}^G :

- **Object:** G -equivariant objects of \mathcal{C} , which is an object $X \in \mathcal{C}$ together with isomorphisms $u_g : \rho_g(X) \cong X$ such that the diagram

$$\begin{array}{ccc} \rho_g(\rho_h(X)) & \xrightarrow{\rho_g(u_h)} & \rho_g(X) \\ \gamma_{g,h}(X) \downarrow & & \downarrow u_g \\ \rho_{gh}(X) & \xrightarrow{u_{gh}} & X \end{array}$$

commutes for all $g, h \in G$.

- **morphism:** morphisms in \mathcal{C} commuting with u_g .

We refer to the [29],[9] and [13, Sec. 4] for more details and we summarize some known results about the G -equivariantization category.

- \mathcal{C}^G is a fusion category.
- \mathcal{C} is unitary, then \mathcal{C}^G is unitary by requiring u_g are unitary isomorphisms [10]
- If \mathcal{C} is a G -crossed braided fusion category, then \mathcal{C}^G is a braided fusion category, with the braiding \tilde{c} defined as the composition

$$X \otimes Y \xrightarrow{c_{X,Y}} g(Y) \otimes X \xrightarrow{u_g \otimes id_X} Y \otimes X$$

in addition, \mathcal{C}_1 is modular $\Leftrightarrow \mathcal{C}^G$ is modular, where \mathcal{C}_1 is the trivial grading part of \mathcal{C}

- $\dim(\mathcal{C}^G) = |G| \dim(\mathcal{C})$
- The simple objects are parameterized by pairs $([X], \pi_X)$, where $[X]$ is an orbit of the G -action on simple objects of \mathcal{C} , and π_X is an irreducible projective representation of G_X (stabilizer group of X).
- $\dim([X], \pi_X) = \dim(\pi_X) \dim_{\mathcal{C}}(X) N_{[X]}$, where $N_{[X]}$ is the size of the orbit $[X]$.

Definition 2.3. [10] Let \mathcal{C} be a unitary modular category with a global symmetry (G, ρ) , Gauging is the two-step process:

- **G -extension:** Extend \mathcal{C} to a G -crossed braided fusion category \mathcal{C}_G^\times .
- **Equivariantization:** \mathcal{C}_G^\times is equivariantized to a new unitary modular category $\mathcal{C}_G^{\times,G}$.

2.3. Preliminaries of planar algebra. The planar algebra was introduced by Vaughan Jones [27] as an axiomatization of standard invariant of subfactors. We refer to the following references for more details on the definition and relation to the category theory.

- finite depth unshaded planar algebras and fusion categories. [8, Sec. 2] [33, Sec. 4.1]
- shaded planar algebra and 2-category [19]

Remark 2.1. It will be convenient to make the following simplifications and technical restrictions of our illustration of planar algebras.

- Arcs intersect only the bottom boundary of input disks and output disks. And they cross the boundary of the output disk orthogonally.
- The boundary of the disks and the arcs are all smooth. The corners appearing in the diagram are only for simplicity.
- We will often omit the output disks.
- We omit the $\$$ sign of the planar diagram if it is on the left.

It is noteworthy to present some special tangles, which give important structures of the planar algebra.

Definition 2.4. *The algebra structure on $\{P_{2n}\}_{n \geq 0}$ is given by the following tangles (they are special cases of the general graded product defined in [22]).*

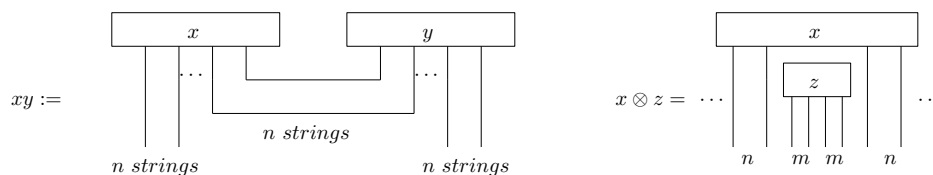

Definition 2.5. *A unitary structure on a (shaded) planar algebra is an antilinear involution Θ_1 on the P_n , such that it is compatible with the reflection of the tangle. And the following pairing defines a positive definite inner product.*

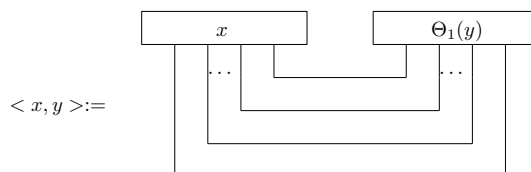

The braiding on the certain planar algebra was discussed in [33]. They showed that braiding is a partial braiding in the sense that, away from certain input disks, diagrams in the planar algebra are equal up to framed three-dimensional isotopy. However the isotopy gives additional factors when going through these input disks [33, Thm. 3.2].

Here we will define a generalized notion of braidings on an unshaded planar algebra.

Definition 2.6. *A $\mathbb{Z}/2\mathbb{Z}$ braiding on an unshaded planar algebra is a braiding such that*

- *there is an $\mathbb{Z}/2\mathbb{Z}$ planar algebra action ρ on P_n (respect all the planar algebra structures including the braiding).*
- *Away from the input disks, the partition function Z is invariant under framed three-dimensional isotopy.*
- *Strands can be isotoped above input disks. But being isotoped below input disks introduces the action ρ on these input disks.*
- *The braiding is unitary when the underlying planar algebra is unitary.*

Now to construct a planar algebra with a $\mathbb{Z}/2\mathbb{Z}$ braiding, it is enough to define certain generating tangles and verify certain list of relations, see for example [27], [41] and [26]. Here we will briefly summarize the construction.

One defines the generic planar tangle such that the number of singular points (cap, cup, input disc, crossing) is finite and they are distinct with respect to the height function. Now any planar tangle can be deformed to a generic one and thus can be assigned a map using defined generators. The isotopic (framed three-dimensional isotopy away from input disks) generic planar algebras can be related through the following moves.

- framed three-dimensional isotopy in the class of generic planar algebra. (Reidemeister moves)
- Interchanging the order of two singular points with respect to the height function.
- Birth or annihilation of a pair of local extrema.
- Moving the braiding singularity along caps and cups.
- 2π -rotation invariance.

Which will give the relations among generators to ensure the assigned maps are well-defined.

3. LIFTING THE SHADED PLANAR ALGEBRA

In this section we will discuss the lifting problem of a shaded planar algebras to unshaded ones, the goal is to give a sufficient condition in terms of certain braiding structures on the even part of the shaded planar algebra.

Definition 3.1. [31, Def. 1.3] *A shaded planar algebra $(\mathcal{P}_+, \mathcal{P}_-)$ is called **self-dual**, if there are isomorphisms $\Phi_{\pm} ((\Phi_+, \Phi_-) : (\mathcal{P}_+, \mathcal{P}_-) \rightarrow (\mathcal{P}_-, \mathcal{P}_+))$, satisfying shaded planar algebra isomorphism: natural with respect to the tangle action (with the color flipped). Moreover the shaded planar algebra is **symmetrically self-dual** if $\Phi_{\mp} \circ \Phi_{\pm} = 1_{\mathcal{P}_{\pm}}$.*

In [31], the authors proved the following theorem.

Theorem 3.2. [31, Thm. A] *Given a symmetrically self-dual shaded planar algebra $(\mathcal{P}, \Phi_{\pm})$, it can be lifted to an unshaded planar algebra.*

Next, we will define certain $\mathbb{Z}/2\mathbb{Z}$ braiding structures on the (shaded) planar algebra.

Definition 3.3. *The $\mathbb{Z}/2\mathbb{Z}$ braiding structure is defined to be a sequence of tangles.*

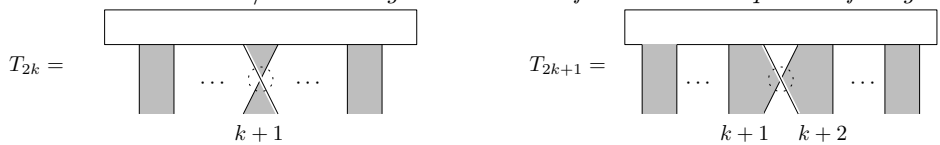

which satisfies the following relations (including all possible braidings and ways of shading).

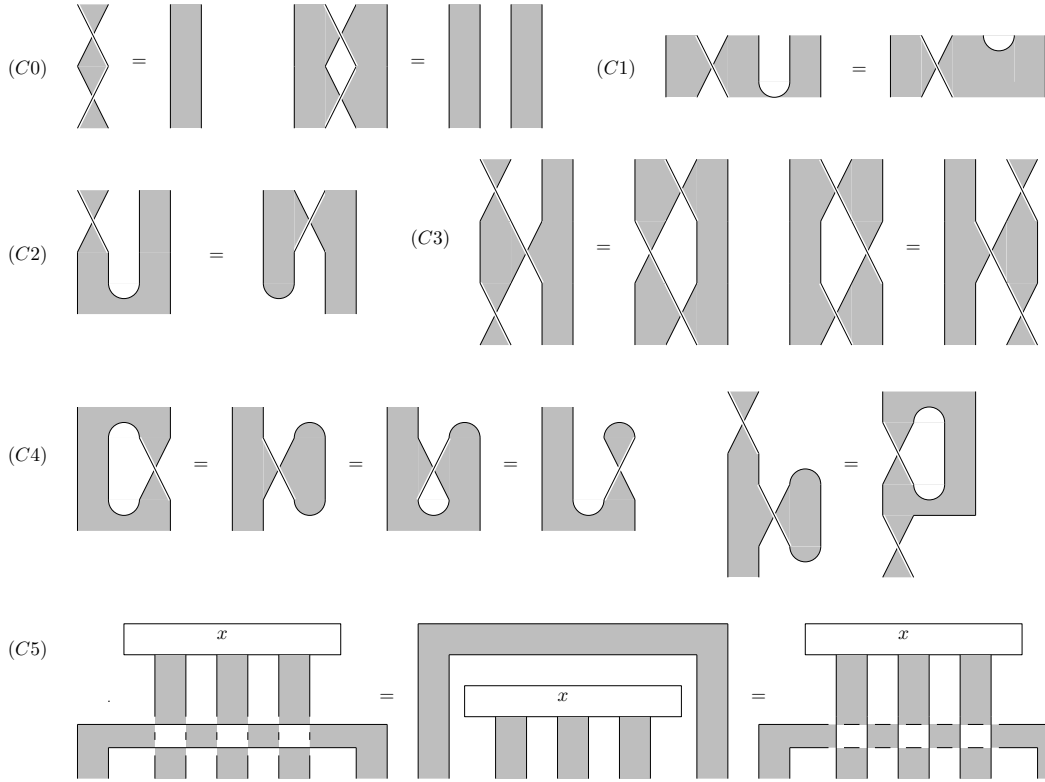

- Remark 3.1.*
- (C1) indicates the compatibility of interchanging the order of braiding singularity and caps or cups with respect to the height function. For interchanging singularities of other types are inherited in the definition of shaded planar algebra.
 - (C4) is the analogy of twists in the shaded version. We omit several relations there for simplicity: the similar equalities hold with the twist in the first strand, a positive twist and a negative twist in the same strand can be canceled.
 - (C5) is well-defined relation once (C2) is satisfied, since one can move the braiding singularities freely along the cap and cups. One can compare (C5) with the symmetrically self-duality (Definition 3.1).
 - All the strands can be labeled here, then the relations with all possible labels should be satisfied.

Lemma 3.4. *The $\mathbb{Z}/2\mathbb{Z}$ braiding induces a $\mathbb{Z}/2\mathbb{Z}$ action ρ on $P_{n,+}$. In particular, $\rho(x) \otimes \rho(y) = \rho(x \otimes y)$ and $\rho(x)\rho(y) = \rho(xy)$.*

Proof. The action ρ is given by the following tangle, the equality follows from (C3). Where $c > 0$ is

the loop value of the original shaded planar algebra $\bigcirc = c$, which depends on the label of the

loops.

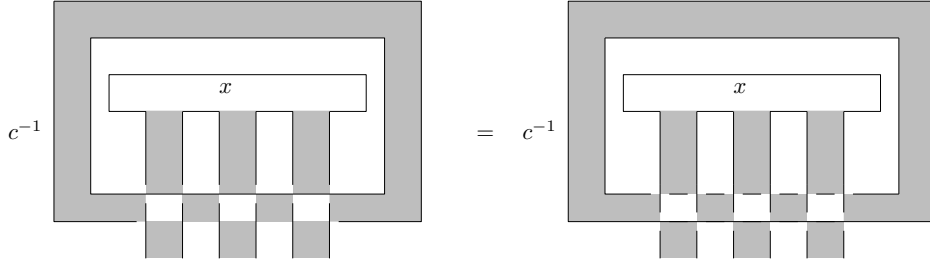

from (C3) it is a planar algebra action (commute with all the planar tangle actions) and respects the braiding. Together with (C5), one has it is a $\mathbb{Z}/2\mathbb{Z}$ action. \square

Theorem 3.5. *If there exists a $\mathbb{Z}/2\mathbb{Z}$ braiding structure on the even part of a shaded planar algebra, then it can be lifted to an unshaded planar algebra together with a $\mathbb{Z}/2\mathbb{Z}$ braiding.*

Proof. Now we define a unshaded planar algebra \mathcal{P}^u , the idea is similar to the [31, Def. 1.6,1.7]:

- $P_{2n}^u := P_n$, $P_{2n+1}^u := \emptyset$
- Given an unshaded tangle \mathbb{U} , we give it checkerboard shading such that the region meeting the distinguished interval of the output disk is unshaded. Now if the distinguished interval of an input disk is in a shaded region, then we put a circle above or below as follows, scaled by $c^{-1/2}$.

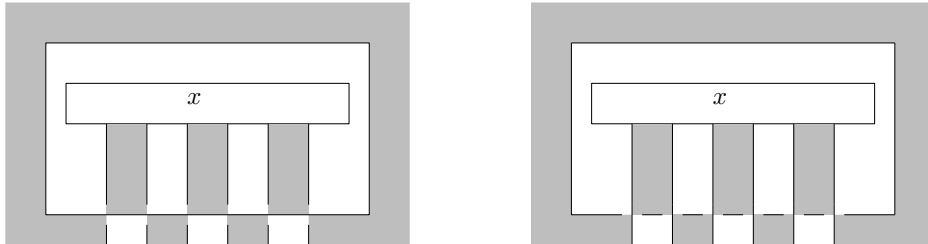

Next, we prove this is indeed a planar algebra with $\mathbb{Z}/2\mathbb{Z}$ -braiding. The isotopy invariance follows from 1.the planar isotopy invariance of the shaded ones, 2.the isotopy involving braidings away from input disks: (C0) – (C4) and 3.the isotopy through input disks: Corollary 3.6. The proof of $Z(U \circ_i V) = Z(U) \circ_i Z(V)$ follows similarly to the proof of [31, Thm A], one just replaces their Φ_{\pm} operator by our attaching circle operation, and the symmetrically self-duality is replaced by (C5). \square

Now we fix a choice when constructing the unshaded planar algebra by attaching a circle from above.

Corollary 3.6. *In the unshaded planar algebra \mathcal{P}^u , we have the following identities.*

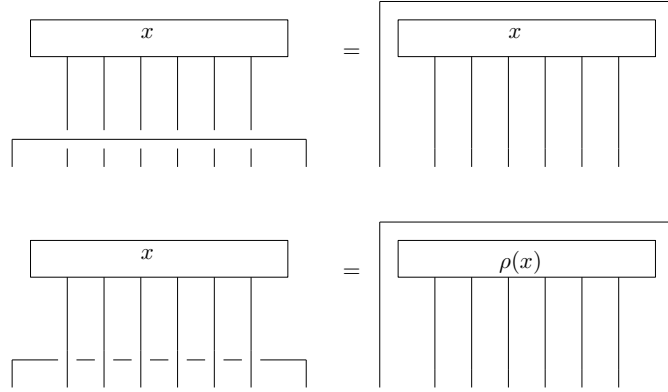

Proof. There are two cases depending on the shading of the input disk labeled by x on the left-hand side, if it is shaded, then we attach a circle by definition, apply (C5) and take out the unshaded disk (for the second equality, one need to use the diagrammatic description of the action in Lemma 3.4). If it is unshaded, then the input disk on the right-hand side is shaded, again we attach a circle, apply (C5) and also Lemma 3.4. \square

4. GRAPHIC CALCULUS IN THE CONFIGURATION SPACE

In this section, we will define new configuration spaces generalizing those in [32], and several operations on them.

Let \mathcal{C} be a unitary modular category, consider the category $\mathcal{C}^{\boxtimes 2}$, and the Frobnius algebra $\gamma = \bigoplus_X X \boxtimes \bar{X}$. In [32], they identify the space $\text{Hom}(1, \gamma^{\otimes n})$ with the configuration space $\text{Conf}(\mathcal{C})_{n,2}$, which is a Hilbert space and the orthonormal basis is given in [32].

Now we consider the generalization to the case involving simple objects of the form (not symmetric) $Z_{2i-2} \boxtimes Z_{2i-1}$. Let \mathcal{Z} denote the ordered set $(Z_k)_{0 \leq k \leq 2n-1}$, We define the configuration space $Cf(n, \mathcal{Z}) := \text{Hom}_{\mathcal{C}^{\boxtimes 2}}(1, \otimes_{i=1}^n \gamma Z_{2i-2} \boxtimes Z_{2i-1})$, when all Z'_i 's are trivial, we denote corresponding configuration space simply by $Cf(n)$. The configuration space is now spanned by the following vectors. (The blue vertical lines are labeled by the simple objects in \mathcal{C} similar as [32, Sec. 2.2])

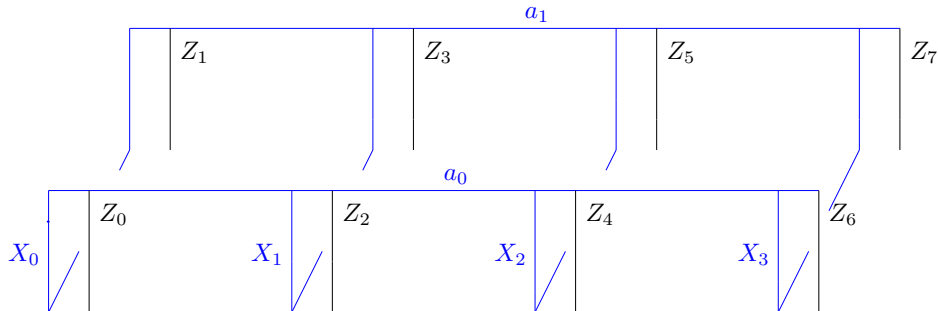

Since we only have two layers, we will simply denote $\vec{X} := (X_k)_{0 \leq k \leq n-1}$ and we define $d_{\vec{X}} = \prod_{k=0}^{n-1} d_{X_k}$.

Now we define some operations ρ_1 , Θ_2 in \mathcal{C} which is similar as in [32].

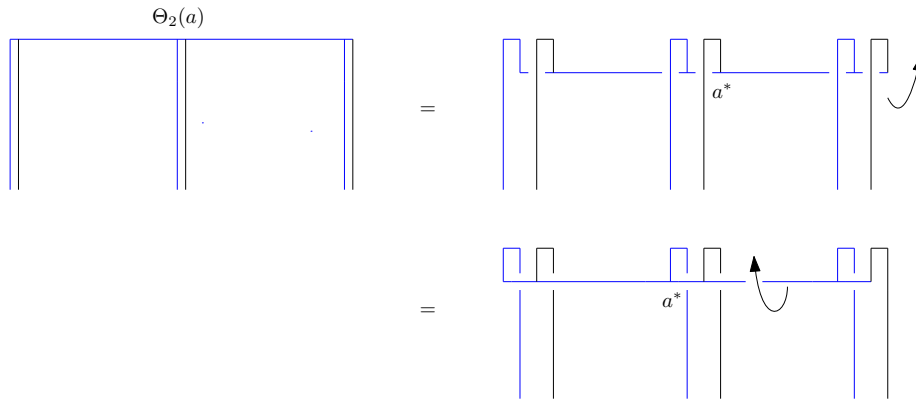
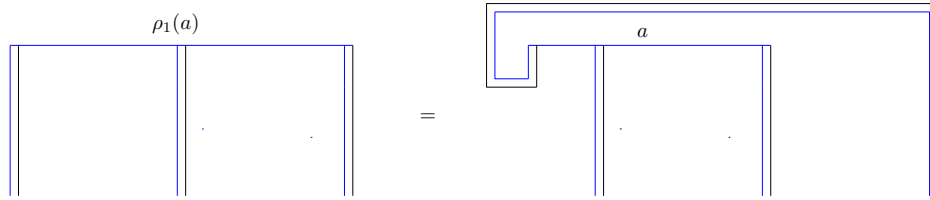

One can view the Θ_2 action as bending the morphisms along the indicated directions. The next lemma will be used frequently and follows directly from the definition of Θ_2 and the graphic calculus in \mathcal{C} .

Lemma 4.1. *The following morphisms in \mathcal{C} are equal (the red strand is labeled by Ω)*

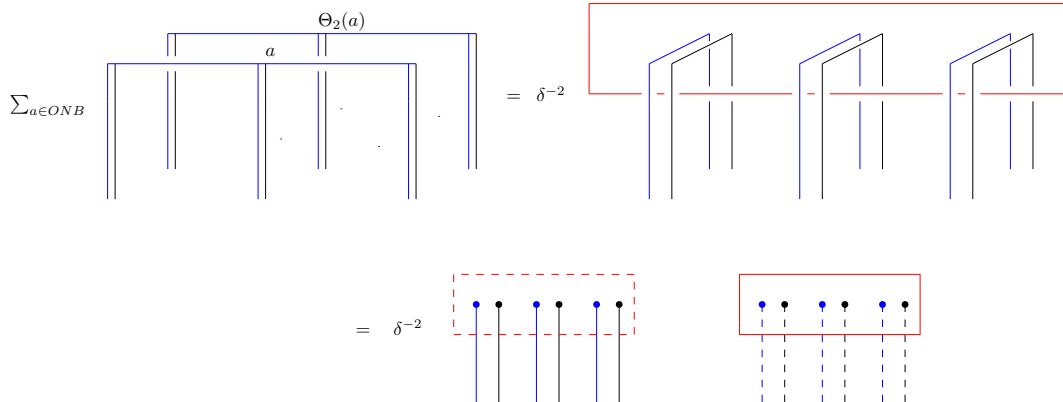

Here we also introduce the new diagrammatic notation for simplicity, the 3D diagram will now be interpreted by a pair of 2D diagrams, one is for the front layer and the other one is for the back

layer. the small dot on the boundary of an edge indicates it connects with the other layer through Y -direction, the dashed strands are underneath other strands.

Remark 4.1. The inner product $\langle a, a' \rangle$ for a, a' in the configuration space is the obvious one given by the evaluation in \mathcal{C} of a composed with the vertical reflection of a' . Therefore in most cases we will use Lemma 4.1 to simplify our calculations. We will simply denote the orthonormal basis in configuration space by Cf_{ONB} .

The operations act among the configuration spaces as follows (similarly as in [32]).

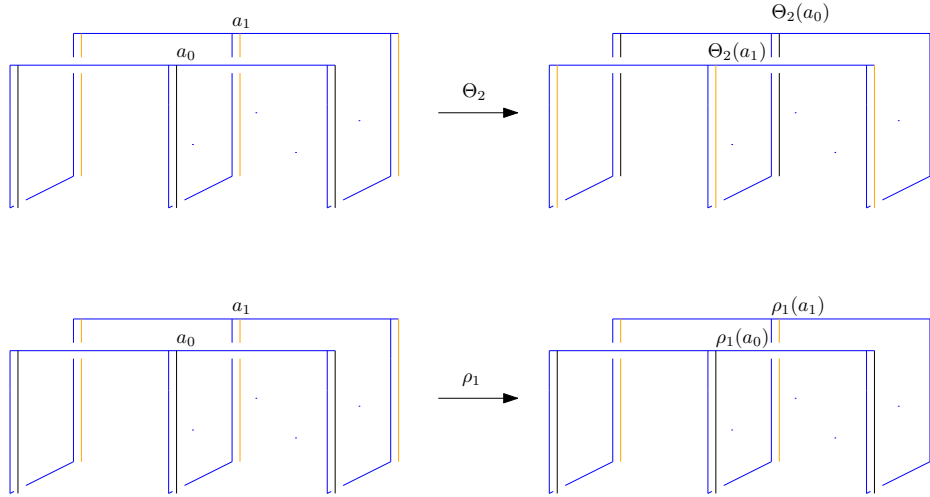

And we will simply use $Cf(n, \Theta_2(\mathcal{Z}))$, $Cf(n, \rho_1(\mathcal{Z}))$ to denote corresponding target spaces.

Next we define a bilinear form generalizing pairing defined in [32, Sec. 2.3], Let $F(\mathcal{Z}) = (Z_k)_{1 \leq k \leq 2n}$ with $Z_{2n} := Z_0$.

Definition 4.2. Now for $a \in Cf(n, \mathcal{Z})$ and $a' \in Cf(n, F(\mathcal{Z}))$, we define the value of the pairing $\mathcal{L}(a, \Theta_2(a'))$ to be the value of the diagram 1 (where a is blue and a' is purple), the coefficient is equal to $\delta^{1-n} \sqrt{d_{\vec{X}}} \sqrt{d_{\vec{Y}}}$.

The Fourier transform $\mathcal{F} : Cf(n, \mathcal{Z}) \rightarrow Cf(n, F(\mathcal{Z}))$ is now defined by

$$\mathcal{F}(a) = \sum_{a' \in Cf_{ONB}} \mathcal{L}(a, \Theta_2(a')) a'.$$

Example 4.3. the Fourier pairing on $Cf(2)$ with the canonical basis is the same as the S -matrix of \mathcal{C} [32, Thm. 6.8].

Example 4.4. The Fourier pairing between $Cf(2, \mathcal{Z})$ and $Cf(2, F(\mathcal{Z}))$, where $\mathcal{Z} = (Z, 1, 1, 1)$, is given by the following,

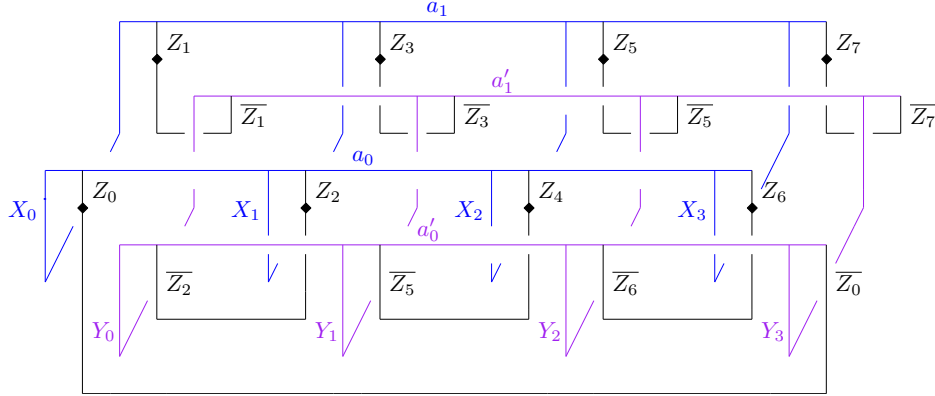
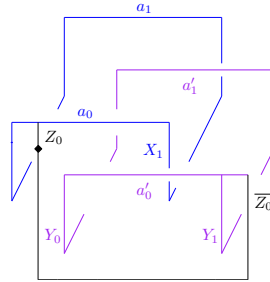

FIGURE 1. Fourier pairing



which can be viewed as a S -matrix of once punctured torus.

4.1. Inclusion and contractions. In this subsection, we will define certain operations on the configuration spaces, and study their compatibility with the Fourier transform.

We first define the contractions and inclusions.

Definition 4.5. *The contraction and inclusion $\phi_k : Cf(\mathbb{C})_{n,z} \rightarrow Cf(\mathbb{C})_{n-1,\phi_k(z)}$, $\iota_k : Cf(\mathbb{C})_{n,z} \rightarrow Cf(\mathbb{C})_{n+1,\iota_k(z)}$ ($\phi_k(z)$ and $\iota_k(z)$ are defined accordingly) are defined by stacking the following diagrams on the bottom. The sum is for all $0 \leq i \leq n-1$, $X_i, Y, Y', Z \in Irr(\mathbb{C})$ and all orthonormal basis α in corresponding Hom spaces. The global coefficient is $\delta^{1/2}$ for ϕ_{2k}, ι_{2k} , $\delta^{-1/2}$ for $\phi_{2k+1}, \iota_{2k+1}$.*

$$\begin{aligned}
\phi_{2k} &= \sum_{i, X_i, Y, \alpha} \sqrt{d_{X_k}} \cdots \left| \begin{array}{c} Z_{2k-2} \\ \vdots \\ Z_{2k-1} \\ \bar{X}_{k-1} \end{array} \right|_{k-1} \left| \begin{array}{c} X_k \\ Z_{2k} \\ \alpha \end{array} \right|_k \left| \begin{array}{c} \bar{X}_k \\ Z_{2k+1} \\ \theta_2(\alpha) \end{array} \right|_{k+1} \left| \begin{array}{c} Z_{2k+2} \\ \vdots \\ Z_{2k+3} \\ \bar{X}_{k+1} \end{array} \right|_{k+1} \cdots \\
\phi_{2k+1} &= \sum_{i, X_i, Y, \alpha} \sqrt{d_{X_k} d_{X_{k+1}} d_Y} \cdots \left| \begin{array}{c} Z_{2k-2} \\ \vdots \\ Z_{2k-1} \\ \bar{X}_{k-1} \end{array} \right|_{k-1} \left| \begin{array}{c} X_k \\ Z_{2k} \\ Y \\ \alpha \end{array} \right|_k \left| \begin{array}{c} \bar{X}_k \\ Z_{2k+1} \\ X_{k+1} \\ \theta_2(\alpha) \\ \bar{X}_{k+1} \\ Z_{2k+3} \\ X_{k+2} \end{array} \right|_{k+1} \left| \begin{array}{c} Z_{2k+4} \\ \vdots \\ Z_{2k+5} \\ \bar{X}_{k+2} \end{array} \right|_{k+1} \cdots \\
\iota_{2k} &= \sum_{i, X_i, Y, Z, \alpha} \sqrt{d_Y} \cdots \left| \begin{array}{c} Z_{2k-2} \\ \vdots \\ Z_{2k-1} \\ \bar{X}_{k-1} \end{array} \right|_{k-1} \left| \begin{array}{c} Y \\ Z \\ \alpha \end{array} \right|_k \left| \begin{array}{c} \bar{Y} \\ Z \\ \theta_2(\alpha) \\ \bar{Z} \end{array} \right|_{k+1} \left| \begin{array}{c} Z_{2k} \\ \vdots \\ Z_{2k+1} \\ \bar{X}_k \end{array} \right|_{k+1} \cdots \\
\iota_{2k+1} &= \sum_{i, X_i, Y, Y', Z, \alpha} \sqrt{d_{X_k} d_Y d_{Y'}} \cdots \left| \begin{array}{c} Z_{2k-2} \\ \vdots \\ Z_{2k-1} \\ \bar{X}_{k-1} \end{array} \right|_{k-1} \left| \begin{array}{c} X_k \\ Z_{2k} \\ Y \\ \alpha \\ \bar{Y} \\ Y' \\ Z \end{array} \right|_k \left| \begin{array}{c} \bar{X}_k \\ Z_{2k+1} \\ X_{k+1} \\ \theta_2(\alpha) \\ \bar{X}_{k+1} \\ Z_{2k+3} \\ X_{k+2} \end{array} \right|_{k+1} \left| \begin{array}{c} Z_{2k+4} \\ \vdots \\ Z_{2k+5} \\ \bar{X}_{k+2} \end{array} \right|_{k+1} \cdots
\end{aligned}$$

Now we examine some properties of ϕ_k, ι_k .

First of all one verify ϕ_k, ι_k satisfy "zig-zag" relations:

Lemma 4.6. *The following identities hold*

$$\begin{aligned}
\phi_{2k-1} \circ (Id \otimes \iota_{2k}) &= (Id \otimes \phi_{2k}) \circ \iota_{2k-1} = Id \\
\phi_{2k-1} \circ (\iota_{2k-2} \otimes Id) &= (\phi_{2k-2} \otimes Id) \circ \iota_{2k-1} = Id
\end{aligned}$$

Proof. We will prove the first identity, and the second one follows similarly. The proof is given by the graphic calculus below and we omit the labels and summations.

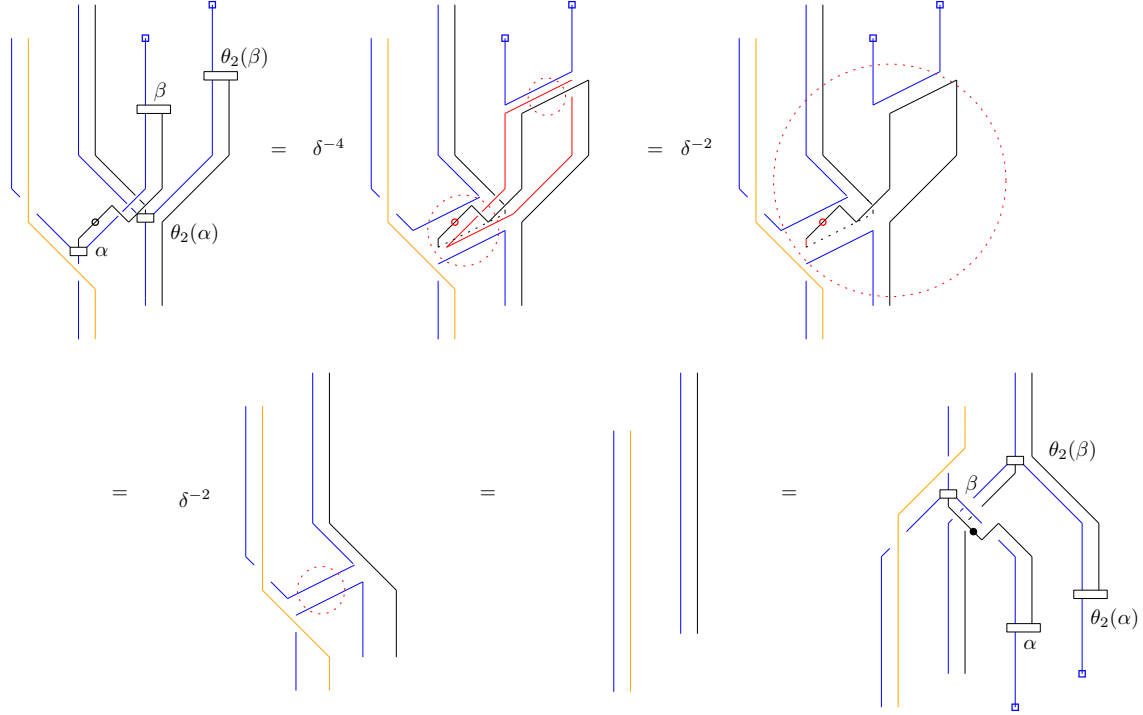

The square root of quantum dimension coefficients for ϕ_k , ι_k make the pair of blue lines connecting two boxes in the first diagram become a red circle (Kirby color), combined with Lemma 4.1, the first equality now follows, the next ones followings from using isotopy and the cutting property of the Kirby color. \square

Remark 4.2. As in the proof of Lemma 4.6, apart from the lemma 4.1, the step of changing a pair of blue-colored lines (with suitable coefficients) connecting two boxes into a red-colored circle will also be used frequently.

Lemma 4.7. Let $\hat{Z} := \bigoplus_{Z \in \text{irr}(\mathcal{C})} Z$, we have for $x \in Cf(n, \mathbb{Z})$ and $y \in Cf(n-1, \mathbb{Z})$

$$\begin{aligned}
 (2) \quad & \phi_k \iota_k = \delta d_{\hat{Z}}, \\
 & \mathcal{L}(\phi_{2k} x, \Theta_2(y)) = \mathcal{L}(x, \Theta_2 \iota_{2k-1}(y)), \\
 & \mathcal{L}(\phi_{2k+1}(x), \Theta_2(y)) = \mathcal{L}(x, \Theta_2 \iota_{2k}(y)).
 \end{aligned}$$

Proof. First one observes the action of Θ_2 will change the braiding and the way of connections. Now the proof follows from the following graphic calculus

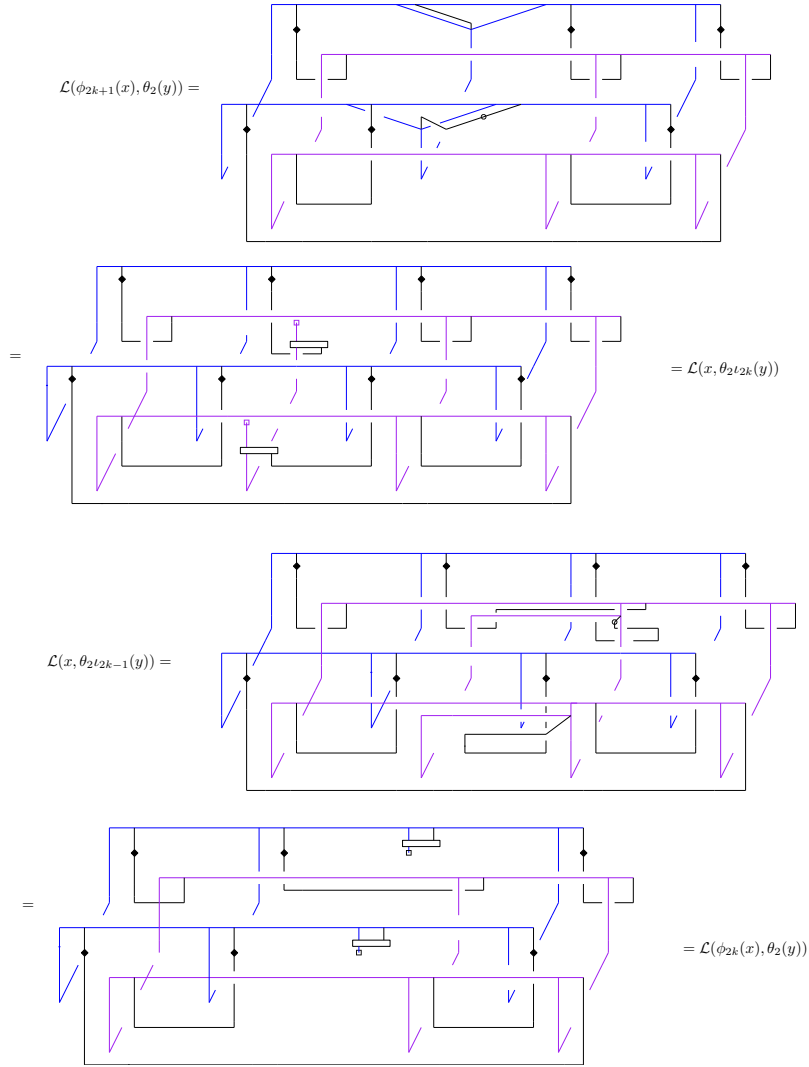

□

From Lemma 4.7, we have the following compatibility with respect to the Fourier transform.

Proposition 4.8. *We have the following identity*

$$\mathcal{F}(\phi_{k+1}(x)) = \phi_k \mathcal{F}(x).$$

Proof.

$$\begin{aligned}
\mathcal{F}(\phi_{k+1}(x)) &= \sum_y \mathcal{L}(\phi_{k+1}x, \Theta_2(y))y \\
&= \sum_y \mathcal{L}(x, \Theta_2\iota_k(y))y \\
&= \sum_{(\delta d_{\bar{z}})^{-1/2} \iota_k y} \mathcal{L}(x, \Theta_2(\delta d_{\bar{z}})^{-1/2} \iota_k(y)) \phi_k(\delta d_{\bar{z}})^{-1/2} \iota_k y \\
&= \phi_k \mathcal{F}(x)
\end{aligned}$$

□

Remark 4.3. The tensor product among configuration spaces is defined naturally by simply placing vectors next to each other.

4.2. Braiding Structure. in this section, we will define the braiding structures using the data of \mathcal{C} .

Definition 4.9. We define the braiding morphism as follows, where $T_{2k+1} = (\phi_{2k+1} \otimes Id)(Id \otimes T_{2k+2}^{-1} \otimes Id)(Id \otimes \iota_{2k+3})$ and the coefficient for T_{2k+1} is δ^{-1} ($\delta^{-1/2}$ each for ϕ_{2k+1} and ϕ_{2k+3}).

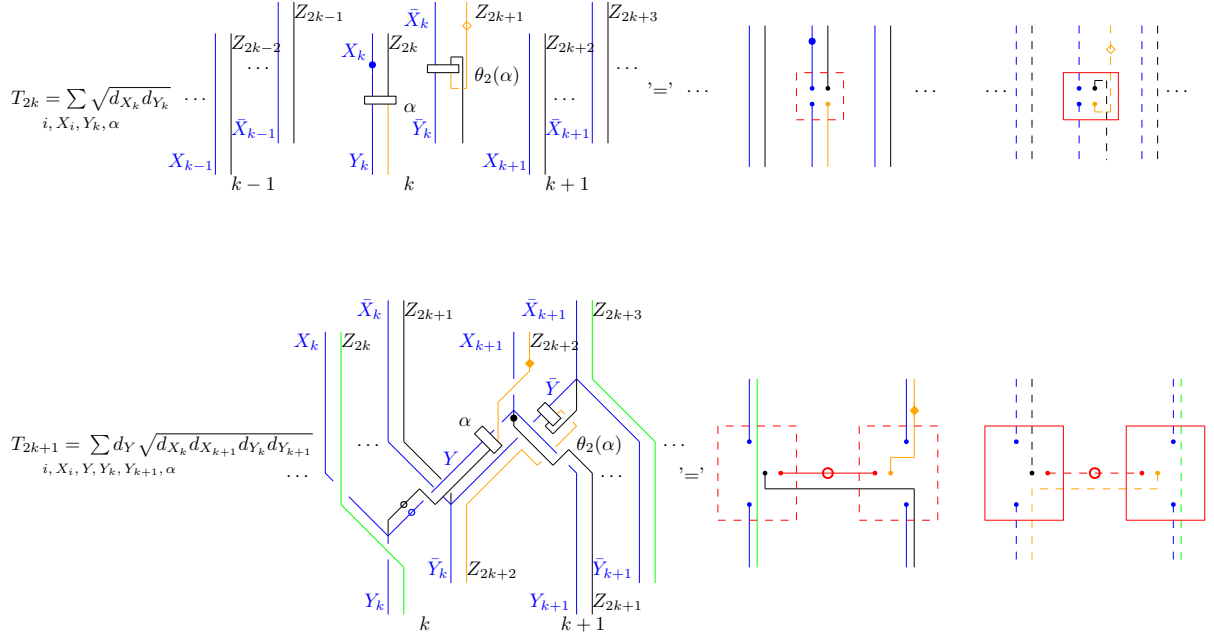

Now it is straightforward to prove operators T_k are unitary with $T_k^\dagger = T_k^{-1}$ given by the vertical reflection with corresponding dagger operation on morphisms.

Lemma 4.10. We have the following identities,

$$\mathcal{F}(T_{2k+1}(x)) = \eta T_{2k} \mathcal{F}(x)$$

Proof. We will first prove

$$(3) \quad \mathcal{L}(T_{2k+1}x, \Theta_2(y)) = \eta \mathcal{L}(x, \Theta_2 T_{2k}^{-1}(y)),$$

recall $\eta = \frac{p^+}{\delta}$ is a global constant. By the definition of the Θ_2 , we have the following identities, the second equality follows from Lemma 4.1, Remark 4.2 and using the twist property.

$$\Theta_2(T_{2k}^{-1}) = \dots \quad \dots \quad \dots = (p^+)^{-1} \dots$$

Now the identity (3) follows from transferring two diagrams below by the direct isotopy and cancellation of the twists. (Here we only draw the local diagrams for the pairing \mathcal{L} , since we already did a similar proof in Lemma 4.7 by drawing full diagrams).

$$\mathcal{L}(T_{2k+1}(x), \Theta_2(y)) = \delta^{-1} \dots = \delta^{-1} \dots = \eta \mathcal{L}(x, \Theta_2 T_{2k}^{-1}(y))$$

Now we have,

$$\begin{aligned} \mathcal{F}(T_{2k+1}(x)) &= \sum_y \mathcal{L}(T_{2k+1}x, \Theta_2(y))y \\ &= \sum \eta \mathcal{L}(x, \Theta_2 T_{2k}^{-1}(y)) T_{2k} T_{2k}^{-1}(y) \\ &= \eta T_{2k} \mathcal{F}(x) \end{aligned}$$

□

Next we show the braiding is compatible with contractions and inclusions in the sense of the next Lemma.

Lemma 4.11. *We have the identities*

$$\begin{aligned} \phi_{2k} \phi_{2k+1} T_{2k} \otimes Id &= \phi_{2k} \phi_{2k+1} Id \otimes T_{2k+2} \\ T_{2k} \otimes Id \phi_{2k+1} \phi_{2k} &= Id \otimes T_{2k+2} \phi_{2k} \phi_{2k+1} \end{aligned}$$

Proof. We only prove the first statement, the second one follows similarly

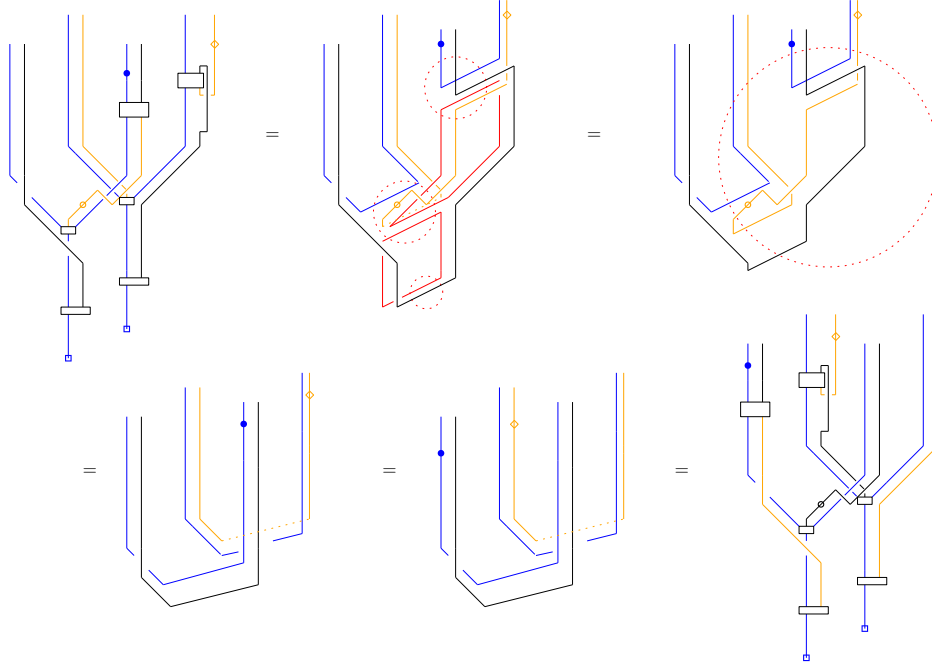

□

Now we give another diagrammatic interpretation of the Fourier transform \mathcal{F} .

Definition 4.12. We define an operator $F_{+,Z}$ in configuration space from $Cf(n, \mathcal{Z})$ to $Cf(n, F(\mathcal{Z}))$ given by the figure 2 with a δ^{-1} factor, where $Z \in \text{Obj}(\mathcal{C})$ is the color on the black strand. We denote $F_{+,1}$ by F_+ , and we also denote the operator with braiding reversed by $F_{-,Z}$ ($F_- := F_{-,1}$).

Definition 4.13. The action ρ_2 on the configuration space is defined as follows.

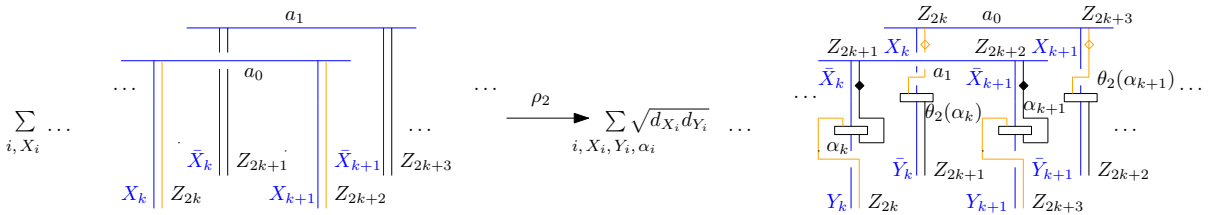

By direct graphic calculus, one gets the following lemma.

Lemma 4.14. ρ_2 is an isometry, $\rho_2^2 = 1$ and $\rho_2(x) \otimes \rho_2(y) = \rho_2(x \otimes y)$.

The next theorem is one of the main theorems that relates two definitions of the Fourier transform (fig 1 and fig 2).

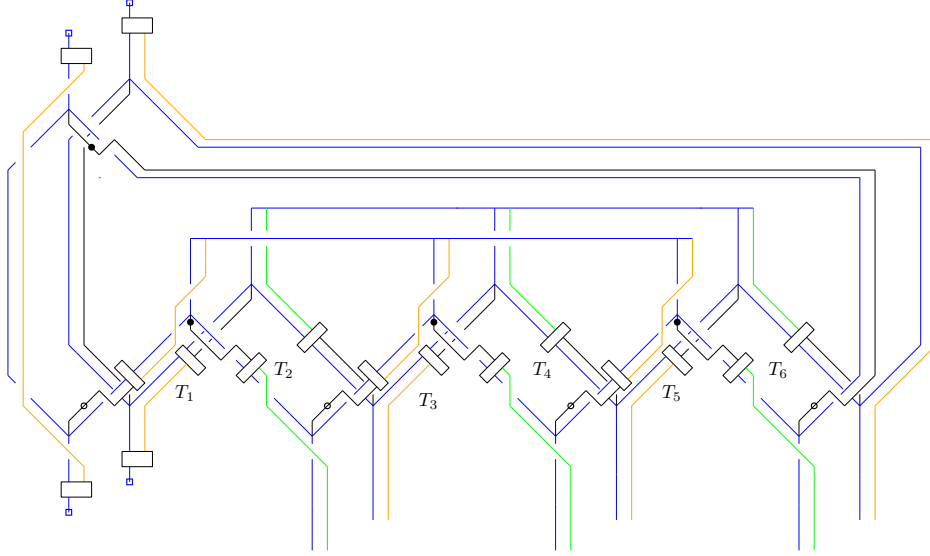
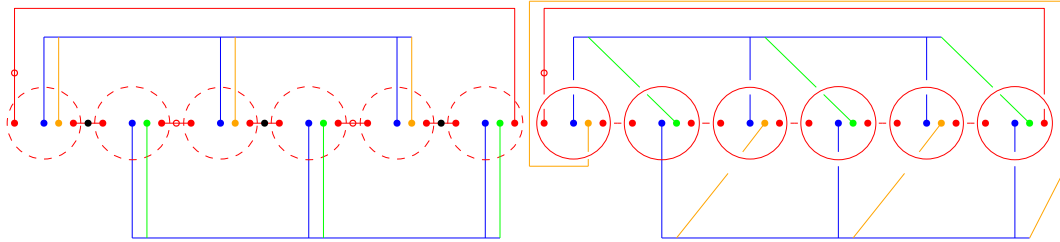

FIGURE 2. Fourier transform as an operator between configuration spaces

Theorem 4.15. *We have the following identities,*

$$\begin{aligned} \langle F_{+,Z}(x), y \rangle &= d_Z \mathcal{L}(x, \theta_2(y)) \\ \langle F_{-,Z}(x), y \rangle &= d_Z \mathcal{L}(\rho_2(x), \theta_2(y)) \end{aligned}$$

Proof. The diagram is read as discussed before, they all come from the front views, while the left ones are first layers, and the right ones are second layers, the small dot on the boundary of an edge indicates it connects with the other layer through Y -direction. surrounded by a Kirby color (dotted right circle). We want to emphasize, this is just for the simplification of notations, one can draw the 3D-diagrams, and it represents genuine morphisms in \mathcal{C} (see Lemma 4.1), the graphic calculus we use here all come from the graphic calculus of \mathcal{C} .



First, observe there are two types of red circles, we call them vertical or horizontal red circles respectively, the number of each of them is $2n$, and the twists are all on the horizontal ones. One uses definitions of the braiding and the black string is pulled out which gives the d_Z factor. By Lemma 4.1 and the definition of the ϕ, ι , we have another $(\delta^{3/2-2-2})^{2n} \delta^{-1} = \delta^{-5n-1}$ as the coefficient.

Now we use the twist property to link horizontal red circles (Kirby color) with blue and orange ones, such that the twists on the red strings are all resolved. Next using the cutting property to reduce the number of both the vertical and horizontal red circles to n , which gives a δ^{2n} factor. By sphericity and the property of the configuration space (two layers are separated), one removes the rightmost vertical red circle, which gives a δ^2 factor. Hence we have the following diagrams.

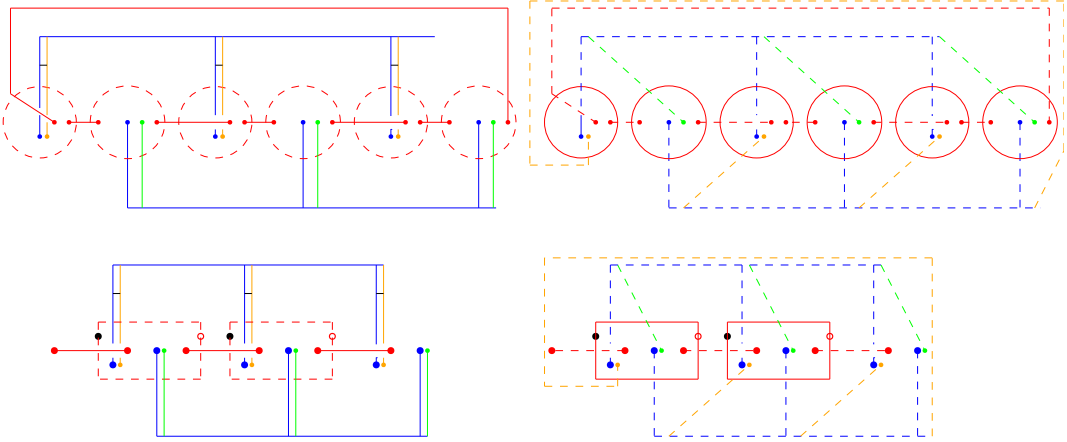

One considers the strands that go through the horizontal red circles and applies the twist property again. Next using the handle slide property of the Kirby color, we link the x, y together and all red circles are resolved, which introduces a factor of δ^{2n} . And the coefficient now is equal to $d_Z \delta^{-5n-1+2n+2+2n} = d_Z \delta^{1-n}$ and the terms of the square roots of the object quantum dimensions appear as in the definition of the contraction and inclusion (Def.4.5), which is the same as d_Z times the coefficient in the definition of \mathcal{L} .

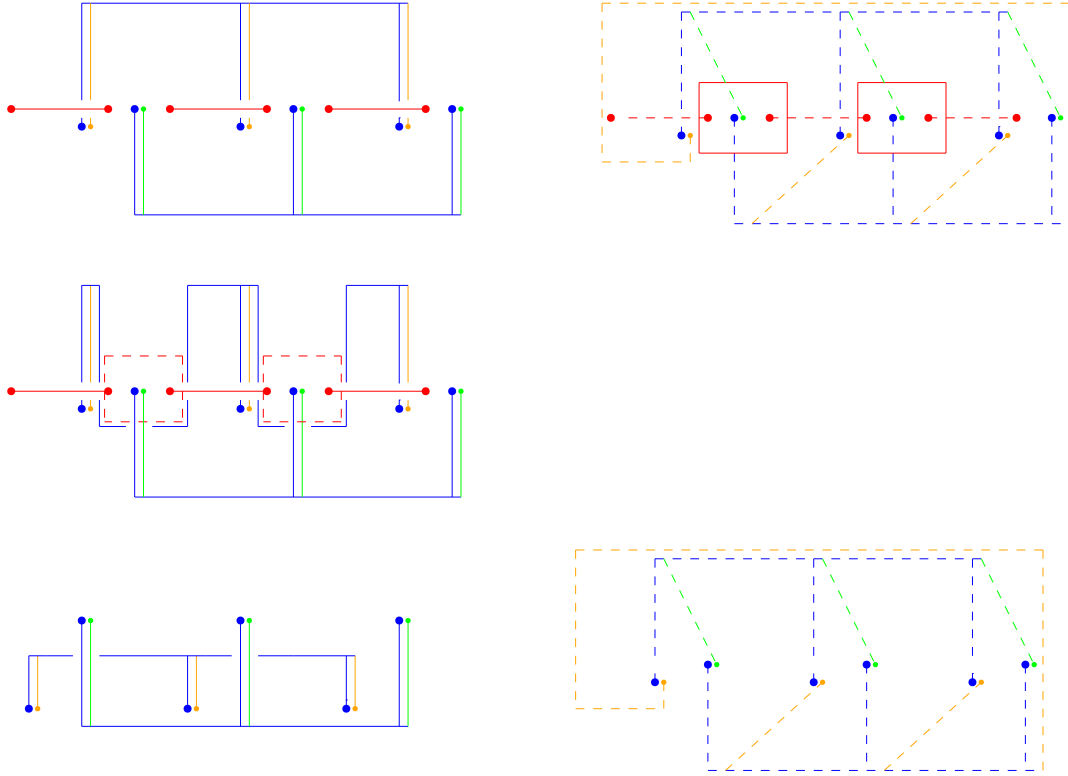

Now we have the following 3D diagram and the equality follows after doing bending moves as described in the definition of Θ_2 . The rotations introduce the left twists to green strings and Θ_2 action to y (purple).

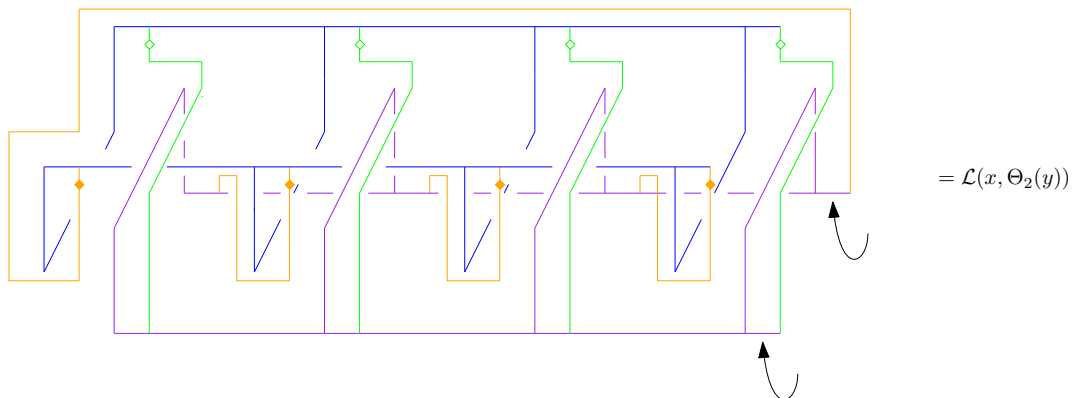

for the reverse braiding we have, one can imagine that we read diagrams "from the other side", then the twists change to the case of the previous situation and proof follows similarly except the position

of two basis in the end gets changed. Now the rotation is here to transform it to the standard position. Here we only draw the last steps of the proof.

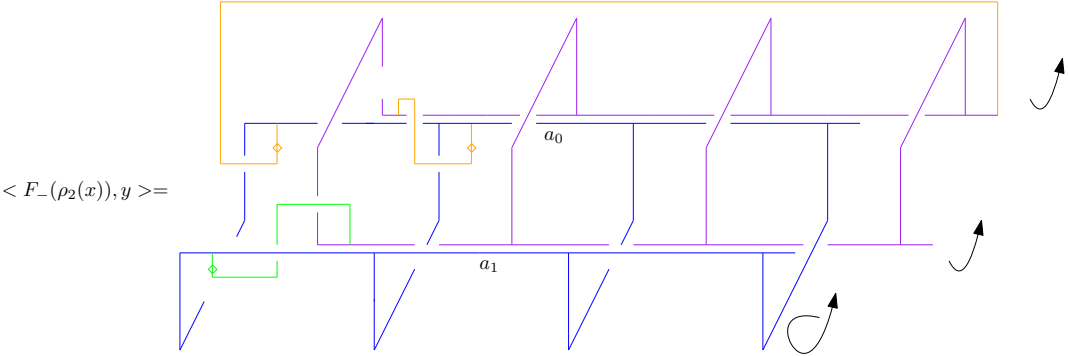
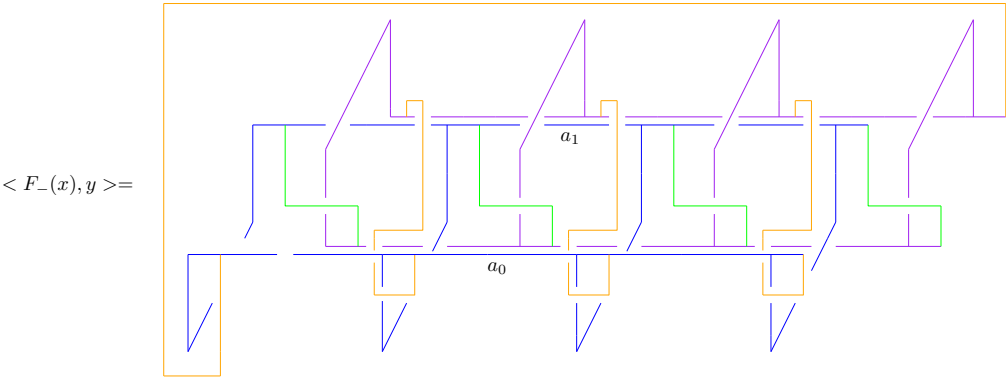

$$= \mathcal{L}(x, \Theta_2(y)) = \langle F_+(x), y \rangle$$

The rotations introduce the left twists to both green and orange strings and Θ_2 action to y (purple). □

Now from Theorem 4.15, we see $F_+ = \mathcal{F}$ as an operator Cf_+ to Cf_- . We will use this to prove \mathcal{F} is an isometry.

Theorem 4.2.1. *The Fourier transform \mathcal{F} is an isometry from $Cf(n, \mathbb{Z})$ to $Cf(n, \mathcal{F}(\mathbb{Z}))$. Moreover we have $\mathcal{F}^2 = \rho_1$. The same statements also hold for F_-*

Proof. $\langle \mathcal{F}(x), \mathcal{F}(y) \rangle$ is equal to the following diagrams, with a $(\delta^{-1/2-2})^{4n} \delta^{-2} = \delta^{-10n-2}$ factor.

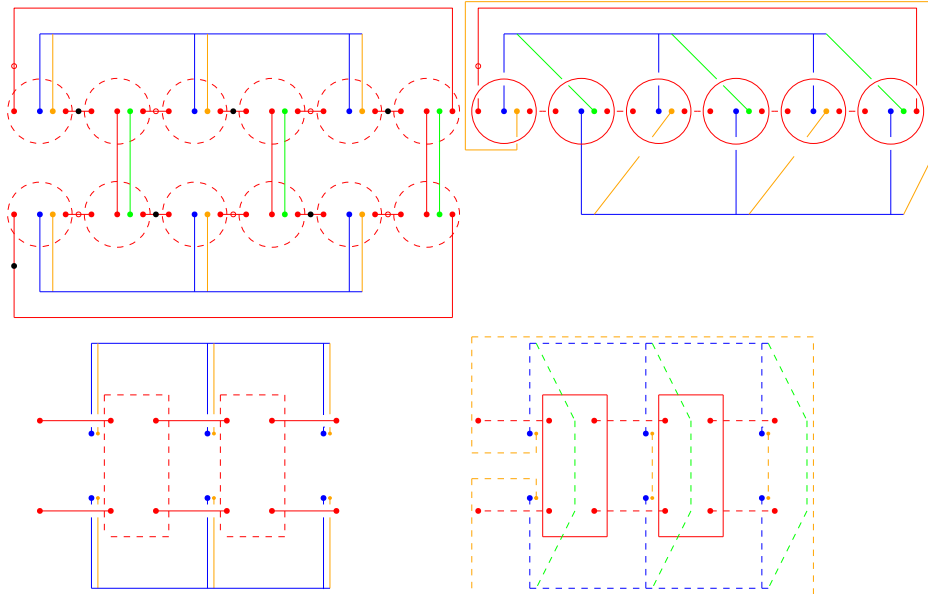

Then we use similar moves both in the top and bottom part as in the proof of the theorem 4.15 to simplify the diagrams (the bottom is just a reflection of the top hence all the moves are the same), we

get following diagrams with a factor of $\delta^{-10n-2+2n+4n+2+2n} = \delta^{-2n}$

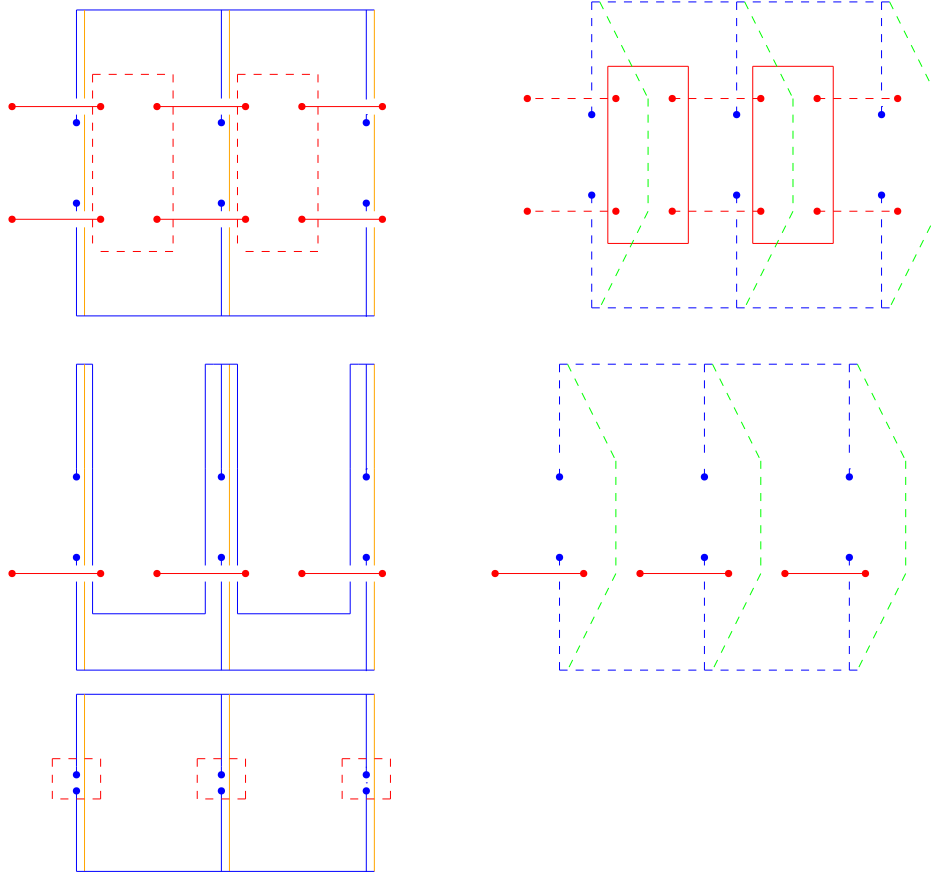

The last diagram gives $\delta^{-2n} \delta^{2n} \langle x, y \rangle = \langle x, y \rangle$.

As for the second statement, $\langle F_+^2 x, y \rangle$ are given by the following diagrams.

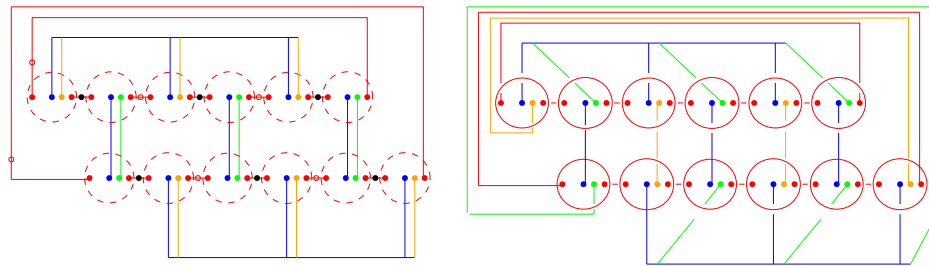

one observes the isotopy given by rotating clockwise the diagram in the right lower corner to the left lower corner, one gets exactly the diagram for the inner product of $F_+(x)$ and $F_+(\rho_1^{-1}y)$ which is equal to $\langle x, \rho_1^{-1}y \rangle$ by the proof of the first statement, which implies $F_+^2 = \rho_1$.

The statement for F_- now follows directly from Theorem 4.15. □

Corollary 4.16. *We have the following identities,*

$$\begin{aligned}\mathcal{F}(T_{k+1}(x)) &= \eta^{(-1)^k} T_k(\mathcal{F}(x)), \\ \mathcal{F}(\iota_{k+1}(x)) &= \iota_k \mathcal{F}(x).\end{aligned}$$

Proof. From Theorem 4.15, 4.2.1 and Lemma 4.7, 4.10, we have,

$$\mathcal{F}T_{2k+1}\mathcal{F}^{-1} = \eta T_{2k} \implies \mathcal{F}T_{2k+2}\mathcal{F}^{-1} = \eta^{-1}\rho_1 T_{2k+3}\rho_1^{-1} = \eta^{-1}T_{2k+1}.$$

For the first equality, we have,

$$\mathcal{F}\phi_{k+1}\mathcal{F}^{-1} = \phi_k \implies \mathcal{F}\phi_{k+1}\mathcal{F}^{-1}\iota_k = \phi_k\iota_k = 1 \implies \iota_k = \mathcal{F}\iota_{k+1}\mathcal{F}^{-1}.$$

□

Next we verify the braiding we defined here is indeed the 'square root' of the braiding on $\mathcal{C} \boxtimes \mathcal{C}$ ($c_{x,y} \boxtimes c_{\bar{x},\bar{y}}$).

Proposition 4.17. *We have the following identity.*

$$T_{2k+1} \circ T_{2k} \otimes T_{2k+2} \circ T_{2k+1} = \bigoplus_{X,Y \in \text{irr}(\mathcal{C})} c_{XZ_{2k}, YZ_{2k+2}} \boxtimes c_{\bar{X}Z_{2k+1}, \bar{Y}Z_{2k+3}}$$

Proof. As usual, using Lemma 4.1 (Here we indeed show they are equal in the configuration space by evaluating in \mathcal{C} the inner product with basis vectors, hence the lemma can be applied), we draw the simplified diagrams as follows. Now we first apply the twist property inside vertical red circles at the right upper and left lower corners and apply the twist property again inside the upper and lower horizontal red circles and apply the cutting property. We have

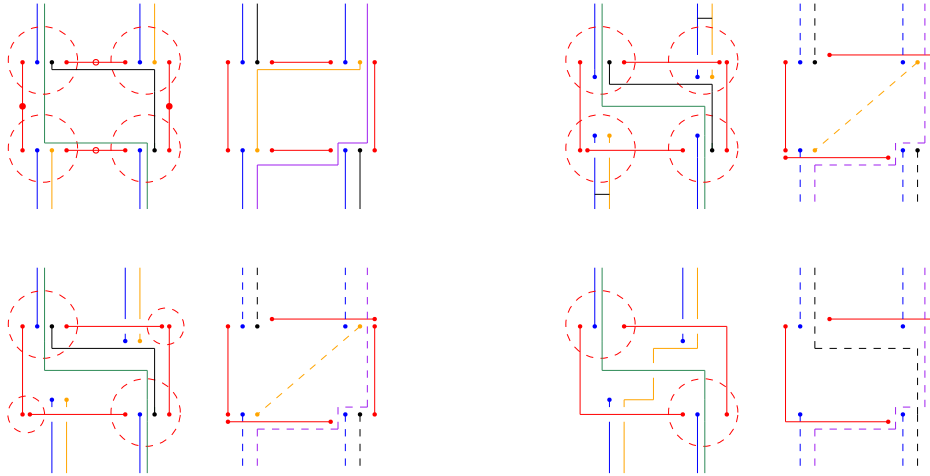

Now we use the fact that we are working in the configuration space and apply the cutting property, therefore we have,

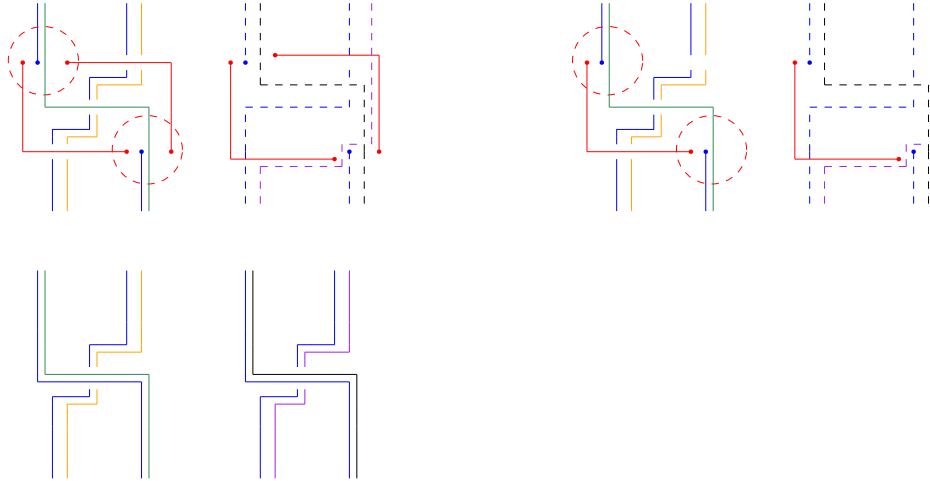

□

5. $\mathbb{Z}/2\mathbb{Z}$ PERMUTATION EXTENSION

Now we define a shaded planar algebra structure with $\mathbb{Z}/2\mathbb{Z}$ braiding structure from the data of \mathcal{C} .

Definition 5.1. We define a shaded planar algebra $\mathcal{P}^{\mathcal{C}}$, such that $P_{n,\pm,\mathbb{Z}} = Cf(n, \mathbb{Z})$. the generating tangles are defined as follows.

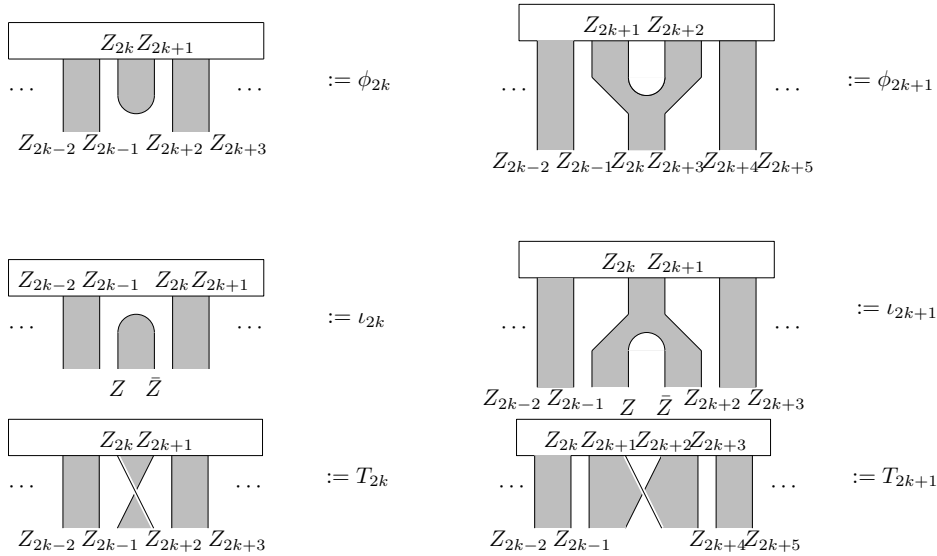

Theorem 5.2. *They define the even part of a shaded planar algebra with a $\mathbb{Z}/2\mathbb{Z}$ braiding structure (Definition 3.3).*

Proof. The following relations can be verified. By conjugating with F_+ , we have (R2) – (R6) with reversed shading are also satisfied (the relation holds for any labeling, hence we omit labels for simplicity).

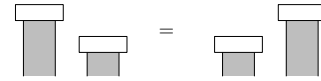
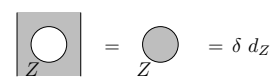
(R0)  (R1) 

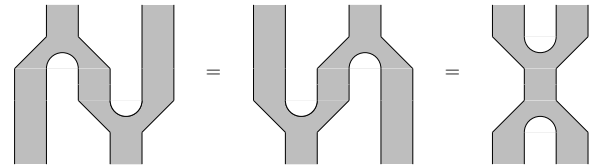
(R2) 

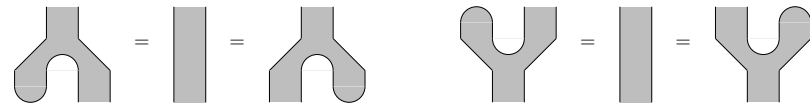
(R3) 

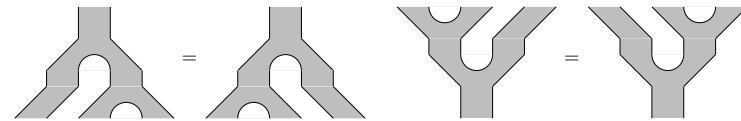
(R4) 

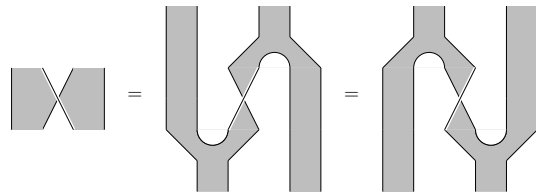
(R5) 

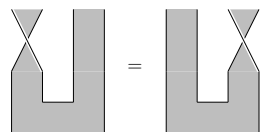
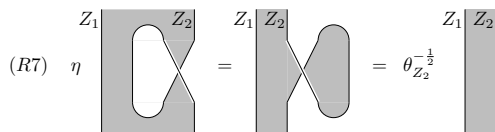
(R6)  (R7) 

Here the braiding in (R5), (R6) can be either positive or negative. (R0) is obvious, (R1) is the first identity in Lemma 4.7, (R2), (R4) follow from direct graphic calculus using Lemma 4.1 and Remark 4.2, (R3) follows from "zig-zag" relation which is proved in 4.6.

The first equality of (R5) is the definition 4.9, the second one follows from direct graphic calculus. (R6) is proved in Lemma 4.11.

Now (R0) – (R4) (also with shading reversed) gives the structure of an even part of planar algebra. (C0) can be verified easily (Definition 4.9), (C1) follows from (R5), (R4). (C2) can be verified using (R5) on the right-hand side and applying (R2), (R3), (R6). (C3) will be proved later (Lemma 5.4). (C4) follows from (R7) and other equalities are direct consequence of applying (R5) and (C3). And (C5) follows from Proposition 4.17. \square

Remark 5.1. We will abuse the notation to denote curls or the square root of twist in (R7) by again a diamond symbol on the corresponding strand.

$$\begin{array}{c} \blacksquare \\ | \\ Z_0 Z_1 \end{array} := \theta_{Z_1}^{-1/2} \begin{array}{c} | \\ | \\ Z_0 Z_1 \end{array}$$

The immediate Corollary of (C5) is the following

Corollary 5.3. *For $x \in P_{n,Z}$, we have*

$$F_{\pm,Z}(x) = d_Z \theta_{Z_0}^{\mp 1/2} \prod_{k=0}^{2n-2} T_{2n-2-k}^{\pm 1}$$

Proof. By comparing various definitions, The operators $F_{\pm,(Z)}$ are given by the following tangles. And the results follows from (C5)(Proposition 4.17) and (R7).

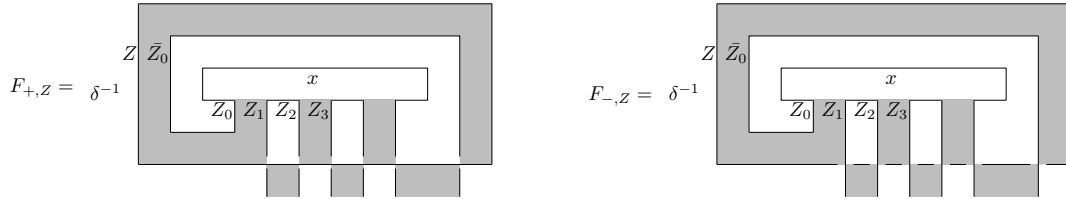

\square

Now the (C3) (see the next lemma) follows from Corollary 5.3, Lemma 4.10 and Corollary 4.16.

Lemma 5.4. *The braidings we defined satisfy the following*

$$T_{k+1}T_kT_{k+1} = \eta^{(-1)^k} T_kT_{k+1}T_k.$$

Proof. the identity is equivalent, by conjugating $F_{+,Z}$, to $T_1T_0T_1 = \eta T_0T_1T_0$.

Now from Corollary 5.3 and 4.16, we have $\prod_{m=0}^{2n-2} T_{2n-2-m}T_1 = \eta T_0 \prod_{m=0}^{2n-2} T_{2n-2-m}$. Since $T_mT_{m+2} = T_{m+2}T_m$, after cancellations we have $T_1T_0T_1 = \eta T_0T_1T_0$

\square

Now in order to resolve the global constant η , one can easily check it is enough to let $\tilde{T}_k = \eta \frac{(-1)^k}{2} T_k$. Then in favor of Theorem 3.5, we obtain an unshaded planar algebra with a $\mathbb{Z}/2\mathbb{Z}$ braiding (the braiding structure now comes from \tilde{T}_k). The corresponding $\mathbb{Z}/2\mathbb{Z}$ action is given by placing the input disks in between two 1-labeled circles, see Lemma 3.4. Next Lemma shows this action is the same as ρ_2 (Definition 4.13).

Lemma 5.5. *The $\mathbb{Z}/2\mathbb{Z}$ action is given by ρ_2 .*

Proof. From Theorem 4.15, we have $F_-^{-1}F_+ = \rho_2$, and it is easy to see the corresponding tangle of the left-hand side is isotopic to the desired form (see the proof of Corollary 5.3). \square

Now by detailed analysis of the minimal projections and the $\mathbb{Z}/2\mathbb{Z}$ action in the unshaded planar algebra, one gets the following.

Theorem 5.6. *We obtain a $\mathbb{Z}/2\mathbb{Z}$ -graded unitary fusion category $\mathcal{D} := (\mathcal{C} \boxtimes \mathcal{C})_{\mathbb{Z}/2\mathbb{Z}}^\times$ with a unitary $\mathbb{Z}/2\mathbb{Z}$ -crossed braiding. Moreover the projections in the odd part are given by a single cap labeled by V for $V \in \text{obj}(\mathcal{C})$, we denote them by $\{\hat{V}\}_{V \in \text{obj}(\mathcal{C})}$, we have*

- \hat{V} is minimal $\Leftrightarrow V$ is simple.
- $\hat{V}X \boxtimes Y = X \boxtimes Y\hat{V} = \hat{V}X\hat{Y}$
- $\hat{V}\hat{W} = \hat{W}\hat{V} = \bigoplus_{X \in \text{irr}(\mathcal{C})} XV \boxtimes XW$.

The $\mathbb{Z}/2\mathbb{Z}$ action ρ (given by ρ_2) acts on objects by $\rho(\hat{V}) = \hat{V}$ and $\rho(X \boxtimes Y) = Y \boxtimes X$

Proof. Recall the algebra structure of P_n is given in Definition 2.4. θ_1 is given by the following tangle,

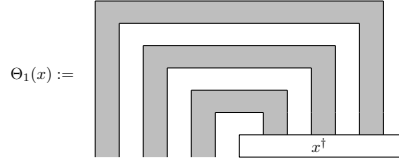

and the unitarity follows from the planar isotopy and that of \mathcal{C} . We first describe the category coming from the even part. When n is even, it is not hard to show the following two Hom space is isomorphic, as \mathbb{C}^* algebras:

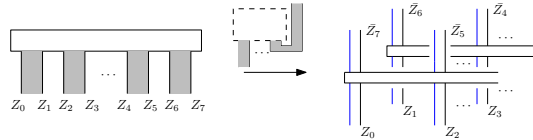

Hence the minimal projections in P_n for n even is equivalent to those in P_2 which can be described by the simple objects in $\mathcal{C} \boxtimes \mathcal{C}$, we denoted them by $p_{X \boxtimes Y}$, $X, Y \in \text{irr}(\mathcal{C})$. The following representative will be used in further calculations

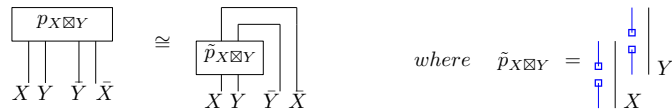

The corresponding fusion rings are isomorphic. Note the corresponding evaluation and coevaluation maps are given similarly as in Lemma 4.11 without the twists (only caps or cups are not the morphism in the category), and the rigidity follows from (R6) and the planar isotopy. Moreover thanks to Proposition 4.17, the braiding structures agree. Therefore the category of projections from the even part is equivalent, as a unitary braided fusion category to $\mathcal{C} \boxtimes \mathcal{C}$.

When $n = 1$, let $\mathcal{Z} = \{V, W\}$, by computing the dimension of the configuration space, we have $\dim(P_{1,\mathcal{Z}}) = \dim(\text{Hom}_{\mathcal{C}}(V, W^*))$. Hence the projections in 1-box space are given by the single cap labeled by V, \bar{V} , and the projection is minimal when V is simple. The dual projection is given by the cap labeled \bar{V}, V (rigidity follows from the planar isotopy of the single string), we denote them by $\hat{V}, \hat{\bar{V}}$ respectively. Using the structure of the even part described previously, the fusion rule for $\hat{V}\hat{W}$ is immediate. ($\hat{V}\hat{W} = \hat{W}\hat{V}$ can be shown either by direct arguing $\oplus_{X \in \text{irr}(\mathcal{C})} XV \boxtimes XW = \oplus_{X \in \text{irr}(\mathcal{C})} XW \boxtimes XV$ or by establishing equivalence of projections simply using braidings)

Now for any projections Q in P_n for n is odd, pick any $V \in \text{irr}(\mathcal{C})$, we have $Q \otimes \hat{V} \in P_{n+1}$, hence it can be written as sums of projections in $\mathcal{C} \boxtimes \mathcal{C}$. Using rigidity and the fusion rule for $\hat{V} \boxtimes \hat{\bar{V}}$, we have the projections in P_n for n odd are the sum of projections of the form $(X \boxtimes Y)\hat{V}$. Next we prove they are equivalent to the projections in the P_1 .

$(X \boxtimes Y)\hat{V} = \hat{V}(X \boxtimes Y)$ follows from the equivalence of two projections given by braidings:

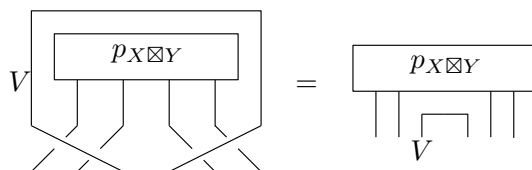

Next by direct calculation of $\oplus_{Z \in \text{irr}(\mathcal{C})} XZV \boxtimes Y\bar{Z} = \oplus_{Z \in \text{irr}(\mathcal{C})} VXYZ \boxtimes \bar{Z}$, we have the following equivalence:

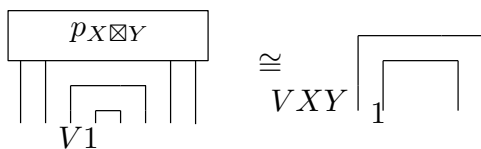

And $(X \boxtimes Y)\hat{V} = \widehat{VXY}$ follows from composing a single cup labeled by the trivial object on the bottom on both hand sides and resolving the trivial labeled loops.

Next, we examine the $\mathbb{Z}/2\mathbb{Z}$ actions on the objects, $\rho_2(\hat{V}) = (\hat{V})$ follows directly from the planar algebra description of the action (Lemma 3.4) and the objects in odd part. The action on the even part needs a little bit of calculation. By observing the similarities between more explicit definition (4.13) of ρ_2 and braidings action on the $\tilde{p}_{X \boxtimes Y}$, the following identity holds (we also use the proof of

Lemma 4.11 to make the flipping action involved in ρ_2 obvious).

$$\rho_2 \left(\begin{array}{c} \text{---} \\ | \\ \boxed{\tilde{p}_{X \boxtimes Y}} \\ | \\ X \quad Y \quad \bar{X} \quad \bar{Y} \end{array} \right) = \begin{array}{c} \text{---} \\ | \\ \boxed{\tilde{p}_{Y \boxtimes X}} \\ | \\ X \quad Y \quad \bar{X} \quad \bar{Y} \end{array} \cong \begin{array}{c} \text{---} \\ | \\ \boxed{\tilde{p}_{Y \boxtimes X}} \\ | \\ X \quad Y \quad \bar{X} \quad \bar{Y} \end{array}$$

Now $\rho_2(X \boxtimes Y) = Y \boxtimes X$ follows from the next identities.

$$\begin{array}{c} \text{---} \\ | \\ \text{---} \\ | \\ \text{---} \end{array} = \begin{array}{c} \text{---} \\ | \\ \boxed{\theta^{-1}} \\ | \\ \text{---} \\ | \\ \text{---} \end{array} \Rightarrow \begin{array}{c} \text{---} \\ | \\ \boxed{\tilde{p}_{Y \boxtimes X}} \\ | \\ \text{---} \\ | \\ \text{---} \end{array} = \begin{array}{c} \text{---} \\ | \\ \boxed{\tilde{p}_{Y \boxtimes X}} \\ | \\ Y \quad X \end{array}$$

Where the first identity can easily be proved by first isotopy the left-hand side to a full twist on double strings, then using Proposition 4.17.

Finally, the coherence conditions of $\mathbb{Z}/2\mathbb{Z}$ -crossed braiding can be checked easily from Corollary 3.6 and (C3). \square

Remark 5.2. The sphericity can also be derived simply using the braiding that strands can be isotoped above everything.

Remark 5.3. Even though the unitarity is crucial for the reconstruction program, it is not necessary in our construction, the whole proof works very similarly. Now instead of picking the orthonormal basis in the configuration space, we take the basis and the dual basis under the non-degenerate bilinear form given by \langle, \rangle . The only place we use the unitarity is when we take the square root of the quantum dimension appeared in the coefficient of many operations (ϕ_k , ι_k , T_k). These can be adjusted by redefining the vertical composition with an additional $\frac{1}{d_-}$ factor so that the coefficient only involves the product of the quantum dimensions.

6. SOME APPLICATIONS

Theorem 6.1. T_k ($0 \leq k \leq 2n - 2$) satisfy the following relations

$$\begin{aligned} T_k T_{k+2} &= T_{k+2} T_k, \\ T_{k+1} T_k T_{k+1} &= \eta^{(-1)^k} T_k T_{k+1} T_k, \\ (T_{2n-2} T_{2n-1} \cdots T_1 T_0)^{2n} &= \left(\prod_{k=0}^{2n-1} \theta_{Z_k}^{\frac{1}{2}} \right) Id, \\ (T_0 T_1 \cdots T_{2n-2} T_{2n-2} \cdots T_1 T_0)^2 &= \theta_{Z_0}^2 Id. \\ T_0 T_1 \cdots T_{2n-2} T_{2n-2} \cdots T_1 T_0 &\text{ commutes with } T_k \text{ (} 0 \leq k \leq 2n - 2 \text{)} \end{aligned}$$

Proof. The first one is obvious, the second one is Lemma 5.4. The third and fourth ones follow from rewriting $(F_+)^{2n} = Id$ and $F_+ = F_- \rho_2$ using Corollary 5.3, and $\rho_2^2 = Id$. The last one follows from Lemma 5.5 and the fact that the planar algebra action respects braidings (Lemma 3.4) \square

Now consider the configuration space with all black strands labeled by the same simple object V . We denote it by $Cf^V(n)$. We refer to [5, Thm. 8] for the presentation of symmetric mapping class group $SMod(\Sigma_{n-1})$, we thus have the following Corollary,

Corollary 6.2. *$Cf^V(n)$ gives a unitary projective representation of $SMod(\Sigma_{n-1})$.*

Now we consider the case that V is the trivial object 1, then the space $Cf^1(n)$ is the same as the configuration space in [32] for $m = 2$. And the planar algebra we constructed here corresponds to the 2-interval Jones-Wassermann subfactor. As a result of Theorem 4.2.1, we have a different proof for the following Theorem.

Theorem 6.3. ([32]) *The 2-interval Jones-Wassermann subfactor is self-dual.*

And the braiding in this case is much easier to describe, for example,

$$T_{2k} = \cdots Id \otimes \left(\bigoplus_{V \in \text{irr}(\mathcal{C})} \theta_V^{-1} Id_V \boxtimes Id_{\bar{V}} \right) \otimes Id \cdots$$

When working in the 2-box space, we have $T_0 = T_2$ is the T -matrix of \mathcal{C} , the Fourier transformation F_+ corresponds to S -matrix ([32]) and the charge conjugation matrix C is given by the Z_2 -action ρ_2 . See figure 3 for more details.

The following Corollary follows from Theorem 6.1 and Lemma 5.3, which gives the well-known projective representation of $SL_2(\mathbb{Z})$

Corollary 6.4. *The following identities hold*

$$\begin{aligned} S^4 &= Id(S^2 = C) \\ (T^{-1}S)^3 &= \eta C \\ (ST)^3 &= \eta^{-1} \end{aligned}$$

Remark 6.1. We will show in Section 8, in general our $SMod(\Sigma_{n-1})$ representation given by $Cf^1(n)$ is equivalent to the representation coming from Reshetikhin-Turaev TQFT state space associated with closed surface of genus $n - 1$, see Theorem 8.2, which indicates the genus-0 data (braidings) of the extension theory contains the higher genus data of the original theory. Which interprets the twisted/untwisted correspondence [3][21].

Previous identities are derived only from the isotopy of strands. One may expect there are more identities derived from the isotopy of whole planar algebra. Indeed we obtain numerous interesting identities. For example in the next proposition, we list here only three of them involving merely one isotopy through input disks of trivial labeled 2-box space ($Cf(2, \mathcal{Z})$ with Z_i 's all trivial objects).

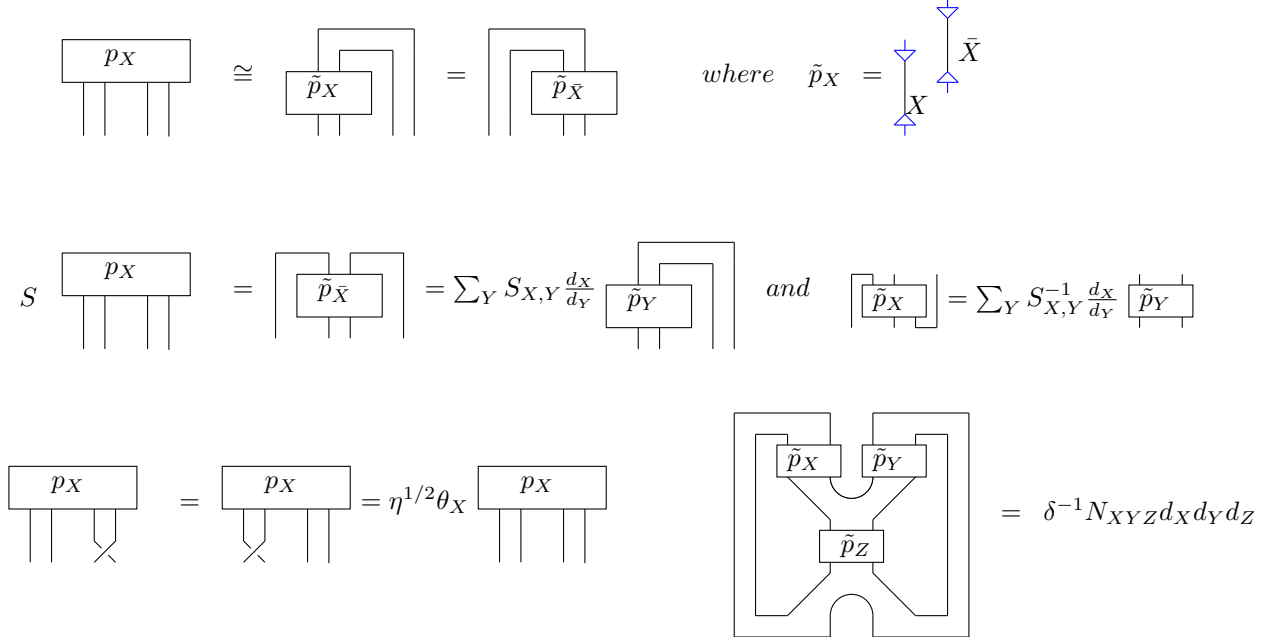

FIGURE 3. Some basic identities when all strands are labeled by 1 (or $\hat{1}$)

Proposition 6.5. *We have the following identities.*

$$\sum_{V \in \text{irr}(\mathfrak{C})} \frac{\theta_V}{\theta_X} S_{YV} N_{VX}^Z = \sum_{V \in \text{irr}(\mathfrak{C})} \frac{\theta_V}{\theta_W} S_{XV} N_{VY}^Z,$$

$$\sum_{V, W \in \text{irr}(\mathfrak{C})} \delta_{Y,Z} \frac{\theta_V}{\theta_W} S_{XV} N_{VW}^Z d_X d_W = \sum_{V, W \in \text{irr}(\mathfrak{C})} \delta_{X,Z} \frac{\theta_V}{\theta_W} S_{YV} N_{VW}^Z d_Y d_W,$$

$$\sum_{V \in \text{irr}(\mathfrak{C})} \delta_{Y,Z} \frac{\theta_V}{\theta_X} N_{VX}^Z d_V = \sum_{V, W \in \text{irr}(\mathfrak{C})} \frac{\theta_V}{\theta_W} S_{XZ} S_{Y\bar{W}} N_{WV}^Z d_V.$$

Proof.

□

Here we list all three isotopy identities we used, and the proof of the first one is established, the others can be derived similarly.

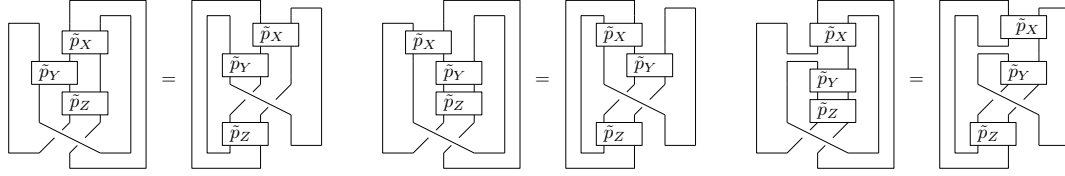

$$\text{RHS} = \sum_{V,W} \frac{\theta_V}{\theta_W} \left[\text{Diagram} \right] = \sum_V \frac{\theta_V}{\theta_X} S_{YV}^{-1} \frac{d_Y}{d_V} \left[\text{Diagram} \right] = \delta^{-1} \sum_V \frac{\theta_V}{\theta_X} S_{YV} N_{VX}^Z d_Y d_X d_Z$$

$$\text{LHS} = \sum_{V,W} \frac{\theta_V}{\theta_W} \left[\text{Diagram} \right] = \sum_V \frac{\theta_V}{\theta_Y} S_{XV}^{-1} \frac{d_X}{d_V} \left[\text{Diagram} \right] = \delta^{-1} \sum_V \frac{\theta_V}{\theta_W} S_{XV} N_{VY}^Z d_X d_Y d_Z$$

We don't know, at this stage, whether all the identities we derived can be generated by the Verlinde formula, balancing equation or $SL_2(Z)$ relations. If not, we will have new obstructions for the realization of the modular data. We conjecture one can deduce some new identities using isotopy only involving trivial labeled 2-boxes .

The next identity comes from considering only planar isotopy among nontrivial labeled 2-box spaces, which are not generated by the known identities.

Proposition 6.6. *We have the following identity,*

$$= \sum_{\vec{\beta} \in C f_2^{\otimes 6} \otimes NB} \prod_{i=1}^6 F_{-, \alpha_i \beta_i}$$

Here instead of making strings zigzag, we simply rotate the boxes (one can retrieve everything to a standard form), and β_i, α_i are the orthonormal basis in the corresponding configuration space. We denote $\bar{\alpha} := \rho_1(\alpha)$. $F_{-, \alpha_i \beta_i} := \langle F_-(\alpha), (\beta) \rangle$.

Proof. The right-hand side is given by applying (inverse) Fourier transform F_- to every 2-box (rotate $\frac{\pi}{2}$ counter-clockwise), see the following diagram.

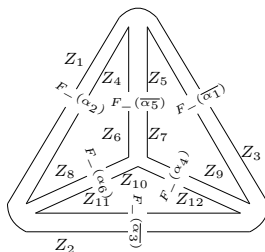

Direct isotopy then gives the left-hand side. □

When all Z'_i 's are trivial, then we replace α_i, β_i by \tilde{p}_{X_i} and \tilde{p}_{Y_i} respectively, and $F_{-, \alpha_i \beta_i} = S_{X_i Y_i}^{-1}$. The previous proposition reduces to the identity known as 6j-symbol self-duality [30]. Now we use Λ to denote the subspace spanned by admissible colors $\{X_1 \otimes X_2 \otimes X_3 \otimes X_4 \otimes X_5 \otimes X_6\}_{\vec{X}}$ such that $N_{\bar{X}_1 \bar{X}_5 X_2} N_{\bar{X}_1 X_4 X_3} N_{X_2 X_6 \bar{X}_3} N_{X_4 X_5 X_6} \neq 0$. Now we have the following non-modular-group-relation identity.

Theorem 6.7. *We have the following identity,*

$$(4) \quad \text{Det}|_{\Lambda}(S^{\otimes 6}P - I^{\otimes 6}) = 0.$$

Where P is the composition of a permutation matrix permuting the tensor factors by the cycle (16)(25)(34) and $C^{\otimes 3} \times I^{\otimes 3}$ (C is the charge conjugation matrix). $\text{Det}|_{\Lambda}$ is the determinant of the matrix restricted in Λ .

Proof. Let $\left| \left\{ \begin{matrix} X_1 & X_2 & X_3 \\ X_4 & X_5 & X_6 \end{matrix} \right\} \right|^2$ be the basis-free 6j-symbol (F -symbol) as described in [30] and we denote the vector $\left\{ \left| \left\{ \begin{matrix} X_1 & X_2 & X_3 \\ X_4 & X_5 & X_6 \end{matrix} \right\} \right|^2 \right\}_{\vec{X}}$ by v . Now $\left| \left\{ \begin{matrix} Y_1 & Y_2 & Y_3 \\ Y_4 & Y_5 & Y_6 \end{matrix} \right\} \right|^2$ is given by the value of the diagram on the right-hand side in the previous proposition, while the left-hand side is $\left| \left\{ \begin{matrix} \bar{X}_6 & \bar{X}_5 & \bar{X}_4 \\ X_3 & X_2 & X_1 \end{matrix} \right\} \right|^2$. The result follows by observing that v is an eigenvector of the matrix $S^{\otimes 6}P$ with eigenvalue 1 and $v|_{\Lambda^c} = 0$. □

Remark 6.2. Identity 4 is an obstruction for modular category realization of S -matrix. One may apply it to the S -matrix of the gauged theory discussed in the next section, and obtain another obstruction. As one can keep doing the $\mathbb{Z}/2\mathbb{Z}$ permutation gauging, there will be infinitely many obstructions!

7. EQUIVARIANTIZATION THEORY

In this section we will work on the $\mathbb{Z}/2\mathbb{Z}$ -equivariantization of the category \mathcal{D} obtained in Theorem 5.6. The resulting category is denoted by $\mathcal{D}^{\mathbb{Z}/2\mathbb{Z}}$.

Here in our case, the action ρ is explicit and moreover it is strict ($\rho^2 = Id$), one obtains the simple objects in $\mathcal{D}^{\mathbb{Z}/2\mathbb{Z}}$ are of the form $(XY) := X \boxtimes Y \oplus Y \boxtimes X$, (X, \pm) and (\hat{X}, \pm) ($X, Y \in irr(\mathcal{C})$, $1_{\mathcal{D}^{\mathbb{Z}/2\mathbb{Z}}} := (\hat{1}, +)$). Moreover, thanks to the properties of the braiding and the topological description of the action. It is straight forward to see the structure morphisms (ev, coev, braiding) commute with the action, thus giving rise to the structure morphism in $\mathcal{D}^{\mathbb{Z}/2\mathbb{Z}}$. Therefore we can do calculations in the planar algebra for $\mathcal{D}^{\mathbb{Z}/2\mathbb{Z}}$.

Now let $S', T, N, S^{eq}, T^{eq}, \mathcal{N}$ denote the S (unnormalized), T matrix and fusion coefficient for \mathcal{C} and $\mathcal{D}^{\mathbb{Z}/2\mathbb{Z}}$ respectively.

Theorem 7.1. *We have S^{eq} is symmetric and*

$$\begin{aligned} S_{(XY),(ZW)}^{eq} &= 2(S'_{X,Z}S'_{Y,W} + S'_{X,W}S'_{Y,Z}) \\ S_{(XY),(Z,\epsilon)}^{eq} &= 2S'_{X,Z}S'_{Y,Z} \\ S_{(X,\epsilon_1),(Y,\epsilon_2)}^{eq} &= (S'_{X,Y})^2 \\ S_{(XY),(\hat{Z},\epsilon)}^{eq} &= 0 \\ S_{(X,\epsilon_1),(\hat{Y},\epsilon_2)}^{eq} &= \epsilon_1 \delta S'_{X,Y} \\ S_{(\hat{X},\epsilon_1),(\hat{Y},\epsilon_2)}^{eq} &= \epsilon_1 \epsilon_2 \eta^{-1} \theta_X^{1/2} \theta_Y^{1/2} (S' T^2 S')_{X,Y} \end{aligned}$$

And T^{eq} is diagonal matrix with

$$\begin{aligned} T_{(XY),(XY)}^{eq} &= \theta_X \theta_Y \\ T_{(X,\epsilon),(X,\epsilon)}^{eq} &= \theta_X^2 \\ T_{(\hat{X},\epsilon),(\hat{X},\epsilon)}^{eq} &= \epsilon \eta^{1/2} \theta_X^{1/2} \end{aligned}$$

Proof. As described in the preliminary section. It suffices to evaluate the following four diagrams in the planar algebra. Here $\epsilon_i = \pm 1$, indicates the morphism we pick for the u_g .

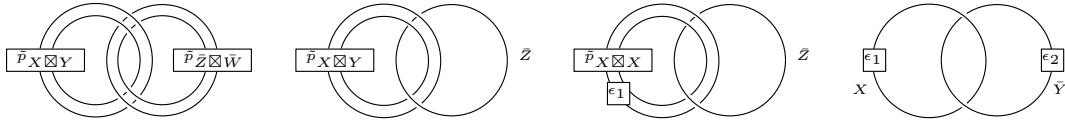

The first three identities follow from the evaluation of the first diagram by using Proposition 4.17. The fourth and fifth ones come from the evaluation of the second and third diagrams, the detailed

calculations are as follows,

$$\begin{aligned}
 \bar{p}_{X \boxtimes Y} &= \bar{p}_{X \boxtimes Y} \\
 &= \delta^{-1} \sum_{\alpha, \beta \in ONB} \text{Diagram} \\
 &= \delta^{-5} \text{Diagram} \\
 &= \delta^{-3} \text{Diagram} \\
 &= \delta^{-3} \text{Diagram} = \delta_{X,Y} \delta \text{Diagram} \\
 &= \delta \delta_{X,Y} S'_{Z,Y}
 \end{aligned}$$

Finally, the last identity follows from the following evaluation of the last diagram,

$$\begin{aligned}
&= \epsilon_1 \epsilon_2 \eta^{-1} \\
&= \epsilon_1 \epsilon_2 \eta^{-1} \\
&= \epsilon_1 \epsilon_2 \eta^{-1} \sum_{Z \in \text{irr}(\mathcal{C})} \theta_Z^2 S'_{X,Z} S'_{Z,Y}
\end{aligned}$$

□

Now we simply denote the normalized S -matrix for \mathcal{C} by S , and define the matrix $P := \eta^{-1} T^{1/2} S T^2 S T^{1/2}$ (this is the same P defined in [3],[7],[28], since their T matrix is normalized by $\eta^{-1/3}$). The following corollary is obtained by direct computation.

Corollary 7.2. $\mathcal{D}^{\mathbb{Z}/2\mathbb{Z}}$ is modular and the fusion rules are as follows

$$\begin{aligned}
\mathcal{N}_{(X_1 Y_1), (X_2 Y_2), (X_3 Y_3)} &= N_{X_1 X_2 X_3} N_{Y_1 Y_2 Y_3} + N_{X_1 X_2 Y_3} N_{Y_1 Y_2 X_3} + N_{X_1 Y_2 X_3} N_{Y_1 X_2 Y_3} + N_{Y_1 X_2 X_3} N_{X_1 Y_2 Y_3}, \\
\mathcal{N}_{(X_1 Y_1), (X_2 Y_2), (Z, \epsilon)} &= N_{X_1 X_2 Z} N_{Y_1 Y_2 Z} + N_{X_1 Y_2 Z} N_{Y_1 X_2 Z}, \\
\mathcal{N}_{(XY), (Z_1, \epsilon_1), (Z_2, \epsilon_2)} &= N_{X Z_1 Z_2} N_{Y Z_1 Z_2}, \\
\mathcal{N}_{(Z_1, \epsilon_1), (Z_2, \epsilon_2), (Z_3, \epsilon_3)} &= \frac{1}{2} N_{Z_1 Z_2 Z_3} (N_{Z_1 Z_2 Z_3} + \epsilon_1 \epsilon_2 \epsilon_3), \\
\mathcal{N}_{(XY), (\hat{Z}_1, \epsilon_1), (\hat{Z}_2, \epsilon_2)} &= \sum_{W \in \text{irr}(\mathcal{C})} \frac{S_{XW} S_{YW} S_{Z_1 W} S_{Z_2 W}}{S_{1W}^2}, \\
\mathcal{N}_{(X, \epsilon), (\hat{Z}_1, \epsilon_1), (\hat{Z}_2, \epsilon_2)} &= \frac{1}{2} \sum_{W \in \text{irr}(\mathcal{C})} \frac{S_{XW}^2 S_{Z_1 W} S_{Z_2 W}}{S_{1W}^2} + \frac{1}{2} \epsilon \epsilon_1 \epsilon_2 \sum_{W \in \text{irr}(\mathcal{C})} \frac{S_{XW} P_{Z_1 W} P_{Z_2 W}}{S_{1W}}.
\end{aligned}$$

Proof. One shows the normalized S^{eq} is unitary by using Theorem 7.1 and the unitarity of S . The fusion rules follow from the Verlinde formula. □

Remark 7.1. The above results coincide with those in [3], [28, Sec. 9.3] and [7, Sec. 4.4], which are in the setting of conformal field theory.

Example 7.3. Metaplectic categories $SO(N)_2$ ($N = 2r + 1$) are the unitary modular categories with the same fusion rule as the type B quantum group category at level 2, see [24][25][1] for the characterization of inequivalent theories. Combined with Corollary 7.2, we have the following corollary.

Corollary 7.4. $SO(N)_2$ is equivalent to the subcategory of a $\mathbb{Z}/2\mathbb{Z}$ permutation gauging of $\mathcal{C}(\mathbb{Z}/N\mathbb{Z}, q)$ generated by $(\hat{1}, \pm)$.

Proof. One can directly check the fusion rule using Corollary 7.2, therefore it suffices to show we have all 2^{s+1} inequivalent categories. Let $N = \prod_i p_i^{s_i}$ and $s = \sum_i s_i$, the choices of non-degenerate quadratic form q gives 2^s inequivalent theories [1], and the last two choices come from pick a different square root of the global dimension (as the value of a single strand circle), which, in particular, change η to $-\eta$. \square

8. SOME OBSERVATIONS AND QUESTIONS

8.1. Relation to the Reshetikhin-Turaev TQFT. We refer to [36] [41] for the basic definition of Reshetikhin-Turaev TQFT and the corresponding mapping class group actions.

The state space associated to the closed genus g surface Σ_g is given by

$$\Psi_g = \bigoplus_{i \in I^g} \Psi_g^i = \bigoplus_{i \in I^g} \text{Hom}(1, \bigotimes_{r=1}^g (V_{i_r} \otimes \bar{V}_{i_r})).$$

Here we denote the vector space $\text{Hom}(1, \bigotimes_{r=1}^g (V_{i_r} \otimes \bar{V}_{i_r}))$ by Ψ_g^i ,

Now we define the map $\Phi_g : \Psi_g \rightarrow C^f(g+1)$ by

$$\Phi_g(\bigoplus_{i \in I^g} f_i) = \sum_{i \in I^g, \alpha, W_r \in \text{irr}(\mathcal{C})} (Id_{V_{i_1}} \otimes \bigotimes_{r=1}^{g-1} \alpha_{\bar{V}_{i_r}, V_{i_{r+1}}}^{W_r} \otimes Id_{\bar{V}_{i_g}}) \circ f_i \otimes \Theta_2((Id_{V_{i_1}} \otimes \bigotimes_{r=1}^{g-1} \alpha_{\bar{V}_{i_r}, V_{i_{r+1}}}^{W_r} \otimes Id_{V_{i_g}}) \circ \bigotimes_{r=1}^g (coev_{\bar{V}_{i_r}}))$$

See the following diagram.

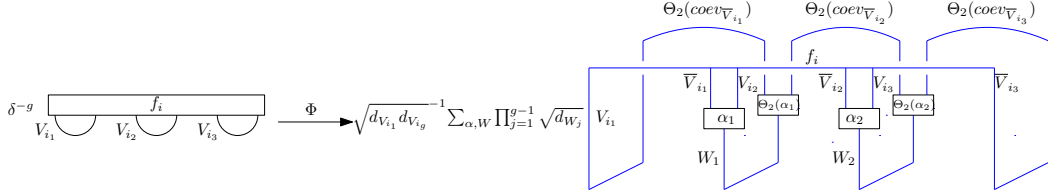

Lemma 8.1. *The dimensions of the two vector spaces are equal,*

$$\dim(\Psi_g) = \dim(C^f(g+1)).$$

Proof. $\dim(\Psi_g) = \sum_{i \in I^g} \dim(\Psi_g^i)$, and we have

$$\begin{aligned} \dim(\Psi_g^i) &= \dim(\text{Hom}(1, \bigotimes_{r=1}^g (V_{i_r} \otimes \bar{V}_{i_r}))) \\ &= \dim(\text{Hom}(\bigotimes_{r=1}^g V_{i_r}, \bigotimes_{r=1}^g V_{i_r})) \\ &= \sum_{W \in \text{irr}(\mathcal{C})} \dim(\text{Hom}(\bigotimes_{r=1}^g V_{i_r}, W)) \dim(\text{Hom}(W, \bigotimes_{r=1}^g V_{i_r})) \\ &= \sum_{W \in \text{irr}(\mathcal{C})} \dim(\text{Hom}(1, W \otimes \bigotimes_{r=1}^g \bar{V}_{i_r})) \dim(\text{Hom}(1, \bar{W} \otimes \bigotimes_{r=1}^g V_{i_r})) \end{aligned}$$

□

Theorem 8.2. Φ_g is an (isometric) isomorphism of $SMod(\Sigma_g)$ representations. Here we also denote the $SMod(\Sigma_g)$ action on Ψ_g by T_j ($0 \leq j \leq 2g + 1$) for simplicity.

Proof. We first prove Φ_g is an (isometric) isomorphism using non-degenerated bilinear (or inner product in the unitary case) for these two spaces.

$$\begin{aligned}
 \langle \Phi(f_i), \Phi(f_i) \rangle &= \delta^{-4(g-1)} \\
 &= \prod_{j=1}^g d_{V_j}^{-1} \\
 &= \delta^{-2g} \langle f_i, f_i \rangle_{RR}
 \end{aligned}$$

Now it follows from Lemma 8.1. Then we proof they are $SMod(\Sigma_g)$ -equivariant.

$$\begin{aligned}
 \langle T_{2k+1}(\Phi_g(f_i)), a \rangle &= d_{V_1}^{-1} d_{V_g}^{-1} \sum_W \sqrt{d_{W_1} d_{W_2}} \delta^{-8-1} \\
 &= d_{V_1}^{-1} d_{V_g}^{-1} \sum_W \sqrt{d_{W_1} d_{W_2}} \delta^{-4-1} \\
 &= d_{V_1}^{-1} d_{V_g}^{-1} \sum_W \sqrt{d_{W_1} d_{W_2}} \delta^{-3}
 \end{aligned}$$

$$\begin{aligned}
\langle \Phi_g(T_{2k+1}(f_i)), a \rangle &= d_{V_{i_1}}^{-1} d_{V_{i_g}}^{-1} \sum_W \sqrt{d_{W_1} d_{W_2}} \delta^{-4-3} \\
&= d_{V_{i_1}}^{-1} d_{V_{i_g}}^{-1} \sum_W \sqrt{d_{W_1} d_{W_2}} \delta^{-5} \\
&= d_{V_{i_1}}^{-1} d_{V_{i_g}}^{-1} \sum_W \sqrt{d_{W_1} d_{W_2}} \delta^{-3}
\end{aligned}$$

The equivalence of $T_{2k}(0 \leq k \leq g)$ action is straight forward, hence the theorem is proved. \square

Remark 8.1. The equivalence is easier to see when working with Temperley-Lieb-Jones modular categories, see [39] for more calculations and formulas of the similar Fourier pairing in this basis.

8.2. On Property F conjecture. A conjecture of Naidu and Rowell (known as Property F conjecture) states as follows

Conjecture 8.3. ([35]) *The braid group representations associated with any object in a weakly integral braided fusion category has finite image. (the property that the braid group image is finite is called property F)*

the conjecture is verified for metaplectic categories [38] [23], and for general weakly group theoretical categories [20]. Since gauging preserves integrality. We ask the following related question,

Question 8.4. Does $\mathbb{Z}/2\mathbb{Z}$ permutation gauging preserve property F ?

Our detailed construction has the following indication, the braid group representation associated with object $\hat{1}$ is the same as the symmetric mapping class group representation (Corollary 6.2 and Theorem 8.2) of the original category. In particular, the space $\text{Hom}_{D^{\mathbb{Z}/2\mathbb{Z}}}((1, +) \oplus (1, -), (\hat{1}, +)^{\otimes 2n})$ is naturally isomorphic to $Cf^1(n)$. Hence the braid group representation is equivalent (as we work in the same planar algebra). Now the question 8.4 leads to the following one,

Question 8.5. Given a modular category \mathcal{C} , if \mathcal{C} has property F , does symmetric mapping class group representation (described in Theorem 6.1) associated \mathcal{C} have a finite image?

Since the property being weakly group theoretical is invariant under gauging [17], together with the results of [20], we can obtain the following result,

Corollary 8.6. *The symmetric mapping class group representation of a weakly group theoretical category has a finite image.*

Proof. Suppose the modular category \mathcal{C} is weakly group theoretical, then the category $\mathcal{D} = (\mathcal{C} \boxtimes \mathcal{C})_{\times, \mathbb{Z}/2\mathbb{Z}}^{\mathbb{Z}/2\mathbb{Z}}$ of its $\mathbb{Z}/2\mathbb{Z}$ permutation gauging is again weakly group theoretical [17], hence has property F by [20]. Therefore we have the braid group image obtained from the $\text{Hom}_{\mathcal{D}}((1, +) \oplus (1, -), (\hat{1}, +)^{\otimes 2n})$ is finite which is equivalent to the finite image of the $SMod(\Sigma_{n-1})$ representation by previous argument and Theorem 8.2. \square

Moreover 8.2, our symmetric mapping class group representation associated with $\mathcal{C}(\mathbb{Z}/(2r+1)\mathbb{Z}, q)$ is equivalent (again by Theorem 8.2) to ones calculated in [20] and [6], hence the image is finite, as a direct consequence, we have

Corollary 8.7. [23] *$SO(N)_2$ for $N = 2r + 1$ have property F .*

Proof. It is clear that $SO(N)_2$ is generated by the object $(\hat{1}, +)$, hence it suffices to consider the braid group representation on $\text{Hom}_{SO(N)_2}((1, +), (\hat{1}, +)^{\otimes 2n})$, which is an invariant subspace of $\text{Hom}_{SO(N)_2}((1, +) \oplus (1, -), (\hat{1}, +)^{\otimes 2n})$. And the latter space is naturally isomorphic to the space $Cf^1(n)$. \square

8.3. On cyclic permutation gauging. In [11] and [12], the authors give the formula of the S -matrix for the $\mathbb{Z}/n\mathbb{Z}$ permutation orbifold in the setting of vertex operator algebras. We ask the following natural question.

Question 8.8. Can our techniques be generalized to the case of $\mathbb{Z}/n\mathbb{Z}$ permutation gauging?

We believe the general idea is the same, and one needs to consider n -layer generalized configuration space instead. Hence the main difficulty here will be defining all these delicate structures, in particular, the braiding structures.

REFERENCES

- [1] E. Ardonne, M. Cheng, E. C. Rowell, and Z. Wang. Classification of metaplectic modular categories. *J. Algebra*, 466:141–146, 2016.
- [2] B. Bakalov and A. Kirillov, Jr. *Lectures on tensor categories and modular functors*, volume 21 of *University Lecture Series*. American Mathematical Society, Providence, RI, 2001.
- [3] P. Bantay. Characters and modular properties of permutation orbifolds. *Phys. Lett. B*, 419(1-4):175–178, 1998.
- [4] T. Barmeier and C. Schweigert. A geometric construction for permutation equivariant categories from modular functors. *Transform. Groups*, 16(2):287–337, 2011.
- [5] J. S. Birman and H. M. Hilden. *On the mapping class groups of closed surfaces as covering spaces*. Ann. of Math. Stud., No. 66. Princeton Univ. Press, Princeton, NJ, 1971.
- [6] W. Bloomquist and Z. Wang. On topological quantum computing with mapping class group representations. *J. Phys. A*, 52(1):015301, 23, 2019.
- [7] L. Borisov, M. B. Halpern, and C. Schweigert. Systematic approach to cyclic orbifolds. *Internat. J. Modern Phys. A*, 13(1):125–168, 1998.
- [8] A. Brothier, M. Hartglass, and D. Penneys. Rigid C^* -tensor categories of bimodules over interpolated free group factors. *J. Math. Phys.*, 53(12):123525, 43, 2012.
- [9] S. Burciu and S. Natale. Fusion rules of equivariantizations of fusion categories. *J. Math. Phys.*, 54(1):013511, 21, 2013.

- [10] S. X. Cui, C. Galindo, J. Y. Plavnik, and Z. Wang. On gauging symmetry of modular categories. *Comm. Math. Phys.*, 348(3):1043–1064, 2016.
- [11] C. Dong, L. Ren, and F. Xu. S -matrix in orbifold theory. *J. Algebra*, 568:139–159, 2021.
- [12] C. Dong, F. Xu, and N. Yu. S -matrix in permutation orbifolds. *J. Algebra*, 606:851–876, 2022.
- [13] V. Drinfeld, S. Gelaki, D. Nikshych, and V. Ostrik. On braided fusion categories. I. *Selecta Math. (N.S.)*, 16(1):1–119, 2010.
- [14] C. Edie-Michell, C. Jones, and J. Y. Plavnik. Fusion rules for $\mathbb{Z}/2\mathbb{Z}$ permutation gauging. *J. Math. Phys.*, 60(10):102302, 15, 2019.
- [15] P. Etingof, S. Gelaki, D. Nikshych, and V. Ostrik. *Tensor categories*, volume 205 of *Mathematical Surveys and Monographs*. American Mathematical Society, Providence, RI, 2015.
- [16] P. Etingof, D. Nikshych, and V. Ostrik. Fusion categories and homotopy theory. *Quantum Topol.*, 1(3):209–273, 2010. With an appendix by Ehud Meir.
- [17] P. Etingof, D. Nikshych, and V. Ostrik. Weakly group-theoretical and solvable fusion categories. *Adv. Math.*, 226(1):176–205, 2011.
- [18] T. Gannon and C. Jones. Vanishing of categorical obstructions for permutation orbifolds. *Comm. Math. Phys.*, 369(1):245–259, 2019.
- [19] S. K. Ghosh. Planar algebras: a category theoretic point of view. *J. Algebra*, 339:27–54, 2011.
- [20] J. Green and D. Nikshych. On the braid group representations coming from weakly group-theoretical fusion categories. *J. Algebra Appl.*, 20(1):Paper No. 2150210, 20, 2021.
- [21] b. Gui. Genus-zero permutation-twisted conformal blocks for tensor product vertex operator algebras: The tensor-factorizable case. *arXiv:2111.04662*, 2021.
- [22] A. Guionnet, V. F. R. Jones, and D. Shlyakhtenko. *Random matrices, free probability, planar algebras and subfactors*, volume 11 of *Clay Math. Proc.* Amer. Math. Soc., Providence, RI, 2010.
- [23] P. Gustafson, E. C. Rowell, and Y. Ruan. Metaplectic categories, gauging and property F . *Tohoku Math. J. (2)*, 72(3):411–424, 2020.
- [24] M. B. Hastings, C. Nayak, and Z. Wang. Metaplectic Anyons, Majorana Zero Modes, and their Computational Power. *Phys. Rev.*, B87(16):165421, 2013.
- [25] M. B. Hastings, C. Nayak, and Z. Wang. On metaplectic modular categories and their applications. *Comm. Math. Phys.*, 330(1):45–68, 2014.
- [26] A. G. Henriques, D. Penneys, and J. Tener. Planar algebras in braided tensor categories. *Mem. Amer. Math. Soc.*, 282(1392):vi+106, 2023.
- [27] V. F. R. Jones. Planar algebras, I. *New Zealand J. Math.*, 52:1–107, 2021 [2021–2022].
- [28] V. G. Kac, R. Longo, and F. Xu. Solitons in affine and permutation orbifolds. *Comm. Math. Phys.*, 253(3):723–764, 2005.
- [29] A. Kirillov, Jr. On G -equivariant modular categories. *ArXiv Mathematics e-prints*, Jan. 2004.
- [30] Z. Liu. Quon language: surface algebras and Fourier duality. *Comm. Math. Phys.*, 366(3):865–894, 2019.
- [31] Z. Liu, S. Morrison, and D. Penneys. Lifting shadings on symmetrically self-dual subfactor planar algebras. In *Topological phases of matter and quantum computation*, volume 747 of *Contemp. Math.*, pages 51–61. Amer. Math. Soc., [Providence], RI, [2020] ©2020.
- [32] Z. Liu and F. Xu. Jones-Wassermann subfactors for modular tensor categories. *Adv. Math.*, 355:106775, 40, 2019.
- [33] S. Morrison, E. Peters, and N. Snyder. Skein theory for the D_{2n} planar algebras. *J. Pure Appl. Algebra*, 214(2):117–139, 2010.
- [34] M. Müger. Conformal orbifold theories and braided crossed G -categories. *Comm. Math. Phys.*, 260(3):727–762, 2005.
- [35] D. Naidu and E. C. Rowell. A finiteness property for braided fusion categories. *Algebr. Represent. Theory*, 14(5):837–855, 2011.
- [36] N. Reshetikhin and V. G. Turaev. Invariants of 3-manifolds via link polynomials and quantum groups. *Invent. Math.*, 103(3):547–597, 1991.

- [37] E. C. Rowell. From quantum groups to unitary modular tensor categories. In *Representations of algebraic groups, quantum groups, and Lie algebras*, volume 413 of *Contemp. Math.*, pages 215–230. Amer. Math. Soc., Providence, RI, 2006.
- [38] E. C. Rowell and H. Wenzl. $SO(N)_2$ braid group representations are Gaussian. *Quantum Topol.*, 8(1):1–33, 2017.
- [39] Y. Ruan. Projective representations of hecke groups from topological quantum field theory. *arXiv:2203.10745*, 2022.
- [40] V. Turaev. *Homotopy quantum field theory*, volume 10 of *EMS Tracts in Mathematics*. European Mathematical Society (EMS), Zürich, 2010. Appendix 5 by Michael Müger and Appendices 6 and 7 by Alexis Virelizier.
- [41] V. G. Turaev. *Quantum invariants of knots and 3-manifolds*, volume 18 of *De Gruyter Studies in Mathematics*. Walter de Gruyter & Co., Berlin, revised edition, 2010.

Email address: ryz22@mails.tsinghua.edu.cn

Email address: liuzhengwei@mail.tsinghua.edu.cn