DERIVATIVES ON GRAPHS FOR THE POSITIVE CALCULUS OF RELATIONS WITH TRANSITIVE CLOSURE

YOSHIKI NAKAMURA 

Tokyo Institute of Technology, Japan
e-mail address: nakamura.yoshiki.ny@gmail.com

ABSTRACT. We prove that the equational theory of the positive calculus of relations with transitive closure (PCoR*) is EXPSPACE-complete. PCoR* terms consist of the following standard operators on binary relations: identity, empty, universality, union, intersection, composition, converse, and reflexive-transitive closure (so, PCoR* terms subsume Kleene algebra terms and allegory terms as fragments). Additionally, we show that the equational theory of PCoR* extended with tests and nominals (in hybrid logic) is still EXPSPACE-complete; moreover, it is PSPACE-complete for its intersection-free fragment.

To this end, we design derivatives on *graphs* by extending derivatives on words for regular expressions. The derivatives give a finite automata construction on path decompositions, like those on words. Because the equational theory has a linearly bounded pathwidth model property, using these automata, we can decide the equational theory of PCoR*.

1. INTRODUCTION

We consider *the positive calculus of relations with transitive closure* (PCoR*) [Pou18]: the algebraic system on binary relations with the operators $\{1, 0, \top, ;, +, \cap, -^\smile, -^*\}$ of identify (1), empty (0), universality (\top), composition ($;$), union ($+$), intersection (\cap), converse ($-^\smile$), and reflexive-transitive closure ($-^*$). Namely, PCoR* terms consist of the operators of Kleene algebra $\{1, 0, ;, +, -^*\}$ [Kle56, Con71, Koz91], those of allegory $\{1, ;, \cap, -^\smile\}$ [FS90], and the constant \top . PCoR* without \top are sometimes called *Kleene allegory* [BP15, BP17, Nak17].

If we added the complement operator ($-^\neg$) to PCoR*, then we would obtain the calculus of relations [Tar41, TG87] with transitive closure [Ng84]. However, the equational theory of the calculus of relations is undecidable [Tar41, TG87]. The undecidability result holds even for the terms with the three operators $\{;, +, -^\neg\}$ [Hir18] and even with one variable [Nak19]. Additionally, even if the complement only applies to atomic terms (variables or constants), the equational theory is still undecidable [Nak23]. In this paper, by excluding complement, we focus on *positive* fragments. For Kleene algebras (w.r.t. binary relations), the equational theory coincides with the language equivalence problem of regular expressions (see, e.g., [Pou18, Thm. 4]), and thus, the equational theory of Kleene algebras is decidable and PSPACE-complete, by the results on regular expressions [MS72]. For allegories (w.r.t.

Key words and phrases: Relation algebra, Kleene algebra, Derivative, Relational intersection, Series-Parallel Graph, Pathwidth.

This paper is a revised and extended version of [Nak17].

binary relations), the equational theory coincides with the graph homomorphic equivalence problem via an encoding of terms as graphs [FS90, AB95, CM77], and thus the equational theory of allegories is also decidable. For the equational theory of PCoR^* , Brunet and Pous extended the graph homomorphism characterizations above using graph languages [BP15, BP17]. By introducing Petri automata, which is an automata model for expressing graph languages, they have shown that the equational theory of *identity-free* Kleene lattices $\{0, ;, +, \cap, _^+\}$ w.r.t. relations [AMN11] is decidable and EXPSPACE -complete [BP15, BP17] where $(_+)$ denotes the transitive closure operator. However, the decidability and complexity were left open for Kleene allegories and PCoR^* at LICS 2015 [BP15].

Our main contribution in this work is to prove that the equational theory of PCoR^* is still decidable and EXPSPACE -complete. We first note that the equational theory has the treewidth at most 2 model property (Prop. 2.9) and the linearly bounded pathwidth model property (Prop. 2.10). Thus, the decidability can be derived from the decidability of MSO over bounded treewidth structures [Cou88]. However, the naive algorithm obtained from this fact has a non-elementary complexity (see Sect. 8, for more comparison to other systems related to PCoR^*). The EXPSPACE -hardness is shown by giving a reduction from the universality problem of regular expressions with intersection, which is EXPSPACE -complete [Fü80, Thm. 2]. (This was independently shown in [Nak17, BP17].)

To obtain the EXPSPACE upper bound of the equational theory of PCoR^* , we use the idea of derivatives on words for regular expressions, e.g., Brzozowski’s derivatives [Brz64] and Antimirov’s (partial) derivatives [Ant96, BBM⁺16], that are tools to obtain automata from regular expressions syntactically (we refer to the book [Sak09], for more details of derivatives on words). In this paper, we extend the derivatives from words to graphs. To this end, we consider Kleene lattices $\{1, 0, ;, +, \cap, _^*\}$, which is a core fragment of PCoR^* , and we extend terms with *labels* for pointing multiple vertices on graphs (Sect. 3). Thanks to this extension, similar to those on words, we can give derivatives on graphs/structures (Sect. 4). Derivatives of labeled Kleene lattice terms can simulate left quotients of run (a special form of DAG) languages (Sect. 2.2.1), as with that derivatives of regular expressions can simulate left quotients of word languages. Moreover, we show that our derivatives are decomposable on path decompositions (Thm. 5.5). Namely, from derivatives on (small) pre-glued graphs, we can compute the derivative on the (large) glued graph (in this sense, our approach can be viewed as a variant of the Feferman-Vaught decomposition theorem [Mak04, CE12]). Thanks to this decomposition with the linearly bounded pathwidth model property (Prop. 2.10), we can obtain an automata construction for Kleene lattice terms (Sect. 5). Using this construction, we have that the equational theory of Kleene lattices w.r.t. relations is EXPSPACE -complete (Cor. 5.13). Moreover, on our automata construction, we can give encodings of the following operators: universality (\top), converse ($-\smile$), tests in Kleene algebra with tests (KAT), and nominals in hybrid logic. Thus, the equational theory of PCoR^* is EXPSPACE -complete (Cor. 6.1), and moreover, the equational theory of PCoR^* with tests and nominals is EXPSPACE -complete (Cor. 6.3). Additionally, if the intersection width [GLL09] is fixed (particularly, if \cap does not occur), the equational theory of PCoR^* with tests and nominals is PSPACE -complete (Cor. 6.4).

Differences with the version at LICS 2017. This is a revised and extended version of the paper [Nak17], presented at the 32nd Annual ACM/IEEE Symposium on Logic in Computer Science (LICS 2017). The differences from the conference version are as follows.

- To express bounded pathwidth structures, we use a graph gluing operator (\odot) [BP16a], instead of “Sequential Graph Constructing Procedures” (SGCPs) [Nak17]. Roughly speaking, SGCPs enumerate a restricted (but complete to generate all structures of pathwidth at most k) path decompositions of width at most k , but combinations of the gluing operator enumerate all path decompositions of width at most k . The alphabet size, here, the number of structures of size at most k , is large, naively, but we can reduce it (see Sect. 6.3). Thanks to this separation of concerns, our formalizations are significantly simplified without changing the essence.
- Thanks to the above, we can easily encode some extra operators, e.g., top \top , converse \smile , tests in Kleene algebra with tests, and nominals in hybrid logic (Sects. 6.1 and 6.2). In the body of this paper, relying on these encodings, instead of PCOR* terms, we mainly consider Kleene lattice terms—PCOR* terms without top (\top) nor converse (\smile). This separation also slightly simplifies our formalizations.
- We use runs (defined in Sect. 2.2.1), instead of “simple graphs” in [Nak17]. Because each vertex of runs has one fun-in and one fun-out, we can more easily define left quotients, cf. [Nak17]. Our runs are essentially those of branching automata by Lodaya and Weil [LW98, LW00, LW01] without minor changes.
- We point out an error of [Nak17, Sect. IV] in Sect. 7.4. We give a counterexample that the decomposition rules corresponding to the argument in [Nak17, Lem. IV.10] are not complete (cf. Lem. 7.10), due to one-way reading. To avoid this problem, we use two-way alternating finite automata (2AFAs), not one-way automata.

Outline. In Sect. 2, we give basic definitions, including PCOR* terms and Kleene lattice terms (KL terms). In Sect. 3, we extend KL terms with labels. In Sect. 4, we define derivatives on structures (graphs without interfaces) for labeled KL terms. In Sect. 5, we give an automata construction using the derivatives. We then have that the equational theory of KL terms is decidable and EXPSPACE-complete. In Sect. 6, we give encodings of extra operators in our automata construction. Consequently, the equational theory of PCOR* terms with tests and nominals is also decidable and EXPSPACE-complete. In Sect. 7, we prove the decomposition theorem for the derivatives, which is the key to our automata construction in Sect. 5. In Sect. 8, we conclude this paper with related and future work.

2. PRELIMINARIES

We write \mathbb{N} for the set of non-negative integers. For $l, r \in \mathbb{N}$, we write $[l, r]$ for the set $\{i \in \mathbb{N} \mid l \leq i \leq r\}$. For $n \in \mathbb{N}$, we abbreviate $[1, n]$ to $[n]$. For a set X , we write $\#X$ for the cardinality of X and $\wp(X)$ for the power set of X . We use \uplus to denote that the union \cup is disjoint.

Word languages. We write wv for the concatenation of words w and v . We write 1 for the *empty word*. For a set X of *letters*, we write X^* for the set of *words* over X . A *language* over X is a subset of X^* . We use w, v to denote words and use \mathcal{L}, \mathcal{K} to denote languages. For languages $\mathcal{L}, \mathcal{K} \subseteq X^*$, the *concatenation* $\mathcal{L}; \mathcal{K}$, the *n -th iteration* \mathcal{L}^n (where $n \in \mathbb{N}$), the

Kleene plus \mathcal{L}^+ , the Kleene star \mathcal{L}^* are defined by:

$$\mathcal{L};\mathcal{K} \triangleq \{wv \mid w \in \mathcal{L} \wedge v \in \mathcal{K}\}, \quad \mathcal{L}^n \triangleq \begin{cases} \mathcal{L}; \mathcal{L}^{n-1} & (n \geq 1) \\ \{1\} & (n = 0) \end{cases}, \quad \mathcal{L}^+ \triangleq \bigcup_{n \geq 1} \mathcal{L}^n, \quad \mathcal{L}^* \triangleq \bigcup_{n \geq 0} \mathcal{L}^n.$$

Binary relations. We write Δ_A for the identity relation on a set A : $\Delta_A \triangleq \{\langle x, x \rangle \mid x \in A\}$. For binary relations R, S on a set B , the *composition* $R; S$, the *converse* R^\smile , the *n -th iteration* R^n (where $n \in \mathbb{N}$), the *transitive closure* R^+ , and the *reflexive transitive closure* R^* are defined by:

$$R; S \triangleq \{\langle x, z \rangle \mid \exists y, \langle x, y \rangle \in R \wedge \langle y, z \rangle \in S\}, \quad R^\smile \triangleq \{\langle x, y \rangle \mid \langle y, x \rangle \in R\},$$

$$R^n \triangleq \begin{cases} R; R^{n-1} & (n \geq 1) \\ \Delta_B & (n = 0) \end{cases}, \quad R^+ \triangleq \bigcup_{n \geq 1} R^n, \quad R^* \triangleq \bigcup_{n \geq 0} R^n.$$

Graphs with bi-interface. We consider graphs with bi-interface, inspired by [BP16a, bi-interface graphs][BGK⁺16, symmetric monoidal structures]. Interfaces are used to define the series composition (Def. 2.1). Let A be a set with a map $\text{ty}: A \rightarrow \mathbb{N}^2$; we also let ty_1 and ty_2 be such that $\text{ty}(a) = \langle \text{ty}_1(a), \text{ty}_2(a) \rangle$ for each $a \in A$. For $n, m \in \mathbb{N}$, a *graph* G over A (with $\langle n, m \rangle$ -interface) is a tuple $\langle |G|, \{a^G\}_{a \in A}, 1_1^G, \dots, 1_n^G, 2_1^G, \dots, 2_m^G \rangle$, where

- $|G|$ is a (possibly empty) set;
- $a^G \subseteq |G|^{\text{ty}_1(a) + \text{ty}_2(a)}$ is a $(\text{ty}_1(a) + \text{ty}_2(a))$ -ary relation for each $a \in A$;
- $1_l^G \in |G|$ is the l -th *source* vertex for each $l \in [n]$;
- $2_r^G \in |G|$ is the r -th *target* vertex for each $r \in [m]$.

Note that, if $|G| = \emptyset$, then $n = m = 0$. We let $\text{ty}(G) \triangleq \langle \text{ty}_1(G), \text{ty}_2(G) \rangle \triangleq \langle n, m \rangle$. We often abbreviate 1_1^G to 1^G and 2_1^G to 2^G , respectively.

Let G, H be graphs over a set A with $\langle n, m \rangle$ -interface. We say that a map $f: |G| \rightarrow |H|$ is a *graph homomorphism* from G to H , written $f: G \rightarrow H$, if for each $a \in A$ and $x_1, \dots, x_n \in |G|$, $\langle x_1, \dots, x_n \rangle \in a^G$ implies $\langle f(x_1), \dots, f(x_n) \rangle \in a^H$, for each $l \in [n]$, $f(1_l^G) = 1_l^H$, and for each $r \in [m]$, $f(2_r^G) = 2_r^H$. Particularly, we say that f is a *graph isomorphism* from G to H , written $f: G \cong H$, if f is a bijective graph homomorphism from G to H , and for each $a \in A$ and $x_1, \dots, x_n \in |G|$, $\langle x_1, \dots, x_n \rangle \in a^G$ iff $\langle f(x_1), \dots, f(x_n) \rangle \in a^H$. We write $G \rightarrow H$ (resp. $G \cong H$) if there is some $f: G \rightarrow H$ (resp. $f: G \cong H$). In the sequel, we identify two graphs if there is a graph isomorphism between them (except for structures; see Sect. 3.1); we write $G = H$ when $G \cong H$.

For instance, when $A = \{a, \mathbf{f}, \mathbf{j}\}$ with $\text{ty}(a) = \langle 1, 1 \rangle$, $\text{ty}(\mathbf{f}) = \langle 1, 2 \rangle$, and $\text{ty}(\mathbf{j}) = \langle 2, 1 \rangle$ and $|G| = \{1, 2, 3, 4\}$, $a^G = \{\langle 1, 2 \rangle\}$, $\mathbf{f}^G = \{\langle 1, 2, 3 \rangle\}$, $\mathbf{j}^G = \{\langle 2, 3, 4 \rangle\}$, $\text{ty}(G) = \langle 1, 1 \rangle$, $1_1^G = 1$, and $2_1^G = 4$, we depict the graph G as the figure on the left-hand side. For notational simplicity, we often omit vertex labels and some “1” labels as the right-hand side.

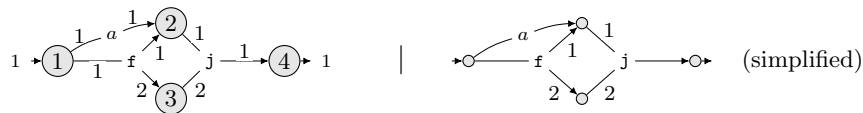

We may depict graphs G with $\text{ty}(G) = \langle n, m \rangle$ as one edge:

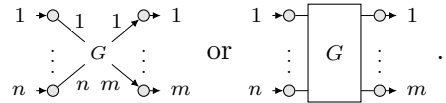

For an equivalence relation E on $|G|$, the *quotient graph* of G w.r.t. E is the graph $G/E \triangleq \langle |G|/E, \{ \langle X, Y \rangle \mid \exists x \in X, y \in Y, \langle x, y \rangle \in a^G \}_{a \in A}, [1_1^G]_E, \dots, [1_n^G]_E, [2_1^G]_E, \dots, [2_m^G]_E \rangle$ where X/E denotes the set of equivalence classes of X by E and $[x]_E$ denotes the equivalence class of x .

Series and parallel composition. For graphs, we use the series composition and the parallel composition, defined as follows.

Definition 2.1. For graphs, $G = \left(\begin{array}{ccc} 1 \circ \rightarrow & \boxed{G} & \circ \rightarrow 1 \\ \vdots & & \vdots \\ n \circ \rightarrow & & \circ \rightarrow m \end{array} \right)$ and $H = \left(\begin{array}{ccc} 1 \circ \rightarrow & \boxed{H} & \circ \rightarrow 1 \\ \vdots & & \vdots \\ n' \circ \rightarrow & & \circ \rightarrow m' \end{array} \right)$, the *series composition* $G \diamond H$ and the *parallel composition* $G \parallel H$ are defined as follows, respectively:

$$G \diamond H \triangleq \begin{cases} \left(\begin{array}{ccc} 1 \circ \rightarrow & \boxed{G} & \circ \rightarrow 1 \\ \vdots & & \vdots \\ n \circ \rightarrow & & \circ \rightarrow m' \end{array} \right) \left(\begin{array}{ccc} \circ \rightarrow 1 & & \circ \rightarrow 1 \\ \vdots & & \vdots \\ \circ \rightarrow m & & \circ \rightarrow m' \end{array} \right) & (m = n') \\ \text{undefined} & (\text{otherwise}) \end{cases}, \quad G \parallel H \triangleq \left(\begin{array}{ccc} 1 \circ \rightarrow & \boxed{G} & \circ \rightarrow 1 \\ \vdots & & \vdots \\ n \circ \rightarrow & & \circ \rightarrow m \\ n+1 \circ \rightarrow & & \circ \rightarrow m+1 \\ \vdots & & \vdots \\ n+n' \circ \rightarrow & \boxed{H} & \circ \rightarrow m+m' \end{array} \right).$$

($G \diamond H$ is the graph obtained from G and H by merging 2_i^G and 1_i^H for $i \in [m]$.)

For instance,

$$\begin{aligned} \left(\begin{array}{ccc} 1 \\ \circ \rightarrow \\ 2 \end{array} \right) \diamond \left(\begin{array}{ccc} 1 \rightarrow \circ - a \rightarrow \circ & 1 \\ 2 \rightarrow \circ - b \rightarrow \circ & 2 \end{array} \right) \diamond \left(\begin{array}{ccc} 1 \rightarrow \circ & 1 \\ 2 \rightarrow \circ - c \rightarrow \circ & 2 \end{array} \right) \diamond \left(\begin{array}{ccc} 1 \\ \circ \rightarrow \\ 2 \end{array} \right) &= \left(\begin{array}{ccc} & a & \\ \circ & & \circ \\ & b & \\ & \circ & \\ & & c & \\ & & \circ & \end{array} \right), \\ \left(\begin{array}{ccc} 1 \\ \circ \rightarrow \\ 2 \end{array} \right) \diamond \left(\begin{array}{ccc} & \circ - a \rightarrow \circ & \\ & \parallel & \\ ((\circ - b \rightarrow \circ) & \diamond & (\circ - c \rightarrow \circ)) \end{array} \right) \diamond \left(\begin{array}{ccc} 1 \\ \circ \rightarrow \\ 2 \end{array} \right) &= \left(\begin{array}{ccc} & a & \\ \circ & & \circ \\ & b & \\ & \circ & \\ & & c & \\ & & \circ & \end{array} \right). \end{aligned}$$

For $n \in \mathbb{N}$, we let 1^n be the following graph with $\langle n, n \rangle$ -interface: $1^n \triangleq \left(\begin{array}{ccc} 1 \rightarrow \circ & 1 \\ \vdots & \\ n \rightarrow \circ & n \end{array} \right)$.

Each 1^n is an *empty* graph and the graph 1^0 is the *null* graph. Each 1^n is the identity element w.r.t. \diamond on graphs with $\langle n, n \rangle$ -interface and 1^0 is the identity element w.r.t. \parallel on graphs with $\langle n, m \rangle$ -interface:

$$G \diamond 1^n = G \quad 1^n \diamond G = G \quad G \parallel 1^0 = G \quad 1^0 \parallel G = G.$$

Pathwidth and treewidth. We recall the pathwidth and treewidth of structures [CE12, Def. 9.12], which are defined based on the pathwidth [RS83] (see also, e.g., [Bod98, Thm. 2][BP16a, Lem. 4.6] for alternative characterizations) and the treewidth [RS86] for graphs. We use these parameters also for graphs with bi-interface by forgetting bi-interface. For a graph G , a *path decomposition* of G is a sequence $\vec{H} = \langle H_1, \dots, H_n \rangle$ of finite graphs such that

- $|G| = \bigcup_{i \in [n]} |H_i|$ and $a^G = \bigcup_{i \in [n]} a^{H_i}$ for each $a \in A$;
- $|H_i| \cap |H_k| \subseteq |H_j|$ for all $1 \leq i \leq j \leq k \leq n$.

The *width* of \vec{H} is $\max_{i \in [n]} (\#|H_i| - 1)$. The *pathwidth* $\text{pw}(G)$ of a graph G is the minimum width among path decompositions of G .

Similarly, for a graph G , a *tree decomposition* of G is a finite rooted tree $\vec{H} = \{H_w\}_{w \in \Gamma}$ of graphs, where $\Gamma \subseteq \mathbb{N}^*$ is a finite and prefix-closed ($ww' \in \Gamma$ implies $w \in \Gamma$) set, such that

- $|G| = \bigcup_{w \in \Gamma} |H_w|$ and $a^G = \bigcup_{w \in \Gamma} a^{H_w}$ for each $a \in A$;
- $|H_w| \cap |H_u| \subseteq |H_v|$ for all $w, v, u \in \Gamma$ s.t. v is on the unique path between w and u (i.e., v satisfies $v_0 \preceq_{\text{pref}} v \preceq_{\text{pref}} w$ or $v_0 \preceq_{\text{pref}} v \preceq_{\text{pref}} u$ where $w' \preceq_{\text{pref}} v'$ denotes that w' is a prefix of v' and v_0 denotes the maximal common prefix word of w and u).

The *width* of \vec{H} is $\max_{w \in \Gamma} (\#|H_w| - 1)$. The *treewidth* $\text{tw}(G)$ of a graph G is the minimum width among tree decompositions of G .

Remark 2.2. We ignore bi-interface in the definition above, cf. [CE12, Def. 2.5.3][Nak17]. Then, the pathwidth/treewidth of a graph G coincide with those of its Gaifman graph (the graph $\langle |G|, E \rangle$ where E is the binary relation $\bigcup_{a \in A} \bigcup_{\langle x_1, \dots, x_k \rangle \in a^G} \{ \langle x_i, x_j \rangle \mid i, j \in [k] \wedge x_i \neq x_j \}$ [EF95, p. 26]), respectively (because we can use the same path/tree decompositions). Additionally, by definition, the number of components is finite (cf., e.g., [Cou90]); this is sufficient in this paper as we are mainly interested in finite structures (thanks to the Prop. 2.8).

2.1. PCoR*: **The Positive Calculus of Relations.** We consider the positive calculus of relations with transitive closure (PCoR*). We use Σ to denote a set of *variables*. The set of *PCoR* terms* over Σ is defined as the set of terms over the signature $\{\mathbf{1}_{(0)}, \mathbf{0}_{(0)}, \top_{(0)}, ;_{(2)}, +_{(2)}, \cap_{(2)}, \smile_{(1)}, *_{{(1)}}\}$ and the variable set Σ :

$$t, s, u ::= a \mid \mathbf{1} \mid \mathbf{0} \mid \top \mid t; s \mid t + s \mid t \cap s \mid t \smile \mid t^*. \quad (a \in \Sigma)$$

We often abbreviate $t; s$ to ts . We use parentheses in ambiguous situations (where $+$, \cdot , \cap are left-associative). We write $\sum_{i=1}^n t_i$ for the term $\mathbf{0} + t_1 + \dots + t_n$. We also let $t^+ \triangleq tt^*$.

An *equation* $t = s$ is a pair of PCoR* terms. An *inequation* $t \leq s$ abbreviates the equation $t + s = s$.

For a PCoR* term t , the *size* $\|t\|$ is the number of symbols occurring in t :

$$\begin{aligned} \|a\| &\triangleq 1 \text{ for } a \in \Sigma \cup \{\mathbf{1}, \mathbf{0}, \top\}, & \|t^\heartsuit\| &\triangleq 1 + \|t\| \text{ for } \heartsuit \in \{\smile, *\}, \\ \|t \heartsuit s\| &\triangleq 1 + \|t\| + \|s\| \text{ for } \heartsuit \in \{;, +, \cap\}. \end{aligned}$$

Additionally, the *intersection width* $\text{iw}(t)$ [GLL09] is defined as follows:

$$\begin{aligned} \text{iw}(a) &\triangleq 1 \text{ for } a \in \Sigma \cup \{\mathbf{1}, \mathbf{0}, \top\}, & \text{iw}(t^\heartsuit) &\triangleq \text{iw}(t) \text{ for } \heartsuit \in \{\smile, *\}, \\ \text{iw}(t \heartsuit s) &\triangleq \max(\text{iw}(t), \text{iw}(s)) \text{ for } \heartsuit \in \{;, +\}, & \text{iw}(t \cap s) &\triangleq \text{iw}(t) + \text{iw}(s). \end{aligned}$$

For instance, $\text{iw}(a \cap b \cap c \cap d) = 4$ and $\text{iw}((a \cap b); (a \cap c); (a \cap d)) = 2$.

Proposition 2.3. *For all PCoR* terms t , we have $\text{iw}(t) \leq \|t\|$.*

Proof. By easy induction on t . □

2.1.1. *Semantics: relational models.* A *structure (of binary relations)* is a non-empty graph with $\langle 0, 0 \rangle$ -interface over the set Σ with $\text{ty}(a) = \langle 1, 1 \rangle$ for $a \in \Sigma$. We use $\mathfrak{A}, \mathfrak{B}$ to denote a structure. Let \mathfrak{A} be a structure. For a PCoR* term t , the *semantics* $\llbracket t \rrbracket_{\mathfrak{A}} \subseteq |\mathfrak{A}|^2$ is defined as follows:

$$\begin{aligned} \llbracket a \rrbracket_{\mathfrak{A}} &\triangleq a^{\mathfrak{A}}, & \llbracket 1 \rrbracket_{\mathfrak{A}} &\triangleq \Delta_{|\mathfrak{A}|}, & \llbracket 0 \rrbracket_{\mathfrak{A}} &\triangleq \emptyset, & \llbracket \top \rrbracket_{\mathfrak{A}} &\triangleq |\mathfrak{A}|^2, & \llbracket t ; s \rrbracket_{\mathfrak{A}} &\triangleq \llbracket t \rrbracket_{\mathfrak{A}} ; \llbracket s \rrbracket_{\mathfrak{A}}, \\ \llbracket t + s \rrbracket_{\mathfrak{A}} &\triangleq \llbracket t \rrbracket_{\mathfrak{A}} \cup \llbracket s \rrbracket_{\mathfrak{A}}, & \llbracket t \cap s \rrbracket_{\mathfrak{A}} &\triangleq \llbracket t \rrbracket_{\mathfrak{A}} \cap \llbracket s \rrbracket_{\mathfrak{A}}, & \llbracket t \smile \rrbracket_{\mathfrak{A}} &\triangleq \llbracket t \rrbracket_{\mathfrak{A}}^{\smile}, & \llbracket t^* \rrbracket_{\mathfrak{A}} &\triangleq \llbracket t \rrbracket_{\mathfrak{A}}^*. \end{aligned}$$

We write REL for the class of all structures. For $\mathcal{C} \subseteq \text{REL}$, we write $\mathcal{C} \models t = s$ if $\llbracket t \rrbracket_{\mathfrak{A}} = \llbracket s \rrbracket_{\mathfrak{A}}$ for all $\mathfrak{A} \in \mathcal{C}$. In the sequel, we consider the *equational theory* w.r.t. REL . For instance, the following equations hold w.r.t. REL :

$$(t^* s^*)^* = (t + s)^* \quad (2.1) \quad t(s \cap u) \leq (ts) \cap (tu) \quad (2.3) \quad t^+ \cap 1 \leq (tt)^+ \quad (2.5)$$

$$t^* = (tt)^*(1 + t) \quad (2.2) \quad (ts) \cap u \leq t(s \cap (t \smile u)) \quad (2.4) \quad (t \cap s \smile)^+ \cap 1 \leq (t \cap s^+)^+ \quad (2.6)$$

Notably, the equational theory of PCoR* contains that of Kleene algebras $\langle 1, 0, ;, +, -^* \rangle$ [Koz91] (such as Equations (2.1) and (2.2)) and that of allegories $\langle 1, ;, \cap, - \smile \rangle$ [FS90, PV18] (such as Equations (2.3) and (2.4)); see also [BÉS95, BP16b] for Kleene algebras with converse $\langle 1, 0, ;, +, -^*, - \smile \rangle$ and [AMN11, DP18] for identity-free Kleene lattices $\langle 0, ;, +, \cap, -^+ \rangle$. Equation (2.5)[Pou18, p. 14] and Equation (2.6) are non-trivial instances of the equations having transitive closure and intersection.

Remark 2.4. The (word) language model LANG [BÉS95, AMN11, Bru17] is another interesting model of PCoR* terms; in LANG , each variable interprets a (possibly non-singleton) language, and each operator interprets the corresponding operator in regular expressions. Notably for identity-free Kleene lattices, the equational theory w.r.t. LANG coincides with that w.r.t. REL [AMN11, Thm. 4.1]. However for Kleene lattices and PCoR*, the coincide is broken, e.g., Equations (2.4) to (2.6) are counterexamples. For the equational theory of Kleene lattices, LANG can be characterized as a subclass of totally ordered (generalized) relational models [Nak24a].

2.1.2. *An alternative semantics: graph languages.* We recall graph languages for PCoR* [BP17][Pou18, Def. 15]. The *graph language* $\mathcal{G}(t)$ of a PCoR* term t is the set of graphs with $\langle 1, 1 \rangle$ -interface over Σ , defined as follows:

$$\begin{aligned} \mathcal{G}(a) &\triangleq \{ \text{node} \xrightarrow{a} \text{node} \} \text{ for } a \in \Sigma, & \mathcal{G}(0) &\triangleq \emptyset, & \mathcal{G}(\top) &\triangleq \{ \text{node} \circ \text{node} \}, \\ \mathcal{G}(t \smile) &\triangleq \{ \text{node} \xrightarrow{G} \text{node} \mid G \in \mathcal{G}(t) \}, & \mathcal{G}(1) &\triangleq \{ \text{node} \circ \text{node} \}, \\ \mathcal{G}(t \cap s) &\triangleq \left\{ \text{node} \xrightarrow[\text{node}]{G} \text{node} \mid G \in \mathcal{G}(t) \wedge H \in \mathcal{G}(s) \right\}, & \mathcal{G}(t + s) &\triangleq \mathcal{G}(t) \cup \mathcal{G}(s), \\ \mathcal{G}(t ; s) &\triangleq \{ \text{node} \xrightarrow{G} \text{node} \xrightarrow{H} \text{node} \mid G \in \mathcal{G}(t) \wedge H \in \mathcal{G}(s) \}, & \mathcal{G}(t^*) &\triangleq \bigcup_{n \geq 0} \mathcal{G}(t^n). \end{aligned}$$

For instance,

$$\begin{aligned} \mathcal{G}(a \cap (bc \smile)) &= \left\{ \begin{array}{c} \text{node} \xrightarrow{a} \text{node} \\ \text{node} \xrightarrow{b} \text{node} \xrightarrow{c} \text{node} \end{array} \right\}, \\ \mathcal{G}(\left(\left(\left(aa \right) \cap 1 \right) b \top c \right) + d) &= \left\{ \begin{array}{c} \text{node} \xrightarrow{a} \text{node} \xrightarrow{a} \text{node} \\ \text{node} \xrightarrow{b} \text{node} \end{array} \right\}, \quad \left\{ \text{node} \xrightarrow{d} \text{node} \right\}, \\ \mathcal{G}(a^*) &= \left\{ \text{node} \circ \text{node}, \text{node} \xrightarrow{a} \text{node} \xrightarrow{a} \text{node}, \text{node} \xrightarrow{a} \text{node} \xrightarrow{a} \text{node} \xrightarrow{a} \text{node}, \dots \right\}. \end{aligned}$$

Proposition 2.5. *For all PCoR* terms t and $G \in \mathcal{G}(t)$, we have $\text{tw}(G) \leq 2$.*

Proof (Cor. of [Bod98, Thm. 41]). By induction on $\langle ;, \cap \rangle$ -terms, every series-parallel graph has some tree decomposition of width 2 such that its root component has the source and target vertices (hence, its treewidth is at most 2) [Bod98, Thm. 41]. Similarly, by induction on PCoR* terms t , each graph $G \in \mathcal{G}(t)$ has some tree decomposition of width 2 such that its root component has the source and target vertices of G . \square

Proposition 2.6. *For all PCoR* terms t and $G \in \mathcal{G}(t)$, we have $\text{pw}(G) \leq \text{iw}(t)$.*

Proof. Similar to the above, by easy induction on t , each graph $G \in \mathcal{G}(t)$ has some path decomposition $\vec{H} = H_1 \dots H_n$ of width $\text{iw}(t)$ such that H_1 contains the source vertex and H_n contains the target vertex. \square

In this paper, we use the graph languages above as an alternative semantics. Let \mathfrak{A} be a structure. For $x, y \in |\mathfrak{A}|$, we write $\mathsf{G}(\mathfrak{A}, x, y)$ for the graph defined by $\langle |\mathfrak{A}|, \{\llbracket a \rrbracket_{\mathfrak{A}}\}_{a \in \Sigma}, x, y \rangle$. For a graph H and a set \mathcal{G} of graphs, we define $\llbracket H \rrbracket_{\mathfrak{A}}$ and $\llbracket \mathcal{G} \rrbracket_{\mathfrak{A}}$ as follows:

$$\llbracket H \rrbracket_{\mathfrak{A}} \triangleq \{ \langle x, y \rangle \mid H \longrightarrow \mathsf{G}(\mathfrak{A}, x, y) \}, \quad \llbracket \mathcal{G} \rrbracket_{\mathfrak{A}} \triangleq \bigcup_{H \in \mathcal{G}} \llbracket H \rrbracket_{\mathfrak{A}}.$$

We then have the following.

Proposition 2.7 ([AMN11, Lem. 2.1] (for PCoR* without \top), [BP17, Lem. 2.3] (for PCoR*)). *Let \mathfrak{A} be a structure. For all PCoR* terms t , we have $\llbracket t \rrbracket_{\mathfrak{A}} = \llbracket \mathcal{G}(t) \rrbracket_{\mathfrak{A}}$.*

Proof. By easy induction on t using distributivity of $;$, \cap , and \smile . \square

For instance, when $\mathfrak{A} = \left(\begin{array}{c} a \\ \downarrow \\ (x) \xrightarrow{b} (y) \\ \uparrow \\ c \end{array} \right)$, we have $\langle x, x \rangle \in \llbracket a \cap (bc^{\smile}) \rrbracket_{\mathfrak{A}}$ by the following:

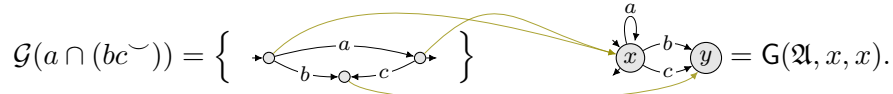

As a corollary of Prop. 2.7, we also have the following bounded model property.

Proposition 2.8 (graph language bounded model property). *For all PCoR* terms t, s ,*

$$\text{REL} \models t \leq s \quad \Leftrightarrow \quad \{ \mathfrak{A} \mid \exists x, y \in |\mathfrak{A}|, \mathsf{G}(\mathfrak{A}, x, y) \in \mathcal{G}(t) \} \models t \leq s.$$

Proof. (\Rightarrow): Trivial. (\Leftarrow): We prove the contraposition. Assume $\langle x, y \rangle \in \llbracket t \rrbracket_{\mathfrak{A}} \setminus \llbracket s \rrbracket_{\mathfrak{A}}$ for $\mathfrak{A} \in \text{REL}$ and $x, y \in |\mathfrak{A}|$. By Prop. 2.7, $G' \longrightarrow \mathsf{G}(\mathfrak{A}, x, y)$ for some $G' \in \mathcal{G}(t)$, and $H \not\rightarrow \mathsf{G}(\mathfrak{A}, x, y)$ for all $H \in \mathcal{G}(s)$. Let \mathfrak{B}, x', y' be s.t. $\mathsf{G}(\mathfrak{B}, x', y') = G'$. By $\mathsf{G}(\mathfrak{B}, x', y') = G' \longrightarrow \mathsf{G}(\mathfrak{A}, x, y)$, we have $\langle x', y' \rangle \notin \llbracket s \rrbracket_{\mathfrak{B}}$ (for $H \in \mathcal{G}(s)$, if $H \longrightarrow \mathsf{G}(\mathfrak{B}, x', y')$, then $H \longrightarrow \mathsf{G}(\mathfrak{A}, x, y)$, thus reaching a contradiction). By $G' \longrightarrow G' = \mathsf{G}(\mathfrak{B}, x', y')$, we have $\langle x', y' \rangle \in \llbracket t \rrbracket_{\mathfrak{B}}$. Hence, $\langle x', y' \rangle \in \llbracket t \rrbracket_{\mathfrak{B}} \setminus \llbracket s \rrbracket_{\mathfrak{B}}$. By $\mathsf{G}(\mathfrak{B}, x', y') \in \mathcal{G}(t)$, this completes the proof. \square

For a class $\mathcal{C} \subseteq \text{REL}$, we use the following notations:

$$\mathcal{C}_{\text{pw} \leq k} = \{ \mathfrak{A} \in \mathcal{C} \mid \text{pw}(\mathfrak{A}) \leq k \}, \quad \mathcal{C}_{\text{tw} \leq k} = \{ \mathfrak{A} \in \mathcal{C} \mid \text{tw}(\mathfrak{A}) \leq k \}.$$

As a corollary of Prop. 2.8, we also have the following two model properties.

Proposition 2.9 (treewidth at most 2 model property). *For all PCoR* terms t, s ,*

$$\text{REL} \models t \leq s \quad \Leftrightarrow \quad \text{REL}_{\text{tw} \leq 2} \models t \leq s.$$

Proof. By Prop. 2.8 with that every graph of $\mathcal{G}(t)$ has treewidth at most 2 (Prop. 2.5). \square

Proposition 2.10 (linearly bounded pathwidth model property). *For all PCoR* terms t, s ,*

$$\text{REL} \models t \leq s \quad \Leftrightarrow \quad \text{REL}_{\text{pw} \leq \text{iw}(t)} \models t \leq s.$$

Proof. By Prop. 2.8 with that every graph of $\mathcal{G}(t)$ has pathwidth at most $\text{iw}(t)$ (Prop. 2.6). \square

Note that we can easily translate the equational theory of PCoR* terms into the theory of monadic second-order logic (MSO) formulas¹ as an analogy of the standard translation from the equational theory of the calculus of relations into the theory of 3-variable first-order logic formulas [Tar41, TG87, Giv07]. Because the theory of MSO over bounded treewidth structures is decidable [Cou88, Cou90, CE12], Prop. 2.9 (or Prop. 2.10) implies that the equational theory of PCoR* is decidable. However, the naive algorithm obtained from the above has a non-elementary complexity. We will show that the equational theory of PCoR* is EXPSPACE-complete (Cor. 6.1).

Additionally, Brunet and Pous gave the following graph-theoretic characterization of the equational theory for PCoR*, which is a generalization of the characterization known for conjunctive queries [CM77], allegories [FS90] and union-free relation algebras [AB95].

Proposition 2.11 ([BP15, BP17]). *For all PCoR* terms t, s ,*

$$\text{REL} \models t \leq s \quad \Leftrightarrow \quad \forall G \in \mathcal{G}(t), \exists H \in \mathcal{G}(s), H \longrightarrow G.$$

2.1.3. *Comparison to word languages.* The word language $[t]_\Sigma$ of a Kleene lattice term with top (i.e., terms over $\{1, 0, \top, ;, +, \cap, -^*\}$) t is the set of words over Σ defined as follows (we recall word language operators in Sect. 2):

$$\begin{aligned} [a]_\Sigma &\triangleq \{a\} \text{ for } \Sigma, & [0]_\Sigma &\triangleq \emptyset, & [1]_\Sigma &\triangleq \{1\}, & [\top]_\Sigma &\triangleq \Sigma^*, \\ [t \cap s]_\Sigma &\triangleq [t]_\Sigma \cap [s]_\Sigma, & [t + s]_\Sigma &\triangleq [t]_\Sigma \cup [s]_\Sigma, & [t ; s]_\Sigma &\triangleq [t]_\Sigma ; [s]_\Sigma, & [t^*]_\Sigma &\triangleq [t]_\Sigma^*. \end{aligned}$$

For Kleene algebra terms (i.e., terms over $\{1, 0, ;, +, -^*\}$) t and s , the following is well-known (see, e.g., [Pou18, Thm. 4]): $\text{REL} \models t \leq s$ iff $[t]_\Sigma \subseteq [s]_\Sigma$. This equivalence can be slightly strengthened as follows.

Proposition 2.12 ([Nak17, BP17], but extended for \top). *For all Kleene algebra terms t and Kleene lattice terms with top s , we have:*

$$\text{REL} \models t \leq s \quad \Leftrightarrow \quad [t]_\Sigma \subseteq [s]_\Sigma.$$

Proof. (In [Nak17, Thm. VI.3], this was shown via the tree unfolding technique in modal logic. The following is a simpler proof [BP17, Prop. 10.2] base on the graph language characterization.) For all Kleene lattice terms with top s and words $w \in \Sigma^*$, we have:

$$\exists H \in \mathcal{G}(s), H \longrightarrow G(w) \quad \Leftrightarrow \quad w \in [s]_\Sigma$$

where $G(w)$ is the unique graph s.t. $\mathcal{G}(w) = \{G(w)\}$. It is shown by easy induction on s . Thus by Prop. 2.11, this completes the proof. \square

This equivalence fails when \cap occurs in t . For instance, if $t = a \cap b$ and $s = 0$ where $a \neq b$, then we have $[t]_\Sigma = [s]_\Sigma = \emptyset$ but $a \cap b \leq 0$ does not hold w.r.t. REL. (In such cases, graph languages are required for Kleene lattice terms and PCoR* terms.)

¹W.r.t. binary relations, the expressive power of PCoR* is equivalent to that of 3-variable existential positive logic with variable-confined monadic transitive closure [Nak20, Nak22].

For runs H and a set \mathcal{G} of runs, we define $\llbracket H \rrbracket_{\mathfrak{A}}$ and $\llbracket \mathcal{G} \rrbracket_{\mathfrak{A}}$ as follows:

$$\llbracket H \rrbracket_{\mathfrak{A}} \triangleq \{\vec{x}\vec{y} \mid \vec{x} \in |\mathfrak{A}|^{\text{ty}_1(H)} \wedge \vec{y} \in |\mathfrak{A}|^{\text{ty}_2(H)} \wedge H \longrightarrow \tilde{\mathcal{G}}(\mathfrak{A}, \vec{x}, \vec{y})\}, \quad \llbracket \mathcal{G} \rrbracket_{\mathfrak{A}} \triangleq \bigcup_{H \in \mathcal{G}} \llbracket H \rrbracket_{\mathfrak{A}}.$$

We then have the following as with Prop. 2.7.

Proposition 2.14. *Let \mathfrak{A} be a structure. For all KL terms t , we have $\llbracket t \rrbracket_{\mathfrak{A}} = \llbracket \mathcal{R}(t) \rrbracket_{\mathfrak{A}}$.*

Proof. By easy induction on t using distributivity of $;$ and \cap . \square

2.2.2. Compositions on runs. We recall the series composition \diamond , the parallel composition \parallel , and the identify elements 1^n (Def. 2.1). The set of *atomic runs* is defined as $\bar{\Sigma} \triangleq \{a_i^n \mid a \in \Sigma_{\mathfrak{f}, \mathfrak{j}}, n \geq 1, i \in [n]\}$ where $a_i^n \triangleq 1^{i-1} \parallel (\rightarrow \circ - a \rightarrow \circ) \parallel 1^{n-i}$ for $a \in \Sigma$, $\mathfrak{f}_i^n \triangleq 1^{i-1} \parallel \left(\begin{array}{c} \rightarrow \circ - \mathfrak{f} \\ \begin{array}{ccc} & \begin{array}{c} \nearrow \circ \rightarrow 1 \\ \searrow \circ \rightarrow 2 \end{array} & \\ \end{array} \end{array} \right) \parallel 1^{n-i}$, and $\mathfrak{j}_i^n \triangleq 1^{i-1} \parallel \left(\begin{array}{c} \begin{array}{ccc} \begin{array}{c} \nearrow \circ \rightarrow 1 \\ \searrow \circ \rightarrow 2 \end{array} & \mathfrak{j} & \rightarrow \circ \\ \end{array} & \rightarrow \circ & \end{array} \right) \parallel 1^{n-i}$.

Namely, a_i^n , \mathfrak{f}_i^n , and \mathfrak{j}_i^n are given as follows:

$$a_i^n = \begin{pmatrix} 1 \rightarrow \circ \rightarrow 1 \\ \vdots \\ i-1 \rightarrow \circ \rightarrow i-1 \\ i \rightarrow \circ - a \rightarrow \circ \rightarrow i \\ i+1 \rightarrow \circ \rightarrow i+1 \\ \vdots \\ n \rightarrow \circ \rightarrow n \end{pmatrix}, \quad \mathfrak{f}_i^n = \begin{pmatrix} 1 \rightarrow \circ \rightarrow 1 \\ \vdots \\ i-1 \rightarrow \circ \rightarrow i-1 \\ i \rightarrow \circ - \mathfrak{f} \begin{array}{ccc} & \begin{array}{c} \nearrow \circ \rightarrow i \\ \searrow \circ \rightarrow i+1 \end{array} & \\ \end{array} \\ i+1 \rightarrow \circ \rightarrow i+1 \\ \vdots \\ n \rightarrow \circ \rightarrow n+1 \end{pmatrix}, \quad \mathfrak{j}_i^n = \begin{pmatrix} 1 \rightarrow \circ \rightarrow 1 \\ \vdots \\ i-1 \rightarrow \circ \rightarrow i-1 \\ i \rightarrow \circ \begin{array}{ccc} & \begin{array}{c} \nearrow \circ \rightarrow 1 \\ \searrow \circ \rightarrow 2 \end{array} & \mathfrak{j} \rightarrow \circ \rightarrow i \\ i+1 \rightarrow \circ \rightarrow i+1 \\ i+2 \rightarrow \circ \rightarrow i+2 \\ \vdots \\ n+1 \rightarrow \circ \rightarrow n \end{pmatrix}.$$

Every run can be expressed as series compositions of atomic runs.

Proposition 2.15. *For every non-empty run G , there exists some $a_1 \dots a_n \in \bar{\Sigma}^+$ such that $G = a_1 \diamond \dots \diamond a_n$.*

Proof. By easy induction on the number of edges in G . \square

For instance, $\left(\begin{array}{c} \rightarrow \circ - \mathfrak{f} \begin{array}{ccc} & \begin{array}{c} \nearrow \circ - a \rightarrow \circ \\ \searrow \circ - b \rightarrow \circ - c \rightarrow \circ \end{array} & \\ \end{array} \end{array} \right) = \mathfrak{f}_1^1 \diamond a_1^2 \diamond b_2^2 \diamond c_2^2 \diamond \mathfrak{j}_1^1$. This decomposition is not

unique if the topological sort of edges of the run is not unique; for instance, $\mathfrak{f}_1^1 \diamond b_2^2 \diamond a_1^2 \diamond c_2^2 \diamond \mathfrak{j}_1^1$ and $\mathfrak{f}_1^1 \diamond b_2^2 \diamond c_2^2 \diamond a_1^2 \diamond \mathfrak{j}_1^1$ also express the same run above.

2.2.3. Left quotients of runs. For runs, we define *left quotients* w.r.t. series compositions. For runs G, H, J , we write:

$$G \longrightarrow_J H \iff J \diamond H \text{ is defined and } G = J \diamond H.$$

The *left quotient* $D_J(G)$ of a run G w.r.t. a run J is the run languages defined by:

$$D_J(G) \triangleq \{H \mid G \longrightarrow_J H\}.$$

For a run language \mathcal{G} , let $D_J(\mathcal{G}) \triangleq \bigcup_{G \in \mathcal{G}} D_J(G)$. For instance, when $J = \left(\begin{array}{ccc} & \circ & 1 \\ & \swarrow \text{f} & \searrow 1 \\ \circ & & \circ \\ 2 & \circ & \circ \rightarrow 2 \end{array} \right)$,

we have:

$$D_J \left(\begin{array}{ccc} & \circ & a \rightarrow \circ \\ & \swarrow \text{f} & \searrow 1 \\ \circ & & \circ \\ 2 & \circ & \circ \rightarrow c \rightarrow \circ \end{array} \right) = \left\{ \begin{array}{ccc} & \circ & a \rightarrow \circ \\ & & \searrow 1 \\ & & \circ \\ 2 & \circ & \circ \end{array} \right\}.$$

Let $n \in \mathbb{N}$. For a run G , the *emptiness property* $E_n(G)$ is the truth value defined by:

$$E_n(G) \triangleq \begin{cases} \text{true} & (G = 1^n) \\ \text{false} & (\text{otherwise}) \end{cases}.$$

For a run language \mathcal{G} , let $E_n(\mathcal{G}) \triangleq \bigvee_{G \in \mathcal{G}} E_n(G)$. The following is clear by definition.

Proposition 2.16. *For all runs G , we have $E_{\text{ty}_2(G)}(D_G(G))$.*

2.3. Runs on structures. For considering semantics using runs (Prop. 2.14) more usefully, we moreover introduce runs on structures. Let \mathfrak{A} be a structure. An \mathfrak{A} -run with $\langle \vec{x}, \vec{y} \rangle$ -interface is a graph homomorphism $\tau: H \rightarrow \tilde{G}(\mathfrak{A}, \vec{x}, \vec{y})$, where H is some run. We let $\text{ty}(\tau) \triangleq \langle \text{ty}_1(\tau), \text{ty}_2(\tau) \rangle \triangleq \langle \vec{x}, \vec{y} \rangle$. We use τ, σ, ρ to denote \mathfrak{A} -runs. For brevity, we depict \mathfrak{A} -runs as node-labeled graphs where each vertex is labeled with a vertex of \mathfrak{A} . For instance, let $\mathfrak{A} = \left(\begin{array}{ccc} & a & \\ \circ & \rightarrow & \circ \\ & b & \\ \circ & \leftarrow & \circ \end{array} \right)$ and we consider the following graph homomorphism τ :

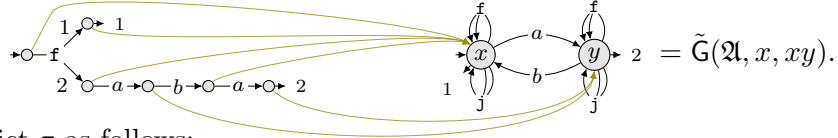

We then depict τ as follows:

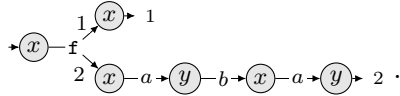

For two \mathfrak{A} -runs with $\langle \vec{x}, \vec{y} \rangle$ -interface, $\tau: H \rightarrow \tilde{G}(\mathfrak{A}, \vec{x}, \vec{y})$ and $\sigma: J \rightarrow \tilde{G}(\mathfrak{A}, \vec{x}, \vec{y})$, we say that a map $f: |H| \rightarrow |J|$ is an \mathfrak{A} -run *isomorphism* from τ to σ , written $f: \tau \cong \sigma$, if $f: H \cong J$ and for all $x \in |H|$, $\tau(x) = \sigma(f(x))$. We write $\tau \cong \sigma$ if there is some f such that $f: \tau \cong \sigma$. In the sequel, we identify two \mathfrak{A} -runs if there is an \mathfrak{A} -run isomorphism between them; we write $\tau = \sigma$ when $\tau \cong \sigma$.

For a KL term t and $x, y \in |\mathfrak{A}|$, we write $\mathcal{R}_{x,y}^{\mathfrak{A}}(t)$ for the \mathfrak{A} -run language defined by:

$$\mathcal{R}_{x,y}^{\mathfrak{A}}(t) \triangleq \{ \tau: H \rightarrow \tilde{G}(\mathfrak{A}, x, y) \mid H \in \mathcal{R}(t) \}.$$

For instance, when $\mathfrak{A} = \left(\begin{array}{ccc} & a & \\ \circ & \rightarrow & \circ \\ & b & \\ \circ & \leftarrow & \circ \end{array} \right)$, we have:

$$\mathcal{R}_{x,y}^{\mathfrak{A}}(a \cap (aba)) = \left\{ \begin{array}{ccc} & \circ & a \rightarrow \circ \\ & \swarrow \text{f} & \searrow 1 \\ \circ & & \circ \\ 2 & \circ & \circ \rightarrow b \rightarrow \circ \rightarrow a \rightarrow \circ \end{array} \right\}.$$

Using \mathfrak{A} -runs, we can rephrase Prop. 2.14 as follows.

Proposition 2.17. *Let \mathfrak{A} be a structure. For all KL term t , we have:*

$$\llbracket t \rrbracket_{\mathfrak{A}} = \left\{ \langle x, y \rangle \in |\mathfrak{A}|^2 \mid \mathcal{R}_{x,y}^{\mathfrak{A}}(t) \neq \emptyset \right\}.$$

Proof. By easy induction on t (or an easy consequence of Prop. 2.14, as $\langle x, y \rangle \in \llbracket t \rrbracket_{\mathfrak{A}}$ iff $\exists H \in \mathcal{R}(t), \exists \tau, \tau: H \rightarrow \tilde{\mathcal{G}}(\mathfrak{A}, x, y)$ iff $\mathcal{R}_{x,y}^{\mathfrak{A}}(t) \neq \emptyset$). \square

2.3.1. *Compositions on \mathfrak{A} -runs.* We recall the series composition \diamond , the parallel composition \parallel , and the identify element 1^n (Def. 2.1) for graphs with bi-interface. Similarly, we define them also for \mathfrak{A} -runs.

Definition 2.18. Let $\tau: H \rightarrow \tilde{\mathcal{G}}(\mathfrak{A}, \vec{x}, \vec{y})$ and $\sigma: J \rightarrow \tilde{\mathcal{G}}(\mathfrak{A}, \vec{x}', \vec{y}')$ be \mathfrak{A} -runs. Under $\vec{y} = \vec{x}'$, the *series composition* $\tau \diamond \sigma: (H \diamond J) \rightarrow \tilde{\mathcal{G}}(\mathfrak{A}, \vec{x}, \vec{y}')$ is defined (undefined when $\vec{y} \neq \vec{x}'$) as the map such that, for each vertex $x \in |H \diamond J|$, if x is induced from a vertex $y \in |H|$, then $(\tau \diamond \sigma)(x) = \tau(y)$, and if x is induced from a vertex $y \in |J|$, then $(\tau \diamond \sigma)(x) = \sigma(y)$. The *parallel composition* $\tau \parallel \sigma: (H \parallel J) \rightarrow \tilde{\mathcal{G}}(\mathfrak{A}, \vec{x}, \vec{y}')$ is defined as the map such that if x is induced from a vertex $y \in |H|$, then $(\tau \parallel \sigma)(x) = \tau(y)$, and if x is induced from a vertex $y \in |J|$, then $(\tau \parallel \sigma)(x) = \sigma(y)$. For each $\vec{x} = x_1 \dots x_n \in |\mathfrak{A}|^*$, let $1^{\vec{x}}: 1^n \rightarrow \tilde{\mathcal{G}}(\mathfrak{A}, \vec{x}, \vec{x})$ be the \mathfrak{A} -run such that, for each $i \in [n]$, the i -th source/target vertex maps to x_i .

Each $1^{\vec{x}}$ is the identity element w.r.t. \diamond on \mathfrak{A} -runs with $\langle \vec{x}, \vec{x} \rangle$ -interface and 1^1 is the identity element w.r.t. \parallel on \mathfrak{A} -runs with $\langle \vec{x}, \vec{y} \rangle$ -interface:

$$\tau \diamond 1^{\vec{x}} = \tau, \quad 1^{\vec{x}} \diamond \tau = \tau, \quad \tau \parallel 1^1 = 1^1, \quad 1^1 \parallel \tau = 1^1.$$

The set of *atomic \mathfrak{A} -runs* is defined as $\bar{\Sigma}_{\mathfrak{A}} \triangleq \{a_i^{\vec{z}, z'} \mid a \in \Sigma, n \geq 1, i \in [n], \vec{z} \in |\mathfrak{A}|^n, z' \in |\mathfrak{A}|, \langle z_i, z' \rangle \in \llbracket a \rrbracket_{\mathfrak{A}}\} \cup \{\mathbf{f}_i^{\vec{z}}, \mathbf{j}_i^{\vec{z}} \mid n \geq 1, i \in [n], \vec{z} \in |\mathfrak{A}|^n\}$ where $\vec{z} = z_1 \dots z_n$ and $a_i^{\vec{z}, z'} \triangleq 1^{z_1 \dots z_{i-1}} \parallel \left(\begin{array}{c} \textcircled{z_i} \xrightarrow{a} \textcircled{z'} \\ \textcircled{z_i} \end{array} \right) \parallel 1^{z_{i+1} \dots z_n}$, $\mathbf{f}_i^{\vec{z}} \triangleq 1^{z_1 \dots z_{i-1}} \parallel \left(\begin{array}{c} \textcircled{z_i} \xrightarrow{f} \textcircled{z_i} \xrightarrow{1} 1 \\ \textcircled{z_i} \xrightarrow{2} \textcircled{z_i} \xrightarrow{2} 2 \end{array} \right) \parallel 1^{z_{i+1} \dots z_n}$, and $\mathbf{j}_i^{\vec{z}} \triangleq 1^{z_1 \dots z_{i-1}} \parallel \left(\begin{array}{c} 1 \rightarrow \textcircled{z_i} \xrightarrow{1} \textcircled{z_i} \\ 2 \rightarrow \textcircled{z_i} \xrightarrow{2} \textcircled{z_i} \end{array} \right) \parallel 1^{z_{i+1} \dots z_n}$. Every \mathfrak{A} -run can be expressed as series compositions of atomic \mathfrak{A} -runs, as follows (as with Prop. 2.15).

Proposition 2.19. *Let \mathfrak{A} be a structure. For every non-empty \mathfrak{A} -run τ , there exists some $a_1 \dots a_n \in \bar{\Sigma}_{\mathfrak{A}}^+$ such that $\tau = a_1 \diamond \dots \diamond a_n$.*

Proof. By easy induction on the number of edges in τ . \square

For instance, when $\mathfrak{A} = \left(\begin{array}{c} \textcircled{b} \\ \textcircled{x} \xrightarrow{a} \textcircled{y} \\ \textcircled{x} \xrightarrow{c} \textcircled{y} \end{array} \right)$, we have $\begin{array}{c} \textcircled{x} \xrightarrow{f} \textcircled{x} \xrightarrow{1} \textcircled{x} \xrightarrow{a} \textcircled{y} \\ \textcircled{x} \xrightarrow{2} \textcircled{x} \xrightarrow{b} \textcircled{x} \xrightarrow{c} \textcircled{y} \end{array} \xrightarrow{j} \textcircled{y} = \mathbf{f}_1^x \diamond a_1^{xx,y} \diamond b_2^{yx,x} \diamond c_2^{yx,y} \diamond \mathbf{j}_1^y$. This decomposition is not unique, since $\mathbf{f}_1^x \diamond b_2^{xx,x} \diamond a_1^{xx,y} \diamond c_2^{yx,y} \diamond \mathbf{j}_1^y$ and $\mathbf{f}_1^x \diamond b_2^{xx,x} \diamond c_2^{xx,y} \diamond a_1^{xy,y} \diamond \mathbf{j}_1^y$ also express the same \mathfrak{A} -run above.

2.3.2. *Left quotients of \mathfrak{A} -runs.* Let \mathfrak{A} be a structure. Similar to Sect. 2.2.3, we define emptiness property and left quotients for \mathfrak{A} -runs. For \mathfrak{A} -runs τ, σ, ρ , we write:

$$\tau \xrightarrow{\rho}^{\mathfrak{A}} \sigma \iff \rho \diamond \sigma \text{ is defined and } \tau \cong \rho \diamond \sigma.$$

For \mathfrak{A} -runs τ and ρ , the *left quotient* $D_{\rho}^{\mathfrak{A}}(\tau)$ of τ w.r.t. ρ is the \mathfrak{A} -run language defined by:

$$D_{\rho}^{\mathfrak{A}}(\tau) \triangleq \{\sigma \text{ an } \mathfrak{A}\text{-run} \mid \tau \xrightarrow{\rho} \sigma\}.$$

For an \mathfrak{A} -run language \mathcal{G} , let $D_{\rho}^{\mathfrak{A}}(\mathcal{G}) \triangleq \bigcup_{\tau \in \mathcal{G}} D_{\rho}^{\mathfrak{A}}(\tau)$.

For instance, if $\rho = \left(\begin{array}{c} \textcircled{x} \xrightarrow{1} \textcircled{x} \xrightarrow{1} \\ \textcircled{x} \xrightarrow{2} \textcircled{x} \xrightarrow{b} \textcircled{y} \xrightarrow{2} \end{array} \right)$, we have:

$$D_\rho^{\mathfrak{A}} \left(\begin{array}{c} \textcircled{x} \xrightarrow{1} \textcircled{x} \xrightarrow{a} \textcircled{z} \xrightarrow{1} \textcircled{z} \\ \textcircled{x} \xrightarrow{2} \textcircled{x} \xrightarrow{b} \textcircled{y} \xrightarrow{c} \textcircled{z} \xrightarrow{2} \textcircled{z} \end{array} \right) = \left\{ \begin{array}{c} \textcircled{x} \xrightarrow{1} \textcircled{x} \xrightarrow{a} \textcircled{z} \xrightarrow{1} \textcircled{z} \\ \textcircled{y} \xrightarrow{2} \textcircled{y} \xrightarrow{c} \textcircled{z} \xrightarrow{2} \textcircled{z} \end{array} \right\}.$$

For an \mathfrak{A} -run τ and $\vec{z} \in |\mathfrak{A}|^*$, the *emptiness property* $E_{\vec{z}}(\tau)$ is the truth value defined by:

$$E_{\vec{z}}(\tau) \triangleq \begin{cases} \text{true} & (\tau = 1^{\vec{z}}) \\ \text{false} & (\text{otherwise}) \end{cases}.$$

For an \mathfrak{A} -run language \mathcal{G} , let $E_{\vec{z}}(\mathcal{G}) \triangleq \bigvee_{\tau \in \mathcal{G}} E_{\vec{z}}(\tau)$. The following is clear by definition.

Proposition 2.20. *Let \mathfrak{A} be a structure. For all \mathfrak{A} -runs τ , we have $E_{\text{ty}_2(\tau)}(D_\tau^{\mathfrak{A}})$.*

We will define derivatives based on these left quotient and emptiness property.

3. LABELED KLEENE LATTICE TERMS

To present derivatives (which will be used for an automata construction for PCoR*), we consider simulating left quotients of \mathfrak{A} -runs (Sect. 2.3.2) by terms. To this end, we extend terms with “labels”. In a nutshell, labels are used for expressing runs with *multiple* source vertices.

Let L be a set of *labels*. We use x, y, z to denote labels. The set of *labeled Kleene lattice terms* (IKL terms) is defined by the following grammar:

$$\tilde{t}, \tilde{s}, \tilde{u} \in \tilde{\mathbf{T}}_L ::= @x.t \mid \tilde{t};_1 s \mid \tilde{t} \cap_1 \tilde{s} \quad (x \in L \text{ and } t, s \text{ are KL terms})$$

Each label x indicates the vertex x on a structure (if exists). The notation $@x.t$ is inspired by the jump operator in hybrid logics [AtC07] (a minor difference is that x directly indicates a vertex name, here). We write $\text{lab}_i(\tilde{t})$ for the i -th label occurring in \tilde{t} and we write $\overrightarrow{\text{lab}}(\tilde{t})$ for the sequence $\text{lab}_1(\tilde{t}) \dots \text{lab}_n(\tilde{t})$ where n is the number of labels occurring in \tilde{t} . For instance, if $\tilde{t} = ((@x.\tilde{s}_1) \cap_1 (((@x.\tilde{s}_2) \cap_1 (@y.\tilde{s}_3));_1 u_1));_1 u_2$, then $\text{lab}_1(\tilde{t}) = x$, $\text{lab}_2(\tilde{t}) = x$, $\text{lab}_3(\tilde{t}) = y$, and $\overrightarrow{\text{lab}}(\tilde{t}) = xxy$.

3.1. Semantics: relational models. For an IKL term \tilde{t} , the *semantics* $\llbracket \tilde{t} \rrbracket_{\mathfrak{A}} \subseteq |\mathfrak{A}|$ is a unary relation defined as follows:

$$\llbracket @x.t \rrbracket_{\mathfrak{A}} \triangleq \{y \mid \langle x, y \rangle \in \llbracket t \rrbracket_{\mathfrak{A}}\}, \llbracket \tilde{t};_1 s \rrbracket_{\mathfrak{A}} \triangleq \{z \mid y \in \llbracket \tilde{t} \rrbracket_{\mathfrak{A}}, \langle y, z \rangle \in \llbracket s \rrbracket_{\mathfrak{A}}\}, \llbracket \tilde{t} \cap_1 \tilde{s} \rrbracket_{\mathfrak{A}} \triangleq \llbracket \tilde{t} \rrbracket_{\mathfrak{A}} \cap \llbracket \tilde{s} \rrbracket_{\mathfrak{A}}.$$

Note that $\llbracket @x.t \rrbracket_{\mathfrak{A}} = \emptyset$ when $x \notin |\mathfrak{A}|$. For $\mathcal{C} \subseteq \text{REL}$, we write $\mathcal{C} \models \tilde{t} = \tilde{s}$ if $\llbracket \tilde{t} \rrbracket_{\mathfrak{A}} = \llbracket \tilde{s} \rrbracket_{\mathfrak{A}}$ for $\mathfrak{A} \in \mathcal{C}$.

Proposition 3.1. *Let t and s be KL terms and x be a label. We then have:*

$$\text{REL} \models t \leq s \quad \Leftrightarrow \quad \text{REL} \models @x.t \leq @x.s.$$

Proof. (\Rightarrow): Trivial. (\Leftarrow): Let $\langle y, z \rangle \in \llbracket t \rrbracket_{\mathfrak{A}}$. Let f and \mathfrak{B} be s.t. $f: \mathfrak{A} \cong \mathfrak{B}$ and $f(y) = x$. We then have: $\langle y, z \rangle \in \llbracket t \rrbracket_{\mathfrak{A}} \Leftrightarrow \langle x, f(z) \rangle \in \llbracket t \rrbracket_{\mathfrak{B}} \Leftrightarrow f(z) \in \llbracket @x.t \rrbracket_{\mathfrak{B}} \Rightarrow f(z) \in \llbracket @x.s \rrbracket_{\mathfrak{B}} \Leftrightarrow \langle x, f(z) \rangle \in \llbracket s \rrbracket_{\mathfrak{B}} \Leftrightarrow \langle y, z \rangle \in \llbracket s \rrbracket_{\mathfrak{A}}$. \square

Note that for labeled KL terms \tilde{t} , $\llbracket \tilde{t} \rrbracket_{\mathfrak{A}}$ and $\llbracket \tilde{t} \rrbracket_{\mathfrak{B}}$ may not be equal even if $\mathfrak{A} \cong \mathfrak{B}$, because we use the names of vertices in the semantics (cf. nominals in hybrid logic [AtC07]). For that reason, for structures, we distinguish two structures even if they are isomorphic, cf. we identify two graphs/runs/ \mathfrak{A} -runs if they are isomorphic.

3.2. Runs on structures. We use the following notation: $X \heartsuit Y \triangleq \{\tau \heartsuit \sigma \mid \tau \in X \wedge \sigma \in Y\}$ where X and Y are sets of runs or sets of \mathfrak{A} -runs and $\heartsuit \in \{\diamond, \parallel\}$. In this set notation, we use terms as a singleton set: for instance, $\{\tau, \sigma\} \diamond \rho = \{\tau \diamond \rho, \sigma \diamond \rho\}$.

Definition 3.2. Let \mathfrak{A} be a structure. For an IKL term \tilde{t} and $z \in |\mathfrak{A}|$, the \mathfrak{A} -run language $\mathcal{R}_z^{\mathfrak{A}}(\tilde{t})$ is defined as follows:

$$\mathcal{R}_z^{\mathfrak{A}}(@x.t) \triangleq \mathcal{R}_{x,z}^{\mathfrak{A}}(t), \quad \mathcal{R}_z^{\mathfrak{A}}(\tilde{t};_1 s) \triangleq \bigcup_{y \in |\mathfrak{A}|} \mathcal{R}_y^{\mathfrak{A}}(\tilde{t}) \diamond \mathcal{R}_{y,z}^{\mathfrak{A}}(s), \quad \mathcal{R}_z^{\mathfrak{A}}(\tilde{t} \cap_1 \tilde{s}) \triangleq (\mathcal{R}_z^{\mathfrak{A}}(\tilde{t}) \parallel \mathcal{R}_z^{\mathfrak{A}}(\tilde{s})) \diamond \mathbf{j}_1^z.$$

Proposition 3.3 (cf. Prop. 2.17). *Let \mathfrak{A} be a structure. For all IKL term \tilde{t} , we have:*

$$\llbracket \tilde{t} \rrbracket_{\mathfrak{A}} = \left\{ z \in |\mathfrak{A}| \mid \mathcal{R}_z^{\mathfrak{A}}(\tilde{t}) \neq \emptyset \right\}.$$

Proof. By easy induction on \tilde{t} using Prop. 2.17. □

4. DERIVATIVES ON GRAPHS

We recall the left quotients of \mathfrak{A} -runs (defined in Sect. 2.3.2). In this section, we now define derivatives on \mathfrak{A} , which can simulate the left quotients.

Definition 4.1. For a label z and an IKL term \tilde{t} , the truth value $E_z(\tilde{t}) \in \{\text{false}, \text{true}\}$ is defined as follows:

$$\begin{aligned} E_z(@x.a) &\triangleq E_z(@x.0) \triangleq E_z(@x.s \cap u) \triangleq E_z(\tilde{s} \cap_1 \tilde{u}) \triangleq \text{false}, \\ E_z(@x.1) &\triangleq E_z(@x.s^*) \triangleq \begin{cases} \text{true} & (x = z) \\ \text{false} & (x \neq z) \end{cases}, \quad E_z(\tilde{s};_1 u) \triangleq E_z(\tilde{s}) \wedge E_z(@z.u), \\ E_z(@x.s; u) &\triangleq E_z(@x.s) \wedge E_z(@z.u), \quad E_z(@x.s + u) \triangleq E_z(@x.s) \vee E_z(@x.u). \end{aligned}$$

For a label z and a set \tilde{T} of IKL terms, let $E_z(\tilde{T}) \triangleq \bigvee_{\tilde{t} \in \tilde{T}} E_z(\tilde{t})$. This E (Def. 4.1) can simulate the emptiness property E (in Sect. 2.2.3) as follows.

Lemma 4.2. *Let \mathfrak{A} be a structure. For all $z \in |\mathfrak{A}|$ and IKL terms \tilde{t} , $E_z(\mathcal{R}_z^{\mathfrak{A}}(\tilde{t})) \Leftrightarrow E_z(\tilde{t})$.*

Proof. By easy induction on \tilde{t} .

- Case $\tilde{t} = @x.a, @x.0, @x.s \cap u, \tilde{s} \cap_1 \tilde{u}$: By $E_z(\mathcal{R}_z^{\mathfrak{A}}(\tilde{t})) \Leftrightarrow \text{false}$.
- Case $\tilde{t} = @x.1, @x.s^*$: By $E_z(\mathcal{R}_z^{\mathfrak{A}}(\tilde{t})) \Leftrightarrow \begin{cases} \text{true} & (x = z) \\ \text{false} & (x \neq z) \end{cases}$.
- Case $\tilde{t} = @x.s + u$: We have:

$$\begin{aligned} E_z(\mathcal{R}_z^{\mathfrak{A}}(@x.s + u)) &\Leftrightarrow E_z(\mathcal{R}_z^{\mathfrak{A}}(@x.s) \cup \mathcal{R}_z^{\mathfrak{A}}(@z.u)) \\ &\Leftrightarrow E_z(\mathcal{R}_z^{\mathfrak{A}}(@x.s)) \vee E_z(\mathcal{R}_z^{\mathfrak{A}}(@z.u)) \\ &\Leftrightarrow E_z(@x.s) \vee E_z(@z.u) \Leftrightarrow E_z(@x.s + u). \end{aligned} \quad (\text{IH})$$

- Case $\tilde{t} = @x.s ; u$: Similar to the above, we have:

$$\begin{aligned}
E_z(\mathcal{R}_z^{\mathfrak{A}}(@x.s ; u)) &\Leftrightarrow E_z\left(\bigcup_{y \in |\mathfrak{A}|} \mathcal{R}_y^{\mathfrak{A}}(@x.s) \diamond \mathcal{R}_z^{\mathfrak{A}}(@y.u)\right) && \text{(By Defs. 3.2 and 2.13)} \\
&\Leftrightarrow E_z(\mathcal{R}_z^{\mathfrak{A}}(@x.s)) \wedge E_z(\mathcal{R}_z^{\mathfrak{A}}(@z.u)) \\
&\Leftrightarrow E_z(@x.s) \wedge E_z(@z.u) \Leftrightarrow E_z(@x.s ; u). && \text{(IH)}
\end{aligned}$$

- Case $\tilde{t} = \tilde{s} ;_1 u$: We have:

$$\begin{aligned}
E_z(\mathcal{R}_z^{\mathfrak{A}}(\tilde{s} ;_1 u)) &\Leftrightarrow E_z\left(\bigcup_{y \in |\mathfrak{A}|} \mathcal{R}_y^{\mathfrak{A}}(\tilde{s}) \diamond \mathcal{R}_z^{\mathfrak{A}}(@y.u)\right) && \text{(By Defs. 3.2 and 2.13)} \\
&\Leftrightarrow E_z(\mathcal{R}_z^{\mathfrak{A}}(\tilde{s})) \wedge E_z(\mathcal{R}_z^{\mathfrak{A}}(@z.u)) \\
&\Leftrightarrow E_z(\tilde{s}) \wedge E_z(@z.u) \Leftrightarrow E_z(\tilde{s} ;_1 u). && \text{(IH)}
\end{aligned}$$

Hence, this completes the proof. \square

Definition 4.3. Let \mathfrak{A} be a structure. The *derivative* relation $\tilde{t} \longrightarrow_{\rho}^{\mathfrak{A}} \tilde{s}$, where \tilde{t} and \tilde{s} are IKL terms and ρ is an \mathfrak{A} -run, is defined as the minimal relation closed under the rules:

$$\begin{array}{c}
\frac{\langle x, y \rangle \in \llbracket a \rrbracket_{\mathfrak{A}}}{@x.a \longrightarrow_{a_1^{x,y}}^{\mathfrak{A}} @y.1} \text{ for } a \in \Sigma \quad \frac{@x.t \longrightarrow_{\rho}^{\mathfrak{A}} \tilde{t}'}{@x.t ; s \longrightarrow_{\rho}^{\mathfrak{A}} \tilde{t}' ; s} \quad \frac{E_z(@x.t) \quad @z.s \longrightarrow_{\rho}^{\mathfrak{A}} \tilde{s}'}{@x.t ; s \longrightarrow_{\rho}^{\mathfrak{A}} \tilde{s}'} \\
\frac{@x.t \longrightarrow_{\rho}^{\mathfrak{A}} \tilde{t}' \quad @x.s \longrightarrow_{\rho}^{\mathfrak{A}} \tilde{s}'}{@x.t + s \longrightarrow_{\rho}^{\mathfrak{A}} \tilde{t}' + \tilde{s}'} \quad \frac{\tilde{t} \longrightarrow_{\rho}^{\mathfrak{A}} \tilde{t}' \quad @z.s \longrightarrow_{\rho}^{\mathfrak{A}} \tilde{s}'}{\tilde{t} ;_1 s \longrightarrow_{\rho}^{\mathfrak{A}} \tilde{t}' ;_1 \tilde{s}'} \quad \frac{E_z(\tilde{t}) \quad @z.s \longrightarrow_{\rho}^{\mathfrak{A}} \tilde{s}'}{\tilde{t} ;_1 s \longrightarrow_{\rho}^{\mathfrak{A}} \tilde{s}'} \\
\frac{@x.t \longrightarrow_{\rho}^{\mathfrak{A}} \tilde{t}'}{@x.t^* \longrightarrow_{\rho}^{\mathfrak{A}} \tilde{t}' ; t^*} \quad \frac{@x.t \cap s \longrightarrow_{\tilde{t}}^{\mathfrak{A}} (@x.t) \cap_1 (@x.s)}{\tilde{t} \cap_1 \tilde{s} \longrightarrow_{\tilde{t}}^{\mathfrak{A}} @z.1} \quad \frac{E_z(\tilde{t}) \quad E_z(\tilde{s})}{\tilde{t} \cap_1 \tilde{s} \longrightarrow_{\tilde{t}}^{\mathfrak{A}} @z.1} \\
\frac{\tilde{t} \longrightarrow_{\rho}^{\mathfrak{A}} \tilde{t}' \quad \tilde{s} \longrightarrow_{\rho}^{\mathfrak{A}} \tilde{s}'}{\tilde{t} \cap_1 \tilde{s} \longrightarrow_{\rho \parallel \vec{1}^{\text{ab}}(\tilde{s})}^{\mathfrak{A}} \tilde{t}' \cap_1 \tilde{s}'} \quad \frac{\tilde{t} \longrightarrow_{\rho}^{\mathfrak{A}} \tilde{t}' \quad \tilde{s} \longrightarrow_{\rho}^{\mathfrak{A}} \tilde{s}'}{\tilde{t} \cap_1 \tilde{s} \longrightarrow_{\vec{1}^{\text{ab}}(\tilde{t}) \parallel \rho}^{\mathfrak{A}} \tilde{t}' \cap_1 \tilde{s}'} \quad \frac{\tilde{t} \longrightarrow_{\rho}^{\mathfrak{A}} \tilde{t}'}{\tilde{t} \longrightarrow_{\vec{1}^{\text{ab}}(\tilde{t})}^{\mathfrak{A}} \tilde{t}'} \quad \text{R} \quad \frac{\tilde{t} \longrightarrow_{\rho}^{\mathfrak{A}} \tilde{u} \quad \tilde{u} \longrightarrow_{\rho'}^{\mathfrak{A}} \tilde{s}}{\tilde{t} \longrightarrow_{\rho \circ \rho'}^{\mathfrak{A}} \tilde{s}} \quad \text{T}
\end{array}$$

Let \mathfrak{A} be a structure and ρ be an \mathfrak{A} -run. For an IKL term \tilde{t} (resp. a set \tilde{T} of IKL terms), we define the derivative of \tilde{t} (resp. \tilde{T}) w.r.t. ρ as follows:

$$D_{\rho}^{\mathfrak{A}}(\tilde{t}) \triangleq \{ \tilde{s} \text{ an IKL term} \mid \tilde{t} \longrightarrow_{\rho}^{\mathfrak{A}} \tilde{s} \}, \quad D_{\rho}^{\mathfrak{A}}(\tilde{T}) \triangleq \bigcup_{\tilde{t} \in \tilde{T}} D_{\rho}^{\mathfrak{A}}(\tilde{t}).$$

For notational simplicity, we use the following notation: $A \heartsuit B \triangleq \{ a \heartsuit b \mid a \in A \wedge b \in B \}$ where A and B are sets of IKL terms and $\heartsuit \in \{ ;_1, \cap_1 \}$. In this notation, we use terms as a singleton set: for instance, $\{ a, b \} \cap_1 c = \{ a \cap_1 c, b \cap_1 c \}$. Using this notation, for atomic \mathfrak{A} -runs, Def. 4.3 can be alternatively expressed as follows (cf. Antimirov's derivatives [Ant96]).

Proposition 4.4. *Let \mathfrak{A} be a structure. For an atomic \mathfrak{A} -run ρ and an IKL term \tilde{t} , we have the following:*

$$\begin{aligned}
D_\rho^{\mathfrak{A}}(@x.a) &= \begin{cases} \{ @y.1 \mid \langle x, y \rangle \in \llbracket a \rrbracket_{\mathfrak{A}} \} & (\rho = a_1^{x,y}) \\ \emptyset & (\text{otherwise}) \end{cases} \text{ for } a \in \Sigma, \\
D_\rho^{\mathfrak{A}}(@x.1) &= D_\rho^{\mathfrak{A}}(@x.0) = \emptyset, \\
D_\rho^{\mathfrak{A}}(@x.s; u) &= (D_\rho^{\mathfrak{A}}(@x.s);_1 u) \cup D_\rho^{\mathfrak{A}}(\{ @z.u \mid z \in |\mathfrak{A}| \wedge E_z(@x.s) \}), \\
D_\rho^{\mathfrak{A}}(@x.s + u) &= D_\rho^{\mathfrak{A}}(@x.s) \cup D_\rho^{\mathfrak{A}}(@x.u), \\
D_\rho^{\mathfrak{A}}(@x.s^*) &= D_\rho^{\mathfrak{A}}(@x.s);_1 s^*, \\
D_\rho^{\mathfrak{A}}(@x.s \cap u) &= \begin{cases} \{ (@x.s) \cap_1 (@x.u) \} & (\rho = \mathbf{f}_1^x) \\ \emptyset & (\text{otherwise}) \end{cases}, \\
D_\rho^{\mathfrak{A}}(\tilde{s};_1 u) &= (D_\rho^{\mathfrak{A}}(\tilde{s});_1 u) \cup D_\rho^{\mathfrak{A}}(\{ @z.u \mid z \in |\mathfrak{A}| \wedge E_z(\tilde{s}) \}), \\
D_\rho^{\mathfrak{A}}(\tilde{s} \cap_1 \tilde{u}) &= \begin{cases} D_{\rho'}^{\mathfrak{A}}(\tilde{s}) \cap_1 \tilde{u} & (\rho = (\rho' \parallel \mathbf{1}^{\overrightarrow{\text{lab}}(\tilde{u})}) \text{ for some } \rho') \\ \tilde{s} \cap_1 D_{\rho'}^{\mathfrak{A}}(\tilde{u}) & (\rho = (\mathbf{1}^{\overrightarrow{\text{lab}}(\tilde{s})} \parallel \rho') \text{ for some } \rho') \\ \bigcup_{z \in |\mathfrak{A}|} \{ @z.1 \mid E_z(\tilde{s}) \wedge E_z(\tilde{u}) \} & (\rho = \mathbf{j}_1^z) \\ \emptyset & (\text{otherwise}) \end{cases}.
\end{aligned}$$

Proof. By a routine verification. \square

We then have that the derivatives can simulate left quotients of \mathfrak{A} -runs, as follows. See Sect. 4.1, for a detailed proof.

Lemma 4.5. *Let \mathfrak{A} be a structure and $z \in |\mathfrak{A}|$. For all IKL terms \tilde{t} and \mathfrak{A} -runs ρ , we have:*

$$D_\rho^{\mathfrak{A}}(\mathcal{R}_z^{\mathfrak{A}}(\tilde{t})) = \mathcal{R}_z^{\mathfrak{A}}(D_\rho^{\mathfrak{A}}(\tilde{t})).$$

Example 4.6 (cf. Sect. 2.3.2). Let $\mathfrak{A} = \left(\begin{array}{c} \textcircled{x} \xleftarrow{b} \textcircled{y} \\ \textcircled{x} \xrightarrow{a} \textcircled{y} \end{array} \right)$, $\tilde{t} = @x.(a((ba) \cap 1)b) \cap 1$, $\rho =$

$$\left(\begin{array}{c} \textcircled{x} \xrightarrow{1} \textcircled{x} \xrightarrow{a} \textcircled{y} \rightarrow 1 \\ \textcircled{x} \xrightarrow{\tilde{t}} \textcircled{x} \xrightarrow{2} \textcircled{x} \rightarrow 2 \end{array} \right), \text{ and } \rho' = \left(\begin{array}{c} \textcircled{y} \xrightarrow{1} \textcircled{y} \xrightarrow{b} \textcircled{x} \xrightarrow{a} \textcircled{y} \\ \textcircled{y} \xrightarrow{2} \textcircled{y} \xrightarrow{2} \textcircled{y} \xrightarrow{j} \textcircled{y} \xrightarrow{b} \textcircled{x} \xrightarrow{1} \textcircled{x} \rightarrow 2 \\ \textcircled{x} \xrightarrow{2} \textcircled{x} \xrightarrow{2} \textcircled{x} \xrightarrow{j} \textcircled{x} \xrightarrow{2} \textcircled{x} \rightarrow 2 \end{array} \right). \text{ We can}$$

see $\rho' \in D_\rho(\mathcal{R}_x^{\mathfrak{A}}(\tilde{t}))$ by $\rho \diamond \rho' \in \mathcal{R}_x^{\mathfrak{A}}(\tilde{t})$. We also have $\rho' \in \mathcal{R}_x^{\mathfrak{A}}(D_\rho(\tilde{t}))$, because by letting $\tilde{t}' = (@y.((ba) \cap 1)b) \cap_1 @x.1$, we have $\rho' \in \mathcal{R}^{\mathfrak{A}}(\tilde{t}')$ and $\tilde{t}' \in D_\rho(\tilde{t})$. Here, $\tilde{t}' \in D_\rho(\tilde{t})$ is shown as follows:

$$\begin{aligned}
\tilde{t} &= @x.(a((ba) \cap 1)b) \cap 1 \xrightarrow{\mathfrak{A}} \begin{pmatrix} \textcircled{x} \xrightarrow{1} \textcircled{x} \xrightarrow{a} \textcircled{y} \rightarrow 1 \\ \textcircled{x} \xrightarrow{\tilde{t}} \textcircled{x} \xrightarrow{2} \textcircled{x} \rightarrow 2 \end{pmatrix} \quad (@x.a((ba) \cap 1)b) \cap_1 @x.1 \\
&\xrightarrow{\mathfrak{A}} \begin{pmatrix} \textcircled{1} \rightarrow \textcircled{x} \xrightarrow{a} \textcircled{y} \rightarrow 1 \\ \textcircled{2} \rightarrow \textcircled{x} \rightarrow 2 \end{pmatrix} \quad (@y.((ba) \cap 1)b) \cap_1 @x.1 = \tilde{t}'.
\end{aligned}$$

Similar to the above, for an IKL term \tilde{t} and a set \tilde{T} of IKL terms, we let:

$$(\longrightarrow^{\mathfrak{A}}) \triangleq \bigcup_{\rho \text{ an } \mathfrak{A}\text{-run}} (\longrightarrow_{\rho}^{\mathfrak{A}}), \quad D^{\mathfrak{A}}(\tilde{t}) \triangleq \{ \tilde{s} \mid \tilde{t} \longrightarrow^{\mathfrak{A}} \tilde{s} \}, \quad D^{\mathfrak{A}}(\tilde{T}) \triangleq \bigcup_{\tilde{t} \in \tilde{T}} D^{\mathfrak{A}}(\tilde{t}).$$

By Lems. 4.2 and 4.5, derivatives can give an alternative semantics, as follows.

Theorem 4.7. *Let \mathfrak{A} be a structure and let \tilde{t} be an IKL term. We have:*

$$\llbracket \tilde{t} \rrbracket_{\mathfrak{A}} = \{z \in |\mathfrak{A}| \mid E_z(D^{\mathfrak{A}}(\tilde{t}))\}.$$

Proof. We have:

$$\begin{aligned} z \in \llbracket \tilde{t} \rrbracket_{\mathfrak{A}} &\Leftrightarrow \mathcal{R}_z^{\mathfrak{A}}(\tilde{t}) \neq \emptyset && \text{(Prop. 3.3)} \\ &\Leftrightarrow E_z(D_{\rho}^{\mathfrak{A}}(\mathcal{R}_z^{\mathfrak{A}}(\tilde{t}))) \text{ for some } \mathfrak{A}\text{-run } \rho && \text{(Prop. 2.20)} \\ &\Leftrightarrow E_z(D_{\rho}^{\mathfrak{A}}(\tilde{t})) \text{ for some } \mathfrak{A}\text{-run } \rho && \text{(Lems. 4.2 and 4.5)} \\ &\Leftrightarrow E_z(D^{\mathfrak{A}}(\tilde{t})). && \text{(By } D^{\mathfrak{A}}(\tilde{t}) = \bigcup_{\rho} \text{ an } \mathfrak{A}\text{-run } D_{\rho}^{\mathfrak{A}}(\tilde{t})) \end{aligned}$$

Hence this completes the proof. \square

4.1. Proof on Lem. 4.5: derivatives can simulate left quotients. We first prepare the following proposition.

Proposition 4.8. *Let ρ be an atomic \mathfrak{A} -run. For \vec{x}, \vec{y} , we use $X_{\vec{x}, \vec{y}}, Y_{\vec{x}, \vec{y}}$ to denote sets of \mathfrak{A} -runs with $\langle \vec{x}, \vec{y} \rangle$ -interface. We then have the following.*

$$\begin{aligned} (\diamond) : D_{\rho}^{\mathfrak{A}}(X_{\vec{x}, \vec{y}} \diamond Y_{\vec{y}, \vec{z}}) &= \begin{cases} (D_{\rho}^{\mathfrak{A}}(X_{\vec{x}, \vec{y}}) \diamond Y_{\vec{y}, \vec{z}}) \cup D_{\rho}^{\mathfrak{A}}(Y_{\vec{y}, \vec{z}}) & (E_y(X_{\vec{x}, \vec{y}})) \\ (D_{\rho}^{\mathfrak{A}}(X_{\vec{x}, \vec{y}}) \diamond Y_{\vec{y}, \vec{z}}) & (\text{otherwise}) \end{cases}; \\ (||) : D_{\rho}^{\mathfrak{A}}(X_{\vec{x}_1, \vec{z}_1} || Y_{\vec{x}_2, \vec{z}_2}) &= \begin{cases} D_{\rho'}^{\mathfrak{A}}(X_{\vec{x}_1, \vec{z}_1}) || Y_{\vec{x}_2, \vec{z}_2} & (\rho = (\rho' || \mathbf{1}^{\vec{\text{lab}}(\vec{x}_2)}) \text{ for some } \rho') \\ X_{\vec{x}_1, \vec{z}_1} || D_{\rho'}^{\mathfrak{A}}(Y_{\vec{x}_2, \vec{z}_2}) & (\rho = (\mathbf{1}^{\vec{\text{lab}}(\vec{x}_1)} || \rho') \text{ for some } \rho') \\ \emptyset & (\text{otherwise}) \end{cases}. \end{aligned}$$

Proof. For (\diamond) : Because for all τ, σ, ρ_1 s.t. $\text{ty}_2(\tau) = \text{ty}_1(\sigma) = y$, we have

$$\tau \diamond \sigma \longrightarrow_{\rho}^{\mathfrak{A}} \rho_1 \Leftrightarrow \bigvee \begin{cases} \exists \tau', \tau \longrightarrow_{\rho}^{\mathfrak{A}} \tau' \wedge \rho_1 = \tau' \diamond \sigma \\ E_y(\tau) \wedge (\exists \sigma', \sigma \longrightarrow_{\rho}^{\mathfrak{A}} \sigma' \wedge \rho_1 = \sigma') \end{cases}.$$

For $(||)$: Because for all τ, σ, ρ_1 , we have

$$\tau || \sigma \longrightarrow_{\rho}^{\mathfrak{A}} \rho_1 \Leftrightarrow \bigvee \begin{cases} \exists \tau', \rho', \tau \longrightarrow_{\rho'}^{\mathfrak{A}} \tau' \wedge \rho_1 = (\tau' || \sigma) \wedge \rho = (\rho' || \mathbf{1}^{\text{ty}_1(\sigma)}) \\ \exists \sigma', \rho', \sigma \longrightarrow_{\rho'}^{\mathfrak{A}} \sigma' \wedge \rho_1 = (\tau || \sigma') \wedge \rho = (\mathbf{1}^{\text{ty}_1(\tau)} || \rho') \end{cases}. \quad \square$$

We first show Lem. 4.5 for atomic \mathfrak{A} -runs, and then we extend for \mathfrak{A} -runs.

Lemma 4.9. *Let \mathfrak{A} be a structure and $z \in |\mathfrak{A}|$. For all IKL terms \tilde{t} and atomic \mathfrak{A} -runs ρ ,*

$$D_{\rho}^{\mathfrak{A}}(\mathcal{R}_z^{\mathfrak{A}}(\tilde{t})) = \mathcal{R}_z^{\mathfrak{A}}(D_{\rho}^{\mathfrak{A}}(\tilde{t})).$$

Proof. By easy induction on \tilde{t} using Prop. 4.8.

• Case $\tilde{t} = @x.a$ for $a \in \Sigma$: We have:

$$\begin{aligned} D_{\rho}^{\mathfrak{A}}(\mathcal{R}_z^{\mathfrak{A}}(@x.a)) &= D_{\rho}^{\mathfrak{A}}(\{a_1^{x,z} \mid \langle x, z \rangle \in \llbracket a \rrbracket_{\mathfrak{A}}\}) \\ &= \begin{cases} \mathcal{R}_z^{\mathfrak{A}}(\{@z.1 \mid \langle x, z \rangle \in \llbracket a \rrbracket_{\mathfrak{A}}\}) & (\rho = a_1^{x,z}) \\ \emptyset & (\text{otherwise}) \end{cases} = \mathcal{R}_z^{\mathfrak{A}}(D_{\rho}^{\mathfrak{A}}(@x.a)). \end{aligned}$$

• Case $\tilde{t} = @x.1, @x.0$: We have: $D_{\rho}^{\mathfrak{A}}(\mathcal{R}_z^{\mathfrak{A}}(\tilde{t})) = \emptyset = \mathcal{R}_z^{\mathfrak{A}}(D_{\rho}^{\mathfrak{A}}(\tilde{t}))$.

- Case $\tilde{t} = @x.s ; u$: We have:

$$\begin{aligned}
D_\rho^{\mathfrak{A}}(\mathcal{R}_z^{\mathfrak{A}}(@x.s ; u)) &= \bigcup_{y \in |\mathfrak{A}|} D_\rho^{\mathfrak{A}}(\mathcal{R}_y^{\mathfrak{A}}(@x.s) \diamond \mathcal{R}_{y,z}^{\mathfrak{A}}(u)) \\
&= \left(\bigcup_{y \in |\mathfrak{A}|} D_\rho^{\mathfrak{A}}(\mathcal{R}_y^{\mathfrak{A}}(@x.s)) \diamond \mathcal{R}_{y,z}^{\mathfrak{A}}(u) \right) \cup \bigcup_{y \in |\mathfrak{A}|; E_y(\mathcal{R}_y^{\mathfrak{A}}(@x.s))} D_\rho^{\mathfrak{A}}(\mathcal{R}_z^{\mathfrak{A}}(@y.u)) \quad (\text{Prop. 4.8 } (\diamond)) \\
&= \left(\bigcup_{y \in |\mathfrak{A}|} \mathcal{R}_y^{\mathfrak{A}}(D_\rho^{\mathfrak{A}}(@x.s)) \diamond \mathcal{R}_{y,z}^{\mathfrak{A}}(u) \right) \cup \bigcup_{y \in |\mathfrak{A}|; E_y(@x.s)} \mathcal{R}_z^{\mathfrak{A}}(D_\rho^{\mathfrak{A}}(@y.u)) \quad (\text{Lem. 4.2, IH}) \\
&= \mathcal{R}_z^{\mathfrak{A}} \left((D_\rho^{\mathfrak{A}}(@x.s) ;_1 u) \cup \bigcup_{y \in |\mathfrak{A}|; E_y(@x.s)} D_\rho^{\mathfrak{A}}(@y.u) \right) = \mathcal{R}_z^{\mathfrak{A}}(D_\rho^{\mathfrak{A}}(@x.s ; u)). \quad (\text{By Def. 3.2})
\end{aligned}$$

- Case $\tilde{t} = @x.s + u$: We have:

$$\begin{aligned}
D_\rho^{\mathfrak{A}}(\mathcal{R}_z^{\mathfrak{A}}(@x.s + u)) &= D_\rho^{\mathfrak{A}}(\mathcal{R}_z^{\mathfrak{A}}(@x.s)) \cup D_\rho^{\mathfrak{A}}(\mathcal{R}_z^{\mathfrak{A}}(@x.u)) \\
&= \mathcal{R}_z^{\mathfrak{A}}(D_\rho^{\mathfrak{A}}(@x.s)) \cup \mathcal{R}_z^{\mathfrak{A}}(D_\rho^{\mathfrak{A}}(@x.u)) = \mathcal{R}_z^{\mathfrak{A}}(D_\rho^{\mathfrak{A}}(@x.s + u)). \quad (\text{IH})
\end{aligned}$$

- Case $\tilde{t} = @x.s^*$: We have:

$$\begin{aligned}
D_\rho^{\mathfrak{A}}(\mathcal{R}_z^{\mathfrak{A}}(@x.s^*)) &= D_\rho^{\mathfrak{A}} \left(\bigcup_{y \in |\mathfrak{A}|} \{ \tau \in \mathcal{R}_y^{\mathfrak{A}}(@x.s) \mid \neg E_y(\tau) \} \diamond \mathcal{R}_{y,z}^{\mathfrak{A}}(s^*) \right) \\
&= \bigcup_{y \in |\mathfrak{A}|} D_\rho^{\mathfrak{A}}(\{ \tau \in \mathcal{R}_y^{\mathfrak{A}}(@x.s) \mid \neg E_y(\tau) \}) \diamond \mathcal{R}_{y,z}^{\mathfrak{A}}(s^*) \quad (\text{Prop. 4.8 } (\diamond)) \\
&= \bigcup_{y \in |\mathfrak{A}|} D_\rho^{\mathfrak{A}}(\mathcal{R}_y^{\mathfrak{A}}(@x.s)) \diamond \mathcal{R}_{y,z}^{\mathfrak{A}}(s^*) \quad (\text{Because } \rho \text{ is not empty}) \\
&= \bigcup_{y \in |\mathfrak{A}|} \mathcal{R}_y^{\mathfrak{A}}(D_\rho^{\mathfrak{A}}(@x.s)) \diamond \mathcal{R}_{y,z}^{\mathfrak{A}}(s^*) \quad (\text{IH}) \\
&= \mathcal{R}_z^{\mathfrak{A}}(D_\rho^{\mathfrak{A}}(@x.s) ;_1 s^*) = \mathcal{R}_z^{\mathfrak{A}}(D_\rho^{\mathfrak{A}}(@x.s^*)). \quad (\text{By Def. 3.2})
\end{aligned}$$

- Case $\tilde{t} = @x.s \cap u$: We have:

$$\begin{aligned}
D_\rho^{\mathfrak{A}}(\mathcal{R}_z^{\mathfrak{A}}(@x.s \cap u)) &= D_\rho^{\mathfrak{A}}(\mathbf{f}_1^x \diamond (\mathcal{R}_z^{\mathfrak{A}}(@x.s) \parallel \mathcal{R}_z^{\mathfrak{A}}(@x.u)) \diamond \mathbf{j}_1^z) \\
&= \begin{cases} (\mathcal{R}_z^{\mathfrak{A}}(@x.s) \parallel \mathcal{R}_z^{\mathfrak{A}}(@x.u)) \diamond \mathbf{j}_1^z & (\rho = \mathbf{f}_1^x) \\ \emptyset & (\text{otherwise}) \end{cases} = \mathcal{R}_z^{\mathfrak{A}}(D_\rho^{\mathfrak{A}}(@x.s \cap u)).
\end{aligned}$$

- Case $\tilde{t} = \tilde{s} ;_1 u$: We have:

$$\begin{aligned}
D_\rho^{\mathfrak{A}}(\mathcal{R}_z^{\mathfrak{A}}(\tilde{s} ;_1 u)) &= \bigcup_{y \in |\mathfrak{A}|} D_\rho^{\mathfrak{A}}(\mathcal{R}_y^{\mathfrak{A}}(\tilde{s}) \diamond \mathcal{R}_{y,z}^{\mathfrak{A}}(u)) \\
&= \left(\bigcup_{y \in |\mathfrak{A}|} D_\rho^{\mathfrak{A}}(\mathcal{R}_y^{\mathfrak{A}}(\tilde{s})) \diamond \mathcal{R}_{y,z}^{\mathfrak{A}}(u) \right) \cup \bigcup_{y \in |\mathfrak{A}|; \mathbf{E}_y(\mathcal{R}_y^{\mathfrak{A}}(\tilde{s}))} D_\rho^{\mathfrak{A}}(\mathcal{R}_z^{\mathfrak{A}}(@y.u)) && \text{(Prop. 4.8 } (\diamond)) \\
&= \left(\bigcup_{y \in |\mathfrak{A}|} \mathcal{R}_y^{\mathfrak{A}}(D_\rho^{\mathfrak{A}}(\tilde{s})) \diamond \mathcal{R}_{y,z}^{\mathfrak{A}}(u) \right) \cup \bigcup_{y \in |\mathfrak{A}|; \mathbf{E}_y(\tilde{s})} \mathcal{R}_z^{\mathfrak{A}}(D_\rho^{\mathfrak{A}}(@y.u)) && \text{(Lem. 4.2, IH)} \\
&= \mathcal{R}_z^{\mathfrak{A}} \left(\left(D_\rho^{\mathfrak{A}}(\tilde{s}) ;_1 u \right) \cup \bigcup_{y \in |\mathfrak{A}|; \mathbf{E}_y(\tilde{s})} D_\rho^{\mathfrak{A}}(@y.u) \right) = \mathcal{R}_z^{\mathfrak{A}}(D_\rho^{\mathfrak{A}}(\tilde{s} ;_1 u)). && \text{(By Def. 3.2)}
\end{aligned}$$

- Case $\tilde{t} = \tilde{s} \cap_1 \tilde{u}$: We have:

$$\begin{aligned}
D_\rho^{\mathfrak{A}}(\mathcal{R}_z^{\mathfrak{A}}(\tilde{s} \cap_1 \tilde{u})) &= D_\rho^{\mathfrak{A}}((\mathcal{R}_z^{\mathfrak{A}}(\tilde{s}) \parallel \mathcal{R}_z^{\mathfrak{A}}(\tilde{u})) \diamond j_1^z) \\
&= \begin{cases} (\mathcal{R}_z^{\mathfrak{A}}(D_{\rho'}^{\mathfrak{A}}(\tilde{s})) \parallel \mathcal{R}_z^{\mathfrak{A}}(\tilde{u})) \diamond j_1^z & (\rho = (\rho' \parallel \mathbf{1}^{\overrightarrow{\text{lab}}(\tilde{u})}) \text{ for some } \rho') \\ (\mathcal{R}_z^{\mathfrak{A}}(\tilde{s}) \parallel \mathcal{R}_z^{\mathfrak{A}}(D_{\rho'}^{\mathfrak{A}}(\tilde{u}))) \diamond j_1^z & (\rho = (\mathbf{1}^{\overrightarrow{\text{lab}}(\tilde{s})} \parallel \rho') \text{ for some } \rho') \\ \{1^z \mid \mathbf{E}_z(\tilde{s}) \wedge \mathbf{E}_z(\tilde{u})\} & (\rho = j_1^z) \\ \emptyset & \text{(otherwise)} \end{cases} && \text{(Prop. 4.8, IH)} \\
&= \begin{cases} \mathcal{R}_z^{\mathfrak{A}}(D_{\rho'}^{\mathfrak{A}}(\tilde{s}) \cap_1 \tilde{u}) & (\rho = (\rho' \parallel \mathbf{1}^{\overrightarrow{\text{lab}}(\tilde{u})}) \text{ for some } \rho') \\ \mathcal{R}_z^{\mathfrak{A}}(\tilde{s} \cap_1 D_{\rho'}^{\mathfrak{A}}(\tilde{u})) & (\rho = (\mathbf{1}^{\overrightarrow{\text{lab}}(\tilde{s})} \parallel \rho') \text{ for some } \rho') \\ \mathcal{R}_z^{\mathfrak{A}}(\{ @z.1 \mid \mathbf{E}_z(\tilde{s}) \wedge \mathbf{E}_z(\tilde{u}) \}) & (\rho = j_1^z) \\ \emptyset & \text{(otherwise)} \end{cases} && \text{(By Def. 3.2)} \\
&= \mathcal{R}_z^{\mathfrak{A}}(D_\rho^{\mathfrak{A}}(\tilde{s} \cap_1 \tilde{u})).
\end{aligned}$$

Hence this completes the proof. \square

Proof of Lem. 4.5. By easy induction on the number k of edges occurring in ρ using Lem. 4.9. We distinguish the following cases:

- Case $k = 0$: We have:

$$D_\rho^{\mathfrak{A}}(\mathcal{R}_z^{\mathfrak{A}}(\tilde{t})) = \begin{cases} \mathcal{R}_z^{\mathfrak{A}}(\tilde{t}) & (\rho = \mathbf{1}^{\overrightarrow{\text{lab}}(\tilde{t})}) \\ \emptyset & \text{(otherwise)} \end{cases} = \mathcal{R}_z^{\mathfrak{A}}(D_\rho^{\mathfrak{A}}(\tilde{t})). \quad \text{(By the rule (R))}$$

- Case $k \geq 1$: By Prop. 2.19, let a_1, \dots, a_k be atomic \mathfrak{A} -runs s.t. $\rho = a_1 \diamond \dots \diamond a_k$. We have:

$$\begin{aligned}
D_{a_1 \diamond \dots \diamond a_k}^{\mathfrak{A}}(\mathcal{R}_z^{\mathfrak{A}}(\tilde{t})) &= D_{a_k}^{\mathfrak{A}}(D_{a_{k-1}}^{\mathfrak{A}}(\dots (D_{a_1}^{\mathfrak{A}}(\mathcal{R}_z^{\mathfrak{A}}(\tilde{t})))) \\
&= \mathcal{R}_z^{\mathfrak{A}}(D_{a_k}^{\mathfrak{A}}(D_{a_{k-1}}^{\mathfrak{A}}(\dots (D_{a_1}^{\mathfrak{A}}(\tilde{t})))) && \text{(By Lem. 4.9, iteratively)} \\
&= \mathcal{R}_z^{\mathfrak{A}}(D_{a_1 \diamond \dots \diamond a_k}^{\mathfrak{A}}(\tilde{t})). && \text{(By the rule (T))}
\end{aligned}$$

Hence this completes the proof. \square

4.2. Closure property of derivatives. Moreover, the derivatives above have a closure property like Antimirov's derivatives [Ant96, BBM⁺16].

Definition 4.10. Let L be a set. For a KL term t , the *closure* $\text{cl}_L(t)$ is the set of IKL terms defined by:

$$\begin{aligned} \text{cl}_L(a) &\triangleq \{ @y.a, @y.1 \mid y \in L \} \text{ for } a \in \Sigma, \\ \text{cl}_L(1) &\triangleq \{ @y.1 \mid y \in L \}, \\ \text{cl}_L(0) &\triangleq \{ 0 \}, \\ \text{cl}_L(s ; u) &\triangleq \{ @y.s ; u \mid y \in L \} \cup (\text{cl}_L(s) ;_1 u) \cup \text{cl}_L(u), \\ \text{cl}_L(s + u) &\triangleq \{ @y.s + u \mid y \in L \} \cup \text{cl}_L(s) \cup \text{cl}_L(u), \\ \text{cl}_L(s^*) &\triangleq \{ @y.s^* \mid y \in L \} \cup (\text{cl}_L(s) ;_1 s^*), \\ \text{cl}_L(s \cap u) &\triangleq \{ @y.s \cap u, @y.1 \mid y \in L \} \cup (\text{cl}_L(s) \cap_1 \text{cl}_L(u)). \end{aligned}$$

For an IKL term $\tilde{t} \in \tilde{\mathbf{T}}_L$, the closure $\text{cl}_L(\tilde{t})$ is the set of IKL terms defined by:

$$\begin{aligned} \text{cl}_L(@x.t) &\triangleq \text{cl}_L(t), \\ \text{cl}_L(\tilde{s} ;_1 u) &\triangleq (\text{cl}_L(\tilde{s}) ;_1 u) \cup \text{cl}_L(u), \\ \text{cl}_L(\tilde{s} \cap_1 \tilde{u}) &\triangleq \{ @y.1 \mid y \in L \} \cup (\text{cl}_L(\tilde{s}) \cap_1 \text{cl}_L(\tilde{u})). \end{aligned}$$

We then extend cl_L for sets of IKL terms, by $\text{cl}_L(\tilde{T}) \triangleq \bigcup_{\tilde{t} \in \tilde{T}} \text{cl}_L(\tilde{t})$.

By the following two propositions, we have that the function cl is a closure operator of the derivatives defined above.

Proposition 4.11. *For each set L , the function $\text{cl}_L : \wp(\tilde{\mathbf{T}}_L) \rightarrow \wp(\tilde{\mathbf{T}}_L)$ is a closure operator.*

Proof. Because we have the following, respectively:

- Extensivity $\tilde{T} \subseteq \text{cl}_L(\tilde{T})$: Because $\tilde{t} \in \text{cl}_L(\tilde{t})$ (by definition).
- Monotonicity $\tilde{T} \subseteq \tilde{S} \Rightarrow \text{cl}_L(\tilde{T}) \subseteq \text{cl}_L(\tilde{S})$: By $\text{cl}_L(\tilde{T}) = \bigcup_{\tilde{t} \in \tilde{T}} \text{cl}_L(\tilde{t}) \subseteq \bigcup_{\tilde{t} \in \tilde{S}} \text{cl}_L(\tilde{t}) = \text{cl}_L(\tilde{S})$.
- Idempotency $\text{cl}_L(\text{cl}_L(\tilde{T})) \subseteq \text{cl}_L(\tilde{T})$: It suffices to prove that $\text{cl}_L(\text{cl}_L(t)) \subseteq \text{cl}_L(t)$ and $\text{cl}_L(\text{cl}_L(\tilde{t})) \subseteq \text{cl}_L(\tilde{t})$. This is shown by induction on the size of t (resp. \tilde{t}). \square

Proposition 4.12. *Let \mathfrak{A} be a structure and let ρ be a \mathfrak{A} -run. For all IKL terms $\tilde{t} \in \tilde{\mathbf{T}}_{|\mathfrak{A}|}$, we have $D_\rho^{\mathfrak{A}}(\tilde{t}) \subseteq \text{cl}_{|\mathfrak{A}|}(\tilde{t})$.*

Proof. When ρ is an atomic \mathfrak{A} -run, this is shown by easy induction on the size of \tilde{t} (by comparing Prop. 4.4 and Def. 4.10). By extensivity and idempotency (Prop. 4.11), we can extend this property from atomic \mathfrak{A} -runs to \mathfrak{A} -runs. \square

Moreover, on the closure size, we have the following.

Proposition 4.13. *Let L be a set. For all KL terms t , $\#\text{cl}_L(t) \leq (2 \times \#L \times \|t\|)^{\text{iw}(t)}$.*

Proof. By easy induction on t .

- Case $t = a$ where $a \in \Sigma \cup \{1, 0\}$: By $\#\text{cl}_L(t) \leq 2 \times \#L \leq (2 \times \#L \times \|t\|)^1$.

- Case $t = s \heartsuit u$ where $\heartsuit \in \{;, +\}$: We have:

$$\begin{aligned}
\# \text{cl}_L(s \heartsuit u) &\leq \#L + \# \text{cl}_L(s) + \# \text{cl}_L(u) && \text{(By the definition of } \text{cl}_L \text{ (Def. 4.10))} \\
&\leq \#L + (2 \times \#L \times \|s\|)^{\text{iw}(s)} + (2 \times \#L \times \|u\|)^{\text{iw}(u)} && \text{(IH)} \\
&\leq (2 \times \#L)^{\max(\text{iw}(s), \text{iw}(u))} \times (1 + \|s\|^{\max(\text{iw}(s), \text{iw}(u))} + \|u\|^{\max(\text{iw}(s), \text{iw}(u))}) \\
&\leq (2 \times \#L \times \|s \heartsuit u\|)^{\text{iw}(s \heartsuit u)}.
\end{aligned}$$

- Case $t = s^*$: We have:

$$\begin{aligned}
\# \text{cl}_L(s^*) &\leq \#L + \# \text{cl}_L(s) && \text{(By the definition of } \text{cl}_L \text{ (Def. 4.10))} \\
&\leq \#L + (2 \times \#L \times \|s\|)^{\text{iw}(s)} && \text{(IH)} \\
&\leq (2 \times \#L)^{\text{iw}(s)} \times (1 + \|s\|^{\text{iw}(s)}) \leq (2 \times \#L \times \|s^*\|)^{\text{iw}(s^*)}.
\end{aligned}$$

- Case $t = s \cap u$: We have:

$$\begin{aligned}
\# \text{cl}_L(s \cap u) &\leq \#L + \# \text{cl}_L(s) \times \# \text{cl}_L(u) + \#L && \text{(By the definition of } \text{cl}_L \text{ (Def. 4.10))} \\
&\leq 2 \times \#L + (2 \times \#L \times \|s\|)^{\text{iw}(s)} \times (2 \times \#L \times \|u\|)^{\text{iw}(u)} && \text{(IH)} \\
&\leq (2 \times \#L)^{\text{iw}(s) + \text{iw}(u)} \times (1 + \|s\|^{\text{iw}(s)} \times \|u\|^{\text{iw}(u)}) \\
&\leq (2 \times \#L)^{\text{iw}(s) + \text{iw}(u)} \times (1 + \|s\| + \|u\|)^{\text{iw}(s) + \text{iw}(u)} \leq (2 \times \#L \times \|s \cap u\|)^{\text{iw}(s \cap u)}.
\end{aligned}$$

Hence, this completes the proof. \square

5. DECOMPOSING DERIVATIVES: AN AUTOMATA CONSTRUCTION

In this section, we show that the derivatives are decomposable on path decompositions (Thm. 5.5 in Sect. 5.2), and we give an automata construction (Sect. 5).

We write STR for the class of all structures. We let $\text{STR}_k \triangleq \{\mathfrak{A} \in \text{STR} \mid |\mathfrak{A}| \subseteq [k]\}$.

5.1. Gluing operator for path decompositions. For $\mathfrak{A}_1, \dots, \mathfrak{A}_n \in \text{STR}$, the *disjoint union* $\bigsqcup_{i=1}^n \mathfrak{A}_i$ is defined as the structure $\langle \{\langle i, x \rangle \mid i \in [n], x \in |\mathfrak{A}_i|\}, \{\langle \langle i, x \rangle, \langle i, y \rangle \rangle \mid i \in [n], \langle x, y \rangle \in a^{\mathfrak{A}_i}\}_{a \in \Sigma} \rangle$. We consider the following gluing operator.

Definition 5.1. Let $\vec{\mathfrak{A}} = \mathfrak{A}_1 \dots \mathfrak{A}_n \in \text{STR}^+$. The structure $\odot \vec{\mathfrak{A}}$ (or written $\odot_{i=1}^n \mathfrak{A}_i$) is defined as follows:

$$\odot \vec{\mathfrak{A}} \triangleq \left(\bigsqcup_{i=1}^n \mathfrak{A}_i \right) / \sim_{\vec{\mathfrak{A}}}$$

where $\sim_{\vec{\mathfrak{A}}}$ is the minimal binary relation closed under the following rule:

For all x and $i \in [n-1]$, if $x \in |\mathfrak{A}_i| \cap |\mathfrak{A}_{i+1}|$, then $\langle i, x \rangle \sim_{\vec{\mathfrak{A}}} \langle i+1, x \rangle$.

(For notational simplicity, we abbreviate $\sim_{\vec{\mathfrak{A}}}$ to \sim when $\vec{\mathfrak{A}}$ is clear from the context.)

For instance, $\odot \left(\textcircled{1} \xleftarrow{b} \textcircled{2} \right) \left(\textcircled{2} \xleftarrow{b} \textcircled{3} \right) \left(\textcircled{3} \xleftarrow{b} \textcircled{1} \right) = \left(\textcircled{1} \xleftarrow{b} \textcircled{2} \xleftarrow{b} \textcircled{3} \xleftarrow{b} \textcircled{1} \right)$. This gluing operator transforms a given path decomposition into the original structure up to isomorphisms.

Proposition 5.2. *Let \mathfrak{A} be a structure. If $\vec{\mathfrak{B}}$ is a path decomposition of \mathfrak{A} , then $\mathfrak{A} \cong \odot \vec{\mathfrak{B}}$.*

Proof. Easy, by definition. \square

From this, $\text{REL}_{\text{pw} \leq k} = \{\odot \vec{\mathfrak{A}} \mid \vec{\mathfrak{A}} \in \text{STR}_{k+1}^+\}$. By the linearly bounded pathwidth model property (Prop. 2.10), the equational theory of KL terms can be reformulated as follows:

$$\text{REL} \models t \leq s \quad \Leftrightarrow \quad \{\odot \vec{\mathfrak{A}} \mid \vec{\mathfrak{A}} \in \text{STR}_{\text{iw}(t)+1}^+\} \models t \leq s.$$

Because path decompositions are sequences (words) of structures, this characterization is compatible with the automata construction given later.

5.2. Decomposing derivatives. Let \bullet be a fresh special label for denoting a special isolated vertex. For a structure \mathfrak{A} , let $\mathfrak{A}_\bullet \triangleq \langle \mathfrak{A} \uplus \{\bullet\}, \{a^\mathfrak{A}\}_{a \in \Sigma} \rangle$. Clearly, for all $\tilde{t}, \tilde{s} \in \tilde{\mathbf{T}}_{|\mathfrak{A}|}$, $\tilde{t} \xrightarrow{\mathfrak{A}} \tilde{s}$ iff $\tilde{t} \xrightarrow{\mathfrak{A}_\bullet} \tilde{s}$.

Let $\vec{\mathfrak{A}} = \mathfrak{A}_1 \dots \mathfrak{A}_n \in \text{STR}^+$. In the sequel, we consider the structure $\odot((\mathfrak{A}_1)_\bullet \dots (\mathfrak{A}_n)_\bullet)$; we use $(\odot \vec{\mathfrak{A}})_\bullet$ to denote this structure (as they are isomorphic) and we may abbreviate $[\langle i, \bullet \rangle]_{\sim_{(\odot \vec{\mathfrak{A}})_\bullet}}$ to \bullet . For $i \in [n]$, we let $\tilde{\mathbf{T}}_{(i)}^{\vec{\mathfrak{A}}} \triangleq \tilde{\mathbf{T}}_{\{[\langle i, x \rangle]_{\sim_{(\odot \vec{\mathfrak{A}})_\bullet}} \mid x \in |(\mathfrak{A}_i)_\bullet|\}}$. For an IKL term \tilde{t} and $i \in [n]$, let $\tilde{t}_{(i)}$ be the IKL term \tilde{t} in which each x has been replaced with $[\langle i, x \rangle]_{\sim_{(\odot \vec{\mathfrak{A}})_\bullet}}$.

We consider the following composition of derivative relations.

Definition 5.3. Let $\vec{\mathfrak{A}} = \mathfrak{A}_1 \dots \mathfrak{A}_n \in \text{STR}^+$. The relation $\tilde{t} (\odot_{i=1}^n \xrightarrow{(\mathfrak{A}_i)_\bullet}) \tilde{s}$, where $\langle \tilde{t}, \tilde{s} \rangle \in \bigcup_{i=1}^n (\tilde{\mathbf{T}}_{(i)}^{\vec{\mathfrak{A}}})^2$, is defined as the minimal subset closed under the following rules:

$$\begin{array}{c} \frac{\tilde{t} \xrightarrow{(\mathfrak{A}_j)_\bullet} \tilde{s}}{\tilde{t}_{(j)} (\odot_{i=1}^n \xrightarrow{(\mathfrak{A}_i)_\bullet}) \tilde{s}_{(j)}} \text{ D} \\ \frac{\tilde{t} (\odot_{i=1}^n \xrightarrow{(\mathfrak{A}_i)_\bullet}) \tilde{u} \quad \tilde{u} (\odot_{i=1}^n \xrightarrow{(\mathfrak{A}_i)_\bullet}) \tilde{s}}{\tilde{t} (\odot_{i=1}^n \xrightarrow{(\mathfrak{A}_i)_\bullet}) \tilde{s}} \text{ T} \quad \frac{\tilde{t}[\bullet/l] (\odot_{i=1}^n \xrightarrow{(\mathfrak{A}_i)_\bullet}) \tilde{s}[\bullet/r]}{\tilde{t}[x/l] (\odot_{i=1}^n \xrightarrow{(\mathfrak{A}_i)_\bullet}) \tilde{s}[x/r]} \text{ L.} \end{array}$$

Here, $\tilde{t}[y/i]$ denotes the IKL term \tilde{t} in which the i -th label of \tilde{t} has been replaced with y .

Example 5.4. Let $\vec{\mathfrak{A}} = \mathfrak{A}_1 \mathfrak{A}_2$ where $\mathfrak{A}_1 = \left(\begin{array}{c} \textcircled{1} \xleftarrow{b} \textcircled{2} \\ \textcircled{1} \xrightarrow{a} \textcircled{2} \end{array} \right)$ and $\mathfrak{A}_2 = \left(\begin{array}{c} \textcircled{2} \xleftarrow{b} \textcircled{3} \\ \textcircled{2} \xrightarrow{a} \textcircled{3} \end{array} \right)$. Let $\tilde{t} = @[\langle 1, 1 \rangle]_{\sim} . (a^2((b^2 a^2) \cap 1) b^2) \cap 1$ and let $\tilde{s} = @[\langle 1, 1 \rangle]_{\sim} . 1$. We then have $\tilde{t} \xrightarrow{(\odot \vec{\mathfrak{A}})_\bullet} \tilde{s}$ by the following $(\odot \vec{\mathfrak{A}})_\bullet$ -run:

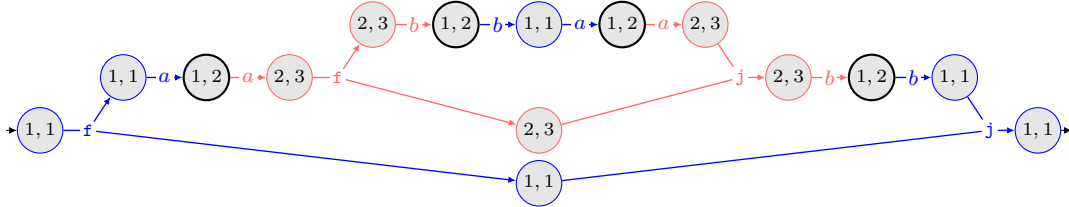

where we abbreviate $[\langle i, x \rangle]_{\sim}$ to “ i, x ” in each vertex. We also have $\tilde{t} (\odot_{i=1}^2 \xrightarrow{(\mathfrak{A}_i)_\bullet}) \tilde{s}$, as follows:

- $\tilde{t} = @[\langle 1, 1 \rangle]_{\sim} . (a^2((b^2 a^2) \cap 1) b^2) \cap 1 (\odot_{i=1}^2 \xrightarrow{(\mathfrak{A}_i)_\bullet}) (@[\langle 1, 2 \rangle]_{\sim} . a((b^2 a^2) \cap 1) b^2) \cap 1 (@[\langle 1, 1 \rangle]_{\sim} . 1)$, by (D) w.r.t. \mathfrak{A}_1 ;
- $(@[\langle 1, 2 \rangle]_{\sim} . a((b^2 a^2) \cap 1) b^2) \cap 1 (@ \bullet . 1) (\odot_{i=1}^2 \xrightarrow{(\mathfrak{A}_i)_\bullet}) (@[\langle 1, 2 \rangle]_{\sim} . b) \cap 1 (@ \bullet . 1)$, by
 – $(@[\langle 2, 2 \rangle]_{\sim} . a((b^2 a^2) \cap 1) b^2) \cap 1 (@ \bullet . 1)$
 $(\odot_{i=1}^2 \xrightarrow{(\mathfrak{A}_i)_\bullet}) (((@[\langle 2, 2 \rangle]_{\sim} . b a^2) \cap 1 (@[\langle 2, 3 \rangle]_{\sim} . 1) b^2) \cap 1 (@ \bullet . 1)$, by (D) w.r.t. \mathfrak{A}_2 ;

- $((@[\langle 1, 2 \rangle] \sim .ba^2) \cap_1 (@ \bullet .1)b^2) \cap_1 (@ \bullet .1)$
 $(\odot_{i=1}^2 \longrightarrow^{(\mathfrak{A}_i) \bullet}) (((@[\langle 1, 2 \rangle] \sim .a) \cap_1 (@ \bullet .1))b^2) \cap_1 (@ \bullet .1)$, by (D) w.r.t. \mathfrak{A}_1 ;
- $((@[\langle 2, 2 \rangle] \sim .a) \cap_1 (@[\langle 2, 3 \rangle] \sim .1)b^2) \cap_1 (@ \bullet .1)$
 $(\odot_{i=1}^2 \longrightarrow^{(\mathfrak{A}_i) \bullet}) (@[\langle 2, 2 \rangle] \sim .b) \cap_1 (@ \bullet .1)$, by (D) w.r.t. \mathfrak{A}_2 ;
- $(@[\langle 1, 2 \rangle] \sim .b) \cap_1 (@[\langle 1, 1 \rangle] \sim .1) (\odot_{i=1}^2 \longrightarrow^{(\mathfrak{A}_i) \bullet}) @[\langle 1, 1 \rangle] \sim .1 = \tilde{s}$, by (D) w.r.t. \mathfrak{A}_1 .

Note that we cannot use IKL terms with labels $[\langle 1, 1 \rangle] \sim$ and $[\langle 2, 3 \rangle] \sim$, because these labels does not occur in \mathfrak{A}_1 nor \mathfrak{A}_2 , simultaneously; so, we should consider an appropriate strategy.

The following decomposition theorem shows that, by composing derivative relations $\longrightarrow^{\mathfrak{A}_i}$ using the rules of Def. 5.3, we can obtain the derivative relation $\longrightarrow^{(\odot \vec{\mathfrak{A}}) \bullet}$. Namely, we can decompose a derivative relation on a large structure into derivative relations on small structures, as follows. The soundness (\Leftarrow) is easy. For the completeness (\Rightarrow), we decompose derivative relations appropriately like as Example 5.4. The proof will be given in Sect. 7.

Theorem 5.5 (decomposition theorem). *Let $\vec{\mathfrak{A}} = \mathfrak{A}_1 \dots \mathfrak{A}_n \in \text{STR}^+$. For all $j \in [n]$ and IKL terms $\tilde{t}, \tilde{s} \in \tilde{\mathbf{T}}_{(j)}^{\vec{\mathfrak{A}}}$, we have:*

$$\tilde{t} \longrightarrow^{(\odot \vec{\mathfrak{A}}) \bullet} \tilde{s} \quad \Leftrightarrow \quad \tilde{t} (\odot_{i=1}^n \longrightarrow^{(\mathfrak{A}_i) \bullet}) \tilde{s}.$$

5.3. Reducing to 2AFAs. Using Thm. 5.5, we can give a reduction from the equational theory of PCoR* into the inclusion problem of two-way alternating finite word automata (2AFAs) [LLS78, LLS84] (the following definition is based on [GO14]).²

5.3.1. 2AFAs. We use \triangleright and \triangleleft as the special characters denoting the leftmost and rightmost. A 2AFA \mathcal{A} over a finite set A is a tuple $\mathcal{A} = \langle |\mathcal{A}|, \delta^{\mathcal{A}}, 1^{\mathcal{A}} \rangle$, where

- $|\mathcal{A}|$ is a finite set of states;
- $\delta^{\mathcal{A}}: |\mathcal{A}| \times (A \uplus \{\triangleright, \triangleleft\}) \rightarrow \mathbb{B}_+(|\mathcal{A}| \times \{-1, 0, 1\})$ is a *transition function*, where $\mathbb{B}_+(X)$ denotes the set of positive boolean formulas over a set X given by

$$\varphi, \psi \in \mathbb{B}_+(X) ::= p \mid \mathbf{f} \mid \mathbf{t} \mid \varphi \vee \psi \mid \varphi \wedge \psi \quad (p \in X);$$

- $1^{\mathcal{A}} \in |\mathcal{A}|$ is the initial state.

For a 2AFA \mathcal{A} and a word $w = a_0 \dots a_{n-1}$ over $A \uplus \{\triangleright, \triangleleft\}$, the set $S_w^{\mathcal{A}} \subseteq |\mathcal{A}| \times [0, n-1]$ is defined as the minimal set closed under the following rule: For $\langle q, i \rangle \in |\mathcal{A}| \times [0, n-1]$ and propositional variables $\langle q_1, i_1 \rangle, \dots, \langle q_m, i_m \rangle \in |\mathcal{A}| \times \{-1, 0, 1\}$, when the positive boolean formula $\delta^{\mathcal{A}}(q, a_i)$ is true under that each $\langle q_k, i_k \rangle$ is true, then

$$\frac{\langle q_1, i + i_1 \rangle \in S_w^{\mathcal{A}} \quad \dots \quad \langle q_m, i + i_m \rangle \in S_w^{\mathcal{A}}}{\langle q, i \rangle \in S_w^{\mathcal{A}}}.$$

For a 2AFA \mathcal{A} , the language is defined as $[\mathcal{A}] \triangleq \{w \in A^* \mid \langle 1^{\mathcal{A}}, 0 \rangle \in S_{\triangleright w \triangleleft}^{\mathcal{A}}\}$. We define the *size* $\|\mathcal{A}\|$ as $\sum_{\langle q, a \rangle \in |\mathcal{A}| \times (A \uplus \{\triangleright, \triangleleft\})} \|\delta^{\mathcal{A}}(q, a)\|$ where $\|\varphi\|$ denotes the number of symbols occurring in the positive boolean formula φ . (Note that, the size may not be bounded by a polynomial in $(\#\mathcal{A} \#A)$, as $\|\delta^{\mathcal{A}}(q, a)\|$ may not be bounded by a polynomial.)

²See also [KZ21] for comparison of definitions of “2AFA”. In their classification, our definition is precisely monotone 2BFA, as we use monotone (but, possibly non-basic) formulas in transition functions.

Proposition 5.6. *The inclusion problem for 2AFAs—given a finite set A and given two 2AFAs \mathcal{A} and \mathcal{B} over A , does $[\mathcal{A}] \subseteq [\mathcal{B}]$ hold?—is decidable in PSPACE.*

Proof. Let \mathcal{A}' be the (one-way) non-deterministic finite automata (1NFA) of states $2^{\mathcal{O}(n \log n)}$ s.t. $[\mathcal{A}'] = [\mathcal{A}]$ obtained by [GO14, Lem. 1], and let $\tilde{\mathcal{B}}'$ be the 1NFA of states $2^{\mathcal{O}(n)}$ s.t. $[\tilde{\mathcal{B}}'] = A^* \setminus [\mathcal{B}]$ obtained by [GO14, Lem. 5] (see also [CDGLV02, Thm. 8]). Here, n is the number of states in the input 2AFA. We have $[\mathcal{A}] \not\subseteq [\mathcal{B}]$ iff $[\mathcal{A}'] \cap [\tilde{\mathcal{B}}'] \neq \emptyset$. Then the right-hand side can be decided in a non-deterministic polynomial space algorithm by the “on-the-fly” checking of the non-emptiness problem of the product 1NFA of \mathcal{A}' and $\tilde{\mathcal{B}}'$.³ Hence, by Savitch’s theorem ((co)NPSpace = PSpace) [Sav70], this completes the proof. \square

5.3.2. *2AFAs construction.* Using 2AFAs, we can naturally encode the rules of Def. 5.3.

Definition 5.7. For $k \geq 1$ and a KL term u , we define the 2AFA \mathcal{A}_k^u over STR_k as follows:

- $|\mathcal{A}_k^u| \triangleq \{1\} \uplus (\text{cl}_{[k] \cup \{\bullet\}}(u)^2 \times \{?, \checkmark\})$, we abbreviate $\langle \tilde{t}, \tilde{s}, p \rangle$ to $\langle \tilde{t}, \tilde{s} \rangle_p$;
- $1^{\mathcal{A}_k^u} \triangleq 1$;
- $\delta^{\mathcal{A}_k^u}(q, a) \triangleq \bigvee X(q, a)$ where $X(q, a) \subseteq \mathbb{B}_+(\|\mathfrak{A}\| \times \{-1, 0, +1\})$ is the minimal set closed under the following rules:

$$\begin{array}{c} \frac{\text{E}_y(\tilde{s})}{\langle \langle @x. u, \tilde{s} \rangle_?, +1 \rangle \in X(1^{\mathcal{A}_k^u}, \triangleright)} \quad \text{i}_{x,y} \ (x, y \in [k]) \quad \frac{\overrightarrow{\text{lab}}(\tilde{t}), \overrightarrow{\text{lab}}(\tilde{s}) \in \|\mathfrak{A}_\bullet\|^+}{\langle \langle \tilde{t}, \tilde{s} \rangle_{\checkmark}, 0 \rangle \in X(\langle \tilde{t}, \tilde{s} \rangle_?, \mathfrak{A})} \checkmark \\ \frac{}{\langle \langle \tilde{t}, \tilde{s} \rangle_?, -1 \rangle \in X(\langle \tilde{t}, \tilde{s} \rangle_{\checkmark}, \mathfrak{A})} -1 \quad \frac{}{\langle \langle \tilde{t}, \tilde{s} \rangle_?, +1 \rangle \in X(\langle \tilde{t}, \tilde{s} \rangle_{\checkmark}, \mathfrak{A})} +1 \quad \frac{\tilde{t} \xrightarrow{\mathfrak{A}_\bullet} \tilde{s}}{\mathfrak{t} \in X(\langle \tilde{t}, \tilde{s} \rangle_{\checkmark}, \mathfrak{A})} \text{D} \\ \frac{\overrightarrow{\text{lab}}(\tilde{u}') \in \|\mathfrak{A}_\bullet\|^+}{\langle \langle \tilde{t}, \tilde{u}' \rangle_{\checkmark}, 0 \rangle \wedge \langle \langle \tilde{u}', \tilde{s} \rangle_{\checkmark}, 0 \rangle \in X(\langle \tilde{t}, \tilde{s} \rangle_{\checkmark}, \mathfrak{A})} \text{T} \quad \frac{}{\langle \langle \tilde{t}[\bullet/l], \tilde{s}[\bullet/r] \rangle_{\checkmark}, 0 \rangle \in X(\langle \tilde{t}[x/l], \tilde{s}[x/r] \rangle_{\checkmark}, \mathfrak{A})} \text{L} \end{array}$$

The rules are defined based on Def. 5.3. Intuitively, the check mark “ \checkmark ” in $\langle \tilde{t}, \tilde{s} \rangle_{\checkmark}$ expresses that $\overrightarrow{\text{lab}}(\tilde{t}), \overrightarrow{\text{lab}}(\tilde{s}) \in \|\mathfrak{A}_\bullet\|^+$ holds (where \mathfrak{A} is the structure in the current position); the question mark “?” in $\langle \tilde{t}, \tilde{s} \rangle_?$ expresses that it has not yet been checked. They are introduced to check it after the rule -1 or $+1$ (as 2AFAs cannot read sibling structures in one step).

Example 5.8. Let $\vec{\mathfrak{A}} = \mathfrak{A}_1 \mathfrak{A}_2$ where $\mathfrak{A}_1 = \left(\begin{array}{c} \textcircled{1} \xleftarrow{b} \textcircled{2} \\ \xrightarrow{a} \end{array} \right)$ and $\mathfrak{A}_2 = \left(\begin{array}{c} \textcircled{2} \xleftarrow{b} \textcircled{3} \\ \xrightarrow{a} \end{array} \right)$. Let

$$\begin{array}{lll} \tilde{t}_1 = @1.(a^2b^2) \cap 1, & \tilde{t}_2 = (@2.ab^2) \cap_1 (@1.1), & \tilde{t}'_2 = (@2.ab^2) \cap_1 (@\bullet.1), \\ \tilde{t}'_3 = (@2.b) \cap_1 (@\bullet.1), & \tilde{t}_3 = (@2.b) \cap_1 (@1.1), & \tilde{t}_4 = @1.1. \end{array}$$

Then $(\tilde{t}_1)_{(1)} \rightsquigarrow (\tilde{t}_4)_{(1)}$ holds by the following derivation tree (w.r.t. the rules Def. 5.3), where we abbreviate $(\odot_{i=1}^2 \xrightarrow{(\mathfrak{A}_i)\bullet})$ to (\rightsquigarrow) :

³See [GO14] for the precise constructions of \mathcal{A}' and $\tilde{\mathcal{B}}'$. For \mathcal{A}' [GO14, Lem. 1], we can encode each state of \mathcal{A}' (expressed as a sequence over subsets of $|A|$) in $\mathcal{O}(n \log n)$ -space because its length is at most $2n$ and each state of \mathcal{A} occurs at most 2 times. Given $q, q' \in |\mathcal{A}'|$ and $a \in A \uplus \{\triangleright, \triangleleft\}$, the membership $\langle q, q' \rangle \in a^{\mathcal{A}'}$ can be decided in polynomial space, by construction. Similarly for $\tilde{\mathcal{B}}'$ [GO14, Lem. 5], the membership $\langle q, q' \rangle \in a^{\tilde{\mathcal{B}}'}$ can be decided in polynomial space. Thus, the “on-the-fly” checking is indeed possible.

$$\begin{array}{c}
\frac{}{(\tilde{t}_1)_{(1)} \rightsquigarrow (\tilde{t}_2)_{(1)}} \text{ D w.r.t. } \mathfrak{A}_1 \quad \frac{\frac{}{(\tilde{t}'_2)_{(2)} \rightsquigarrow (\tilde{t}'_3)_{(2)}} \text{ D w.r.t. } \mathfrak{A}_2}{(\tilde{t}_2)_{(1)} \rightsquigarrow (\tilde{t}_3)_{(1)}} \text{ L}}{(\tilde{t}_1)_{(1)} \rightsquigarrow (\tilde{t}_3)_{(1)}} \text{ T} \quad \frac{}{(\tilde{t}_3)_{(1)} \rightsquigarrow (\tilde{t}_4)_{(1)}} \text{ D w.r.t. } \mathfrak{A}_1 \\
\hline
(\tilde{t}_1)_{(1)} \rightsquigarrow (\tilde{t}_4)_{(1)} \text{ T}
\end{array}$$

Let $u = a^2b^2 \cap 1$. This tree can be simulated in \mathcal{A}_k^u as follows, where we omit “ $\in S_{\triangleright \mathfrak{A}_k^u}$ ”:

$$\begin{array}{c}
\frac{}{\langle \langle \tilde{t}_1, \tilde{t}_2 \rangle_{\checkmark}, 1 \rangle} \text{ D w.r.t. } \mathfrak{A}_1 \quad \frac{\frac{\frac{\frac{}{\langle \langle \tilde{t}'_2, \tilde{t}'_3 \rangle_{\checkmark}, 2 \rangle} \text{ D w.r.t. } \mathfrak{A}_2}{\langle \langle \tilde{t}'_2, \tilde{t}'_3 \rangle_{?}, 2 \rangle} \checkmark}{\langle \langle \tilde{t}'_2, \tilde{t}'_3 \rangle_{\checkmark}, 1 \rangle} \text{ L}}{\langle \langle \tilde{t}_2, \tilde{t}_3 \rangle_{\checkmark}, 1 \rangle} \text{ L}}{\langle \langle \tilde{t}_1, \tilde{t}_3 \rangle_{\checkmark}, 1 \rangle} \text{ T} \quad \frac{}{\langle \langle \tilde{t}_3, \tilde{t}_4 \rangle_{\checkmark}, 1 \rangle} \text{ D w.r.t. } \mathfrak{A}_1 \\
\hline
\langle \langle \tilde{t}_1, \tilde{t}_4 \rangle_{\checkmark}, 1 \rangle \text{ T} \\
\frac{\langle \langle \tilde{t}_1, \tilde{t}_4 \rangle_{\checkmark}, 1 \rangle \checkmark}{\langle \langle \tilde{t}_1, \tilde{t}_4 \rangle_{?}, 1 \rangle} \text{ i}_{1,1} \\
\hline
\langle 1^{\mathcal{A}_k^u}, 0 \rangle
\end{array}$$

Since the rules of \mathcal{A}_k^u are defined based on the rules of Def. 5.3, we have the following, as expected. Both directions are shown by easy induction on the derivative trees.

Proposition 5.9 (Appendix A). *Let $k \geq 1$ and let u be an LKL term. Let $\mathfrak{A}_1 \dots \mathfrak{A}_n \in \text{STR}_k^+$. For all $j \in [n]$ and $\tilde{t}, \tilde{s} \in \text{cl}_{|\mathfrak{A}_j| \cup \{\bullet\}}(u)$, we have:*

$$\tilde{t}_{(j)} (\odot_{i=1}^n \longrightarrow^{(\mathfrak{A}_i) \bullet}) \tilde{s}_{(j)} \Leftrightarrow \langle \langle \tilde{t}, \tilde{s} \rangle_{\checkmark}, j \rangle \in S_{\triangleright \mathfrak{A}_1 \dots \mathfrak{A}_n \triangleleft}^{\mathcal{A}_k^u}$$

Thus, we have the following.

Lemma 5.10. *For $k \geq 1$ and a KL term t , we have: $[\mathcal{A}_k^t] = \{\vec{\mathfrak{A}} = \mathfrak{A}_1 \dots \mathfrak{A}_n \in \text{STR}_k^+ \mid \langle \langle 1, x \rangle_{\sim}, \langle 1, y \rangle_{\sim} \rangle \in \llbracket t \rrbracket_{\odot \vec{\mathfrak{A}}}$ for some $x, y \in |\mathfrak{A}_1|\}$.*

Proof. Let $\vec{\mathfrak{A}} = \mathfrak{A}_1 \dots \mathfrak{A}_n \in \text{STR}_k^+$. We have:

$$\begin{aligned}
\vec{\mathfrak{A}} \in [\mathcal{A}_k^t] &\Leftrightarrow \exists x, y \in |\mathfrak{A}_1|, \exists \tilde{s} \in \text{cl}_{[k]}(t), \langle \langle @x.t, \tilde{s} \rangle_{\checkmark}, 1 \rangle \in S_{\triangleright \vec{\mathfrak{A}} \triangleleft}^{\mathcal{A}_k^t} \wedge E_y(\tilde{s}) \quad (\text{By the form of } \mathcal{A}_k^t) \\
&\Leftrightarrow \exists x, y \in |\mathfrak{A}_1|, \exists \tilde{s} \in \text{cl}_{[k]}(t), (@x.t)_{(1)} (\odot_{i=1}^n \longrightarrow^{(\mathfrak{A}_i) \bullet}) \tilde{s}_{(1)} \wedge E_y(\tilde{s}) \quad (\text{Prop. 5.9}) \\
&\Leftrightarrow \exists x, y \in |\mathfrak{A}_1|, \exists \tilde{s} \in \text{cl}_{[k]}(t), (@x.t)_{(1)} \longrightarrow^{(\odot \vec{\mathfrak{A}}) \bullet} \tilde{s}_{(1)} \wedge E_y(\tilde{s}) \quad (\text{Thm. 5.5}) \\
&\Leftrightarrow \exists x, y \in |\mathfrak{A}_1|, \exists \tilde{s} \in \text{cl}_{[k]}(t), (@x.t)_{(1)} \longrightarrow^{\odot \vec{\mathfrak{A}}} \tilde{s}_{(1)} \wedge E_{[\langle 1, y \rangle]_{\sim}}(\tilde{s}_{(1)}) \\
&\Leftrightarrow \exists x, y \in |\mathfrak{A}_1|, [\langle 1, y \rangle]_{\sim} \in \llbracket @[\langle 1, x \rangle]_{\sim}.t \rrbracket_{\odot \vec{\mathfrak{A}}}. \quad (\text{Thm. 4.7})
\end{aligned}$$

Hence, this completes the proof. \square

When l and r are fresh variables, we have: $\text{REL} \models t \leq s \Leftrightarrow \text{REL} \models \top ltr \top \leq \top lsr \top$. For PCoR* terms of the form $\top u \top$, either $\llbracket \top u \top \rrbracket_{\mathfrak{A}} = \emptyset$ or $\llbracket \top u \top \rrbracket_{\mathfrak{A}} = |\mathfrak{A}|^2$ holds. Thus, if there is a KL term u_{\top} such that $\llbracket u_{\top} \rrbracket_{\mathfrak{A}} = \llbracket \top \rrbracket_{\mathfrak{A}}$ (note that \top is not a KL term), then we have:

$\text{REL}_{\text{pw} \leq k-1} \models t \leq s$ iff $\{\vec{\mathfrak{A}} \in \text{STR}_k^+ \mid \llbracket u_{\top} ltru_{\top} \rrbracket_{\odot \vec{\mathfrak{A}}} \neq \emptyset\} \subseteq \{\vec{\mathfrak{A}} \in \text{STR}_k^+ \mid \llbracket u_{\top} lsru_{\top} \rrbracket_{\odot \vec{\mathfrak{A}}} \neq \emptyset\}$
 iff $[\mathcal{A}_k^{u_{\top} ltru_{\top}}] \subseteq [\mathcal{A}_k^{u_{\top} lsru_{\top}}]$.

From this, if we can encode \top , then by using Lem. 5.10, we can encode the equational theory of KL terms. In the following, we consider encoding \top on our automata construction.

5.3.3. *A normal form of path decompositions.* Let $\mathcal{L}_k^{\text{N}} \triangleq \text{STR}_k^+ \setminus (\mathcal{L}_k^{\text{Inac}} \cup \mathcal{L}_k^{\text{Incon}})$ where

$$\begin{aligned} \mathcal{L}_k^{\text{Inac}} &\triangleq \text{STR}_k^* ; \{ \mathfrak{A}_1 \mathfrak{A}_2 \in \text{STR}_k^2 \mid |\mathfrak{A}_1| \cap |\mathfrak{A}_2| = \emptyset \} ; \text{STR}_k^* , \\ \mathcal{L}_k^{\text{Incon}} &\triangleq \text{STR}_k^* ; \left\{ \mathfrak{A}_1 \mathfrak{A}_2 \in \text{STR}_k^2 \mid \exists b \in \Sigma, b^{\mathfrak{A}_1} \cap \left(\bigcap_{i=1}^2 |\mathfrak{A}_i| \right)^2 \neq b^{\mathfrak{A}_2} \cap \left(\bigcap_{i=1}^2 |\mathfrak{A}_i| \right)^2 \right\} ; \text{STR}_k^* . \end{aligned}$$

Intuitively, $\mathcal{L}_k^{\text{Inac}}$ detects adjacent structures not sharing any vertices, and $\mathcal{L}_k^{\text{Incon}}$ detects adjacent structures such that their relations are not the same in the sharing part.

Proposition 5.11. *For $k \geq 2$, $\text{REL}_{\text{pw} \leq k-1} = \{ \odot \vec{\mathfrak{A}} \mid \vec{\mathfrak{A}} \in \mathcal{L}_k^{\text{N}} \}$.*

Proof. Let $\vec{\mathfrak{A}} = \mathfrak{A}_1 \dots \mathfrak{A}_n \in \text{STR}_k^+$. If $|\mathfrak{A}_i| \cap |\mathfrak{A}_{i+1}| = \emptyset$ for some i , then by putting a new component consisting of one vertex in \mathfrak{A}_i and one vertex in \mathfrak{A}_{i+1} between \mathfrak{A}_i and \mathfrak{A}_{i+1} , we can avoid the condition of $\mathcal{L}_k^{\text{Inac}}$. Moreover, for each $\langle [i, x]_{\sim}, [i, y]_{\sim} \rangle \in b^{\odot \vec{\mathfrak{A}}}$, we add a new edge for $\langle x, y \rangle \in b^{\mathfrak{A}_i}$ in \mathfrak{A}_i ; then, we can avoid the condition of $\mathcal{L}_k^{\text{Incon}}$. \square

In the sequel, we consider \mathcal{L}_k^{N} , instead of STR_k^+ . This is useful for encoding extra operators (Sects. 5.3.4 and 6). We use the condition of $\mathcal{L}_k^{\text{Inac}}$ to encode \top and we use the condition of $\mathcal{L}_k^{\text{Incon}}$ to encode tests and nominals.

5.3.4. *Encoding the equational theory of KL.* Let c_{\top} be a special letter for encoding \top . We consider the following language:

$$\mathcal{L}_k^{\top} \triangleq \text{STR}_k^* ; \{ \mathfrak{A} \in \text{STR}_k \mid \neg c_{\top}^{\mathfrak{A}} = |\mathfrak{A}|^2 \} ; \text{STR}_k^* .$$

We then encode the equational theory by the inclusion problem for 2AFAs, as follows.

Lemma 5.12. *Let $k \geq 2$. Let t and s be KL terms. Let l, r, c_{\top} be fresh variables. Then,*

$$\text{REL}_{\text{pw} \leq k-1} \models t \leq s \quad \Leftrightarrow \quad [\mathcal{A}_k^{c_{\top}^* ltrc_{\top}^*}] \cap (\mathcal{L}_k^{\text{N}} \setminus \mathcal{L}_k^{\top}) \subseteq [\mathcal{A}_k^{c_{\top}^* lsrc_{\top}^*}] .$$

Proof. We have:

$$\begin{aligned} \text{REL}_{\text{pw} \leq k-1} \models t \leq s &\Leftrightarrow \text{REL}_{\text{pw} \leq k-1} \models \top ltr \top \leq \top lsr \top \\ &\Leftrightarrow \{ \odot \vec{\mathfrak{A}} \mid \vec{\mathfrak{A}} \in \mathcal{L}_k^{\text{N}} \setminus \mathcal{L}_k^{\top} \} \models \top ltr \top \leq \top lsr \top && \text{(Sect. 5.3.3 and } c_{\top} \text{ is fresh)} \\ &\Leftrightarrow \forall \vec{\mathfrak{A}} \in \mathcal{L}_k^{\text{N}} \setminus \mathcal{L}_k^{\top}, \llbracket c_{\top}^* ltrc_{\top}^* \rrbracket_{\odot \vec{\mathfrak{A}}} \neq \emptyset \text{ implies } \llbracket c_{\top}^* lsrc_{\top}^* \rrbracket_{\odot \vec{\mathfrak{A}}} \neq \emptyset && \llbracket \top \rrbracket_{\odot \vec{\mathfrak{A}}} = \llbracket c_{\top}^* \rrbracket_{\odot \vec{\mathfrak{A}}} \\ &\Leftrightarrow [\mathcal{A}_k^{c_{\top}^* ltrc_{\top}^*}] \cap (\mathcal{L}_k^{\text{N}} \setminus \mathcal{L}_k^{\top}) \subseteq [\mathcal{A}_k^{c_{\top}^* lsrc_{\top}^*}] . && \text{(Lem. 5.10 and } \llbracket \top u \top \rrbracket_{\odot \vec{\mathfrak{A}}} \text{ is } \emptyset \text{ or } |\odot \vec{\mathfrak{A}}|^2 \text{)} \end{aligned}$$

Hence, this completes the proof. \square

5.3.5. *Complexity: On the size of the translated 2AFA.* For the number of states of \mathcal{A}_k^t , by Prop. 4.13, we have $\#\mathcal{A}_k^t = 2^{\mathcal{O}(\text{iw}(t) \log(k\|t\|))}$. For the alphabet size of \mathcal{A}_k^t , we have $\#\text{STR}_k = 2^{\mathcal{O}(k^2\#\Sigma)}$. (The number of structures over the universe S is $2^{\#\Sigma^2\#\Sigma}$, as every element of Σ denotes an binary relation. Thus, $\#\text{STR}_k = \sum_{S \subseteq [k]; S \neq \emptyset} 2^{\#\Sigma^2\#\Sigma} \leq 2^k \times 2^{k^2\#\Sigma} = 2^{\mathcal{O}(k^2\#\Sigma)}$.) For the sizes of the positive boolean formulas, we have $\|\delta^{\mathcal{A}_k^t}(q, a)\| = \mathcal{O}(k^2\#\mathcal{A}_k^t) = 2^{\mathcal{O}(\text{iw}(t) \log(k\|t\|))}$ (due to the rule $(i_{x,y})$ and the rule (T)). Thus, we have $\|\mathcal{A}_k^t\| = 2^{\mathcal{O}(\text{iw}(t) \log(k\|t\|) + k^2\#\Sigma)}$. (Hence, under $k = \mathcal{O}(\|t\|)$, we have $\|\mathcal{A}_k^t\| = 2^{\text{poly}(\|t\|)}$.)

Additionally, for $\mathcal{L}_k^{\text{Inac}}$, there is a 1DFA such that the number of states is $\mathcal{O}(2^k)$ (each state corresponds to the universe in the current structure). For $\mathcal{L}_k^{\text{Incon}}$, there is a 1DFA such that the number of states is $\mathcal{O}(\#\text{STR}_k)$ (each state corresponds to the current structure). For \mathcal{L}_k^\top , there is a 1DFA such that the number of states is a constant. Finally, we have obtained the following complexity result.

Corollary 5.13. *The equational theory for KL terms w.r.t. binary relations—given a finite set Σ and KL terms t and s over Σ , does $\text{REL} \models t \leq s$ hold?—is EXPSPACE-complete.*

Proof. (In EXPSPACE): By Lem. 5.12 with the linearly bounded pathwidth model property (Prop. 2.10), we can reduce the problem into the inclusion problem for 2AFAs:

$$\text{REL} \models t \leq s \quad \Leftrightarrow \quad [\mathcal{A}_{\text{iw}(t)+1}^{c_\top^* \text{ltrc}_\top^*}] \subseteq [\mathcal{A}_{\text{iw}(t)+1}^{c_\top^* \text{lsrc}_\top^*}] \cup \mathcal{L}_{\text{iw}(t)+1}^{\text{Inac}} \cup \mathcal{L}_{\text{iw}(t)+1}^{\text{Incon}} \cup \mathcal{L}_{\text{iw}(t)+1}^\top.$$

Here, we take the union construction. By the discussion above with $k = \text{iw}(t) + 1 \leq \|t\| + 1$ (Prop. 2.3), the 2AFAs have exponential sizes to the input size. By Prop. 5.6, this completes the proof. (EXPSPACE-hard) [Nak17, BP17]: By $\text{REL} \models (\sum_{a \in \Sigma} a)^* \leq t$ iff $\Sigma^* \subseteq [t]_\Sigma$ (Prop. 2.12), we can give a reduction from the universality problem for regular expressions with intersection, which is EXPSPACE-hard [Fü80, Thm. 2]. \square

Remark 5.14. In Cor. 5.13, by [Fü80, Thm. 2], the equational theory for KL terms w.r.t. binary relations is EXPSPACE-hard even when $\#\Sigma = 2$. Furthermore, even when $\#\Sigma = 1$, the equational theory is EXPSPACE-hard; given terms t and s , by letting t' and s' be the terms t and s in which each variable a_i (where $\Sigma = \{a_1, a_2\}$) has been replaced with $u_i \triangleq b^3 \cap b^{3+i}$, we have $\text{REL} \models t \leq s$ iff $\text{REL} \models t' \leq s'$. (\Rightarrow): Because $t' \leq s'$ is obtained by a substitution from $t \leq s$. (\Leftarrow): We show the contraposition. Assume $\llbracket t \rrbracket_{\mathfrak{A}} \not\subseteq \llbracket s \rrbracket_{\mathfrak{A}}$. Let \mathfrak{B} be the structure obtained by extending fresh vertices for $\langle x, y \rangle \in \llbracket u_i \rrbracket_{\mathfrak{B}}$, for each edge $\langle x, y \rangle \in \llbracket a_i \rrbracket_{\mathfrak{A}}$; for instance, if \mathfrak{A} is $\circ - a_1 \rightarrow \circ - a_2 \rightarrow \circ$, then \mathfrak{B} is $\circ \xrightarrow{a_1} \circ \xrightarrow{a_2} \circ$. We then have $\llbracket t' \rrbracket_{\mathfrak{B}} = \llbracket t \rrbracket_{\mathfrak{A}}$ or $\llbracket t' \rrbracket_{\mathfrak{B}} = \llbracket t \rrbracket_{\mathfrak{A}} \cup \Delta_{|\mathfrak{B}| \setminus |\mathfrak{A}|}$, by easy induction on t ; thus, $\llbracket t' \rrbracket_{\mathfrak{B}} \not\subseteq \llbracket s' \rrbracket_{\mathfrak{B}}$.

6. ENCODING EXTRA OPERATORS

In this section, as with \top in the reduction of Lem. 5.12 above, we give encodes of some extra operators in our automata construction. As a consequence, we have that the equational theory of PCoR* is decidable in EXPSPACE.

6.1. **Encoding PCoR*.** In this subsection, we give encodings of \top and \smile . Using them, we can encode the equational theory of PCoR*.

6.1.1. *Encoding top* (\top). We recall \mathcal{L}_k^\top and c_\top (Sect. 5.3.4). For a term t , let t' be the unique normal form w.r.t. the term rewriting system: $\top \rightsquigarrow c_\top^*$. For every $\vec{\mathfrak{A}} \in \text{STR}_k^+ \setminus (\mathcal{L}_k^\top \cup \mathcal{L}_k^{\text{Inac}})$, by $\llbracket c_\top^* \rrbracket_{\odot \vec{\mathfrak{A}}} = \llbracket \top \rrbracket_{\odot \vec{\mathfrak{A}}}$, we have $\llbracket t' \rrbracket_{\odot \vec{\mathfrak{A}}} = \llbracket t \rrbracket_{\odot \vec{\mathfrak{A}}}$. Thus we can encode \top .

6.1.2. *Encoding converse* ($-\smile$). For each variable a , we introduce a fresh variable \check{a} . Let $\text{REL}^\smile \triangleq \{\mathfrak{A} \in \text{REL} \mid \forall a \in \Sigma, \check{a}^{\mathfrak{A}} = (a^{\mathfrak{A}})^\smile\}$. We consider the *converse normal form* [BP15, BP17] of PCOR*. For a PCOR* term t , we consider the unique normal form t' w.r.t. the following term rewriting system:

$$\begin{aligned} a^\smile &\rightsquigarrow \check{a}, & 1^\smile &\rightsquigarrow 1, & 0^\smile &\rightsquigarrow 0, & \top^\smile &\rightsquigarrow \top, & (t; s)^\smile &\rightsquigarrow s^\smile; t^\smile, \\ (t + s)^\smile &\rightsquigarrow t^\smile + s^\smile, & (t \cap s)^\smile &\rightsquigarrow t^\smile \cap s^\smile, & (t^\smile)^\smile &\rightsquigarrow t, & (t^*)^\smile &\rightsquigarrow (t^\smile)^*. \end{aligned}$$

Then, for $\mathfrak{A} \in \text{REL}^\smile$, we have $\llbracket t' \rrbracket_{\mathfrak{A}} = \llbracket t \rrbracket_{\mathfrak{A}}$. Let $\mathcal{L}_k^\smile \triangleq \text{STR}_k^* \setminus \{\mathfrak{A} \in \text{STR}_k \mid \neg \check{a}^{\mathfrak{A}} = (a^{\mathfrak{A}})^\smile\}; \text{STR}_k^*$. Then, $\text{REL}_{\text{pw} \leq k-1}^\smile = \{\odot \vec{\mathfrak{A}} \mid \vec{\mathfrak{A}} \in \text{STR}_k^+ \setminus \mathcal{L}_k^\smile\}$. For \mathcal{L}_k^\smile , there is a 1DFA such that the number of states is a constant size. Thus we can encode $-\smile$.

6.1.3. *Encoding the equational theory of PCOR**. By using the encodings above, we can encode the equational theory of PCOR*. Thus, we have the following.

Corollary 6.1. *The equational theory of PCOR* is decidable and EXPSPACE-complete.*

Proof. (EXPSPACE-hardness): By Cor. 5.13. (In EXPSPACE): Let t and s be the KL terms obtained from given PCOR* terms t' and s' by applying the translations of Sects. 6.1.1 and 6.1.2. Similar to Cor. 5.13, we can reduce into the inclusion problem for 2AFAs, as follows: $\text{REL} \models t' \leq s'$ iff $\text{REL}_{\text{pw} \leq \text{iw}(t')} \models t' \leq s'$ (Prop. 2.10) iff

$$[\mathcal{A}_{\text{iw}(t)+1}^{c_\top^* \text{ltr} c_\top^*}] \subseteq [\mathcal{A}_{\text{iw}(t)+1}^{c_\top^* \text{lsr} c_\top^*}] \cup \mathcal{L}_{\text{iw}(t)+1}^{\text{Inac}} \cup \mathcal{L}_{\text{iw}(t)+1}^{\text{Incon}} \cup \mathcal{L}_{\text{iw}(t)+1}^\top \cup \mathcal{L}_{\text{iw}(t)+1}^\smile.$$

Because these 2AFAs have exponential sizes, this completes the proof by Prop. 5.6. \square

6.2. **Encoding tests and nominals.** In this subsection, moreover, we give encodings of tests in Kleene algebra with tests [KS96, Sect. 4] and nominals in hybrid logic [AtC07].

6.2.1. *Encoding tests.* Let $B \subseteq \Sigma$ be a finite set of *atomic tests*. Let $\text{REL}^{\text{tests}_B} \triangleq \{\mathfrak{A} \in \text{REL} \mid \forall b \in B, b^{\mathfrak{A}} \subseteq \Delta_{|\mathfrak{A}|}\}$. The set of *PCOR* terms with tests* is given by:

$$\begin{aligned} t, s &::= p \mid a \mid 1 \mid 0 \mid t; s \mid t + s \mid t^*, & (a \in \Sigma \setminus B) \\ p, q &::= b \mid 1 \mid 0 \mid p; q \mid p + q \mid p^-. & (b \in B) \end{aligned}$$

where the term p^- expresses the complement of p w.r.t. the identify—the semantics is extended by $\llbracket p^- \rrbracket_{\mathfrak{A}} = \Delta_{|\mathfrak{A}|} \setminus \llbracket p \rrbracket_{\mathfrak{A}}$ (the others are the same as PCOR* terms). Using tests, we can encode propositional while programs [FL79, Koz97]:

$$\text{while } p \text{ do } t \triangleq (pt)^* p^-, \quad \text{if } p \text{ then } t \text{ else } s \triangleq (pt) \cup (p^- s).$$

For each $b \in B$, we introduce a fresh variable \bar{b} ; let \bar{B} be the set $\{\bar{b} \mid b \in B\}$. Let $\text{REL}^{\text{tests}_{B, \bar{B}}} \triangleq \{\mathfrak{A} \in \text{REL} \mid \forall b \in B, b^{\mathfrak{A}} \uplus \bar{b}^{\mathfrak{A}} = \Delta_{|\mathfrak{A}|}\}$. For a term t , we consider the unique normal form t' in PCOR* terms w.r.t. the following term rewriting system:

$$b^- \rightsquigarrow \bar{b}, \quad 1^- \rightsquigarrow 0, \quad 0^- \rightsquigarrow 1, \quad (p; q)^- \rightsquigarrow p^- + q^-, \quad (p + q)^- \rightsquigarrow p^-; q^-.$$

Then, for $\mathfrak{A} \in \text{REL}^{\text{tests}_B}$, we have $\llbracket t' \rrbracket_{\mathfrak{A}} = \llbracket t \rrbracket_{\mathfrak{A}}$. Let

$$\mathcal{L}_k^{\text{tests}_{B,\bar{B}}} \triangleq \text{STR}_k^* ; \{ \mathfrak{A} \in \text{STR}_k \mid \exists b \in B, b^{\mathfrak{A}} \uplus \bar{b}^{\mathfrak{A}} \neq \Delta_{|\mathfrak{A}|} \} ; \text{STR}_k^*.$$

Then, $\text{REL}_{\text{pw} \leq k-1}^{\text{tests}_{B,\bar{B}}} = \{ \odot \vec{\mathfrak{A}} \mid \vec{\mathfrak{A}} \in \text{STR}_k^+ \setminus (\mathcal{L}_k^{\text{tests}_{B,\bar{B}}} \cup \mathcal{L}_k^{\text{Incon}}) \}$. For $\mathcal{L}_k^{\text{tests}_{B,\bar{B}}}$, there is a 1NFA such that the number of states is a constant size. Thus, we can encode tests.

6.2.2. Encoding nominals. Let $L \subseteq \Sigma$ be a finite set of *nominals*. Let $\text{REL}^{\text{nom}_L} \triangleq \{ \mathfrak{A} \in \text{REL} \mid \forall l \in L, \exists x \in |\mathfrak{A}|, l^{\mathfrak{A}} = \{ \langle x, x \rangle \} \}$. Using nominals, we can point a vertex. On $\text{REL}^{\text{nom}_L}$, we can also encode the jump operator “@l.t” in the definition of [AtC07], by $\text{REL}^{\text{nom}_L} \models @l.t = \top lt$.

We define the following language:

$$\mathcal{L}_k^{\text{nom}_L} \triangleq \bigcup_{l \in L} \left(\left(\{ \mathfrak{A} \in \text{STR}_k \mid l^{\mathfrak{A}} = \emptyset \}^+ \cup (\text{STR}_k^* ; \{ \mathfrak{A} \in \text{STR}_k \mid l^{\mathfrak{A}} \not\subseteq \Delta_{|\mathfrak{A}|} \} ; \text{STR}_k^*) \cup \right. \right. \\ \left. \left. (\text{STR}_k^* ; \left\{ \mathfrak{A}_1 \dots \mathfrak{A}_n \in \text{STR}_k^+ \mid \exists x, \exists y, \langle x, x \rangle \in l^{\mathfrak{A}_1} \wedge \langle y, y \rangle \in l^{\mathfrak{A}_n} \right. \right. \right. \\ \left. \left. \left. \wedge (x \neq y \vee (x = y \wedge \exists j \in [n], x \notin |\mathfrak{A}_j|)) \right\} ; \text{STR}_k^*) \right) \right).$$

Then, $\text{REL}_{\text{pw} \leq k-1}^{\text{nom}_L} = \{ \odot \vec{\mathfrak{A}} \mid \vec{\mathfrak{A}} \in \text{STR}_k^+ \setminus \mathcal{L}_k^{\text{nom}_L} \}$. (By the first line, $l^{\odot \vec{\mathfrak{A}}} \neq \emptyset$ and $l^{\odot \vec{\mathfrak{A}}} \subseteq \Delta_{|\odot \vec{\mathfrak{A}}|}$.)

By the second line, $\#\{x \mid \langle x, x \rangle \in l^{\odot \vec{\mathfrak{A}}}\} \leq 1$.) For $\mathcal{L}_k^{\text{nom}_L}$, there is a 1NFA such that the number of states is $\mathcal{O}(\#L \times k)$ (intuitively, we use the states for memorizing $l \in L, x \in [k]$, and whether $x \notin |\mathfrak{A}_j|$ holds in past structures \mathfrak{A}_j). Thus, we can encode nominals.

6.2.3. Encoding the equational theory of PCoR* with tests and nominals. From the two above, to use tests and nominals, we consider PCoR* terms in the class $\text{REL}^{\text{tests}_{B,\bar{B}}, \text{nom}_L} \triangleq \text{REL}^{\text{tests}_{B,\bar{B}}} \cap \text{REL}^{\text{nom}_L}$. For the class, we have the following (cf. Prop. 2.10).

Proposition 6.2. *For all PCoR* terms t, s , we have:*

$$\text{REL}^{\text{tests}_{B,\bar{B}}, \text{nom}_L} \models t \leq s \quad \Leftrightarrow \quad \text{REL}_{\text{pw} \leq \text{iw}(t) + \#L}^{\text{tests}_{B,\bar{B}}, \text{nom}_L} \models t \leq s.$$

Proof. (\Rightarrow): Trivial. (\Leftarrow): We prove the contraposition. Assume $\langle x, y \rangle \in \llbracket t \rrbracket_{\mathfrak{A}} \setminus \llbracket s \rrbracket_{\mathfrak{A}}$ for $\mathfrak{A} \in \text{REL}^{\text{tests}_{B,\bar{B}}, \text{nom}_L}$. By Prop. 2.7, $G' \rightarrow G(\mathfrak{A}, x, y)$ for some $G' \in \mathcal{G}(t)$, and $H \not\rightarrow G(\mathfrak{A}, x, y)$ for all $H \in \mathcal{G}(s)$. Let G be the graph G' extended with L isolated vertices having $l_1, \dots, l_{\#L}$ labelled looping edges, respectively, where $L = \{l_1, \dots, l_{\#L}\}$. Then there is a graph homomorphism $h: G \rightarrow G(\mathfrak{A}, x, y)$ by extending $G' \rightarrow G(\mathfrak{A}, x, y)$. Let $\mathcal{S}_{B,\bar{B}}(h) \triangleq \langle |G|, \{a^{\mathcal{S}_{B,\bar{B}}(h)}\}_{a \in \Sigma}, 1^G, 2^G \rangle$ where $a^{\mathcal{S}_{B,\bar{B}}(h)}$ is the binary relation defined by

$$\begin{cases} a^G & (a \in \Sigma \setminus (B \cup \bar{B})) \\ a^G \cup \{ \langle x, x \rangle \in \Delta_{|G|} \mid \langle h(x), h(x) \rangle \in a^H \} & (a \in B \cup \bar{B}) \end{cases}. \text{ Note that } h: \mathcal{S}_{B,\bar{B}}(h) \rightarrow$$

$G(\mathfrak{A}, x, y)$. Let \sim be the minimal equivalence relation satisfying the following two:

- for each $l \in L$, if $\langle x, y \rangle, \langle x', y' \rangle \in l^{\mathcal{S}_{B,\bar{B}}(h)}$, then $x \sim y'$;
- for each $b \in B \cup \bar{B}$, if $\langle x, y \rangle \in b^{\mathcal{S}_{B,\bar{B}}(h)}$, then $x \sim y$.

Then $\mathcal{S}_{B,\bar{B}}(h)/\sim \rightarrow G(\mathfrak{A}, x, y)$ holds because $h(x) = h(y)$ holds for all $x \sim y$. Let \mathfrak{B}, x', y' be such that $G(\mathfrak{B}, x', y') = \mathcal{S}_{B,\bar{B}}(h)/\sim$. By $\mathcal{S}_{B,\bar{B}}(h)/\sim \rightarrow G(\mathfrak{A}, x, y)$, we have $\langle x', y' \rangle \notin \llbracket s \rrbracket_{\mathfrak{B}}$ (Prop. 2.7). By $G' \rightarrow G \rightarrow \mathcal{S}_{B,\bar{B}}(h) \rightarrow \mathcal{S}_{B,\bar{B}}(h)/\sim$, we also have $\langle x', y' \rangle \in \llbracket t \rrbracket_{\mathfrak{B}}$ (Prop. 2.7). Because $\mathfrak{B} \in \text{REL}_{\text{pw} \leq \text{iw}(t) + \#L}^{\text{tests}_{B,\bar{B}}, \text{nom}_L}$ (note that by $\text{pw}(\mathcal{S}_{B,\bar{B}}(h)) = \text{pw}(G) = \text{pw}(G') \leq \text{iw}(t)$ (Prop. 2.6), we have $\text{pw}(\mathcal{S}_{B,\bar{B}}(h)/\sim) \leq \text{iw}(t) + \#L$), this completes the proof. \square

Using this bounded pathwidth model property, we have the following.

Corollary 6.3. *The equational theory of PCOR* terms with tests and nominals is decidable and EXPSPACE-complete.*

Proof. (EXPSPACE-hardness): By Cor. 5.13. (In EXPSPACE): From given terms t'' and s'' (where B and \bar{B} are used for tests and L is used for nominals), let t' and s' be the PCOR* terms obtained by applying the translations of Sect. 6.2.1, and let t and s be the KL terms obtained by applying the translations of Sects. 6.1.1 and 6.1.2, respectively. Similar to Cor. 5.13, we can reduce into the inclusion problem for 2AFAs, as follows: $\text{REL}^{\text{tests}_B, \text{nom}_L} \models t'' \leq s''$ iff $\text{REL}^{\text{tests}_{B, \bar{B}}, \text{nom}_L} \models t' \leq s'$ (Sect. 6.2.1) iff $\text{REL}_{\text{pw} \leq \text{iw}(t) + \#L}^{\text{tests}_{B, \bar{B}}, \text{nom}_L} \models t' \leq s'$ (Prop. 6.2) iff

$$[\mathcal{A}_k^{c_\top^* \text{ltr} c_\top^*}] \subseteq [\mathcal{A}_k^{c_\top^* \text{lsr} c_\top^*}] \cup \mathcal{L}_k^{\text{Inac}} \cup \mathcal{L}_k^{\text{Incon}} \cup \mathcal{L}_k^\top \cup \mathcal{L}_k^\sim \cup \mathcal{L}_k^{\text{tests}_B} \cup \mathcal{L}_k^{\text{nom}_L}$$

where $k \triangleq \text{iw}(t) + \#L + 1$. Because these 2AFAs have exponential sizes, this completes the proof by Prop. 5.6. \square

6.3. Reducing the alphabet size for PSPACE-decidability. In this subsection, we note that we can reduce the alphabet size from $\#\text{STR}_k = 2^{\mathcal{O}(\#\Sigma \times k^2)}$ into $\#\Sigma \times 2^{\mathcal{O}(k^2)}$, by reducing the number of variables occurring at the same time. For instance, if $\mathfrak{A} = \left(\textcircled{1} \xrightarrow{a} \textcircled{2} \xrightarrow{b} \textcircled{3} \right)$, then by letting $\vec{\mathfrak{B}} = \left(\textcircled{1} \xrightarrow{a} \textcircled{2} \quad \textcircled{3} \right) \left(\textcircled{1} \xrightarrow{b} \textcircled{2} \xrightarrow{c} \textcircled{3} \right) \left(\textcircled{1} \quad \textcircled{2} \xrightarrow{c} \textcircled{3} \right)$, we have $\mathfrak{A} \cong \odot \vec{\mathfrak{B}}$. In the sequel, we consider an alignment of the following sets:

$$\{b, \bar{b}, \check{b}, \breve{b}\} \text{ for } b \in B, \quad \{l, \check{l}\} \text{ for } l \in L, \quad \{a, \check{a}\} \text{ for other variables } a;$$

let $\Sigma_0, \dots, \Sigma_{m-1}$ be such a sequence (note that $\#\Sigma_i \leq 4$ for each i). Let $\text{STR}'_k \triangleq \bigcup_{i=0}^{m-1} \{\mathfrak{A} \in \text{STR}_k \mid \{a \in \Sigma \mid a^{\mathfrak{A}_i} \neq \emptyset\} \subseteq \Sigma_i\}$. As above, to enumerate all structures of pathwidth at most $k-1$, it suffices to consider STR'_k . Since $\#\Sigma_i$ is bounded by a fixed number, we have $\#\text{STR}'_k = \#\Sigma \times 2^{\mathcal{O}(k^2)}$. However, this decomposition breaks the condition of $\mathcal{L}_k^{\text{Incon}}$. For that reason, we consider the following well-aligned universe:

$$\mathcal{L}_k^{\text{U}} \triangleq \{\mathfrak{A}_0 \dots \mathfrak{A}_{m-1} \mid |\mathfrak{A}_0| = \dots = |\mathfrak{A}_{m-1}| \wedge \forall i < m, \{b \in \Sigma \mid b^{\mathfrak{A}_i} \neq \emptyset\} \subseteq \Sigma_i\}^+,$$

and then we replace $\mathcal{L}_k^{\text{Incon}}$ with the language $\mathcal{L}_k^{\text{Incon}'}$ defined by:

$$(\text{STR}'_k)^* ; \bigcup_{a \in \Sigma} \left\{ \mathfrak{A}_0 \dots \mathfrak{A}_m \in (\text{STR}'_k)^{m+1} \mid a^{\mathfrak{A}_0} \cap \left(\bigcap_{i=0}^m |\mathfrak{A}_i| \right)^2 \neq a^{\mathfrak{A}_m} \cap \left(\bigcap_{i=0}^m |\mathfrak{A}_i| \right)^2 \right\} ; (\text{STR}'_k)^*.$$

Similarly for the others, we construct as follows:

$$\begin{aligned}
\mathcal{L}_k^{\text{Inac}'} &\triangleq (\text{STR}'_k)^* ; \{ \mathfrak{A}_1 \mathfrak{A}_2 \in (\text{STR}'_k)^2 \mid |\mathfrak{A}_1| \cap |\mathfrak{A}_2| = \emptyset \} ; (\text{STR}'_k)^* , \\
\mathcal{L}_k^{\top'} &\triangleq ((\text{STR}'_k)^m)^* ; (\text{STR}'_k)^{i_{\top}-1} ; \{ \mathfrak{A} \in \text{STR}'_k \mid c_{\top}^{\mathfrak{A}} \neq |\mathfrak{A}|^2 \} ; (\text{STR}'_k)^* \\
&\hspace{15em} \text{where } i_{\top} \text{ is s.t. } c_{\top} \in \Sigma_{i_{\top}} , \\
\mathcal{L}_k^{\smile'} &\triangleq (\text{STR}'_k)^* ; \{ \mathfrak{A} \in \text{STR}'_k \mid \check{a}^{\mathfrak{A}} \neq (a^{\mathfrak{A}})^{\smile} \} ; (\text{STR}'_k)^* , \\
\mathcal{L}_k^{\text{tests}'_B} &\triangleq ((\text{STR}'_k)^m)^* ; \left(\bigcup_{b \in B} (\text{STR}'_k)^{i_b-1} ; \{ \mathfrak{A} \in \text{STR}'_k \mid b^{\mathfrak{A}} \uplus \bar{b}^{\mathfrak{A}} \neq \Delta_{|\mathfrak{A}|} \} \right) ; (\text{STR}'_k)^* \\
&\hspace{15em} \text{where } i_b \text{ is s.t. } b \in \Sigma_{i_b} , \\
\mathcal{L}_k^{\text{noms}'_L} &\triangleq \bigcup_{l \in L} \left(\left\{ \mathfrak{A} \in \text{STR}'_k \mid l^{\mathfrak{A}} = \emptyset \right\}^+ \cup ((\text{STR}'_k)^* ; \{ \mathfrak{A} \in \text{STR}'_k \mid l^{\mathfrak{A}} \not\subseteq \Delta_{|\mathfrak{A}|} \} ; (\text{STR}'_k)^*) \cup \right. \\
&\quad \left. (\text{STR}'_k)^* ; \left\{ \begin{array}{l} \mathfrak{A}_1 \dots \mathfrak{A}_n \in (\text{STR}'_k)^+ \mid \exists x, \exists y, \\ \langle x, x \rangle \in l^{\mathfrak{A}_1} \wedge \langle y, y \rangle \in l^{\mathfrak{A}_n} \\ \wedge (x \neq y \vee (x = y \wedge \exists j \in [n], x \notin |\mathfrak{A}_j|)) \end{array} \right\} ; (\text{STR}'_k)^* \right) .
\end{aligned}$$

For each of them, it is a regular language and there is a 1DFA of states $\mathcal{O}(2^k m)$ for $\mathcal{L}_k^{\text{U}'}$, $\mathcal{O}(2^k m)$ for $\mathcal{L}_k^{\text{Incon}'}$, $\mathcal{O}(2^k)$ for $\#\mathcal{L}_k^{\text{Inac}'}$, $\mathcal{O}(m)$ for $\#\mathcal{L}_k^{\top'}$, $\mathcal{O}(1)$ for $\#\mathcal{L}_k^{\smile'}$, and $\mathcal{O}(m)$ for $\#\mathcal{L}_k^{\text{tests}'_B}$. There is a 1NFA of states $\mathcal{O}(k\#L)$ for $\#\mathcal{L}_k^{\text{noms}'_L}$. Thus, under that k is fixed, for each language, there is a 1NFA such that the number of states is $\mathcal{O}(\|t\|)$. The alphabet size STR'_k is also $\mathcal{O}(\|t\|)$.

6.3.1. *The bounded intersection width fragment.* We moreover show that when the intersection width [GLL09] is fixed, the equational theory is PSPACE-complete.

Corollary 6.4. *Let $k \geq 1$. The equational theory of PCoR* terms with tests and nominals of intersection width at most k is PSPACE-complete.*

Proof. (PSPACE-hardness): Because the universality problem for regular expressions is PSPACE-complete [MS72]. (In PSPACE): Similar to Cor. 6.3, from given PCoR* terms with tests and nominals t' and s' , let t and s be the KL terms obtained by applying the translations of Sects. 6.1.1, 6.1.2 and 6.2.1. By using the automata above with $\text{iw}(t) \leq k$, we can reduce into the inclusion problem for 2AFAs, as follows: $\text{REL} \models t' \leq s'$ iff

$$[\mathcal{A}_{k+1}^{c_{\top}^* t' r c_{\top}^*}] \cap \mathcal{L}_{k+1}^{\text{U}'} \subseteq [\mathcal{A}_{k+1}^{c_{\top}^* s' r c_{\top}^*}] \cup \mathcal{L}_{k+1}^{\text{Inac}'} \cup \mathcal{L}_{k+1}^{\text{Incon}'} \cup \mathcal{L}_{k+1}^{\top'} \cup \mathcal{L}_{k+1}^{\smile'} \cup \mathcal{L}_{k+1}^{\text{tests}'_B} \cup \mathcal{L}_{k+1}^{\text{noms}'_L} .$$

Because these 2AFAs have polynomial sizes, this completes the proof by Prop. 5.6. \square

Particularly, when $k = 1$, we have the following, which slightly extends the PSPACE-decidability results of Kleene algebra with top and tests [PW23] and of Kleene algebra with top and converse [Nak23].

Corollary 6.5. *The equational theory for Kleene algebra with top, converse, tests, and nominals w.r.t. binary relations is PSPACE-complete.*

7. PROOF OF THM. 5.5: THE DECOMPOSITION THEOREM

In this section, we prove Thm. 5.5, which is the only remaining part.

Theorem 5.5 (decomposition theorem). *Let $\vec{\mathfrak{A}} = \mathfrak{A}_1 \dots \mathfrak{A}_n \in \text{STR}^+$. For all $j \in [n]$ and IKL terms $\tilde{t}, \tilde{s} \in \tilde{\mathbf{T}}_{(j)}^{\vec{\mathfrak{A}}}$, we have:*

$$\tilde{t} \longrightarrow^{(\odot^{\vec{\mathfrak{A}}}) \bullet} \tilde{s} \quad \Leftrightarrow \quad \tilde{t} (\odot_{i=1}^n \longrightarrow^{(\mathfrak{A}_i) \bullet}) \tilde{s}.$$

We first show the decomposition theorem for a subclass of runs (Lem. 7.10 in Sect. 7.1), and then we extend for IKL terms.

7.1. Decomposition theorem for local sub-series-parallel runs. In this subsection, we show the decomposition theorem for sub-series-parallel runs (sub-SP runs). In Sect. 7.1.1, we define “sub-SP”. In Sect. 7.1.2, we define “local”. In Sect. 7.1.3, we show the theorem.

7.1.1. Sub-series-parallel runs. The set SPR of *series-parallel (SP) runs* is the subclass of runs with $\langle 1, 1 \rangle$ -interface defined by:

$$G, H, J \in \text{SPR} \quad ::= \quad 1^1 \mid a_1^1 \mid G \diamond H \mid \mathfrak{f}_1^1 \diamond (G \parallel H) \diamond \mathfrak{j}_1^1 \quad (a \in \Sigma)$$

For runs G, H , we say that G' is a *sub-run* of G if there are H and J s.t. $H \diamond G' \diamond J = G$. We write $\text{sub}(G)$ for the set of all sub-runs of G . We write subSPR for the set of all *sub-series-parallel runs* (sub-SP runs): $\text{subSPR} \triangleq \bigcup_{G \in \text{SPR}} \text{sub}(G)$. We can alternatively define subSPR as the set subSPR' defined by:

$$\begin{aligned} G, H, J \in \text{subSPR}' & ::= (H^1 \diamond J^r) \mid (H \parallel J) \quad (H^1 \in \text{subSPRl}, J^1 \in \text{subSPRr}, H, J \in \text{SPR}) \\ G, H, J \in \text{subSPRl} & ::= J \mid (G^1 \parallel H^1) \diamond \mathfrak{j}_1^1 \diamond J \quad (G^1, H^1 \in \text{subSPRl}, J \in \text{SPR}) \\ G, H, J \in \text{subSPRr} & ::= J \mid J \diamond \mathfrak{f}_1^1 \diamond (G^r \parallel H^r) \quad (G^r, H^r \in \text{subSPRr}, J \in \text{SPR}) \end{aligned}$$

Proposition 7.1. $\text{subSPR} = \text{subSPR}'$.

Proof. ($\text{subSPR}' \subseteq \text{subSPR}$): First, for every $G \in \text{subSPRl}$, there is $G' \in \text{subSPRr}$ such that $G' \diamond G \in \text{SPR}$. This is shown by induction on the derivation tree of $G \in \text{subSPRl}$, as follows.

- Case $G \in \text{SPR}$: By letting $G' = 1^1$, we have $G' \diamond G = G \in \text{SPR}$.
- Case $G = (G^1 \parallel H^1) \diamond \mathfrak{j}_1^1 \diamond J$ where $G^1, H^1 \in \text{subSPRl}$ and $J \in \text{SPR}$: Let $G^r, H^r \in \text{subSPRr}$ be the ones obtained by IH w.r.t. G^1 and H^1 , respectively. Then by letting $G' = \mathfrak{f}_1^1 \diamond (G^r \parallel H^r)$, we have $G' \diamond G = (\mathfrak{f}_1^1 \diamond ((G^r \diamond G^1) \parallel (H^r \diamond H^1))) \diamond \mathfrak{j}_1^1 \diamond J \in \text{SPR}$.

Similarly, for every $G \in \text{subSPRr}$, there is $G' \in \text{subSPRl}$ s.t. $G \diamond G' \in \text{SPR}$. Finally, by induction on the derivation tree of $G \in \text{subSPR}'$, we show that for every $G \in \text{subSPR}'$, there are $H \in \text{subSPRl}$ and $J \in \text{subSPRr}$ such that $H \diamond G \diamond J \in \text{SPR}$.

- Case $G = H^1 \diamond J^r$ where $H^1 \in \text{subSPRl}$ and $J^r \in \text{subSPRr}$: Let $H^r \in \text{subSPRr}$ be s.t. $H^r \diamond H^1 \in \text{SPR}$ and let $J^1 \in \text{subSPRl}$ be s.t. $J^r \diamond J^1 \in \text{SPR}$. Then, $H^r \diamond (H^r \diamond H^1) \diamond J^1 \in \text{SPR}$.
- Case $G = (G_1 \parallel G_2)$ where $G_1, G_2 \in \text{subSPR}'$: By IH, there are $H_k \in \text{subSPRr}, J_k \in \text{subSPRl}$ s.t. $H_k \diamond G_k \diamond J_k \in \text{SPR}$ for each $k \in [1, 2]$. Then we have

$$\begin{aligned} & (\mathfrak{f}_1^1 \diamond (H_1 \parallel H_2)) \diamond (G_1 \parallel G_2) \diamond ((J_1 \parallel J_2) \diamond \mathfrak{j}_1^1) \\ & = \mathfrak{f}_1^1 \diamond ((H_1 \diamond G_1 \diamond J_1) \parallel (H_2 \diamond G_2 \diamond J_2)) \diamond \mathfrak{j}_1^1 \in \text{SPR}. \end{aligned}$$

($\text{subSPR} \subseteq \text{subSPR}'$): By induction on the derivation tree of $G_0 \in \text{SPR}$, we show $G \in \text{sub}(G_0) \implies G \in \text{subSPR}'$. We distinguish the following cases:

- Case $G_0 = 1^1$, Case $G_0 = a_1^1$: Clear, by $\text{sub}(G_0) \subseteq \text{SPR} \subseteq \text{subSPR}'$.
- Case $G_0 = H_0 \diamond J_0$ where $H_0, J_0 \in \text{SPR}$:
 - Case $G \in \text{sub}(H_0)$ or $G \in \text{sub}(J_0)$: By IH.
 - Otherwise: G is of the form: $\left(\begin{array}{c} \circ \rightarrow \boxed{H} \rightarrow \circ \\ \vdots \\ \circ \rightarrow \boxed{H} \rightarrow \circ \end{array} \rightarrow \circ \rightarrow \begin{array}{c} \boxed{J} \rightarrow \circ \\ \vdots \\ \boxed{J} \rightarrow \circ \end{array} \rightarrow \circ \right)$ where $H \in \text{sub}(H_0)$ and $J \in \text{sub}(J_0)$. By IH, $H, J \in \text{subSPR}'$. By $\text{ty}_2(H) = 1$, we have $H \in \text{subSPR}$. Similarly, by $\text{ty}_1(J) = 1$, we have $J \in \text{subSPR}$. Thus, $H \diamond J \in \text{subSPR}'$.
- Case $G_0 = \mathbf{f}_1^1 \diamond (H_0 \parallel J_0) \diamond \mathbf{j}_1^1$ where $H_0, J_0 \in \text{SPR}$: We distinguish the following cases:
 - Case $G = G_0$: By $G_0 \in \text{SPR}$, we have $G_0 \in \text{subSPR}'$.
 - Case $G = \mathbf{f}_1^1 \diamond (H \parallel J)$ where $H \in \text{sub}(H_0)$ and $J \in \text{sub}(J_0)$: By IH, $H, J \in \text{subSPR}'$. By $\text{ty}_1(H) = \text{ty}_1(J) = 1$, we have $H, J \in \text{subSPR}$. Thus, $G \in \text{subSPR} \subseteq \text{subSPR}'$.
 - Case $G = (H \parallel J) \diamond \mathbf{j}_1^1$ where $H \in \text{sub}(H_0)$ and $J \in \text{sub}(J_0)$: Similarly, $G \in \text{subSPR} \subseteq \text{subSPR}'$.
 - Case $G = (H \parallel J)$ where $H \in \text{sub}(H_0)$ and $J \in \text{sub}(J_0)$: By IH, $H, J \in \text{subSPR}'$. Thus, we have $G \in \text{subSPR}'$.

Hence, this completes the proof. \square

By Prop. 7.1, we can see that every sub-SP run can be viewed as a forest of SP runs. For instance, we can express the sub-SP run $(((((G_1 \parallel G_2) \diamond \mathbf{j}_1^1 \diamond G_3) \parallel G_4) \diamond \mathbf{j}_1^1 \diamond G_5) \diamond (G_5' \diamond \mathbf{f}_1^1 \diamond (G_3' \parallel G_4')))) \parallel (((G_6 \parallel G_7) \diamond \mathbf{j}_1^1 \diamond G_8) \diamond G_8')$ (where $G_i \in \text{SPR}$ for each i) as follows:

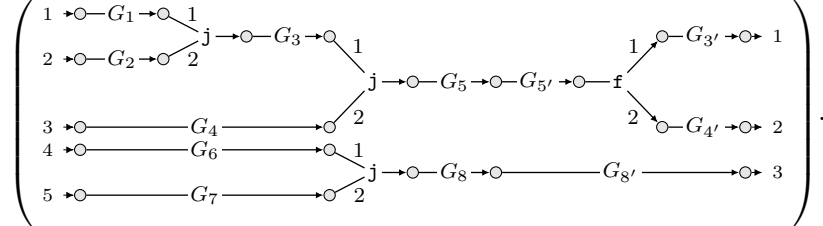

Remark 7.2. Every (sub-)SP run does not contain the four pairwise distinct vertices of the form $\left(\begin{array}{c} \circ \rightsquigarrow \circ \\ \circ \rightsquigarrow \circ \end{array} \right)$, cf. “N-free” [VTL79, p. 17][LW98]. Here, $\circ \rightsquigarrow \circ$ expresses that the target vertex is reachable from the source vertex.

Proposition 7.3. *Let \mathfrak{A} be a structure.*

- For all KL terms t , every \mathfrak{A} -run of t is an SP \mathfrak{A} -run.
- For all lKL terms \tilde{t} , every \mathfrak{A} -run of \tilde{t} is a sub-SP \mathfrak{A} -run.

Proof. By easy induction on terms. \square

7.1.2. Local runs.

Definition 7.4. Let $\vec{\mathfrak{A}} = \mathfrak{A}_1 \dots \mathfrak{A}_n$. We say that an $(\odot \vec{\mathfrak{A}})_\bullet$ -run $\tau: G \rightarrow (\odot \vec{\mathfrak{A}})_\bullet$ is *local* if for all $\langle v_1, \dots, v_k \rangle \in a^G$, there is some $i \in [n]$ s.t. $\{\tau(v_1), \dots, \tau(v_k)\} \subseteq \{[i, x]_\sim \mid x \in |\mathfrak{A}_i|\}$.

Proposition 7.5. *Let \tilde{t} be an lKL term. Every $(\odot \vec{\mathfrak{A}})_\bullet$ -run of \tilde{t} is local sub-SP.*

Proof. By Prop. 7.3 and by that it is clearly local by definition of $(\odot \vec{\mathfrak{A}})_\bullet$ -run. \square

7.1.3. *Decomposition of local sub-SP runs.* Let $\vec{\mathfrak{A}} = \mathfrak{A}_1 \dots \mathfrak{A}_n \in \text{STR}^+$. Let $\text{lsubSPR}^{(\odot \vec{\mathfrak{A}})}_\bullet$ be the set of local sub-SP $(\odot \vec{\mathfrak{A}})_\bullet$ -runs. Similarly, we use $\text{ISPR}^{(\odot \vec{\mathfrak{A}})}_\bullet$, $\text{lsubSPRl}^{(\odot \vec{\mathfrak{A}})}_\bullet$, and $\text{lsubSPRr}^{(\odot \vec{\mathfrak{A}})}_\bullet$. We now define the decompositions of local sub-SP $(\odot \vec{\mathfrak{A}})_\bullet$ -runs. For $i \in [n]$, we let $\text{lsubSPR}_{(i)}^{\vec{\mathfrak{A}}} \triangleq \{\tau \in \text{lsubSPR}^{(\odot \vec{\mathfrak{A}})}_\bullet \mid \text{ty}_1(\tau)\text{ty}_2(\tau) \in \{[(i, x)]_\sim \mid x \in |(\mathfrak{A}_i)_\bullet|\}^*\}$. For $i \in [n]$ and an $(\mathfrak{A}_i)_\bullet$ -run τ , we write $\tau_{(i)}$ for the $(\odot \vec{\mathfrak{A}})_\bullet$ -run τ in which each label x has been replaced with $[(i, x)]_\sim$. We then consider the following decomposition of $(\odot \vec{\mathfrak{A}})_\bullet$ -run.

Definition 7.6. Let $\vec{\mathfrak{A}} = \mathfrak{A}_1 \dots \mathfrak{A}_n \in \text{STR}^+$. The set $\odot_{i=1}^n \text{lsubSPR}^{(\mathfrak{A}_i)}_\bullet$ is defined as the minimal subset of $\bigcup_{i=1}^n \text{lsubSPR}_{(i)}^{\vec{\mathfrak{A}}}$ closed under the following rules:

$$\frac{\tau \in \text{lsubSPR}^{\mathfrak{A}_j}}{\tau_{(j)} \in \odot_{i=1}^n \text{lsubSPR}^{(\mathfrak{A}_i)}_\bullet} \text{ D}$$

$$\frac{\tau \in \odot_{i=1}^n \text{lsubSPR}^{(\mathfrak{A}_i)}_\bullet \quad \sigma \in \odot_{i=1}^n \text{lsubSPR}^{(\mathfrak{A}_i)}_\bullet}{\tau \diamond \sigma \in \odot_{i=1}^n \text{lsubSPR}^{(\mathfrak{A}_i)}_\bullet} \text{ T}$$

$$\frac{\tau[\bullet / \langle l, r \rangle] \in \odot_{i=1}^n \text{lsubSPR}^{(\mathfrak{A}_i)}_\bullet}{\tau[x / \langle l, r \rangle] \in \odot_{i=1}^n \text{lsubSPR}^{(\mathfrak{A}_i)}_\bullet} \text{ L.}$$

Here, $\tau[y / \langle l, r \rangle]$ denotes the $(\odot \vec{\mathfrak{A}})_\bullet$ -run τ in which $\tau(1_l^\tau)$ and $\tau(2_r^\tau)$ has been replaced with y .

We then have that every $(\odot \vec{\mathfrak{A}})_\bullet$ -run of $\bigcup_{i=1}^n \text{lsubSPR}_{(i)}^{\vec{\mathfrak{A}}}$ can be derived using the rules of Def. 7.6 (Lem. 7.10). Note that each $(\odot \vec{\mathfrak{A}})_\bullet$ -run occurring in the derivation tree should be in $\text{lsubSPR}_{(i)}^{\vec{\mathfrak{A}}}$ for some i .

Example 7.7. We recall the sequence $\vec{\mathfrak{A}} = \mathfrak{A}_1 \mathfrak{A}_2$ and the following $(\odot \vec{\mathfrak{A}})_\bullet$ -run $\tau \in \text{lsubSPR}_{(1)}^{\vec{\mathfrak{A}}}$ in Example 5.4:

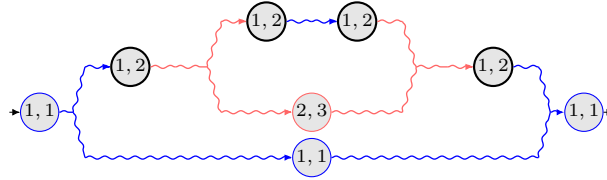

We then also have $\tau \in \odot_{i=1}^n \text{lsubSPR}^{(\mathfrak{A}_i)}_\bullet$ by the following derivation tree (cf. Example 5.4):

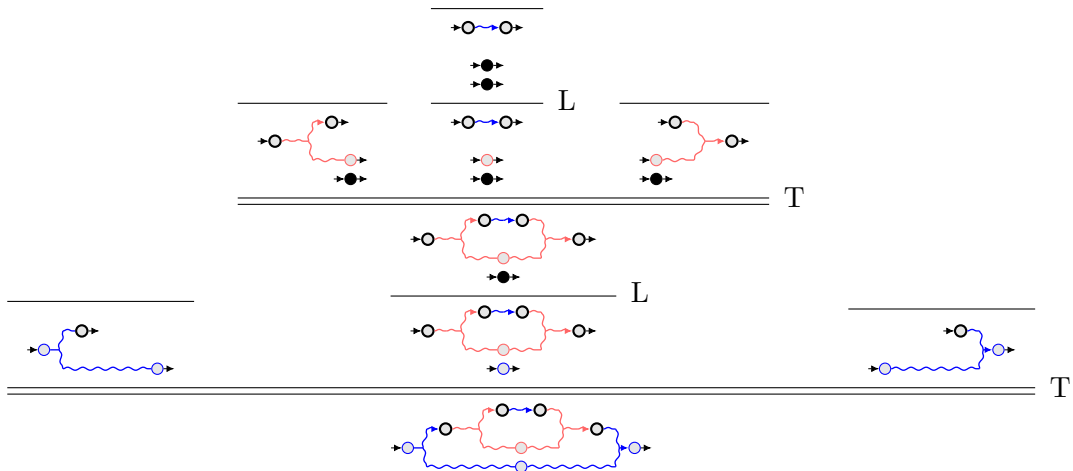

The most technical point in Example 7.7 is to find an appropriate interpolation. In the following, we show that we can always take an appropriate interpolation (Lem. 7.10).

For $\vec{\mathfrak{A}} = \mathfrak{A}_1 \dots \mathfrak{A}_n \in \text{STR}^+$ and $i \in [n]$, we consider the following three disjoint sets:

$$|\vec{\mathfrak{A}}|_{(i)} \triangleq \{[\langle i, x \rangle]_{\sim} \mid x \in |\mathfrak{A}_i|\}, \quad |\vec{\mathfrak{A}}|_{(<i)} \triangleq \left(\bigcup_{j < i} |\vec{\mathfrak{A}}|_{(j)} \right) \setminus |\vec{\mathfrak{A}}|_{(i)}, \quad |\vec{\mathfrak{A}}|_{(>i)} \triangleq \left(\bigcup_{j > i} |\vec{\mathfrak{A}}|_{(j)} \right) \setminus |\vec{\mathfrak{A}}|_{(i)}.$$

The following is an illustration of the three sets:

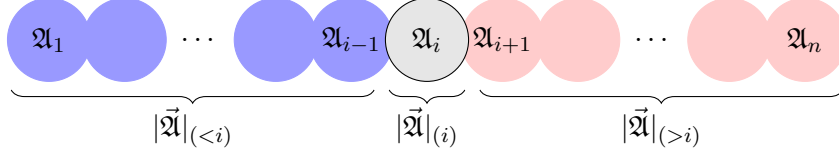

For $\tau \in \text{lsubSPR}^{(\odot \vec{\mathfrak{A}})\bullet}$, we say that τ is i -split if there are $x \in |\vec{\mathfrak{A}}|_{(<i)}$ and $y \in |\vec{\mathfrak{A}}|_{(>i)}$ occurring in the sequence $\text{ty}_1(\tau)\text{ty}_2(\tau)$. We first show that, we can decompose each i -split $\text{ISPR}^{(\odot \vec{\mathfrak{A}})\bullet}$ run into two $\text{ISPR}^{(\odot \vec{\mathfrak{A}})\bullet}$ runs such that each glued vertex is $|\vec{\mathfrak{A}}|_{(i)}$ -labeled.

Lemma 7.8. *Let $\vec{\mathfrak{A}} = \mathfrak{A}_1 \dots \mathfrak{A}_n \in \text{STR}^+$ and $i \in [n]$. For all i -split $\tau \in \text{ISPR}^{(\odot \vec{\mathfrak{A}})\bullet}$, there are non-empty σ and ρ such that $\tau = \sigma \diamond \rho$ and for each k , we have $\sigma(2_k^\sigma) \in |\vec{\mathfrak{A}}|_{(i)}$.*

Proof. By induction on the derivation tree of $G \in \text{SPR}$ (where $\tau: G \rightarrow (\odot \vec{\mathfrak{A}})\bullet$).

- Case $\tau = a_1^{x,y}$, Case $\tau = 1^x$: Because τ is local, this case does not occur.
- Case $\tau = (\text{---}\circ\text{---}\tau'\text{---}\textcircled{z}\text{---}\tau''\text{---}\circ\text{---})$: We distinguish the following cases:
 - Case $z \in |\vec{\mathfrak{A}}|_{(i)}$: By letting $\sigma = \tau'$ and $\rho = \tau''$, this case has been proved.
 - Otherwise: Because z is $|\vec{\mathfrak{A}}|_{(<i)}$ - or $|\vec{\mathfrak{A}}|_{(>i)}$ -labeled vertex, either τ' or τ'' is i -split.
 - * Case τ' is i -split: Let σ' and ρ' be the ones obtained by IH w.r.t. τ' . Then by letting $\sigma = \sigma'$ and $\rho = \rho' \diamond \tau''$, this case has been proved.
 - * Case τ'' is i -split: Similarly, let σ'' and ρ'' be the ones obtained by IH w.r.t. τ'' . Then by letting $\sigma = \tau' \diamond \sigma''$ and $\rho = \rho''$, this case has been proved.
- Case $\tau = \mathfrak{f}_1^x \diamond (\tau' \parallel \tau'') \diamond \mathfrak{j}_1^y$: Since both τ' and τ'' are i -split, let σ' and ρ' be the ones obtained by IH w.r.t. τ' and let σ'' and ρ'' be the ones obtained by IH w.r.t. τ'' . Then by letting $\sigma = \mathfrak{f}_1^x \diamond (\sigma' \parallel \sigma'')$ and $\rho = (\rho' \parallel \rho'') \diamond \mathfrak{j}_1^y$, this case has been proved.

Hence, this completes the proof. \square

We then extend the lemma above for (slightly specialized) lsubSPR .

Lemma 7.9 (interpolation lemma). *Let $\vec{\mathfrak{A}} = \mathfrak{A}_1 \dots \mathfrak{A}_n \in \text{STR}^+$ and let $i \in [n]$. For*

$$\text{all } \tau \in \text{lsubSPR}_{(i)}^{\vec{\mathfrak{A}}} \text{ of the form } \left(\begin{array}{c} 1 \rightarrow \textcircled{x_1} \xrightarrow{a_1} \textcircled{x'_1} \rightarrow \boxed{\tau_0} \rightarrow \textcircled{y'_1} \xrightarrow{b_1} \textcircled{y_1} \rightarrow 1 \\ \vdots \\ n \rightarrow \textcircled{x_n} \xrightarrow{a_n} \textcircled{x'_n} \rightarrow \boxed{\tau_0} \rightarrow \textcircled{y'_m} \xrightarrow{b_m} \textcircled{y_m} \rightarrow m \end{array} \right) \text{ s.t. } \tau_0 \text{ is}$$

i -split, there are non-empty σ and ρ such that $\tau = \sigma \diamond \rho$ and $\sigma, \rho \in \text{lsubSPR}_{(i)}^{\vec{\mathfrak{A}}}$.

Proof. For short, for i, j , let $a^{[i,j]} \triangleq a_1^{x_i, x'_i} \parallel \dots \parallel a_1^{x_j, x'_j}$ and let $b^{[i,j]} \triangleq b_1^{y_i, y'_i} \parallel \dots \parallel b_1^{y_j, y'_j}$. If $\tau_0 = (\sigma_0 \diamond \rho_0)$ for some $\sigma_0, \rho_0 \in \text{lsubSPR}^{(\odot \vec{\mathfrak{A}})\bullet}$, then by letting $\sigma = (a^{[1, n']} \diamond \sigma_0 \diamond b^{[1, m']}) \parallel 1^{x_{n'+1} \dots x_n}$ and $\rho = 1^{y_1 \dots y_m} \parallel (a^{[n'+1, n]} \diamond \rho_0 \diamond b^{[m'+1, m]})$ where n' is the number of source vertices of σ_0 and m' is the number of the number of target vertices of σ_0 , this case has been

proved. Otherwise, $\tau_0 = (\sigma_0 \diamond \rho_0)$ for some $\sigma_0 \in \text{lsubSPR}^{(\odot \vec{\mathfrak{A}})} \bullet$ and $\rho_0 \in \text{lsubSPR}^{(\odot \vec{\mathfrak{A}})} \bullet$. Then σ_0 and ρ_0 can be viewed as a tree of $\text{ISPR}^{(\odot \vec{\mathfrak{A}})} \bullet$ runs. Let v_k be such vertices in the tree and let z_k be the label of v_k . Let $z_{<}$ and $z_{>}$ be an $|\vec{\mathfrak{A}}|_{(<i)}$ -labeled vertex and an $|\vec{\mathfrak{A}}|_{(>i)}$ -labeled vertex in source or target vertices of τ (as τ is i -split). For instance, we consider the following σ_0 and ρ_0 (where $z_{<} = z_2$ and $z_{>} = z_{15}$):

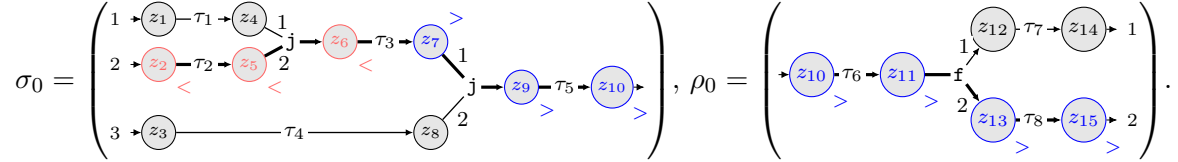

We distinguish the following cases:

- Case $z_k \in |\vec{\mathfrak{A}}|_{(i)}$ for some v_k on σ_0 : By letting σ and ρ be such that $\tau = \sigma' \diamond \rho'$ and σ' consists of the edges on the left of z_k , this case has been proved. For instance, if $z_6 \in |\vec{\mathfrak{A}}|_{(i)}$

$$\text{in the instance above, then } \sigma = \left(\begin{array}{c} 1 \rightarrow x_1 \xrightarrow{a_1} z_1 \xrightarrow{\tau_1} z_4 \xrightarrow{1} z_6 \rightarrow 1 \\ 2 \rightarrow x_2 \xrightarrow{a_2} z_2 \xrightarrow{\tau_2} z_5 \xrightarrow{2} z_6 \rightarrow 1 \\ 3 \rightarrow x_3 \rightarrow z_3 \end{array} \right).$$

- Case $z_k \in |\vec{\mathfrak{A}}|_{(i)}$ for some v_k on ρ_0 : In the same way as above.
- Otherwise, every z_k is either $|\vec{\mathfrak{A}}|_{(<i)}$ - or $|\vec{\mathfrak{A}}|_{(>i)}$ -labeled. We consider a path between $z_{<}$ and $z_{>}$ (the bold edges in the above). Then, on the path, there is k such that there are an $|\vec{\mathfrak{A}}|_{(<i)}$ -labeled vertex and an $|\vec{\mathfrak{A}}|_{(>i)}$ -labeled vertex in source or target vertices of τ_k (e.g., in the instance above, τ_3 is an expected $\text{ISPR}^{(\odot \vec{\mathfrak{A}})} \bullet$ run where each $<$ and $>$ indicates $|\vec{\mathfrak{A}}|_{(<i)}$ -labeled and $|\vec{\mathfrak{A}}|_{(>i)}$ -labeled, respectively.) We distinguish the following cases:
 - Case τ_k is on σ_0 : Let σ_k and ρ_k be the ones obtained from τ_k by Lem. 7.8. Let $\sigma', \rho', \vec{z}, \vec{z}'$ be such that $\sigma = \sigma' \diamond (1^{\vec{z}} \parallel \tau_k \parallel 1^{\vec{z}'}) \diamond \rho'$ and σ' consists of the edges on the left of the source of τ_k . Then by letting $\sigma = \sigma' \diamond (1^{\vec{z}} \parallel \sigma_k \parallel 1^{\vec{z}'})$ and $\rho = (1^{\vec{z}} \parallel \rho_k \parallel 1^{\vec{z}'}) \diamond \rho' \diamond \rho_0$, this case has been proved.
 - Otherwise (Case τ_k is on ρ_0): In the same way as above.

Hence, this completes the proof. \square

Using Lem. 7.9, we can show the decomposition theorem for local sub-SP runs, as follows.

Lemma 7.10 (decomposition theorem for local sub-SP runs). *Let $\vec{\mathfrak{A}} = \mathfrak{A}_1 \dots \mathfrak{A}_n \in \text{STR}^+$.*

$$\left(\bigcup_{i=1}^n \text{lsubSPR}_{(i)}^{\vec{\mathfrak{A}}} \right) = \left(\odot_{i=1}^n \text{lsubSPR}^{\mathfrak{A}_i} \right).$$

Proof. (\supseteq): Trivial, by the definition of them. (\subseteq): We show that for all $i \in [n]$, $\tau \in \text{lsubSPR}_{(i)}^{\vec{\mathfrak{A}}} \Rightarrow \tau \in \left(\odot_{i=1}^n \text{lsubSPR}^{\mathfrak{A}_i} \right)$, by induction on the number of edges of τ . We distinguish the following cases.

- Case τ has no edges: Then $\tau = 1^{\vec{z}}$. By the rule (R), this case has been proved.
- Case there is an a -labeled edge of \mathfrak{A}_i adjacent to a source vertex:
 - Case $a \in \Sigma$: Then $\tau = a_k^{\vec{z}, \vec{z}'} \diamond \tau'$ where $\vec{z}, \vec{z}' \in |\vec{\mathfrak{A}}|_{(i)}^+$. We then have:

$$\frac{\frac{\overline{a_k^{\vec{z}, \vec{z}'}}}{\tau'} \text{ D}}{a_k^{\vec{z}, \vec{z}'} \diamond \tau'} \text{ T} \quad \equiv \quad \text{(IH)}$$

- Case $a = \mathbf{f}$: In the same way as above.
- Case $a = \mathbf{j}$: Then $\tau = ((1^{\vec{z}} \parallel (1^z \parallel \rho) \parallel 1^{\vec{z}'})) \diamond \mathbf{j}_k^{\vec{z}\vec{z}'}) \diamond \tau'$ or $\tau = ((1^{\vec{z}} \parallel (\rho \parallel 1^z) \parallel 1^{\vec{z}'})) \diamond \mathbf{j}_k^{\vec{z}\vec{z}'}) \diamond \tau'$ where $\rho \in \text{lsubSPR}_{(i)}^{\vec{\mathfrak{A}}}$, $\vec{z}\vec{z}' \in |\vec{\mathfrak{A}}_{(i)}^+|$, and $k = \|\vec{z}\| + 1$. Then we have:

$$\frac{\frac{\overline{1^{\vec{z}} \parallel \rho' \parallel 1^{\vec{z}'}} \text{ (IH)}}{\tau'} \text{ D}}{\overline{((1^{\vec{z}} \parallel \rho' \parallel 1^{\vec{z}'}) \diamond \mathbf{j}_k^{\vec{z}\vec{z}'}) \diamond \tau'}} \text{ T} \quad \equiv \quad \text{(IH)} \quad \text{where } \rho' = 1^z \parallel \rho \text{ or } \rho' = \rho \parallel 1^z.$$

- Case there is an edge of \mathfrak{A}_i adjacent to a target vertex: Similar to the case above.
- Otherwise, after applying the rule (L) for each vertex on source and target vertices, $\tau = \mathbf{1}^{\bullet \cdots \bullet} \parallel (\tau' \diamond \tau'' \diamond \tau''') \parallel \mathbf{1}^{\bullet \cdots \bullet}$ where

$$\tau' = \left(\begin{array}{ccc} \circlearrowleft x'_1 \rightarrow a_1 \rightarrow \circlearrowright x_1 \\ \vdots \\ \circlearrowleft x'_n \rightarrow a_n \rightarrow \circlearrowright x_n \end{array} \right), \tau'' = \left(\begin{array}{ccc} \circlearrowleft x_1 & \boxed{\tau''} & \circlearrowright y_1 \\ \vdots & & \vdots \\ \circlearrowleft x_n & & \circlearrowright y_m \end{array} \right), \tau''' = \left(\begin{array}{ccc} \circlearrowleft y_1 \rightarrow b_1 \rightarrow \circlearrowright y'_1 \\ \vdots \\ \circlearrowleft y_m \rightarrow b_m \rightarrow \circlearrowright y'_m \end{array} \right).$$

Here, $n, m \geq 1$ (as τ has some edge by the first case) and $x_1, \dots, x_n, y_1, \dots, y_m \in |\vec{\mathfrak{A}}_{(<i)}| \cup |\vec{\mathfrak{A}}_{(>i)}|$ (by the second and third cases). We then distinguish the following cases:

- Case $x_1, \dots, x_n, y_1, \dots, y_m \in |\vec{\mathfrak{A}}_{(<i)}|$: Let $j < i$ be the maximum j such that some edge of $a_1, \dots, a_n, b_1, \dots, b_m$ occurs in \mathfrak{A}_j . Let σ' and ρ' be such that $\tau' = \sigma' \diamond \rho'$ and σ' contains edges of \mathfrak{A}_j . Similarly, let σ''' and ρ''' be such that $\tau''' = \sigma''' \diamond \rho'''$ and ρ''' contains edges of \mathfrak{A}_j . Then either σ' or ρ''' is not empty and $\sigma', \rho' \diamond \tau'' \diamond \sigma''', \rho''' \in \text{lsubSPR}_{(j)}^{\vec{\mathfrak{A}}}$ ($x_1, \dots, x_n, y_1, \dots, y_m \in |\vec{\mathfrak{A}}_{(j)}|$ holds by the maximality of j). Then we have:

$$\frac{\frac{\overline{\mathbf{1}^{\bullet \cdots \bullet} \parallel \sigma' \parallel \mathbf{1}^{\bullet \cdots \bullet}} \text{ (IH)}}{\tau'} \text{ D}}{\overline{\mathbf{1}^{\bullet \cdots \bullet} \parallel (\sigma' \diamond \rho' \diamond \tau'' \diamond \sigma''' \diamond \rho''') \parallel \mathbf{1}^{\bullet \cdots \bullet}}} \text{ T} \quad \equiv \quad \frac{\overline{\mathbf{1}^{\bullet \cdots \bullet} \parallel \rho' \parallel \mathbf{1}^{\bullet \cdots \bullet}} \text{ (IH)}}{\tau'} \text{ D} \quad \equiv \quad \frac{\overline{\mathbf{1}^{\bullet \cdots \bullet} \parallel \rho''' \parallel \mathbf{1}^{\bullet \cdots \bullet}} \text{ (IH)}}{\tau'}$$

- Case $x_1, \dots, x_n, y_1, \dots, y_m \in |\vec{\mathfrak{A}}_{(>i)}|$: In the same way as above.
- Otherwise, by the interpolation lemma (Lem. 7.9), there are non-empty σ and ρ such that $\tau = \mathbf{1}^{\bullet \cdots \bullet} \parallel (\sigma \diamond \rho) \parallel \mathbf{1}^{\bullet \cdots \bullet}$ and $\sigma, \rho \in \text{lsubSPR}_{(i)}^{\vec{\mathfrak{A}}}$. Thus we have:

$$\frac{\overline{\mathbf{1}^{\bullet \cdots \bullet} \parallel \sigma \parallel \mathbf{1}^{\bullet \cdots \bullet}} \text{ (IH)}}{\tau} \text{ D} \quad \equiv \quad \frac{\overline{\mathbf{1}^{\bullet \cdots \bullet} \parallel \rho \parallel \mathbf{1}^{\bullet \cdots \bullet}} \text{ (IH)}}{\tau} \text{ D} \quad \equiv \quad \frac{\overline{\mathbf{1}^{\bullet \cdots \bullet} \parallel (\sigma \diamond \rho) \parallel \mathbf{1}^{\bullet \cdots \bullet}} \text{ (IH)}}{\tau}$$

Hence, this completes the proof. \square

Remark 7.11 (On non-sub-SP runs). If τ is a local $\odot \vec{\mathfrak{A}}$ -run but not a sub-SP run, we may not be able to decompose τ (and hence, Lem. 7.10 fails for non-sub-SP runs). For instance,

we cannot decompose for the following τ :

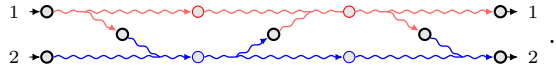

7.2. Properties of derivatives. In this subsection, we get back to derivatives, and we show some properties of derivatives. To prove Thm. 5.5, we will use them for each rule: Lem. 7.12 for (D), Lem. 7.13 for (L), and Lem. 7.14 for (T), respectively.

Lemma 7.12. *Let $\vec{\mathfrak{A}} = \mathfrak{A}_1 \dots \mathfrak{A}_n \in \text{STR}^+$ and $j \in [n]$. For all lKL terms \tilde{t}, \tilde{s} and $(\mathfrak{A}_j)_\bullet$ -runs τ , if $\tilde{t}_{(j)} \xrightarrow{\tau_{(j)}}^{\odot \vec{\mathfrak{A}}_\bullet} \tilde{s}_{(j)}$, then $\tilde{t} \xrightarrow{\tau}^{\mathfrak{A}_j \bullet} \tilde{s}$.*

Proof. By easy induction on the derivation tree w.r.t. Def. 4.3. Note that $\langle \tilde{t}_{(j)}, \tau_{(j)}, \tilde{s}_{(j)} \rangle$ and $\langle \tilde{t}, \tau, \tilde{s} \rangle$ are the same up to changing the names of vertices' labels. \square

Lemma 7.13. *Let \mathfrak{A} be a structure. For all lKL terms \tilde{t} and \tilde{s} , \mathfrak{A}_\bullet -runs τ , l and r such that $1_l^\tau = 2_r^\tau$, and $x, y \in |\mathfrak{A}_\bullet|$, if $\tilde{t}[x/l] \xrightarrow{\tau[x/\langle l, r \rangle]}^{\mathfrak{A}_\bullet} \tilde{s}[x/r]$, then $\tilde{t}[y/l] \xrightarrow{\tau[y/\langle l, r \rangle]}^{\mathfrak{A}_\bullet} \tilde{s}[y/r]$.*

Proof. By easy induction on the derivation tree w.r.t. Def. 4.3. Since $1_l^\tau = 2_r^\tau = v$ for some v , the label x is not used on the derivation tree of $\xrightarrow{\tau[x/\langle l, r \rangle]}^{\mathfrak{A}_\bullet}$, thus we can replace the label of v with any label (in particular, with \bullet). \square

Lemma 7.14. *Let \mathfrak{A} be a structure. For all lKL terms \tilde{t} and \tilde{s} and \mathfrak{A} -runs τ and σ , if $\tilde{t} \xrightarrow{\tau \circ \sigma}^{\mathfrak{A}} \tilde{s}$, then there exists some lKL term \tilde{u} such that $\tilde{t} \xrightarrow{\tau}^{\mathfrak{A}} \tilde{u}$ and $\tilde{u} \xrightarrow{\sigma}^{\mathfrak{A}} \tilde{s}$.*

To prove Lem. 7.14, we use the following alternative definition of $(\xrightarrow{\tau}^{\mathfrak{A}})$. Intuitively, this is the ‘‘big-step’’ version of $(\xrightarrow{\tau}^{\mathfrak{A}})$, obtained by eliminating the transitivity rule (T).

Definition 7.15. Let \mathfrak{A} be a structure. The derivative relation $\tilde{t} \rightsquigarrow_\rho^{\mathfrak{A}} \tilde{s}$, where \tilde{t} and \tilde{s} are lKL terms and ρ is an \mathfrak{A} -run, is defined as the minimal relation closed under the rules:

$$\begin{array}{c}
\frac{\langle x, y \rangle \in a^{\mathfrak{A}}}{@x.a \rightsquigarrow_{a_1}^{\mathfrak{A}} @y.1} \text{ for } a \in \Sigma \quad \frac{@x.t \rightsquigarrow_\rho^{\mathfrak{A}} \tilde{t}'}{@x.t ; s \rightsquigarrow_\rho^{\mathfrak{A}} \tilde{t}' ;_1 s} \quad \frac{@x.t \rightsquigarrow_\rho^{\mathfrak{A}} \tilde{t}' \quad E_z(\tilde{t}') \quad @z.s \rightsquigarrow_{\rho'}^{\mathfrak{A}} \tilde{s}'}{@x.t ; s \rightsquigarrow_{\rho \circ \rho'}^{\mathfrak{A}} \tilde{s}'} \\
\frac{@x_0.t \rightsquigarrow_{\rho_0}^{\mathfrak{A}} \tilde{t}'_1 \quad E_{x_1}(\tilde{t}'_1) \quad \dots \quad @x_{n-1}.t \rightsquigarrow_{\rho_{n-1}}^{\mathfrak{A}} \tilde{t}'_n \quad E_{x_n}(\tilde{t}'_n) \quad @x_n.t \rightsquigarrow_{\rho_n}^{\mathfrak{A}} \tilde{t}'_{n+1}}{@x_0.t^* \rightsquigarrow_{\rho_0 \circ \dots \circ \rho_n}^{\mathfrak{A}} \tilde{t}'_{n+1} ;_1 t^*} \\
\frac{@x_0.t \rightsquigarrow_{\rho_0}^{\mathfrak{A}} \tilde{t}'_1 \quad E_{x_1}(\tilde{t}'_1) \quad \dots \quad @x_{n-1}.t \rightsquigarrow_{\rho_{n-1}}^{\mathfrak{A}} \tilde{t}'_n \quad E_{x_n}(\tilde{t}'_n)}{@x_0.t^* \rightsquigarrow_{\rho_0 \circ \dots \circ \rho_{n-1}}^{\mathfrak{A}} @x_n.t^*} \\
\frac{@x.t \rightsquigarrow_\rho^{\mathfrak{A}} \tilde{t}' \quad @x.s \rightsquigarrow_\rho^{\mathfrak{A}} \tilde{s}' \quad @x.t \rightsquigarrow_\rho^{\mathfrak{A}} \tilde{t}' \quad @x.s \rightsquigarrow_{\rho'}^{\mathfrak{A}} \tilde{s}' \quad E_z(\tilde{t}') \quad E_z(\tilde{s}')}{@x.t + s \rightsquigarrow_\rho^{\mathfrak{A}} \tilde{t}' \quad @x.t + s \rightsquigarrow_\rho^{\mathfrak{A}} \tilde{s}' \quad @x.t \cap s \rightsquigarrow_{\mathfrak{f}_1^\tau \circ (\rho \parallel \rho') \circ \mathfrak{j}_1^{\tilde{t}}}^{\mathfrak{A}} @z.1} \\
\frac{@x.t \rightsquigarrow_\rho^{\mathfrak{A}} \tilde{t}' \quad @x.s \rightsquigarrow_{\rho'}^{\mathfrak{A}} \tilde{s}' \quad \tilde{t} \rightsquigarrow_\rho^{\mathfrak{A}} \tilde{t}' \quad \tilde{s} \rightsquigarrow_{\rho'}^{\mathfrak{A}} \tilde{s}' \quad E_z(\tilde{t}') \quad E_z(\tilde{s}') \quad \tilde{t} \rightsquigarrow_\rho^{\mathfrak{A}} \tilde{t}' \quad \tilde{s} \rightsquigarrow_{\rho'}^{\mathfrak{A}} \tilde{s}'}{@x.t \cap s \rightsquigarrow_{\mathfrak{f}_1^\tau \circ (\rho \parallel \rho')}^{\mathfrak{A}} \tilde{t}' \cap_1 \tilde{s}'} \\
\frac{\tilde{t} \rightsquigarrow_\rho^{\mathfrak{A}} \tilde{t}' \quad @z.1}{\tilde{t} \cap_1 \tilde{s} \rightsquigarrow_{(\rho \parallel \rho')}^{\mathfrak{A}} \tilde{t}' \cap_1 \tilde{s}'} \quad \frac{\tilde{t} \rightsquigarrow_\rho^{\mathfrak{A}} \tilde{t}' \quad \tilde{s} \rightsquigarrow_{\rho'}^{\mathfrak{A}} \tilde{s}' \quad E_z(\tilde{t}') \quad E_z(\tilde{s}')}{\tilde{t} \cap_1 \tilde{s} \rightsquigarrow_{(\rho \parallel \rho')}^{\mathfrak{A}} \tilde{t}' \cap_1 \tilde{s}'} \\
\frac{\tilde{t} \rightsquigarrow_\rho^{\mathfrak{A}} \tilde{t}' \quad @z.s \rightsquigarrow_{\rho'}^{\mathfrak{A}} \tilde{s}}{\tilde{t} ;_1 s \rightsquigarrow_\rho^{\mathfrak{A}} \tilde{t}' ;_1 s} \quad \frac{\tilde{t} \rightsquigarrow_\rho^{\mathfrak{A}} \tilde{t}' \quad E_z(\tilde{t}') \quad @z.s \rightsquigarrow_{\rho'}^{\mathfrak{A}} \tilde{s}}{\tilde{t} ;_1 s \rightsquigarrow_{\rho \circ \rho'}^{\mathfrak{A}} \tilde{s}} \quad \frac{}{\tilde{t} \rightsquigarrow_{1^{\text{lab}(\tilde{t})}}^{\mathfrak{A}} \tilde{t}} \quad (\text{R})
\end{array}$$

Proposition 7.16 (Appendix B). *For all \mathfrak{A} -runs τ , we have: $(\xrightarrow{\tau}^{\mathfrak{A}}) = (\rightsquigarrow_\tau^{\mathfrak{A}})$.*

Proof Sketch. (\supseteq) : Using the transitivity rule (T), we have that each rule of $\rightsquigarrow_\tau^{\mathfrak{A}}$ is admissible

in $\xrightarrow{\tau}^{\mathfrak{A}}$. (\subseteq) : We have that the transitivity rule $\frac{\tilde{t} \rightsquigarrow_\tau^{\mathfrak{A}} \tilde{u} \quad \tilde{u} \rightsquigarrow_\sigma^{\mathfrak{A}} \tilde{s}}{\tilde{t} \rightsquigarrow_{\tau \circ \sigma}^{\mathfrak{A}} \tilde{s}}$ T is admissible in $\rightsquigarrow_\tau^{\mathfrak{A}}$, which is shown by induction on the size of the derivation tree. \square

Proof of Lem. 7.14. By induction on the derivation tree of $\rightsquigarrow_{\tau}^{\mathfrak{A}}$.

- Case $\frac{\langle x, y \rangle \in a^{\mathfrak{A}}}{@x.a \rightsquigarrow_{a_1^{x,y}} @y.1}$: Then $\tau \diamond \sigma = a_1^{x,y}$. we distinguish the following sub-cases:
 - Case $\tau = a_1^{x,y}$ and $\sigma = 1^y$: By letting $\tilde{u} = @y.1$.
 - Case $\tau = 1^x$ and $\sigma = a_1^{x,y}$: By letting $\tilde{u} = @x.a$.
- Case $\frac{@x.t \rightsquigarrow_{\rho} \tilde{t}'}{@x.t + s \rightsquigarrow_{\rho} \tilde{t}'}$: By IH, there is some \tilde{t}'' s.t. $@x.t \rightsquigarrow_{\tau} \tilde{t}''$ and $\tilde{t}'' \rightsquigarrow_{\sigma} \tilde{t}'$. We then have $\frac{@x.t \rightsquigarrow_{\tau} \tilde{t}''}{@x.t + s \rightsquigarrow_{\tau} \tilde{t}''}$. Hence by letting $\tilde{u} = \tilde{t}''$, this case has been proved.
- Case $\frac{@x.s \rightsquigarrow_{\rho} \tilde{s}'}{@x.t + s \rightsquigarrow_{\rho} \tilde{s}'}$: Similar to the case above.
- Case $\frac{@x.t \rightsquigarrow_{\rho} \tilde{t}'}{@x.t ; s \rightsquigarrow_{\rho} \tilde{t}' ;_1 s}$: By IH, there is some \tilde{t}'' s.t. $@x.t \rightsquigarrow_{\tau} \tilde{t}''$ and $\tilde{t}'' \rightsquigarrow_{\sigma} \tilde{t}'$. Then,

$$\frac{\frac{@x.t \rightsquigarrow_{\tau} \tilde{t}''}{@x.t ; s \rightsquigarrow_{\tau} \tilde{t}'' ;_1 s}}{\tilde{t}'' ;_1 s \rightsquigarrow_{\sigma} \tilde{t}' ;_1 s}}{\tilde{t}'' \rightsquigarrow_{\sigma} \tilde{t}'}$$

Thus by letting $\tilde{u} = \tilde{t}'' ;_1 s$, this case has been proved.

- Case $\frac{@x.t \rightsquigarrow_{\rho} \tilde{t}' \quad E_z(\tilde{t}') \quad @z.s \rightsquigarrow_{\rho'} \tilde{s}'}{@x.t ; s \rightsquigarrow_{\rho \circ \rho'} \tilde{s}'}$: We distinguish the following cases:
 - Case $\rho = \tau \diamond \rho''$ (and $\sigma = \rho'' \diamond \rho'$): By IH, there is \tilde{t}'' s.t. $@x.t \rightsquigarrow_{\tau} \tilde{t}''$ and $\tilde{t}'' \rightsquigarrow_{\rho''} \tilde{t}'$. Then, $\frac{\tilde{t}'' \rightsquigarrow_{\rho''} \tilde{t}' \quad E_z(\tilde{t}') \quad @z.s \rightsquigarrow_{\rho'} \tilde{s}'}{\tilde{t}'' \rightsquigarrow_{\rho'' \diamond \rho'} \tilde{s}'}$. By letting $\tilde{u} = \tilde{t}''$, this case has been proved.
 - Case $\rho' = \rho'' \diamond \sigma$ (and $\tau = \rho \diamond \rho''$): By IH, there is \tilde{s}'' s.t. $@z.s \rightsquigarrow_{\rho''} \tilde{s}''$ and $\tilde{s}'' \rightsquigarrow_{\sigma} \tilde{s}'$. Then, $\frac{@x.t \rightsquigarrow_{\rho} \tilde{t}' \quad E_z(\tilde{t}') \quad @z.s \rightsquigarrow_{\rho''} \tilde{s}''}{@x.t \rightsquigarrow_{\rho \circ \rho''} \tilde{s}''}$. By letting $\tilde{u} = \tilde{s}''$, this case has been proved.
- Case $\frac{\tilde{t} \rightsquigarrow_{\rho} \tilde{t}'}{\tilde{t} ;_1 u \rightsquigarrow_{\rho} \tilde{t}' ;_1 u}$, Case $\frac{\tilde{t} \rightsquigarrow_{\rho} \tilde{t}' \quad E_z(\tilde{t}') \quad @z.s \rightsquigarrow_{\rho'} \tilde{s}'}{\tilde{t} ;_1 s \rightsquigarrow_{\rho \circ \rho'} \tilde{s}'}$: Similar to the two cases above.
- Case $\frac{@x_0.t \rightsquigarrow_{\rho_0} \tilde{t}'_1 \quad E_{x_1}(\tilde{t}'_1) \quad \dots \quad @x_{n-1}.t \rightsquigarrow_{\rho_{n-1}} \tilde{t}'_n \quad E_{x_n}(\tilde{t}'_n) \quad @x_n.t \rightsquigarrow_{\rho_n} \tilde{t}'_{n+1}}{@x_0.t^* \rightsquigarrow_{\rho_0 \diamond \dots \diamond \rho_n} \tilde{t}'_{n+1} ;_1 t^*}$:

Then there is some $i \in [0, n]$ s.t. $\rho_i = \rho'_i \diamond \rho''_i$, $\tau = \rho_0 \diamond \dots \diamond \rho_{i-1} \diamond \rho'_i$, and $\sigma = \rho''_i \diamond \rho_{i+1} \diamond \dots \diamond \rho_n$. By IH, there is some \tilde{u}' s.t. $@x_i.t_i \rightsquigarrow_{\rho'_i} \tilde{u}'$ and $\tilde{u}' \rightsquigarrow_{\rho''_i} \tilde{t}'_{i+1}$. We then have:

$$\frac{\frac{@x_0.t \rightsquigarrow_{\rho_0} \tilde{t}'_1 \quad E_{x_1}(\tilde{t}'_1) \quad \dots \quad @x_{i-1}.t \rightsquigarrow_{\rho_{i-1}} \tilde{t}'_i \quad E_{x_i}(\tilde{t}'_i) \quad @x_i.t \rightsquigarrow_{\rho'_i} \tilde{u}'}{@x_0.t^* \rightsquigarrow_{\rho_0 \diamond \dots \diamond \rho_{i-1} \diamond \rho'_i} \tilde{u}' ;_1 t^*}}{\frac{@x_{i+1}.t \rightsquigarrow_{\rho_{i+1}} \tilde{t}'_{i+2} \quad E_{x_{i+2}}(\tilde{t}'_{i+2}) \quad \dots \quad E_{x_n}(\tilde{t}'_n) \quad @x_n.t \rightsquigarrow_{\rho_n} \tilde{t}'_{n+1}}{@x_{i+1}.t^* \rightsquigarrow_{\rho_{i+1} \diamond \dots \diamond \rho_n} \tilde{t}'_{n+1} ;_1 t^*}}{\tilde{u}' ;_1 t^* \rightsquigarrow_{\rho'_i \diamond \rho_{i+1} \diamond \dots \diamond \rho_n} \tilde{t}'_{n+1} ;_1 t^*}}$$

Hence by letting $\tilde{u} = \tilde{u}' ;_1 t^*$, this case has been proved.

- Case $\frac{\textcircled{x}_0.t \rightsquigarrow_{\rho_0}^{\mathfrak{A}} \tilde{t}'_1 \ E_{x_1}(\tilde{t}'_1) \ \dots \ \textcircled{x}_{n-1}.t \rightsquigarrow_{\rho_{n-1}}^{\mathfrak{A}} \tilde{t}'_n \ E_{x_n}(\tilde{t}'_n)}{\textcircled{x}_0.t^* \rightsquigarrow_{\rho_0 \diamond \dots \diamond \rho_{n-1}}^{\mathfrak{A}} \textcircled{x}_n.t^*}$: Similar to the case above.
- Case $\frac{\textcircled{x}.t \rightsquigarrow_{\rho'} \tilde{t}' \quad E_z(\tilde{t}') \quad \textcircled{x}.s \rightsquigarrow_{\rho''} \tilde{s}' \quad E_z(\tilde{s}')}{\textcircled{x}.t \cap s \rightsquigarrow_{\mathfrak{f}_1^x \diamond (\rho' \parallel \rho'') \diamond j_1^z} \textcircled{z}.1}$: We distinguish the following cases:
 - Case $\tau = \mathfrak{f}_1^x \diamond (\rho' \parallel \rho'') \diamond j_1^z$ and $\sigma = 1^z$: By $\textcircled{x}.t \cap s \rightsquigarrow_{\tau} \textcircled{z}.1$ and $\textcircled{z}.1 \rightsquigarrow_{\sigma} \textcircled{z}.1$.
 - Case $\tau = 1^x$ and $\sigma = \mathfrak{f}_1^x \diamond (\rho' \parallel \rho'') \diamond j_1^z$: Similar to the case above.
 - Case $\tau = \mathfrak{f}_1^x \diamond (\tau' \parallel \tau'')$ and $\sigma = (\sigma' \parallel \sigma'') \diamond j_1^z$ (then, $\rho' = \tau' \diamond \sigma'$ and $\rho'' = \tau'' \diamond \sigma''$): By IH with $\rho' = \tau' \diamond \sigma'$, there is some \tilde{t}'' s.t. $\textcircled{x}.t \rightsquigarrow_{\tau'} \tilde{t}''$ and $\tilde{t}'' \rightsquigarrow_{\sigma'} \tilde{t}'$. By IH with $\rho'' = \tau'' \diamond \sigma''$, there is some \tilde{s}'' s.t. $\textcircled{x}.s \rightsquigarrow_{\tau''} \tilde{s}''$ and $\tilde{s}'' \rightsquigarrow_{\sigma''} \tilde{s}'$. Then we have:

$$\frac{\textcircled{x}.t \rightsquigarrow_{\tau'} \tilde{t}'' \quad \textcircled{x}.s \rightsquigarrow_{\tau''} \tilde{s}'' \quad \tilde{t}'' \rightsquigarrow_{\sigma'} \tilde{t}' \quad \tilde{s}'' \rightsquigarrow_{\sigma''} \tilde{s}' \quad E_z(\tilde{s}') \quad E_z(\tilde{t}')}{\textcircled{x}.t \cap s \rightsquigarrow_{\mathfrak{f}_1^x \diamond (\tau' \parallel \tau'')} \tilde{t}'' \cap_1 \tilde{s}'' \quad \tilde{t}'' \cap_1 \tilde{s}'' \rightsquigarrow_{(\sigma' \parallel \sigma'') \diamond j_1^z} \textcircled{z}.1}$$
 Hence by letting $\tilde{u} = \tilde{t}'' \cap_1 \tilde{s}''$, this case has been proved.
- Case $\frac{\textcircled{x}.t \rightsquigarrow_{\rho'} \tilde{t}' \quad \textcircled{x}.s \rightsquigarrow_{\rho''} \tilde{s}' \quad \tilde{t} \rightsquigarrow_{\rho'} \tilde{t}' \quad \tilde{s} \rightsquigarrow_{\rho''} \tilde{s}' \quad E_z(\tilde{t}') \quad E_z(\tilde{s}')}{\textcircled{x}.t \cap s \rightsquigarrow_{\mathfrak{f}_1^x \diamond (\rho' \parallel \rho'')} \tilde{t}' \cap_1 \tilde{s}'}$, Case $\frac{\tilde{t} \rightsquigarrow_{\rho'} \tilde{t}' \quad \tilde{s} \rightsquigarrow_{\rho''} \tilde{s}' \quad E_z(\tilde{t}') \quad E_z(\tilde{s}')}{\tilde{t} \cap_1 \tilde{s} \rightsquigarrow_{(\rho' \parallel \rho'') \diamond j_1^z} \textcircled{z}.1}$, Case $\frac{\tilde{t} \rightsquigarrow_{\rho'} \tilde{t}' \quad \tilde{s} \rightsquigarrow_{\rho''} \tilde{s}'}{\tilde{t} \cap_1 \tilde{s} \rightsquigarrow_{(\rho' \parallel \rho'')} \tilde{t}' \cap_1 \tilde{s}'}$: Similar to the case above.
- Case $\frac{}{\tilde{t} \rightsquigarrow_{1^{\text{lab}(\tilde{t})}} \tilde{t}}$: Then $\tau = \sigma = 1^{\text{lab}(\tilde{t})}$. This case has been proved by the assumption.

Hence, this completes the proof. \square

7.3. Proof of Thm. 5.5: decomposition of derivatives. We now prove Thm. 5.5. First, we extend Def. 5.3 with annotations $(-)_\tau$ of $(\textcircled{\mathfrak{A}})_\bullet$ -runs.

Definition 7.17. Let $\vec{\mathfrak{A}} = \mathfrak{A}_1 \dots \mathfrak{A}_n \in \text{STR}^+$. The relation $\tilde{t} (\textcircled{\mathfrak{A}}_{i=1}^n \longrightarrow^{(\mathfrak{A}_i)_\bullet})_\tau \tilde{s}$, where $\langle \tilde{t}, \tau, \tilde{s} \rangle \in \bigcup_{j=1}^n \tilde{\mathbf{T}}_{(j)}^{\vec{\mathfrak{A}}} \times \text{lsubSPR}_{(j)}^{\vec{\mathfrak{A}}} \times \tilde{\mathbf{T}}_{(j)}^{\vec{\mathfrak{A}}}$, is defined as the minimal subset closed under the following rules:

$$\frac{\tilde{t} \longrightarrow_{\tau}^{(\mathfrak{A}_j)_\bullet} \tilde{s}}{\tilde{t}_{(j)} (\textcircled{\mathfrak{A}}_{i=1}^n \longrightarrow^{(\mathfrak{A}_i)_\bullet})_{\tau_{(j)}} \tilde{s}_{(j)}} \text{ D}$$

$$\frac{\tilde{t} (\textcircled{\mathfrak{A}}_{i=1}^n \longrightarrow^{(\mathfrak{A}_i)_\bullet})_\tau \tilde{u} \quad \tilde{u} (\textcircled{\mathfrak{A}}_{i=1}^n \longrightarrow^{(\mathfrak{A}_i)_\bullet})_\sigma \tilde{s}}{\tilde{t} (\textcircled{\mathfrak{A}}_{i=1}^n \longrightarrow^{(\mathfrak{A}_i)_\bullet})_{\tau \diamond \sigma} \tilde{s}} \text{ T} \quad \frac{\tilde{t}[\bullet/l] (\textcircled{\mathfrak{A}}_{i=1}^n \longrightarrow^{(\mathfrak{A}_i)_\bullet})_{\tau[\bullet/\langle l, r \rangle]} \tilde{s}[\bullet/r]}{\tilde{t}[x/l] (\textcircled{\mathfrak{A}}_{i=1}^n \longrightarrow^{(\mathfrak{A}_i)_\bullet})_{\tau[x/\langle l, r \rangle]} \tilde{s}[x/r]} \text{ L}$$

The rules of Def. 7.17 $(\textcircled{\mathfrak{A}}_{i=1}^n \longrightarrow^{(\mathfrak{A}_i)_\bullet})_\tau$ are the same as those of Def. 5.3 $(\textcircled{\mathfrak{A}}_{i=1}^n \longrightarrow^{(\mathfrak{A}_i)_\bullet})$ except that an $(\textcircled{\mathfrak{A}})_\bullet$ -run is annotated. Thus, the following immediately holds:

Proposition 7.18. Let $\vec{\mathfrak{A}} = \mathfrak{A}_1 \dots \mathfrak{A}_n \in \text{STR}^+$. For all $j \in [n]$ and $\tilde{t}, \tilde{s} \in \tilde{\mathbf{T}}_{(j)}^{\vec{\mathfrak{A}}}$, we have:

$$\tilde{t} (\textcircled{\mathfrak{A}}_{i=1}^n \longrightarrow^{(\mathfrak{A}_i)_\bullet}) \tilde{s} \Leftrightarrow \exists \tau \in \text{lsubSPR}_{(j)}^{\vec{\mathfrak{A}}}, \tilde{t} (\textcircled{\mathfrak{A}}_{i=1}^n \longrightarrow^{(\mathfrak{A}_i)_\bullet})_\tau \tilde{s}.$$

Proof. Both directions are shown by easy induction on the derivation trees. \square

We also have the following by using the properties shown in Sect. 7.2.

Lemma 7.19. Let $\vec{\mathfrak{A}} = \mathfrak{A}_1 \dots \mathfrak{A}_n \in \text{STR}^+$. For $\langle \tilde{t}, \tau, \tilde{s} \rangle \in \bigcup_{j=1}^n \tilde{\mathbf{T}}_{(j)}^{\vec{\mathfrak{A}}} \times \text{lsubSPR}_{(j)}^{\vec{\mathfrak{A}}} \times \tilde{\mathbf{T}}_{(j)}^{\vec{\mathfrak{A}}}$,

$$\tilde{t} \longrightarrow_{\tau}^{(\odot \vec{\mathfrak{A}}) \bullet} \tilde{s} \quad \Leftrightarrow \quad \tilde{t} (\odot_{i=1}^n \longrightarrow^{(\mathfrak{A}_i) \bullet})_{\tau} \tilde{s}.$$

Proof. (\Leftarrow): By easy induction on the derivation tree of Def. 7.17. (\Rightarrow): Using Lem. 7.10, we show by induction on the derivation tree of $\tau \in \odot_{i=1}^n \text{lsubSPR}^{(\mathfrak{A}_i) \bullet}$ (of the rules in Def. 7.6).

- Case $\frac{\tau \in \text{lsubSPR}^{(\mathfrak{A}_j) \bullet}}{\tau_{(j)} \in \odot_{i=1}^n \text{lsubSPR}^{(\mathfrak{A}_i) \bullet}}$ D: By $\tilde{t} \longrightarrow_{\tau_{(j)}}^{(\odot \vec{\mathfrak{A}}) \bullet} \tilde{s}$ (so $\tilde{t}, \tilde{s} \in \tilde{\mathbf{T}}_{(j)}^{\vec{\mathfrak{A}}}$), let \tilde{t}' and \tilde{s}' be such that $\tilde{t} = \tilde{t}'_{(j)}$ and $\tilde{s} = \tilde{s}'_{(j)}$. By $\tilde{t}'_{(j)} \longrightarrow_{\tau_{(j)}}^{(\odot \vec{\mathfrak{A}}) \bullet} \tilde{s}'_{(j)}$, we have $\tilde{t}' \longrightarrow_{\tau}^{(\mathfrak{A}_j) \bullet} \tilde{s}'$ (Lem. 7.12). Thus, by the rule (D), this case has been proved.
- Case $\frac{\tau \in \odot_{i=1}^n \text{lsubSPR}^{(\mathfrak{A}_i) \bullet} \quad \sigma \in \odot_{i=1}^n \text{lsubSPR}^{(\mathfrak{A}_i) \bullet}}{\tau \diamond \sigma \in \odot_{i=1}^n \text{lsubSPR}^{(\mathfrak{A}_i) \bullet}}$ T: By $\tilde{t} \longrightarrow_{\tau \diamond \sigma}^{(\odot \vec{\mathfrak{A}}) \bullet} \tilde{s}$, there exists some IKL term \tilde{u} such that $\tilde{t} \longrightarrow_{\tau}^{(\odot \vec{\mathfrak{A}}) \bullet} \tilde{u}$ and $\tilde{u} \longrightarrow_{\sigma}^{(\odot \vec{\mathfrak{A}}) \bullet} \tilde{s}$ (Lem. 7.14). Thus, by the rule (T) with IH, this case has been proved.
- Case $\frac{\tau[\bullet / \langle l, r \rangle] \in \odot_{i=1}^n \text{lsubSPR}^{(\mathfrak{A}_i) \bullet}}{\tau[x / \langle l, r \rangle] \in \odot_{i=1}^n \text{lsubSPR}^{(\mathfrak{A}_i) \bullet}}$ L: By $\tilde{t} \longrightarrow_{\tau[x / \langle l, r \rangle]}^{(\odot \vec{\mathfrak{A}}) \bullet} \tilde{s}$, let \tilde{t}' and \tilde{s}' be such that $\tilde{t} = \tilde{t}'[x / l]$ and $\tilde{s} = \tilde{s}'[x / r]$. Then we have $\tilde{t}'[\bullet / l] \longrightarrow_{\tau[\bullet / \langle l, r \rangle]}^{(\odot \vec{\mathfrak{A}}) \bullet} \tilde{s}'[\bullet / r]$ (Lem. 7.13). Thus, by the rule (L) with IH, this case has been proved.

Hence, this completes the proof. \square

Proof of Thm. 5.5. For all $\tilde{t}, \tilde{s} \in \tilde{\mathbf{T}}_{(j)}^{\vec{\mathfrak{A}}}$, we have:

$$\tilde{t} \longrightarrow^{(\odot \vec{\mathfrak{A}}) \bullet} \tilde{s} \quad \Leftrightarrow \quad \exists \tau \in \text{lsubSPR}_{(j)}^{\vec{\mathfrak{A}}}, \tilde{t} \longrightarrow_{\tau}^{(\odot \vec{\mathfrak{A}}) \bullet} \tilde{s} \quad (\text{Prop. 7.5})$$

$$\Leftrightarrow \quad \exists \tau \in \text{lsubSPR}_{(j)}^{\vec{\mathfrak{A}}}, \tilde{t} (\odot_{i=1}^n \longrightarrow^{(\mathfrak{A}_i) \bullet})_{\tau} \tilde{s} \quad (\text{Lem. 7.19})$$

$$\Leftrightarrow \quad \tilde{t} (\odot_{i=1}^n \longrightarrow^{(\mathfrak{A}_i) \bullet}) \tilde{s}. \quad (\text{Prop. 7.18})$$

Hence, this completes the proof. \square

7.4. Incompleteness of the decomposition rules in [Nak17]. In this subsection, we point out an error of the decomposition of $(\odot \vec{\mathfrak{A}}) \bullet$ -runs in [Nak17, Sect. IV (Lemma IV.10)]. In [Nak17], left quotients of $(\odot \vec{\mathfrak{A}}) \bullet$ -runs w.r.t. SGCPs are considered, but events of SGCPs are read in one-way. This approach essentially corresponds to the following decomposition rules of $(\odot \vec{\mathfrak{A}}) \bullet$ -runs where $\vec{\mathfrak{A}} = \mathfrak{A}_1 \dots \mathfrak{A}_n$ and each X_j ($j \in [n]$) is the minimal subset of $\bigcup_{i=1}^n \text{lsubSPR}_{(i)}^{\vec{\mathfrak{A}}}$ closed under the following rules (cf. Def. 7.6):

$$\frac{\tau \in \text{lsubSPR}^{\mathfrak{A}_j}}{\tau_{(j)} \in X_j} \text{ D} \quad \frac{\tau \in X_j \quad \sigma \in X_j}{\tau \diamond \sigma \in X_j} \text{ T} \quad \frac{\tau[\bullet / \langle l, r \rangle] \in X_j}{\tau[x / \langle l, r \rangle] \in X_j} \text{ L} \quad \frac{\tau \in X_{j-1}}{\tau \in X_j} +1$$

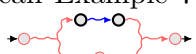
(In a nutshell, the rule “-1” does not exist.) However, the set $(\bigcup_{i=1}^n X_i)$ is incomplete (Lem. 7.10 \Leftarrow does not hold). We recall Example 7.7 and the sequence $\vec{\mathfrak{A}} = \mathfrak{A}_1 \mathfrak{A}_2$. For instance, the $(\odot \vec{\mathfrak{A}}) \bullet$ -run of the form  is derived by:

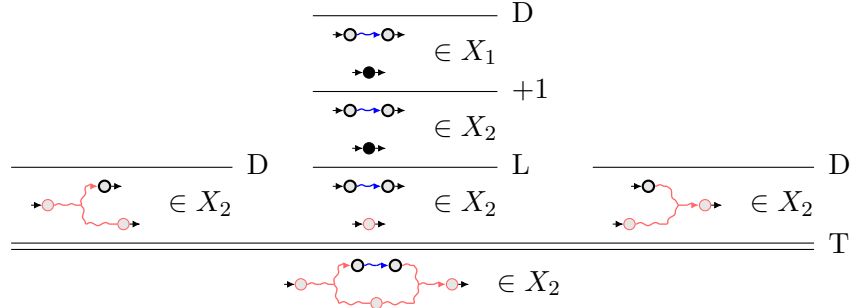

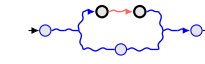
(Here, blue-colored edges and red-colored edges are the edges induced from \mathfrak{A}_1 and \mathfrak{A}_2 , respectively.) However, we cannot derive the $(\odot \vec{\mathfrak{A}})_\bullet$ -run τ of the form  in this system because the rule “-1” does not exist. To avoid this problem, instead of one-way automata, we use 2AFAs.

8. CONCLUSION

We have presented derivatives on structures/graphs and have shown a decomposition theorem of the derivatives (Thm. 5.5). Consequently, we have shown that the equational theory of the positive calculus of relations with transitive closure (PCoR*) is decidable and EXPSPACE-complete (Cor. 6.1).

Related and future work. In the following, we present related and future work.

Identity-free Kleene lattices. Brunet and Pous have shown that the equational theory of identity-free Kleene lattices $\langle 0, ;, +, \cap, _+ \rangle$ is EXPSPACE-complete [BP15, BP17]. They presented an algorithm for comparing sets of runs (denoting acyclic and connected graphs) modulo homomorphisms using Petri automata. However, their approach is problematic when terms have non-acyclic or non-connected graphs (e.g., when the identity 1, the converse \smile , or the university \top occurs) [BP17, Sect. 9.3]. In our approach, based on the linearly bounded pathwidth model property (Prop. 2.10), we consider decomposing \mathfrak{A} -runs (instead of runs) on path decompositions. It would also be possible to connect our derivatives to branching automata [LW98, LW00, LW01] or Petri automata [BP17].

PDL with intersection. Propositional dynamic logic with intersection (IPDL) [Dan84a] is propositional dynamic logic (PDL) of regular programs with intersection. The theory of IPDL is decidable and 2EXPTIME-complete [Dan84a, LL05, GLL09]. The known algorithms [Dan84a, Lut05, GLL09] are based on the treewidth at most 2 model property of IPDL (cf. Prop. 2.9). In [GLL09], Göeller, Lohrey, and Lutz presented a polynomial-time reduction from the theory of IPDL with converse (ICPDL) into that over ω -regular trees and presented a reduction to the universality problem of two-way alternating parity tree automata. To express relational intersection (\cap), their approach is based on the product construction of automata (the product construction naively fails, but by adding transitions so that there always exists the shortest run if a run exists between two vertices on an input tree, the product construction works on trees [GLL09, p. 288]), while our approach uses sub SP runs. Recently by extending their approach, the elementary decidability result of ICPDL has been extended to CPDL+ [FFP23]. Note that we can naturally reduce the equational

theory of KL terms (w.r.t. relations) into the theory of IPDL formulas because $\text{REL} \models t = s$ iff the IPDL formula $\langle t \rangle p \leftrightarrow \langle s \rangle p$ is valid (as with [FL79, p. 209] for PDL) where p is a propositional variable (disjoint from variables) and $\langle - \rangle$ denotes the diamond modality. Thus, the 2EXPTIME upper bound of the equational theory of KL terms can be obtained via this reduction. To obtain the EXPSPACE upper bound using this approach, we need to give a reduction from the theory of KL terms over linearly bounded pathwidth structures into that over words, cf. the inclusion problem is in PSPACE for (*word*) 2AFAs (Prop. 5.6) whereas the inclusion problem is EXPTIME-hard for *tree* (two-way alternating) automata [CDG⁺07, Thm. 1.7.7]. This approach would be possible by modifying the encoding of tree-decompositions but is not immediate, because the reduction [Lut05, GLL09] always generates trees (not words) even when a given tree decomposition is a path decomposition. Conversely, it would also be possible to extend our decomposition approach to the extensions of PDL above, but we leave it as a future work.

Regular queries. Regular queries [RRV17] are binary non-recursive positive Datalog programs extended with Kleene-star. The containment problem for regular queries is decidable and 2EXPSpace-complete [RRV17]. Because we can naturally translate KL terms (w.r.t. relations) and also PCoR* terms into regular queries, we can also reduce the equational theory of PCoR* terms into the containment problem for regular queries.

The existential calculus of relations with transitive closure. The existential calculus of relations with transitive closure (ECoR*) [Nak23] is PCoR* with variable and constant complements (i.e., the complement operator only applies to variables or constants). ECoR* has the same expressive power as 3-variable existential first-order logic with variable-confined monadic transitive closure [Nak20, Nak22]. This extension is related to boolean modal logic [GP90] and (I)PDL with negation of atomic programs [LW05, GLL09]. The equational theory of PCoR* with variable complements is Π_1^0 -complete [Nak23] (an open problem left in the conference version [Nak17]) and the equational theory of PCoR* with constant complements (i.e., with the difference constant) is Π_1^0 -complete [Nak24b]. Nevertheless, the equational theory is decidable for the intersection-free fragment of ECoR* [Nak23].

On Kleene algebra with graph loop. The graph loop operator t° [Dan84b] is the operator defined by: $t^\circ \triangleq t \cap 1$. We leave it open whether the equational theory of Kleene algebra with graph loop (w.r.t. relations) is PSPACE-complete. Related to this, PDL with graph loop (loop-PDL) [Dan84b, GLL09] is EXPTIME-complete, whereas PDL with intersection is 2EXPSpace-complete. For loop-PDL, the formulas can be translated into ICPDL formulas of intersection width at most 2, so the EXPTIME upper bound of loop-PDL is a corollary of that the bounded intersection width fragment of ICPDL is decidable in EXPTIME [GLL09, Cor. 4.9]. However, this translation essentially needs the diamond modality as a primitive, so Cor. 6.4 does not imply the PSPACE decidability, immediately; the closure size (w.r.t. the closure function of Def. 4.10) is still exponential because the number of labels occurring in Kleene algebra terms with graph loop is not bounded. A related problem is posed by Sedlár [Sed23, p. 16] for the complexity of the equational theory of Kleene algebra with the domain operator (dKA) w.r.t. relations. Here, the domain operator $\mathbf{d}(t)$ is the operator $\mathbf{d}(t) \triangleq (t\top) \cap 1$. Note that, because $\text{REL} \models \mathbf{d}(t) = (t\top)^\circ$, we can reduce the equational theory of dKA into that of Kleene algebra with graph loop and top.

On axiomatization. Another interesting question is the axiomatizability. Doumane and Pous presented a finite axiomatization for the equational theory of identity-free Kleene lattices [DP18]. However, the finite axiomatizability is still an open problem for the equational theory of Kleene lattices (with extra operators) w.r.t. relations [DP18, p. 15][Pou18].

APPENDIX A. PROOF OF PROP. 5.9

Proof. Both directions are shown by easy induction on the derivative trees, respectively.

(\Rightarrow): By induction on the derivation tree.

- Case $\frac{\tilde{t} \rightarrow^{(\mathfrak{A}_j)\bullet} \tilde{s}}{\tilde{t}_{(j')} (\odot_{i=1}^n \rightarrow^{(\mathfrak{A}_i)\bullet}) \tilde{s}_{(j')}} \text{ D}$ where j' satisfies $\tilde{t}_{(j')} = \tilde{t}_{(j)}$ and $\tilde{s}_{(j')} = \tilde{s}_{(j)}$: Then,

$$\frac{\frac{\frac{}{\langle \tilde{t}, \tilde{s} \rangle_{\checkmark}, j'} \in S_{\triangleright \mathfrak{A}_1 \dots \mathfrak{A}_n \triangleleft}^{\mathcal{A}_k^u} \text{ D}}{\langle \tilde{t}, \tilde{s} \rangle_{\checkmark}, j} \in S_{\triangleright \mathfrak{A}_1 \dots \mathfrak{A}_n \triangleleft}^{\mathcal{A}_k^u} \quad -1, +1, \checkmark}{\langle \tilde{t}, \tilde{s} \rangle_{\checkmark}, j} \in S_{\triangleright \mathfrak{A}_1 \dots \mathfrak{A}_n \triangleleft}^{\mathcal{A}_k^u}}$$

- Case $\frac{\tilde{t}_{(j')} (\odot_{i=1}^n \rightarrow^{(\mathfrak{A}_i)\bullet}) \tilde{u}'_{(j')} \quad \tilde{u}'_{(j')} (\odot_{i=1}^n \rightarrow^{(\mathfrak{A}_i)\bullet}) \tilde{s}_{(j')}}{\tilde{t}_{(j')} (\odot_{i=1}^n \rightarrow^{(\mathfrak{A}_i)\bullet}) \tilde{s}_{(j')}} \text{ T}$ where j' satisfies $\tilde{t}_{(j')} = \tilde{t}_{(j)}$ and $\tilde{s}_{(j')} = \tilde{s}_{(j)}$: Then we have:

$$\frac{\frac{\frac{\frac{}{\langle \tilde{t}, \tilde{u}' \rangle_{\checkmark}, j'} \in S_{\triangleright \mathfrak{A}_1 \dots \mathfrak{A}_n \triangleleft}^{\mathcal{A}_k^u} \text{ (IH)}}{\langle \tilde{t}, \tilde{u}' \rangle_{\checkmark}, j} \in S_{\triangleright \mathfrak{A}_1 \dots \mathfrak{A}_n \triangleleft}^{\mathcal{A}_k^u} \quad \checkmark}{\langle \tilde{t}, \tilde{u}' \rangle_{\checkmark}, j} \in S_{\triangleright \mathfrak{A}_1 \dots \mathfrak{A}_n \triangleleft}^{\mathcal{A}_k^u} \quad \checkmark}{\langle \tilde{t}, \tilde{s} \rangle_{\checkmark}, j} \in S_{\triangleright \mathfrak{A}_1 \dots \mathfrak{A}_n \triangleleft}^{\mathcal{A}_k^u} \text{ (IH)}}{\frac{\frac{\frac{}{\langle \tilde{u}', \tilde{s} \rangle_{\checkmark}, j'} \in S_{\triangleright \mathfrak{A}_1 \dots \mathfrak{A}_n \triangleleft}^{\mathcal{A}_k^u} \text{ (IH)}}{\langle \tilde{u}', \tilde{s} \rangle_{\checkmark}, j} \in S_{\triangleright \mathfrak{A}_1 \dots \mathfrak{A}_n \triangleleft}^{\mathcal{A}_k^u} \quad \checkmark}{\langle \tilde{u}', \tilde{s} \rangle_{\checkmark}, j} \in S_{\triangleright \mathfrak{A}_1 \dots \mathfrak{A}_n \triangleleft}^{\mathcal{A}_k^u} \text{ T}}{\langle \tilde{t}, \tilde{s} \rangle_{\checkmark}, j} \in S_{\triangleright \mathfrak{A}_1 \dots \mathfrak{A}_n \triangleleft}^{\mathcal{A}_k^u} \quad -1, +1, \checkmark}{\langle \tilde{t}, \tilde{s} \rangle_{\checkmark}, j} \in S_{\triangleright \mathfrak{A}_1 \dots \mathfrak{A}_n \triangleleft}^{\mathcal{A}_k^u}}$$

- Case $\frac{\tilde{t}[\bullet/l]_{(j')} (\odot_{i=1}^n \rightarrow^{(\mathfrak{A}_i)\bullet}) \tilde{s}[\bullet/r]_{(j')}}{\tilde{t}[x/l]_{(j')} (\odot_{i=1}^n \rightarrow^{(\mathfrak{A}_i)\bullet}) \tilde{s}[x/r]_{(j')}} \text{ L}$ where i' satisfies that $\tilde{t}[x/l]_{(j')} = \tilde{t}[x/l]_{(j)}$ and $\tilde{s}[x/r]_{(j')} = \tilde{s}[x/r]_{(j)}$: Then we have:

$$\frac{\frac{\frac{\frac{}{\langle \tilde{t}[\bullet/l], \tilde{s}[\bullet/r] \rangle_{\checkmark}, j'} \in S_{\triangleright \mathfrak{A}_1 \dots \mathfrak{A}_n \triangleleft}^{\mathcal{A}_k^u} \text{ (IH)}}{\langle \tilde{t}[\bullet/l], \tilde{s}[\bullet/r] \rangle_{\checkmark}, j} \in S_{\triangleright \mathfrak{A}_1 \dots \mathfrak{A}_n \triangleleft}^{\mathcal{A}_k^u} \quad \checkmark}{\langle \tilde{t}[\bullet/l], \tilde{s}[\bullet/r] \rangle_{\checkmark}, j} \in S_{\triangleright \mathfrak{A}_1 \dots \mathfrak{A}_n \triangleleft}^{\mathcal{A}_k^u} \text{ L}}{\frac{\frac{}{\langle \tilde{t}[x/l], \tilde{s}[x/r] \rangle_{\checkmark}, j'} \in S_{\triangleright \mathfrak{A}_1 \dots \mathfrak{A}_n \triangleleft}^{\mathcal{A}_k^u} \quad -1, +1, \checkmark}{\langle \tilde{t}[x/l], \tilde{s}[x/r] \rangle_{\checkmark}, j} \in S_{\triangleright \mathfrak{A}_1 \dots \mathfrak{A}_n \triangleleft}^{\mathcal{A}_k^u}}{\langle \tilde{t}[x/l], \tilde{s}[x/r] \rangle_{\checkmark}, j} \in S_{\triangleright \mathfrak{A}_1 \dots \mathfrak{A}_n \triangleleft}^{\mathcal{A}_k^u}}$$

(\Leftarrow): By induction on the derivation tree.

- Case $\frac{\tilde{t} \rightarrow^{(\mathfrak{A}_j)\bullet} \tilde{s}}{\tilde{t}_{(j')} (\odot_{i=1}^n \rightarrow^{(\mathfrak{A}_i)\bullet}) \tilde{s}_{(j')}} \text{ D}$ where $\tilde{t} \rightarrow^{(\mathfrak{A}_j)\bullet} \tilde{s}$: Then, $\frac{\tilde{t} \rightarrow^{(\mathfrak{A}_j)\bullet} \tilde{s}}{\tilde{t}_{(j')} (\odot_{i=1}^n \rightarrow^{(\mathfrak{A}_i)\bullet}) \tilde{s}_{(j')}} \text{ D}$.

- Case $\frac{\langle \langle \tilde{t}, \tilde{s} \rangle_{\checkmark}, j-1 \rangle \in S_{\triangleright \mathfrak{A}_1 \dots \mathfrak{A}_n}^{A_k^u}}{-1} \checkmark$: (Note that \checkmark is the only rule that can apply to $\langle \langle \tilde{t}, \tilde{s} \rangle_{\checkmark}, j \rangle \in S_{\triangleright \mathfrak{A}_1 \dots \mathfrak{A}_n}^{A_k^u}$.) We then have:

$$\frac{}{\frac{}{\tilde{t}_{(j-1)} (\odot_{i=1}^n \rightarrow^{(\mathfrak{A}_i) \bullet}) \tilde{s}_{(j-1)}}} \text{ (IH).}$$

By $\overrightarrow{\text{lab}}(\tilde{t}), \overrightarrow{\text{lab}}(\tilde{s}) \in |(\mathfrak{A}_{j-1}) \bullet|^+ \cap |(\mathfrak{A}_j) \bullet|^+$, we have $\tilde{t}_{(j-1)} = \tilde{t}_{(j)}$ and $\tilde{s}_{(j-1)} = \tilde{s}_{(j)}$, and thus this case has been proved.

- Case $\frac{\langle \langle \tilde{t}, \tilde{s} \rangle_{\checkmark}, j+1 \rangle \in S_{\triangleright \mathfrak{A}_1 \dots \mathfrak{A}_n}^{A_k^u}}{+1}$: In the same way as the case above.
- Case $\frac{\langle \langle \tilde{t}, \tilde{s} \rangle_{\checkmark}, j \rangle \in S_{\triangleright \mathfrak{A}_1 \dots \mathfrak{A}_n}^{A_k^u}}{\checkmark} \quad \frac{\langle \langle \tilde{t}, \tilde{u}' \rangle_{\checkmark}, j \rangle \in S_{\triangleright \mathfrak{A}_1 \dots \mathfrak{A}_n}^{A_k^u}}{\checkmark} \quad \frac{\langle \langle \tilde{u}', \tilde{s} \rangle_{\checkmark}, j \rangle \in S_{\triangleright \mathfrak{A}_1 \dots \mathfrak{A}_n}^{A_k^u}}{\checkmark}}{\langle \langle \tilde{t}, \tilde{u}' \rangle_{\checkmark}, j \rangle \in S_{\triangleright \mathfrak{A}_1 \dots \mathfrak{A}_n}^{A_k^u} \quad \langle \langle \tilde{u}', \tilde{s} \rangle_{\checkmark}, j \rangle \in S_{\triangleright \mathfrak{A}_1 \dots \mathfrak{A}_n}^{A_k^u}} \text{ T} : \text{ Then we have:}$

$$\frac{\frac{\frac{}{\tilde{t}_{(j)} (\odot_{i=1}^n \rightarrow^{(\mathfrak{A}_i) \bullet}) \tilde{u}'_{(j)}} \text{ (IH)}}{\tilde{t}_{(j)} (\odot_{i=1}^n \rightarrow^{(\mathfrak{A}_i) \bullet}) \tilde{u}'_{(j)}} \quad \frac{\frac{}{\tilde{u}'_{(j)} (\odot_{i=1}^n \rightarrow^{(\mathfrak{A}_i) \bullet}) \tilde{s}_{(j)}} \text{ (IH)}}{\tilde{u}'_{(j)} (\odot_{i=1}^n \rightarrow^{(\mathfrak{A}_i) \bullet}) \tilde{s}_{(j)}} \text{ T}}{\tilde{t}_{(j)} (\odot_{i=1}^n \rightarrow^{(\mathfrak{A}_i) \bullet}) \tilde{s}_{(j)}} \text{ T}.$$

- Case $\frac{\langle \langle \tilde{t}[\bullet/l], \tilde{s}[\bullet/r] \rangle_{\checkmark}, j \rangle \in S_{\triangleright \mathfrak{A}_1 \dots \mathfrak{A}_n}^{A_k^u}}{\checkmark} \quad \frac{\langle \langle \tilde{t}[\bullet/l], \tilde{s}[\bullet/r] \rangle_{\checkmark}, j \rangle \in S_{\triangleright \mathfrak{A}_1 \dots \mathfrak{A}_n}^{A_k^u}}{\text{L}} \quad \frac{\langle \langle \tilde{t}[x/l], \tilde{s}[x/r] \rangle_{\checkmark}, j \rangle \in S_{\triangleright \mathfrak{A}_1 \dots \mathfrak{A}_n}^{A_k^u}}{\text{L}}}{\langle \langle \tilde{t}[\bullet/l], \tilde{s}[\bullet/r] \rangle_{\checkmark}, j \rangle \in S_{\triangleright \mathfrak{A}_1 \dots \mathfrak{A}_n}^{A_k^u}} \text{ L} : \text{ Then, } \frac{\frac{}{\tilde{t}[\bullet/l]_{(j)} (\odot_{i=1}^n \rightarrow^{(\mathfrak{A}_i) \bullet}) \tilde{s}[\bullet/r]_{(j)}} \text{ (IH)}}{\tilde{t}[\bullet/l]_{(j)} (\odot_{i=1}^n \rightarrow^{(\mathfrak{A}_i) \bullet}) \tilde{s}[\bullet/r]_{(j)}} \text{ L} \quad \frac{\frac{}{\tilde{t}[x/l]_{(j)} (\odot_{i=1}^n \rightarrow^{(\mathfrak{A}_i) \bullet}) \tilde{s}[x/r]_{(j)}} \text{ L}}{\tilde{t}[x/l]_{(j)} (\odot_{i=1}^n \rightarrow^{(\mathfrak{A}_i) \bullet}) \tilde{s}[x/r]_{(j)}} \text{ L}.$

Hence, this completes the proof. \square

APPENDIX B. PROOF OF PROP. 7.16

Proof. (\supseteq): We show that each rule of \rightsquigarrow_{τ} is admissible in \rightarrow_{τ} .

- Case $\frac{\langle x, y \rangle \in a^{\mathfrak{A}}}{\ @x.a \rightarrow_{a_1}^{\mathfrak{A}} @y.1}$ for $a \in \Sigma$, Case $\frac{\ @x.t \rightarrow_{\rho}^{\mathfrak{A}} \tilde{t}'}{\ @x.t + s \rightarrow_{\rho}^{\mathfrak{A}} \tilde{t}'}$, Case $\frac{\ @x.s \rightarrow_{\rho}^{\mathfrak{A}} \tilde{s}'}{\ @x.t + s \rightarrow_{\rho}^{\mathfrak{A}} \tilde{s}'}$, Case $\frac{\ @x.t \rightarrow_{\rho}^{\mathfrak{A}} \tilde{t}'}{\ @x.t; s \rightarrow_{\rho}^{\mathfrak{A}} \tilde{t}' ;_1 s}$, Case $\frac{\ @x.t \rightarrow_{\rho}^{\mathfrak{A}} \tilde{t}'}{\ @x.t; s \rightarrow_{\rho}^{\mathfrak{A}} \tilde{t}' ;_1 s}$, Case $\frac{\ @x.t \rightarrow_{\rho}^{\mathfrak{A}} \tilde{t}'}{\ @x.t; s \rightarrow_{\rho}^{\mathfrak{A}} \tilde{t}' ;_1 s}$: Trivial.
- Case $\frac{\ @x.t \rightarrow_{\rho}^{\mathfrak{A}} \tilde{t}' \quad E_z(\tilde{t}') \quad @z.s \rightarrow_{\rho'}^{\mathfrak{A}} \tilde{s}'}{\ @x.t; s \rightarrow_{\rho \circ \rho'}^{\mathfrak{A}} \tilde{s}'}$: By $\frac{\ @x.t \rightarrow_{\rho}^{\mathfrak{A}} \tilde{t}' \quad \frac{\ @z.s \rightarrow_{\rho'}^{\mathfrak{A}} \tilde{s}'}{\ @z.s \rightarrow_{\rho'}^{\mathfrak{A}} \tilde{s}'}}{E_z(\tilde{t}') \quad @z.s \rightarrow_{\rho'}^{\mathfrak{A}} \tilde{s}'}}{\ @x.t; s \rightarrow_{\rho \circ \rho'}^{\mathfrak{A}} \tilde{s}'}$ T.

- Case $\frac{\tilde{t} \xrightarrow{\mathfrak{A}}_{\rho} \tilde{t}' \quad E_z(\tilde{t}') \quad @z.s \xrightarrow{\mathfrak{A}}_{\rho'} \tilde{s}}{\tilde{t} ;_1 s \xrightarrow{\mathfrak{A}}_{\rho \circ \rho'} \tilde{s}}$: Similar to the case above.
- Case $\frac{\frac{@x_0.t \xrightarrow{\mathfrak{A}}_{\rho_0} \tilde{t}'_1 \quad E_{x_1}(\tilde{t}'_1) \quad \dots \quad @x_{n-1}.t \xrightarrow{\mathfrak{A}}_{\rho_{n-1}} \tilde{t}'_n \quad E_{x_n}(\tilde{t}'_n) \quad @x_n.t \xrightarrow{\mathfrak{A}}_{\rho_n} \tilde{t}'_{n+1}}{@x_0.t^* \xrightarrow{\mathfrak{A}}_{\rho_0 \diamond \dots \diamond \rho_n} \tilde{t}'_{n+1} ;_1 t^*}}{\dots}$:

By the following derivation tree:

$$\frac{\frac{@x_0.t \xrightarrow{\mathfrak{A}}_{\rho_0} \tilde{t}'_1 \quad E_{x_n}(\tilde{t}'_n) \quad @x_n.t^* \xrightarrow{\mathfrak{A}}_{\rho_n} \tilde{t}'_{n+1} ;_1 t^*}{@x_0.t^* \xrightarrow{\mathfrak{A}}_{\rho_0} \tilde{t}'_1 ;_1 t^*} \quad \dots \quad \frac{@x_n.t \xrightarrow{\mathfrak{A}}_{\rho_n} \tilde{t}'_{n+1}}{\tilde{t}'_n ;_1 t^* \xrightarrow{\mathfrak{A}}_{\rho_n} \tilde{t}'_{n+1} ;_1 t^*}}{\dots} \quad \text{T}}{@x_0.t^* \xrightarrow{\mathfrak{A}}_{\rho_0 \diamond \dots \diamond \rho_n} \tilde{t}'_{n+1} ;_1 t^*}} \quad \text{T}$$

- Case $\frac{\frac{@x_0.t^* \xrightarrow{\mathfrak{A}}_{\rho_0 \diamond \dots \diamond \rho_n} \tilde{t}'_{n+1} ;_1 t^* \quad @x.t \xrightarrow{\mathfrak{A}}_{\rho} \tilde{t}' \quad @x.s \xrightarrow{\mathfrak{A}}_{\rho'} \tilde{s}' \quad E_z(\tilde{t}') \quad E_z(\tilde{s}')}{@x.t \cap s \xrightarrow{\mathfrak{A}}_{\mathfrak{F}_1^x \diamond (\rho \parallel \rho') \diamond j_1^z} @z.1}}{\dots}$: We have:

$$\frac{\frac{@x.t \cap s \xrightarrow{\mathfrak{A}}_{\mathfrak{F}_1^x} (@x.t) \cap_1 (@x.s)}{@x.s \xrightarrow{\mathfrak{A}}_{\rho'} \tilde{s}'}}{\tilde{t}' \cap_1 (@x.s) \xrightarrow{\mathfrak{A}}_{\rho'} \tilde{t}' \cap_1 \tilde{s}'}, \quad \frac{\frac{@x.t \xrightarrow{\mathfrak{A}}_{\rho} \tilde{t}' \quad (@x.t) \cap_1 (@x.s) \xrightarrow{\mathfrak{A}}_{\rho} \tilde{t}' \cap_1 (@x.s)}{E_z(\tilde{t}') \quad E_z(\tilde{s}')}}{\tilde{t}' \cap_1 \tilde{s}' \xrightarrow{\mathfrak{A}}_{j_1^z} @z.1}}$$

Hence by (T), we have obtained $@x.t \cap s \xrightarrow{\mathfrak{A}}_{\mathfrak{F}_1^x \diamond (\rho \parallel \rho') \diamond j_1^z} @z.1$.

- Case $\frac{\frac{@x.t \xrightarrow{\mathfrak{A}}_{\rho} \tilde{t}' \quad @x.s \xrightarrow{\mathfrak{A}}_{\rho'} \tilde{s}' \quad \tilde{t} \xrightarrow{\mathfrak{A}}_{\rho} \tilde{t}' \quad \tilde{s} \xrightarrow{\mathfrak{A}}_{\rho'} \tilde{s}' \quad E_z(\tilde{t}') \quad E_z(\tilde{s}')}{@x.t \cap s \xrightarrow{\mathfrak{A}}_{\mathfrak{F}_1^x \diamond (\rho \parallel \rho')} \tilde{t} \cap_1 \tilde{s}}}{\tilde{t} \xrightarrow{\mathfrak{A}}_{\rho} \tilde{t}' \quad \tilde{s} \xrightarrow{\mathfrak{A}}_{\rho'} \tilde{s}'}}{\tilde{t} \cap_1 \tilde{s} \xrightarrow{\mathfrak{A}}_{(\rho \parallel \rho')} \tilde{t}' \cap_1 \tilde{s}'}, \quad \text{Case } \frac{\tilde{t} \cap_1 \tilde{s} \xrightarrow{\mathfrak{A}}_{(\rho \parallel \rho') \diamond j_1^z} @z.1}{\dots}, \quad \text{Case } \frac{\tilde{t} \xrightarrow{\mathfrak{A}}_{\rho} \tilde{t}' \quad \tilde{s} \xrightarrow{\mathfrak{A}}_{\rho'} \tilde{s}' \quad E_z(\tilde{t}') \quad E_z(\tilde{s}')}{\tilde{t} \cap_1 \tilde{s} \xrightarrow{\mathfrak{A}}_{(\rho \parallel \rho') \diamond j_1^z} @z.1}, \quad \text{Case } \frac{\tilde{t} \xrightarrow{\mathfrak{A}}_{\rho} \tilde{t}' \quad \tilde{s} \xrightarrow{\mathfrak{A}}_{\rho'} \tilde{s}' \quad E_z(\tilde{t}') \quad E_z(\tilde{s}')}{\tilde{t} \cap_1 \tilde{s} \xrightarrow{\mathfrak{A}}_{(\rho \parallel \rho')} \tilde{t}' \cap_1 \tilde{s}'}$: Similar to the case above.

Hence, this direction has been proved.

(\subseteq): We show that the transitivity rule $\frac{\tilde{t} \rightsquigarrow_{\tau}^{\mathfrak{A}} \tilde{u} \quad \tilde{u} \rightsquigarrow_{\sigma}^{\mathfrak{A}} \tilde{s}}{\tilde{t} \rightsquigarrow_{\tau \diamond \sigma}^{\mathfrak{A}} \tilde{s}}$ T is admissible, by induction on the sum of the sizes of the derivation trees of $\tilde{t} \rightsquigarrow_{\tau}^{\mathfrak{A}} \tilde{u}$ and $\tilde{u} \rightsquigarrow_{\sigma}^{\mathfrak{A}} \tilde{s}$.

- Case $\frac{\frac{\tilde{t} \rightsquigarrow_{\rho}^{\mathfrak{A}} \tilde{s} \quad \tilde{s} \rightsquigarrow_{1^{\text{lab}}(\tilde{s})}^{\mathfrak{A}} \tilde{s}}{\tilde{t} \rightsquigarrow_{\rho}^{\mathfrak{A}} \tilde{s}} \quad \text{R}}{\tilde{t} \rightsquigarrow_{\rho}^{\mathfrak{A}} \tilde{s}} \quad \text{T}, \quad \text{Case } \frac{\frac{\tilde{t} \rightsquigarrow_{1^{\text{lab}}(\tilde{t})}^{\mathfrak{A}} \tilde{t} \quad \tilde{t} \rightsquigarrow_{\rho}^{\mathfrak{A}} \tilde{s}}{\tilde{t} \rightsquigarrow_{\rho}^{\mathfrak{A}} \tilde{s}} \quad \text{R}}{\tilde{t} \rightsquigarrow_{\rho}^{\mathfrak{A}} \tilde{s}} \quad \text{T}$ (i.e., when the immediate above rule contains (R)): Clear.

- Case $\frac{@x.a \rightsquigarrow_{\rho}^{\mathfrak{A}} @y.1 \quad @y.1 \rightsquigarrow_{\rho'}^{\mathfrak{A}} \tilde{s}}{@x.a \rightsquigarrow_{\rho \circ \rho'}^{\mathfrak{A}} \tilde{s}} \quad \text{T}$: Then the right-hand side rule should be the rule (R); thus, this case has already been proved.

- Case $\frac{\textcircled{x}.t \rightsquigarrow_{\rho}^{\mathfrak{A}} \tilde{t}''}{\textcircled{x}.t ; s \rightsquigarrow_{\rho}^{\mathfrak{A}} \tilde{t}'' ;_1 s \rightsquigarrow_{\rho'}^{\mathfrak{A}} \tilde{t}'' ;_1 s \rightsquigarrow_{\rho'}^{\mathfrak{A}} \tilde{u}} \text{T}$: For the form of the above of $\tilde{t}'' ;_1 s \rightsquigarrow_{\rho'}^{\mathfrak{A}} \tilde{u}$,

$$\textcircled{x}.t ; s \rightsquigarrow_{\rho \circ \rho'}^{\mathfrak{A}} \tilde{u}$$

we distinguish the following cases (except for the rule (R)):

- Case $\frac{\tilde{t}'' \rightsquigarrow_{\rho'}^{\mathfrak{A}} \tilde{t}'}{\tilde{t}'' ;_1 s \rightsquigarrow_{\rho'}^{\mathfrak{A}} \tilde{t}' ;_1 s}$: Then we have: $\frac{\textcircled{x}.t \rightsquigarrow_{\rho}^{\mathfrak{A}} \tilde{t}'' \quad \tilde{t}'' \rightsquigarrow_{\rho'}^{\mathfrak{A}} \tilde{t}'}{\textcircled{x}.t \rightsquigarrow_{\rho \circ \rho'}^{\mathfrak{A}} \tilde{t}'}$ T . By IH, this case

has been proved.

- Case $\frac{\tilde{t}'' \rightsquigarrow_{\rho_1}^{\mathfrak{A}} \tilde{t}' \quad \text{E}_z(\tilde{t}') \quad \textcircled{z}.s \rightsquigarrow_{\rho_2}^{\mathfrak{A}} \tilde{u}}{\textcircled{x}.t \rightsquigarrow_{\rho}^{\mathfrak{A}} \tilde{t}'' \quad \tilde{t} \rightsquigarrow_{\rho_1}^{\mathfrak{A}} \tilde{t}' \quad \tilde{t}'' ;_1 s \rightsquigarrow_{\rho_1 \circ \rho_2}^{\mathfrak{A}} \tilde{u}} \text{T}$: Then we have: $\frac{\textcircled{x}.t \rightsquigarrow_{\rho \circ \rho_1}^{\mathfrak{A}} \tilde{t}' \quad \text{E}_z(\tilde{t}') \quad \textcircled{z}.s \rightsquigarrow_{\rho_2}^{\mathfrak{A}} \tilde{u}}{\textcircled{x}.t ; s \rightsquigarrow_{(\rho \circ \rho_1) \circ \rho_2}^{\mathfrak{A}} \tilde{u}}$. By IH, this case has been proved.

- Case $\frac{\textcircled{x}.t ; s \rightsquigarrow_{\rho \circ \rho'}^{\mathfrak{A}} \tilde{s}'' \quad \tilde{s}'' \rightsquigarrow_{\rho''}^{\mathfrak{A}} \tilde{s}'}{\textcircled{x}.t \rightsquigarrow_{\rho}^{\mathfrak{A}} \tilde{t}' \quad \text{E}_z(\tilde{t}') \quad \textcircled{z}.s \rightsquigarrow_{\rho'}^{\mathfrak{A}} \tilde{s}''} \text{T}$: Then we have: $\frac{\textcircled{x}.t ; s \rightsquigarrow_{(\rho \circ \rho') \circ \rho''}^{\mathfrak{A}} \tilde{s}' \quad \textcircled{z}.s \rightsquigarrow_{\rho'}^{\mathfrak{A}} \tilde{s}'' \quad \tilde{s}'' \rightsquigarrow_{\rho''}^{\mathfrak{A}} \tilde{s}'}{\textcircled{x}.t \rightsquigarrow_{\rho}^{\mathfrak{A}} \tilde{t}' \quad \text{E}_z(\tilde{t}') \quad \textcircled{z}.s \rightsquigarrow_{\rho' \circ \rho''}^{\mathfrak{A}} \tilde{s}'}$ T . By IH, this case has been proved.

- Case $\frac{\textcircled{x}.t ; s \rightsquigarrow_{\rho ; (\rho' \circ \rho'')}^{\mathfrak{A}} \tilde{s}'}{\tilde{t} \rightsquigarrow_{\rho}^{\mathfrak{A}} \tilde{t}'}$, Case $\frac{\tilde{t} \rightsquigarrow_{\rho}^{\mathfrak{A}} \tilde{t}' \quad \text{E}_z(\tilde{t}') \quad \textcircled{z}.s \rightsquigarrow_{\rho'}^{\mathfrak{A}} \tilde{s}''}{\tilde{t} ;_1 s \rightsquigarrow_{\rho \circ \rho'}^{\mathfrak{A}} \tilde{s}'' \quad \tilde{s}'' \rightsquigarrow_{\rho''}^{\mathfrak{A}} \tilde{s}'}$ T : $\frac{\tilde{t} \rightsquigarrow_{\rho \circ \rho'}^{\mathfrak{A}} \tilde{s}'}{\tilde{t} ;_1 s \rightsquigarrow_{(\rho \circ \rho') \circ \rho''}^{\mathfrak{A}} \tilde{s}'}$ T

Similar to the two cases above.

- Case $\frac{\textcircled{x}_0.t \rightsquigarrow_{\rho_0}^{\mathfrak{A}} \tilde{t}'_1 \quad \text{E}_{x_1}(\tilde{t}'_1) \quad \dots \quad \text{E}_{x_n}(\tilde{t}'_n) \quad \textcircled{x}_n.t \rightsquigarrow_{\rho'_n}^{\mathfrak{A}} \tilde{t}''_{n+1}}{\textcircled{x}_0.t^* \rightsquigarrow_{\rho_0 \circ \dots \circ \rho_{n-1} \circ \rho'_n}^{\mathfrak{A}} \tilde{t}''_{n+1} ;_1 t^* \quad \tilde{t}''_{n+1} ;_1 t^* \rightsquigarrow_{\rho''}^{\mathfrak{A}} \tilde{u}} \text{T}$: $\frac{\textcircled{x}_0.t^* \rightsquigarrow_{(\rho_0 \circ \dots \circ \rho_{n-1} \circ \rho'_n) \circ \rho''}^{\mathfrak{A}} \tilde{u}}{\textcircled{x}_0.t^* \rightsquigarrow_{\rho_0 \circ \dots \circ \rho_{n-1} \circ \rho'_n}^{\mathfrak{A}} \tilde{u}}$

For the form of the above of $\tilde{t}''_{n+1} ;_1 t^* \rightsquigarrow_{\rho''}^{\mathfrak{A}} \tilde{u}$, we distinguish the following cases (except for the rule (R)):

- Case $\frac{\tilde{t}''_{n+1} \rightsquigarrow_{\rho''}^{\mathfrak{A}} \tilde{t}'_{n+1}}{\tilde{t}''_{n+1} ;_1 t^* \rightsquigarrow_{\rho''}^{\mathfrak{A}} \tilde{t}'_{n+1} ;_1 t^*}$: Then we have:

$$\frac{\frac{\textcircled{x}_0.t \rightsquigarrow_{\rho_0}^{\mathfrak{A}} \tilde{t}'_1 \quad \text{E}_{x_1}(\tilde{t}'_1) \quad \dots \quad \text{E}_{x_n}(\tilde{t}'_n) \quad \frac{\textcircled{x}_n.t \rightsquigarrow_{\rho'_n}^{\mathfrak{A}} \tilde{t}''_{n+1} \quad \tilde{t}''_{n+1} \rightsquigarrow_{\rho''}^{\mathfrak{A}} \tilde{t}'_{n+1}}{\textcircled{x}_n.t \rightsquigarrow_{\rho'_n \diamond \rho''}^{\mathfrak{A}} \tilde{t}'_{n+1}} \text{T}}{\textcircled{x}_0.t^* \rightsquigarrow_{\rho_0 \diamond \dots \diamond (\rho'_n \diamond \rho'')}^{\mathfrak{A}} \tilde{t}'_{n+1} ;_1 t^*}} \text{T}.$$

Thus by IH, this case has been proved.

$$\text{-- Case } \frac{\tilde{t}''_{n+1} \rightsquigarrow_{\rho'_1}^{\mathfrak{A}} \tilde{t}'_{n+1} \quad \text{E}_{x_{n+1}}(\tilde{t}'_{n+1}) \quad \textcircled{x}_{n+1}.t^* \rightsquigarrow_{\rho'_2}^{\mathfrak{A}} \tilde{u}}{\tilde{t}'_{n+1} ;_1 t^* \rightsquigarrow_{\rho'_1 \diamond \rho'_2}^{\mathfrak{A}} \tilde{u}} \text{T} : \text{ For the form of the above of}$$

$\textcircled{x}_{n+1}.t^* \rightsquigarrow_{\rho'_2}^{\mathfrak{A}} \tilde{u}$, we distinguish the following cases:

$$\text{* Case } \frac{}{\textcircled{x}_{n+1}.t^* \rightsquigarrow_{1^{x_{n+1}}}^{\mathfrak{A}} \textcircled{x}_{n+1}.t^*} \text{R (then, } \rho'' = \rho'_1 \text{): Then we have:}$$

$$\frac{\frac{\textcircled{x}_0.t \rightsquigarrow_{\rho_0}^{\mathfrak{A}} \tilde{t}'_1 \quad \text{E}_{x_1}(\tilde{t}'_1) \quad \dots \quad \frac{\textcircled{x}_n.t \rightsquigarrow_{\rho'_n}^{\mathfrak{A}} \tilde{t}''_{n+1} \quad \tilde{t}''_{n+1} \rightsquigarrow_{\rho''}^{\mathfrak{A}} \tilde{t}'_{n+1}}{\textcircled{x}_n.t \rightsquigarrow_{\rho'_n \diamond \rho''}^{\mathfrak{A}} \tilde{t}'_{n+1}} \text{T}}{\textcircled{x}_0.t^* \rightsquigarrow_{\rho_0 \diamond \dots \diamond \rho_{n-1} \diamond \rho'_n \diamond \rho''}^{\mathfrak{A}} \textcircled{x}_{n+1}.t^*}} \text{T} \quad \text{E}_{x_{n+1}}(\tilde{t}'_{n+1}).$$

Thus by IH, this case has been proved.

$$\text{* Case } \frac{\textcircled{x}_{n+1}.t \rightsquigarrow_{\rho_{n+1}}^{\mathfrak{A}} \tilde{t}'_{n+2} \quad \text{E}_{x_{n+2}}(\tilde{t}'_{n+2}) \quad \dots \quad \text{E}_{x_{m+1}}(\tilde{t}'_{m+1}) \quad \textcircled{x}_{m+1}.t \rightsquigarrow_{\rho_{m+1}}^{\mathfrak{A}} \tilde{t}'_{m+2}}{\textcircled{x}_{n+1}.t^* \rightsquigarrow_{\rho_{n+1} \diamond \dots \diamond \rho_{m+1}}^{\mathfrak{A}} \tilde{t}'_{m+2} ;_1 t^*} \text{T} :$$

Then by letting $\rho_n = \rho'_n \diamond \rho''_1$, we have:

$$\frac{\textcircled{x}_0.t \rightsquigarrow_{\rho_0}^{\mathfrak{A}} \tilde{t}'_1 \quad \text{E}_{x_1}(\tilde{t}'_1) \quad \dots \quad \text{E}_{x_{m+1}}(\tilde{t}'_{m+1}) \quad \textcircled{x}_{m+1}.t \rightsquigarrow_{\rho_{m+1}}^{\mathfrak{A}} \tilde{t}'_{m+2}}{\textcircled{x}_0.t^* \rightsquigarrow_{\rho_0 \diamond \dots \diamond \rho_{m+1}}^{\mathfrak{A}} \tilde{t}'_{m+2} ;_1 t^*} \text{T}.$$

Thus by IH, this case has been proved.

$$\bullet \text{ Case } \frac{\textcircled{x}_0.t \rightsquigarrow_{\rho_0}^{\mathfrak{A}} \tilde{t}'_1 \quad \text{E}_{x_1}(\tilde{t}'_1) \quad \dots \quad \text{E}_{x_n}(\tilde{t}'_n)}{\frac{\textcircled{x}_0.t^* \rightsquigarrow_{\rho_0 \diamond \dots \diamond \rho_{n-1}}^{\mathfrak{A}} \textcircled{x}_n.t^* \quad \textcircled{x}_n.t^* ;_1 t^* \rightsquigarrow_{\rho'_1}^{\mathfrak{A}} \tilde{u}}{\textcircled{x}_0.t^* \rightsquigarrow_{\rho_0 \diamond \dots \diamond \rho_{n-1}}^{\mathfrak{A}} \tilde{u}} \text{T}} : \text{ Similar to the case above.}$$

$$\bullet \text{ Case } \frac{\textcircled{x}.t \rightsquigarrow_{\rho}^{\mathfrak{A}} \tilde{t}' \quad \tilde{t}' \rightsquigarrow_{\rho'}^{\mathfrak{A}} \tilde{u}}{\textcircled{x}.t \rightsquigarrow_{\rho \diamond \rho'}^{\mathfrak{A}} \tilde{u}} \text{T} : \text{ We then have: } \frac{\textcircled{x}.t \rightsquigarrow_{\rho}^{\mathfrak{A}} \tilde{t}' \quad \tilde{t}' \rightsquigarrow_{\rho'}^{\mathfrak{A}} \tilde{u}}{\textcircled{x}.t \rightsquigarrow_{\rho \diamond \rho'}^{\mathfrak{A}} \tilde{u}} \text{T} . \text{ Thus}$$

by IH, this case has been proved.

$$\bullet \text{ Case } \frac{\textcircled{x}.s \rightsquigarrow_{\rho}^{\mathfrak{A}} \tilde{s}' \quad \tilde{s}' \rightsquigarrow_{\rho'}^{\mathfrak{A}} \tilde{u}}{\textcircled{x}.t + s \rightsquigarrow_{\rho \diamond \rho'}^{\mathfrak{A}} \tilde{u}} \text{T} : \text{ Similar to the case above.}$$

- $$\frac{\textcircled{x}.t \rightsquigarrow_{\rho_1}^{\mathfrak{A}} \tilde{t}' \quad \textcircled{x}.s \rightsquigarrow_{\rho_2}^{\mathfrak{A}} \tilde{s}' \quad E_z(\tilde{t}') \quad E_z(\tilde{s}')}{\textcircled{x}.t \cap s \rightsquigarrow_{\mathfrak{f}_1^x \diamond (\rho_1 \parallel \rho_2) \diamond j_1^z}^{\mathfrak{A}} \textcircled{z}.1} \quad \textcircled{z}.1 \rightsquigarrow_{\rho'}^{\mathfrak{A}} \tilde{u} \quad \mathbb{T},$$
- $$\frac{\tilde{t} \rightsquigarrow_{\rho_1}^{\mathfrak{A}} \tilde{t}' \quad \tilde{s} \rightsquigarrow_{\rho_2}^{\mathfrak{A}} \tilde{s}' \quad E_z(\tilde{t}') \quad E_z(\tilde{s}')}{\tilde{t} \cap_1 \tilde{s} \rightsquigarrow_{(\rho_1 \parallel \rho_2) \diamond j_1^z}^{\mathfrak{A}} \textcircled{z}.1} \quad \textcircled{z}.1 \rightsquigarrow_{\rho'}^{\mathfrak{A}} \tilde{u} \quad \mathbb{T} :$$
 Then the right-hand side rule should be the rule (R); thus, this case has already been proved.
- $$\frac{\textcircled{x}.t \rightsquigarrow_{\rho_1}^{\mathfrak{A}} \tilde{t}'' \quad \textcircled{x}.s \rightsquigarrow_{\rho_2}^{\mathfrak{A}} \tilde{s}''}{\textcircled{x}.t \cap s \rightsquigarrow_{\mathfrak{f}_1^x \diamond (\rho_1 \parallel \rho_2)}^{\mathfrak{A}} \tilde{t}'' \cap_1 \tilde{s}''} \quad \tilde{t}'' \cap_1 \tilde{s}'' \rightsquigarrow_{\rho'}^{\mathfrak{A}} \tilde{u} \quad \mathbb{T} :$$
 For the form of the above of $\tilde{t}'' \cap_1 \tilde{s}'' \rightsquigarrow_{\rho'}^{\mathfrak{A}} \tilde{u}$, we distinguish the following cases (except for the rule (R)):
- Case $\frac{\tilde{t}'' \rightsquigarrow_{\rho_1}^{\mathfrak{A}} \tilde{t}' \quad \tilde{s}'' \rightsquigarrow_{\rho_2}^{\mathfrak{A}} \tilde{s}'}{\tilde{t}'' \cap_1 \tilde{s}'' \rightsquigarrow_{\rho_1 \parallel \rho_2}^{\mathfrak{A}} \tilde{t}' \cap_1 \tilde{s}'}$: Then we have:
- $$\frac{\textcircled{x}.t \rightsquigarrow_{\rho_1}^{\mathfrak{A}} \tilde{t}'' \quad \tilde{t}'' \rightsquigarrow_{\rho_1}^{\mathfrak{A}} \tilde{t}' \quad \textcircled{x}.s \rightsquigarrow_{\rho_1}^{\mathfrak{A}} \tilde{s}'' \quad \tilde{s}'' \rightsquigarrow_{\rho_1}^{\mathfrak{A}} \tilde{s}'}{\textcircled{x}.t \rightsquigarrow_{\rho_1 \diamond \rho_1}^{\mathfrak{A}} \tilde{t}' \quad \textcircled{x}.s \rightsquigarrow_{\rho_2 \diamond \rho_2}^{\mathfrak{A}} \tilde{s}' \quad \mathbb{T}} \quad \mathbb{T}.$$
- $$\frac{\textcircled{x}.t \cap s \rightsquigarrow_{\mathfrak{f}_1^x \diamond ((\rho_1 \diamond \rho_1) \parallel (\rho_2 \diamond \rho_2))}^{\mathfrak{A}} \tilde{t}' \cap_1 \tilde{s}'}{\textcircled{x}.t \cap s \rightsquigarrow_{\mathfrak{f}_1^x \diamond ((\rho_1 \diamond \rho_1) \parallel (\rho_2 \diamond \rho_2)) \diamond j_1^z}^{\mathfrak{A}} \tilde{t}' \cap_1 \tilde{s}'}$$
- Note that $\mathfrak{f}_1^x \diamond ((\rho_1 \diamond \rho_1) \parallel (\rho_2 \diamond \rho_2)) = (\mathfrak{f}_1^x \diamond (\rho_1 \parallel \rho_2)) \diamond (\rho_1' \parallel \rho_2')$. Thus by IH, this case has been proved.
- Case $\frac{\tilde{t}'' \rightsquigarrow_{\rho_1}^{\mathfrak{A}} \tilde{t}' \quad \tilde{s}'' \rightsquigarrow_{\rho_2}^{\mathfrak{A}} \tilde{s}' \quad E_z(\tilde{t}') \quad E_z(\tilde{s}')}{\tilde{t}'' \cap_1 \tilde{s}'' \rightsquigarrow_{(\rho_1' \parallel \rho_2') \diamond j_1^z}^{\mathfrak{A}} \textcircled{z}.1}$: Then we have:
- $$\frac{\textcircled{x}.t \rightsquigarrow_{\rho_1}^{\mathfrak{A}} \tilde{t}'' \quad \tilde{t}'' \rightsquigarrow_{\rho_1}^{\mathfrak{A}} \tilde{t}' \quad \textcircled{x}.s \rightsquigarrow_{\rho_1}^{\mathfrak{A}} \tilde{s}'' \quad \tilde{s}'' \rightsquigarrow_{\rho_1}^{\mathfrak{A}} \tilde{s}'}{\textcircled{x}.t \rightsquigarrow_{\rho_1 \diamond \rho_1}^{\mathfrak{A}} \tilde{t}' \quad \textcircled{x}.s \rightsquigarrow_{\rho_2 \diamond \rho_2}^{\mathfrak{A}} \tilde{s}' \quad \mathbb{T}} \quad \mathbb{T} \quad E_z(\tilde{t}') \quad E_z(\tilde{s}').$$
- $$\frac{\textcircled{x}.t \cap s \rightsquigarrow_{\mathfrak{f}_1^x \diamond ((\rho_1 \diamond \rho_1) \parallel (\rho_2 \diamond \rho_2)) \diamond j_1^z}^{\mathfrak{A}} \tilde{t}' \cap_1 \tilde{s}'}{\textcircled{x}.t \cap s \rightsquigarrow_{\mathfrak{f}_1^x \diamond ((\rho_1 \diamond \rho_1) \parallel (\rho_2 \diamond \rho_2)) \diamond j_1^z}^{\mathfrak{A}} \tilde{t}' \cap_1 \tilde{s}'}$$
- Note that $\mathfrak{f}_1^x \diamond ((\rho_1 \diamond \rho_1) \parallel (\rho_2 \diamond \rho_2)) \diamond j_1^z = (\mathfrak{f}_1^x \diamond (\rho_1 \parallel \rho_2)) \diamond ((\rho_1' \parallel \rho_2') \diamond j_1^z)$. Thus by IH, this case has been proved.
- $$\frac{\tilde{t} \rightsquigarrow_{\rho_1}^{\mathfrak{A}} \tilde{t}'' \quad \tilde{s} \rightsquigarrow_{\rho_2}^{\mathfrak{A}} \tilde{s}''}{\tilde{t} \cap s \rightsquigarrow_{\rho_1 \parallel \rho_2}^{\mathfrak{A}} \tilde{t}'' \cap_1 \tilde{s}''} \quad \tilde{t}'' \cap_1 \tilde{s}'' \rightsquigarrow_{\rho'}^{\mathfrak{A}} \tilde{u} \quad \mathbb{T} :$$
 Similar to the case above.
- $$\frac{\tilde{t} \cap s \rightsquigarrow_{\rho_1 \parallel \rho_2}^{\mathfrak{A}} \tilde{t}'' \cap_1 \tilde{s}'' \quad \tilde{t}'' \cap_1 \tilde{s}'' \rightsquigarrow_{\rho'}^{\mathfrak{A}} \tilde{u} \quad \mathbb{T}}{\tilde{t} \cap_1 \tilde{s} \rightsquigarrow_{(\rho_1 \parallel \rho_2) \diamond \rho'}^{\mathfrak{A}} \tilde{u} \quad \mathbb{T}}$$

Hence, this completes the proof. \square

ACKNOWLEDGMENT

We would like to thank anonymous referees of LICS 2017 for useful comments. This work was supported by JSPS KAKENHI Grant Numbers JP16J08119, JP21K13828.

REFERENCES

- [AB95] Hajnal Andréka and D. A. Bredikhin. The equational theory of union-free algebras of relations. *Algebra Universalis*, 33(4):516–532, 1995. doi:10.1007/BF01225472.
- [AMN11] Hajnal Andréka, Szabolcs Mikulás, and István Németi. The equational theory of Kleene lattices. *Theoretical Computer Science*, 412(52):7099–7108, 2011. doi:10.1016/J.TCS.2011.09.024.
- [Ant96] Valentin Antimirov. Partial derivatives of regular expressions and finite automaton constructions. *Theoretical Computer Science*, 155(2):291–319, 1996. doi:10.1016/0304-3975(95)00182-4.
- [AtC07] Carlos Areces and Balder ten Cate. Hybrid logics. In *Handbook of Modal Logic*, volume 3 of *Studies in Logic and Practical Reasoning*, pages 821–868. Elsevier, 2007. doi:10.1016/S1570-2464(07)80017-6.
- [BBM⁺16] Rafaela Bastos, Sabine Broda, António Machiavelo, Nelma Moreira, and Rogério Reis. On the state complexity of partial derivative automata for regular expressions with intersection. In *DCFS*, volume 9777 of *LNTCS*, pages 45–59. Springer, 2016. doi:10.1007/978-3-319-41114-9_4.
- [BÉS95] S. L. Bloom, Z. Ésik, and Gh. Stefanescu. Notes on equational theories of relations. *algebra universalis*, 33(1):98–126, 1995. doi:10.1007/BF01190768.
- [BGK⁺16] Filippo Bonchi, Fabio Gadducci, Aleks Kissinger, Paweł Sobociński, and Fabio Zanasi. Rewriting modulo symmetric monoidal structure. In *LICS*, page 710–719. ACM, 2016. doi:10.1145/2933575.2935316.
- [Bod98] Hans L. Bodlaender. A partial k -arboretum of graphs with bounded treewidth. *Theoretical Computer Science*, 209(1-2):1–45, 1998. doi:10.1016/S0304-3975(97)00228-4.
- [BP15] Paul Brunet and Damien Pous. Petri automata for Kleene allegories. In *LICS*, pages 68–79. IEEE, 2015. doi:10.1109/LICS.2015.17.
- [BP16a] Mikołaj Bojańczyk and Michał Pilipczuk. Definability equals recognizability for graphs of bounded treewidth. In *LICS*, pages 407–416. ACM, 2016. doi:10.1145/2933575.2934508.
- [BP16b] Paul Brunet and Damien Pous. Algorithms for Kleene algebra with converse. *Journal of Logical and Algebraic Methods in Programming*, 85(4):574–594, 2016. doi:10.1016/J.JLAMP.2015.07.005.
- [BP17] Paul Brunet and Damien Pous. Petri automata. *Logical Methods in Computer Science*, 13(3), 2017. doi:10.23638/LMCS-13(3:33)2017.
- [Bru17] Paul Brunet. Reversible Kleene lattices. In *MFCS*, volume 83 of *LIPICs*, pages 66:1–66:14. Schloss Dagstuhl, 2017. doi:10.4230/LIPICs.MFCS.2017.66.
- [Brz64] Janusz A. Brzozowski. Derivatives of regular expressions. *Journal of the ACM*, 11(4):481–494, 1964. doi:10.1145/321239.321249.
- [CDG⁺07] Hubert Comon, Max Dauchet, Rémi Gilleron, Florent Jacquemard, Denis Lugiez, Christof Löding, Sophie Tison, and Marc Tommasi. Tree automata techniques and applications, 2007. URL: <http://www.grappa.univ-lille3.fr/tata>.
- [CDGLV02] Diego Calvanese, Giuseppe De Giacomo, Maurizio Lenzerini, and Moshe Y. Vardi. View-based query answering and query containment over semistructured data. In *DBPL*, volume 2397 of *LNCS*, pages 40–61. Springer, 2002. doi:10.1007/3-540-46093-4_3.
- [CE12] Bruno Courcelle and Joost Engelfriet. *Graph Structure and Monadic Second-Order Logic*. Number 138 in *Encyclopedia of Mathematics and its Applications*. Cambridge University Press, 2012. doi:10.1017/CB09780511977619.
- [CM77] Ashok K. Chandra and Philip M. Merlin. Optimal implementation of conjunctive queries in relational data bases. In *STOC*, pages 77–90. ACM, 1977. doi:10.1145/800105.803397.
- [Con71] John H. Conway. *Regular Algebra and Finite Machines*. Chapman and Hall, 1971.
- [Cou88] Bruno Courcelle. The monadic second-order logic of graphs, II: Infinite graphs of bounded width. *Mathematical Systems Theory*, 21(1):187–221, 1988. doi:10.1007/BF02088013.
- [Cou90] Bruno Courcelle. The monadic second-order logic of graphs. I. recognizable sets of finite graphs. *Information and Computation*, 85(1):12–75, 1990. doi:10.1016/0890-5401(90)90043-H.
- [Dan84a] Ryszard Danecki. Nondeterministic propositional dynamic logic with intersection is decidable. In *SCT*, volume 208 of *LNCS*, pages 34–53. Springer, 1984. doi:10.1007/3-540-16066-3_5.
- [Dan84b] Ryszard Danecki. Propositional dynamic logic with strong loop predicate. In *MFCS*, volume 176 of *LNCS*, pages 573–581. Springer, 1984. doi:10.1007/BFb0030342.

- [DP18] Amina Doumane and Damien Pous. Completeness for identity-free Kleene lattices. In *CONCUR*, volume 118 of *LIPICs*, pages 18:1–18:17. Schloss Dagstuhl, 2018. doi:10.4230/LIPICs.CONCUR.2018.18.
- [EF95] Heinz-Dieter Ebbinghaus and Jörg Flum. *Finite Model Theory*. Springer, 1995. doi:10.1007/3-540-28788-4.
- [Epp92] David Eppstein. Parallel recognition of series-parallel graphs. *Information and Computation*, 98(1):41–55, 1992. doi:10.1016/0890-5401(92)90041-D.
- [FFP23] Diego Figueira, Santiago Figueira, and Edwin Pin. PDL on steroids: on expressive extensions of PDL with intersection and converse. In *LICS*, pages 1–13. IEEE, 2023. doi:10.1109/LICS56636.2023.10175813.
- [FL79] Michael J. Fischer and Richard E. Ladner. Propositional dynamic logic of regular programs. *Journal of Computer and System Sciences*, 18(2):194–211, 1979. doi:10.1016/0022-0000(79)90046-1.
- [FS90] Peter J. Freyd and Andre Scedrov. *Categories. Allegories*, volume 39. North-Holland, 1990. doi:10.1016/S0924-6509(08)70048-5.
- [Fü80] Martin Fürer. The complexity of the inequivalence problem for regular expressions with intersection. In *ICALP*, volume 85 of *LNCS*, pages 234–245. Springer, 1980. doi:10.1007/3-540-10003-2_74.
- [Giv07] Steven Givant. The calculus of relations as a foundation for mathematics. *Journal of Automated Reasoning*, 37(4):277–322, 2007. doi:10.1007/s10817-006-9062-x.
- [GLL09] Stefan Göller, Markus Lohrey, and Carsten Lutz. PDL with intersection and converse: satisfiability and infinite-state model checking. *The Journal of Symbolic Logic*, 74(1):279–314, 2009. doi:10.2178/jsl/1231082313.
- [GO14] Viliam Geffert and Alexander Okhotin. Transforming two-way alternating finite automata to one-way nondeterministic automata. In *MFCS*, volume 8634 of *LNTCS*, pages 291–302. Springer, 2014. doi:10.1007/978-3-662-44522-8_25.
- [GP90] George Gargov and Solomon Passy. A note on boolean modal logic. In *Mathematical Logic*, pages 299–309. Springer, 1990. doi:10.1007/978-1-4613-0609-2_21.
- [Hir18] Robin Hirsch. Decidability of equational theories for subsignatures of relation algebra. In *RAMICS*, volume 11194 of *LNCS*, pages 87–96. Springer, 2018. doi:10.1007/978-3-030-02149-8_6.
- [Kle56] Stephen C. Kleene. Representation of events in nerve nets and finite automata. In *Automata Studies. (AM-34)*, pages 3–42. Princeton University Press, 1956. doi:10.1515/9781400882618-002.
- [Koz91] Dexter Kozen. A completeness theorem for Kleene algebras and the algebra of regular events. In *LICS*, pages 214–225. IEEE, 1991. doi:10.1109/LICS.1991.151646.
- [Koz97] Dexter Kozen. Kleene algebra with tests. *ACM Transactions on Programming Languages and Systems*, 19(3):427–443, 1997. doi:10.1145/256167.256195.
- [KS96] Dexter Kozen and Frederick Smith. Kleene algebra with tests: Completeness and decidability. In *CSL*, volume 1258 of *LNCS*, pages 244–259. Springer, 1996. doi:10.1007/3-540-63172-0_43.
- [KZ21] Christos Kapoutsis and Mohammad Zakzok. Alternation in two-way finite automata. *Theoretical Computer Science*, 870:75–102, 2021. doi:10.1016/j.tcs.2020.12.011.
- [LL05] Martin Lange and Carsten Lutz. 2-exptime lower bounds for propositional dynamic logics with intersection. *The Journal of Symbolic Logic*, 70(04):1072–1086, 2005. doi:10.2178/jsl/1129642115.
- [LLS78] Richard E. Ladner, Richard J. Lipton, and Larry J. Stockmeyer. Alternating pushdown automata. In *SFCS*, pages 92–106. IEEE, 1978. doi:10.1109/SFCS.1978.6.
- [LLS84] Richard E. Ladner, Richard J. Lipton, and Larry J. Stockmeyer. Alternating pushdown and stack automata. *SIAM Journal on Computing*, 13(1):135–155, 1984. doi:10.1137/0213010.
- [Lut05] Carsten Lutz. PDL with intersection and converse is decidable. In *CSL*, volume 3634 of *LNTCS*, pages 413–427. Springer, 2005. doi:10.1007/11538363_29.
- [LW98] K. Lodaya and P. Weil. Series-parallel posets: Algebra, automata and languages. In *STACS*, volume 1373 of *LNCS*, pages 555–565. Springer, 1998. doi:10.1007/BFb0028590.
- [LW00] K. Lodaya and P. Weil. Series-parallel languages and the bounded-width property. *Theoretical Computer Science*, 237(1):347–380, 2000. doi:10.1016/S0304-3975(00)00031-1.
- [LW01] K. Lodaya and P. Weil. Rationality in algebras with a series operation. *Information and Computation*, 171(2):269–293, 2001. doi:10.1006/inco.2001.3077.

- [LW05] Carsten Lutz and Dirk Walther. PDL with negation of atomic programs. *Journal of Applied Non-Classical Logics*, 15(2):189–213, 2005. doi:10.3166/janc1.15.189-213.
- [Mak04] J. A. Makowsky. Algorithmic uses of the feferman–vaught theorem. *Annals of Pure and Applied Logic*, 126(1):159–213, 2004. doi:10.1016/j.apal.2003.11.002.
- [MS72] A. R. Meyer and L. J. Stockmeyer. The equivalence problem for regular expressions with squaring requires exponential space. In *SWAT*, pages 125–129. IEEE, 1972. doi:10.1109/SWAT.1972.29.
- [Nak17] Yoshiki Nakamura. Partial derivatives on graphs for Kleene allegories. In *LICS*, pages 1–12. IEEE, 2017. doi:10.1109/LICS.2017.8005132.
- [Nak19] Yoshiki Nakamura. The undecidability of FO3 and the calculus of relations with just one binary relation. In *ICLA*, volume 11600 of *LNTCS*, pages 108–120. Springer, 2019. doi:10.1007/978-3-662-58771-3_11.
- [Nak20] Yoshiki Nakamura. Expressive power and succinctness of the positive calculus of relations. In *RAMICS*, volume 12062 of *LNTCS*, pages 204–220. Springer, 2020. doi:10.1007/978-3-030-43520-2_13.
- [Nak22] Yoshiki Nakamura. Expressive power and succinctness of the positive calculus of binary relations. *Journal of Logical and Algebraic Methods in Programming*, 127:100760, 2022. doi:10.1016/j.jlamp.2022.100760.
- [Nak23] Yoshiki Nakamura. Existential calculi of relations with transitive closure: Complexity and edge saturations. In *LICS*, pages 1–13. IEEE, 2023. doi:10.1109/LICS56636.2023.10175811.
- [Nak24a] Yoshiki Nakamura. Finite relational semantics for language Kleene algebra with complement, 2024. URL: <https://hal.science/hal-04455882>.
- [Nak24b] Yoshiki Nakamura. Undecidability of the positive calculus of relations with transitive closure and difference: Hypothesis elimination using graph loops. In *RAMICS*, volume 14787 of *LNTCS*, pages 207–224. Springer, 2024. doi:10.1007/978-3-031-68279-7_13.
- [Ng84] Kan Ching Ng. *Relation algebras with transitive closure*. PhD thesis, University of California, 1984.
- [Pou18] Damien Pous. On the positive calculus of relations with transitive closure. In *STACS*, volume 96 of *LIPICs*, pages 3:1–3:16. Schloss Dagstuhl, 2018. doi:10.4230/LIPICs.STACS.2018.3.
- [PV18] Damien Pous and Valeria Vignudelli. Allegories: decidability and graph homomorphisms. In *LICS*, pages 829–838. ACM, 2018. doi:10.1145/3209108.3209172.
- [PW23] Damien Pous and Jana Wagemaker. Completeness theorems for Kleene algebra with tests and top, 2023. doi:10.48550/arXiv.2304.07190.
- [RRV17] Juan L. Reutter, Miguel Romero, and Moshe Y. Vardi. Regular queries on graph databases. *Theory of Computing Systems*, 61(1):31–83, 2017. doi:10.1007/s00224-016-9676-2.
- [RS83] Neil Robertson and Paul D. Seymour. Graph minors. I. excluding a forest. *Journal of Combinatorial Theory, Series B*, 35(1):39–61, 1983. doi:10.1016/0095-8956(83)90079-5.
- [RS86] Neil Robertson and Paul D. Seymour. Graph minors. II. algorithmic aspects of tree-width. *Journal of Algorithms*, 7(3):309–322, 1986. doi:10.1016/0196-6774(86)90023-4.
- [Sak09] Jacques Sakarovitch. *Elements of Automata Theory*. Cambridge University Press, 2009. doi:10.1017/CB09781139195218.
- [Sav70] Walter Savitch. Relationships between nondeterministic and deterministic tape complexities. *Journal of Computer and System Sciences*, 4(2):177–192, 1970. doi:10.1016/S0022-0000(70)80006-X.
- [Sed23] Igor Sedlár. Kleene algebra with dynamic tests: Completeness and complexity, 2023. doi:10.48550/arXiv.2311.06937.
- [Tar41] Alfred Tarski. On the calculus of relations. *The Journal of Symbolic Logic*, 6(3):73–89, 1941. doi:10.2307/2268577.
- [TG87] Alfred Tarski and Steven Givant. *A Formalization of Set Theory without Variables*, volume 41. American Mathematical Society, 1987. doi:10.1090/coll/041.
- [VTL79] Jacobo Valdes, Robert E. Tarjan, and Eugene L. Lawler. The recognition of series parallel digraphs. In *STOC*, page 1–12. ACM, 1979. doi:10.1145/800135.804393.