

Less Is More: A Mixed-Methods Study on Security-Sensitive API Calls in Java for Better Dependency Selection

Imranur Rahman*, Ranindya Paramitha†, Henrik Plate‡, Dominik Wermke*, Laurie Williams*

*North Carolina State University
{irahman3, dwerkme, lawilli3}@ncsu.com

†Università degli Studi di Trento
{ranindya.paramitha}@unitn.it

‡Endor Labs
{henrik}@endor.ai

arXiv:2408.02846v1 [cs.CR] 5 Aug 2024

Abstract—[Background:] Security-sensitive APIs provide access to security-sensitive resources, e.g., the filesystem or network resources. Including such API calls—directly or through dependencies—increases the application’s attack surface. An example of such a phenomenon is Log4Shell, which rendered many applications vulnerable due to network-related capabilities (JNDI lookup) in log4j package. Before the Log4Shell incident, alternate logging libraries to log4j were available that do not make JNDI lookup calls. [Problem:] The impact of such an incident would be minimal if information about network-related API calls by logging libraries were available to the developers. And so the lack of visibility into the calls to these security-sensitive APIs by functionally similar open-source packages makes it difficult for developers to use them as a dependency selection criterion. [Goal:] *The goal of this study is to aid developers in selecting their dependency by understanding security-sensitive APIs in their dependency through call graph analysis.* [Methodology:] We conducted a mixed-methods study with 45 Java packages and defined a list of 219 security-sensitive APIs. We categorized these 219 APIs into 3 themes and 15 categories. We then used call graph analysis to analyze the prevalence of these APIs in our selected package versions, with and without their dependencies. Finally, we conducted a survey with open-source developers (110 respondents) showing the comparison of functionally similar packages w.r.t. security-sensitive API calls to understand the usefulness of this API information in the dependency selection process. [Result:] The number of security-sensitive API calls of functionally similar packages can vary from 0 to 368 in one API category and 0 to 429 in total. Our survey results show that 73% developers agree that information about the number and type of security-sensitive API calls of functionally similar packages would have been useful in their dependency selection.

I. INTRODUCTION

“Why would a logging package need a JNDI lookup feature?” This question illustrates the surprise of many log4j users when the Log4Shell (CVE-2021-44228) vulnerability was disclosed in 2021. The vulnerable versions of log4j included a JNDI lookup feature, which allowed downloading a remote object from an attacker-controlled website. Interestingly, the JNDI lookup was added to log4j as a feature request by a user in 2013 [1]. This JNDI lookup API can be categorized as a security-sensitive API, an API that can

TABLE I. API usage in 5 Java dependency injection packages.
F: FILESYSTEM, *N*: NETWORK, *P*: PROCESS.

Alternates	F/Modification	F/Read	Network	Env	F/Input	F/Output	FMiscellaneous	F/Read	Env	N/Socket	N/Naming	Directory	N/Connection	P/Reflection	P/Code	Crypto	P/Scripting	P/Operating	System	Total
dagger	0	0	0	0	0	0	0	0	0	0	0	0	0	0	0	0	0	0	0	0
guice	0	0	1	35	0	4	0	0	0	0	1	66	1	0	0	0	0	0	0	108
jakarta.inject-api	0	0	0	0	0	0	0	0	0	0	0	0	0	0	0	0	0	0	0	0
spring-beans	0	0	3	1	12	17	0	0	0	0	6	235	3	0	0	0	0	0	0	277
spring-context	1	0	3	4	12	20	0	4	0	7	368	2	8	0	0	0	0	0	0	429

access a security-sensitive resource. However, logback-classic does not call the JNDI lookup method but provides similar logging functionalities as log4j. The Log4Shell incident highlights that developers are not always aware of how their dependencies (direct or transitive) might enable inappropriate resource access through security-sensitive API and if there is a better alternative available w.r.t. security-sensitive API calls. For example, log4j-core and logback-classic have similar functionalities, but unlike log4j-core, logback-classic does not call the JNDI lookup method and has no NETWORK/HTTP call. A similar trend also happens in other package categories (e.g., the dependency injection packages in Table I) that functionally similar packages can have different security-sensitive API calls (more in Section IV-B). As shown in Table I, a developer choosing a dependency injection package may care to understand that dagger has 0 calls to sensitive APIs, and spring-context has 429 calls to sensitive APIs.

Previous research shows developers prioritize factors such as popularity, documentation, ease of use, recent release, and commit frequency before choosing a package as dependency [2]–[4]. In addition, based upon an in-depth interview with 27 developers, Wermke et al. [5] found that developers often overlook the source code or APIs used in the package. Understanding the capabilities of a package is important [6] yet challenging due to the lack of research exploring security-sensitive API. Understanding what sensitive resources a package can access becomes even more difficult considering its dependencies because of the lack of available tools. Depen-

dependency management and tracking what a dependency pulls into a project become more challenging for developers with more dependencies. Moreover, with Java Security Manager being deprecated in Java 17, developers have fewer tools to control the access of their (direct and transitive) dependencies to sensitive resources [7]–[9].

In this study, we propose security-sensitive API calls in a package (with and without its dependencies) as a criterion for the dependency selection process. We hypothesize that the more sensitive APIs or sensitive resources a package uses, the higher the risk of having associated vulnerabilities. In this mixed-methods study, we quantitatively and qualitatively analyzed the prevalence of security-sensitive APIs in functionally similar open-source packages. Then we conducted a developer survey to validate the usefulness of security-sensitive API calls in the dependency selection process.

The goal of this study is to aid developers in selecting their dependency by understanding security-sensitive APIs in their dependency through call graph analysis.

Toward this goal, we defined three research questions (RQs):

RQ1: *What are the security-sensitive APIs in Java?*

RQ2: *How frequently do open-source packages call security-sensitive APIs? How does the use of security-sensitive APIs change when including the packages' direct and indirect dependencies?*

RQ3: *How useful do developers find security-sensitive API information for selecting an open-source package as a dependency?*

Before analyzing the security-sensitive APIs in functionally similar packages, we need to have a comprehensive list of security-sensitive APIs in Java. We started by looking at the JDK JavaDoc and defined a preliminary set of security-sensitive APIs. We then enriched the set by looking at the fix of the common vulnerabilities and exposures (CVE) affecting these packages; and the code examples of the common weakness enumeration (CWE)s associated with those CVEs. Using this three-pronged approach, we define a list of 219 Java security-sensitive APIs (**RQ1**). After that, we quantitatively and qualitatively analyzed the comparison of the security-sensitive API usage in individual packages and package categories to understand the prevalence of the security-sensitive APIs. For this analysis, we used the call graphs of packages, with and without their dependencies, to measure the prevalence of the use of the security-sensitive API (**RQ2**). Finally, we conducted a survey with developers to understand if the security-sensitive API calls of functionally similar packages can be useful to developers' dependency selection process (**RQ3**).

In summary, our contributions are as follows:

- A user study on the usefulness of the security-sensitive API call information for dependency selection.
- Call graph analysis of the security-sensitive APIs prevalence in Java packages, with and without their dependencies.
- A list of security-sensitive API in Java.

Our replication package also contains manually verified vulnerable functions associated with 255 CVEs.

II. TERMINOLOGY

In this section, we formally define a dependency (direct vs transitive), a call graph (without vs with dependencies), and a security-sensitive API.

Definition 1 (Dependency). *A dependency is a package that is required by another package to function properly. A direct dependency is a package that is explicitly required by the package. A transitive dependency is a package that is required by direct dependencies but not explicitly required by the package.*

For example, log-parser package needs log4j-core and log4j-core needs log4j-api to function. In this case, log4j-core is a direct and log4j-api is a transitive dependency of log-parser.

Definition 2 (Security-Sensitive API). *We define a security-sensitive API as an API that can be used to access security-sensitive resources, the filesystem, network, or system processes.*

`java.io.File.createTempFile()`, `java.net.Socket.connect()`, `javax.script.ScriptEngine.eval()`, and `java.lang.Runtime.load()` are examples of security-sensitive APIs.

Definition 3 (Intra-Package and Inter-Package Call Graph). *An intra-package call graph is created by analyzing the code of a single package and represents the <caller, callee> relationships between methods of types defined in the package and methods of other types, defined both within or outside the package.*

An inter-package call graph is created by stitching the intra-package call graphs of a given package and its dependencies, which means that callee types specified in intra-package call graphs are resolved to all possible implementation types. As a result, an inter-package call graph represents all <caller, callee> relationships between methods in a package and its dependencies that can be connected to a given package.

For example, log4j-core's method `ConfigurationSource.fromUri()` calls the static method `FileUtils.fileFromUri()` and instantiates `java.io.FileInputStream`, which is represented by corresponding call graph edges in the intra- and inter-package call graphs of log4j-core.

III. METHODOLOGY

This section describes our methodology for API list construction (Figure 1), analysis, and developer survey.

A. Package Selection

To find out the usefulness of security-sensitive API information in selecting dependencies, we need to have several functionally similar packages for a specific language (so that they are alternatives to each other) in different package categories. Finding functionally similar packages for one specific language is necessary to make sure we only use analogous packages when comparing. Package categories here are from a coarse-grained categorization by Maven [10] based on the packages' main functionalities. As they are coarse-grained,

TABLE II. Chosen Core Packages

Category	Package Names
Dependency Injection	<i>dagger, guice, jakarta.enterprise.cdi-api, jakarta.inject-api, javax.inject, spring-beans, spring-context</i>
HTTP Client	<i>httplasyncclient, httpclient5, jetty-client, okhttp, retrofit</i>
I/O Utilities	<i>commons-io, jetty-io, okio, plexus-io</i>
JDBC Driver	<i>derby, derbyclient, mariadb-java-client, mssql-jdbc, mysql-connector-j, postgresql, sqlite-jdbc</i>
JSON Libraries	<i>fastjson2, gson, jackson-core, json</i>
Logging	<i>log4j-core, logback-classic, jboss-logging, timber</i>
Web Frameworks	<i>jakarta.faces-api, spring-boot-starter-web, spring-web, spring-webflow, spring-webmvc, struts2-core, tapestry-core, vaadin, wicket-core</i>
XML Parsers	<i>dom4j, jakarta.xml.bin-api, jaxb-api, xercesImpl, xstream</i>

there is a possibility that the fine-grained functionality of packages in the same category is not the same or they work for different programming languages. For example, in the logging category, *log4j-core* and *logback-classic* have similar functionalities and work for Java, but *scala-logging* works for Scala. Later on, we would provide this alternative to developers with their security-sensitive API call and ask them whether they would consider the information in their selection.

Our package selection process consisted of six individual steps. At first, we take the top 25 most used categories of open-source packages from MvnRepository [10] (Step ①). We then applied three *inclusion criteria* on package category: packages that are (a) used at runtime (excludes anything related to building, testing, or mocking); (b) providing alternative functionality for a given task (eg. the category “Java Specifications” does not meet this criterion because the range of tasks done in this category is too broad); and (c) used in “typical” server-side Java Web applications (which makes it possible to create call graphs using a variety of open-source and proprietary tools and excludes other JVM languages). With these inclusion criteria, we ended up with eight categories, as shown in Table II (Step ②). JDBC driver category is an exception in the sense that the choice is determined by the underlying database developers are using. Our intuition behind keeping this category is alternative DB drivers might have similar implementations.

We then focused on the top 15 packages in each category from MvnRepository [10]. We applied two *exclusion criteria* on packages: packages that (1) are used for other JVM languages like Kotlin or Scala and (2) have not been updated since 2019 (Step ③). We then used an expert selection process following negotiator agreement techniques [11] to agree on a set of packages in each of the eight categories that can be used as alternatives to each other (Step ④). Two graduate students, one industry professional, and one faculty advisor conducted this expert selection process, where three authors went through the packages and selected the alternative packages, and all four authors reached a consensus on the final selection. After this process, we have 45 packages, as shown in Table II.

There are 255 CVEs in our chosen 45 packages, and their

dependencies (by June 2024) recorded by [a company that will be revealed upon paper acceptance]. We then map these CVEs to OWASP’s Top 10 [12] (Step ⑤). If the CVE has no mapping to OWASP’s Top 10, we check if the CVE has a parent that has a mapping to OWASP’s Top 10 and maps it as such, otherwise, we map it as “Others”. Other than the ones outside the OWASP mapping, most CVEs are in A08: Software and Data Integrity Failures categories (79/255), A01: Broken Access Control (41/255), and A03: Injection (40/255).

From these 45 core packages, we have 4,183 package versions after excluding unavailable versions, ie. missing POM or JAR files in Maven Central. We then added the unique packages from these package versions’ dependency trees to our list, which gives us a total of 1,210 packages (Step ⑥). At the end, we have 30,772 package versions to analyze.

B. Security-Sensitive API List Construction and Categorization (RQ1)

To construct our security-sensitive API list, we used a three-pronged approach, as illustrated in Figure 1:

- 1) **JDK:** One author went through all the API documentation from Java 11 and selected a preliminary list by looking at whether they are accessing sensitive resources: file system, network, and process. This preliminary list contains 127 security-sensitive APIs.
- 2) **CVE fixes:** One author went through the 255 CVE fixes using VFCFinder [13] to find out APIs associated with the system or information compromise if the vulnerability was exploited. For APIs coming from the vulnerability fixes, we look into whether the API call is added, removed, or modified in the fix. This process resulted in 76 security-sensitive APIs of which 66 are new (were not in the preliminary list). We analyze the CVEs related to these CVEs in the next part.
- 3) **CWE examples:** One author went through the MITRE CWE [14] for each of the 71 unique CVEs coming from the 255 CVEs to find common examples of exploitation in Java. If no example was found in MITRE, we rely on Google and ChatGPT to provide examples. In this way, we assemble a list of APIs that are present in the CWE examples. From this process, we got 42 security-sensitive APIs of which 26 are new (not in the list of other 2 steps).

Another author reviewed the results from all approaches, and finally, all three authors reached a consensus on the final security-sensitive API list, consisting of 219 APIs. During this construction, we also have two rules of thumb:

- (a) If a class has one or more security-sensitive APIs (methods), the class’s constructor is added to the security-sensitive API list, except if:
 - the class cannot be instantiated,
 - there is no constructor available, or
 - the constructor is not public
- (b) We also exclude interfaces if they have no method.

Two authors independently applied hybrid card sorting (sorting the APIs into categories with the flexibility to add

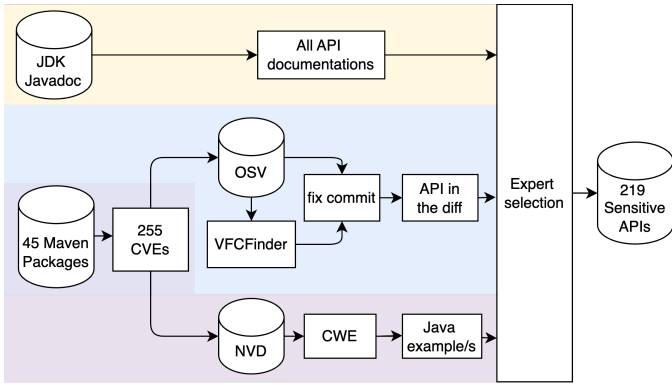

FIG. 1. API List Construction Process

categories as well) on the selected APIs. Card sorting is a qualitative technique to classify text into themes [15]. Card sorting is commonly used in research to create informative categories [16, 17]. We followed Zimmermann et al. [15]’s described three-phase card sorting technique. We resolved the disagreements between raters by negotiated agreement technique [11]. One special case raised in the negotiated agreement process is `CODEC_CRYPTO` category. Both the raters agreed that `CODEC_CRYPTO` does not fall into the `FILESYSTEM` or `NETWORK` category, and so classified it as `PROCESS` [18]. `CODEC_CRYPTO` APIs were included since the insecure use of `codec/crypto` libraries can lead to vulnerabilities [19]. After the categorization, we have 3 categories (themes) and 15 subcategories, as shown in Table III. In this table, we also describe the functionality of the APIs, how many security-sensitive APIs there are in each category and the CWEs related to these APIs and their accessed sensitive resources.

C. Call Graph Generation and Analysis (RQ2)

Using a third-party tool, we generated a call graph for each package version (intra-pkg call graph) of our set of 30,772 package versions. We opted to use the specific call graph generated by *organization to be revealed at paper acceptance* because it can accumulate the reachable APIs of dependencies which, to the best of our knowledge, cannot be done directly from any open-source call graph generation tools for Java.

After getting the call graphs in JSON format, we traversed them with a pre-order breadth-first-search (BFS) to find if any of our security-sensitive APIs were called in the package version. Our pre-order breadth-first-traversal is similar to Mir et al. [20]’s analysis of reachable vulnerable call chains. *Reachability analysis* is a program analysis concept to determine whether functions containing vulnerable code are called within dependencies [21, 22]. After this *reachable* method identification step, we can find the reachable functions and sensitive APIs from the vulnerable functions (RQ1).

D. Experimental Design of User Study (RQ3)

To understand the usefulness of the security-sensitive API information for developers, we conducted an online survey

with developers who are maintainers of projects using the chosen 45 core packages.

Participant Selection: To find the respondents for our survey, we first used `deps.dev` [23] to find the dependents of our chosen 45 core packages, which resulted in 37,192 dependent packages (and 118,775 package versions). Only 29% (10,785/37,192) dependent packages had a valid GitHub URL. We used the GitHub API to find the top 20 contributors to each package (12,565 people) and pulled their email addresses, which resulted in 11,703 available emails. We then filtered out the users who had not contributed to the project in the last 2 years, which resulted in 7,785 contributors. We conducted the survey between June and July 2024. As a thank you for their participation, we offered a \$20 Amazon gift card to five randomly selected participants if they wished to participate in the lottery. We discussed the IRB approval and other ethical considerations in section VI.

Feedback Elicitation: To elicit feedback from the developers, we showed them a personalized heatmap visualization of the security-sensitive API calls of their chosen dependency and other alternative packages in the same category. We designed the survey such that participants required as little effort as possible to complete it, e.g., it was self-contained and included all relevant security-sensitive API information as well as our motivation and context of the study.

Piloting: We conducted a first pilot with eight graduate students, two undergraduate students, and one faculty member to validate the clarity of the visualization to choose the best visualization for the survey. The visualizations in consideration were a plain table, a bar chart, a radar chart, a heatmap, and a polar chart. We chose heatmap as it was more intuitive and clear for the pilot participants. We used an accessible palette for the heatmap visualization to ensure that the visualization is clear for colorblind people. We also randomized the order of the security-sensitive API categories in the visualization to avoid any bias in our results [24, 25]. We then conducted a second pilot with 1.5% (118/7785) of our contributor population. These pilot surveys had two additional validation questions which we used to validate the survey and visualization clarity. The heatmaps are included in the supplementary material.

Survey Design: In our survey, we asked developers: (1) whether they think that the security-sensitive API information is useful in selecting a dependency (perceived usefulness [26]); (2) whether they would have changed their decision if they had known this information before; and (3) what API categories they think should be considered as security-sensitive in general along with the degree of sensitivity. We include the full questionnaire in the supplementary material.

IV. RESULTS

This section discusses the result and analysis for each RQ.

A. RQ1 Java security-sensitive APIs

In this RQ, at first, we identify and classify the security-sensitive API in our chosen packages. To evaluate how good our constructed list is, we then analyzed the presence of our

security-sensitive APIs in 255 CVE fixes and their associated vulnerable functions.

API List and Categorization: Using our methodology, we define a list of Java security-sensitive APIs, consisting of 219 APIs from Java JDK 11, categorized into 3 major categories: FILESYSTEM, NETWORK, and PROCESS, inspired by Ferreira et al. [27]. These 3 categories are then refined to more specific 15 subcategories using hybrid card sorting and negotiated agreement techniques. Our classified list is specified in Table III with the number of APIs in each category and the related CWE IDs. We put the full list of APIs in the supplementary materials.

FILESYSTEM:

related to interacting with the filesystem, including opening, reading, modifying, creating, and writing from/ to files. It also includes the APIs about file permissions.

NETWORK:

interact with network resources, including HTTP servlet/client, URL connection, socket, and naming directory services.

PROCESS:

manage encoding/ encryption, program loading, and script execution.

Security-Sensitive APIs in Vulnerable Functions: We first qualitatively analyzed the security-sensitive APIs in vulnerable functions associated with the 255 CVEs to evaluate how comprehensive our constructed API list is. Overall, 72 out of 219 APIs in our list are directly called in vulnerable functions of these 255 CVEs. The vulnerable functions in our sample are spread across 2806 package versions. From the package version granularity, the number of security-sensitive API calls in package versions’ vulnerable functions has a median of 1.

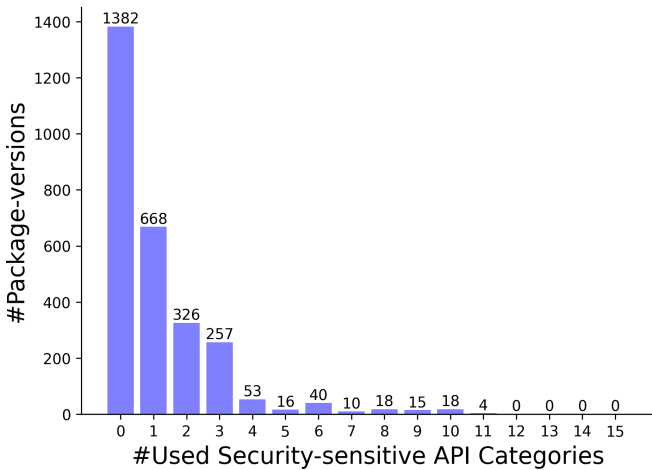

Observation: More than two-thirds of the vulnerable functions in our set have at least one security-sensitive API call.

FIG. 2. Security-sensitive API category usage in vulnerable functions

Fig. 2 shows the number of unique security-sensitive API categories used by package versions in their vulnerable functions. 49.2% of package versions have no security-sensitive

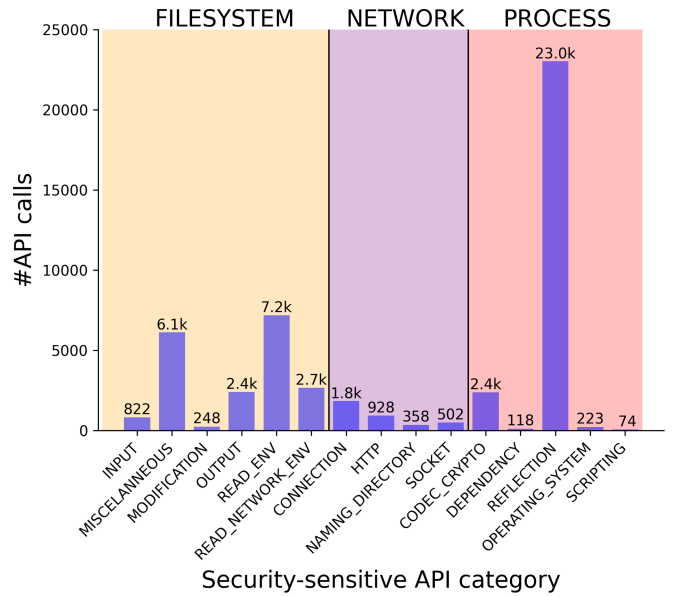

FIG. 3. Sensitive API usage in 1,210 open-source packages.

API call in their vulnerable function, while the rest (50.8%) have at least one security-sensitive API call. However, if we look at the package granularity, 25 out of 45 packages (56.82%) have at least one security-sensitive API call in one of their vulnerable functions. In this analysis, we only identified the directly called APIs from vulnerable functions, which is an underestimation. We can conclude that our constructed API list is a good representative of security-sensitive APIs w.r.t. vulnerable functions.

Finding #1: We define a list of 219 Java security-sensitive APIs (categorized into 3 categories and 15 subcategories, related to 57 CWE categories), of which 72 are found in vulnerable Java functions. These security-sensitive APIs are directly called at least once in 50.8% of our set’s vulnerable functions.

B. RQ2 Prevalence in 1,210 open-source packages

To answer this RQ, we first analyze the prevalence of our security-sensitive APIs calls in our chosen packages with and without dependencies. Then, we qualitatively analyze each package category (Table II) and compare the security-sensitive API calls among packages in each category. Functionally similar packages are grouped together in a package category.

1) *API Prevalence in 1,210 Packages:* Fig. 3 shows the security-sensitive API call in 1,210 open-source packages. These 1,210 packages are the unique packages of our chosen 45 packages’ dependency tree. The most used security-sensitive API category is PROCESS/REFLECTION. Table IV shows the top 10 security-sensitive API calls in the observed packages, which shows that the PROCESS/REFLECTION category takes the first, second, sixth, seventh, and tenth place (32.4% of total calls).

Fig. 4 shows the number of security-sensitive API categories each package-versions uses. Half of the package

TABLE III. Java security-sensitive API Categorization

Category	Subcategory	Description	#API	Related CWE IDs
FILESYSTEM	INPUT	Opening or reading files.	13	73, 91, 319, 552, 576, 611
	OUTPUT	Creating a new file or writing to an existing file.	17	73, 116, 117, 552
	MODIFICATION	Modifying files, such as deleting and copying files.	5	73, 552
	MISCELLANEOUS	Any other actions related to the file system, including APIs that can read <i>and</i> write files, APIs related to paths, and file permissions.	16	22, 73, 367, 552, 732
	READ_ENV	Reading environment variables.	9	214, 526
	READ_NETWORK_ENV	Reading environment variables related to the network.	26	214, 291, 526, 706, 755, 1327
NETWORK	CONNECTION	Creating and managing connections such as URL connections, web connections, and dispatching requests.	23	89, 404, 444, 523, 600, 601, 772, 830, 918, 943, 1072
	HTTP	Creating and managing HTTP requests, responses, cookies, and client operations.	26	20, 79, 116, 213, 295, 352, 384, 444, 600, 601, 602, 614, 754, 918
	SOCKET	Creating and managing sockets as endpoints of communications between two machines.	21	246, 577, 602, 923, 941, 1385
	NAMING_DIRECTORY	Providing naming and directory functionality to Java applications.	13	502
PROCESS	CODEC_CRYPTO	Encoding, decoding, encrypting, and decrypting APIs.	29	84, 177, 261, 327, 1385
	DEPENDENCY	Loading packages as dependencies.	4	111, 114
	REFLECTION	Dynamic loading of accessible objects: classes, methods, constructors, etc.	6	470, 578, 749, 917
	OPERATING_SYSTEM	Executing OS programs.	35	78
	SCRIPTING	Building, loading, and executing scripts.	14	79

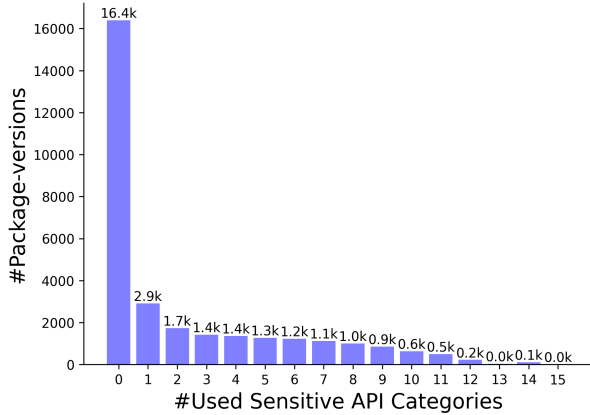

FIG. 4. Sensitive API category usage in 30,772 open-source package versions.

versions (50.2%) use no security-sensitive API (consecutively no security-sensitive API category), and only 2.6% package versions use more than 10 security-sensitive API categories.

Fig. 5 shows the security-sensitive API call comparison between intra- (without dependencies) and inter- (with dependencies) package call graphs. It is important to note that this analysis was done only with 41 out of 45 packages as the 4 do not have dependencies. On average, each package version has 168 additional security-sensitive API calls from its dependencies. The most increase happens in category `PROCESS/REFLECTION` (on average, 109 additional calls per package version). `FILESYSTEM/MISCELLANEOUS` calls are increased 5.3 times (from 13k to 69k), the highest multiply factor in a category. This phenomenon can be explained by the nature of the `FILESYSTEM` APIs that are used in tandem with other functionalities, e.g., checking if a file exists is a standard practice before creating or

TABLE IV. Top 10 security-sensitive API Call

These top 10 API calls are from 1,210 packages. We first average the calls on each package and then sum for each category. We did this to avoid bias from packages with a lot of package versions. F is from `FILESYSTEM` category and P is from `PROCESS`.

Subcategory	API	#	%
P/REFLECTION	java.lang.Class.forName()	7243	14.80%
P/REFLECTION	java.lang.reflect.Method.invoke()	3688	7.54%
F/READ_ENV	java.lang.System.getProperty()	3319	6.78%
F/MISCELLANEOUS	java.io.File.exists()	2693	5.50%
F/MISCELLANEOUS	java.io.File.getAbsolutePath()	2016	4.12%
P/REFLECTION	java.lang.Class.newInstance()	1767	3.61%
P/REFLECTION	java.lang.Class.getMethod()	1711	3.50%
F/OUTPUT	java.util.logging.Logger.log()	1548	3.16%
F/READ_ENV	java.util.Properties.getProperty()	1527	3.12%
P/REFLECTION	java.lang.reflect.Constructor.newInstance()	1440	2.94%

reading from a file. `PROCESS/SCRIPTING` has the lowest multiply factor (1.19 times) with 2.5k to 2.1k calls.

However, `NETWORK/HTTP` is the only category where the calls are reduced (15k to 4.4k) when dependencies are included. The number of calls in inter-package call graphs is smaller than in intra-package call graphs if there is no suitable implementation type of an interface found in the package or its dependencies. In such cases, the chosen call graph generator does not create any edge because no concrete `<caller, callee>` relationship can be determined. One illustrating example is calls of the interface method `HttpSession.getAttribute()` in `spring-webflow@2.2.1`. Due to a lack of interface implementation in the package and its dependencies, no corresponding edge was created in the inter-package call graph of `spring-webflow@2.2.1`. One possible explanation is that implementations of the servlet API are commonly provided by a servlet container such as Apache Tomcat. The choice of a specific servlet container, however, is not prescribed by `spring-webflow@2.2.1`. This requirement can be satisfied, for example, through additional dependencies

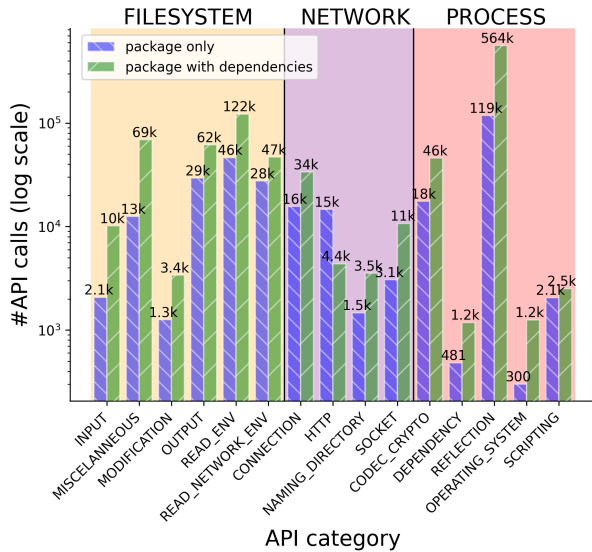

FIG. 5. Security-sensitive API call increase in 3641 open-source package versions without vs. with dependencies.

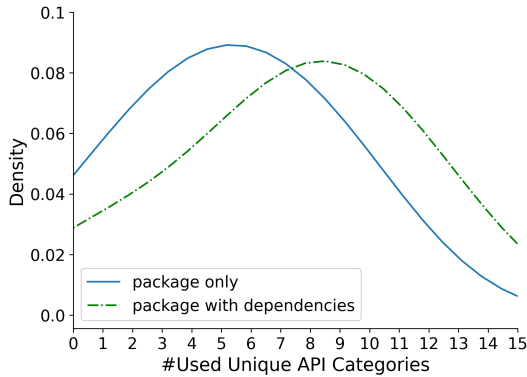

FIG. 6. Security-sensitive API category usage in 3641 open-source package versions.

of `spring-webflow@2.2.1` dependents.

To compare the use of security-sensitive API categories, we show the density functions with and without dependencies in Fig. 6. The density function’s shift to the right shows that dependencies increase the number of used API categories.

Finding #2: On average, each package version calls 72 security-sensitive API in their own code. This average increases 2.3 times when we consider dependencies, indicating that dependencies play a major role in adding API calls to a program.

2) *Security-Sensitive APIs in Package Categories:* In this section, we qualitatively compare functionally similar packages (Table III) w.r.t. security-sensitive API calls and discuss each category’s findings. For this analysis, we only consider the security-sensitive API calls from the inter-package CG of the latest version of the packages. One author reviewed each of the 41 package’s source code, documentation, and usage examples.

Dependency Injection. Dependency injection is a software design pattern that allows the removal of hard-coded dependencies and makes it possible to change them, whether at runtime or compile time. Spring-beans and spring-context used 368 and 235 REFLECTION APIs, respectively, which are the highest and second-highest by any dependency injector framework. High use of REFLECTION APIs indicates that spring-beans and spring-context change the dependencies at runtime. Guice and jakarta.enterprise.cdi-api used 66 and 9 REFLECTION API calls, respectively, to achieve similar functionality as spring-beans and spring-context. On the other hand, dagger used 0 API calls, which indicates that it does not even use reflection to change the dependencies at runtime.

HTTP Client. HTTP client packages provide the implementation of HTTP methods (e.g., GET and POST). All the HTTP client packages in our set use minimal calls to the NETWORK category, indicating an optimized implementation with good software engineering practices, i.e. on average, they call one API in NETWORK/CONNECTION and three in NETWORK/SOCKET. All the packages in this category use PROCESS/REFLECTION and PROCESS/CODEC_CRYPT APIs. The use of PROCESS/CODEC_CRYPT APIs indicates that encoding/decoding and encryption/decryption are necessary for network communications in these packages. Interestingly, retrofit uses okhttp as a dependency, but it uses fewer calls in each API category (except PROCESS/REFLECTION) compared to okhttp. The reasoning is our call-graph generator stitches the *reachable* calls from the entry points of the package to dependency, and so retrofit achieves the same functionality with fewer calls than okhttp by making minimal calls only to okhttp.

I/O Utilities. I/O utility packages provide the implementation of I/O operations such as reading, writing, and modifying files complementing *java.io* and *java.nio* packages. All I/O utilities use every FILESYSTEM category except READ_NETWORK_ENV with FILESYSTEM/MISCELLANEOUS as the most used API category. The only package that uses READ_NETWORK_ENV is jetty-io. Moreover, all the packages use the PROCESS/REFLECTION and NETWORK/CONNECTION categories. Also in the NETWORK category, jetty-io is the only package that calls the NETWORK/SOCKET and NAMING_DIRECTORY APIs, once each.

JDBC Drivers. JDBC (Java Database Connectivity) driver packages allow Java applications to interact with databases. PROCESS/REFLECTION, FILESYSTEM/READ_ENV, and PROCESS/CODEC_CRYPT APIs are the top three used API categories by JDBC drivers. Sqlite-jdbc is the package with the lowest API calls in this category. Interestingly, sqlite-jdbc does not use any FILESYSTEM/INPUT or OUTPUT APIs. Other than that, FILESYSTEM/READ_ENV APIs are used by all JDBC drivers to read environment variables and configuration files.

JSON Libraries. JSON libraries provide the implementation of JSON parsing and serialization to Java objects, and vice versa. Fastjson2 extensively uses PROCESS/REFLECTION APIs compared to gson and jackson-core. Fastjson2 has more functionality than the others, and this is reflected in its API usage, i.e., parsing objects from URLs (NETWORK/CONNECTION APIs) and Base64 encoded strings (PROCESS/CODEC_CRYPT APIs).

Logging. Logging libraries provide the implementation of logging functionality in Java applications. Log4j-core and logback-classic use five out of six FILESYSTEM categories and PROCESS/REFLECTION is the most used API category by these two libraries.

Web Frameworks. Web frameworks support the development of web applications, including web services, web resources, and web APIs. All the web frameworks extensively use PROCESS/REFLECTION to load classes and methods dynamically. For example, spring-web uses REFLECTION APIs to load the classes written by the developer and to create objects of those classes, manipulate them, and inject them into other classes. The FILESYSTEM category calls do not fluctuate much across the web frameworks. The only exception is tapestry-core, which has 157 indirect calls to FILESYSTEM/OUTPUT. The only package in this category that uses PROCESS/OPERATING_SYSTEM APIs (indirectly) is struts2-core.

XML Parsers. XML parsers provide utilities to parse, transform, serialize, and query XML documents. All XML processors only use CONNECTION from the NETWORK category and REFLECTION from the PROCESS category. FILESYSTEM APIs are uniformly used by the XML processors. Dom4j and xstream both use FILESYSTEM/INPUT and MISCELLANEOUS APIs whereas jakarta.xml.bind-api and jaxb-api do not. The most used API category by XML parsers is the PROCESS/REFLECTION category and xstream makes the highest number of (direct + indirect) calls to this category (it used jaxb-api as a dependency).

Comparison Across Package Categories. In terms of the number of API calls, PROCESS/DEPENDENCY is the least used API category, and PROCESS/REFLECTION is the most used across all package versions. Also, PROCESS/DEPENDENCY is called only by JDBC Drivers and Web Frameworks, and PROCESS/REFLECTION is called by all package categories. In terms of packages using the API categories, again, PROCESS/DEPENDENCY is the lowest used (by 5 packages), and PROCESS/REFLECTION is the highest used (by 35 packages).

Finding #3: Different package categories has noticeable differences in API usage. Moreover, packages with the same functionality often differ notably in their API calls.

C. RQ3 Usefulness: Developer Survey

Our survey aims to understand the usefulness of our security-sensitive API information to developers. We got responses from 110 developers. The overall result of the survey is depicted in Figure 7.

How useful do developers think the information is. In response to whether they consider the security-sensitive API information as useful, 72.7% of the developers responded positively. When answering why they think the security-sensitive API information is useful, ⟨P1⟩ said, “If there is a choice, fewer security sensitive APIs reduces the potential for an issue.” ⟨P2⟩ here mentioned, “[...] we give more and more permissions because we assume they are needed, and then start pressing agree to new terms. If people are not even aware of what their core API calls do, how can we expect end-users to care[?]” Another developer ⟨P3⟩

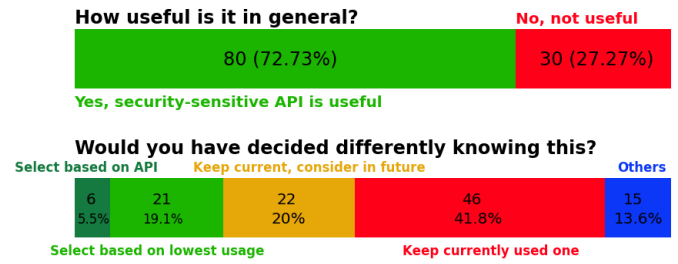

FIG. 7. Perceived and actual usefulness of security-sensitive APIs according to developers

said, “The security implications of particular API calls are not necessarily apparent from the name of the library itself. Understanding the scope of potential API calls would be helpful when evaluating the use of a particular library.”

Of the 27.3% of developers who responded negatively, ⟨P4⟩ said, “Because you typically do not use the full functionality of a framework, especially with spring a lot of functionality is prepared but mostly no security problem in a typical production use case (e.g. running a spring boot app in a docker container, I don’t care about filesystem access)”. Lack of availability of security-sensitive APIs is another reason—⟨P5⟩ mentioned, “Sensitive API calls information is not so broadly available, so I am not planning to factor it.”—which reflects our initial motivation.

Would you have decided differently knowing this information. In response to the question of the effect of the security-sensitive API information on their decision-making process, 44.6% of the respondents said that they would consider this information in their dependency selection process. Among those 44.6%, 20% would keep using the chosen dependency but would factor security-sensitive API into their future decisions. Other 19.1% would select the dependency with the lowest security-sensitive API calls and the rest (5.5%) would select the dependency based on the calls to a specific API category. When elaborating on their answers, ⟨P6⟩ said, “If there were an alternative, this would be an easy metric to reduce security risks without spending too much effort.”

41.8% of respondents responded that they would not change their decision based on the security-sensitive API information. Most of them either think that functionality is still much more important or that the security-sensitive APIs in the package are necessary for the package to do what it is doing, as ⟨P7⟩ mentioned, “I would assume it does what it does for a reason.” The rest (13.6%) answered “Others”. From these answers, 7 out of 15 still mentioned that they would consider the security-sensitive API information as part of their decision-making process. This number adds to the 44.6% and we ended with 50.9% of the developers saying that this information can be considered in their dependency selection process.

Security-sensitive API from developer perspective. For the question of which of the API categories should be considered security-sensitive APIs, the top three most sensitive categories according to developers are PROCESS/OPERATING SYSTEM

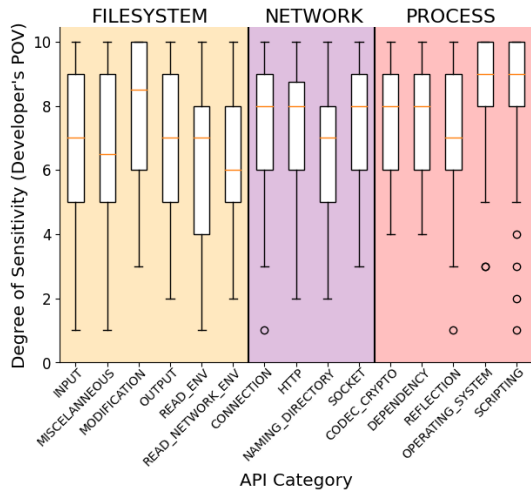

FIG. 8. Degree of sensitivity of security-sensitive API categories according to developers.

(76 votes), PROCESS/SCRIPTING (72), and FILESYSTEM/MODIFICATION (71). In contrast, the least three voted categories were PROCESS/REFLECTION (38), PROCESS/CODEC_CRYPT0 (42), and NETWORK/NAMING_DIRECTORY (48). In terms of the mean degree of sensitivity (1 being least sensitive to 10 being most sensitive), the top three categories were PROCESS/SCRIPTING (8.5), PROCESS/OPERATING_SYSTEM (8.4), and FILESYSTEM/MODIFICATION (7.9). On the other hand, the three sensitive categories with the lowest mean degree of sensitivity were FILESYSTEM/READ_ENV (6.4), FILESYSTEM/READ_NETWORK_ENV (6.4), and FILESYSTEM/INPUT (6.7). The degree of sensitivity of security-sensitive API categories according to developers is depicted in Figure 8.

Finding #4: 72.7% of the developers found the security-sensitive API information useful and 50.9% of the developers said that they would consider security-sensitive API information in their dependency selection process.

V. DISCUSSIONS AND IMPLICATIONS

Prevalence of security-sensitive APIs: We reviewed the source code and documentation of our chosen 45 packages to understand the design pattern, dependency use, implementation choices, and overall API usage. Our observation of going through the individual packages in each category can be summarized into four patterns:

- *Same Functionality, Different Implementation:* The expected functionality of a package is fixed (eg. HTTP spec [28]). But dagger, for example, has a completely different implementation, which results in different security-sensitive API calls than the rest of the “dependency injection” packages.
- *Different Features:* At a high level, all web framework packages are supposed to provide the functionality of building web applications. However, each web framework has a slightly different feature set that makes it unique. Similarly, JSON library fastjson2 provides additional features than the gson and jackson-core. Having additional features is reflected in the differences in security-sensitive API usage.

- *Modularity And Reuse:* HTTP client packages have a low usage of NETWORK APIs. The implementations are very modular. For example, rather than having three NETWORK calls for GET, POST, and PUT, httpclient5 uses one `java.lang.Socket.connect()` method in `ProxyClient.java` and reuse the `ProxyClient` class to implement other methods.
- *Using Similar Package As Dependency:* Even with another HTTP client package okhttp as a dependency, retrofit uses fewer security-sensitive API calls than okhttp. Retrofit is a high-level REST abstraction built on top of okhttp. In this setting, okhttp provides low-level HTTP functionality, whereas retrofit provides *additional features*, e.g., URL manipulation. A similar pattern can be found in web frameworks as well: spring-webflow and spring-webmvc both use spring-web for different use cases from the high-level.

Developers Perception: Developers appear to be generally aware of security-sensitive APIs. In our survey, they responded with, ⟨P8⟩ “If there is a choice, fewer security-sensitive APIs reduce the potential for an issue” and ⟨P9⟩ “Helps to know what packages have a higher attack surface.” However, developers sometimes emphasize more on knowing about exploitation than security-sensitive API in their dependency, ⟨P10⟩ “It is more important to know if any of the use cases are vulnerable to exploitation.” Other times, developers emphasize more on the functionality, ⟨P11⟩ “Because the library is primarily chosen not upon what sensitive API it calls, but what functions it perform[s].” While functionality and specific use cases are important, we recommend developers to also include security-sensitive APIs as *one of* their selection criteria.

Tooling: We contribute an open-source tool that takes a call graph of packages as input and generates comparative visualizations of security-sensitive API calls for those packages. Regardless of how the call graph is generated (e.g., without or with dependencies), our tool can provide a comparison of the security-sensitive API calls for the provided packages. There are four ways to integrate our tool: ① as a standalone tool, ② as a plugin in IDEs, ③ as a plugin in package management tools (e.g., Maven, Gradle), and ④ as a part of dependency management/checking tool (e.g., OpenSSF Scorecard [29]). Several developers stated that the way ③ and ④ would be more useful, as stated by ⟨P12⟩ “I would not run a tool to decide this manually—too much effort—but if it was auto-provided in the PR say—then it’s a small nice to have.”

VI. ETHICAL CONSIDERATIONS

We have followed the guidelines of the ACM Code of Ethics and Professional Conduct [30] in our research. We obtained IRB approval from our institution (*Uni IRB XXX*) before conducting the survey. We did not collect any personally identifiable information from the survey. We attached the consent form with our initial email to the participants and informed them that the survey is voluntary and they can withdraw at any time. No new vulnerabilities were introduced during our research, so no disclosures were made. Our contact procedure focused on informing the responsible parties about the security-sensitive API calls in their chosen dependencies.

VII. THREATS TO VALIDITY

Generalizability and Coverage. We use CVEs and CWEs of our chosen 45 packages of Maven repositories as our reference in our analysis of determining a list of security-sensitive APIs. We acknowledge that this list of security-sensitive APIs may not reflect the whole population of (possibly) security-sensitive APIs. However, during our analysis, we found that (1) not all CVE patches and CWEs have related security-sensitive APIs, and (2) the more CVEs and CWEs we analyzed, the more our list gets saturated with repeating security-sensitive API. Our list of 219 security-sensitive APIs serves well in showing the overview of these API calls in the ecosystem and how it affects developers' decisions in adopting open-source packages.

API List Construction Method. We opt not to just look at the APIs used by the vulnerable functions (from our chosen packages) and consider them sensitive. Considering all APIs called from vulnerable functions as sensitive would be an overapproximation. Thus, we constructed our security-sensitive API list based on expert selection (through manual inspection of JavaDoc, CVE patches, and CWE examples).

Call Graph Construction and Analysis. We acknowledge that the soundness of our call graph depends on the third-party tool we used and it may affect the accuracy of our analysis [31]. However, as we focus on the usefulness of the information for developers, slightly less accurate information will not greatly impact our most important finding. Also, the BOM (Bill of Materials) dependencies did not result in any security-sensitive API calls in our analysis, so we excluded them. Some package versions also lacked source code, which resulted in the call graph generator producing no output.

Survey Limitation. The generalization of our findings beyond the pool of participants should be made with caution since this is a common limitation of works of this kind [32]. The developers that participated in the survey might not be a good representation of the whole developer population. Developers participating in an API study might be more knowledgeable/aware of APIs than the average (self-selection bias [33, 34]). The survey result may also be affected by how we explain the problem (survey clarity) and present the alternatives (visualization clarity). To make sure that our survey and visualization are clear enough, we did 2 pilots and modified our survey accordingly.

VIII. RELATED WORK

Capability Analysis. Our study is inspired by previous capability analysis research whose goal is to understand what capabilities (permissions) a program has and possibly detect any malicious behaviors. BINCAPZ by Chainguard [35], CAPSLOCK by Google [36], and APPINSPECTOR by Microsoft can find the capabilities from binary or source code of a certain language. Similarly, Gorla et al. [37] uses the term *sensitive API* to find the capabilities of an Android application and possibly anomalous behavior. We built on a similar term as Gorla et al. but focused more on *security-sensitive APIs* and the Maven ecosystem, as this ecosystem has been also found to have supply chain issues [38, 39].

Permission Managers and Compliance Enforcement. Another way to control program capability is by enforcing permission in compliance with certain policies. Several studies have been done to build permission managers [8, 9, 40], enforce third-party permission [27, 41], or enforce policy compliance [42, 43]. Ferreira et al. [27] proposed a lightweight permission system that protects applications from malicious updates of direct and transitive dependencies. The permissions are categorized as NETWORK ACCESS, FILE SYSTEM ACCESS, PROCESS CREATION, and ALL. Our security-sensitive API categories are inspired by the first three.

Maven Supply Chain Security. When there is a lack of capability studies on the Java/Maven ecosystem, there are several studies that analyze supply chain security in this ecosystem [20, 44, 45]. Additionally, while vulnerability analysis covers most research on supply chain security, breaking changes have also gathered research interest as it can be related to security patches [46]–[48].

Debloating. Soto-Valero et al. [49, 50] found that 57% of Java dependencies are bloated and 89.2% of them remain bloated over time. To tackle this issue, several studies have been done using reachability [51, 52], coverage [53], and dynamic analysis [54] to debloat applications. This has been found to impact the security of the applications [55]–[58].

Program Analysis for Security. We chose to use call graph analysis in our study as program analysis has been used in the SOTA for security purposes [20, 59]–[61]. Another common program analysis used for security purposes is taint analysis [62]–[65]. To avoid weaknesses of conventional program analysis, several studies prefer to use hybrid program analysis [41, 66]–[68], anti-analysis techniques [69], or large language models [70, 71].

Developers Study in Supply Chain. When no study has explored the usefulness of understanding security-sensitive API for dependency selection, several studies have been done with developers to understand how they choose/update their dependencies and why [4, 72]–[74]. From the security point of view, several studies have been done with developers to understand the relationship between dependency management and security [2, 75], identify common threats [76] and attacks [77]. From the studies in the SOTA, the closest to our developer study is a study by Mujahid et al. [78]. They also presented some package alternatives to the developers and asked if they would consider them. The difference with ours is that (1) they surveyed JavaScript/NPM developers (we surveyed Java developers) and (2) they compared packages based on how they were declining while we compared packages based on their security-sensitive API calls.

IX. CONCLUSION

In this mixed-methods study, we analyzed the security-sensitive API calls in the 45 Java packages based on our categorization method. We assessed the efficacy of using security-sensitive API information as a criterion for dependency selection through a user study. Our results indicate that security-sensitive APIs are prevalent across 30,772 versions

of Java packages. Moreover, 72.7% of developers agreed that the information on these security-sensitive APIs would be useful for their dependency selection process. Based on feedback from several developers, integrating this information into the package registry could be useful for their dependency selection process, which fosters future research. We encourage developers to consider the security-sensitive API calls as *one of the* dependency selection criteria.

REFERENCES

- [1] D. Everson, L. Cheng, and Z. Zhang, "Log4shell: Redefining the Web Attack Surface," in *Proceedings 2022 Workshop on Measurements, Attacks, and Defenses for the Web*. San Diego, CA, USA: Internet Society, 2022.
- [2] I. Pashchenko, D.-L. Vu, and F. Massacci, "A Qualitative Study of Dependency Management and Its Security Implications," in *Proceedings of the 2020 ACM SIGSAC Conference on Computer and Communications Security*, ser. CCS '20. New York, NY, USA: Association for Computing Machinery, Nov. 2020, pp. 1513–1531.
- [3] M. H. Tanzil, G. Uddin, and A. Barcomb, "'How do people decide?': A Model for Software Library Selection," in *Proceedings of the 2024 IEEE/ACM 17th International Conference on Cooperative and Human Aspects of Software Engineering*. Lisbon Portugal: ACM, Apr. 2024, pp. 1–12.
- [4] E. Larios Vargas, M. Aniche, C. Treude, M. Bruntink, and G. Gousios, "Selecting third-party libraries: The practitioners' perspective," in *Proceedings of the 28th ACM Joint Meeting on European Software Engineering Conference and Symposium on the Foundations of Software Engineering*. Virtual Event USA: ACM, Nov. 2020, pp. 245–256.
- [5] D. Wermke, N. Wöhler, J. H. Klemmer, M. Fourné, Y. Acar, and S. Fahl, "Committed to trust: A qualitative study on security & trust in open source software projects," in *2022 IEEE symposium on Security and Privacy (SP)*. IEEE, 2022, pp. 1880–1896.
- [6] R. Paramitha and F. Massacci, "Technical leverage analysis in the python ecosystem," *Empirical Software Engineering*, vol. 28, no. 6, p. 139, 2023.
- [7] OpenJDK, "JEP 411: Deprecate the Security Manager for Removal," <https://openjdk.org/jeps/411>, 2021, last accessed: 01-Aug-2024.
- [8] P. C. Amusuo, K. A. Robinson, S. Torres-Arias, L. Simon, and J. C. Davis, "Preventing Supply Chain Vulnerabilities in Java with a Fine-Grained Permission Manager," Oct. 2023.
- [9] P. C. Amusuo, K. A. Robinson, T. Singla, H. Peng, A. Machiry, S. Torres-Arias, L. Simon, and J. C. Davis, "ZTDS_{JAVA}\$: Mitigating Software Supply Chain Vulnerabilities via Zero-Trust Dependencies," Apr. 2024.
- [10] "Maven Central Repository," <https://mvnrepository.com/open-source>, last accessed: 01-Aug-2024.
- [11] J. L. Campbell, C. Quincy, J. Osserman, and O. K. Pedersen, "Coding In-depth Semistructured Interviews: Problems of Unitization and Intercoder Reliability and Agreement," *Sociological Methods & Research*, vol. 42, no. 3, pp. 294–320, Aug. 2013.
- [12] "OWASP Top Ten," <https://owasp.org/www-project-top-ten/>, last accessed: 01-Aug-2024.
- [13] T. Dunlap, E. Lin, W. Enck, and B. Reaves, "VFCFinder: Pairing Security Advisories and Patches," in *Proceedings of the 19th ACM Asia Conference on Computer and Communications Security*. Singapore: ACM, Jul. 2024, pp. 1128–1142.
- [14] T. M. C. (MITRE), "Common weakness enumeration," <https://cwe.mitre.org/index.html>, 2024, last accessed: 01-Aug-2024.
- [15] T. Zimmermann, "Card-sorting: From text to themes," in *Perspectives on Data Science for Software Engineering*, T. Menzies, L. Williams, and T. Zimmermann, Eds. Boston: Morgan Kaufmann, Jan. 2016, pp. 137–141.
- [16] S. K. Basak, L. Neil, B. Reaves, and L. Williams, "What Challenges Do Developers Face About Checked-in Secrets in Software Artifacts?" in *2023 IEEE/ACM 45th International Conference on Software Engineering (ICSE)*, May 2023, pp. 1635–1647.
- [17] A. Rahman, A. Partho, P. Morrison, and L. Williams, "What questions do programmers ask about configuration as code?" in *Proceedings of the 4th International Workshop on Rapid Continuous Software Engineering*, ser. RCoSE '18. New York, NY, USA: Association for Computing Machinery, May 2018, pp. 16–22.
- [18] N. Gisev, J. S. Bell, and T. F. Chen, "Interrater agreement and interrater reliability: Key concepts, approaches, and applications," *Research in Social and Administrative Pharmacy*, vol. 9, no. 3, pp. 330–338, May 2013.
- [19] S. Krüger, M. Reif, A.-K. Wickert, S. Nadi, K. Ali, E. Bodden, Y. Acar, M. Mezini, and S. Fahl, "Securing Your Crypto-API Usage Through Tool Support - A Usability Study," in *2023 IEEE Secure Development Conference (SecDev)*, Oct. 2023, pp. 14–25.
- [20] A. M. Mir, M. Keshani, and S. Proksch, "On the Effect of Transitivity and Granularity on Vulnerability Propagation in the Maven Ecosystem," in *SANER*. arXiv, Jan. 2023.
- [21] T. Dunlap, J. S. Meyers, B. Reaves, and W. Enck, "Pairing Security Advisories with Vulnerable Functions Using Open-Source LLMs," in *Detection of Intrusions and Malware, and Vulnerability Assessment*, F. Maggi, M. Egele, M. Payer, and M. Carminati, Eds. Cham: Springer Nature Switzerland, 2024, vol. 14828, pp. 350–369.
- [22] S. E. Ponta, H. Plate, and A. Sabetta, "Detection, assessment and mitigation of vulnerabilities in open source dependencies," *Empirical Software Engineering*, vol. 25, no. 5, pp. 3175–3215, Sep. 2020.
- [23] "Open Source Insights: Understand your dependencies," <https://deps.dev/>, last accessed: 01-Aug-2024.
- [24] M. Gerosa, I. Wiese, B. Trinkenreich, G. Link, G. Robles, C. Treude, I. Steinmacher, and A. Sarma, "The Shifting Sands of Motivation: Revisiting What Drives Contributors in Open Source," in *2021 IEEE/ACM 43rd International Conference on Software Engineering (ICSE)*, May 2021, pp. 1046–1058.
- [25] E. Guerra, E. Gomes, J. Ferreira, I. Wiese, P. Lima, M. Gerosa, and P. Meirelles, "How do annotations affect Java code readability?" *Empirical Software Engineering*, vol. 29, no. 3, p. 62, May 2024.
- [26] F. D. Davis, "Perceived usefulness, perceived ease of use, and user acceptance of information technology," *MIS quarterly*, pp. 319–340, 1989.
- [27] G. Ferreira, L. Jia, J. Sunshine, and C. Kästner, "Containing Malicious Package Updates in npm with a Lightweight Permission System," in *2021 IEEE/ACM 43rd International Conference on Software Engineering (ICSE)*, May 2021, pp. 1334–1346.
- [28] "HTTP/2 RFC," <https://datatracker.ietf.org/doc/html/rfc9113>, last accessed: 01-Aug-2024.
- [29] N. Zahan, P. Kanakiya, B. Hambleton, S. Shohan, and L. Williams, "OpenSSF Scorecard: On the Path Toward Ecosystem-Wide Automated Security Metrics," *IEEE Security & Privacy*, vol. 21, no. 6, pp. 76–88, Nov. 2023.
- [30] A. C. . T. Force, "Acm code of ethics and professional conduct." [Online]. Available: <https://www.acm.org/code-of-ethics>
- [31] M. Reif, F. Kübler, M. Eichberg, D. Helm, and M. Mezini, "Judge: Identifying, understanding, and evaluating sources of unsoundness in call graphs," in *Proceedings of the 28th ACM SIGSOFT International Symposium on Software Testing and Analysis*, ser. ISSTA 2019. New York, NY, USA: Association for Computing Machinery, Jul. 2019, pp. 251–261.
- [32] C. Miller, C. Kästner, and B. Vasilescu, "'We Feel Like We're Winging It': A Study on Navigating Open-Source Dependency Abandonment," in *Proceedings of the 31st ACM Joint European Software Engineering Conference and Symposium on the Foundations of Software Engineering*. San Francisco CA USA: ACM, Nov. 2023, pp. 1281–1293.
- [33] S. G. Rogelberg, J. M. Conway, M. E. Sederburg, C. Spitzmüller, S. Aziz, and W. E. Knight, "Profiling Active and Passive Nonrespondents to an Organizational Survey," *Journal of Applied Psychology*, vol. 88, no. 6, pp. 1104–1114, Dec. 2003.
- [34] B. Marcus and A. Schütz, "Who Are the People Reluctant to Participate in Research? Personality Correlates of Four Different Types of Nonresponse as Inferred from Self- and Observer Ratings," *Journal of Personality*, vol. 73, no. 4, pp. 959–984, 2005.
- [35] Chainguard, "bincapz," <https://github.com/chainguard-dev/bincapz>, last accessed: 01-Aug-2024.
- [36] Google, "Capslock," <https://github.com/google/capslock>, 2023, last accessed: 01-Aug-2024.
- [37] A. Gorla, I. Tavecchia, F. Gross, and A. Zeller, "Checking app behavior against app descriptions," in *Proceedings of the 36th International Conference on Software Engineering*, ser. ICSE 2014. New York, NY, USA: Association for Computing Machinery, May 2014, pp. 1025–1035.

- [38] A. Berge, “What is log4shell? the log4j vulnerability explained (and what to do about it),” <https://www.dynatrace.com/news/blog/what-is-log4shell/>, 2023, last accessed: 01-Aug-2024.
- [39] “Equifax data breach FAQ: What happened, who was affected, what was the impact?” <https://www.csoonline.com/article/567833/equifax-data-breach-faq-what-happened-who-was-affected-what-was-the-impact.html>, 2017, last accessed: 01-Aug-2024.
- [40] N. Vasilakis, C.-A. Staicu, G. Ntousakis, K. Kallas, B. Karel, A. DeHon, and M. Pradel, “Preventing Dynamic Library Compromise on Node.js via RWX-Based Privilege Reduction,” in *Proceedings of the 2021 ACM SIGSAC Conference on Computer and Communications Security*. Virtual Event Republic of Korea: ACM, Nov. 2021, pp. 1821–1838.
- [41] G. Ntousakis, S. Ioannidis, and N. Vasilakis, “Demo: Detecting Third-Party Library Problems with Combined Program Analysis,” in *Proceedings of the 2021 ACM SIGSAC Conference on Computer and Communications Security*, ser. CCS ’21. New York, NY, USA: Association for Computing Machinery, Nov. 2021, pp. 2429–2431.
- [42] M. Ohm, T. Pohl, and F. Boes, “You Can Run But You Can’t Hide: Runtime Protection Against Malicious Package Updates For Node.js,” May 2023.
- [43] E. Wyss, A. Wittman, D. Davidson, and L. De Carli, “Wolf at the Door: Preventing Install-Time Attacks in npm with Latch,” in *Proceedings of the 2022 ACM on Asia Conference on Computer and Communications Security*. Nagasaki Japan: ACM, May 2022, pp. 1139–1153.
- [44] Y. Wu, Z. Yu, M. Wen, Q. Li, D. Zou, and H. Jin, “Understanding the Threats of Upstream Vulnerabilities to Downstream Projects in the Maven Ecosystem,” in *ICSE*, 2023.
- [45] I. Pashchenko, H. Plate, S. E. Ponta, A. Sabetta, and F. Massacci, “Vuln4Real: A Methodology for Counting Actually Vulnerable Dependencies,” *IEEE Transactions on Software Engineering*, vol. 48, no. 5, pp. 1592–1609, May 2022.
- [46] L. Ochoa, T. Degueule, J.-R. Falleri, and J. Vinju, “Breaking bad? Semantic versioning and impact of breaking changes in Maven Central,” *Empirical Software Engineering*, vol. 27, no. 3, p. 61, Mar. 2022.
- [47] S. Raemaekers, A. van Deursen, and J. Visser, “Semantic Versioning versus Breaking Changes: A Study of the Maven Repository,” in *2014 IEEE 14th International Working Conference on Source Code Analysis and Manipulation*, Sep. 2014, pp. 215–224.
- [48] D. Jayasuriya, V. Terragni, J. Dietrich, S. Ou, and K. Blincoe, “Understanding Breaking Changes in the Wild,” in *Proceedings of the 32nd ACM SIGSOFT International Symposium on Software Testing and Analysis*. Seattle WA USA: ACM, Jul. 2023, pp. 1433–1444.
- [49] C. Soto-Valero, N. Harrand, M. Monperrus, and B. Baudry, “A comprehensive study of bloated dependencies in the Maven ecosystem,” *Empirical Software Engineering*, vol. 26, no. 3, p. 45, Mar. 2021.
- [50] C. Soto-Valero, T. Durieux, and B. Baudry, “A longitudinal analysis of bloated Java dependencies,” in *Proceedings of the 29th ACM Joint Meeting on European Software Engineering Conference and Symposium on the Foundations of Software Engineering*, ser. ESEC/FSE 2021. New York, NY, USA: Association for Computing Machinery, Aug. 2021, pp. 1021–1031.
- [51] B. R. Bruce, T. Zhang, J. Arora, G. H. Xu, and M. Kim, “JSrink: In-depth investigation into debloating modern Java applications,” in *Proceedings of the 28th ACM Joint Meeting on European Software Engineering Conference and Symposium on the Foundations of Software Engineering*, ser. ESEC/FSE 2020. New York, NY, USA: Association for Computing Machinery, Nov. 2020, pp. 135–146.
- [52] K. Macias, M. Mathur, B. R. Bruce, T. Zhang, and M. Kim, “Web-JSrink: A web service for debloating Java bytecode,” in *Proceedings of the 28th ACM Joint Meeting on European Software Engineering Conference and Symposium on the Foundations of Software Engineering*, ser. ESEC/FSE 2020. New York, NY, USA: Association for Computing Machinery, Nov. 2020, pp. 1665–1669.
- [53] C. Soto-Valero, T. Durieux, N. Harrand, and B. Baudry, “Coverage-Based Debloating for Java Bytecode,” *ACM Transactions on Software Engineering and Methodology*, vol. 32, no. 2, pp. 38:1–38:34, Apr. 2023.
- [54] A. Turcotte, E. Arteca, A. Mishra, S. Alimadadi, and F. Tip, “Stubbi-fier: Debloating dynamic server-side JavaScript applications,” *Empirical Software Engineering*, vol. 27, no. 7, p. 161, Sep. 2022.
- [55] B. A. Azad, P. Laperdrix, and N. Nikiforakis, “Less is More: Quantifying the Security Benefits of Debloating Web Applications,” p. 19.
- [56] R. Ye, L. Liu, S. Hu, F. Zhu, J. Yang, and F. Wang, “JSLIM: Reducing the Known Vulnerabilities of JavaScript Application by Debloating,” in *Emerging Information Security and Applications*, ser. Communications in Computer and Information Science, W. Meng and S. K. Katsikas, Eds. Cham: Springer International Publishing, 2022, pp. 128–143.
- [57] P. Pashakhanloo, A. Machiry, H. Choi, A. Canino, K. Heo, I. Lee, and M. Naik, “PacJam: Securing Dependencies Continuously via Package-Oriented Debloating,” in *Proceedings of the 2022 ACM on Asia Conference on Computer and Communications Security*. Nagasaki Japan: ACM, May 2022, pp. 903–916.
- [58] S. Ghavannia, “Attack Surface Reduction through Software Debloating and Specialization.”
- [59] B. B. Nielsen, M. T. Torp, and A. Møller, “Modular call graph construction for security scanning of Node.js applications,” in *Proceedings of the 30th ACM SIGSOFT International Symposium on Software Testing and Analysis*, ser. ISSTA 2021. New York, NY, USA: Association for Computing Machinery, Jul. 2021, pp. 29–41.
- [60] M. Keshani, G. Gousios, and S. Proksch, “Frankenstein: Fast and lightweight call graph generation for software builds,” *Empirical Software Engineering*, vol. 29, no. 1, p. 1, Nov. 2023.
- [61] M. Keshani, “Scalable Call Graph Constructor for Maven,” in *2021 IEEE/ACM 43rd International Conference on Software Engineering: Companion Proceedings (ICSE-Companion)*, May 2021, pp. 99–101.
- [62] C.-A. Staicu, M. T. Torp, M. Schäfer, A. Møller, and M. Pradel, “Extracting taint specifications for JavaScript libraries,” in *Proceedings of the ACM/IEEE 42nd International Conference on Software Engineering*, ser. ICSE ’20. New York, NY, USA: Association for Computing Machinery, Oct. 2020, pp. 198–209.
- [63] S. Muralee, I. Koishybayev, A. Nahapetyan, G. Tystahl, B. Reaves, A. Bianchi, W. Enck, A. Kapravelos, and A. Machiry, “ARGUS: A Framework for Staged Static Taint Analysis of GitHub Workflows and Actions,” in *USENIX Security Symposium*, 2023.
- [64] M. Shcherbakov, M. Balliu, and C.-A. Staicu, “Silent Spring: Prototype Pollution Leads to Remote Code Execution in Node.js,” in *USENIX Security*, 2023.
- [65] E. J. Schwartz, T. Avgerinos, and D. Brumley, “All You Ever Wanted to Know about Dynamic Taint Analysis and Forward Symbolic Execution (but Might Have Been Afraid to Ask),” in *2010 IEEE Symposium on Security and Privacy*. Oakland, CA, USA: IEEE, 2010, pp. 317–331.
- [66] R. Duan, O. Alrawi, R. P. Kasturi, R. Elder, B. Saltaformaggio, and W. Lee, “Towards Measuring Supply Chain Attacks on Package Managers for Interpreted Languages,” in *Proceedings 2021 Network and Distributed System Security Symposium*. Virtual: Internet Society, 2021.
- [67] S. Li, M. Kang, J. Hou, and Y. Cao, “Mining Node.js Vulnerabilities via Object Dependence Graph and Query,” in *31st USENIX Security Symposium (USENIX Security 22)*, 2022.
- [68] N. Vasilakis, G. Ntousakis, V. Heller, and M. C. Rinard, “Efficient module-level dynamic analysis for dynamic languages with module recontextualization,” in *Proceedings of the 29th ACM Joint Meeting on European Software Engineering Conference and Symposium on the Foundations of Software Engineering*. Athens Greece: ACM, Aug. 2021, pp. 1202–1213.
- [69] C. Jung, D. Kim, W. Wang, Y. Zheng, K. H. Lee, and Y. Kwon, “Defeating Program Analysis Techniques via Ambiguous Translation,” in *2021 36th IEEE/ACM International Conference on Automated Software Engineering (ASE)*, Nov. 2021, pp. 1382–1387.
- [70] H. Li, Y. Hao, Y. Zhai, and Z. Qian, “The Hitchhiker’s Guide to Program Analysis: A Journey with Large Language Models,” Jul. 2023.
- [71] X. Xu, Z. Zhang, S. Feng, Y. Ye, Z. Su, N. Jiang, S. Cheng, L. Tan, and X. Zhang, “LmPa: Improving Decompilation by Synergy of Large Language Model and Program Analysis,” Jun. 2023.
- [72] S. Mujahid, R. Abdalkareem, and E. Shihab, “What are the characteristics of highly-selected packages? A case study on the npm ecosystem,” *Journal of Systems and Software*, vol. 198, p. 111588, Apr. 2023.
- [73] X. Li, S. Moreschini, Z. Zhang, and D. Taibi, “Exploring factors and metrics to select open source software components for integration: An empirical study,” *Journal of Systems and Software*, vol. 188, p. 111255, Jun. 2022.
- [74] R. He, H. He, Y. Zhang, and M. Zhou, “Automating Dependency Updates in Practice: An Exploratory Study on GitHub Dependabot,” Jul. 2022.
- [75] D. Wermke, J. H. Klemmer, N. Wöhler, J. Schmäser, H. S. Ramulu, Y. Acar, and S. Fahl, “‘Always Contribute Back’: A Qualitative Study on Security Challenges of the Open Source Supply Chain,” in *2023 IEEE Symposium on Security and Privacy (SP)*, May 2023, pp. 1545–1560.
- [76] B. Kaplan and J. Qian, “A Survey on Common Threats in npm and PyPi Registries,” in *Deployable Machine Learning for Security Defense*,

ser. Communications in Computer and Information Science, G. Wang, A. Ciptadi, and A. Ahmadzadeh, Eds. Cham: Springer International Publishing, 2021, pp. 132–156.

[77] P. Ladisa, H. Plate, M. Martinez, and O. Barais, “SoK: Taxonomy of Attacks on Open-Source Software Supply Chains,” *IEEE Symposium on Security and Privacy (SP)*, 2023.

[78] S. Mujahid, D. E. Costa, R. Abdalkareem, and E. Shihab, “Where to Go Now? Finding Alternatives for Declining Packages in the npm Ecosystem,” Aug. 2023.

Less Is More: A Mixed-Methods Study on Security-Sensitive API Calls in Java for Better Dependency Selection

SUPPLEMENTARY MATERIAL

arXiv:2408.02846v1 [cs.CR] 5 Aug 2024

I. FULL API LIST

TABLE I. Security-sensitive Java API List

Category	Subcategory	APIs
FILESYSTEM	INPUT	java.io.FileInputStream()
		java.io.FileReader()
		java.nio.channels.FileChannel.read()
		java.nio.file.Files.lines()
		java.nio.file.Files.newBufferedReader()
		java.nio.file.Files.newInputStream()
		java.nio.file.Files.readAllBytes()
		java.nio.file.Files.readAllLines()
		java.nio.file.Files.readString()
		java.nio.file.Files.readSymbolicLink()
		java.util.Scanner()
		javax.xml.parsers.DocumentBuilder.parse()
		javax.xml.parsers.SAXParser.parse()
		FILESYSTEM
java.io.File.exists()		
java.io.File.getAbsolutePath()		
java.io.File.getCanonicalFile()		
java.io.File.getPath()		
java.io.File.toPath()		
java.io.RandomAccessFile()		
java.nio.channels.FileChannel()		
java.nio.file.Paths.get()		
java.security.BasicPermission()		
java.security.ProtectionDomain()		
FILESYSTEM	MODIFICATION	java.nio.file.Files.copy()
		java.nio.file.Files.delete()
		java.nio.file.Files.deleteIfExists()
		java.nio.file.Files.move()
		java.nio.file.Files.newByteChannel()
FILESYSTEM	OUTPUT	java.io.File.createTempFile()
		java.io.File.mkdir()
		java.io.FileOutputStream()
		java.io.FileWriter()
		java.nio.file.Files.createFile()
		java.nio.file.Files.createLink()
		java.nio.file.Files.createSymbolicLink()
		java.nio.file.Files.createTempFile()
		java.nio.file.Files.newBufferedWriter()
		java.nio.file.Files.newOutputStream()
		java.nio.file.Files.setLastModifiedTime()
		java.nio.file.Files.setOwner()
		java.nio.file.Files.setPosixFilePermissions()
		java.nio.file.Files.write()
		java.nio.file.Files.writeString()
java.util.logging.Logger.info()		
java.util.logging.Logger.log()		
FILESYSTEM		java.lang.ProcessBuilder.environment()
		java.lang.System.getenv()
		java.lang.System.getProperties()

Continued on next page

READ_ENV	java.lang.System.getProperty() java.lang.System.getSecurityManager() java.sql.Connection.getMetaData() java.util.Properties.getProperty() java.util.Properties.setProperty() java.util.Properties()
	<hr/> java.net.InetAddress.getAllByName() java.net.InetAddress.getHostAddress() java.net.InetAddress.getHostName() java.net.InetAddress.getLocalHost() java.net.InetAddress.getLoopbackAddress() java.net.InetAddress.isReachable() java.net.InetSocketAddress() java.net.InetSocketAddress.getHostName() java.net.InetSocketAddress.getPort() java.net.NetworkInterface.getInetAddresses() java.net.Socket.getInetAddress() java.net.URI()
READ_NETWORK_ENV	java.net.URI.getAuthority() java.net.URI.getHost() java.net.URI.getPort() java.net.URI.getRawSchemeSpecificPart() javax.servlet.http.HttpServletRequest.getContextPath() javax.servlet.http.HttpServletRequest.getLocalAddr() javax.servlet.http.HttpServletRequest.getLocalName() javax.servlet.http.HttpServletRequest.getLocalPort() javax.servlet.http.HttpServletRequest.getRemoteAddr() javax.servlet.http.HttpServletRequest.getRemotePort() javax.servlet.http.HttpServletRequest.getQueryString() javax.servlet.http.HttpServletRequest.getRequestURI() javax.servlet.http.HttpServletRequest.getServletPath() javax.servlet.http.HttpServletResponse.setStatus()
	<hr/> <hr/> jakarta.servlet.ServletContext.getRequestDispatcher() java.net.HttpURLConnection() java.net.HttpURLConnection.connect() java.net.HttpURLConnection() java.net.HttpURLConnection.connect() java.net.HttpURLConnection.getInputStream() java.net.HttpURLConnection.getOutputStream() java.net.JarURLConnection() java.net.JarURLConnection.connect() java.net.URL() java.net.URL.openConnection() java.net.URL.openStream() java.sql.DriverManager.getConnection() java.sql.Statement.executeQuery() javax.servlet.http.HttpServletRequest.getRequestDispatcher() javax.sql.DataSource.getConnection()
CONNECTION	<hr/> jakarta.servlet.http.HttpServletRequest.getParameter() jakarta.servlet.http.HttpServletRequest.getRequestDispatcher() jakarta.servlet.http.HttpServletRequest.setAttribute() jakarta.servlet.http.HttpServletResponse.getWriter() jakarta.servlet.http.HttpServletResponse.setStatus()
NETWORK	jakarta.servlet.http.HttpServletRequest.setStatus()

Continued on next page

HTTP

- java.net.http.HttpClient()
- java.net.http.HttpClient.Builder.build()
- java.net.http.HttpClient.newBuilder()
- java.net.http.HttpClient.newHttpClient()
- java.net.http.HttpClient.send()
- java.net.http.HttpClient.sendAsync()
- javax.net.ssl.HttpURLConnection.setHostnameVerifier()
- javax.security.auth.login.LoginContext.login()
- javax.servlet.http.Cookie()
- javax.servlet.http.HttpServlet()
- javax.servlet.http.HttpServletResponse.addHeader()
- javax.servlet.http.HttpServletResponse.getWriter()
- javax.servlet.http.HttpServletResponse.sendRedirect()
- javax.servlet.http.HttpServletRequest.getParameter()
- javax.servlet.http.HttpServletRequestWrapper()
- javax.servlet.http.HttpSession.getAttribute()
- javax.servlet.http.HttpSession.setAttribute()

NAMING_DIRECTORY

- javax.naming.Context()
- javax.naming.Context.bind()
- javax.naming.Context.list()
- javax.naming.Context.listBindings()
- javax.naming.Context.lookup()
- javax.naming.Context.lookupLink()
- javax.naming.Context.rebind()
- javax.naming.Context.rename()
- javax.naming.Context.unbind()
- javax.naming.directory.DirContext()
- javax.naming.directory.InitialDirContext()
- javax.naming.InitialContext()
- javax.naming.InitialContext.lookup()

SOCKET

- java.net.DatagramSocket()
- java.net.DatagramSocket.connect()
- java.net.http.HttpClient.newWebSocketBuilder()
- java.net.http.WebSocket.Builder.buildAsync()
- java.net.http.WebSocket.sendBinary()
- java.net.http.WebSocket.sendPing()
- java.net.http.WebSocket.sendPong()
- java.net.http.WebSocket.sendText()
- java.net.ServerSocket()
- java.net.ServerSocket.accept()
- java.net.Socket()
- java.net.Socket.connect()
- java.net.Socket.getInputStream()
- java.nio.channels.ServerSocketChannel()
- java.nio.channels.ServerSocketChannel.socket()
- java.nio.channels.SocketChannel()
- java.rmi.server.RMIWebSocketFactory()
- java.rmi.server.RMIWebSocketFactory.createServerSocket()
- java.rmi.server.RMIWebSocketFactory.createSocket()
- javax.websocket.WebSocketContainer()

- java.net.URLDecoder.decode()
- java.net.URLEncoder.encode()
- java.nio.charset.CharsetDecoder.charset()

Continued on next page

	<pre> java.nio.charset.CharsetEncoder.charset() java.security.MessageDigest.getInstance() java.security.MessageDigest() java.util.Base64.Decoder.decode() java.util.Base64.Decoder.wrap() java.util.Base64.Encoder.encode() java.util.Base64.Encoder.encodeToString() </pre>
	<pre> java.util.Base64.Encoder.wrap() java.util.Base64.getDecoder() java.util.Base64.getEncoder() javax.crypto.Cipher.doFinal() javax.crypto.Cipher.getInstance() javax.crypto.Cipher.init() javax.crypto.Cipher.update() javax.crypto.Cipher.updateAAD() javax.crypto.Cipher.wrap() javax.websocket.Decoder.Binary.decode() javax.websocket.Decoder.Text.decode() </pre> <hr/>
	<pre> java.lang.Runtime.load() java.lang.Runtime.loadLibrary() java.lang.System.load() java.lang.System.loadLibrary() </pre> <hr/>
PROCESS	<pre> java.awt.Desktop.open() java.lang.ProcessBuilder.start() java.lang.ProcessBuilder() java.lang.Runtime.exec() </pre> <hr/>
	<pre> java.beans.Introspector.getBeanInfo() java.beans.PropertyDescriptor() java.beans.PropertyDescriptor.getWriteMethod() java.io.ObjectInputStream.readObject() java.lang.Class.forName() java.lang.Class.getConstructor() java.lang.Class.getConstructors() java.lang.Class.getDeclaredConstructor() java.lang.Class.getDeclaredConstructors() java.lang.Class.getDeclaredMethod() java.lang.Class.getDeclaredMethods() java.lang.Class.getMethod() java.lang.Class.getMethods() java.lang.Class.getSuperclass() </pre>
	<pre> java.lang.Class.newInstance() java.lang.ClassLoader() java.lang.ClassLoader.defineClass() java.lang.reflect.AccessibleObject.setAccessible() java.lang.reflect.Constructor.newInstance() java.lang.reflect.Method.getDeclaringClass() java.lang.reflect.Method.invoke() java.net.URLClassLoader() java.net.URLClassLoader.newInstance() java.rmi.server.RMIClassLoader.getClassLoader() java.rmi.server.RMIClassLoader.loadClass() java.util.ServiceLoader.load() java.util.ServiceLoader.loadInstalled() </pre> <hr/>
	<pre> javax.script.ScriptEngine.eval() </pre>

Continued on next page

SCRIPTING	javax.script.ScriptEngineFactory.getScriptEngine()
	javax.script.ScriptEngineManager()
	javax.script.ScriptEngineManager.getEngineByExtension()
	javax.script.ScriptEngineManager.getEngineByMimeType()
	javax.script.ScriptEngineManager.getEngineByName()
	javax.script.ScriptEngineManager.getEngineFactories()
	jdk.jshell.JShell.Builder.build()
	jdk.jshell.JShell.builder()
	jdk.jshell.JShell.create()
	jdk.jshell.JShell.eval()
jdk.nashorn.api.scripting.NashornScriptEngine.eval()	

End

II. ANALYSIS ON CVEs AND VULNERABLE FUNCTIONS

TABLE II. Security-sensitive API Calls in Vulnerable Functions

The Pkg (avg) row shows the data statistic from the package granularity if we took the average number of API calls for each package. The Pkg (max) row shows the data statistic from the package granularity if we took the maximum API calls for each package. **Observation:** Half of the package versions have at least 1 call to a security-sensitive API.

Unit	#	Min	Q25%	Med	Q75%	Max	Mean	Std.Dev
Pkg vers	2807	0	0	1	7	206	6.98	18.81
Pkg (avg)	44	0	0	0.92	4.94	84.84	5.01	13.16
Pkg (max)	44	0	0	2	11	206	9.84	30.75

TABLE III. CVE Distribution in the Chosen Packages

OWASP ID	Description	#CWE	#CVE
A01	Broken Access Control	14	41
A02	Cryptographic Failures	3	6
A03	Injection	11	40
A04	Insecure Design	5	15
A05	Security Misconfiguration	2	5
A06	Vulnerable and Outdated Components	0	0
A07	Identification and Authentication Failures	2	3
A08	Software and Data Integrity Failures	4	79
A09	Security Logging and Monitoring Failures	1	1
A10	Server-Side Request Forgery (SSRF)	1	1
Other	Outside the OWASP categorization	30	79
NoInfo	Insufficient Information		26
None	No CWE Assigned		3
Total		73	299

III. SURVEY

TABLE IV. Developer Survey Questions

Measured Variable	Question	Answer form
Expectation before information	When you adopt library X in your project which kind of security-sensitive API categories would you expect to be called from library X?	(A) Checkbox category
Perceived usefulness	Do you think the information on security-sensitive API calls can aid when comparing/choosing alternative packages for a given functionality?	(B) Binary
Perceived usefulness reasoning	Why do you think the security-sensitive API call is useful/ useless?	(C) Text
Actual usefulness	If you had known this security-sensitive API information before choosing the dependency, how would it affect your decision?	(D) Multiple choice
Actual usefulness reasoning	Please elaborate on your choice from the previous question (e.g., why).	(C) Text
API sensitivity	In your opinion, which of the following API categories should be considered sensitive for any package?	(A) Checkbox category
API sensitivity details	Based on your answer to the previous question, what is the degree of sensitivity for your selected API categories?	(E) 10-points Likert scale
PILOT ONLY		
Survey clarity	Please rate the clarity of this survey	(F) 5-points Likert scale
Survey visualization comprehensibility	Please rate the comprehensibility/understandability of the visualizations	(F) 5-points Likert scale

- (A) Checkbox with 15 security-sensitive API categories.
- (B) Binary: yes, no
- (C) Text: open-ended text field
- (D) Multiple choice
 - keep using chosen dependency
 - keep using chosen dependency but will consider for the future
 - select dependency with the lowest usage
 - select dependency based on call in a category
 - other (please specify).
- (E) 10-point Likert scale: 1 is the least sensitive and 10 is the most sensitive.
- (F) 5-point Likert scale: very negative, somewhat negative, neither-negative-nor-positive, somewhat positive, very positive



FIG. 1. Dependency injection packages' security-sensitive API usage

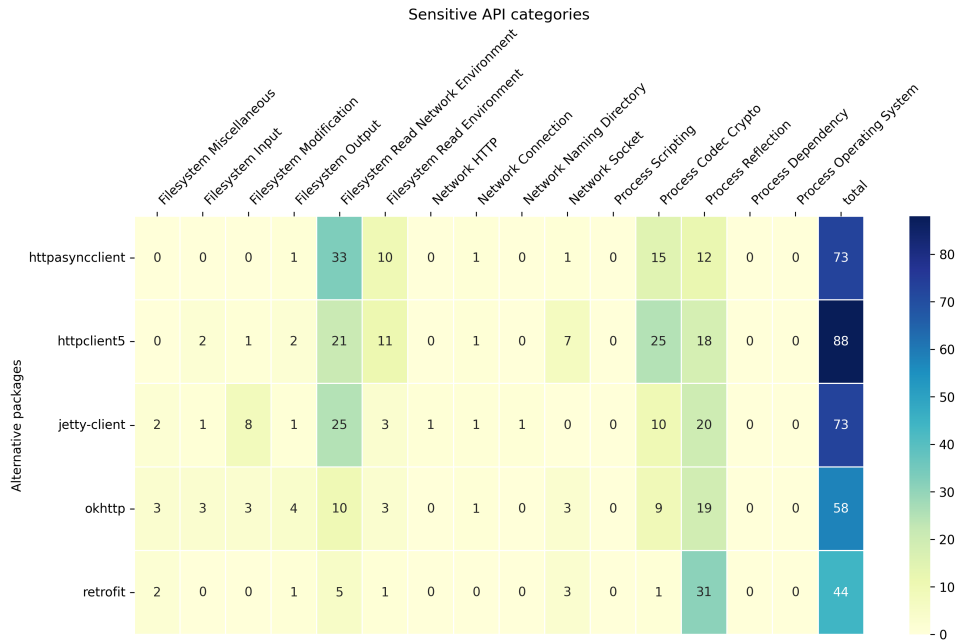

FIG. 2. HTTP client packages' security-sensitive API usage



FIG. 3. I/O utility packages' security-sensitive API usage

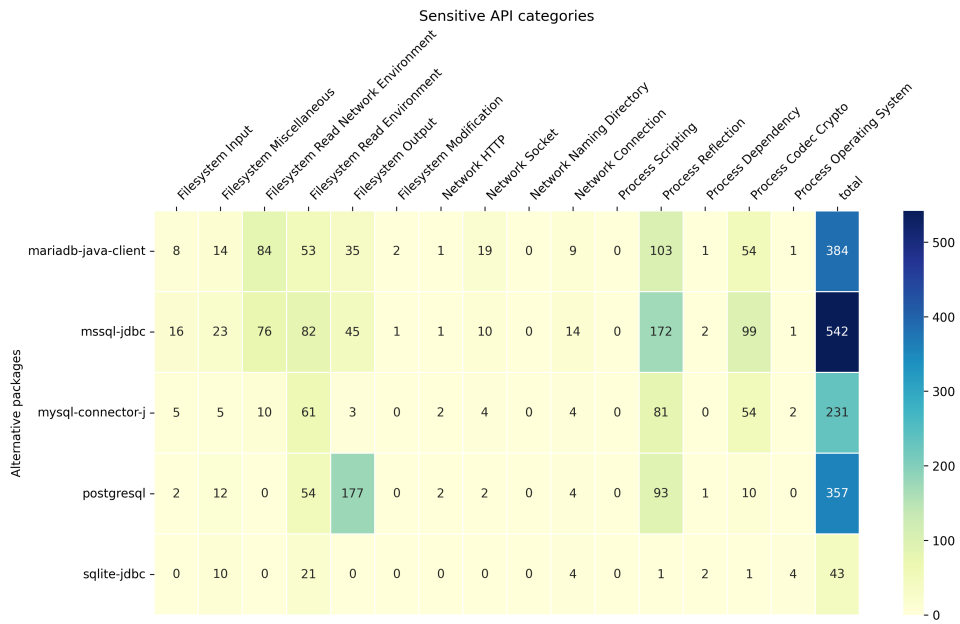

FIG. 4. JDBC driver packages' security-sensitive API usage

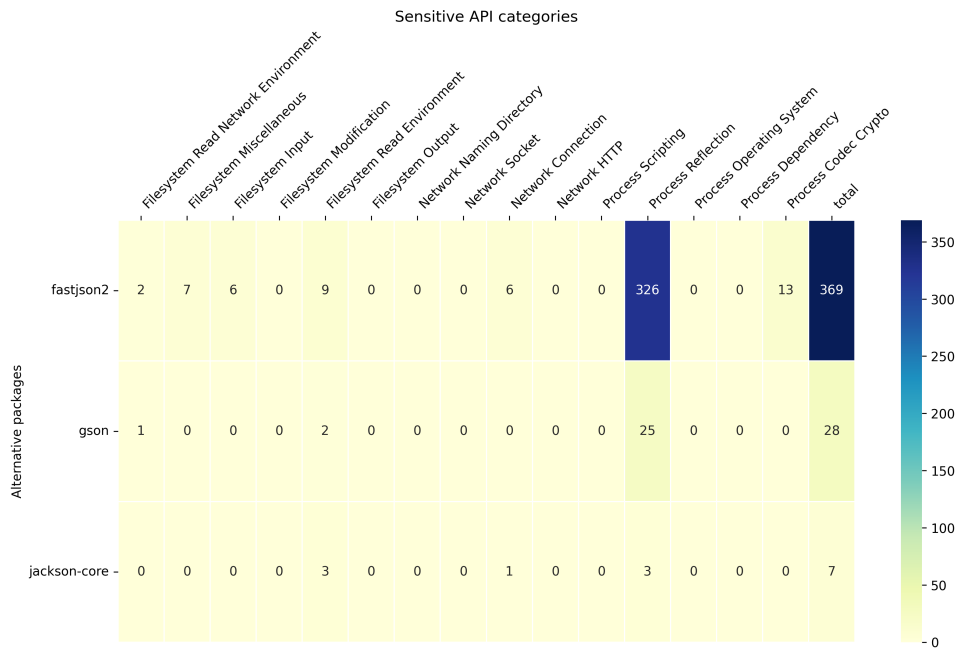

FIG. 5. JSON library packages' security-sensitive API usage



FIG. 6. Logging packages' security-sensitive API usage

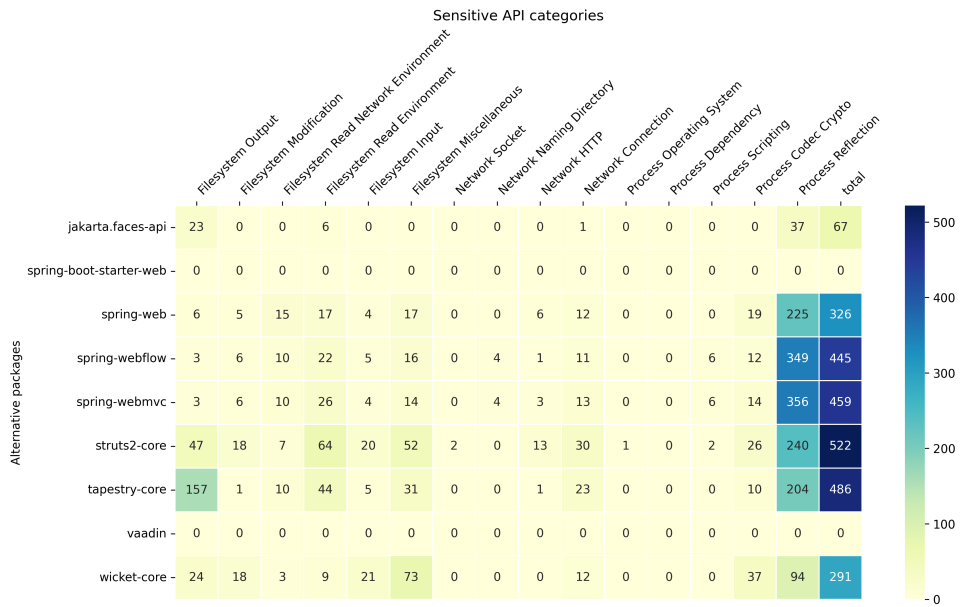

FIG. 7. Web framework packages' security-sensitive API usage

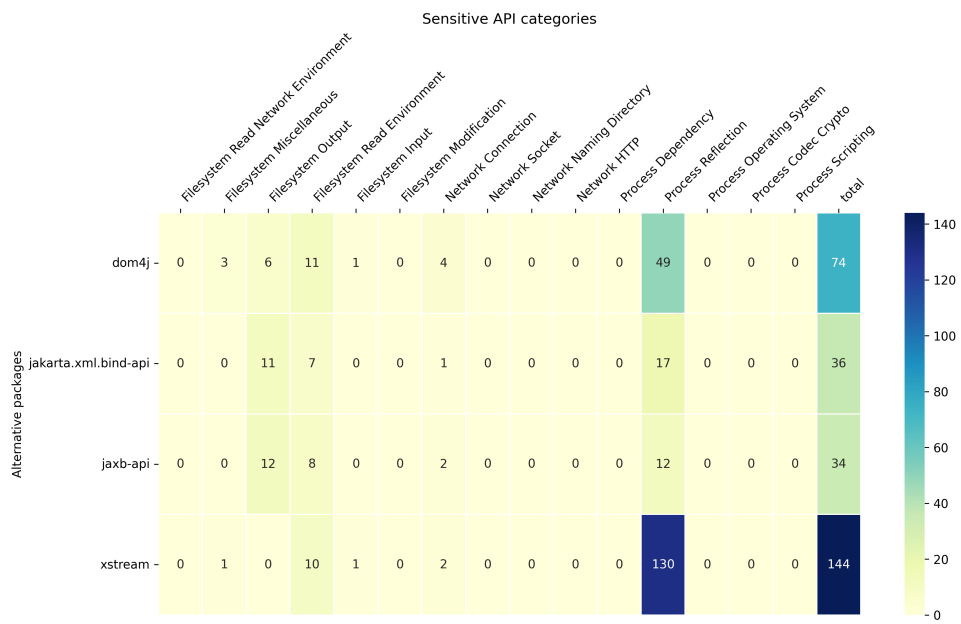

FIG. 8. XML parser packages' security-sensitive API usage