

# PRINCIPAL MINORS OF THE DISTANCE MATRIX OF A TREE

ÁLVARO GUTIÉRREZ AND ADRIÁN LILLO

ABSTRACT. Let  $T = ([n], E)$  be a tree and let  $D = (d(i, j))_{i, j \leq n}$  be the distance matrix of  $T$ . Let  $S \subseteq [n]$ . We give the first combinatorial proof for a formula to compute the principal minor of  $D$  indexed by  $S$ , namely  $\det D[S]$ . This generalizes work of Graham and Pollak, as well as more recent works.

*As presented in the 30th British Combinatorial Conference*

## 1. INTRODUCTION

Consider a tree  $T = ([n], E)$  with  $n$  vertices. The distance between two vertices  $i$  and  $j$ , denoted by  $d(i, j)$ , is defined as the number of edges in the unique path  $P(i, j)$  from  $i$  to  $j$  in  $T$ . Let  $D = (d(i, j))_{1 \leq i, j \leq n}$  be the distance matrix of  $T$ . Graham and Pollak [GP71] gave in 1971 the following formula for the determinant of the distance matrix of a tree:

$$\det D = (-1)^{n-1} (n-1) 2^{n-2}.$$

Of particular significance, this formula only depends on the number of vertices of  $T$ , and not on its structure.

There exist several elementary proofs of Graham and Pollak's formula [GP71, GL78, YY07, Til10, ZD16a, DY20], as well as many generalizations to weighted trees [BKN05, BLP09, ZD16a] and  $q$ -analogues of the above [BLP06, YY07, LSZ14]. So far, all these generalized notions of distance are *additive*, in the sense that the distance from  $i$  to  $j$  can be expressed as the sum of certain polynomials depending on the intermediate paths  $P(k, j)$  as  $k$  ranges over the nodes of  $P(i, j)$ . Multiplicative generalizations of distances were explored in [YY06, ZD16b]. Recently, a very general framework was developed by Choudhury and Khare in [CK23b], which gives a formula that specializes to all of the above. (Also for general graphs, see [CK23a].) Moreover, the formula also specializes to compute *some* principal and non-principal minors of the matrix. A similar but different expression to compute *all* principal minors of the matrix was very recently given by Richman, Shokrieh, and Wu [RSW24]. A multiplicative distance analogue is [HY15].

The first involutive proof of Graham and Pollak's formula was given by Briand, Esquivias, Rosas and the authors of the present paper in [BEGLR24b, BEGLR24c]. Furthermore, the determinant of all of the additive distance matrices generalized above follow easily from the bijections. The main idea is to reduce the problem to a path enumeration problem, and to invoke the Lindström–Gessel–Viennot Lemma [Lin73, GV85] to conclude.

In the present paper, we give a new formula for the principal minors of the distance matrix of a tree. Our proof is bijective and based on [BEGLR24c]. Our methods can be used to deduce formulas given in [CK23b, RSW24].

---

Date: 1st July, 2024.

**Outline of paper.** We begin by fixing graph theoretic notation and stating our main results in Section 2. We turn the problem into an enumeration of combinatorial objects coined catalysts in Section 3, after which we are ready to give an outline of the proof of Theorem A. The details of the proof are postponed to Propositions 4.1, 4.2, 4.3. We devote Section 5 to the proof of Proposition 4.1. Sections 6 and 7 reduce the remainder of problem even further to a path enumeration problem. In order to do this, several combinatorial constructions have to be carefully examined. Much of this is delegated to [BEGLR24c] and [BEGLR24a], where the analysis takes up the bulk of the works. We show Proposition 4.2 in Section 8 and Proposition 4.3 in Section 9. We conclude by deducing [RSW24] in Section 10, and a Corollary of [CK23b] in Section 11 and giving some closing remarks.

## 2. STATEMENT OF THE MAIN THEOREM

If  $X$  is a finite set, we denote as  $\mathbb{S}_X$  the set of permutations of  $X$ . When  $X = [k]$  for some integer  $k \geq 0$ , we simplify the notation to  $\mathbb{S}_k$ , as is customary.

Throughout the paper, fix a tree  $T = ([n], E)$  with  $n$  vertices, and consider a subset  $S \subseteq [n]$  of  $m \geq 2$  vertices. We let  $E^\pm$  be the set of all possible oriented arcs supported on  $T$ . That is, for each  $\{i, j\} \in E$ , we have  $(i, j) \in E^\pm$  and  $(j, i) \in E^\pm$ .

Given a simple graph  $G$ , we let  $\epsilon(G)$  be the number of edges of  $G$  and  $cc(G)$  be the number of connected components of  $G$ . For instance,  $\epsilon(T) = n - 1$  and  $cc(T) = 1$ . A subgraph of a simple graph  $G = (V, E)$  is a graph  $H = (V', E')$  where  $V' \subseteq V$  and  $E' \subseteq E$ . We write  $H \subseteq G$ . For subgraphs  $H \subseteq T$  of a tree, we have  $cc(H) = n - \epsilon(H)$ . A *spanning forest* of a graph  $G$  is an acyclic subgraph containing every vertex of  $G$ . The union of two simple graphs  $G = (V, E)$  and  $G' = (V', E')$  is the simple graph  $G \cup G' = (V \cup V', E \cup E')$ .

We borrow from [RSW24] the following concepts:

**Definition 2.1.** Let  $T = ([n], E)$  be a tree, let  $S \subseteq [n]$  be a subset of cardinality  $m$ . A spanning forest  $F$  of  $T$  is said to be  *$S$ -rooted* if it has  $m$  connected components and each of its connected components has exactly one vertex in  $S$ . See Figure 1(c). We write  $F = \bigsqcup_{s \in S} F_s$ , where  $F_s$  is the component of  $F$  containing  $s$ . We denote the set of  $S$ -rooted spanning forests of  $T$  by  $\mathcal{F}_S(T)$ .

Similarly, a spanning forest  $F$  is said to be  *$(S, *)$ -rooted* if it has  $m + 1$  connected components, and exactly one of them does not contain any vertex of  $S$ . See Figure 1(d). We write  $F = F_* \sqcup \bigsqcup_{s \in S} F_s$ , where  $F_s$  is the component of  $F$  containing  $s$ . We call  $F_*$  the *floating component* of  $F$ . The set of  $(S, *)$ -rooted spanning forests of  $T$  is denoted  $\mathcal{F}_S^*(T)$ .

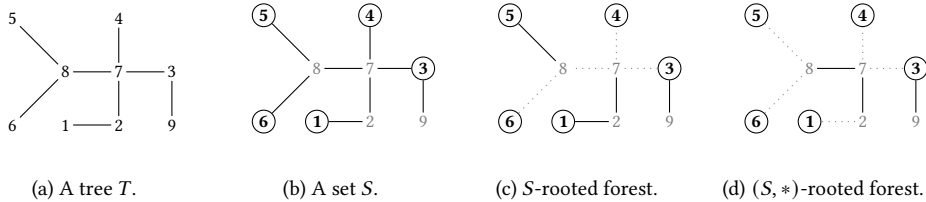

FIGURE 1

Let  $G$  be a simple graph, let  $F = \bigsqcup_{i \in I} F_i$  be a spanning forest of  $G$ , with  $F_i = (V_i, E_i)$ . The *boundary of a component*  $F_{i_0}$ , denoted  $\partial F_{i_0}$ , is the set of nodes of  $G$

adjacent to  $F_{i_0}$  in  $\sqcup_{i \in I, i \neq i_0} F_i$ . That is,

$$\partial F_{i_0} = \{u \in V - V_{i_0} : \exists \{u, v\} \in E, v \in V_{i_0}\}.$$

The *boundary degree* of  $F_{i_0}$  is defined as the number of such nodes,

$$\delta(F_{i_0}) := \#\partial F_{i_0}.$$

Similarly, given a vertex  $x$  of the tree, we write  $\partial x$  for the set of its neighbors and  $\delta(x) = \#\partial x$  for its degree. (Since the discrete graph supported on  $[n]$  is a spanning forest, the notation is consistent with the above.)

**Theorem A.** *Let  $T = ([n], E)$  be a tree and let  $D$  be its distance matrix. Let  $S \subseteq [n]$  be a subset of cardinality  $m \geq 2$ . Then*

$$\det D[S] = (-1)^{m-1} 2^{m-2} \left( (m-1) \#\mathcal{F}_S(T) - \sum_{F \in \mathcal{F}_S^*(T)} (\delta(F_*) - 1)(\delta(F_*) - 4) \right).$$

Compare this with the formula given in [RSW24] (see Theorem 10.1). As a sanity check: if  $S = [n]$  then  $\#\mathcal{F}_S(T) = 1$  and  $\#\mathcal{F}_S^*(T) = 0$ , and our formula specializes to the Graham–Pollak formula.

### 3. S-CATALYSTS AND $m$ -ARROWFLOWS

#### Catalysts.

**Definition 3.1.** Given a permutation  $\sigma$  in  $\mathbb{S}_S$  and a map  $f : S \rightarrow E^\pm$ , we say that the ordered pair  $(\sigma, f)$  is an *S-catalyst for T* if, for each vertex  $i$  of  $S$ , the arc  $f(i)$  lies in the path from  $i$  to  $\sigma(i)$ , and is oriented according to this path. (Note that the endpoints of  $f(i)$  do not necessarily belong to  $S$ .) We denote by  $K_S$  the set of all *S-catalysts for T*.

In particular, when  $S = [n]$ , an *S-catalyst for T* is a catalyst for  $T$  in the sense of [BEGLR24c]. Catalysts were introduced in [BEGLR24c] as the natural object for which  $\det D$  is a signed enumeration. Indeed, since there are  $d(i, \sigma(i))$  edges in the path from  $i$  to  $\sigma(i)$ , then

$$\det D[S] = \sum_{\sigma \in \mathbb{S}_S} \operatorname{sgn}(\sigma) d(s_1, \sigma(s_1)) \cdots d(s_m, \sigma(s_m)) = \sum_{(\sigma, f) \in K_S} \operatorname{sgn}(\sigma). \quad (1)$$

**Example 3.2.** Let  $T$  and  $S$  be the tree and set of Figure 1. Figure 2 showcases four *S-catalysts for T*. We can represent them as follows:

$$\left( \begin{array}{cccccc} 1 & 3 & 4 & 5 & 6 \\ \sigma & 5 & 6 & 3 & 4 & 1 \\ f & 85 & 37 & 47 & 87 & 87 \end{array} \right), \left( \begin{array}{cccccc} 1 & 3 & 4 & 5 & 6 \\ \sigma & 3 & 5 & 6 & 4 & 1 \\ f & 27 & 37 & 47 & 87 & 21 \end{array} \right), \left( \begin{array}{cccccc} 1 & 3 & 4 & 5 & 6 \\ \sigma & 3 & 4 & 5 & 6 & 1 \\ f & 73 & 37 & 47 & 86 & 87 \end{array} \right), \left( \begin{array}{cccccc} 1 & 3 & 4 & 5 & 6 \\ \sigma & 3 & 4 & 1 & 6 & 5 \\ f & 73 & 74 & 21 & 58 & 68 \end{array} \right).$$

For instance, for the *S-catalyst*  $(\sigma, f)$  of Figure 2(a),  $\sigma(1) = 5$  and  $f(1) = (8, 5)$ . This is illustrated with a path from 1 to 5 with a mark at  $(8, 5)$ .

#### Arrowflows.

**Definition 3.3.** Let  $k$  be a nonnegative integer. We define a *k-arrowflow on T* to be a directed multigraph with vertex set  $[n]$ , with  $k$  arcs (counted with multiplicity), and whose underlying simple graph is a subgraph of  $T$ .

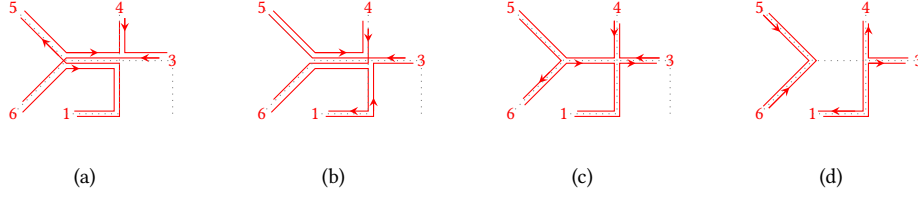
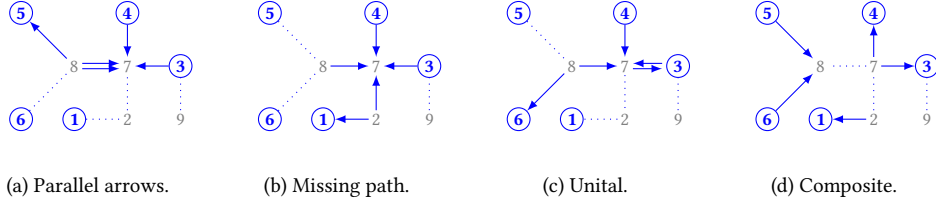
FIGURE 2. Four  $S$ -catalysts for  $T$ .FIGURE 3. Four  $m$ -arrowflows on  $T$ .

If  $k = n$ , we emphasize this saying that the  $k$ -arrowflow is *complete*. A complete  $k$ -arrowflow is an arrowflow in the sense of [BEGLR24c].

Given an  $S$ -catalyst  $\kappa = (\sigma, f)$  for  $T$ , we define the  $m$ -arrowflow induced by  $\kappa$  as the  $m$ -arrowflow on  $T$  with arc multiset  $\{\{f(i) \mid i \in S\}\}$ .

**Example 3.4.** The four arrowflows of Figure 3 are induced from the four catalysts of Figure 2.

The  $m$ -arrowflow class of  $A$  for  $S$ , denoted by  $C_S(A)$ , is defined as the set of  $S$ -catalysts for  $T$  inducing the  $m$ -arrowflow  $A$ . The non-empty arrowflow classes form a partition of the set of  $S$ -catalysts, allowing us to rewrite Equation (1) as

$$\det D[S] = \sum_A \sum_{\kappa \in C_S(A)} \operatorname{sgn}(\kappa)$$

where  $A$  ranges over the set of  $m$ -arrowflows on  $T$ .

To better understand this sum, we distinguish three different classes of  $m$ -arrowflows. Given a digraph  $A = (V, E)$ , its *underlying simple graph* is the graph  $\operatorname{SG}(A)$  with vertex set  $V$  and edge set  $\{\{u, v\} : (u, v) \in E\}$ . Given a simple graph  $G = (V, E)$  and a subgraph  $H = (V, E')$  with same vertex set, the *complement* of  $H$  in  $G$  defined as the subgraph  $H^c := (V, E - E')$  of  $G$ . Note  $G = H \cup H^c$ . Back in our setting, the *missing forest of an arrowflow  $A$*  is the complement of the underlying simple graph of  $A$ , namely  $\operatorname{SG}(A)^c$ . Note that  $\operatorname{SG}(A)^c$  is a spanning forest of  $T$ .

**Definition 3.5 (Zero-sum arrowflow).** Let  $A$  be an  $m$ -arrowflow on  $T$ .

- If there is an arc  $a \in E^\pm$  that appears with multiplicity at least 2 in  $A$ , we say that  $A$  has *parallel arrows*.
- If there is a path  $P(i, j)$  in  $\operatorname{SG}(A)^c$  between a pair of vertices  $i, j$  of  $S$ , we say  $A$  has a *missing path (for  $S$ )*.

An  $m$ -arrowflow is *zero-sum (for  $S$ )* if it has either parallel arrows or a missing path for  $S$ .

**Definition 3.6 (Unital arrowflow).** An  $m$ -arrowflow  $A$  is *unital* (for  $S$ ) if it has no parallel arrows and its missing forest is  $S$ -rooted,  $\text{SG}(A)^c \in \mathcal{F}_S(T)$ .

**Definition 3.7 (Composite arrowflow).** An  $m$ -arrowflow  $A$  is *composite* (for  $S$ ) if it has no parallel arrows and its missing forest is  $(S, *)$ -rooted,  $\text{SG}(A)^c \in \mathcal{F}_S^*(T)$ .

**Example 3.8.** The arrowflow of Figure 3(a) has parallel arrows at  $(8, 7)$ , and thus it is a zero-sum arrowflow. The arrowflow of Figure 3(b) has a missing path  $P(5, 6)$ . The remaining two arrowflows are unital and composite, respectively. Indeed, the missing forest of Figure 3(c) is the  $S$ -rooted forest of Figure 1(c), and the missing forest of Figure 3(d) is the  $(S, *)$ -rooted forest of Figure 1(d).

**Lemma 3.9.** Every  $m$ -arrowflow is either zero-sum, unital, or composite for  $S$ .

*Proof.* Let  $A$  be an  $m$ -arrowflow on  $T$ . The number of connected components of  $\text{SG}(A)^c$  is

$$\begin{aligned} cc(\text{SG}(A)^c) &= n - \epsilon(\text{SG}(A)^c) \\ &= n - ((n-1) - \epsilon(\text{SG}(A))) \\ &= 1 + \epsilon(\text{SG}(A)) \\ &\leq 1 + \epsilon(A) \\ &= m + 1. \end{aligned}$$

If  $A$  has a missing path then  $A$  is zero-sum. Suppose otherwise; then each vertex of  $S$  lies in a different connected component of  $\text{SG}(A)^c$ . In particular, we get  $m \leq cc(\text{SG}(A)^c) \leq m + 1$  and the missing forest  $\text{SG}(A)^c$  is either  $S$ -rooted or  $(S, *)$ -rooted. Altogether,  $A$  is either zero-sum, unital, or composite. ■

#### 4. PROOF OF THE MAIN THEOREM

The proof of Theorem A will follow from the following propositions, whose proofs will unfold over the next sections.

**Proposition 4.1.** Let  $A$  be a zero-sum arrowflow. Then,

$$\sum_{\kappa \in \mathcal{C}_S(A)} \text{sgn}(\kappa) = 0.$$

**Proposition 4.2.** Let  $A$  be a unital arrowflow. Then,

$$\sum_{\kappa \in \mathcal{C}_S(A)} \text{sgn}(\kappa) = (-1)^{m-1}.$$

Let  $F \in \mathcal{F}_S(T)$  be an  $S$ -rooted forest. The number of unital arrowflows with missing forest  $F$  is  $(m-1)2^{m-2}$ .

**Proposition 4.3.** Let  $F \in \mathcal{F}_S^*(T)$  be an  $(S, *)$ -rooted spanning forest of  $T$ . Then,

$$\sum_{\substack{A \\ \text{composite} \\ \text{SG}(A)^c = F}} \sum_{\kappa \in \mathcal{C}_S(A)} \text{sgn}(\kappa) = (-1)^m 2^{m-2} (\delta(F_*) - 1) (\delta(F_*) - 4).$$

We end this section with the proof of Theorem A, which we recall below.

**Theorem (A).** *Let  $T = ([n], E)$  be a tree and let  $D$  be its distance matrix. Let  $S \subseteq [n]$  be a subset of cardinality  $m \geq 2$ . Then*

$$\det D[S] = (-1)^{m-1} 2^{m-2} \left( (m-1) \# \mathcal{F}_S(T) - \sum_{F \in \mathcal{F}_S^*(T)} (\delta(F_*) - 1)(\delta(F_*) - 4) \right).$$

*Proof of Theorem A.* Equation (1) establishes

$$\det D[S] = \sum_{(\sigma, f) \in K_S} \operatorname{sgn}(\sigma) = \sum_A \sum_{\kappa \in C_S(A)} \operatorname{sgn}(\kappa).$$

We expand this sum into three summands and get

$$\det D[S] = \sum_{\text{zero-sum}} \sum_A \sum_{\kappa \in C_S(A)} \operatorname{sgn}(\kappa) + \sum_{\text{unital}} \sum_A \sum_{\kappa \in C_S(A)} \operatorname{sgn}(\kappa) + \sum_{\text{composite}} \sum_A \sum_{\kappa \in C_S(A)} \operatorname{sgn}(\kappa).$$

The first summand vanishes by Proposition 4.1. By Proposition 4.2, the second summand is

$$(-1)^{m-1} (m-1) 2^{m-2} \# \mathcal{F}_S(T).$$

Finally, by Proposition 4.3, the last summand is

$$\begin{aligned} \sum_{\text{composite}} \sum_A \sum_{\kappa \in C_S(A)} \operatorname{sgn}(\kappa) &= \sum_{F \in \mathcal{F}_S^*(T)} \sum_{\substack{A \\ \text{composite} \\ \text{SG}(A)^c = F}} \sum_{\kappa \in C_S(A)} \operatorname{sgn}(\kappa) \\ &= \sum_{F \in \mathcal{F}_S^*(T)} (-1)^m 2^{m-2} (\delta(F_*) - 1)(\delta(F_*) - 4). \end{aligned}$$

Altogether, we obtain the desired formula.  $\blacksquare$

## 5. ZERO-SUM ARROWFLOWS

This section is dedicated to a combinatorial proof of Proposition 4.1. Given a zero-sum arrowflow  $A$ , we construct a sign-reversing involution on the set  $C_S(A)$  of catalysts that induce  $A$ . We conclude that the signed enumeration of such catalysts is 0. In order to do this, we adapt the constructions of [BEGLR24c].

**Lemma 5.1.** *Let  $A$  be a zero-sum  $m$ -arrowflow on  $T$ . If  $A$  has a missing path, let  $i$  and  $j$  be its endpoints. On the other hand, if  $A$  has parallel arrows, let  $i$  and  $j$  be the two preimages of those arrows under  $f$ . Then, the map*

$$\begin{aligned} \varphi : C_S(A) &\rightarrow C_S(A) \\ (\sigma, f) &\mapsto (\sigma \circ (i j), f \circ (i j)) \end{aligned}$$

*is a sign-reversing involution.*

*Proof.* The map is clearly an involution if it is well defined. To see that it is well defined, we need to show that  $f(i)$  is an arc in both  $P(j, \sigma(i))$  and  $P(i, \sigma(i))$ .

Suppose  $A$  has parallel arrows,  $f(i) = f(j)$ . Then,  $i$  and  $j$  lie in the same connected component of  $T - \{f(i)\}$ , whereas  $\sigma(i)$  and  $\sigma(j)$  lie in the other component. This shows the claim.

Suppose  $A$  has a missing path  $P(i, j) \subseteq \text{SG}(A)^c$ . Now  $P(j, \sigma(i))$  and  $P(i, \sigma(i))$  coincide everywhere except in a subgraph of  $P(i, j)$ . Since  $f(i)$  is not in  $P(i, j)$ , it must appear with the same orientation in both paths. See Figure 4.  $\blacksquare$

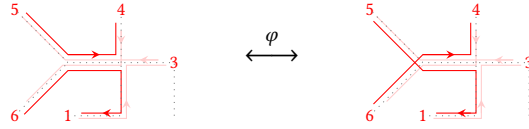

FIGURE 4. Involution  $\varphi$  on an  $m$ -arrowflow class  $C_S(A)$ , where  $A$  is as in Figure 3(b) and has missing path  $P(5, 6)$ .

6. QUOTIENT ARROWFLOWS

Given a simple graph  $G = (V, E)$  and a partition  $V = \bigsqcup_{i \in I} V_i$  of its vertex set, we define the *quotient graph*  $G/\sim_I$  with respect to this partition as the graph obtained from  $G$  by contracting each  $V_i$ . That is,  $G/\sim_I$  has vertex set  $I$  and an edge  $\{i, j\}$  whenever  $i \neq j$  and there exists  $u \in V_i$  and  $v \in V_j$  such that  $\{u, v\} \in E$ . Similarly, let  $A$  be a digraph with underlying simple graph  $SG(A) = G$  as above. The quotient *multigraph*  $A/\sim_I$  with respect to this partition is defined as the multigraph obtained from  $A$  by contracting each  $V_i$ .

**Definition 6.1 (Quotient arrowflow).** Let  $A$  be an arrowflow, let  $F = SG(A)^c = \bigsqcup_{i \in I} F_i$  be its missing forest,  $F_i = (V_i, E_i)$  for each  $i \in I$ . Note that  $V = \bigsqcup_{i \in I} V_i$  is a partition of  $V$ . The *quotient arrowflow*  $A/\sim$  is defined to be the quotient multigraph with respect to this partition. See Figure 5.

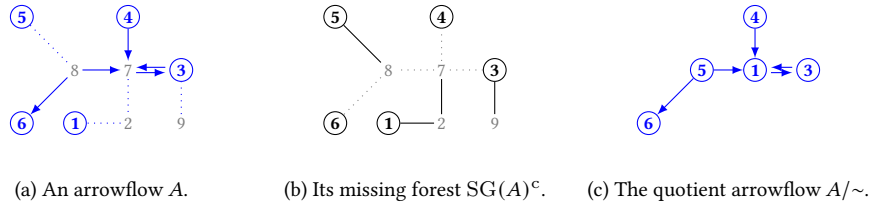

FIGURE 5

In Lemma 6.2, we slightly abuse notation by identifying an arrowflow  $A$  and its quotient  $A/\sim$  with their respective sets of arcs (without multiplicity).

**Lemma 6.2.** *Let  $A$  be an arrowflow with missing forest  $\bigsqcup_{i \in I} F_i$ , and let  $\psi : [n] \rightarrow I$  denote the quotient projection. Then, the map*

$$\begin{aligned} \phi : A &\rightarrow A/\sim \\ (i, j) &\mapsto (\psi(i), \psi(j)) \end{aligned}$$

is a bijection.

*Proof.* We first address the well-definition. If  $(i, j)$  is an arc of  $A$ , then  $i$  and  $j$  lie in distinct components of the missing forest  $SG(A)^c$ . Hence  $\psi(i) \neq \psi(j)$  and  $(\psi(i), \psi(j))$  is an arc of the quotient arrowflow  $A/\sim$ . Thus  $\phi$  is well-defined.

Surjectivity follows from the definitions. To show injectivity, suppose that  $\phi(a) = \phi(b)$  for two arcs  $a = (u_a, v_a)$  and  $b = (u_b, v_b)$  of  $A$ :

$$\begin{array}{ccc} & b & \\ u_b & \xrightarrow{\quad} & v_b \\ u_a & \xrightarrow{\quad} & v_a \\ & a & \end{array}$$

Since  $\phi(a) = \phi(b)$ , the vertices  $u_a$  and  $u_b$  are mapped to the same vertex under the quotient, so we deduce  $u_a$  and  $u_b$  belong to the same connected component of  $\text{SG}(A)^c$ . In particular, there is a path  $P(u_a, u_b) \subseteq \text{SG}(A)^c \subseteq T$ . Similarly, there is a path  $P(v_b, v_a) \subseteq \text{SG}(A)^c \subseteq T$ . But then, there are two paths

$$P(u_a, u_b) \ b \ P(v_b, v_a) \quad \text{and} \quad a$$

from  $u_a$  to  $v_a$  in  $T$ . Since  $T$  is a tree, this implies  $u_a = u_b$  and  $v_a = v_b$ . We conclude that  $\phi$  is a bijection, as claimed.  $\blacksquare$

If  $A$  is a unital arrowflow, then its missing forest is  $S$ -rooted. That is, the connected components of  $\text{SG}(A)^c$  are indexed by the vertices of  $S$ . We therefore take  $I = S$ . Similarly, if  $A$  is a composite arrowflow, then its missing forest  $\text{SG}(A)^c$  is  $(S, *)$ -rooted; we can take  $I = S \sqcup \{*\}$ , where  $*$  denotes the quotient projection of the floating component of  $\text{SG}(A)^c$ . Remark that, in both cases, the restriction of the quotient map  $\psi : [n] \rightarrow I$  to  $S$  is the identity map,  $\psi|_S = \text{Id}_S$ .

**Lemma 6.3.** *Let  $A$  be an  $m$ -arrowflow on  $T$ . Then its quotient arrowflow  $A/\sim$  is an  $m$ -arrowflow on  $T/\sim$ . Moreover,*

- (1)  *$A$  has parallel arrows if and only if  $A/\sim$  has parallel arrows,*
- (2) *if  $A$  is unital (for  $S$ ) then  $A/\sim$  is unital (for  $S$ ), and*
- (3) *if  $A$  is composite (for  $S$ ) then  $A/\sim$  is composite (for  $S$ ).*

*Proof.* Let  $A$  be an  $m$ -arrowflow on  $T$ . The vertex sets of both  $A/\sim$  and  $T/\sim$  coincide. Furthermore,  $A/\sim$  has  $m$  arcs counted with multiplicity and

$$\text{SG}(A/\sim) = \text{SG}(A)/\sim \subseteq T/\sim .$$

Thus,  $A/\sim$  is an  $m$ -arrowflow on  $T/\sim$ .

If  $A$  has parallel arrows, so does  $A/\sim$ . Reciprocally, if  $(u, v)$  appears with multiplicity at least two in  $A/\sim$ , then there are two arcs joining the components  $\psi^{-1}(u)$  and  $\psi^{-1}(v)$  of  $\text{SG}(A)^c$ . As argued in Lemma 6.2, this implies that the arcs are supported on the same edge of  $A$ , and pointing in the same direction. This shows (1).

We show (2) and (3) together. If  $A$  is unital or composite, the vertex set of  $A/\sim$  is  $I = S$  or  $I = S \sqcup \{*\}$ , respectively. The result follows noting that, in either case, every vertex is isolated in  $\text{SG}(A/\sim)^c$ .  $\blacksquare$

**Example 6.4.** The arrowflow of Figure 5(c) is unital and it is the quotient arrowflow of the unital arrowflow of Figure 3(c). The arrowflow of Figure 6(c) is composite and it is the quotient arrowflow of the composite arrowflow of Figure 3(d).

**Lemma 6.5.** *Let  $A$  be either a unital or a composite  $m$ -arrowflow. There is a sign-preserving bijection between  $C_S(A)$  and  $C_S(A/\sim)$ . In particular,*

$$\sum_{\kappa \in C_S(A)} \text{sgn}(\kappa) = \sum_{\kappa \in C_S(A/\sim)} \text{sgn}(\kappa).$$



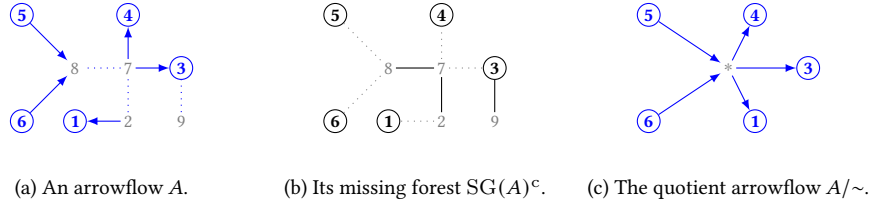

FIGURE 6

*Proof.* Let  $\phi$  be the bijection of Lemma 6.2. Given a  $S$ -catalyst  $(\sigma, f)$  of  $C_S(A)$ , we construct an  $S$ -catalyst  $(\Phi\sigma, \Phi f)$  in the catalyst class  $C_S(A/\sim)$  by letting  $\Phi\sigma = \sigma$  and  $\Phi f = \phi \circ f$ . The map  $(\sigma, f) \mapsto (\Phi\sigma, \Phi f)$  has an inverse  $(\tau, g) \mapsto (\Psi\tau, \Psi g)$  and is given by  $\Psi\tau := \tau$  and  $\Psi g := \phi^{-1} \circ g$ . Thus, it is a bijection. That it is sign-preserving is immediate. ■

## 7. ROUTE MAPS

To provide combinatorial proofs of Propositions 4.2 and 4.3, we transform our  $S$ -catalyst enumeration problem into a path enumeration problem in a network that we call the route map. This latter class of problems are well-studied and is of extreme beauty. The cornerstone of this field lies in the following lemma.

**Lemma 7.1 (LGV lemma, [Lin73] [GV85]).** *For any network  $\mathcal{G}$ , there exists a sign-reversing involution on the set of all families of network paths of  $\mathcal{G}$  such that*

- (1) *its fixed points are the non-intersecting families of network paths, and*
- (2) *it stabilizes the multiset of the families of network paths.*

We introduce the necessary concepts to understand this lemma below. The proof is elegant and well-known, even featured in *Proofs from THE BOOK* [AZ09], and so we omit it. We remark it is bijective.

Then, we recall the definition of the route map of an arrowflow introduced in [BEGLR24b, BEGLR24c]. The definition is involved and studying its properties represents the bulk of said article. In this section, we introduce the definition and collect its main properties, referring to [BEGLR24c] for many of the proofs.

### Generalities about networks.

**Definition 7.2 (Network).** A *network* is a tuple  $(\mathcal{G}, \Delta, \nabla)$  consisting of an acyclic digraph  $\mathcal{G}$  and two sets of distinguished nodes of  $\mathcal{G}$  such that  $\#\Delta = \#\nabla$ . We order these sets,  $\Delta = (i_1, \dots, i_n)$  and  $\nabla = (j_1, \dots, j_n)$ . We say each node in  $\Delta$  is a *source* and each node in  $\nabla$  is a *sink* of the network.

A *network path* in  $\mathcal{G}$  is a path from a source  $i \in \Delta$  to a sink  $j \in \nabla$ . A *family of network paths* in  $\mathcal{G}$  is a tuple  $\Lambda = (\Lambda_i)_{i \in \Delta}$  of network paths, each starting from a source  $i \in \Delta$  and ending on a distinct sink. A family of network paths is non-intersecting if paths are pairwise vertex-disjoint. The *underlying map of a family*  $\Lambda$  is the bijection  $\sigma : \Delta \rightarrow \nabla$  such that  $\Lambda_i$  is a network path from  $i$  to  $\sigma(i)$  for all  $i \in \Delta$ . When there is a canonical identification of  $\Delta$  and  $\nabla$ , we refer to this as the underlying permutation, and identify it with an element of  $\mathbb{S}_\Delta$ . In this context, we define the sign of  $\Lambda$  as the sign of  $\sigma \in \mathbb{S}_\Delta$ .

We let  $\text{FNP}(\mathcal{G})$  denote the set of families of network paths of  $\mathcal{G}$ .

We will need a notion of composition of maps  $\sigma$  and  $\tau$  with different domains and co-domains: let  $\sigma : \Delta \rightarrow \nabla$  and  $\tau : \Delta' \rightarrow \nabla'$  be two maps and define  $\tau \circ \sigma : \Delta \cup (\Delta' \setminus \nabla) \rightarrow (\nabla \setminus \Delta') \cup \nabla'$  to be the map given by

$$\tau \circ \sigma(x) = \begin{cases} \tau(\sigma(x)) & \text{if } x \in \Delta \text{ and } \sigma(x) \in \Delta', \\ \sigma(x) & \text{if } x \in \Delta \text{ and } \sigma(x) \notin \Delta', \\ \tau(x) & \text{if } x \notin \Delta \text{ and } x \in \Delta'. \end{cases}$$

This can be understood diagrammatically through the next easy example.

**Example 7.3.** Let  $\sigma : \{i_1, i_2\} \rightarrow \{j_1, j_2\}$  map  $i_1 \mapsto j_1$  and  $i_2 \mapsto j_2$ . Let  $\tau : \{j_2, i'_2\} \rightarrow \{j'_1, j'_2\}$  map  $j_2 \mapsto j'_1$  and  $i'_2 \mapsto j'_2$ . Then, the composition  $\tau \circ \sigma$  is the following:

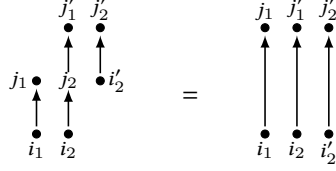

So far, we have been using the words sinks and sources in the context of networks, to refer to distinguished points of a graph. In some applications, however, it is useful to require these to be graph-theoretic sinks and sources: a node of a digraph is a *graph-theoretic sink* if it only has incoming arcs, and a *graph-theoretic source* if it only has outgoing arcs.

**Lemma 7.4.** Let  $(\mathcal{G}, \Delta, \nabla)$  and  $(\mathcal{G}', \Delta', \nabla')$  be two networks. Suppose that  $\mathcal{G} \cap \mathcal{G}' = \nabla \cap \Delta'$  and that each node in  $\nabla \cap \Delta'$  is a graph-theoretic sink of  $\mathcal{G}$  and a graph-theoretic source of  $\mathcal{G}'$ . Then,

$$\mathcal{G} \# \mathcal{G}' := \left( \mathcal{G} \cup \mathcal{G}', \quad \Delta \cup (\Delta' \setminus \nabla), \quad (\nabla \setminus \Delta') \cup \nabla' \right)$$

is a network and  $\text{FNP}(\mathcal{G} \# \mathcal{G}') = \text{FNP}(\mathcal{G}) \times \text{FNP}(\mathcal{G}')$ . Moreover, the underlying map of  $(\Lambda, \Lambda')$  is  $\sigma_{(\Lambda, \Lambda')} = \sigma_{\Lambda'} \circ \sigma_{\Lambda}$ .

We call this the *concatenation* of networks. (Beware: the operation is not symmetric on  $\mathcal{G}$  and  $\mathcal{G}'$ .)

*Proof.* The graph  $\mathcal{G} \cup \mathcal{G}'$  is acyclic, since it is the union of acyclic graphs by graph-theoretic sinks of one and graph-theoretic sources of another. That the new sets of sources and sinks are equinumerous is immediate.

A network path of the concatenation starts either in  $\Delta$  or in  $\Delta' \setminus \nabla$ . If it starts in  $\Delta' \setminus \nabla$ , then it must end in  $\mathcal{G}'$ , since it cannot cross back to  $\mathcal{G}$ . If it starts in  $\Delta$ , then it must visit a node of  $\nabla$ , since these separate  $\Delta$  from  $\nabla'$ . Hence every network path splits uniquely as a pair of network paths of  $\mathcal{G}$  and  $\mathcal{G}'$ .

Finally, the underlying map is the composition of the factors, by definition. ■

**Plane rooted directed trees.** Throughout this section, let  $T_* = (V \cup \{*\}, E_*)$  be a rooted (simple) tree with root  $*$  and let  $(V \cup \{*\}, A_*)$  be a rooted *directed* tree supported on  $T_*$ . We refer to this latter by  $A_*$  by abuse of notation. We assume  $\text{SG}(A_*) = T_*$ .

**Definition 7.5.** Let  $x \in V$  be a node with parent  $X \in V \cup \{*\}$  in  $T_*$ . We say that  $x$  is an *ascending child* of  $X$  if  $(x, X) \in A_*$ . Otherwise, we have  $(X, x) \in A_*$  and we say  $x$  is a *descending child*.

For  $X \in V \cup \{*\}$  let  $\text{Asc}(X)$  be the set of ascending children of  $X$  and let  $\text{Des}(X)$  be the set descending children. If  $x$  is a node with parent  $X$ , then the set of neighbors of  $x$  is  $\partial x = \text{Asc}(x) \cup \text{Des}(x) \cup \{X\}$ . We denote by  $T_X$  the subtree of  $T_*$  formed by  $X$  and all of its descendants, and define  $A_X$  similarly.

**Definition 7.6.** The *plane rooted directed tree structure on  $T_*$  induced by  $A_*$*  is the tuple

$$\left( A_*, (\prec_x)_{x \in V \cup \{*\}} \right)$$

where for each  $x \in V \cup \{*\}$  we have a total order  $\prec_x$  on the set of neighbors  $\partial x$  such that any ascending child precedes any descending child. That is, such that

- $y \prec_x z$  for each  $y \in \text{Asc}(x)$  and  $z \in \text{Des}(x)$ , and
- $y \prec_x X$  if  $X$  is the parent of  $x$ , for all  $y \in \text{Asc}(x) \cup \text{Des}(x)$ .

(Note that this second condition is void for the root  $x = *$ .) By abuse of notation, we denote this structure by  $T_*$ . See Figure 7(a) for an example.

Hereafter, we write  $(\partial x, \prec_x)$  for the totally ordered poset defined by the plane rooted directed tree structure on the set of neighbors  $\partial x$ , for  $x \in V \cup \{*\}$ .

**Hemisphere of a plane rooted directed tree.** A *hemisphere*  $\mathcal{H}(T_*)$  is a digraph constructed from a plane rooted tree  $T_*$ . There are three types of nodes in  $\mathcal{H}(T_*)$ : *v-nodes*, coming from the vertices of  $T_*$ ; *e-nodes*, coming from oriented edges supported on  $T_*$ , and *s-nodes*, that represent the oriented sectors of  $T_*$ . See Figure 7. Explicitly, the set of nodes of  $\mathcal{H}(T_*)$  consists of:

- (1) one *v-node*  $\Delta_i$  for each vertex  $i \in V$ .
- (2) two *e-nodes*  $e(i, j)$  and  $e(j, i)$  for every edge  $\{i, j\} \in E_*$ .
- (3) two sequences of *s-nodes*

$$s_i(j_1, j_2), s_i(j_2, j_3), \dots, s_i(j_{m-1}, j_m) \quad \text{and} \\ s_i(j_m, j_{m-1}), s_i(j_{m-1}, j_{m-2}), \dots, s_i(j_2, j_1)$$

for each vertex  $i \in V \cup \{*\}$ , where  $(\partial i, \prec_i) = (j_1 \prec_i j_2 \prec_i \dots \prec_i j_m)$  are the neighbors of  $i$ .

**Note 7.7.** The most attentive reader might have spotted that the definitions here presented and those of [BEGLR24c, BEGLR24b] vary slightly. In both cases, “vestigial” nodes are included in the definition, which have been removed here. For instance, the construction of [BEGLR24b] has a node  $\Delta_*$  that is *not* a source of the network. These play no role in the constructions, and thus the networks are interchangeable.

The arcs of  $\mathcal{H}(T_*)$  are better described in terms of local digraphs  $\Gamma(i)$ , one for each vertex  $i \in V \cup \{*\}$ . If the neighbors of  $i$  are  $(\partial i, \prec_i) = (j_1 \prec_i j_2 \prec_i \dots \prec_i j_m)$ , then refer to Figure 8 for an illustration of  $\Gamma(i)$ . In order to obtain  $\Gamma(*)$ , let  $i = *$  in Figure 8 and remove  $\Delta_*$ .

A key property of the local graphs is that the local digraphs  $\Gamma(i)$  and  $\Gamma(j)$  intersect if and only if  $i$  and  $j$  are neighbors in  $T_*$ . In this situation, the intersection uniquely consists of the pair of nodes  $e(i, j), e(j, i)$ .

**Proposition 7.8.** *The hemisphere is a network  $(\mathcal{H}(T_*), (\Delta_i)_{i \in V}, (e(a))_{a \in A_*})$ .*

*Proof.* Note that  $\#V = \#A_*$ . That  $\mathcal{H}(T_*)$  is acyclic is [BEGLR24c, Prop. 6.6]. ■

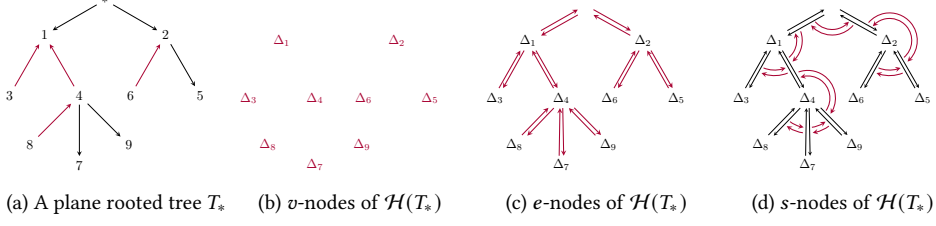
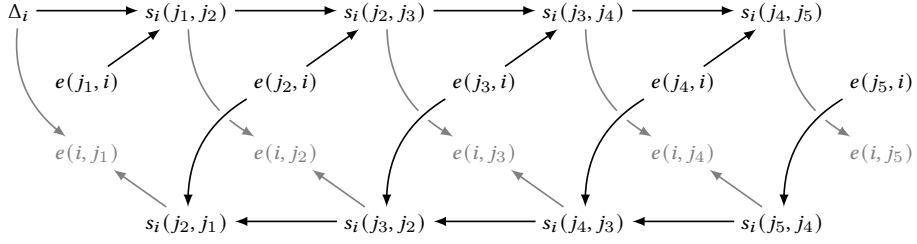
FIGURE 7. Nodes of  $\mathcal{H}(T_*)$ .FIGURE 8. Digraph  $\Gamma(i)$  for a vertex  $i \in V$  and with neighbors  $(\partial i, <_i) = (j_1 <_i j_2 <_i j_3 <_i j_4 <_i j_5)$ .

**The route map.** The route map  $\mathcal{R}$  of a plane rooted directed tree  $A_*$  is created from two hemispheres. The *Southern hemisphere* is  $\mathcal{S} := \mathcal{H}(T_*)$ .

Let  $A'_* = \{(j, i) : (i, j) \in A_*\}$  be the mirror of  $A_*$  and define the mirror local order  $<'_x$  by letting  $y <'_x z$  if and only if  $z <_x y$ , for each  $x \in V \cup \{*\}$ . Let  $T'_* = (A'_*, (<'_x)_{x \in V \cup \{*\}})$  be the plane rooted directed tree structure induced by  $A'_*$ , and let  $\mathcal{H}(T'_*)$  be its hemisphere. The *Northern hemisphere*  $\mathcal{N}$  is created from  $\mathcal{H}(T'_*)$  by reversing each arc in  $\mathcal{H}(T'_*)$  and relabeling each node  $x$  by  $\Psi(x)$ :

$$\Psi(\Delta_i) = \nabla_i, \Psi(e(i, j)) = e'(j, i), \Psi(s_i(u, v)) = s'_i(v, u).$$

We define a network  $\mathcal{B}$  whose vertex set is  $\{e(a) : a \in A_*\} \cup \{e'(a) : a \in A_*\}$ , and with  $n$  arcs  $(e(a), e'(a))$ , one for each  $a$  in  $A_*$ . We let  $e(a)$  be a source and  $e'(a)$  be a sink for each  $a \in A_*$ . The route map  $\mathcal{R}$  is defined as the concatenation

$$\mathcal{S} \# \mathcal{B} \# \mathcal{N}.$$

The arcs of  $\mathcal{B}$  are referred to as the *bridges between hemispheres* of  $\mathcal{R}$ . Note that there is a unique family of network paths in  $\mathcal{B}$ , and that its underlying map is  $\iota : e(a) \mapsto e'(a)$  for all  $a \in A_*$ .

**Corollary 7.9.** *The route map inherits a network structure  $(\mathcal{R}, (\Delta_i)_{i \in V}, (\nabla_i)_{i \in V})$ .*

A family of network paths  $\Lambda \in \text{FNP}(\mathcal{R})$  is called *full* if it visits every bridge between hemispheres. Note that if  $\Lambda$  is non-intersecting, it is in particular full.

**Proposition 7.10** ([BEGLR24c]). *Let  $T_* = (V \cup \{*\}, E_*)$  be a rooted tree with a plane directed rooted tree structure induced by a directed tree  $A_*$ . Let  $\mathcal{R}$  be the route map of  $A_*$ .*

- (1) Let  $i, j \in V$ , let  $a \in P(i, j) \subseteq A_*$ .
  - (a) There is a unique path from  $\Delta_i$  to  $e(a)$  in  $\mathcal{S}$ .
  - (b) There is a unique path from  $e'(a)$  to  $\nabla_j$  in  $\mathcal{N}$ .
  - (c) There is a unique path from  $\Delta_i$  to  $\nabla_j$  in  $\mathcal{R}$ .

Furthermore, every network path of  $\mathcal{R}$  arises this way.

- (2) The correspondence of (1) induces a bijection between the set  $C(A_*)$  of  $V$ -catalysts inducing  $A_*$  and the set of full families of network paths in  $\mathcal{R}$ .

*Proof.* We point at the precise results in [BEGLR24c] to guide the more interested reader. The first part follows from Lemma 6.5 as deduced in Proposition 6.6 and Corollary 6.7. The second part is Lemma 6.10. ■

**Local network structure.** The network structure of  $\mathcal{R}$  can also be constructed locally, by endowing each local graph  $\Gamma(i)$ ,  $i \in V \cup \{*\}$ , with a network structure.

**Definition 7.11.** Let  $x \in V$ , let  $\partial x = \text{Asc}(x) \cup \text{Des}(x) \cup \{X\}$ . Let  $\Gamma_{\mathcal{S}}(x)$  be the local graph of  $x$  in  $\mathcal{S}$ . Endow it with network structure by setting sources

$$\{\Delta_x\} \cup \{e(y, x) : y \text{ child of } x\}$$

and sinks

$$\{e(x, X)\} \cup \{e(a) : a \in A_* \text{ adjacent to } x, a \neq (X, x)\}.$$

Let  $\Gamma_{\mathcal{N}}(x)$  be the local graph of  $x$  in  $\mathcal{N}$ . Endow it with a network structure with sources

$$\{e'(X, x)\} \cup \{e'(a) : a \in A_* \text{ adjacent to } x\}.$$

and sinks

$$\{\nabla_x\} \cup \{e'(x, y) : y \text{ child of } x\}$$

We call these the *Southern (resp. Northern) local network of  $x$* .

It is apparent from Figure 8 that these are acyclic graphs. The sets of sources and sinks of the Southern and Northern local network have  $\delta(x)$  many nodes each.

The local graph around the root is slightly different. Let  $\Gamma_{\mathcal{S}}(*)$  be the local graph of  $*$  in  $\mathcal{S}$ . We endow it with a network structure with

- (1) a source  $e(y, *)$  for each  $y \in \partial*$ , and
- (2) a sink  $e(a)$  for each  $a \in A_*$  adjacent to  $*$ .

Let  $\Gamma_{\mathcal{N}}(*)$  be the local graph of  $*$  in  $\mathcal{N}$  and endow it with a network structure with

- (1) a sink  $e'(*, y)$  for each  $y \in \partial*$ , and
- (2) a source  $e'(a)$  for each  $a \in A_*$  adjacent to  $*$ .

We call these the *Southern (resp. Northern) local network of the root  $*$* .

Let  $\mathcal{B}(x)$  be the network with one source  $e(a)$  and one sink  $e'(a)$  for each arc  $a$  adjacent to  $x$  (except for  $a = (x, X)$ ), no other nodes, and arcs  $(e(a), e'(a))$ .

**Definition 7.12.** The *local network of  $x$*  is  $\Gamma_{\mathcal{R}}(x) := \Gamma_{\mathcal{S}}(x) \# \mathcal{B}(x) \# \Gamma_{\mathcal{N}}(x)$ .

See Figure 9. We spell out the network structure of the local network. Let  $x \in V$  be a vertex. Then  $\Gamma_{\mathcal{R}}(x)$  has sources  $\{\Delta_x\} \cup \{e(y, x) : y \text{ child of } x\} \cup \{e'(X, x)\}$  and sinks  $\{\nabla_x\} \cup \{e'(x, y) : y \text{ child of } x\} \cup \{e(x, X)\}$ .

Let  $x = *$  be the root. Then  $\Gamma_{\mathcal{R}}(*)$  has

- (1) a source  $e(y, *)$  for each child  $y$  of  $*$ , and
- (2) a sink  $e'(*, y)$  for each child  $y$  of  $*$ .

We now study non-intersecting families of network paths in  $\mathcal{R}$ . Recall that  $\mathcal{R} = \mathcal{S} \# \mathcal{B} \# \mathcal{N}$ . We will shortly refine this concatenation, to allow us to compute the underlying map of any family of network paths.

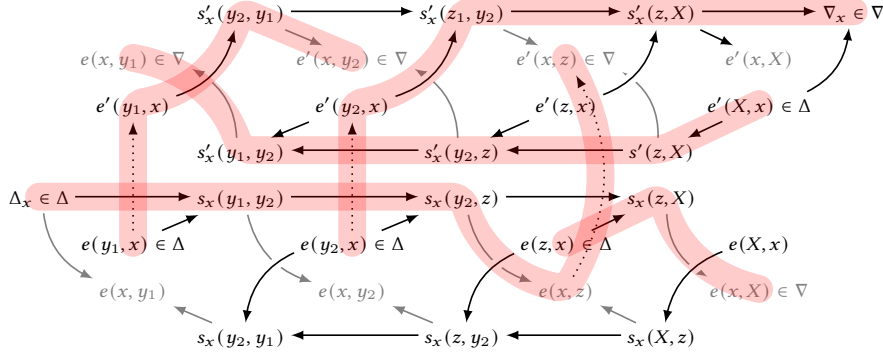

FIGURE 9. Non-intersecting family of network paths in  $\Gamma_{\mathcal{R}}(x)$  for a vertex  $x \in V$  with two ascending and one descending neighbors.

**Lemma 7.13.** *Let  $x \in V$  be a vertex with  $a = \# \text{Asc}(x)$  ascending children and  $d = \# \text{Des}(x)$  descending children. Let*

$$(\partial x, <_x) = (y_1 <_x \cdots <_x y_a <_x z_1 <_x \cdots <_x z_d <_x X).$$

*There is a unique non-intersecting family of network paths in  $\Gamma_{\mathcal{S}}(x)$  and its underlying map is the following:*

$$\sigma_x := \begin{array}{ccccccc} e(x, y_1) & \cdots & e(x, y_a) & e(x, z_1) & \cdots & e(x, z_d) & e(x, X) \\ \uparrow & & \uparrow & \nearrow & \nearrow & \nearrow & \nearrow \\ e(x, y_1) & \cdots & e(x, y_a) & \Delta_x & e(z_1, x) & \cdots & e(z_d, x) \end{array}$$

*Proof.* This is [BEGLR24c, Lemma 7.5] (uniqueness and map) and [BEGLR24c, Proposition 8.9] (existence). See the southern part of Figure 9 for an example. ■

**Lemma 7.14.** *Let  $x \in V$  be a vertex with  $a = \# \text{Asc}(x)$  ascending children and  $d = \# \text{Des}(x)$  descending children. Let*

$$(\partial x, <_x) = (y_1 <_x \cdots <_x y_a <_x z_1 <_x \cdots <_x z_d <_x X).$$

*There is a unique non-intersecting family of network paths in  $\Gamma_{\mathcal{N}}(x)$  and its underlying map is the following:*

$$\nu_x := \begin{array}{ccccccc} e'(x, y_1) & \cdots & e'(x, y_a) & \nabla_x & e'(x, z_1) & \cdots & e'(x, z_d) \\ \nearrow & \nearrow & \nearrow & \nearrow & \uparrow & \uparrow & \uparrow \\ e'(X, x) & e'(y_1, x) & \cdots & e'(y_a, x) & e'(x, z_1) & \cdots & e'(x, z_d) \end{array}$$

Let  $\iota_x$  be the underlying permutation of the unique family of network paths of  $\mathcal{B}(x)$ , which sends  $e(a) \mapsto e'(a)$  for each  $a$  adjacent to  $x$ . By Lemma 7.4, we conclude that there is a unique non-intersecting family of network paths in  $\Gamma_{\mathcal{R}}(x)$  and whose underlying permutation is  $\nu_x \circ \iota_x \circ \sigma_x$ . See Figure 9. Lemma 7.15 explains how to pass from the underlying permutation of families of network paths in the local networks to the underlying permutation of families of network paths in the route map. Let  $x \in V$  be a vertex with children

$$y_1 <_x \cdots <_x y_k.$$

If  $x$  is a leaf, let  $\bar{\sigma}_x = \sigma_x$  and  $\bar{\nu}_x = \nu_x$ ; otherwise define recursively

$$\bar{\sigma}_x := \sigma_x \circ \bar{\sigma}_{y_1} \circ \cdots \circ \bar{\sigma}_{y_k}, \quad \text{and} \quad \bar{\nu}_x := \bar{\nu}_{y_k} \circ \cdots \circ \bar{\nu}_{y_1} \circ \nu_x.$$

**Lemma 7.15.** *Let  $\Lambda \in \text{FNP}(\mathcal{R})$  be non-intersecting, and let  $\rho_*$  be the underlying map of the induced family of network paths in  $\Gamma_{\mathcal{R}}(*)$ . Then, the underlying map of  $\Lambda$  is*

$$\bar{\nu}_{j_k} \circ \cdots \circ \bar{\nu}_{j_1} \circ \rho_* \circ \bar{\sigma}_{j_1} \circ \cdots \circ \bar{\sigma}_{j_k},$$

where  $(\partial^*, <_*) = j_1 <_* \cdots <_* j_k$ .

*Proof.* Let  $x \in V$  be a vertex with parent  $X$ . Then  $\mathcal{G} = \Gamma_{\mathcal{S}}(x)$  and  $\mathcal{G}' = \Gamma_{\mathcal{S}}(X)$  are in the hypotheses of Lemma 7.4, and therefore we can concatenate them. Similarly, we can concatenate  $\Gamma_{\mathcal{N}}(X)$  and  $\Gamma_{\mathcal{N}}(x)$ . Hence, we can construct  $\mathcal{R}$  recursively as follows:

- (1) If  $x$  is a leaf, let  $\Sigma_{\mathcal{S}}(x) = \Gamma_{\mathcal{S}}(x)$  and  $\Sigma_{\mathcal{N}}(x) = \Gamma_{\mathcal{N}}(x)$ .
- (2) Otherwise, let

$$\begin{aligned} \Sigma_{\mathcal{S}}(x) &= \Sigma_{\mathcal{S}}(y_1) \# \cdots \# \Sigma_{\mathcal{S}}(y_k) \# \Gamma_{\mathcal{S}}(x) \quad \text{and} \\ \Sigma_{\mathcal{N}}(x) &= \Gamma_{\mathcal{N}}(x) \# \Sigma_{\mathcal{N}}(y_k) \# \cdots \# \Sigma_{\mathcal{N}}(y_1), \end{aligned}$$

where  $y_1, \dots, y_k$  are the children of  $x$ .

- (3) Let  $\mathcal{R} = \Sigma_{\mathcal{S}}(*) \# \mathcal{B} \# \Gamma_{\mathcal{N}}(*)$ .

(Note that  $\Sigma_{\mathcal{S}}(*) = \mathcal{S}$  and  $\Sigma_{\mathcal{N}}(*) = \mathcal{N}$ .) By applying Lemmas 7.4, 7.13, and 7.14, we conclude.  $\blacksquare$

**Example 7.16.** Conceptually, Lemma 7.4 allows us to take the concatenation of networks but only if “one is pointing into the other one”. Let  $T$  be a rooted tree with four nodes: the root  $*$ , a child  $x$ , and two grandchildren  $y, z$ . Choose an arrowflow and construct  $T_*$  and  $\mathcal{R}$  accordingly. The local networks interact as follows:

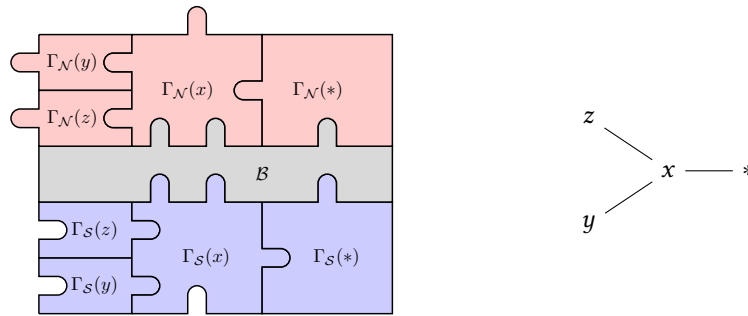

In the picture, a source is indicated with an indent and a sink with a tab. For instance,  $\Gamma_{\mathcal{S}}(x)$  has three sources  $e(y, x)$ ,  $e(z, x)$ , and  $\Delta_x$ . Concatenating in the following order

$$\Gamma_{\mathcal{S}}(z) \# \Gamma_{\mathcal{S}}(y) \# \Gamma_{\mathcal{S}}(x) \# \Gamma_{\mathcal{S}}(*) \# \mathcal{B} \# \Gamma_{\mathcal{N}}(*) \# \Gamma_{\mathcal{N}}(x) \# \Gamma_{\mathcal{N}}(y) \# \Gamma_{\mathcal{N}}(z)$$

ensures that at every step one is joining two networks with one “pointing into” the next one.

**Depth-First-Search walk.** Define the *marked Depth-First-Search walk* on  $T_*$  recursively by letting  $\text{DFS}(x)$  be the trivial walk  $(x)$  if  $x$  is a leaf, and for each  $x \in V$ , letting  $\text{DFS}(x)$  be given by

$$x \text{ DFS}(y_1) x \text{ DFS}(y_2) x \cdots x \text{ DFS}(y_a) (x) \text{ DFS}(z_1) x \cdots x \text{ DFS}(z_d) x,$$

where  $y_1, \dots, y_a$  are the ascending children of  $x$ , and  $z_1, \dots, z_d$  are the descending children. Finally,  $\text{DFS}(\ast)$  is defined similarly, but the root is not marked.

This is a walk of length  $2 \cdot \#(V \cup \{\ast\})$  on  $T_*$ . When convenient, we also consider it as indexed by the integers modulo  $2n$ ; in that case we refer to it as the *cyclic DFS walk*.

**Example 7.17.** In the plane rooted tree of Figure 7, the marked DFS walk on  $T_*$  started at the root is  $\ast \text{DFS}(1) \ast \text{DFS}(2) \ast$ . Expanding the walk recursively,

$$\text{DFS}(\ast) = \ast 1 \textcircled{3} 1 4 \textcircled{8} \textcircled{4} \textcircled{7} 4 \textcircled{9} 4 \textcircled{1} \ast 2 \textcircled{6} \textcircled{2} \textcircled{5} 2 \ast.$$

It is shown in [BEGLR24c] that the underlying permutation  $\bar{v}_x \circ \iota_x \circ \bar{\sigma}_x$  of the unique non-intersecting family of network paths of  $\Gamma_{\mathcal{R}}(x)$  is the cycle given by the marks of the marked DFS walk for every  $x \in V$ . Moreover, if  $\# \text{Asc}(\ast) = 0$  and  $\# \text{Des}(\ast) = 2$  then this also holds for the root, as we will later see. In the example above, the permutation is  $(3 \ 8 \ 4 \ 7 \ 9 \ 1 \ 6 \ 2 \ 5)$ . For now, the precise statement that we need is the following, and it is shown by a careful inspection of Lemmas 7.13 and 7.14.

**Lemma 7.18.** *Let  $x \in V$  with parent  $X$ . If the subsequence of marked nodes of the marked DFS walk  $\text{DFS}(x)$  is  $w_1 w_2 \cdots w_k$ , then  $\bar{v}_x \circ \bar{\sigma}_x$  is the following:*

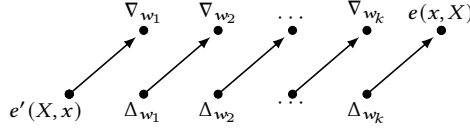

**Lemma 7.19 (Lemma 8.7 in [BEGLR24c]).** *In the cyclic DFS walk, marked nodes and arcs in  $A_*$  are interlaced. That is, if  $\text{DFS}(\ast) = w_1 w_2 \cdots w_k$  and  $w_u$  and  $w_v$  are two marked nodes, consecutive in  $\text{DFS}(\ast)$ , then there is a unique step in the subwalk  $w_u w_{u+1} \cdots w_v$  that is an arc of  $A_*$ . Furthermore, every step in  $w_u w_{u+1} \cdots w_v$  before this one points from child to parent, and every step after this one points parent to child.*

**The local network of the root.** When  $\# \text{Asc}(\ast) = 0$  and  $\# \text{Des}(\ast) = 2$ , then  $\Gamma_{\mathcal{R}}(\ast)$  admits a unique non-intersecting path, [BEGLR24c, Lemma 7.6]. Recall that when talking about the network structure of the route map, one can identify the underlying map with a permutation in  $\mathbb{S}_V$ .

**Proposition 7.20.** *Let  $T_*$  be a tree with a plane rooted tree structure induced by an arrowflow  $A_*$ . If  $\# \text{Asc}(\ast) = 0$  and  $\# \text{Des}(\ast) = 2$ , then there exists a unique non-intersecting family of network paths in  $\mathcal{R}$ . Furthermore, its underlying permutation is the cycle of  $\mathbb{S}_V$  produced by the markings of the marked DFS walk on  $T_*$ .*

*Proof.* This is Proposition 8.10 and Lemma 8.11 in [BEGLR24c].  $\blacksquare$

When the assumption  $\# \text{Asc}(\ast) = 0$  and  $\# \text{Des}(\ast) = 2$  is dropped, the analysis is slightly more complicated, but of remarkable elegance. A crucial step in



the analysis is the first path-enumerative proof of the following result, given in [BEGLR24a]. For another bijective proof, see [Cha01].

**Theorem 7.21.** *The signed enumeration of derangements is*

$$\sum_{\substack{\sigma \in \mathbb{S}_n \\ \text{derangement}}} \text{sgn}(\sigma) = (-1)^{n-1}(n-1).$$

The enumeration of derangements is reduced to a path enumeration problem on the following network.

**Definition 7.22.** Fix an integer  $n \geq 2$ . Let  $\mathcal{D}_n$  be a directed graph with

- two nodes  $\Delta_i$  and  $\nabla_i$  for each  $1 \leq i \leq n$ , and
- two nodes  $s(i, i+1)$  and  $s(i+1, i)$  for each  $1 \leq i < n$ , and

We refer to the nodes as *sources*, *sinks*, and *steps*, respectively. The arc-set has

- arcs  $(\Delta_i, s(i, i+1))$  and  $(\Delta_{i+1}, s(i+1, i))$  for each  $1 \leq i < n$ ,
- arcs  $(s(i+1, i), \nabla_i)$  and  $(s(i, i+1), \Delta_{i+1})$  for each  $1 \leq i < n$ , and
- arcs  $(s(i, i+1), s(i+1, i+2))$  and  $(s(i+2, i+1), s(i+1, i))$  for each  $1 \leq i \leq n-2$ .

The *derangement network* of  $\mathbb{S}_n$  is the network  $(\mathcal{D}_n, (\Delta_i)_{i \in [n]}, (\nabla_i)_{i \in [n]})$ . See Figure 10.

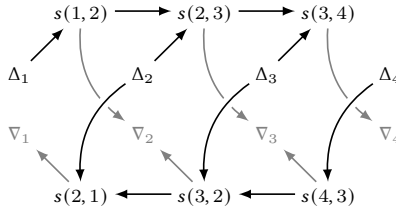

FIGURE 10. The derangement network of  $\mathbb{S}_4$ .

In plain words, the derangement network has two paths, one recording “increasing steps” and one recording “decreasing steps”. A network path starts in a source corresponding to a number  $i \in [n]$  and decides whether to increase or decrease. It follows one of the two paths accordingly and exits at a sink, corresponding to another number  $j \in [n]$ . In a family of network paths, “increasing steps” are visited by the path corresponding to *excedances*  $i < \sigma(i)$  of the underlying permutation  $\sigma$  of the family, and “decreasing steps” by the *anti-excedances*.

**Lemma 7.23.** *For each derangement  $\sigma \in \mathbb{S}_n$ , there is a unique family of network paths  $\Lambda_\sigma$  in  $\mathcal{D}_n$  with underlying permutation  $\sigma$ . This is furthermore a bijection between  $\text{FNP}(\mathcal{D}_n)$  and the set of derangements of  $\mathbb{S}_n$ .*

*Proof.* See [BEGLR24a]. ■

It turns out that derangement networks play an important role in our study of the minors of the distance matrix of  $T$ . The relationship is as follows:

**Proposition 7.24.** *Fix a composite  $m$ -arrowflow  $A$ . Let  $\mathcal{R}$  be the corresponding route map of  $A/\sim$ . Let  $a = \# \text{Asc}(\ast)$ , let  $d = \# \text{Des}(\ast)$ , and consider the local network  $\Gamma_{\mathcal{R}}(\ast)$ . There is a graph endomorphism from  $\mathcal{D}_a \times \mathcal{D}_d$  to  $\Gamma_{\mathcal{R}}(\ast)$  inducing a bijection between the sets of non-intersecting families of network paths.*

*Proof.* The first thing to notice is that every network path of the family has to start at the Southern local network and end at the Northern local network, so it has to travel through a bridge between hemispheres. There are as many bridges as paths, so in order for a family to not be intersecting, each path should take a different bridge. If  $j \in \text{Asc}(\ast)$  is an ascending child of the root, then  $e(j, \ast)$  is both a source and the start of a bridge; in a non-intersecting family of paths, the path  $\Lambda_j$  starting at  $e(j, \ast)$  must also be the unique path taking the bridge  $(e(j, \ast), e'(j, \ast))$ . Note that when  $\#\text{Asc}(\ast) = 1$ , this path cannot end in any sink; there exists no non-intersecting family in this case. Similarly, if  $j \in \text{Des}(\ast)$ , then the path ending at  $e'(\ast, j)$  must also be the unique path taking the bridge  $(e(\ast, j), e'(\ast, j))$ ; and if  $\#\text{Des}(\ast) = 1$  there exists no non-intersecting family.

Altogether, we have shown that for a family  $\Lambda \in \text{FNP}(\Gamma_{\mathcal{R}}(\ast))$  to be non-intersecting, it has to split into two non-intersecting families of network paths in the networks

$$\begin{aligned} \Gamma^{\text{Asc}}(\ast) &:= \left( \Gamma_{\mathcal{N}}(\ast), (e'(j, \ast))_{j \in \text{Asc}(\ast)}, (e'(\ast, j))_{j \in \text{Asc}(\ast)} \right), \text{ and} \\ \Gamma^{\text{Des}}(\ast) &:= \left( \Gamma_{\mathcal{S}}(\ast), (e(j, \ast))_{j \in \text{Des}(\ast)}, (e(\ast, j))_{j \in \text{Des}(\ast)} \right). \end{aligned}$$

Finally, consider the map

$$\begin{aligned} \mathcal{D}_{\text{Asc}(\ast)} &\rightarrow \Gamma^{\text{Asc}}(\ast) \\ \Delta_i &\mapsto e'(i, \ast) \\ \nabla_i &\mapsto e'(\ast, i) \\ s(i, i+1) &\mapsto s_*(i, i+1). \end{aligned}$$

This is an endomorphism of digraphs when  $\#\text{Asc}(\ast) \geq 2$ , and by the above, the map induces a bijection between the sets of non-intersecting paths of the networks. Similarly, there is an endomorphism  $\mathcal{D}_{\text{Des}(\ast)} \rightarrow \Gamma^{\text{Des}}(\ast)$  whenever  $\#\text{Des}(\ast) \geq 2$  and the analogous property holds. ■

## 8. UNITAL ARROWFLOWS

This section is dedicated to the proof of Proposition 4.2. Let  $A$  be a unital arrowflow. We have

$$\epsilon(\text{SG}(A)) = (n-1) - \epsilon(\text{SG}(A)^c) = cc(\text{SG}(A)^c) - 1 = m-1$$

and  $\epsilon(A) = m$ . Therefore, there is exactly one edge  $\{u, v\}$  of  $\text{SG}(A)$  in which there are two arcs of  $A$  are supported. Since  $A$  has no parallel arrows, these two arcs must be  $(u, v)$  and  $(v, u)$ ; we call them *anti-parallel arrows*.

**Lemma 8.1.** *Fix  $F \in \mathcal{F}_1(T; S)$  an  $S$ -rooted forest of  $T$ . We have*

$$\#\{A \text{ unital}, \text{SG}(A)^c = F\} = (m-1)2^{m-2}.$$

*Proof.* We have  $\text{SG}(A) = F^c$  and thus  $\epsilon(\text{SG}(A)) = m-1$ . The factor  $(m-1)$  counts the number of ways of choosing the edge of  $\text{SG}(A)$  in which the anti-parallel arrows are supported. For each of the  $m-2$  remaining edges, there are two possible orientations. ■

Recall that the quotient arrowflow  $A/\sim$  is a *complete* unital  $m$ -arrowflow on  $T/\sim = (S, E/\sim)$ . Let  $\{u, v\}$  be the edge of  $T/\sim$  in which the anti-parallel arrows are supported. We construct a rooted tree  $(T/\sim)_*$  from  $T/\sim$  by subdividing  $\{u, v\}$ ,

and calling the newly introduced vertex  $*$ . Similarly, we construct a complete  $m$ -arrowflow  $(A/\sim)_*$  on  $(T/\sim)_*$  with arc-set

$$\{(i, j) \in A/\sim : \{i, j\} \neq \{u, v\}\} \cup \{(*, u), (*, v)\}.$$

**Lemma 8.2.** *If  $A$  is unital, then*

$$\sum_{\kappa \in C_S(A)} \text{sgn}(\kappa) = (-1)^{m-1}.$$

*Proof.* By Lemma 6.5, we have

$$\sum_{\kappa \in C_S(A)} \text{sgn}(\kappa) = \sum_{\kappa \in C_S(A/\sim)} \text{sgn}(\kappa)$$

The quotient  $A/\sim$  is a *complete* unital  $m$ -arrowflow on  $T/\sim$ . We follow [BEGLR24c] to conclude: let  $\mathcal{R}$  be the route map of the rooted directed tree  $(A/\sim)_*$ . By Proposition 7.10(2) and the LGV lemma, we have

$$\sum_{\kappa \in C_S(A/\sim)} \text{sgn}(\kappa) = \sum_{\substack{\Lambda \in \text{FNP}(\mathcal{R}) \\ \text{full}}} \text{sgn}(\Lambda) = \sum_{\substack{\Lambda \in \text{FNP}(\mathcal{R}) \\ \text{non-intersecting}}} \text{sgn}(\Lambda).$$

By Proposition 7.20, there exists a unique non-intersecting family  $\bar{\Lambda}$  of network paths of  $\mathcal{R}$ , and its sign is  $(-1)^{m-1}$ . We conclude

$$\sum_{\kappa \in C_S(A)} \text{sgn}(\kappa) = \sum_{\substack{\Lambda \in \text{FNP}(\mathcal{R}) \\ \text{non-intersecting}}} \text{sgn}(\Lambda) = \text{sgn}(\bar{\Lambda}) = (-1)^{m-1}. \quad \blacksquare$$

We emphasize that the arguments used in [BEGLR24c] are involutive. In particular, our proof of Lemma 8.2 is also involutive.

## 9. COMPOSITE ARROWFLOWS

Fix  $F$  an  $(S, *)$ -rooted spanning forest of  $T$ . This section is devoted to the proof of Proposition 4.3, namely,

$$\sum_{\substack{A \\ \text{composite} \\ \text{SG}(A)^c = F}} \sum_{\kappa \in C_S(A)} \text{sgn}(\kappa) = (-1)^{m-1} 2^{m-2} (\delta(F_*) - 1) (\delta(F_*) - 4).$$

Recall that the vertex set  $I$  of  $T/\sim$  is  $S \sqcup \{*\}$ , where  $*$  denotes the quotient projection of the floating component of  $\text{SG}(A)^c$ . We endow  $T/\sim$  with a structure of rooted tree by letting  $*$  be the root. We then note that  $A/\sim$  is a rooted directed tree supported on  $T/\sim$ . Endow  $T/\sim$  with a plane directed tree structure induced by  $A/\sim$ . We let  $\mathcal{R}$  denote the *route map* of  $A/\sim$ .

We will shortly compute a formula for the signed enumeration of the catalysts in a composite arrowflow class. This proof will follow the structure of the analogous result for unital arrowflows.

**Proposition 9.1.** *Fix a composite  $m$ -arrowflow  $A$ . Let  $\mathcal{R}$  be the corresponding route map of  $A/\sim$ . Let  $a = \# \text{Asc}(*)$ , let  $d = \# \text{Des}(*)$ , and consider the local network  $\Gamma_{\mathcal{R}}(*)$ . There exists exactly one family of network paths of  $\Gamma_{\mathcal{R}}(*)$  with underlying*

permutation  $\tau$  for each derangement  $\tau \in \mathbb{S}_d \times \mathbb{S}_a$ . Every other family is intersecting. Consequently, in absolute value, we have

$$\left| \sum_{\Lambda \in \text{FNP}(\Gamma_{\mathcal{R}}(*))} \text{sgn}(\Lambda) \right| = \begin{cases} a-1 & \text{if } d=0, \\ d-1 & \text{if } a=0, \\ (a-1)(d-1) & \text{otherwise.} \end{cases}$$

*Proof.* By an application of the LGV lemma and Proposition 7.24, we have

$$\begin{aligned} \sum_{\Lambda \in \text{FNP}(\Gamma_{\mathcal{R}}(*))} \text{sgn}(\Lambda) &= \sum_{\substack{\Lambda \in \text{FNP}(\Gamma_{\mathcal{R}}(*)) \\ \text{non-intersecting}}} \text{sgn}(\Lambda) \\ &= \left( \sum_{\substack{\Lambda \in \text{FNP}(\mathcal{D}_a) \\ \text{non-intersecting}}} \text{sgn}(\Lambda) \right) \left( \sum_{\substack{\Lambda \in \text{FNP}(\mathcal{D}_d) \\ \text{non-intersecting}}} \text{sgn}(\Lambda) \right) \end{aligned}$$

Lemma 7.23 and Theorem 7.21 then give the desired formula.  $\blacksquare$

**Corollary 9.2.** Fix a composite  $m$ -arrowflow  $A$  and let  $\mathcal{R}$  be the corresponding route map of  $A/\sim$ . Let  $a = \# \text{Asc}(*)$ ,  $d = \# \text{Des}(*)$ , and

$$(\partial x, <_x) = (y_1 <_x \cdots <_x y_{a+d} <_x X).$$

There exists exactly one non-intersecting family of network paths in  $\mathcal{R}$  with underlying permutation

$$\bar{v}_{y_{a+d}} \circ \cdots \circ \bar{v}_{y_1} \circ \tau \circ \bar{\sigma}_{y_1} \circ \cdots \circ \bar{\sigma}_{y_{a+d}}$$

for each derangement  $\tau \in \mathbb{S}_d \times \mathbb{S}_a$ , where each other factor is unique and defined as in Lemma 7.15. This is furthermore an exhaustive enumeration of non-intersecting families of  $\text{FNP}(\mathcal{R})$ .

*Proof.* Existence is guaranteed by Lemma 7.23, Proposition 7.24 and Lemma 7.15, which also imply the list is exhaustive.  $\blacksquare$

**Corollary 9.3.** Fix a composite  $m$ -arrowflow  $A$  and let  $\mathcal{R}$  be the corresponding route map of  $A/\sim$ . Let  $a = \# \text{Asc}(*)$ ,  $d = \# \text{Des}(*)$ . Then,

$$\sum_{\substack{\Lambda \in \text{FNP}(\mathcal{R}) \\ \text{non-intersecting}}} \text{sgn}(\Lambda) = (-1)^{m-1} (a-1)(d-1).$$

*Proof.* Consider

$$\begin{aligned} \sum_{\substack{\Lambda \in \text{FNP}(\mathcal{R}) \\ \text{non-intersecting}}} \text{sgn}(\Lambda) &= \sum_{\substack{\Lambda \in \text{FNP}(\mathcal{R}) \\ \text{non-intersecting}}} \text{sgn}(\bar{v}_{y_{a+d}} \circ \cdots \circ \bar{v}_{y_1} \circ \rho_* \circ \bar{\sigma}_{y_1} \circ \cdots \circ \bar{\sigma}_{y_{a+d}}) \\ &= \sum_{\substack{\Lambda \in \text{FNP}(\Gamma_{\mathcal{R}}(*)) \\ \text{non-intersecting}}} \text{sgn}(\bar{v}_{y_{a+d}} \circ \cdots \circ \bar{v}_{y_1} \circ \tau \circ \bar{\sigma}_{y_1} \circ \cdots \circ \bar{\sigma}_{y_{a+d}}), \end{aligned}$$

where  $\tau$  is the derangement corresponding to  $\Lambda$  after Lemma 7.23 and Proposition 7.24, and the remaining maps  $\bar{v}_{y_{a+d}}, \dots, \bar{\sigma}_{y_{a+d}}$  are independent of said  $\Lambda$  by Lemma 7.15. The whole composite is a permutation of  $S$ , and  $\tau$  is a permutation of  $\partial*$ . Moreover,  $\tau$  is a permutation of  $\mathbb{S}_a \times \mathbb{S}_d$ ; we write  $\tau = \tau_{\text{Asc}} \tau_{\text{Des}}$ .

Let  $y_1, \dots, y_a$  be the ascending children of  $*$  and denote by  $z_1, \dots, z_d$  the descending children. Let  $X = \bigcup_{y \in \text{Asc}(*)} V(T_y)$  be the set formed by the ascending children

of the root, and their children, grandchildren, etc. Let  $Y = \bigcup_{z \in \text{Des}(\ast)} V(T_z)$  be defined similarly. Then, we can find  $\alpha_1, \alpha_2 \in \mathbb{S}_X$  and  $\beta_1, \beta_2 \in \mathbb{S}_Y$  such that the composite above can be written as a product  $\alpha_2 \tau'_{\text{Asc}} \alpha_1 \beta_2 \tau'_{\text{Des}} \beta_1$  of permutations, where  $\tau'_{\text{Asc}}$  is the permutation of  $\mathbb{S}_S$  that agrees with  $\alpha_2 \tau_{\text{Asc}} \alpha_1^{-1}$  in  $\text{Asc}(\ast)$  and is the identity elsewhere, and  $\tau'_{\text{Des}}$  is defined similarly.

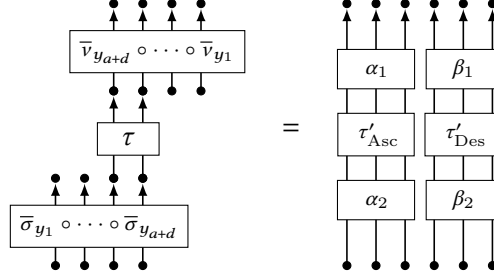

Then,  $\text{sgn}(\alpha_2 \tau'_{\text{Asc}} \alpha_1 \beta_2 \tau'_{\text{Des}} \beta_1) = \text{sgn}(\alpha_2 \alpha_1 \beta_2 \beta_1) \text{sgn}(\tau)$  and the sum simplifies to

$$\begin{aligned} \sum_{\substack{\Lambda \in \text{FNP}(\mathcal{R}) \\ \text{non-intersecting}}} \text{sgn}(\Lambda) &= \sum_{\substack{\Lambda \in \text{FNP}(\Gamma_{\mathcal{R}}(\ast)) \\ \text{non-intersecting}}} \text{sgn}(\alpha_2 \tau'_{\text{Asc}} \alpha_1 \beta_2 \tau'_{\text{Des}} \beta_1) \\ &= \text{sgn}(\alpha_2 \alpha_1 \beta_2 \beta_1) \sum_{\substack{\Lambda \in \text{FNP}(\Gamma_{\mathcal{R}}(\ast)) \\ \text{non-intersecting}}} \text{sgn}(\tau) \\ &= \text{sgn}(\alpha_2 \alpha_1 \beta_2 \beta_1) (-1)^{\delta_{a \neq 0}} (-1)^{\delta_{d \neq 0}} (a-1)(d-1). \end{aligned}$$

To compute  $\text{sgn}(\alpha_2 \alpha_1 \beta_2 \beta_1) (-1)^{\delta_{a \neq 0}} (-1)^{\delta_{d \neq 0}}$ , we argue as follows. We first assume  $a > 0$ . Let  $\tau'_{\text{Asc}}$  be the cycle  $(y_1 y_2 \dots y_a)$ . For each  $y \in \text{Asc}(\ast)$ , by Lemma 7.18, the underlying map of the unique non-intersecting family of network paths of  $\Sigma_S(y) \ast \mathcal{B}(y) \ast \Sigma_N(y)$  is given by the DFS walk on  $T_\ast$  and of this form:

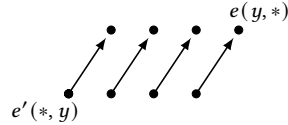

By letting  $\tau'_{\text{Asc}}$  be the cycle  $(y_1 y_2 \dots y_a)$ , the marked Depth-First-Search walk around  $\bigcup_{y \in \text{Asc}(\ast)} T_y$  gives the map  $\alpha_2 \tau'_{\text{Asc}} \alpha_1$ . But the Depth-First-Search always gives a cycle. Hence,

$$\text{sgn}(\alpha_2 \tau'_{\text{Asc}} \alpha_1) = (-1)^{\#X-1} = \text{sgn}(\alpha_2 \alpha_1) \text{sgn}(\tau'_{\text{Asc}})$$

and  $\text{sgn}(\tau'_{\text{Asc}}) = (-1)^{a-1}$ . Similarly, if  $d > 0$ , then

$$\text{sgn}(\beta_2 \tau'_{\text{Des}} \beta_1) = (-1)^{\#Y-1} = \text{sgn}(\beta_2 \beta_1) \text{sgn}(\tau'_{\text{Des}})$$

and  $\text{sgn}(\tau'_{\text{Des}}) = (-1)^{d-1}$ . Altogether, if  $a > 0$  and  $d > 0$ , we have

$$\text{sgn}(\alpha_2 \tau'_{\text{Asc}} \alpha_1 \beta_2 \tau'_{\text{Des}} \beta_1) = (-1)^{\#X+\#Y} = (-1)^m = \text{sgn}(\alpha_2 \alpha_1 \beta_2 \beta_1) \text{sgn}(\tau')$$

and  $\text{sgn}(\tau') = (-1)^{a+d} = (-1)^{\delta(\ast)}$ . And therefore  $\text{sgn}(\alpha_2 \alpha_1 \beta_2 \beta_1) = (-1)^m$ .

If  $a = 0$ , then  $\text{sgn}(\alpha_2 \alpha_1 \beta_2 \beta_1) = \text{sgn}(\beta_2 \beta_1) = (-1)^{m-1}$ . Similarly if  $d = 0$ . In any case,

$$\text{sgn}(\alpha_2 \alpha_1 \beta_2 \beta_1) (-1)^{\delta_{a \neq 0}} (-1)^{\delta_{d \neq 0}} = (-1)^m. \quad \blacksquare$$

In order for our proof of Theorem A to be completely involutive, we give a bijective proof of the following binomial identity.

**Lemma 9.4.** For  $n \geq 0$ ,

$$\sum_{k=0}^n \binom{n}{k} (k-1)(n-k-1) = 2^{n-2}n(n-1) - 2^n(n-1).$$

*Proof.* We begin by noting that the summands corresponding to  $k = 1$  and  $k = n-1$  vanish, while the summands corresponding to  $k = 0$  and  $k = n$  are negative and contribute to the sum with

$$\binom{n}{0}(-1)(n-1) + \binom{n}{n}(n-1)(-1) = -2(n-1).$$

We are looking for a bijective proof, so this term is passed to the other side of the equality as preparation. We want to show

$$\sum_{k=2}^{n-2} \binom{n}{k} (k-1)(n-k-1) = 2^{n-2}n(n-1) - \left(2^n(n-1) - 2(n-1)\right). \quad (2)$$

Consider the set  $R$  of sequences of black and white beads and of length  $n$ , in which exactly one black bead and one white bead are distinguished. For instance, for  $n = 9$  then  $\circ\circ\circ\hat{\circ}\circ\circ\hat{\circ}\bullet$  is in  $R$ , and also  $\bullet\bullet\hat{\circ}\circ\bullet\circ\bullet\hat{\circ}$ . The cardinality of this set can be computed as follows: start with a sequence of  $n$  beads and choose two entries of the sequence to be distinguished, which you can do in  $\binom{n}{2}$  ways; then color all of the beads either black or white except the left-most of the distinguished beads, which you can do in  $2^{n-1}$  ways; finally, color the remaining bead such that both distinguished beads have different colors. Altogether,

$$\#R = 2^{n-1} \binom{n}{2} = 2^{n-2}n(n-1).$$

Now, consider the subset  $L$  of  $R$  for which the distinguished black bead is *not* the left-most black bead, and the distinguished white bead is *not* the left-most white bead. The first of the two examples above is in  $L$ , whereas the second is not, since  $\hat{\circ}$  is the left-most white bead. The set  $L$  is counted as follows: start with a sequence of  $n$  white beads, and choose a number  $k \in \{2, \dots, n-2\}$ ; then select  $\binom{n}{k}$  entries that will be colored black. Subsequently, choose a black bead to be distinguished (but not the left-most one), which you can do in  $(k-1)$  ways; finally, select a white bead to be distinguished (but not the left-most one), which you can do in  $(n-k-1)$  ways. Hence

$$\#L = \sum_{k=2}^{n-2} \binom{n}{k} (k-1)(n-k-1).$$

To conclude, we compute the cardinality of  $R \setminus L$ , which reinterprets Equation (2) as  $\#L = \#R - \#(R \setminus L)$ . A sequence is in  $R \setminus L$  if  $\bullet$  is the left-most black bead, or if  $\hat{\circ}$  is the left-most white bead, or both. This set is counted as follows: start by coloring a sequence of  $n$  beads, which you can do in  $2^n$  ways. Discard the coloring if all beads are black or all are white —this sequence can't be in  $R$ —; there are  $2^n - 2$  possible colorings. You will now have  $k$  black and  $n-k$  white beads, for some  $k$ . If  $0 < k < n$ , distinguish the first black bead and any white bead, which you can do in  $n-k$  ways, or the first white bead and any black bead except the left-most one, which you can do in  $k-1$  ways. Hence there are always

$n - 1$  ways of distinguishing two beads. Altogether,

$$\#(R \setminus L) = (2^n - 2)(n - 1),$$

and Equation (2) becomes  $\#L = \#R - \#(R \setminus L)$ .  $\blacksquare$

*Proof of Proposition 4.3.* Fix a forest  $F \in \mathcal{F}_S^*(T)$ . Proposition 7.10 gives

$$\sum_{\substack{A \\ \text{composite} \\ \text{SG}(A)^c=F}} \sum_{\kappa \in C_S(A)} \text{sgn}(\kappa) = \sum_{\substack{A \\ \text{composite} \\ \text{SG}(A)^c=F}} \sum_{\substack{\Lambda \in \text{FNP}(\mathcal{R}) \\ \text{non-intersecting}}} \text{sgn}(\Lambda),$$

where the route map  $\mathcal{R}$  of the second sum is constructed with respect to the arrowflow  $A$ . Then, Corollary 9.3 gives

$$\sum_{\substack{A \\ \text{composite} \\ \text{SG}(A)^c=F}} \sum_{\substack{\Lambda \in \text{FNP}(\mathcal{R}) \\ \text{non-intersecting}}} \text{sgn}(\Lambda) = \sum_{\substack{A \\ \text{composite} \\ \text{SG}(A)^c=F}} (-1)^m (\# \text{Asc}(\ast) - 1) (\# \text{Des}(\ast) - 1),$$

where again  $\text{Asc}(\ast)$  and  $\text{Des}(\ast)$  are taken with respect to the arrowflow  $A$ . Let  $F_*$  be the floating component of  $F$ . If  $A$  is a composite arrowflow with missing forest  $F$ , then  $F_*$  becomes  $\ast$  in the quotient  $A/\sim$ . Thus a composite arrowflow with missing forest  $F$  is constructed by choosing  $a$  vertices among  $\partial F_*$  to become ascending children of the root, which also determines the remaining  $\delta(F_*) - a$  as descending children of the root; the other  $m - \delta(F_*)$  edges of  $F^c$  can be oriented arbitrarily. Hence, the sum above becomes

$$(-1)^m \sum_{a=0}^{\delta(F_*)} \binom{\delta(F_*)}{a} (a - 1) (\delta(F_*) - a - 1) \cdot 2^{m - \delta(F_*)}.$$

Now, Lemma 9.4 gives

$$(-1)^m \cdot 2^{\delta(F_*) - 2} (\delta(F_*) - 1) (\delta(F_*) - 4) \cdot 2^{m - \delta(F_*)}. \quad \blacksquare$$

## 10. A THEOREM OF RICHMAN, SHOKRIEH, AND WU

In this section, we derive [RSW24, Thm. 1.1] from Theorem A. We begin by stating the theorem.

**Theorem 10.1** ([RSW24]). *Let  $T = ([n], E)$  be a tree, and let  $S \subseteq [n]$  be a subset of cardinality  $m \geq 2$ . Then,*

$$\det D[S] = (-1)^{m-1} 2^{m-2} \left( (n-1) \# \mathcal{F}_S(T) - \sum_{F \in \mathcal{F}_S^*(T)} (\delta(F_*) - 2)^2 \right).$$

We give the first combinatorial proof. Before, we give two preliminary results. The first one is [RSW24, Rk. 2.5].

**Lemma 10.2.** *Fix an edge  $e \in T$  and a spanning forest  $F$  of  $T$ .*

- (a) *If  $F$  is  $S$ -rooted and  $e \in F$ , then  $F \setminus \{e\}$  is  $(S, \ast)$ -rooted and  $e$  is adjacent to the floating component of  $F \setminus \{e\}$ .*
- (b) *If  $F$  is  $(S, \ast)$ -rooted and  $e$  is adjacent to  $F_*$ , then  $F \cup \{e\}$  is  $S$ -rooted.*

*Proof.* Removing an edge from a tree results in two connected components; removing an edge  $e$  from an  $S$ -rooted forest results in a forest with  $m + 1$  connected components. Furthermore, each component has a node of  $S$  except one of the two that was adjacent to  $e$ . This latter becomes the floating component of the  $(S, *)$ -rooted forest  $F \setminus \{e\}$ . Note that  $e$  is adjacent to the floating component, as claimed. This shows part (a). Part (b) is immediate from the definitions. ■

**Lemma 10.3.** *Let  $T = ([n], E)$  be a tree, let  $S$  be an  $m$ -subset of  $[n]$ . Then,*

$$(n - m) \cdot \#\mathcal{F}_S(T) = \sum_{F \in \mathcal{F}_S^*(T)} \delta(F_*).$$

*Proof.* Consider the sets

$$\begin{aligned} A &:= \{(F, e) : F \in \mathcal{F}_S(T), e \in F\} \subseteq \mathcal{F}_S(T) \times E, \\ B &:= \{(F, e) : F \in \mathcal{F}_S^*(T), e \text{ adjacent to } F_*\} \subseteq \mathcal{F}_S^*(T) \times E. \end{aligned}$$

Note that  $\#A = (n - m)\#\mathcal{F}_S(T)$  and  $\#B = \sum_{F \in \mathcal{F}_S^*(T)} \delta(F_*)$ . It is thus sufficient to exhibit a bijection between  $A$  and  $B$ . Consider the map  $h : A \rightarrow B$  defined by

$$h(F, e) = (F \setminus \{e\}, e), \quad (F, e) \in A.$$

This map is bijective: the inverse of  $h$  exists and is given by

$$h^{-1}(F, e) = (F \cup \{e\}, e), \quad (F, e) \in B.$$

Note that both  $h$  and  $h^{-1}$  are well-defined by Lemma 10.2. ■

*Proof of Theorem 10.1.* By Theorem A,

$$\frac{\det D[S]}{(-1)^{m-1}2^{m-2}} = (m - 1)\#\mathcal{F}_S(T) - \sum_{F \in \mathcal{F}_S^*(T)} (\delta(F_*) - 1)(\delta(F_*) - 4).$$

Lemma 10.3 then yields

$$\begin{aligned} \frac{\det D[S]}{(-1)^{m-1}2^{m-2}} &= \frac{\det D[S]}{(-1)^{m-1}2^{m-2}} + (n - m)\#\mathcal{F}_S(T) - \sum_{F \in \mathcal{F}_S^*(T)} \delta(F_*) \\ &= (m - 1 + n - m)\#\mathcal{F}_S(T) - \sum_{F \in \mathcal{F}_S^*(T)} (\delta(F_*) + (\delta(F_*) - 1)(\delta(F_*) - 4)) \\ &= (n - 1)\#\mathcal{F}_S(T) - \sum_{F \in \mathcal{F}_S^*(T)} (\delta(F_*) - 2)^2, \end{aligned}$$

as desired. ■

## 11. A COROLLARY OF CHOUDHURY AND KHARE

Although stated in greater generality (by considering weighted graphs, and computing the whole characteristic polynomial of the matrix), an immediate corollary of [CK23b, Thm. A] is the following.

**Corollary 11.1** ([CK23b]). *Let  $S$  be a subset of nodes of  $T$  of cardinality  $m \geq 3$ . Assume that the induced subgraph of  $T$  on  $S$  is a tree. Then,*

$$\det D[S] = (-1)^{m-1} \cdot (m - 1) \cdot 2^{m-2}.$$



The hypothesis on  $S$  can be rephrased as saying that  $T$  is constructed from a tree  $S$  by iteratively attaching pendant trees to some of the nodes. We give the first combinatorial account of this result.

*Proof.* We take the second, more intuitive notion: identify  $S$  with a tree and think of  $T$  as a tree constructed from  $S$  by iteratively attaching pendant trees to some of the nodes. There is only one  $S$ -rooted forest on  $T$ , namely the forest in which each component is an element  $s \in S$  together with all of the nodes of all of the pendant trees attached to  $s$ . In an  $(S, *)$ -rooted forest, the floating component must be one of the pendant trees; in particular,  $\delta(F_*) = 1$  for all pendant trees. Now, the formula from Theorem A gives

$$\det D[S] = (-1)^{m-1} 2^{m-2} \left( (m-1) \cdot 1 - \sum_{F \in \mathcal{F}_S^*(T)} 0 \right). \quad \blacksquare$$

## 12. CLOSING REMARKS

The present work perfectly illustrates how the combinatorial framework developed in [BEGLR24c] is, at the same time, natural and powerful. Indeed, the setting of [CK23b] is the correct algebraic setting to study distance matrices of trees in all generality, and the results therein prove to be the shadow of beautiful network combinatorics.

We remark that this document can be further generalized in two directions. The first, towards computing non-principal minors of the matrix; the second towards computing weighted generalizations of the formula. Both directions require simple changes in the combinatorial model, followed by careful (and tedious) algebraic computations. We leave this for a future work, and choose to tell a simpler story here.

## ACKNOWLEDGEMENTS

The current version of this article was written to be presented at the British Combinatorial Conference 2024. We thank Mercedes Rosas, Luis Esquivias, and Emmanuel Briand for helpful commentaries. We thank Harry Richman for making us aware of their preprint [RSW24] after the announcement of [BEGLR24b].

ÁG was funded by the University of Bristol Research Training Support Grant. AL was partially supported by the Grant PID2020-117843GB-I00 funded by MICIU/AEI/10.13039/501100011033.

## REFERENCES

- [AZ09] Martin Aigner and Günter M. Ziegler. *Proofs from THE BOOK*. Springer Publishing Company, Incorporated, 2009.
- [BEGLR24a] Emmanuel Briand, Luis Esquivias, Álvaro Gutiérrez, Adrián Lillo, and Mercedes Rosas. Derangements and non-intersecting paths. *In preparation*, 2024+.
- [BEGLR24b] Emmanuel Briand, Luis Esquivias, Álvaro Gutiérrez, Adrián Lillo, and Mercedes Rosas. Determinant of the distance matrix of a tree. *To appear in a special volume of the Séminaire Lotharingien Combinatoire for the 36th International Conference on Formal Power Series and Algebraic Combinatorics*, 2024. (Extended abstract).
- [BEGLR24c] Emmanuel Briand, Luis Esquivias, Álvaro Gutiérrez, Adrián Lillo, and Mercedes Rosas. Non-intersecting paths and the determinant of the distance matrix of a tree. *Preprint*, 2024.

- [BKN05] Ravindra B. Bapat, Stephen J. Kirkland, and Michael Neumann. On distance matrices and laplacians. *Linear Algebra and its Applications*, 401:193–209, 2005. Special Issue in honor of Graciano de Oliveira.
- [BLP06] Ravindra B. Bapat, Arbind K. Lal, and Sukanta Pati. A  $q$ -analogue of the distance matrix of a tree. *Linear Algebra and its Applications*, 416(2-3):799–814, 2006.
- [BLP09] Ravindra B. Bapat, Arbind K. Lal, and Sukanta Pati. The distance matrix of a bidirected tree. *Electronic Journal of Linear Algebra*, 18:233–245, 2009.
- [Cha01] Robin Chapman. An involution on derangements. *Discrete Mathematics*, 231(1):121–122, 2001.
- [CK23a] Projesh Nath Choudhury and Apoorva Khare. The additive-multiplicative distance matrix of a graph, and a novel third invariant. *arXiv e-prints*, 2023, 2309.08691.
- [CK23b] Projesh Nath Choudhury and Apoorva Khare. Distance matrices of a tree: Two more invariants, and in a unified framework. *European Journal of Combinatorics*, 115:103787, 2023.
- [DY20] Zhibin Du and Jean Yeh. Another simple proof of Graham and Pollak’s theorem. *Discrete Mathematics*, 343(10):111994, 3, 2020.
- [GL78] Ronald L. Graham and László Lovász. Distance matrix polynomials of trees. In *Problèmes combinatoires et théorie des graphes*, volume 260 of *Colloq. Internat. CNRS*, pages 189–190. CNRS, Paris, 1978.
- [GP71] Ronald L. Graham and Henry O. Pollak. On the addressing problem for loop switching. *The Bell System Technical Journal*, 50:2495–2519, 1971.
- [GV85] Ira Gessel and Gérard Viennot. Binomial determinants, paths, and hook length formulae. *Advances in Mathematics*, 58(3):300–321, 1985.
- [HY15] Hiroshi Hirai and Akihiro Yabe. A combinatorial formula for principal minors of a matrix with tree-metric exponents and its applications. *Journal of Combinatorial Theory, Series A*, 133:261–279, 2015.
- [Lin73] Bernt Lindström. On the vector representations of induced matroids. *The Bulletin of the London Mathematical Society*, 5:85–90, 1973.
- [LSZ14] Hong-Hai Li, Li Su, and Jing Zhang. On the determinant of  $q$ -distance matrix of a graph. *Discussiones Mathematicae. Graph Theory*, 34(1):103–111, 2014.
- [RSW24] Harry Richman, Farbod Shokrieh, and Chenxi Wu. Minors of tree distance matrices. *Preprint*, 2024.
- [Til10] Valerie Tilia. Determinants of distance matrices of trees. Master’s thesis, Portland State University, 2010.
- [YY06] Weigen Yan and Yeong-Nan Yeh. A simple proof of Graham and Pollak’s theorem. *Journal of Combinatorial Theory. Series A*, 113(5):892–893, 2006.
- [YY07] Weigen Yan and Yeong-Nan Yeh. The determinants of  $q$ -distance matrices of trees and two quantiles relating to permutations. *Advances in Applied Mathematics*, 39(3):311–321, 2007.
- [ZD16a] Hui Zhou and Qi Ding. The distance matrix of a tree with weights on its arcs. *Linear Algebra and its Applications*, 511:365–377, 2016.
- [ZD16b] Hui Zhou and Qi Ding. The product distance matrix of a tree with matrix weights on its arcs. *Linear Algebra and its Applications*, 499:90–98, 2016.

<sup>1</sup> SCHOOL OF MATHEMATICS, UNIVERSITY OF BRISTOL, UNITED KINGDOM.  
*Email address:* a.gutierrezcaceres@bristol.ac.uk

<sup>2</sup> DEPARTAMENTO DE ÁLGEBRA, FACULTAD DE MATEMÁTICAS, UNIVERSIDAD DE SEVILLA, SPAIN.  
*Email address:* alillo@us.es