

Label-free mid-infrared photothermal microscopy revisits intracellular thermal dynamics: what do fluorescent nanothermometers measure?

Keiichiro Toda^{1,2}, Masaharu Takarada³, Genki Ishigane², Hiroyuki Shimada¹, Venkata Ramaiah Badarla¹, Kohki Okabe³ and Takuro Ideguchi^{1,2}

¹ Institute for Photon Science and Technology, The University of Tokyo, Tokyo, Japan

² Department of Physics, The University of Tokyo, Tokyo, Japan

³ Department of Pharmaceutical Science, The University of Tokyo, Tokyo, Japan

* ideguchi@ipst.s.u-tokyo.ac.jp

Abstract

Fluorescent nanothermometry has revealed pronounced inhomogeneous temperature distributions within cells and has opened the field of single-cell thermal biology. However, this finding has sparked a controversial discussion known as the 10^5 gap issue, which arises from a simple heat conduction calculation suggesting such large temperature distributions should not exist inside cells. This debate has led to a hypothesis that intracellular thermal conduction is considerably slower than in water. Although various efforts have been made to measure intracellular thermal conduction, there are significant variations in the reported values. Here, we address this issue using label-free mid-infrared photothermal microscopy, which enables us to measure heat-induced temperature variations under local thermal equilibrium via refractive index changes. We measured intracellular thermal diffusivity via transient thermal decay and found that thermal diffusivity within living cells is 93-94% of water in the cytoplasm and nucleus. This result suggests that intracellular thermal conduction cannot explain the 10^5 gap issue. To investigate this issue further, we compared fluorescent nanothermometry with our label-free thermometry by measuring heat-induced temperature variations in living cells. This experiment revealed intriguing results where the fluorescent nanothermometry showed a slowly varying unexpected signal in addition to a constant temperature change. This result indicates that fluorescent nanothermometers are sensitive to additional factors on top of the temperature variation under local thermal equilibrium, raising an open question of what fluorescent nanothermometry measures.

Introduction

Over the last decade, various fluorescent nanothermometers have been developed and used for mapping intracellular temperature. A prominent discovery of nanothermometry was the presence of inhomogeneous temperature distribution over a few Kelvins within cells^{1,2,3,4,5}. This observation suggested potential thermoregulation of physiological activities at the cellular level, paving the way for the emerging field of single-cell thermal biology^{6,7}, where numerous exciting phenomena, such as the spatiotemporal thermoregulation of gene expression⁸ and neural activity⁹, have been reported. However, a controversial discussion, known as the 10^5 gap issue¹⁰, has arisen from a heat conduction calculation showing typical cellular heat production of 0.1-1 nW results in temperature differences

of approximately 10^{-5} K within a cell. This gap originates from rapid thermal diffusion in a cell, which is assumed to have thermal properties similar to those of an aqueous environment. Experimental studies measuring cellular heat generation provided supportive results in the amount of cellular heat production and thermal properties used in this calculation^{11,12}. To date, there has been no consensus on the mechanism behind the pronounced inhomogeneous temperature distribution observed in fluorescent nanothermometry. When considering this unresolved issue, it is important to note that the heat conduction calculation is based on temperature defined under local thermal equilibrium within the frameworks of thermodynamics and statistical mechanics, where thermal energy diffuses through thermal conduction.

There is a proposed scenario where the pronounced inhomogeneous temperature distribution can be explained by intracellular thermal diffusion being an order of magnitude slower than that in water, potentially due to the nano/micro-scale multiple thermal boundaries along with intracellular structures¹³. However, judging this hypothesis has been challenging due to significant variation in reported intracellular thermal diffusion rates (Table 1). For instance, fluorescent nanothermometers indicated intracellular thermal diffusion to be nearly an order of magnitude slower than that of water (18-19% of water)^{14,15}, while a label-free coherent Raman scattering microscope showed water-like thermal diffusion (89-93% of water)¹⁶. Although the latter measurement mitigated potential systematic errors associated with fluorescent nanothermometers (details are discussed later in this work), it raises concerns due to slow parameter changes, as it measured thermal conductivity using the steady-state heat conduction equation, $\kappa \nabla^2 T = -Q$, where κ , T , and Q represent thermal conductivity, temperature, and the amount of heat supplied per unit time, respectively. Since thermal conductivity is expressed as $\kappa = c\rho\alpha$, where c , ρ , α represent specific heat capacity, density, and thermal diffusivity, respectively, it could be affected by heat-induced changes in the parameters (c or ρ), as well as other factors not explicitly accounted for in the equation. For example, there is a study demonstrated that specific heat capacity c can change by tens of percent during seconds-long heating¹⁷. On the contrary, thermal diffusivity can be determined without being affected by slow changes in other intracellular parameters, as it is directly measured by transient thermal decay using the equation $\partial T / \partial t = \alpha \nabla^2 T$, where t denotes time. Recently, a semi-label-free transient measurement of thermal decay was attempted by detecting the photothermal effect with a dark-field microscope using gold nanoparticles (GNPs) as heat sources¹⁸. This study made comparative measurements between water and cells and reported slower decay inside cells (51-53±15-20% of water). However, it showed unrealistically long decay time of longer than 100 μ s from a 100-nm heat source within water. This indicates a potential systematic error in these measurements, which is suspected to be due to a lack of spatial information caused by dark-field imaging (further details are described in the Discussion section). Given the lack of consensus on intracellular thermal diffusion, it is essential to determine intracellular thermal diffusivity via careful label-free measurement.

In this study, we address the aforementioned hypothesis by measuring thermal dynamics using mid-infrared photothermal optical diffraction tomography (MIP-ODT)¹⁹, a newly developed label-free thermometry technique. MIP-ODT measures the macroscopic change in refractive index (RI) induced by local heating of water molecules via mid-infrared vibrational absorption. Since the RI change is mainly determined by density change due to thermal

expansion, we can measure a temperature change under local thermal equilibrium within the diffraction limit of the microscopy. Therefore, it enables us to measure the thermal conduction property within the observation volume. By operating our system in pump-probe imaging mode with nanosecond pulses, transient thermal decay in the time scale of microseconds can be measured without suffering from slow changes in intracellular parameters. Unlike dark-field imaging used in the previous study¹⁸, ODT enables artifact-free thermal diffusion measurements without losing spatial information. We first measured the thermal diffusivities of water and glycerol as reference samples and confirmed that the evaluated values were consistent with the literature, deviating by no more than 2%. Then, we measured the thermal diffusivities of the nucleus and cytoplasm of living COS7 cells and obtained $0.134 (\pm 0.008) \times 10^{-6} \text{ m}^2 \text{ s}^{-1}$ and $0.133 (\pm 0.002) \times 10^{-6} \text{ m}^2 \text{ s}^{-1}$, respectively. These values correspond to 94% ($\pm 1.7\%$) and 93% ($\pm 5.6\%$) of the thermal diffusivity of water, verifying that intracellular thermal conduction closely resembles that in an aqueous environment. This result contradicts the hypothesis that intracellular heat conduction is considerably slower than in water, raising the question of why the fluorescent nanothermometers show the inhomogeneous temperature distribution within cells.

Following the above consequence, we made an additional investigation to find a clue to solve this issue. We conducted comparative measurements on the heat-induced temperature change within cells using our label-free MIP-ODT thermometry and fluorescent nanothermometry with fluorescent polymeric nanothermometer (FPT). By continuously heating an intracellular spot for several seconds, we observed a step-like temperature variation with a quick rise and fall by our MIP-ODT thermometry, which is consistent with the rapid thermal decay expected in aqueous conditions. In contrast, the FPT measurement showed a slowly varying temperature increase under the same heating conditions. This comparative experiment suggests that the FPT senses slowly varying factors in addition to the temperature change measured by MIP-ODT. This finding raises an intriguing open question of what fluorescent nanothermometry measures.

Results

MIP-ODT system for label-free thermometry.

The working principle of our label-free thermometry is based on mid-infrared photothermal optical diffraction tomography (MIP-ODT)¹⁹, a recently developed label-free chemical imaging technique. A conceptual schematic of the system is shown in Fig. 1a, and details are described in “MIP-ODT system” in Methods. In this method, focused infrared (IR) laser light, which is in resonance with molecular vibrations of water, induces a micrometer-scale heat spot in a cell. Since water distributes almost uniformly within a cell, a well-determined heat spot can be generated. To ensure intracellular heating, we carefully select the IR wavelength (wavenumber) so that the IR light is dominantly absorbed within a cell, providing localized intracellular heating (see “Selection of IR wavenumber” in Methods). The irradiated spot immediately becomes a heat source during the light illumination because the induced energy of molecular vibrations quickly distributes to the other degrees of freedom, such as translational, rotational, and vibrational energies of the surrounding molecules, within picoseconds, leading to a local thermal equilibrium with a slightly higher temperature. Then, heat-induced temperature change leads to thermal expansion, which results in

density change at a typical spatio-temporal scale of ~ 10 nm and ~ 10 ns, where local thermal equilibrium can be defined¹³. The photothermal density change can be quantitatively measured through the RI change by optical diffraction tomography (ODT) with visible light. The ODT system is implemented by off-axis digital holography (DH)²⁰ with an azimuthally-scanning illumination scheme, providing 3-dimensional (3D) RI volumetric images with a spatial resolution of 250 nm and 5 μ m in the lateral and axial directions, respectively.

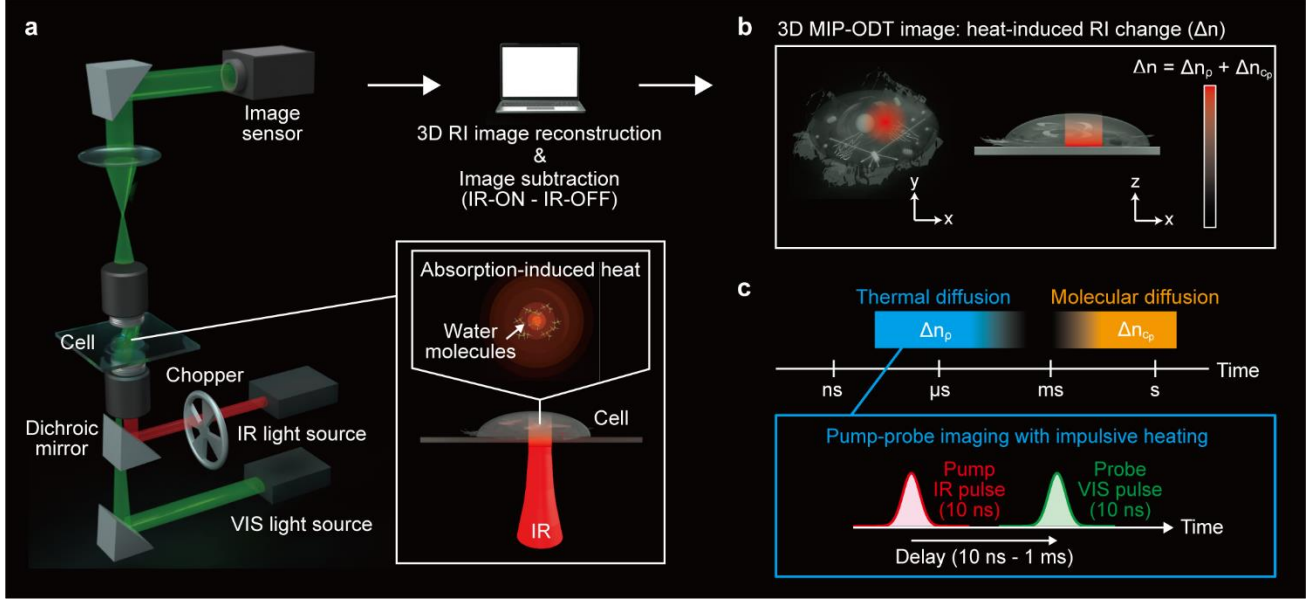

Fig. 1 Principle and schematic of MIP-ODT for label-free thermometry. **a** Schematic of the MIP-ODT system. **b** Illustration of a 3D MIP-ODT image. **c** Timescales of thermal and molecular diffusions. Thermal diffusion can be selectively measured by pump-probe imaging with nanosecond pulses.

Taking the difference between RI images with and without the IR illumination provides an image of heat-induced RI change (Δn), as illustrated in Fig. 1b. The dominant factor contributing to the RI change is a change in density (ρ) induced by temperature variations, which is primarily dominated by water, the most abundant molecular species within a cell. This factor can be denoted as $\Delta n_\rho = \frac{dn}{dT} \Delta T$, where T and ΔT represent the temperature and the heat-induced temperature change, respectively. Another major contributor to the change in RI is the alteration in molecular composition due to the diffusion of biopolymers, such as proteins, when micrometer-scale dynamic diffusion occurs during the measurement. This leads to a change in dry-mass concentration (c_p), either along a spatial temperature gradient (thermophoresis effect) or a radiation gradient (optical tweezers effect). In our measurement conditions, the former dominantly occurs (detailed discussions about intracellular thermophoresis can be found in another paper²¹). By denoting this factor as Δn_{c_p} , the total change in RI can be expressed as

$$\Delta n = \Delta n_\rho + \Delta n_{c_p} = \frac{dn}{dT} \Delta T + \Delta n_{c_p}. \quad (\text{Eq. 1})$$

It is important to note that the first term, Δn_ρ , is nearly linear to ΔT , while the thermo-optic coefficient $\frac{dn}{dT}$ has a slight dependence on T , as shown later in this paper. In order to extract a ΔT map from a measured Δn image, the first term must be selectively detected, which can be realized by harnessing the timescale difference of these phenomena. Specifically, Δn_ρ , governed by thermal diffusion, occurs on a microsecond timescale while Δn_{c_p} , induced by molecular diffusion, occurs on a timescale of milliseconds to seconds considering diffusion coefficients of intracellular macromolecules^{22,23}.

In our experiment, the first term Δn_ρ can be selectively measured by a pump-probe imaging method with nanosecond impulsive heating and detection, as shown in Fig. 1c. Here, the thermo-optic coefficient can be considered a constant value $\left(\frac{dn}{dT}\right)_{T=T_0}$ for the nanosecond pump-probe measurements, where T_0 is the initial temperature prior to the impulsive heating, because the temperature change induced by impulsive heating decays before the subsequent heating. Under this condition, Δn can be written as

$$\Delta n = \delta n_\rho = \left(\frac{dn}{dT}\right)_{T=T_0} \delta T, \quad (\text{Eq. 2})$$

where δn_ρ and δT denote impulsive RI and temperature changes induced by nanosecond heating, respectively. Thanks to the relation of $\Delta n \propto \delta T$, we can diagnose the time variation of temperature change induced by impulsive heating through the time-resolved refractive index measurements.

Intracellular thermal diffusivity measurement.

To evaluate intracellular thermal diffusivity, we performed transient thermal diffusion measurements by pump-probe imaging with 10-ns impulsive IR heating and visible detection pulses. The delay between the IR and the visible pulses is scanned at 1 μs step so that the thermal decay can be well visualized (see ‘‘Thermal diffusivity measurement’’ in Methods for details). For system evaluation, we first measured water and glycerol as reference samples. The wavenumber of the IR light was set to vibrational resonances of water (3,150 cm^{-1}) and glycerol (2,925 cm^{-1}), and a ~ 5 -nJ pulse was illuminated onto the sample with a full-width at half maximum (FWHM) spot size of ~ 3.5 μm . Figure 2a shows δT images of water captured at delays of 3, 7, and 13 μs after the impulsive heating, which are converted from raw images of δn_ρ by an experimentally derived nearly linear calibration curve (see ‘‘Calibration curve of δn_ρ on δT ’’ in Methods for details). From the transient evolution of the δT map, we plotted its decay (Fig. 2b) by taking the average values of an integration volume at the center part (1.8 \times 1.8 μm) of the δT profile in the x-y plane, indicated by a white dotted area in Fig. 2a.

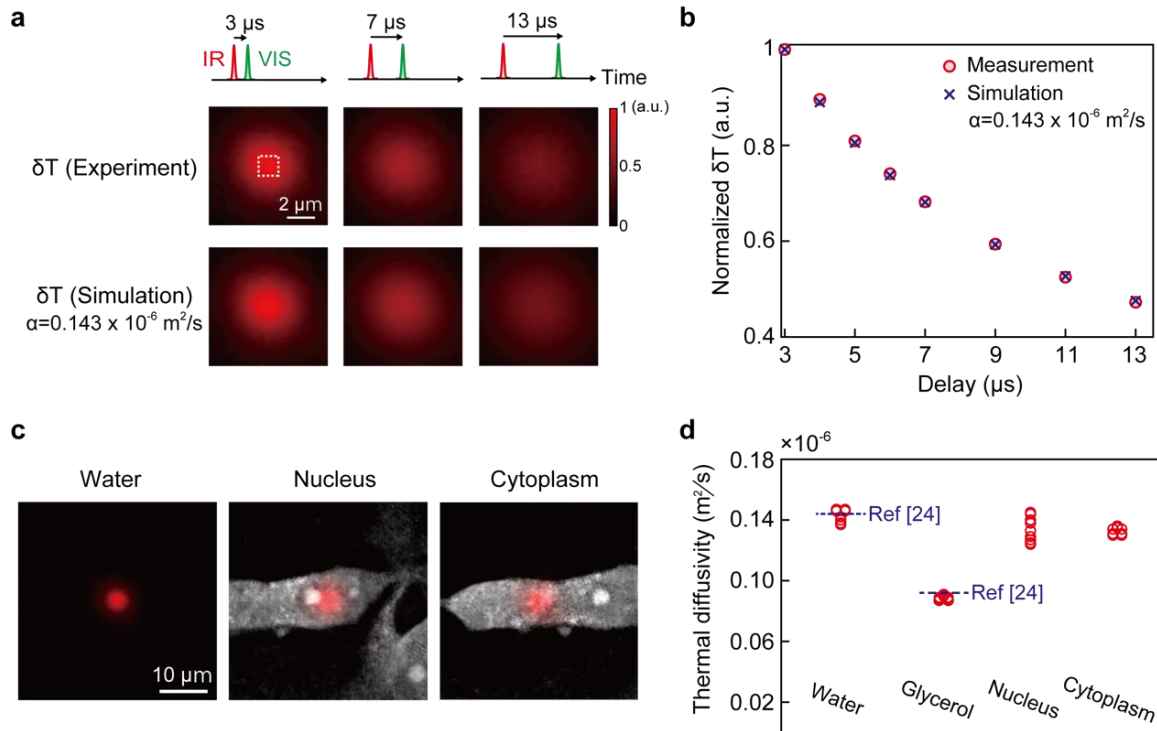

Fig. 2 Intracellular thermal diffusivity measurement by pump-probe imaging with 10-ns impulsive heating. a Experimentally measured temperature change (δT) maps induced by a nanosecond IR heating (top) and simulated δT maps with a thermal diffusivity of $0.143 \times 10^{-6} \text{ m}^2 \text{ s}^{-1}$ (bottom) at delays of 3, 7, 13 μ s. **b** Normalized δT as a function of delay. The plotted data are averages within the center part of the δT map shown as the white dotted area in **a**. **c** Images of the IR heating spot (shown in red) in water, nucleus, and cytoplasm of a COS7 cell. **d** Measured thermal diffusivities for water, glycerol, nucleus, and cytoplasm. The dotted lines represent the literature values of thermal diffusivities for water and glycerol²⁴.

To determine the thermal diffusivity from the measured data, one must carefully consider the spatial profile of the temperature map because thermal diffusion strongly depends on the initial spatial profile of the heat source and cannot be modeled by a single exponential function (see Supplementary Note 6 for details). Therefore, we performed heat conduction calculations to find a thermal diffusivity that replicates the experimental data (See “Heat conduction calculation” in Methods for details). The thermal diffusivity was determined by minimizing the sum of the squares of the differences between the experimental and simulation data points with a resolution of $0.001 \times 10^{-6} \text{ m}^2 \text{ s}^{-1}$.

The thermal diffusivities of water and glycerol obtained by the abovementioned analysis are $(0.143 \pm 0.004) \times 10^{-6} \text{ m}^2 \text{ s}^{-1}$ and $(0.089 \pm 0.002) \times 10^{-6} \text{ m}^2 \text{ s}^{-1}$ for 8 samples, respectively (see Fig. 2d), and are in good agreement with literature values, $0.144 \times 10^{-6} \text{ m}^2 \text{ s}^{-1}$ and $0.092 \times 10^{-6} \text{ m}^2 \text{ s}^{-1}$ within 2% deviation²⁴. Furthermore, the ratio of the standard deviation (STD) to the mean values is 2.7% for the water sample, which is lower than those reported in thermal conductivity measurements of previous studies (7.1%¹⁸ (GNP) and $\sim 40\%$ ¹⁴ (NVC)). This demonstration verifies our system's ability to measure heat conduction parameters with higher precision than previous works.

Then, we measured the thermal diffusivity of the cytoplasm and nucleus in living COS7 cells by selectively heating intracellular regions, as illustrated in Fig. 2c (see “Sample preparations” in Methods for sample preparation procedure). The measured thermal diffusivities of the cytoplasm and nucleus are $(0.133 \pm 0.002) \times 10^{-6} \text{ m}^2 \text{ s}^{-1}$ and $(0.134 \pm 0.008) \times 10^{-6} \text{ m}^2 \text{ s}^{-1}$ for 8 and 9 samples, respectively (~ 93 - 94 % against that of water). The corresponding thermal conductivity, $\kappa = \alpha / c\rho$, is calculated as $0.56 \text{ Wm}^{-1} \text{ K}^{-1}$ for both the nucleus and cytoplasm by using literature values of a cell density ρ of 1.08 kg m^{-3} ²⁵ and a specific heat capacity c of $3,900 \text{ J kg}^{-1} \text{ K}^{-1}$ ²⁶. It is consistent with theoretically estimated values ($\sim 0.54 \text{ Wm}^{-1} \text{ K}^{-1}$) by Levy’s model and the effective medium theory model by assuming the proportion of intracellular constituent molecules as water (80%) and protein (20%)²⁷, where the protein’s thermal conductivity is referenced by a reported value ($0.27 \text{ Wm}^{-1} \text{ K}^{-1}$)²⁸. Consequently, our measurements suggest that intracellular heat conduction is predominantly determined by the constituent molecular species rather than the intracellular structures, and it is likely that water, the most abundant intracellular molecular species, dominates micrometer-scale intracellular thermal conduction.

Table 1 presents a comparison of our work with previous investigations. Our results significantly differ from thermal diffusivity obtained with a GFP fluorescent thermometer ($0.027 \times 10^{-6} \text{ m}^2 \text{ s}^{-1}$)¹⁵ and thermal conductivities obtained with NVCs ($0.11 \text{ Wm}^{-1} \text{ K}^{-1}$)¹⁴, and GNP plasmonic imaging (0.31 - $0.32 \text{ Wm}^{-1} \text{ K}^{-1}$)¹⁸, while similar to those with coherent Raman scattering (CRS) microscopy ($0.563 \text{ Wm}^{-1} \text{ K}^{-1}$, $0.587 \text{ Wm}^{-1} \text{ K}^{-1}$, fixed cell)¹⁶ and heat-flow measurements operated outside a cell (0.54 - $0.57 \text{ Wm}^{-1} \text{ K}^{-1}$)^{12, 27, 29}. We will discuss the reasons for the discrepancy in the discussion section. Our result of water-like thermal diffusivity in living cells contradicts the hypothesis that intracellular heat conduction is considerably slower than in water.

Table 1 Comparison of thermal conduction parameters measured in this work and previous works.

Thermometer	Intracellular thermal diffusivity ($10^{-6} \text{ m}^2 \text{ s}^{-1}$) (/water (%))	Intracellular thermal conductivity ($\text{Wm}^{-1} \text{ K}^{-1}$) (/water (%))	STD of thermal conductivity for water	Cell type Temperature
GFP ¹⁵ Fluorescence intensity	0.027 (19%)	N/A	N/A	HeLa 37 °C
NVCs ¹⁴ Fluorescence intensity	N/A	0.11 ($18 \pm \sim 6.6\%$)	$\pm \sim 40\%$ **	HeLa 27 °C
GNP plasmonic ¹⁸ RI change	N/A	0.31-0.32 (51 - 53 ± 15 - 20% **)	$\pm 7.1\%$	HeLa, MCF-7, etc. 25 °C
CRS ¹⁶ Spectral shape of OH bonds	N/A	0.563 (nucleus) (89%) 0.587 (cytoplasm) (93%)	N/A	A549 (fixed) 37 °C
MIP-ODT (this work) RI change	0.134 ($94 \pm 1.7\%$) 0.133 ($93 \pm 5.6\%$)	0.56* (nucleus) (92%) 0.56* (cytoplasm) (92%)	$\pm 2.7\%$	COS7 24 °C

* These values represent the thermal conductivities estimated from measured thermal diffusivities with the literature values of heat capacity²⁶ and density²⁵.

** These are estimated values from the graphs shown in the papers.

Comparison of MIP-ODT thermometry with fluorescent nanothermometry.

To investigate why the fluorescent nanothermometers show inhomogeneous temperature distribution over a few Kelvins within cells, we compared our MIP-ODT thermometry and fluorescent nanothermometry under the same condition with the same microscopy setup. For this purpose, we implemented a fluorescence imaging branch on our MIP-ODT microscope (See “Fluorescence imaging” in Methods for details). It is important to note that the pump-probe imaging in a microsecond timescale with impulsive nanosecond heating is unsuitable for this comparison because the typical reaction time of fluorescent nanothermometers is in a millisecond timescale³⁰. Therefore, we induced seconds-long continuous heating and measured the temperature change. For continuous heating, we focused a 1456-nm CW-IR laser, which is in resonance with an overtone band of water molecules, onto the sample with a spot size of 5 μm (FWHM) and took images at a temporal resolution of 10 ms, determined by the image sensor’s frame rate (See “Heat-induced intracellular temperature change measurement” in Methods for details).

Under the seconds-long heating, however, Δn measured by our MIP-ODT thermometry can include the change in molecular diffusion, described as the second term (Δn_{c_p}) in Eq. 1, which prevents separately detecting temperature change only (See Supplementary Note 9 for details). To independently measure temperature change induced by continuous heating, we used a dual-heating method, where we added impulsive heating on top of the continuous heating (See “Dual-heating method” in Methods for details). Since the repetition rate of impulsive heating of 50 Hz is much higher than that of molecular diffusion, we can cancel out the effect of molecular diffusion and separately detect the refractive index change due to impulsive heating. By taking subtraction of images under the impulsive heating on and off, we get

$$\Delta n_{\text{IH-ON}} - \Delta n_{\text{IH-OFF}} = \delta n_{\rho} = \left(\frac{dn}{dT} \right)_{T=T_0+\Delta T} \delta T, \quad (\text{Eq. 3})$$

where T_0 is the temperature before continuous heating, ΔT is a temperature change induced by continuous heating, and δT is a temperature change induced by impulsive heating. In this measurement, δT is constant. Since the thermo-optic coefficient $\frac{dn}{dT}$ depends on temperature, we can extract and track ΔT from the measured δn_{ρ} . Figure 3a represents a timing chart of the dual-heating measurement.

Figure 3b presents a temporal change of Δn with 2.4-s continuous heating, where the brown cross and black square symbols show the Δn in the impulsive heating ON ($\Delta n_{\text{IH-ON}}$) and OFF ($\Delta n_{\text{IH-OFF}}$) frames, respectively. The red circles at the bottom of the figure present the difference between them ($\Delta n_{\text{IH-ON}} - \Delta n_{\text{IH-OFF}}$), corresponding to the refractive index change induced by the impulsive heating (δn_{ρ}). Using the temperature dependence of the thermo-optic coefficient, the measured δn_{ρ} is translated into ΔT (See “Calibration curve of δn_{ρ} on ΔT ” in Methods for details). The result shows that the ΔT instantaneously rises within the first frame interval of 20 ms and stays constant at ~ 5.0 K. This is consistent with the temperature change expected from the heat conduction calculation with the water-like intracellular thermal diffusivity, where the rise time of ΔT is estimated to be ~ 100 μs . Consistent time

variations were also observed in other cells that exhibit different variations of Δn_{c_p} , demonstrating the successful elimination of the Δn_{c_p} effect in our measurement (see Supplementary Note 15 for details).

Finally, we measured ΔT by a fluorescent nanothermometer, FPT, and compared it with that obtained by MIP-ODT. We measured the same COS7 cells with the same microscopy setup under continuous heating. Here, we also need to be careful about the effect of thermophoresis due to continuous heating. To mitigate this effect, we used ratiometric FPT thermometry, where temperature is evaluated by comparing fluorescence intensities at two different wavelengths. This method cancels out the fluorescence intensity variations due to the FPT's concentration change³¹. The top panel of Fig. 3c presents ΔT measured by FPT, showing two distinct features. Although the figure shows a representative result, we have confirmed that these features appeared regardless of the heating spot or samples. The first feature is an instantaneous rise and fall at the beginning and end of the heating, which is similar to that observed with the MIP-ODT measurement shown in the bottom panel in Fig. 3c. The amount of temperature change is close for both measurements, ~ 5 K and ~ 4 K with MIP-ODT and FPT thermometry, respectively. This feature indicates that the fluorescent nanothermometer senses temperature change under local thermal equilibrium with a response time below the frame interval of 40 ms. Another distinct feature is a seconds-long gradual increase and decrease of ΔT during and after the continuous heating, which is not observed with MIP-ODT thermometry. It is important to note that this feature was also observed with other types of fluorescent nanothermometers, such as Rhodamine B and Cy3, reported in another paper³⁰. These observations indicate that fluorescent nanothermometers detect additional factors on top of temperature change under local thermal equilibrium.

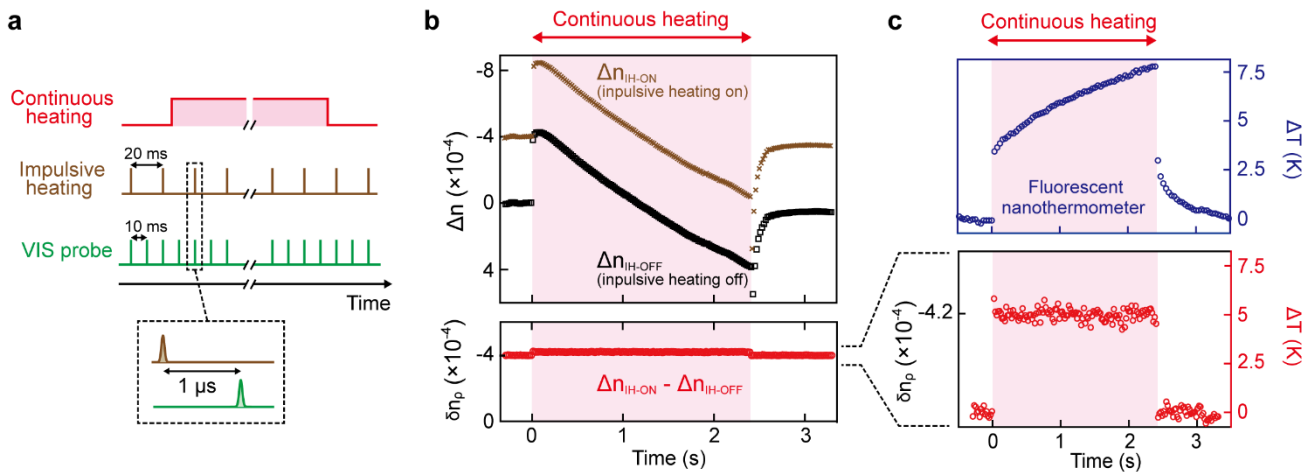

Fig. 3 Heat-induced intracellular temperature change measurements by MIP-ODT and fluorescent nanothermometry. **a** A timing chart of the continuous heating, impulsive heating, and visible probe for temperature change measurement. **b** A temporal evolution of Δn under continuous heating with (brown crosses) and without (black squares) the impulsive heating, and their difference, δn_p (red circles). **c** Time variation of ΔT induced by continuous heating measured by fluorescent nanothermometer (FPT) (top) and label-free MIP-ODT thermometer (bottom).

Discussion

Since this study is the first report of measuring intracellular thermal diffusivity by a label-free technique, we compare the thermal conductivity evaluated in this work and the previous label-free studies^{16,18}, instead. There is a large discrepancy between the values determined in this work ($0.56 \text{ Wm}^{-1}\text{K}^{-1}$) and the previous study ($0.31\text{-}0.32 \text{ Wm}^{-1}\text{K}^{-1}$)¹⁸, although both the measurements detect the photothermal effect. A potential reason for this difference could be the spatial highpass filtering effect of dark-field imaging used in the previous work, which could induce a systematic error. In the previous work, a decay time over $100 \mu\text{s}$ was reported from a heat source of 100 nm in diameter placed in water, which is significantly longer than the theoretically estimated value (sub-microsecond) by several orders of magnitude. We suspect this was due to the insufficient temporal resolution of $5 \mu\text{s}$, which led to the detection of the tail of the decay already after heat spreading. Although their images showed a small spot at the beginning of the diffusion, this may be due to the intrinsic spatial highpass filtering effect (that causes a lack of spatial information) of dark-field imaging, which can artificially visualize the vastly spreading heat distribution as a small spot. On the contrary, our method, MIP-ODT imaging, does not suffer from the spatial filtering effect, and it was experimentally verified by comparing measured and calculated results in RI signal decay in water and glycerol. Compared with another previous study, our result ($0.56 \text{ Wm}^{-1}\text{K}^{-1}$ in nucleus and cytoplasm) is very close to that determined by CRS microscopy (0.563 and $0.587 \text{ Wm}^{-1}\text{K}^{-1}$ in nucleus and cytoplasm, respectively), which measured steady-state temperature distribution of fixed cells¹⁶. The reason why the steady-state measurement showed the rapid decay without suffering from slowly varying effects, such as thermophoresis, was probably because fixation of cells prevented them. It is also important to note that the sample and temperature (fixed A549 cells under 37°C) are different from ours (living COS7 cells under 24°C), implying that thermal conductivity does not strongly depend on cell types and temperature.

Finally, we discuss the potential origin of the additional factor observed in fluorescent nanothermometry. Our observation indicates the existence of a slowly varying phenomenon, which can be induced by heating and does not reach local thermal equilibrium at least within a few seconds. To consider this, we can gain some insights from previous works. Firstly, several studies have carefully verified that the fluorescent quantum yields of the nanothermometers are not affected by microviscosity, pH, and ion concentrations^{1,2,3,4}. Secondly, various nanoprobe based on different fluorescence mechanisms have shown similar inhomogeneous temperature maps. From these clues, we can hypothesize that the nature of nanoprobe could play an essential role. Since nanoprobe intrinsically sense spatially localized volume around the molecules, they can exchange energy with surrounding molecules. One of the candidates of such energy exchange can originate from the slowly varying structural changes of macromolecules attached to the fluorescent nanoprobe. In this context, it is interesting to notice non-thermal fluctuations observed in living cells, where structural changes of macromolecules convey non-thermal energy at a slow time scale of seconds³². Since this time scale is similar to the slowly varying signal observed with fluorescent nanothermometers, the energy change due to structural changes of macromolecules is a potential origin of the additional factor. Indeed, another work on temperature mapping with fluorescent nanoprobe has reported indications of non-conductive energy dissipation within cells³⁰. The above hypothesis does not contradict the result made by MIP-ODT thermometry because MIP-ODT measurement probes spatiotemporal scales of micrometers and milliseconds, which is not

sensitive to the seconds-long slow phenomena occurring at the nanometer scale.

Conclusion

We studied intracellular thermal dynamics using label-free mid-infrared photothermal optical diffraction tomography, shedding light on an ongoing debate in cellular thermal biology. We first determined the intracellular thermal diffusivity of living cells for the first time via label-free transient thermal decay measurement and verified that it is similar to that of water. Then, we conducted comparative measurements of heat-induced temperature changes using our label-free MIP-ODT thermometry and fluorescent nanothermometry and observed a significant discrepancy between the two. Based on our experiments and comparisons with prior studies, we conclude that fluorescent nanothermometers sense slowly varying additional factors on top of the temperature change. In view of previous studies, we hypothesize a scenario that a potential origin of the additional factor could be nanometer-scale local energy changes due to structural variations of macromolecules. This work would trigger further investigations of the origin of the nanoprobe-measured temperature. Our label-free MIP-ODT thermometry will play a pivotal role in future studies to tackle the uncovered open question.

Finally, we suggest to the community that fluorescent nanothermometers are inadequate for quantitative analysis of intracellular thermal properties, which can only be accurately determined by measuring temperature under local thermal equilibrium. Due to the lack of this capability, fluorescence nanothermometry cannot provide accurate evaluations of intracellular thermal properties^{14,15}. On the contrary, we would like to emphasize that fluorescent nanothermometers might become new tools for detecting hidden energies, which should be useful for studying thermally-induced cellular functions in cellular thermal biology^{33,34}.

Reference

1. Okabe, K. *et al.* Intracellular temperature mapping with a fluorescent polymeric thermometer and fluorescence lifetime imaging microscopy. *Nat. Commun.* **3**, 705 (2012).
2. Dominique, C. *et al.* Mitochondria are physiologically maintained at close to 50 °C. *PLoS Biol.* **16**, 201–210 (2018).
3. Qiao, J. *et al.* Ratiometric Fluorescent Polymeric Thermometer for Thermogenesis Investigation in Living Cells. *Anal. Chem.* **87**, 10535–10541 (2015).
4. Kiyonaka, S. *et al.* Genetically encoded fluorescent thermosensors visualize subcellular thermoregulation in living cells. *Nat. Methods* **10**, 1232–1238 (2013).
5. Tanimoto, R. *et al.* Detection of Temperature Difference in Neuronal Cells. *Sci. Rep.* **6**, 22071 (2016).
6. Zhou, J. *et al.* Advances and challenges for fluorescence nanothermometry. *Nat. Methods* **17**, 967–980 (2020).
7. Kucsko, G. *et al.* Nanometre-scale thermometry in a living cell. *Nature* **500**, 54–58 (2013).
8. Kamei, Y. *et al.* Infrared laser-mediated gene induction in targeted single cells in vivo. *Nat. Methods* **6**, 79–81 (2009).
9. Huang, H. *et al.* Remote control of ion channels and neurons through magnetic-field heating of nanoparticles. *Nat.*

- Nanotechnol.* **5**, 602–606 (2010).
10. Baffou, G. *et al.* A critique of methods for temperature imaging in single cells. *Nat. Methods* **11**, 899–901 (2014).
 11. Hong, S. *et al.* Sub-nanowatt microfluidic single-cell calorimetry. *Nat. Commun.* **11**, 1–9 (2020).
 12. Kyoo Park, B. *et al.* Thermal conductivity of single biological cells and relation with cell viability. *Appl. Phys. Lett.* **102**, 203702 (2013).
 13. Suzuki, M. *et al.* The 10^5 gap issue between calculation and measurement in single-cell thermometry. *Nat. Methods* **12**, 802–803 (2015).
 14. Sotoma, S. *et al.* In situ measurements of intracellular thermal conductivity using heater-thermometer hybrid diamond nanosensors. *Sci. Adv.* **7**: eabd7888 (2021).
 15. Lu, K. *et al.* Intracellular Heat Transfer and Thermal Property Revealed by KiloHertz Temperature Imaging with a Genetically Encoded Nanothermometer. *Nano Lett.* **22**, 5698–5707 (2022).
 16. Figueroa, B. *et al.* Real-Time Microscale Temperature Imaging by Stimulated Raman Scattering. *J. Phys. Chem. Lett.* **11**, 7083–7089 (2020).
 17. Inomata, N. *et al.* Measurement of cellular thermal properties and their temperature dependence based on frequency spectra via an on-chip-integrated microthermistor. *Lab Chip* **23**, 2411–2420 (2023).
 18. Song, P. *et al.* Heat transfer and thermoregulation within single cells revealed by transient plasmonic imaging. *Chem* **7**, 1569–1587 (2021).
 19. Tamamitsu, M. *et al.* Label-free biochemical quantitative phase imaging with mid-infrared photothermal effect. *Optica* **7**, 359 (2020).
 20. Park, Y. K. *et al.* Quantitative phase imaging in biomedicine. *Nat. Photonics* **12**, 578–589 (2018).
 21. Toda, K. *et al.* Label-free intracellular thermophoretic imaging. Manuscript in preparation.
 22. Arrio-Dupont, M. *et al.* Translational diffusion of globular proteins in the cytoplasm of cultured muscle cells. *Biophys. J.* **78**, 901–907 (2000).
 23. García-Pérez, A. I. *et al.* Molecular crowding and viscosity as determinants of translational diffusion of metabolites in subcellular organelles. *Arch. Biochem. Biophys.* **362**, 329–338 (1999).
 24. Balderas-López, J. A. *et al.* Thermal-wave resonator cavity design and measurements of the thermal diffusivity of liquids. *Rev. Sci. Instrum.* **71**, 2933–2937 (2000).
 25. Pertoft, H. *et al.* Isopycnic Separation of Cells and Cell Organelles by Centrifugation in Modified Colloidal Silica Gradients. *Methods of Cell Separation* 25-65 (1977).
 26. Giering, K. *et al.* Determination of the specific heat capacity of healthy and tumorous human tissue. *Thermochim. Acta* **251**, 199–205 (1995).
 27. Shrestha, R. *et al.* Thermal conductivity of a Jurkat cell measured by a transient laser point heating method. *Int. J. Heat Mass Transf.* **160**, 120161 (2020).
 28. Yu, X. *et al.* Heat flow in proteins: Computation of thermal transport coefficients. *J. Chem. Phys.* **122**, 054902 (2005).
 29. ElAfandy, R. T. *et al.* Nanomembrane-Based, Thermal-Transport Biosensor for Living Cells. *Small* **13**, 7 (2017).
 30. Takarada, M. *et al.* High-speed Intracellular Temperature Mapping Reveals the Existence of Non-Conductive Dissipation of Energy by Heating. Manuscript in preparation.

31. Uchiyama, S. *et al.* A cationic fluorescent polymeric thermometer for the ratiometric sensing of intracellular temperature. *Analyst* **140**, 4498–4506 (2015).
32. Umeda, K. *et al.* Activity-dependent glassy cell mechanics II: Nonthermal fluctuations under metabolic activity. *arXiv*: 2302.13323 (2023).
33. Okabe, K *et al.* Intracellular thermometry uncovers spontaneous thermogenesis and associated thermal signaling. *Commun. Biol.* **4**, 1–7 (2021).
34. Chuma, S. *et al.* Implication of thermal signaling in neuronal differentiation revealed by manipulation and measurement of intracellular temperature. *Nat. Commun.* **15**, 4–8 (2024).
35. Ishigane, G. *et al.* Label-free mid-infrared photothermal live-cell imaging beyond video rate. *Light Sci. Appl.* **12**, 48 (2023).
36. Venyaminov, S. Y. *et al.* Water (H₂O and D₂O) Molar Absorptivity in the 1000–4000 cm⁻¹ Range and Quantitative Infrared Spectroscopy of Aqueous Solutions. *Anal. Biochem.* **248**, 234–245 (1997).
37. Jewel, J. M. Thermo-optic Coefficients of some Standard Reference Material Glasses. *J. Am. Ceram. Soc.* **74**, 1689–1691 (1991).
38. Ramires, M. L. V. *et al.* Standard Reference Data for the Thermal Conductivity of Water. *J. Phys. Chem. Ref. Data* **24**, 1377–1381 (1995).
39. Lotfi, M. *et al.* Experimental Measurements on the Thermal Conductivity of Glycerol-Based Nanofluids with Different Thermal Contrasts. *J. Nanomater.* 3190877 (2021).

Methods

MIP-ODT system.

A detailed schematic of the MIP-ODT system is represented in Fig. S1 of Supplementary Note 1. A homemade Ti-Sapphire laser at a repetition rate of 1 kHz serves 10-ns visible probe pulses at 705 nm, which are guided into a Mach-Zehnder interferometer through an optical single-mode fiber. In the sample arm of the interferometer, the probe pulses go through a beam steering optics consisting of a grating with lines per millimeter of 70 (46-068, Edmund), an aperture, relay lenses, and a reflective objective lens (5007-000, Beck Optronic Solutions) placed in a 4-f configuration so that the beam is illuminated onto a sample at a tilted angle with a numerical aperture (NA) of 0.58. The illumination angle can be discretely changed by rotating the grating at ten different angles. The aperture is synchronously rotated with the grating to transmit only the first diffraction beam. The FWHM illumination area on the sample is 110 μm in diameter, which is a 1/11.8 times magnification from that on the grating. The sample image is magnified in the image sensor plane for holographic measurement by a factor of 167 with an objective lens (LCPLFLN100XLCD, Olympus) and relay lenses. The reference light is directed to the image sensor (Q-2HFW, Adimec) in the off-axis configuration after adjusting the optical path length, beam size, and polarization to match those of the object light.

We used two IR light sources, a homemade ns-PPLN-OPO³⁵ (ns-IR) and a 1,456-nm CW laser diode (LD) (BL1456-PAG500, Thorlabs) (CW-IR), for the impulsive and continuous heating, respectively. The ns-IR laser is operated at

a repetition rate of 1 kHz, and the output wavenumber is tunable from 2,800 to 3,250 cm^{-1} . The ns-IR beam is mechanically modulated with an optical chopper, while the CW-IR beam is electronically controlled with an LD driver. For impulsive and continuous dual-heating, the ns-IR and CW-IR beams are spatially combined with a dichroic mirror (106950, LAYERTEC) and subsequently combined with the visible beam with another dichroic mirror (100-00-024, S.T.Japan). These beams are focused onto the sample through the reflective objective lens.

Selection of IR wavenumber.

To ensure intracellular local heating, we carefully selected the optimal IR wavenumber with which the IR light is absorbed inside the cell. Figure S2a in Supplementary Note 2 illustrates the depth (z -axis) profiles of δn_p for water, which were acquired through MIP-ODT measurements with ns-IR wavenumbers of 3,000, 3,050, and 3,150 cm^{-1} . Solid lines in the figure show experimental results, which are in good agreement with the dashed lines derived from the theoretical absorption profiles assessed by molar extinction coefficients at the corresponding IR wavenumbers, showing the $1/e$ decays of 7, 5, and 2 μm , respectively³⁶. We also confirmed that the cell and culture medium absorb a similar amount of IR light at 3,150 cm^{-1} (see Fig. S2b). Hence, we employed 3,150 cm^{-1} for IR wavenumber to ensure intracellular local heating of the adherent cells with a thickness of $\sim 5 \mu\text{m}$ (Fig. S2c). In the experiment for comparison between label-free and fluorescence nanothermometry (shown in Fig. 3), we selected 3,100 cm^{-1} with $1/e$ attenuation of around 3 μm , to obtain a signal from the entire cell in depth for a better comparison with fluorescence measurements because fluorescence imaging provides depth-integrated signals. The wavelength of CW-IR is 1,456 nm, which exhibits a lower molar extinction coefficient for water. Although it does not ensure intracellular local heating along the z -axis, the z -sectioning capability of ODT enables measuring intracellular signals.

Thermal diffusivity measurement.

Figure S3 in Supplementary Note 3 depicts the timing chart and control system of MIP-ODT for pump-probe imaging with nanosecond pulses. Repetition rate and timing of the ns-IR pulses (1 kHz), visible pulses (1 kHz), image sensor (100 Hz), and optical chopper (50 Hz) were electrically controlled with a function generator (DG1022Z, RIGOL), and the sensor alternately acquired IR-ON and -OFF frames (see Fig. S3a). The sensor recorded ten visible pulses in a single frame. The delay and illumination angle was also controlled by the function generator (see Fig. S3b).

We acquired 200-frames-averaged phase images by digital holography at ten different angles of illumination for each pump-probe delay and reconstructed an RI image. For RI reconstruction, non-negative constraint regularization was applied with 100 iterations. We selected an initial delay for transient measurement at 3 μs because heat diffusion towards the glass dominantly occurs within a few μs after the heating.

For intracellular measurements, we carefully confirmed that the heated area, particularly in the z direction, is within the cell by depth-sectioned ODT images. Slight heat distribution in the surrounding extracellular water was confirmed to cause a minor effect (see Supplementary Note 4 for details). To precisely evaluate the heat-induced δn_p , we integrated the RI images stacked in the z -direction and visualized the two-dimensional flow of thermal energy.

The residual error of the thermal diffusivity measurement cannot be explained by the noise of our visible ODT measurement, and we suspect that it comes from the IR irradiation conditions, such as fluctuations of the laser power or the beam spot size, which could be reduced by monitoring the laser power or implementing a more robust optical system.

Calibration curve of δn_ρ on δT .

We performed calibration of δn_ρ of water with respect to the temperature rise δT because it is known that there is a slight temperature dependence in the thermo-optic coefficient (dn/dT). It should be noted that the nonlinearity derived below is a minor effect that causes deviation in thermal diffusivity by 4% than that without the calibration. Details are described in Supplementary Note 5.

Heat conduction calculation.

The heat conduction equation is written as,

$$\frac{\partial \delta T(x,y,z,t)}{\partial t} = \left(\frac{\partial^2}{\partial x^2} + \frac{\partial^2}{\partial y^2} + \frac{\partial^2}{\partial z^2} \right) \alpha \delta T(x,y,z,t), \quad (\text{Eq. 4})$$

where δT is the temperature change, x , y , and z are the spatial coordinates, t is the time, and α is the thermal diffusivity. We used the experimentally obtained δT map as an initial profile in the x-y plane and a theoretical absorption profile along the z-axis. Then, we calculated the evolution of δT map by imposing the glass-sample boundary condition. For rigorous comparisons with the experimental results, the instrumental function of ODT was applied to the calculation results. Since the dn/dT of glass is significantly smaller than those of water and glycerol³⁷, δn_ρ in the glass area can be considered to be zero in the calculation, corresponding to the negligibly small δn_ρ experimentally observed in ODT measurement even if heat transfers into the glass.

We used a self-made program based on the Forward Time Centered Space (FTCS) method, which was implemented using Python. The pixel pitch was set to 207 nm to match the ODT measurement. When the sample was water, the IR absorption profiles along the z-axis, required for generating the initial temperature map, were determined based on the literature value of the absorption coefficient for water³⁶. For glycerol and cells, we could not find literature values. Therefore, we used a 1/e decay length of 3.5 μm for glycerol, derived from the experimental data, and the same value as water for cells because the absorption profile shows good agreement with that of water, as demonstrated in Fig. S4.

We imposed the boundary conditions between the sample and the glass substrate written by

$$K_{\text{sample}} \left(\frac{\partial T_{\text{sample}}(x,y,z,t)}{\partial z} \right)_{z=\text{boundary}} = K_{\text{glass}} \left(\frac{\partial T_{\text{glass}}(x,y,z,t)}{\partial z} \right)_{z=\text{boundary}}, \quad (\text{Eq. 5})$$

where $K_{\text{sample (glass)}}$ and $T_{\text{sample (glass)}}$ are the thermal conductivity and temperature of the sample (glass), respectively. The thermal conductivity of the glass substrate was set to 0.76 $\text{Wm}^{-1}\text{K}^{-1}$ for soda-lime glass, specified

by the manufacturer, from which we derived the thermal diffusivity of $0.40 \times 10^{-6} \text{ m}^2 \text{ s}^{-1}$, and those of water and glycerol are 0.61 and $0.29 \text{ W m}^{-1} \text{ K}^{-1}$, respectively^{38,39}. The thermal conductivity of cells was calculated by multiplying the thermal diffusivity with the specific heat capacity of $3,900 \text{ J/(kg} \cdot \text{K)}$ and the density of 1.08 g/cm^3 reported in previous studies^{25,26}.

To apply the instrumental function of the ODT measurement to a 3D temperature map simulated by the thermal conduction calculation, we converted the temperature map to an RI map and calculated phase images through the light propagation equation for all the illumination angles by the angular spectrum method. Then, these phase images were used as inputs for the ODT reconstruction algorithm to produce a 3D RI image with the instrumental function of the ODT measurement.

Sample preparations.

COS7 cells were cultured either on a soda-lime glass plate (1-9648-01, AS ONE) (for experiment shown in Fig. 2) or a CaF₂ plate (C20SQ-0.5, Pier Optics) (for experiment shown in Fig. 3) with high-glucose Dulbecco's modified eagle medium (DMEM), which contains L-glutamine, phenol red, and HEPES (FUJIFILM Wako). The medium was supplemented with 10% fetal bovine serum (Cosmo Bio) and 1% penicillin-streptomycin-L-glutamine solution (FUJIFILM Wako) at 37°C in a 5% CO₂ atmosphere. The COS7 cells were sandwiched between the substrates for imaging.

We performed microinjection to introduce FPTs into cells following the subsequent procedure: (1) FPTs were loaded into a capillary (524-295-7000, Eppendorf) equipped with a chip (5242-956-003, Eppendorf). The capillary was affixed to the injector (FemtJet, Eppendorf). (2) While monitoring the microscopic field-of-view (FOV), the tip of the capillary was gradually lowered to the surface of the dish using a controller (Micromanipulator, Eppendorf). (3) Subsequently, FPTs were injected through the cellular membrane while maintaining the pressure in the capillary within the range of 50 to 100 hPa. The injection solution comprised FPTs dissolved in water at a concentration of 0.5 weight/volume (w/v)%, whereas the estimated concentration of FPTs within the cell was approximately 0.02 w/v%. The environmental temperatures during measurements were 24°C for thermal diffusivity measurements and 26°C for heat-induced intracellular temperature change measurements.

Fluorescence imaging.

Our MIP-ODT system incorporates an epifluorescence imaging modality (see Fig. S1 in Supplementary Note 1). We used FPT for ratiometric sensing, in which fluorescence wavelengths were 500-520 nm and 550-600 nm (FDV-0005, FNA) under 488-nm excitation (WSLP-488-010m-4-B, Wavespectrum). The detection wavelength band was selected by optical bandpass filters (FBH520-40 and FELH0550, Thorlabs). The average excitation power was $\sim 40 \mu\text{W}$ with an illumination spot diameter of $\sim 50 \mu\text{m}$. The fluorescence was then transmitted through a dichroic mirror (MD499, Thorlabs) and projected onto an sCMOS image sensor (Zyla5.5, Andor). The image sensor was operated at 25 fps. The time variation of temperature was evaluated by calculating the ratio of the fluorescence intensities at the two wavelength bands. The detailed procedure is outlined in Supplementary Note 7.

Heat-induced intracellular temperature change measurement.

Figure S8 in Supplementary Note 8 shows the timing chart for the continuous heating experiment. The CW-IR beam was repetitively illuminated onto the sample by heating and cooling cycles of 2.4 s and 12.6 s, respectively, in addition to the impulsive heating with the ns-IR pulses (Fig. S8a). Figure S8b shows the timing chart for fluorescence measurements. The excitation light for fluorescence imaging was illuminated onto the sample for a duration of 4.6 s, starting before the initiation of continuous heating by 0.8 s.

In the experiment corresponding to Figs. 3 and S9, the average power of CW-IR light was ~2 mW. The result of time variation displayed in Fig. S9d was obtained without averaging, whereas that in Fig. 3b was calculated as the average of two measurements. The Δn values in these plots were calculated by averaging $2.1 \times 2.1 \times 4.2 \mu\text{m}$ for Fig. S9d and $2.8 \times 2.8 \times 5.6 \mu\text{m}$ for Fig. 3b along x-, y-, and z-axes in the center of the continuous heating spot.

Dual-heating method.

In the dual-heating method, Δn with impulsive heating OFF and ON are expressed as

$$\Delta n_{\text{IH-OFF}} = \Delta n_{\rho} + \Delta n_{c_p}, \quad (\text{Eq. 6})$$

$$\Delta n_{\text{IH-ON}} = \Delta n_{\rho} + \Delta n_{c_p} + \delta n_{\rho} = \Delta n_{\rho} + \Delta n_{c_p} + \left(\frac{dn}{dT} \right)_{T=T_0+\Delta T} \delta T, \quad (\text{Eq. 7})$$

where T_0 denotes the temperature right before the continuous heating, and ΔT and δT are the temperature changes induced by continuous heating and impulsive heating, respectively. The first and second terms in Eq.7, Δn_{ρ} and Δn_{c_p} , are the RI changes due to continuous heating, and the third term, δn_{ρ} , is that induced by the impulsive heating. Note that the symbols Δ and δ on the right-hand side of the equations represent changes induced by continuous and impulsive heating, respectively. The third term depends on ΔT because the RI change measurement with impulsive heating was operated at every 20 ms, where the initial temperature for each impulsive heating was $T_0 + \Delta T$. We can selectively detect the third term by taking the difference between the impulsive heating ON and OFF states, with which the first and the second terms are canceled out. It is important to note that the differential measurement must be operated in a sufficiently short time to ensure that it is not influenced by the slowly varying effect. To satisfy this condition, we used a frame interpolation method (see Supplementary Note 11 for details). With this approach, we confirmed that the slowly varying effect originating from Δn_{ρ} and/or Δn_{c_p} was reduced to less than 1% of Δn . We corrected the slowly varying minor effect (see Supplementary Note 12 for details), although the characteristics remain unchanged without the correction. The IR-visible delay was set to 1 μs to maximize SNR. The differential measurement between impulsive heating ON and OFF leads to Equation 3. Since δT and T_0 are constant, the temperature change due to continuous heating ΔT can be measured through temperature dependence of the thermo-optic coefficient.

Calibration curve of δn_{ρ} on ΔT .

To accurately determine ΔT with the dual-heating method, we measured ΔT dependence of δn_ρ by changing the amount of continuous heating. The absolute value of ΔT was determined by Δn_ρ divided by intracellular thermo-optic coefficient dn/dT (see Supplementary Note 13 for details). We evaluated Δn_ρ by selectively measuring Δn at the very beginning of the continuous heating, 5 ms after the beginning of the heating. We applied the non-negative constraint to evaluate Δn_ρ for better accuracy because accurate determination of ΔT was required. For an accurate evaluation, we averaged 200 images of Δn . On the contrary, we did not apply the non-negative constraint to evaluate δn_ρ because the primary importance lied in precise determination of relative values rather than accuracy.

From the abovementioned measurement, we found that δn_ρ linearly increases against ΔT as

$$(\delta n_\rho)_{T=T_0+\Delta T}/(\delta n_\rho)_{T=T_0} \approx 1 + a\Delta T, \quad (\text{Eq. 8})$$

where a is a constant value. Figure S13 in Supplementary Note 14 shows the measured data from which we evaluated a . Note that each cell provides slightly different a ($9.3 \times 10^{-3} \pm 7\%$). This is probably because molecular composition depends on the measurement area. Therefore, we evaluated a specifically for the measured cell to determine ΔT accurately.

Data availability

The data provided in the manuscript are available from the corresponding author upon reasonable request.

Acknowledgments

This work was financially supported by Japan Society for the Promotion of Science (20H00125, 23H00273), JST PRESTO (JPMJPR17G2), Precise Measurement Technology Promotion Foundation, Research Foundation for Opto-Science and Technology, Nakatani Foundation, and UTEC-Utokyo FSI Research Grant.

Author contributions

K.T. developed the MIP-ODT system, performed the experiments, and analyzed the experimental data. M.S. and K.O. provided the FPT-injected COS7 cells. K.T., M.S., H.S., K.O., and T.I. discussed the interpretation of the results. V.R.B. constructed the Ti-Sapphire laser and OPO. H.S. wrote codes for data acquisition. K.T. and G.I. wrote codes for thermal conduction simulation. T.I. supervised the entire work. K.T. and T.I. wrote the manuscript with inputs from the other authors.

Competing interests

K.T. and T.I. are inventors of patents related to the MIP-ODT system.

Supplementary Information for Label-free mid-infrared photothermal microscopy revisits intracellular thermal dynamics: what do fluorescent nanothermometers measure?

Keiichiro Toda^{1,2}, Masaharu Takarada³, Genki Ishigane², Hiroyuki Shimada¹, Venkata Ramaiah Badarla¹, Kohki Okabe³ and Takuro Ideguchi^{1,2}

¹ Institute for Photon Science and Technology, The University of Tokyo, Tokyo, Japan

² Department of Physics, The University of Tokyo, Tokyo, Japan

³ Department of Pharmaceutical Science, The University of Tokyo, Tokyo, Japan

* Corresponding author: ideguchi@ipst.s.u-tokyo.ac.jp

Supplementary Note 1: Detailed schematic of MIP-ODT system.

Figure S1 represents a detailed schematic of our MIP-ODT system, which also integrates epifluorescence microscopy.

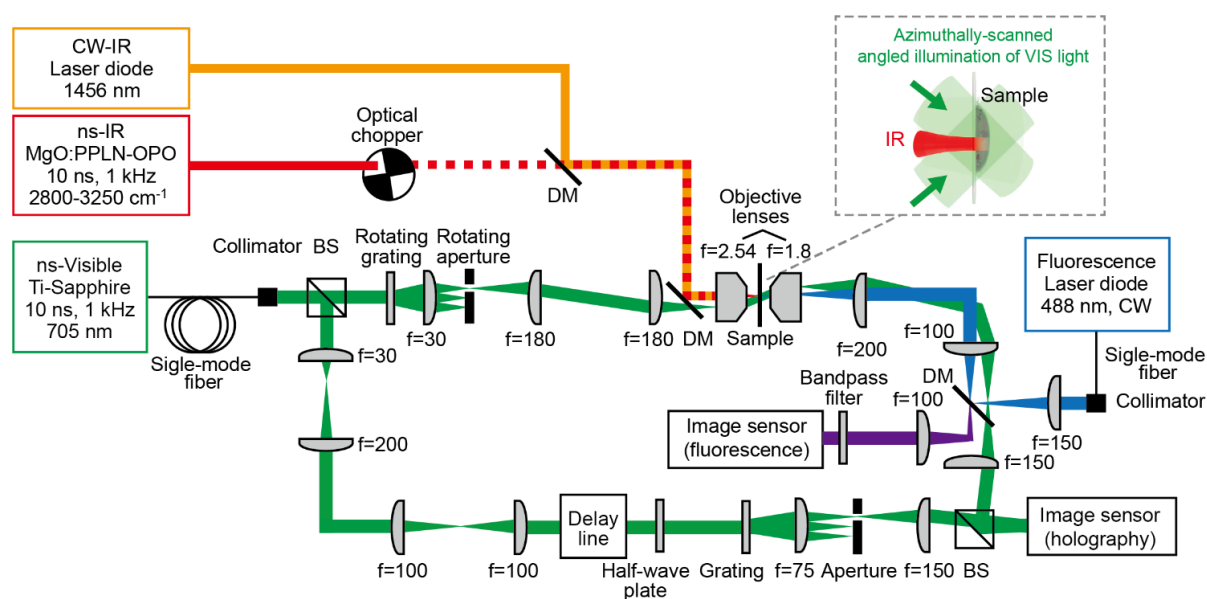

Fig. S1 Detailed schematic of MIP-ODT system. PPLN-OPO: Periodically-poled lithium niobate optical parametric oscillator, DM: Dichroic mirror, BS: Beamsplitter.

Supplementary Note 2: IR wavenumber selection for intracellular thermal diffusivity measurement.

Figure S2 shows depth (z-axis) profiles of the δn_p measured by MIP-ODT with ns-IR wavenumbers of 3,000, 3,050, and 3,150 cm⁻¹.

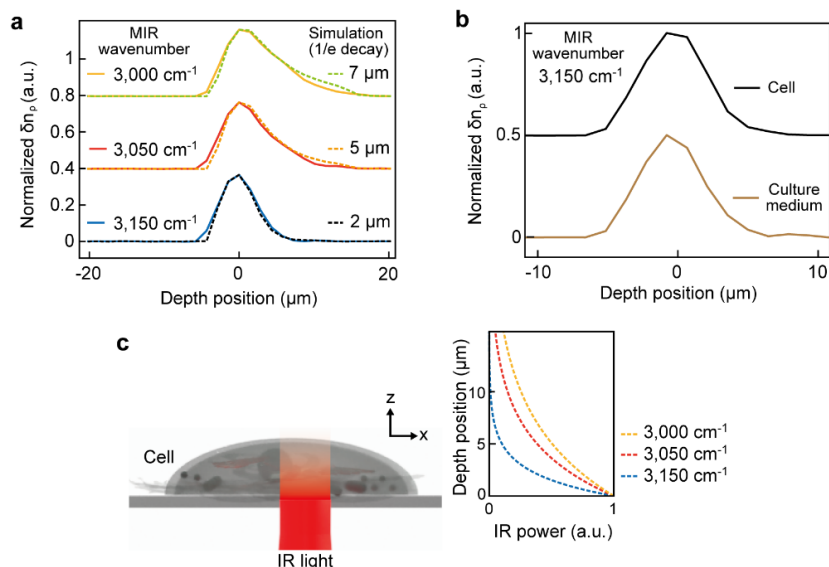

Fig. S2 Measured and simulated attenuation depth of the IR light. **a** Solid lines: Depth (z -axis) profiles of normalized δn_p for a water sample measured by MIP-ODT excited at IR wavenumbers of 3,000 (yellow), 3,050 (red), and 3,150 cm^{-1} (blue). Dashed lines: Simulated depth profiles by convolving the instrumental function of our ODT measurement to single exponential functions with $1/e$ decay lengths of 7 (light green), 5 (orange), and 2 μm (black). **b** Depth profiles of normalized δn_p for a culture medium (brown) and a COS7 cell (black). **c** Illustrative depiction of attenuation profiles of IR light illuminating a cell with a thickness of 5 μm at different IR wavenumbers.

Supplementary Note 3: Timing chart and control system of MIP-ODT for pump-probe imaging.

Figure S3 displays the timing chart and the control system of MIP-ODT for pump-probe thermal diffusivity measurements.

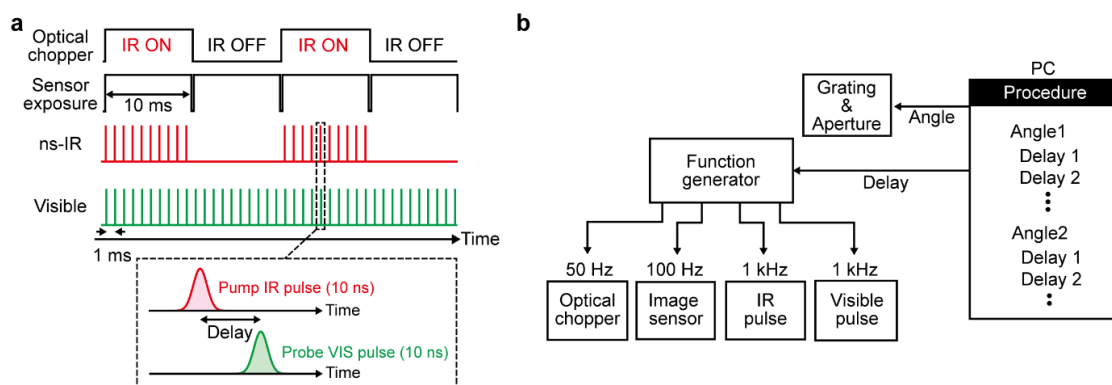

Fig. S3 Timing chart and control system of MIP-ODT for pump-probe imaging with nanosecond pulses. **a** Timing chart of the optical chopper, sensor exposure, and ns-IR/visible pulses. **b** Control system. A function generator controls the frequency and phase (timing) of the optical chopper, image sensor, IR pulses, and visible pulses. A PC sets the illumination angle and pump-probe delay.

Supplementary Note 4: Influence of slight heat distribution in the surrounding water on the thermal diffusivity measurement.

To investigate the impact of a small amount of heat distribution in the water behind the cell on the thermal diffusivity measurements, we compared simulations and experimental results of the z-axis profiles of δn_p for water and a cell on a glass substrate. Figures S4a and S4b display time-resolved profiles of δn_p for water obtained through heat conduction simulation with and without applying the instrumental function of the ODT measurements. Figures S4c and S4d show experimental results for water and a cell measured with MIP-ODT. We verify that the experimental results show good agreement with the simulation, demonstrating our heat conduction calculations, depicted in Fig. S4a, accurately reproduce the actual thermal diffusion. It is also clearly observed that the experimentally measured profile of water (Fig. S4c) is nearly identical to that of a cell (Fig. S4b). These comparisons guarantee that we can use the simulation result shown in Fig. S4a to evaluate the cell measurements. The ratio of the δn_p outside the 5- μm sample region against the total δn_p within the integrated volume is $\sim 8.9\%$ at a delay of 0 s, which gradually increases via thermal diffusion (Fig. S4a). The mean value becomes $\sim 13\%$ during the delay shown in Fig. 2b (3-13 μs), which indicates that 87% of the induced heat resides in the 5- μm -thick cell, while 13% of that presents in the surrounding water. This amount of heat leakage does not majorly alter the value of intracellular thermal diffusivity. In our specific case, a simple estimation via a weighed linear summation of the two components, $0.133 \times 10^{-6} \text{ m}^2 \text{ s}^{-1} \times 0.87$ (cell) + $0.143 \times 10^{-6} \text{ m}^2 \text{ s}^{-1} \times 0.13$ (water), provides a thermal diffusivity of $0.134 \times 10^{-6} \text{ m}^2 \text{ s}^{-1}$, which is deviated by 1% from that without the correction.

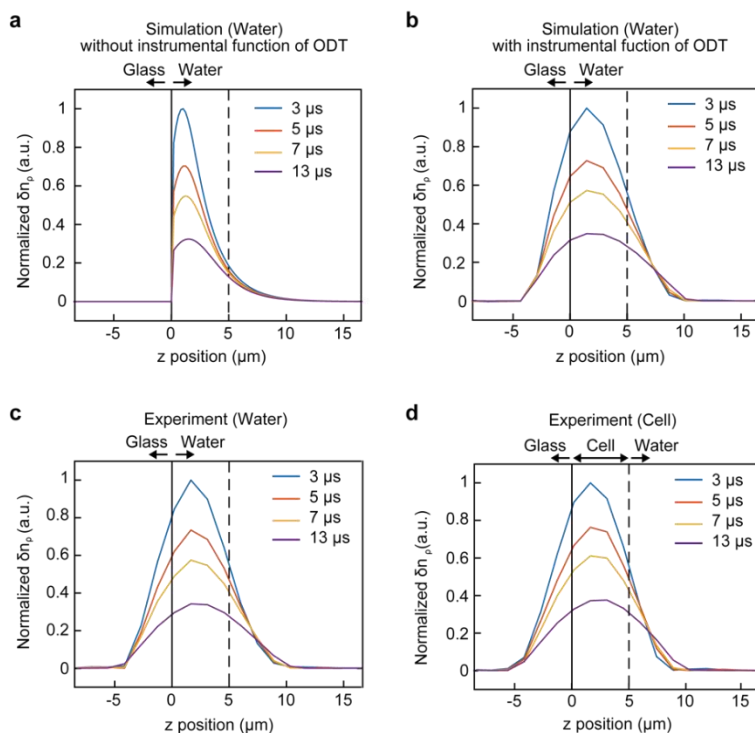

Fig. S4 Time-resolved z-axis profiles of δn_p for water and a cell. **a** Simulation results for water without the instrumental function of ODT. The $1/e$ attenuation of IR light is set to 2 μm , which is the same condition as the experiment shown in Fig. 2. **b** Simulation results for water with the instrumental function of ODT. **c** Experimental results for water. **d** Experimental results for cell.

Supplementary Note 5: Calibration curve of δn_p on δT .

Considering the numbers of IR photons and water molecules in the excited volume with their vibrational decay time, the IR pulse used in our study can excite a small number of water molecules in the excited volume. Therefore, the vibrational absorption of water in this work is assumed to be in the linear regime without saturation. Since the temperature rise can be expected to be in a linear relation with the amount of absorption, we investigate the dependence of δn_p on the IR power to make a calibration curve.

To evaluate the dependence of δn_p on the IR power, we measured crosssectional δn_p profiles with different IR powers (Fig. S5a). We first use a linear relationship between δn_p and δT with an equation of $\delta n_p = 10^{-4}\delta T$ (Fig. S5b), which is a known value of the thermo-optic coefficient of water ($dn/dT = 1 \times 10^{-4}$) at room temperature. Figure S5c displays δT profiles normalized by the excitation IR power 1, showing nonlinearity, particularly around the center of the heated spot, which owes to the slight temperature dependence of dn/dT . According to the abovementioned linear relationship between the temperature rise and the IR power, the normalized δT profiles by excitation IR power must be identical. Therefore, we assume a nonlinear relationship with a quadratic term as $\delta n_p = 10^{-4}(a\delta T + b\delta T^2)$ and find the constants (a and b) to make the normalized profiles overlap (Fig. S5d). We obtain $a=0.98$ and $b=0.02$, respectively, which agree well with the literature values¹. The nonlinear calibration curve is shown in Fig. S5b.

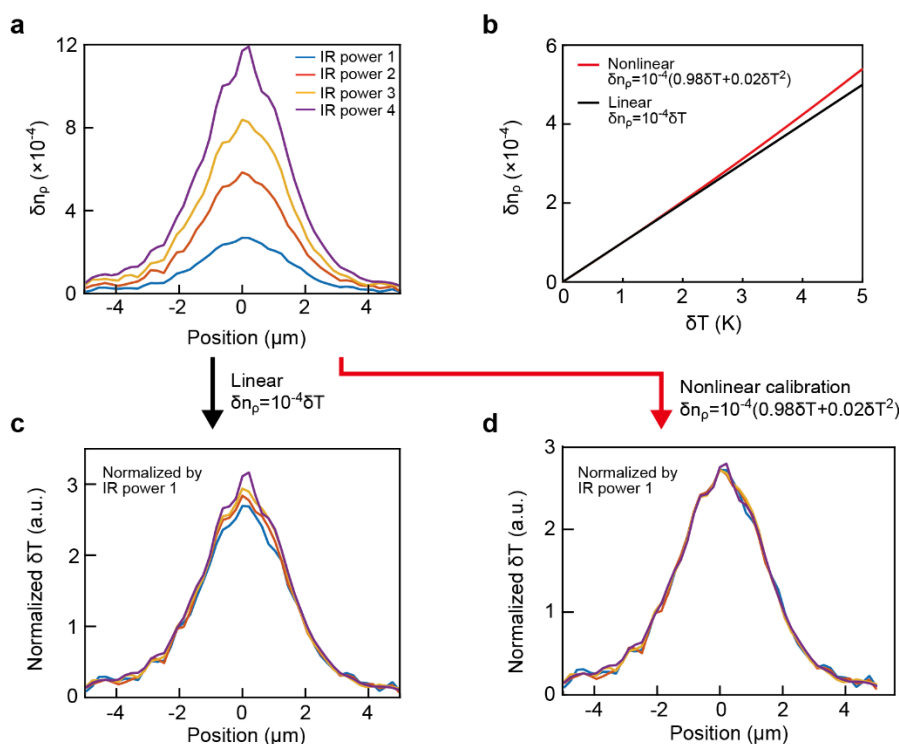

Fig. S5 Determination of the calibration curve of δn_p on δT . **a** Crosssectional profiles of δn_p of water measured with different IR powers. **b** The nonlinear calibration curve of δn_p on δT (red line) referenced with a linear curve (black line). **c** Crosssectional profiles of δT normalized by IR power 1 converted with the linear relation of $\delta n_p = 10^{-4}\delta T$. **d** Crosssectional profiles of δT normalized by IR power 1 converted with the nonlinear relation of $\delta n_p = 10^{-4}(0.98\delta T + 0.02\delta T^2)$.

Supplementary Note 6: Single-exponential fitting for decay plots of temperature change.

A single exponential fitting generally does not work well for evaluating thermal decay. We explain it by showing simulations of temperature change decay from two different micrometer-scale heat sources. Figure S6a represents a heat source with a Gaussian profile in the x-y plane and an exponential decay in the z-direction, which is similar to our MIP excitation, while Figure S6b shows a situation with a spherical heat source. The surrounding medium is water in both cases. The dots in the figures represent simulation results with 3D heat conduction calculation, showing thermal decay in microsecond time scale, while the solid lines are their fitting curves by single exponential functions. The calculation method of heat conduction is the same as that explained in Methods. It is clearly displayed that the fitting curves exhibit poor agreement with the decay plots, which strongly depend on the shape of the initial temperature distribution. This simulation suggests that single-exponential fitting is generally inappropriate for accurately determining thermal diffusivity. Therefore, we calculated 3D heat conduction to evaluate thermal diffusivity from our experimental data.

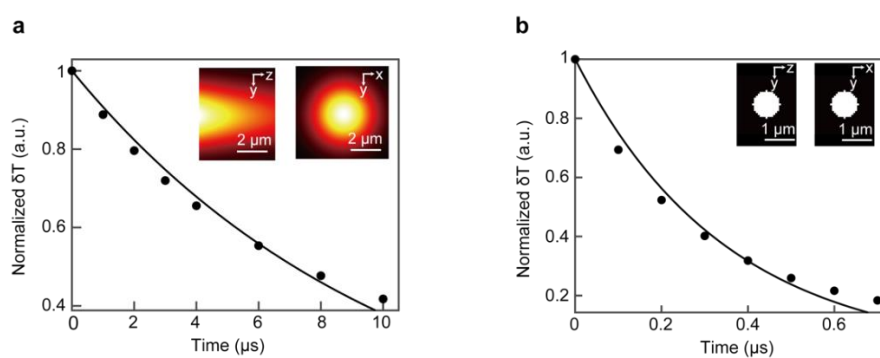

Fig. S6 Single-exponential fitting of temperature change decay. **a** A simulated temperature decay plot from an initial temperature distribution comprising a Gaussian profile with an FWHM of 2.7 μm in the x-y plane and an exponential function along the z-axis that attenuates in 6 μm . **b** A simulated temperature decay plot from an initial temperature distribution comprising a sphere with a diameter of 1 μm . Solid lines represent single-exponential fitting curves.

Supplementary Note 7: Procedure of temperature measurement with fluorescent ratiometric sensing.

Fluorescence ratiometric sensing² is a technique that enables measuring temperature by taking a ratio of separately measured fluorescence intensities at different wavelength bands, where temperature dependences are different. In this experiment, we take a signal with less dependence on temperature at 500-520 nm, and that with strong temperature dependence at 550-600 nm. The captured fluorescence images of a cell are presented in Fig. S7a. Figure S7b shows time variations of fluorescence intensities with continuous heating at a region indicated in the dotted red box shown in Fig. S7a. To extract temperature from the measured data, we made a calibration curve by measuring FPT signals in cells (5 cells) at different temperatures. We used a heating plate to control the temperature of a culture medium (TP-CHSQ-C, Tokai-Hit). Here, we assume the cell's temperature is equivalent to that of the surrounding culture medium. Figure S7c shows the calibration curve we obtained from the averaged data. Figure S7d shows the time variation of temperature derived from the measured data (Fig. S7b) using the calibration curve. Since the

fluorescence measurements at different wavelengths were not simultaneously captured, the fluorescence intensities could suffer from the FPT's photobleaching, causing a slight variation in the fluorescence ratio. To remove this effect, we set the temperature at the time before heating becomes equivalent to that of the heater.

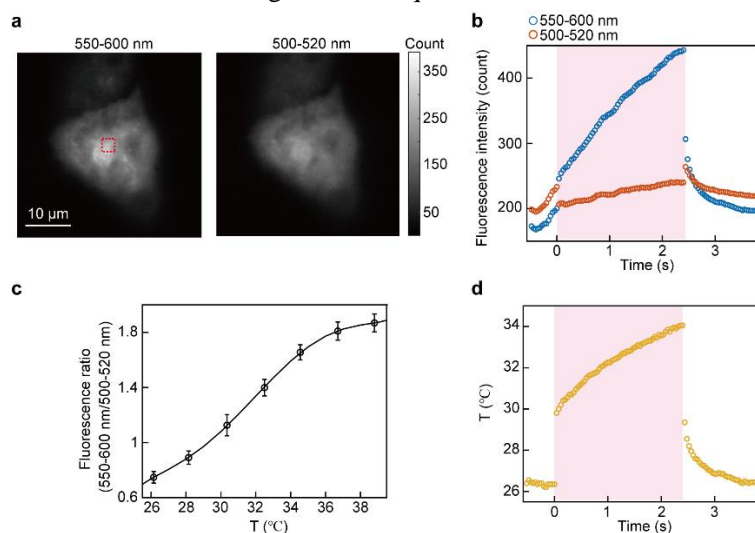

Fig. S7 Temperature measurement with fluorescent ratiometric sensing. **a** Fluorescence images of a cell measured at the wavelength bands of 550-600 nm (left) and 500-520 nm (right). **b** Time variations of fluorescence intensities averaged in the dotted red area in **a** (blue: 550-600 nm, orange: 500-520 nm). **c** A calibration curve of temperature to fluorescence ratio between the two wavelength bands. **d** Time variation of temperature derived from **b** using the calibration curve shown in **c**.

Supplementary Note 8: Timing chart of MIP-ODT and fluorescence imaging for heat-induced intracellular temperature change measurements.

Figures S8a and S8b show the timing chart of MIP-ODT thermometry and fluorescent nanothermometry, respectively.

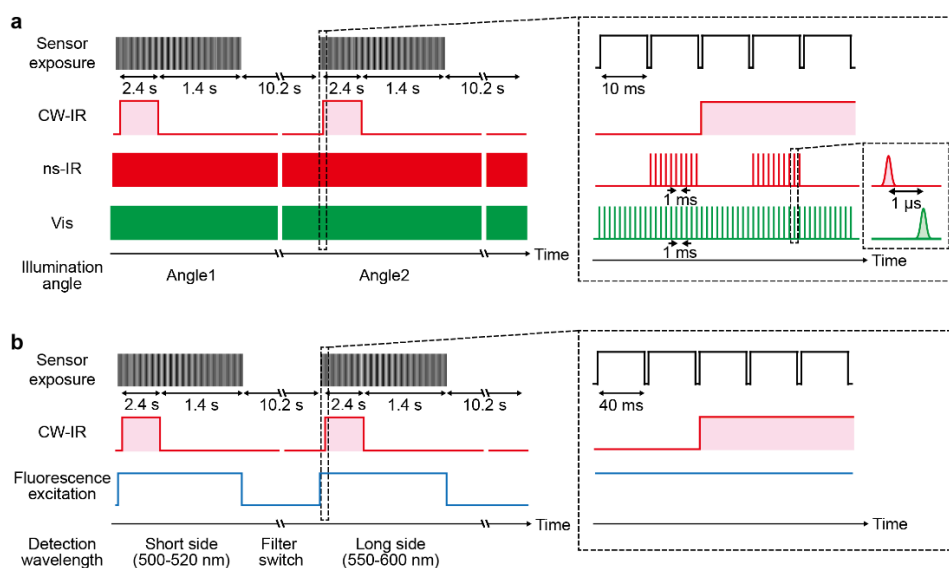

Fig. S8 Timing chart for heat-induced temperature change measurement. **a** Label-free MIP-ODT thermometry with dual-heating method. **b** Fluorescent nanothermometry with FPT.

Supplementary Note 9: Change in refractive index during continuous heating.

We measured the time variation of Δn inside and outside a COS7 cell (Fig. S9a) using a heating duration of 0.25 s by subtracting the RI image captured right before heating ($t = 0$) from those obtained afterward. Figures S9b and S9c illustrate the Δn map inside and outside the cell at $t = 0.01, 0.25, 0.26,$ and 0.28 s, respectively. By comparing the results obtained at 0.01 s (the beginning of heating) and 0.25 s (the end of heating), we see a decreased Δn at 0.25 s, specifically around the center of the heated area inside the cell, which persists even after the heating ends (see $t = 0.26$ and 0.28 s). Note that the color scales are displayed with negative values. Figure S9d represents Δn time variations observed inside and outside the cell. The Δn outside the cell (black squares) shows a rectangular time variation with instantaneous rise and fall, which is consistent with the water-like heat conduction. On the other hand, a gradual change in Δn is observed inside the cell. We also observed site-specific different time variations at the nucleus and cytoplasm (see Supplementary Note 10). These results indicate that slow changes in Δn_{c_p} appear inside the cell during the seconds-long heating as expected. However, only the Δn measurement cannot exclude the possibility of a slowly varying Δn_{ρ} . We introduce dual-heating method to solve this issue in the main text. There is another important insight obtained from Fig. S9d. At the beginning of the heating, Δn instantly changes by a certain amount and then slowly evolves afterward. This implies that Δn_{ρ} is the dominant factor in the initial short time of the heating. It is confirmed by evaluating a portion of the slow variation in Δn being only 4.9% at 5 ms (half the frame interval) after the beginning of heating, as illustrated in Fig. S9d.

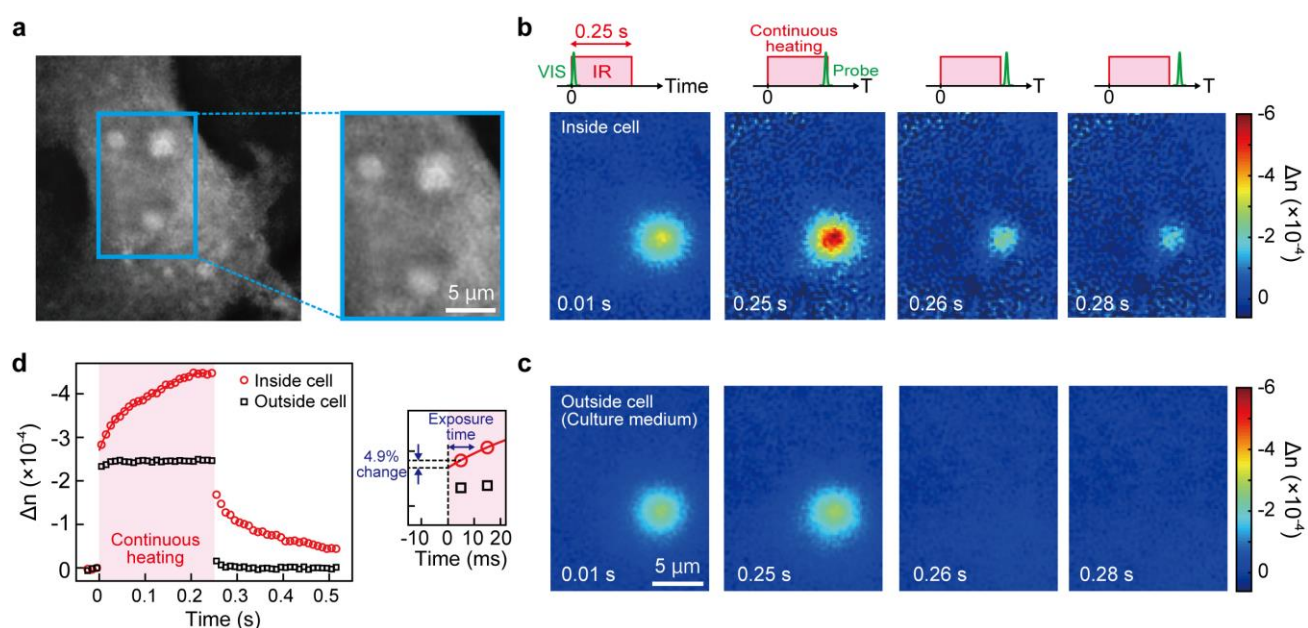

Fig. S9 Refractive index change (Δn) measurement with continuous heating. **a** An RI image of a COS7 cell (left) and a zoom-in around the heating area (right). **b** Δn images inside the cell at 0.01, 0.25, 0.26, and 0.28 s after the beginning of the continuous heating. **c** Δn images outside the cell at the same time frames as **b**. **d** Time variation of Δn inside (red) and outside (black) the cell. There is only a culture medium outside the cell. The small right panel shows a zoom-in around the beginning of the heating. The portion of the slow variation at 5 ms is evaluated as 4.9% to the Δn value at 0 ms, confirming the Δn_{ρ} is dominant at the beginning of the heating (~ 5 ms).

Supplementary Note 10: Site-specific intracellular time variation of Δn induced by continuous heating.

Figure S10 shows the site-specific time variations of Δn within a COS7 cell, particularly at the nucleus and cytoplasm. Interestingly, the time variations are significantly different. The Δn increases during heating in the nucleus, while it decreases in the cytoplasm. Further details regarding the site-specific Δn time variations are discussed in another paper³.

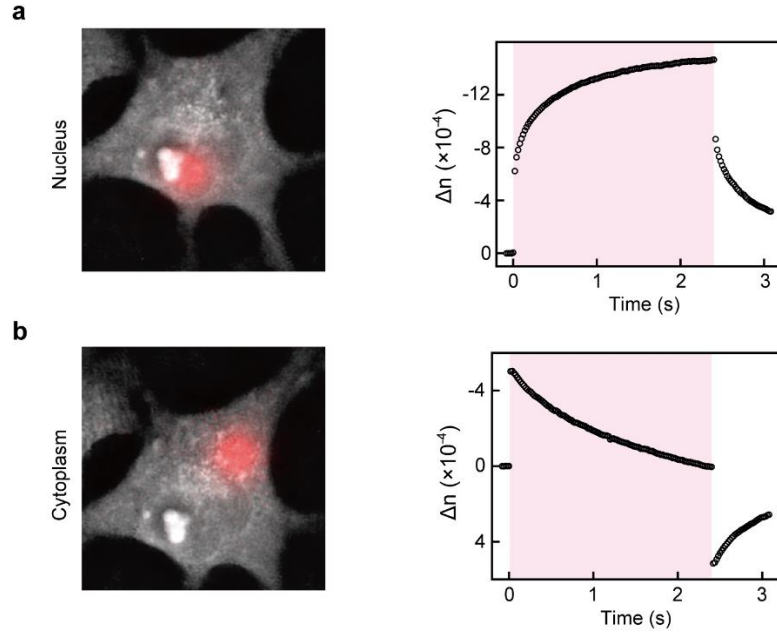

Fig. S10 Site-specific time variations of Δn in a cell induced by continuous heating. RI images of a COS7 cell with the heating spots, **a** in the nucleus and **b** in the cytoplasm, displayed in red (left), and time variations of Δn around the center of the heating spot (right).

Supplementary Note 11: Frame interpolation method.

We used the frame interpolation method in dual-heating conditions to cancel the effect of the slowly varying component (Δn_{c_p}) in Δn for precise evaluation of δn_ρ by subtracting the values obtained with impulsive heating ON and OFF states. Figure S11a illustrates the method. To verify this method, we apply it to the data shown in Fig. S9d, which represents a slowly varying Δn induced by continuous heating, which is shown as red circles in Fig. S11b. We plot interpolated values as black crosses, which are the averages of data points before ($\Delta n(t - 0.01 s)$) and after ($\Delta n(t + 0.01 s)$). Note that 0.01 s is the frame interval of our measurement. Blue squares in Figure S11b show the difference between $\Delta n(t)$ (red circles) and the interpolated values (black crosses). The STD of the difference is 2.9×10^{-6} , which is less than 1% of the Δn values, showing this method largely reduces the slowly varying effect in Δn . While a linear frame interpolation was employed here, we used nonlinear frame interpolations with polynomial fitting for analyzing data shown in Figs. 3 and S14 to adapt various temporal evolution of Δn .

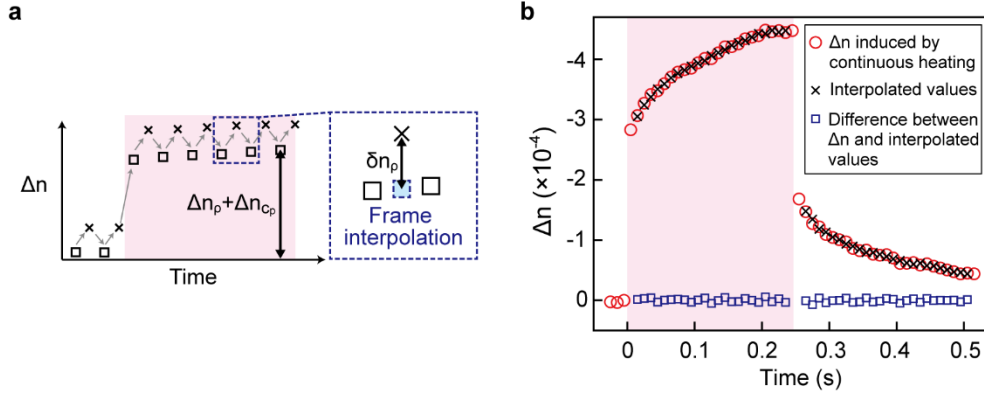

Fig. S11 Frame interpolation method. **a** Illustrative depiction of the method. **b** Validation of canceling a slowly varying effect by the frame interpolation method. The red circles present Δn inside a cell during continuous heating. The black crosses show the interpolated values $(\Delta n(t + 0.01 s) + \Delta n(t - 0.01 s))/2$, and the blue squares exhibit the difference between Δn and the interpolated values.

Supplementary Note 12: Minor correction of ΔT by eliminating a slowly varying effect on dn/dT caused by a change in dry mass concentration.

We derived ΔT by temperature dependence of dn/dT , but a change in dry mass concentration (c_p) also minorly affect. To see this effect, we first break the slowly varying component of Δn into $\Delta n_\rho + \Delta n_{c_p}$ and see Δn_{c_p} is the dominant factor. As shown with the black squares in Fig. 3b, Δn varies over $\sim 8 \times 10^{-4}$ (from -4×10^{-4} to 4×10^{-4}) during continuous heating. Black circles in Fig. S12 show the subtraction between impulsive heating on and off, leading to ΔT evaluated through δn_ρ . The time variation of ΔT shows almost constant rise of 5K with a slight increase by $\sim 0.5K$ indicated by red arrows. If we assume this slight temperature increase was due to Δn_ρ , the expected value would be $\sim 5 \times 10^{-5}$ calculating with the thermo-optic coefficient of $\sim 1 \times 10^{-4}$. Since this value is more than an order of magnitude smaller than Δn variation of $\sim 8 \times 10^{-4}$, we can conclude that Δn_{c_p} is the dominant factor of the slowly varying component of Δn .

Next, we evaluate dn/dT variation caused by Δn_{c_p} . The dn/dT of homogeneous solids and liquids can be written as $dn/dT \propto (n^2 - 1) \times (n^2 + 2)/6n^2$ as reported in literature⁴. The Taylor expansion around n leads to

$$\left(\frac{dn}{dT}\right)_{n+\Delta} = \left(\frac{dn}{dT}\right)_n + \beta \Delta \quad (\text{Eq. S1}),$$

Where Δ is a slight deviation of n , and β is a constant value. The cellular RI can be written by the summation of RI of water (n_{water}) and RI increment due to dry mass concentration (n_{c_p})⁵, $n_{\text{cell}} = n_{\text{water}} + n_{c_p}$. Therefore, the intracellular dn/dT may be written as

$$\left(\frac{dn}{dT}\right)_{\text{cell}} = \left(\frac{dn}{dT}\right)_{\text{water}} + \beta n_{c_p} \quad (\text{Eq. S2})$$

Since the intracellular dn/dT is 1.1-fold larger than that of water, as shown in Supplementary Note 13, Eq. S2 can be expressed as

$$\left(\frac{dn}{dT}\right)_{\text{cell}} = 1.1 \times \left(\frac{dn}{dT}\right)_{\text{water}} \quad (\text{Eq. S3}).$$

From Eqs. S2 and S3, we obtain

$$\beta = 0.1 \times (dn/dT)_{\text{water}}/n_{c_p} \quad (\text{Eq. S4}).$$

Now, we consider the time variation of dn/dT during continuous heating. Since time variation of RI can be written as $n_{\text{cell(heating)}} = n_{\text{cell}} + \Delta n_{c_p}(t)$, dn/dT can be written as

$$\left(\frac{dn}{dT}\right)_{\text{cell(heating)}} = \left(\frac{dn}{dT}\right)_{\text{cell}} + \beta \Delta n_{c_p}(t)$$

By substituting Eqs. S3 and S4, we obtain

$$\left(\frac{dn}{dT}\right)_{\text{cell(heating)}} = \left(\frac{dn}{dT}\right)_{\text{cell}} \left(1 + \frac{0.1}{1.1} \times \frac{\Delta n_{c_p}(t)}{n_{c_p}}\right) \quad (\text{Eq. S5})$$

The Equation S5 suggests that the ratio of the intracellular dn/dT with and without heating can be derived from the ratio of the dry mass concentration with and without heating ($\Delta n_{c_p}(t)/n_{c_p}$). Note that we can experimentally evaluate n_{c_p} from the RI image without heating.

The blue solid line in Fig. S12 represents the rate of time variation of dn/dT induced by $\Delta n_{c_p}(t)$. The red circles show a time variation of ΔT after eliminating this effect, which is obtained by dividing ΔT before correction (black circles) by the time variation of dn/dT (blue solid line).

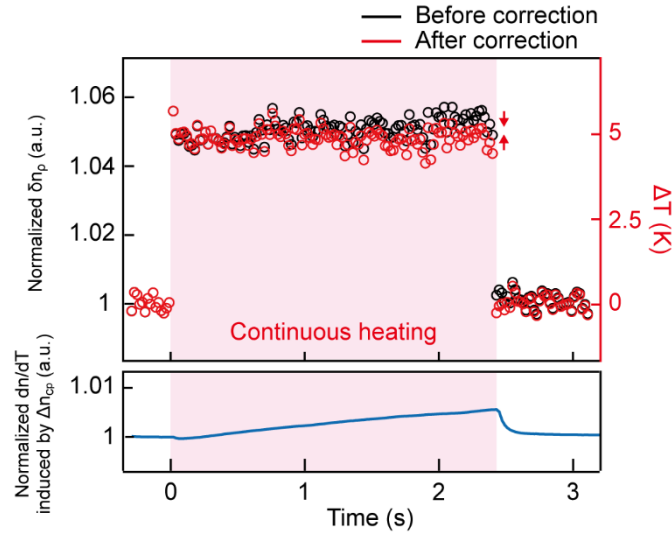

Fig. S12 Correction of ΔT to eliminate minor effects arising from Δc_p . The top panel shows normalized δn_ρ and corresponding time variation of ΔT during continuous heating. The black and red circles represent measured data before and after the correction. The bottom panel shows the time variation of dn/dT induced by Δc_p normalized by the value before heating (blue line).

Supplementary Note 13: Experimental validation of intracellular thermo-optic coefficient.

We experimentally validate the intracellular thermo-optic coefficient, dn/dT , by comparing the z-axis integration of heat-induced RI change of a cell to that of water. The RI change right after heating, which is before being affected by thermal diffusion, can be expressed as

$$\delta n_{\rho} = \frac{dn}{dT} \frac{\phi}{c\rho},$$

where ϕ , c , and ρ represent the total absorbed energy of IR photons, the specific heat capacity, and the density of the sample. Since the value of the specific heat capacity times density $c\rho$ of a cell ($4,210 \text{ J/K cm}^3$) is very close to that of water ($4,180 \text{ J/K cm}^3$), the difference in the evaluated value between water and the cell can be attributed to the difference in dn/dT under the condition that the same amount of IR light is absorbed. To ensure this condition and avoid the effect of thermal diffusion, we employed the ns pump-probe imaging method with IR pulses at a wavenumber of $3,150 \text{ cm}^{-1}$ and VIS pulses with a delay set to 200 ns. Our experimental comparison revealed that the intracellular dn/dT was 1.1-fold larger than that of water. This difference could arise from the RI difference between a cell and water due to the dry mass concentration because dn/dT is known to depend on the RI with a relation of $dn/dT \propto (n^2 - 1) \times (n^2 + 2)/6n$ as reported in literature⁴. We also confirmed that the experimentally obtained 1.1-fold larger dn/dT of a cell than water showed a good agreement with a theoretical estimation with this equation using a cellular RI of 1.36, which was derived from RI increment due to proteins (0.19 l/mg)⁶ and dry mass concentration in a typical cell ($\sim 0.15 \text{ g/ml}$)⁷.

Supplementary Note 14: Calibration curve of δn_{ρ} on ΔT .

Figure S13 shows an experimentally measured linear dependence of normalized δn_{ρ} on ΔT .

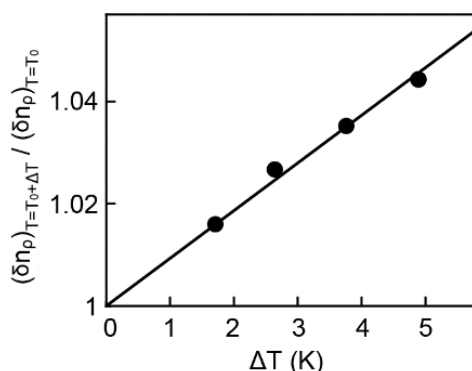

Fig. S13 An experimentally measured linear dependence of normalized δn_{ρ} on ΔT .

Supplementary Note 15: Measured ΔT for a cell showing a different time variation in Δn_{c_p} from that represented in Fig. 3.

Figure S14 illustrates the time variation of ΔT for a cell that exhibits a distinct characteristic of Δn_{c_p} variation as compared to that displayed in Fig. 3. The time variation of ΔT shows good agreement with that shown in Fig. 3,

verifying that measured ΔT does not majorly depend on Δn_{c_p} . Note that Δn_{c_p} slightly affects ΔT as explained in Supplementary Note 12.

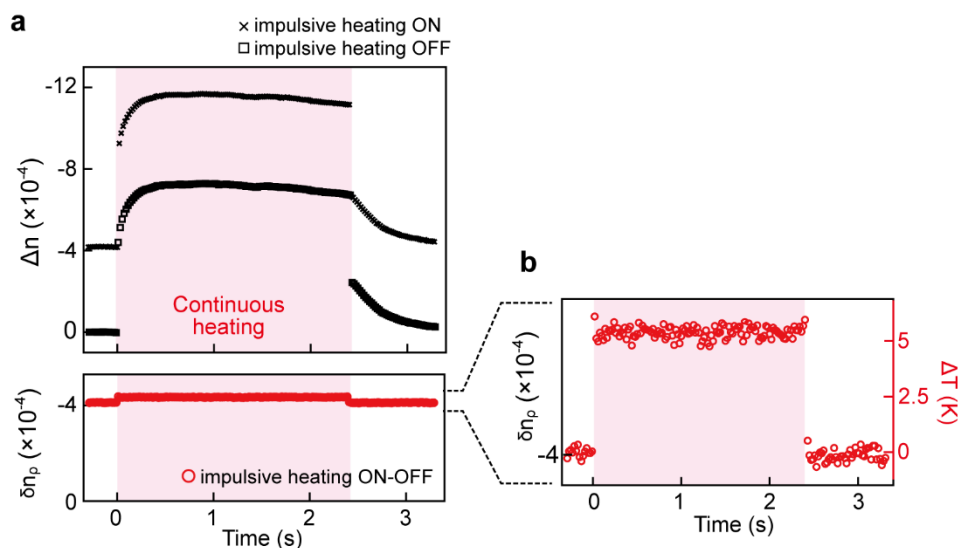

Fig. S14 ΔT measurement for a cell that exhibits a different temporal evolution in Δn_{c_p} from that represented in Fig. 3. a A temporal evolution of Δn under continuous heating together with (black crosses) and without (black squares) the impulsive heating, and their difference, δn_p (red circles) **b** ΔT evolution induced by continuous heating measured by MIP-ODT.

Reference

1. Bashkatov, A. *et al.* Water refractive index in dependence on temperature and wavelength: a simple approximation. in *SPIE 5068, Saratov Fall Meeting 2002* 393–395 (2003).
2. Uchiyama, S. *et al.* A cationic fluorescent polymeric thermometer for the ratiometric sensing of intracellular temperature. *Analyst* **140**, 4498–4506 (2015).
3. Toda, K. *et al.* Label-free intracellular thermophoretic imaging. Manuscript in preparation.
4. Andika, M. *et al.* Excitation temporal pulse shape and beam size on pulsed photothermal lens of single particle *JOSA B* **27**, 796–805 (2010).
5. Popescu, G. *et al.* Optical imaging of cell mass and growth dynamics. *Am. J. Physiol. - Cell Physiol.* **295**, 538–544 (2008).
6. Zhao, H. *et al.* On the distribution of protein refractive index increments. *Biophys. J.* **100**, 2309–2317 (2011).
7. Oh, S. *et al.* Protein and lipid mass concentration measurement in tissues by stimulated Raman scattering microscopy. *Proc. Natl. Acad. Sci. U. S. A.* **119**, 1–11 (2022).