



Phase-Bounded Broadcast Networks over Topologies of Communication

Lucie Guillou  

IRIF, CNRS, Université Paris Cité, France

Arnaud Sangnier  

DIBRIS, Università di Genova, Italy

Nathalie Sznajder  

LIP6, CNRS, Sorbonne Université, France

Abstract

We study networks of processes that all execute the same finite state protocol and that communicate through broadcasts. The processes are organized in a graph (a *topology*) and only the neighbors of a process in this graph can receive its broadcasts. The coverability problem asks, given a protocol and a state of the protocol, whether there is a topology for the processes such that one of them (at least) reaches the given state. This problem is undecidable [6]. We study here an under-approximation of the problem where processes alternate a bounded number of times k between phases of broadcasting and phases of receiving messages. We show that, if the problem remains undecidable when k is greater than 6, it becomes decidable for $k = 2$, and EXPSpace-complete for $k = 1$. Furthermore, we show that if we restrict ourselves to line topologies, the problem is in P for $k = 1$ and $k = 2$.

2012 ACM Subject Classification Theory of computation → Formal languages and automata theory

Keywords and phrases Parameterized verification, Coverability, Broadcast Networks

Digital Object Identifier 10.4230/LIPIcs...

Funding *Lucie Guillou*: ANR project PaVeDyS (ANR-23-CE48-0005)

1 Introduction

Verifying networks with an unbounded number of entities. Ensuring safety properties for concurrent and distributed systems is a challenging task, since all possible interleavings must be taken into account; hence, even if each entity has a finite state behavior, the verification procedure has to deal with the state explosion problem. Another level of difficulty arises when dealing with distributed protocols designed for an unbounded number of entities. In that case, the safety verification problem consists in ensuring the safety of the system, for any number of participants. Here, the difficulty comes from the infinite number of possible instantiations of the network. In their seminal paper [13], German and Sistla propose a formal model to represent and analyze such networks: in this work, all the processes in the network execute the same protocol, given by a finite state automaton, and they communicate thanks to pairwise synchronized rendez-vous. The authors study the parameterized coverability problem, which asks whether there exists an initial number of processes that allow an execution leading to a configuration in which (at least) one process is in an error state (here the parameter is the number of processes). They show that it is decidable in polynomial time. Later on, different variations of this model have been considered, by modifying the communication means: token-passing mechanism [1, 5], communication through shared register [8, 11], non-blocking rendez-vous mechanism [14], or adding a broadcast mechanism to send a message to all the entities [9]. The model of population protocol proposed in [2] and for which verification methods have been developed recently in [10, 12] belongs also to this family of systems. In this latter model, the properties studied are different, and more complex than safety conditions.



© L. Guillou and A. Sangnier and N. Sznajder;
licensed under Creative Commons License CC-BY 4.0



Leibniz International Proceedings in Informatics
Schloss Dagstuhl – Leibniz-Zentrum für Informatik, Dagstuhl Publishing, Germany

Broadcast networks working over graphs. In [6], Delzanno et. al propose a new model of parameterized network in which each process communicates *with its neighbors* by broadcasting messages. The neighbors of an entity are given thanks to a graph: the *communication topology*. This model was inspired by ad hoc networks, where nodes communicate with each other thanks to radio communication. The difficulty in proving safety properties for this new model lies in the fact that one has to show that the network is safe for all possible numbers of processes and all possible communication topologies. So the verification procedure not only looks for the number of entities, but also for a graph representing the relationship of the neighbours to show unsafe execution. As mentioned earlier, it is not the first work to propose a parameterized network with broadcast communication; indeed the parameterized coverability problem in networks with broadcast is decidable [9] and non-primitive recursive [23] when the communication topology is complete (each entity is a neighbor of all the others). However, when there is no restriction on the allowed communication topologies the problem becomes undecidable [6] but decidability can be regained by providing a bound on the length of all simple paths in allowed topologies [6]. This restriction has then been extended in [7] to allow also cliques in the model. However, with this restriction, the complexity of parameterized coverability is non-primitive recursive [7].

Bounding the number of phases. When dealing with infinite-state systems with an undecidable safety verification problem, one option consists in looking at under-approximations of the global behavior, restricting the attention to a subset of executions. If proving whether the considered subset of executions is safe is a decidable problem, this technique leads to a sound but incomplete method for safety verification. Good under-approximation candidates are the ones that can be extended automatically to increase the allowed behavior. For instance, it is known that safety verification of finite systems equipped with integer variables that can be incremented, decremented, or tested to zero is undecidable [18], but if one considers only executions in which, for each counter, the number of times the execution alternates between an increasing mode and a decreasing mode is bounded by a given value, then safety verification becomes decidable [15]. Similarly, verifying concurrent programs manipulating stacks is undecidable [21] but decidability can be regained by bounding the number of allowed context switches (a context being a consecutive sequence of transitions performed by the same thread) [19]. Context-bounded analysis has also been applied to concurrent programs with stacks and dynamic creation of threads [3]. Another type of underapproximation analysis has been conducted by [16] (and by [4] in another context), by considering bounded round-robin schedules of processes. Inspired by this work, we propose here to look at executions of broadcast networks over communication topologies where, for each process, the number of alternations between phases where it broadcasts messages and phases where it receives messages is bounded. We call such protocols *k*-phase-bounded protocols where *k* is the allowed number of alternations.

Our contributions. We study the parameterized coverability problem for broadcast networks working over communication topologies. We first show in Section 2 that it is enough to consider only tree topologies. This allows us to ease our presentation in the sequel and is also an interesting result by itself. In Section 3, we prove that the coverability problem is still undecidable when considering *k*-phase-bounded broadcast protocols with *k* greater than 6. The undecidability proof relies on a technical reduction from the halting problem for two counter Minsky machines. We then show in Sections 4 and 5 that if the number of alternations is smaller or equal to 2, then decidability can be regained. More precisely, we show that for 1-phase-bounded protocols, we can restrict our attention to tree topologies of height 1, which provides an EXPSPACE-algorithm for the coverability problem. To solve

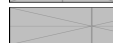

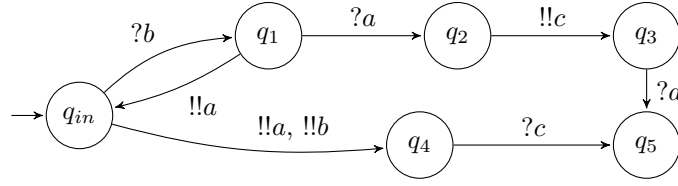

■ **Figure 1** Example of a broadcast protocol denoted P

this problem in the case of 2-phase-bounded protocols, we prove that we can bound the height of the considered tree and rely on the result of [6] which states that the coverability problem for broadcast networks is decidable when considering topologies where the length of all simple paths is bounded. We furthermore show that if we consider line topologies then the coverability problem restricted to 1- and 2-phase-bounded protocols can be solved in polynomial time.

Due to lack of space, omitted proofs and reasonings can be found in Appendix.

2 Preliminaries

Let A be a countable set, we denote A^* as the set of finite sequences of elements taken in A . Let $w \in A^*$, the length of w is defined as the number of elements in the sequence w and is denoted $|w|$. For a sequence $w = a_1 \cdot a_2 \cdots a_k \in A^+$, we denote by $w[-1]$ the sequence $a_1 \cdot a_2 \cdots a_{k-1}$. Let $\ell, n \in \mathbb{N}$ with $\ell \leq n$, we denote by $[\ell, n]$ the set of integers $\{\ell, \ell + 1, \dots, n\}$.

2.1 Networks of processes

We study networks of processes where each process executes the same protocol given as a finite-state automaton. Given a finite set of messages Σ , a transition of the protocol can be labelled by three types of actions: (1) the broadcast of a message $m \in \Sigma$ with label $!!m$, (2) the reception of a message $m \in \Sigma$ with label $?m$ or (3) an internal action with a special label $\tau \notin \Sigma$. Processes are organised according to a topology which gives for each one of them its set of neighbors. When a process broadcasts a message $m \in \Sigma$, the only processes that can receive m are its neighbors, and the ones having an output action $?m$ have to receive it. Furthermore, the topology remains fixed during an execution.

Let Σ be a finite alphabet. In order to refer to the different types of actions, we write $!!\Sigma$ for the set $\{!!m \mid m \in \Sigma\}$ and $?\Sigma$ for $\{?m \mid m \in \Sigma\}$.

► **Definition 2.1.** A Broadcast Protocol is a tuple $P = (Q, \Sigma, q_{in}, \Delta)$ such that Q is a finite set of states, Σ is a finite alphabet of messages, q_{in} is an initial state and $\Delta \subseteq Q \times (!!\Sigma \times ?\Sigma \cup \{\tau\}) \times Q$ is a finite set of transitions.

We depict an example of a broadcast protocol in Figure 1. Processes are organised according to a topology, defined formally as follows.

► **Definition 2.2.** A topology is an undirected graph, i.e. a tuple $\Gamma = (V, E)$ such that V is a finite set of vertices, and $E \subseteq V \times V$ is a finite set of edges such that $(u, v) \in E$ implies $(v, u) \in E$ for all $(u, v) \in V^2$, and for all $u \in V$, $(u, u) \notin E$ (there is no self-loop).

We will use $V(\Gamma)$ and $E(\Gamma)$ to denote the set of vertices and edges of Γ respectively, namely V and E . For $v \in V$, we will denote $N_\Gamma(v)$ the set $\{u \mid (v, u) \in E\}$. When the context is



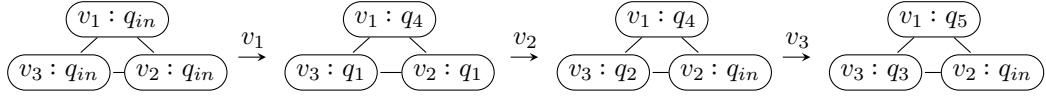

■ **Figure 2** Example of an execution of protocol P (Figure 1).

clear, we will write $\mathbf{N}(v)$. For $u, v \in \mathbf{V}(\Gamma)$, we denote $\langle v, u \rangle$ for the two pairs $(v, u), (u, v)$. We name **Graphs** the set of topologies. In this work, we will also be interested in some families of topologies: line and tree topologies. A topology $\Gamma = (V, E)$ is a *tree topology* if V is a set of words of \mathbb{N}^* which is prefix closed with $\epsilon \in V$, and if $E = \{\langle w[-1], w \rangle \mid w \in V \cap \mathbb{N}^+\}$. This way, the *root* of the tree is the unique vertex $\epsilon \in V$ and a node $w \in V \cap \mathbb{N}^+$ has a unique parent $w[-1]$. The *height* of the tree is $\max\{n \in \mathbb{N} \mid |w| = n\}$. We denote by **Trees** the set of tree topologies. A topology $\Gamma = (V, E)$ is a *line topology* if V is such that $V = \{v_1, \dots, v_n\}$ for some $n \in \mathbb{N}$ and $E = \{\langle v_i, v_{i+1} \rangle \mid 1 \leq i < n\}$. We denote by **Lines** the set of line topologies.

Semantics. A *configuration* C of a broadcast protocol $P = (Q, \Sigma, q_{in}, \Delta)$ is a tuple (Γ, L) where Γ is a topology, and $L : \mathbf{V}(\Gamma) \rightarrow Q$ is a labelling function associating to each vertex v of the topology its current state of the protocol. In the sequel, we will sometimes call processes or nodes the vertices of Γ . A configuration C is *initial* if $L(v) = q_{in}$ for all $v \in \mathbf{V}(\Gamma)$. We let \mathcal{C}_P be the set of all configurations of P , and \mathcal{I}_P the set of all initial configurations. When P is clear from the context, we may drop the subscript and simply use \mathcal{C} and \mathcal{I} . Given a protocol $P = (Q, \Sigma, q_{in}, \Delta)$, and a state $q \in Q$, we let $R(q) = \{m \in \Sigma \mid \exists q' \in Q, (q, ?m, q') \in \Delta\}$ be the set of messages that can be received when in the state q .

Consider $\delta = (q, \alpha, q') \in \Delta$ a transition of P , and $C = (\Gamma, L)$ and $C' = (\Gamma', L')$ two configurations of P , and let $v \in \mathbf{V}(\Gamma)$ be a vertex. The transition relation $\xrightarrow{v, \delta} \in \mathcal{C} \times \mathcal{C}$ is defined as follows: we have $C \xrightarrow{v, \delta} C'$ if and only if $\Gamma = \Gamma'$, and one of the following conditions holds:

- $\alpha = \tau$ and $L(v) = q, L'(v) = q'$ and $L'(u) = L(u)$ for all $u \in \mathbf{V}(\Gamma) \setminus \{v\}$: vertex v performs an internal action;
- $\alpha = !!m$ and $L(v) = q, L'(v) = q'$ (vertex v performs a broadcast), and for each process $u \in \mathbf{N}(v)$ neighbor of v , either $(L(u), ?m, L'(u)) \in \Delta$ (vertex u receives message m from v), or $m \notin R(L(u))$ and $L(u) = L'(u)$ (vertex u is not in a state in which it can receive m and stays in the same state). Furthermore, $L'(w) = L(w)$ for all other vertices $w \in \mathbf{V}(\Gamma) \setminus (\{v\} \cup \mathbf{N}(v))$ (vertex w does not change state).

We write $C \rightarrow C'$ whenever there exists $v \in \mathbf{V}(\Gamma)$ and $\delta \in \Delta$ such that $C \xrightarrow{v, \delta} C'$. We denote by \rightarrow^* [resp. \rightarrow^+] for the reflexive and transitive closure [resp. transitive] of \rightarrow . An *execution* of P is a sequence of configurations $C_0, \dots, C_n \in \mathcal{C}_P$ such that for all $0 \leq i < n$, $C_i \rightarrow C_{i+1}$.

► **Example 2.3.** We depict in Figure 2 an execution of protocol P (from Figure 1): it starts with an initial configuration with three processes v_1, v_2, v_3 , organised as a clique (each vertex is a neighbour of the two others), each on the initial state q_{in} . More formally, $\Gamma = (V, E)$ with $V = \{v_1, v_2, v_3\}$ and $E = \{\langle v_1, v_2 \rangle, \langle v_2, v_3 \rangle, \langle v_1, v_3 \rangle\}$. From the initial configuration, the following chain of events happens: $C_0 \xrightarrow{v_1, (q_{in}, !!b, q_4)} C_1 \xrightarrow{v_2, (q_1, !!a, q_{in})} C_2 \xrightarrow{v_3, (q_2, !!c, q_3)} C_3$.

2.2 Verification problem

In this work, we focus on the *coverability problem* which consists in ensuring a safety property: we want to check that, no matter the number of processes in the network, nor the topology



in which the processes are organised, a specific error state can never be reached.

The coverability problem over a family of topologies $\mathcal{S} \in \{\text{Graphs}, \text{Trees}, \text{Lines}\}$ is stated as follows:

| | |
|------------------------|--|
| COVER[\mathcal{S}] | |
| Input: | A broadcast protocol P and a state $q_f \in Q$; |
| Question: | Is there $\Gamma \in \mathcal{S}$, $C = (\Gamma, L) \in \mathcal{I}_P$ and $C' = (\Gamma, L') \in \mathcal{C}_P$ and $v \in V(\Gamma)$ such that $C \rightarrow^* C'$ and $L'(v) = q_f$? |

For a family \mathcal{S} , if indeed there exist $C = (\Gamma, L)$ and $C' = (\Gamma, L')$ such that $C \rightarrow^* C'$ and $L'(v) = q_f$ for some $v \in V(\Gamma)$, we say that q_f is *coverable* (in P) with Γ . We also say that the execution $C \rightarrow^* C'$ *covers* q_f . For short, we write COVER instead of COVER[Graphs]. Observe that COVER is a generalisation of COVER[Trees] which is itself a generalisation of COVER[Lines]. In [6], the authors proved that the three problems are undecidable, and they later showed in [7] that the undecidability of COVER still holds when restricting the problem to families of topologies with bounded diameter.

However, in [6], the authors show that COVER becomes decidable when searching for an execution covering q_f with a K -bounded path topology for some $K \in \mathbb{N}$, i.e. for a topology in which all simple paths between any pair of vertices $v_1, v_2 \in V$ have a length bounded by K . In [7], it is also shown that COVER is Ackermann-hard when searching for an execution covering q_f with a topology where all maximal cliques are connected by paths of bounded length. We establish the first result.

► **Theorem 2.4.** *COVER[Graphs] and COVER[Trees] are equivalent.*

Indeed, if it is obvious that when a state is coverable with a tree topology, it is coverable with a topology from Graphs, we can show that whenever a state is coverable, it is coverable with a tree topology. If a set q_f of a protocol P is coverable with a topology $\Gamma \in \text{Graphs}$, let $\rho = C_0 \rightarrow \dots \rightarrow C_n = (\Gamma, L_n)$ be an execution covering q_f , and a vertex $v_f \in V(\Gamma)$ such that $L_n(v_f) = q_f$. We can build an execution covering q_f with a tree topology Γ' where the root reaches q_f . Actually, Γ' is the unfolding of Γ in a tree of height n .

3 Phase-Bounded Protocols

As COVER[Graphs], COVER[Trees] and COVER[Lines] are undecidable in the general case, we investigate a restriction on broadcast protocols: phase-bounded protocols.

For $k \in \mathbb{N}$, a k -phase-bounded protocol is a protocol that ensures that each process alternates at most k times between phases of broadcasts and phases of receptions. Before giving our formal definition of a phase-bounded protocol, we motivate this restriction.

Phase-bounded protocols can be seen as a semantic restriction of general protocols in which each process can only switch a bounded number of times between phases where it receives messages and phases where it broadcasts messages. When, usually, restricting the behavior of processes immediately yields an underapproximation of the reachable states, we highlight in Appendix B the fact that preventing messages from being received can in fact lead to new reachable states. Actually, the reception of a message is something that is not under the control of a process. If another process broadcasts a message, a faithful behavior of the system is that all the processes that can receive it indeed do so, no matter in which phase they are in their own execution. Hence, in a restriction that attempts to limit the number of switches between broadcasting and receiving phases, one should not prevent a reception to happen. This motivates our definition of phase-bounded protocols, in which a

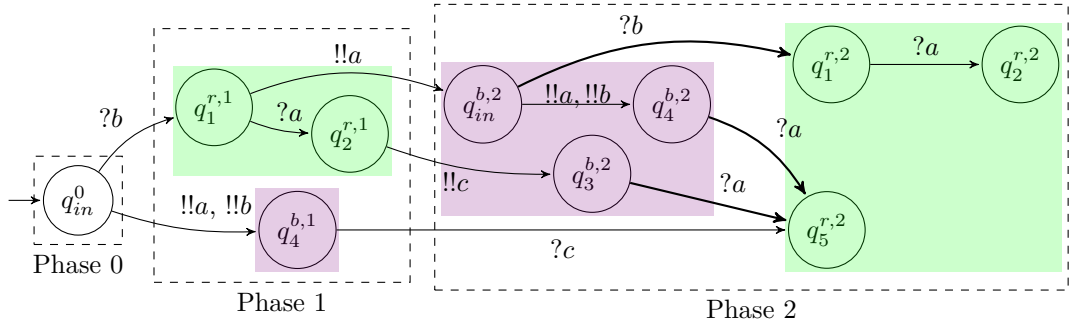

■ **Figure 3** P_2 : the 2-unfolding of protocol P (Figure 1).

process in its last broadcasting phase, can still receive messages. A k -unfolding of a protocol P is then a protocol in which we duplicate the vertices by annotating them with the type and the number of phase (b or r for broadcast or reception and an integer between 0 and k for the number).

► **Example 3.1.** Figure 3 pictures the 2-unfolding of protocol P (Figure 1). Observe that from state $q_4^{b,2}$, which is a broadcast state, it is still possible to receive message a and go to state $q_5^{r,2}$. However, it is not possible to send a message from $q_5^{r,2}$ (nor from any reception state of phase 2).

We show in Appendix that this definition of unfolding can be used as an underapproximation for COVER. In the remaining of the paper, we study the verification problems introduced in Section 2.2 when considering phase-bounded behaviors. We turn this restriction into a syntactic one over the protocol, defined as follows.

► **Definition 3.2.** Let $k \in \mathbb{N}$. A broadcast protocol $P = (Q, \Sigma, q_{in}, \Delta)$ is k -phase-bounded if Q can be partitioned into $2k + 1$ sets $\mathcal{Q} = \{Q_0, Q_1^b, Q_1^r, \dots, Q_k^b, Q_k^r\}$, such that $q_{in} \in Q_0$ and for all $(q, \alpha, q') \in \Delta$ one of the following conditions holds:

1. there exist $0 \leq i \leq k$ and $\beta \in \{r, b\}$ such that $q, q' \in Q_i^\beta$ and $\alpha = \tau$ (for ease of notation, we take $Q_0 = Q_0^b = Q_0^r$);
2. there exists $1 \leq i \leq k$ such that $q, q' \in Q_i^b$ and $\alpha \in !!\Sigma$;
3. there exists $1 \leq i \leq k$ such that $q, q' \in Q_i^r$ and $\alpha \in ?\Sigma$;
4. there exists $0 \leq i < k$ such that $q \in Q_i^b$, $q' \in Q_{i+1}^r$ and $\alpha \in ?\Sigma$;
5. there exists $0 \leq i < k$ such that $q \in Q_i^r$, $q' \in Q_{i+1}^b$ and $\alpha \in !!\Sigma$;
6. $q \in Q_k^b$, $q' \in Q_k^r$ and $\alpha \in ?\Sigma$

A protocol P is phase-bounded if there exists $k \in \mathbb{N}$ such that P is k -phase-bounded.

► **Example 3.3.** Observe that the protocol P displayed in Figure 1 is not phase-bounded: by definition, it holds that $Q_0 = \{q_{in}\}$, and $q_1 \in Q_1^r$ (because of the transition $(q_{in}, ?b, q_1)$). As a consequence $q_{in} \in Q_2^b$, because of the transition $(q_1, !!a, q_{in})$. This contradicts the fact that $Q_2^b \cap Q_0 = \emptyset$. Intuitively, P does not ensure that every vertex alternates at most a bounded number of times between receptions and broadcasts, in particular, for any integer $k \in \mathbb{N}$, it might be that there exists an execution where a process alternates $k + 1$ times between reception of a message b from state q_{in} , and broadcast of a message a from state q_1 . Removing the transition $(q_1, !!a, q_{in})$ from P would give a 2-phase-bounded protocol P' : $Q_0 = \{q_{in}\}$, $Q_1^r = \{q_1, q_2\}$, $Q_1^b = \{q_4\}$, $Q_2^b = \{q_3\}$ and $Q_2^r = \{q_5\}$.

The following table summarizes our results (PB stands for phase-bounded).

| | 1-PB Protocols | 2-PB Protocols | PB Protocols |
|---------------|-----------------------|----------------|------------------------------------|
| COVER[Lines] | $\in P$ (Section 6.2) | | Undecidable ($k \geq 4$) (Sec 4) |
| COVER[Graphs] | EXPSpace-complete | Decidable | Undecidable ($k \geq 6$) |
| COVER[Trees] | (Section 5) | (Section 6.1) | (Section 4) |

4 Undecidability Results

We prove that COVER restricted to k -phase-bounded protocols (with $k \geq 6$) is undecidable by a reduction from the halting problem of a Minsky machine [18]: a Minsky machine is a finite-state machine (whose states are called locations) with two counters, x_1 and x_2 (two variables that take their values in \mathbb{N}). Each transition of the machine is associated with an instruction: increment one of the counters, decrement one of the counters or test if one of the counters is equal to 0. The halting problem asks whether there is an execution that ends in the halting location. In a first step, the protocol will enforce the selection of a line of nodes from the topology. All other nodes will be inactive. In a second step, the first node of the line (that we call the head) visits the different states of the machine during an execution, while all other nodes (except the last one) simulate counters' values: they are either in a state representing value 0, or a state representing x_1 (respectively x_2). The number of processes on states representing x_1 gives the actual value of x_1 in the execution. The last node (called the tail) checks that everything happens as expected. When the head has reached the halting location of the machine, it broadcasts a message which is received and forwarded by each node of the line until the tail receives it and reaches the final state to cover.

When the head of the line simulates a transition of the machine, it broadcasts a message (the instruction for one of the counters), which is transmitted by each node of the line until the tail receives it. A classical way of forwarding the message through receptions and broadcasts would not give a phase-bounded protocol. Hence, during the transmission, the tail only receives messages and all other nodes only broadcast and do not receive any message. The main idea is that we do not use the reception of messages to move into the next state of the execution but to detect errors (and in that case, go to a bad sink state from which the process can not do anything). The processes will have to guess the correct message to send, and the correct instant to send it, otherwise some of them will go to the sink state upon the reception of this "wrong" message. Hence, when everyone makes the correct guesses, the only reception that occurs in the transmission is done by the tail process, whereas when someone makes an incorrect guess, a process goes to a bad state with a reception. In the reduction, if the halting state of the Minsky Machine is not reachable, there will be no way to make a correct guess that allows to cover the final state. In the next subsection, we explain how this is achieved. To do so, we explain the mechanism by abstracting away the actual instruction, and just show how to transmit a message.

4.1 Propagating a message using only broadcasts in a line

In a line, a node has at most two neighbors, but cannot necessarily distinguish between the two (its left and its right one). To do so, nodes broadcast messages with subscript 0, 1 or 2, and we ensure that: if a node broadcasts with subscript 1, its right [resp. left] neighbor broadcasts with subscript 0 [resp. subscript 2]. Similarly, if a node broadcasts with subscript 0 [resp. 2], its right neighbor broadcasts with subscript 2 [resp. 1] and its left one with subscript 1 [resp. 0].



© L. Guillou and A. Sangnier and N. Sznajder;
licensed under Creative Commons License CC-BY 4.0



Leibniz International Proceedings in Informatics
Schloss Dagstuhl – Leibniz-Zentrum für Informatik, Dagstuhl Publishing, Germany

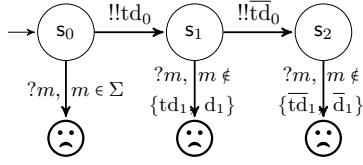

■ Figure 4 Protocol P_h executed by v_0 .

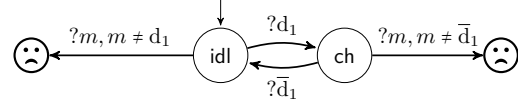

■ Figure 5 Protocol P_t executed by v_n .

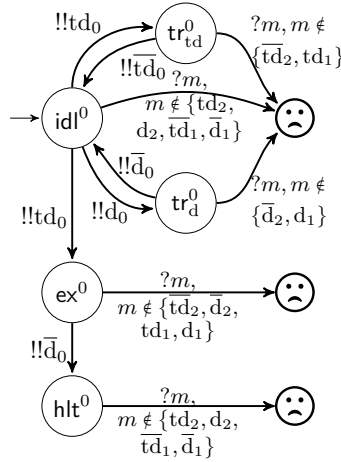

■ Figure 6 P_0 .

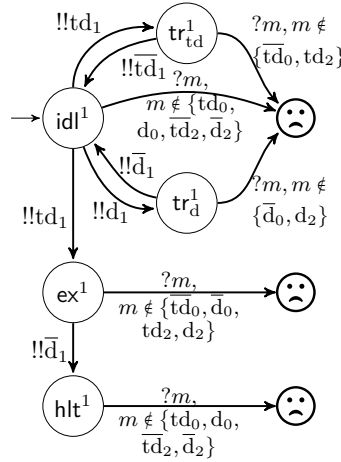

■ Figure 7 P_1 .

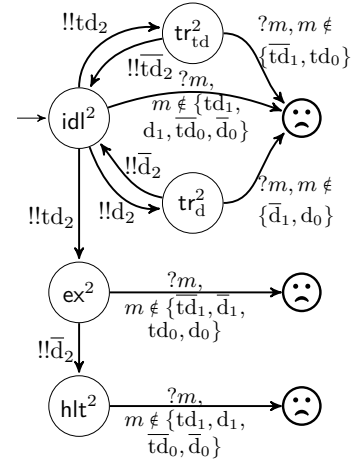

■ Figure 8 P_2 .

Consider the five protocols displayed in Figures 4–8. The states marked as initial are the ones from which a process enters the protocol. Protocol P_h is executed by the head of the line, P_t by the tail of the line and other nodes execute either P_0 , P_1 or P_2 . Observe that messages go by pairs: td_i, \bar{td}_i and d_i, \bar{d}_i for all $i \in \{0, 1, 2\}$.

The head broadcasts a request to be done with the pair of messages td_0, \bar{td}_0 . Each process in one of the P_i starts in idl^i and has a choice: either it transmits a message without executing it, or it “executes” it and tells it to the others. When it transmits a message not yet executed, it broadcasts the messages td_i and \bar{td}_i and visits states tr_{td}^i and idl^i . When it executes the request, it broadcasts the messages td_i and \bar{d}_i and visits states ex^i and hlt^i . Finally, when it transmits a request already done, it broadcasts the messages d_i and \bar{d}_i and visits states tr_d^i and idl^i . Once a process has executed the request (i.e. broadcast a pair td_j, \bar{d}_j for some $j \in \{0, 1, 2\}$), only pairs d_j, \bar{d}_j , with $j \in \{0, 1, 2\}$, are transmitted in the rest of the line.

Correct transmission of a request. Take for instance the configuration C_0 depicted in Figure 9 for $n = 5$ (i.e. there are six vertices). We say that a configuration is *stable* if the head is in s_0 or s_2 , the tail is in idl and other nodes are in idl^i or hlt^i for $i \in \{0, 1, 2\}$. Note that C_0 is stable. We depict a transmission in Figures 10a and 10b, starting from C_0 . We denote the successive depicted configurations C_0, C_1, \dots, C_{11} . Note that C_{11} is stable. Between C_0 and

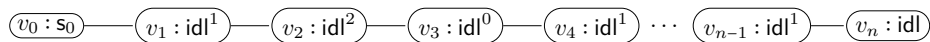

■ Figure 9 A configuration from which the transmission can happen: a node in state idl^i can only broadcast messages with subscript i .

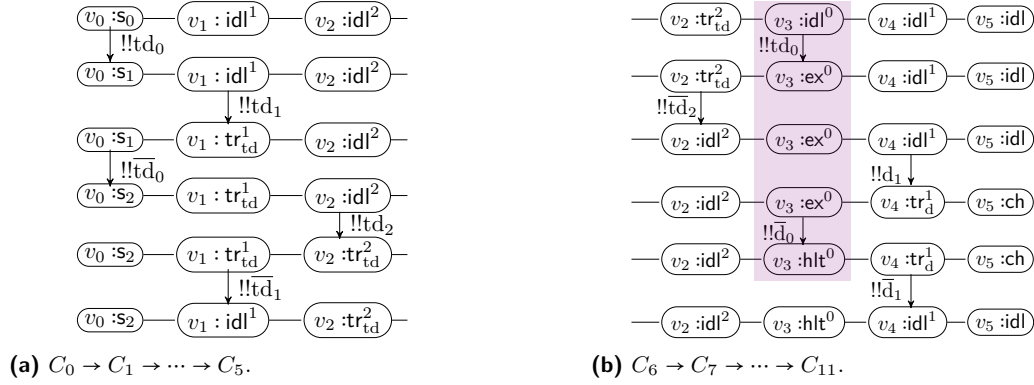

■ **Figure 10** Example of correct transmission.

C_{11} , the following happens: Between C_0 and C_3 , v_0 broadcasts the request with messages td_0 and \bar{td}_0 . Between C_1 and C_8 , v_1 and v_2 successively repeat the request to be done with messages td_1 and \bar{td}_1 for v_1 and td_2 \bar{td}_2 for v_2 . Between C_6 and C_{10} , v_3 executes the request by broadcasting messages td_0 and \bar{d}_0 . Between C_7 and C_{11} , v_4 transmits the done request with messages d_1 and \bar{d}_1 . Hence, the request is executed by exactly one vertex (namely v_3), as highlighted in Figure 10b. Observe that the processes sort of spontaneously emit broadcast to avoid to receive a message. A correct guess of when to broadcast yields the interleaving of broadcasts that we have presented in this example.

How to prevent wrong behaviors? Observe that, when a node is in state idl^1 , if one of its neighbor broadcasts a message which is not td_0, d_0 or \bar{td}_2, \bar{d}_2 , then the node in idl^1 reaches \ominus . We say that a process *fails* whenever it reaches \ominus . We have the following lemma:

► **Lemma 4.1.** *Let $C \in \mathcal{C}$ be a stable configuration such that $C_0 \rightarrow^+ C$. Then in C , it holds that v_0 is in s_2 , and there is exactly one vertex $v \in \{v_1, v_2, v_3, v_4\}$ on a state hlt^j for some $j \in \{0, 1, 2\}$.*

Indeed, let C be a *stable* configuration such that $C_0 \rightarrow^+ C$. It holds that:

1. *From C_0 , the first broadcast is from v_0 and it broadcasts td_0 .*
Indeed, if another vertex than v_0 broadcasts a message m with subscript i from C_0 , its left neighbor would fail with transition $(idl^j, ?m, \ominus)$ as $j = (i - 1) \bmod 3$ and $m \in \{td_i, d_i\}$. Let us consider an example depicted in Figure 11b: Assume v_1 is in state idl^1 and v_2 broadcasts td_2 or d_2 (it issues a request whereas v_1 is not broadcasting any request), then v_1 receives the message with transition that goes from idl^1 to \ominus , as depicted in Figure 7. Hence, we can not reach a stable configuration from there.
2. *Each vertex (except the tail) broadcasts one pair of messages between C_0 and C .*
Assume for instance that v_1 does not broadcast anything. From Item 1, v_0 broadcasts td_0 , and so at some point it will also broadcasts \bar{td}_0 otherwise it would not be in s_0 or s_2 in C . Hence v_1 fails as depicted in Figure 11a. Actually, each vertex (except the tail) broadcasts exactly one pair: if it broadcasts more, its left neighbor would fail as well.
3. *When a node broadcasts a pair (td_j, \bar{td}_j) , its right neighbor broadcasts either a pair (td_i, \bar{td}_i) or (td_i, \bar{d}_i) , for $j, i \in \{0, 1, 2\}$.*
Assume its right neighbor broadcasts d_i , it must be that $i = (j + 1) \bmod 3$. Such an example is depicted in Figure 11b: v_1 fails with $(tr_{td}^1, ?d_2, \ominus)$. Similarly, we have:
4. *When a node broadcasts a pair (td_j, \bar{d}_j) or a pair (d_j, \bar{d}_j) , its right neighbor broadcasts a pair (d_i, \bar{d}_i) , for $j, i \in \{0, 1, 2\}$.*



(a) v_1 does not transmit the request.

(b) v_2 broadcasts the wrong pair of messages.

■ **Figure 11** Example of wrong behaviors during the transmission.

4.2 Putting everything together

We adapt the construction of Section 4.1 to propagate operations on counters of the machine issued by the head of the line. Counters processes will evolve in three different protocols as in Section 4.1. They can be either in a zero state, from which all the types of instructions can be transmitted, or in a state 1_x for x one of the two counters, from which all the types of operations can be transmitted, except 0-tests of x . Increments and decrements of a counter x are done in a similar fashion as in Section 4.1 (exactly one node changes its state). 0-tests are somewhat easier: no node changes state nor executes anything, and the tail accepts the same pair as the one broadcast by the head. However, if a node is in a 1_x when x is the counter compared to 0, it fails when its left neighbor broadcasts the request.

We ensure that we can select a line with a similar structure as the one depicted in Figure 9 thanks to a first part of the protocol where each node: (i) receives an announcement message from its predecessor with a subscript j (except the head which broadcasts first), (ii) broadcasts an announcement message with the subscript $(j + 1) \bmod 3$ (head broadcasts with subscript 0) and (iii) waits for the announcement of its successor with subscript $(j + 2) \bmod 3$ (except for the tail). If it receives any new announcement at any point of its execution, it fails. When considering only line topologies, as each node has at most two neighbors, this part can be achieved with fewer alternations. We get the two following theorems.

► **Theorem 4.2.** *COVER and COVER[Trees] are undecidable for k -phase-bounded protocols with $k \geq 6$.*

► **Theorem 4.3.** *COVER[Lines] is undecidable for k -phase-bounded protocols with $k \geq 4$.*

5 Cover in 1-Phase-Bounded Protocols

We show that COVER[Graphs] restricted to 1-phase-bounded protocols is EXPSPACE-complete.

We begin by proving that for such protocols COVER[Graphs] and COVER[Stars] are equivalent (where Stars correspond to the tree topologies of height one). To get this property, we first rely on Theorem 2.4 (stating that COVER and COVER[Trees] are equivalent) and without loss of generality we can assume that if a control state can be covered with a tree topology, it can be covered by the root of the tree. We then observe that when dealing with 1-phase-bounded protocols, the behaviour of the processes of a tree which are located at a height strictly greater than 1 have no incidence on the root node. Indeed if a process at depth 2 performs a broadcast received by a node at depth 1, then this latter node will not be able to influence the state of the root because in 1-phase-bounded protocols, once a process has performed a reception, it cannot broadcast anymore. In the sequel we fix a 1-phase-bounded protocol $P = (Q, \Sigma, q_{in}, \Delta)$ and a state $q_f \in Q$. We then have:

► **Lemma 5.1.** *There exist $\Gamma \in \text{Graphs}$, $C = (\Gamma, L) \in \mathcal{I}_P$ and $D = (\Gamma, L') \in \mathcal{C}_P$ and $v \in V(\Gamma)$ such that $C \rightarrow^* D$ and $L'(v) = q_f$ iff there exists $\Gamma' \in \text{Stars}$, $C' = (\Gamma', L'') \in \mathcal{I}$ and $D' = (\Gamma', L''') \in \mathcal{C}_P$ such that $C' \rightarrow_P^* D'$ and $L'''(\epsilon) = q_f$.*

To solve COVER[Stars] in EXPSPACE, we proceed as follows (1) we first propose an abstract representation for the configurations reachable by executions where the root node does not perform any reception, and that only keeps track of states in Q_0 and Q_1^b (2) we show that we can decide in polynomial space whether a configuration corresponding to a given abstract representation can be reached from an initial configuration (3) relying on reduction to the control state reachability problem in VASS (Vector Addition System with States), we show how to decide whether there exists a configuration corresponding to a given abstract representation from which q_f can be covered in an execution where the root node does not perform any broadcast. This reasoning relies on the fact that a process executing a 1-phase-bounded protocol first performs only broadcast (or internal actions) and then performs only receptions (or internal actions).

We use Q^b to represent the set $Q_0 \cup Q_1^b$ and we say that a configuration $C = (\Gamma, L)$ in \mathcal{C}_P is a *star-configuration* whenever $\Gamma \in \text{Stars}$. For a star-configuration $C = (\Gamma, L)$ in \mathcal{C}_P such that $L(\epsilon) \in Q^b$, the *broadcast-print* of C , denoted by $\mathbf{bprint}(C)$, is the pair $(L(\epsilon), \{L(v) \in Q^b \mid v \in V(\Gamma) \setminus \{\epsilon\}\})$ in $Q^b \times 2^{Q^b}$. We call such a configuration C a *b-configuration*. Note that any initial star-configuration $C_{in} = (\Gamma_{in}, L_{in}) \in \mathcal{I}$ is a b-configuration verifying $\mathbf{bprint}(C_{in}) \in \{(q_{in}, \emptyset), (q_{in}, \{q_{in}\})\}$ (the first case corresponding to $V(\Gamma) = \{\epsilon\}$). We now define a transition relation \Rightarrow between broadcast-prints. Given (q, Λ) and (q', Λ') in $Q^b \times 2^{Q^b}$, we write $(q, \Lambda) \Rightarrow (q', \Lambda')$ if there exists two b-configurations C and C' such that $\mathbf{bprint}(C) = (q, \Lambda)$ and $\mathbf{bprint}(C') = (q', \Lambda')$ and $C \rightarrow C'$. We denote by \Rightarrow^* the reflexive and transitive closure of \Rightarrow .

One interesting point of this abstract representation is that we can compute in polynomial time the \Rightarrow -successor of a given broadcast-print. The intuition is simple: either the root performs a broadcast of $m \in \Sigma$, and in that case we have to remove from the set Λ all the states from which a reception of m can be done (as the associated processes in C' will not be in a state in Q^b anymore) or one process in a state of Λ performs a broadcast and in that case it should not be received by the root node (otherwise the reached configuration will not be a b-configuration anymore).

► **Lemma 5.2.** *Given $(q, \Lambda) \in Q^b \times 2^{Q^b}$, we can compute in polynomial time the set $\{(q', \Lambda') \mid (q, \Lambda) \Rightarrow (q', \Lambda')\}$.*

In order to show that our abstract representation can be used to solve COVER[Stars], we need to rely on some further formal definitions. Given two star-configurations $C = (\Gamma, L)$ and $C' = (\Gamma', L')$, we write $C \leq C'$ iff the two following conditions hold (i) $L(\epsilon) = L'(\epsilon)$, and, (ii) $|\{v \in V(\Gamma) \setminus \{\epsilon\} \mid L(v) = q\}| \leq |\{v \in V(\Gamma') \setminus \{\epsilon\} \mid L'(v) = q\}|$ for all $q \in Q^b$. We then have the following lemma where the two first points show that when dealing with star-configurations, the network generated by 1-phase-bounded protocol enjoys some monotonicity properties. Indeed, if the root node performs a broadcast received by other nodes, then if we put more nodes in the same state, they will also receive the message. On the other hand if it is another node that performs a broadcast, only the root node is able to receive it. The last point of the lemma shows that we can have as many processes as we want in reachable states in Q^b (as soon as the root node does not perform any reception) by duplicating nodes and mimicking behaviors.

► **Lemma 5.3.** *The following properties hold:*



© L. Guillou and A. Sangnier and N. Sznajder;
licensed under Creative Commons License CC-BY 4.0



Leibniz International Proceedings in Informatics

Schloss Dagstuhl – Leibniz-Zentrum für Informatik, Dagstuhl Publishing, Germany

- (i) If C_1, C'_1 and C_2 are star-configurations such that $C_1 \rightarrow C'_1$ and $C_1 \leq C_2$ then there exists a star-configuration C'_2 such that $C'_1 \leq C'_2$ and $C_2 \rightarrow^* C'_2$.
- (ii) If C_1, C'_1 and C_2 are b-configurations such that $C_1 \rightarrow C'_1$ and $\mathbf{bprint}(C_1) = \mathbf{bprint}(C_2)$ and $C_1 \leq C_2$ then there exists a b-configuration C'_2 such that $C'_1 \leq C'_2$ and $\mathbf{bprint}(C'_1) = \mathbf{bprint}(C'_2)$ and $C_2 \rightarrow^* C'_2$.
- (iii) If C is a b-configuration such that $C_{in} \rightarrow^* C$ for some initial configuration C_{in} then for all $N \in \mathbb{N}$, there exists an initial configuration C'_{in} and a b-configuration $C' = (\Gamma', L')$ such that $C'_{in} \rightarrow^* C'$ and $\mathbf{bprint}(C) = \mathbf{bprint}(C') = (q, \Lambda)$ and $|\{v \in V(\Gamma') \setminus \{\epsilon\} \mid L'(v) = q'\}| \geq N$ for all $q' \in \Lambda$.

We can now prove that we can reason in a sound and complete way with broadcast prints to characterise the b-configurations reachable from initial star-configurations. To prove this next lemma, we rely on the two last points of the previous lemma and reason by induction on the length of the \Rightarrow -path leading from (q_{in}, Λ_{in}) to (q, Λ) .

► **Lemma 5.4.** *Given $(q, \Lambda) \in Q^b \times 2^{Q^b}$, we have $(q_{in}, \Lambda_{in}) \Rightarrow^* (q, \Lambda)$ with $\Lambda_{in} \in \{\emptyset, \{q_{in}\}\}$ iff there exist two b-configurations $C_{in} \in \mathcal{I}$ and $C \in \mathcal{C}$ such that $C_{in} \rightarrow^* C$ and $\mathbf{bprint}(C) = (q, \Lambda)$.*

Finally, we show that we can verify in exponential space whether there exists a configuration with a given broadcast-print (q, Λ) from which we can reach a configuration covering q_f thanks to an execution where the root node does not perform any broadcast. This result is obtained by a reduction to the control state reachability problem in (unary) VASS which is known to be EXPSPACE-complete [17, 20]. VASS are finite state machines equipped with variables (called counters) taking their values in \mathbb{N} , and where each transition of the machine can either change the value of a counter, by incrementing or decrementing it, or do nothing. In our reduction, we encode the state of the root in the control state of the VASS and we associate a counter to each state of Q^b to represent the number of processes in this state. In a first phase, the VASS generates a configuration with (q, Λ) as broadcast-print and in a second phase it simulates the network. For instance, if a process performs a broadcast received by the root node, then we decrement the counter associated to the source state of the broadcast, we increment the one associated to the target state and we change the control state of the VASS representing the state of the root node accordingly. We need a last definition to characterise executions where the root node does not perform any broadcast: given two star-configurations $C = (\Gamma, L)$ and $C' = (\Gamma, L')$, we write $C \rightarrow_r C'$ whenever there exist $v \in V(\Gamma)$ and $\delta \in \Delta$ such that $C \xrightarrow{v, \delta} C'$ and either $v \neq \epsilon$ or $\delta = (q, \tau, q')$ for some $q, q' \in Q$. We denote by \rightarrow_r^* the reflexive and transitive closure of \rightarrow_r .

► **Lemma 5.5.** *Given $(q, \Lambda) \in Q^b \times 2^{Q^b}$, we can decide in EXPSPACE whether there exist a b-configuration $C = (\Gamma_f, L)$ and a star-configuration $C_f = (\Gamma_f, L_f)$ such that $\mathbf{bprint}(C) = (q, \Lambda)$ and $L_f(\epsilon) = q_f$ and $C \rightarrow_r^* C_f$.*

Combining the results of the previous lemmas leads to an EXPSPACE-algorithm to solve COVER[Stars]. We first guess a broadcast-print (q, Λ) and check in polynomial space whether it is \Rightarrow -reachable from an initial broadcast-print in $\{(q_{in}, \emptyset), (q_{in}, \{q_{in}\})\}$ thanks to Lemma 5.2 (relying on a non-deterministic polynomial space algorithm for reachability). Then we use Lemma 5.5 to check the existence of a b-configuration C with $\mathbf{bprint}(C) = (q, \Lambda)$ from which we can cover q_f . By Savitch's theorem [22], we conclude that the problem is in EXPSPACE. The completeness of this method is direct. For the soundness, we reason as follows: using Lemma 5.4, there exists a configuration C reachable from an initial star-configuration such that $\mathbf{bprint}(C) = (q, \Lambda)$, and by Lemma 5.5, there is a configuration C' such that $\mathbf{bprint}(C') = (q, \Lambda)$ from which we cover q_f . Thanks to Lemma 5.3.(iii), there is



a configuration C'' reachable from an initial configuration such that $C \leq C''$ and $C' \leq C''$ and $\mathbf{bprint}(C'') = (q, \Lambda)$. Thanks to Lemma 5.3.(i) applied to each transition, we can build an execution from C'' that covers q_f . The lower bound is obtained by a reduction from the control state reachability in VASS.

► **Theorem 5.6.** *COVER[Graphs] and COVER[Trees] are EXPSPACE-complete for 1-phase-bounded protocols.*

6 Decidability Results for 2-Phase-Bounded Protocols

6.1 Cover and Cover[Trees] are Decidable on 2-PB Protocols

A *simple path* between u and u' in a topology $\Gamma = (V, E)$ is a sequence of distinct vertices v_0, \dots, v_k such that $u = v_0$, $u' = v_k$, and for all $0 \leq i < k$, $(v_i, v_{i+1}) \in E$. Its length is denoted $d(v_0, \dots, v_k)$ and is equal to k . Given an integer K , we say that a topology Γ is K -bounded path (and we write $\Gamma \in K\text{-BP}$) if there is no simple path v_0, \dots, v_k such that $d(v_0, \dots, v_k) > K$. The result of this subsection relies on the following theorem.

► **Theorem 6.1** ([6], Theorem 5). *For $K \geq 1$, COVER[K-BP] is decidable.*

Hence, we show that if a state q_f of a protocol P is coverable with a tree topology, then q_f is actually coverable with a tree topology that is also $2(|Q| + 1)\text{-BP}$. To establish this result, consider a coverable state q_f of a protocol P with a tree topology Γ , such that Γ is minimal in the number of nodes needed to cover q_f . We can suppose wlog that q_f is covered by the root of the tree. We argue that all nodes (except maybe the root) in the execution covering q_f broadcast something, as otherwise they are useless and could then be removed. We also argue that, since P is 2-phase-bounded, a node that would first broadcast after the first broadcast of its father would also be useless for the covering of q_f : this broadcast will only be received by its father in its *last phase of reception*, hence it will have no influence on the behavior of the root. These two properties are the key elements needed to establish the following lemma.

► **Lemma 6.2.** *Let $P = (Q, \Sigma, q_{in}, \Delta)$ be a 2-phase-bounded protocol and $q_f \in Q$. If q_f can be covered with a tree topology, then it can be covered with a topology $\Gamma \in \text{Trees}$ such that, for all $u \in V(\Gamma)$, $|u| \leq |Q| + 1$.*

Indeed, a counting argument implies that if this is not the case, there exist two nodes u_1 and u_2 on the same branch, different from the root, with u_1 a prefix of u_2 , that both execute their first broadcast from the same state q . In this case, we could replace the subtree rooted in u_1 by the subtree rooted in u_2 , and still obtain an execution covering q_f . Once u_1 has reached q (possibly by receiving broadcasts from the children of u_2), it will behave as in the initial execution. Behaviors of the children of u_1 might differ in this second part, but it can only influence u_1 in its reception phase, which will be the last phase, and hence will not influence the behavior of the root. Thanks to Theorems 2.4 and 6.1, we can then conclude.

► **Theorem 6.3.** *COVER and COVER[Trees] are decidable for 2-phase-bounded protocols.*

6.2 Polynomial Time Algorithm for Cover[Lines] on 2-PB Protocols

In the rest of this section, we fix a 2-phase-bounded protocol $P = (Q, \Sigma, q_{in}, \Delta)$ and a state $q_f \in Q$ to cover. For an execution $\rho = C_0 \rightarrow C_1 \rightarrow \dots \rightarrow C_n$ with $C_n = (\Gamma, L_n)$, for all $v \in V(\Gamma)$, we denote by $b_{\text{first}}(v, \rho)$ the *smallest* index $0 \leq i < n$ such that $C_i \xrightarrow{v,t} C_{i+1}$ with

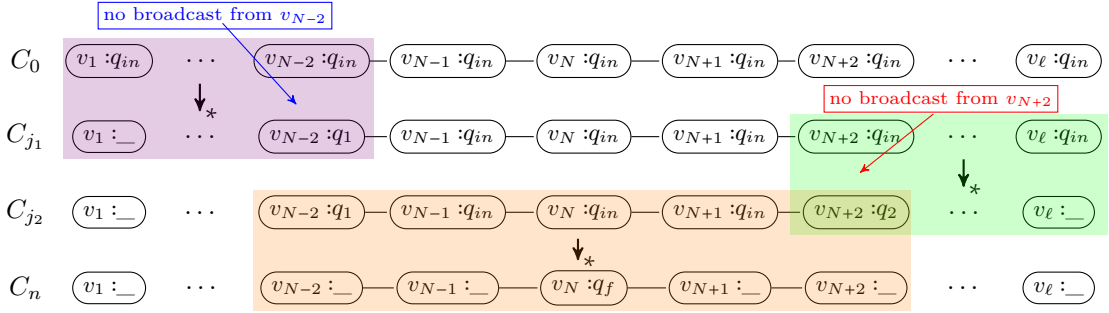

■ **Figure 12** Illustration of execution ρ obtained from Lemma 6.4.

$t = (q, !!m, q') \in \Delta$. If v never broadcasts anything, $b_{\text{first}}(v, \rho) = -1$. We also denote by $t_{\text{last}}(v, \rho)$ the *largest* index $0 \leq i < n$, such that $C_i \xrightarrow{v, t} C_{i+1}$ for some transition $t \in \Delta$. If v never issues any transition, we let $t_{\text{last}}(v, \rho) = -1$.

The polynomial time algorithm relies on the fact that to cover a state, one can consider only executions that have a specific shape, described in the following lemma.

► **Lemma 6.4.** *If q_f is coverable with a line topology Γ such that $V(\Gamma) = \{v_1, \dots, v_{\ell}\}$ then there exists an execution $\rho = C_0 \rightarrow C_1 \rightarrow \dots \rightarrow C_n$ such that $C_n = (\Gamma, L_n)$, and $3 \leq N \leq \ell - 2$ with $L_n(v_N) = q_f$, and*

1. *there exist $0 \leq j_1 < j_2 < n$ such that for all $0 \leq j < n$, if we let $C_j \xrightarrow{v^j, t^j} C_{j+1}$:*
 - (a) *if $0 \leq j < j_1$, then $v^j \in \{v_1, \dots, v_{N-2}\}$ and if $v^j = v_{N-2}$, then $t^j = (q, \tau, q')$ for some $q, q' \in Q$; and*
 - (b) *if $j_1 \leq j < j_2$, then $v^j \in \{v_{N+2}, \dots, v_{\ell}\}$ and if $v^j = v_{N+2}$, then $t^j = (q, \tau, q')$ for some $q, q' \in Q$; and*
 - (c) *if $j_2 \leq j < n$, then $v^j \in \{v_{N-2}, \dots, v_{N+2}\}$.*
2. (a) *for all $1 \leq i \leq N - 2$, $t_{\text{last}}(v_i, \rho) \leq b_{\text{first}}(v_{i+1}, \rho)$, and*
 (b) *for all $N + 2 \leq i \leq \ell$, $t_{\text{last}}(v_i, \rho) \leq b_{\text{first}}(v_{i-1}, \rho)$.*

Figure 12 illustrates the specific form of the execution described in Item 1 of Lemma 6.4: the first nodes to take actions are the ones in the purple part (on the left), then, only nodes in the green part (on the right) issue transitions), and finally the nodes in the orange central part take actions in order to reach q_f . The fact that P is 2-phase bounded allows us to establish Item 2 of Lemma 6.4: when v_{i+1} starts broadcasting, no further broadcasts from v_i will influence v_{i+1} 's broadcasts (it can only receive them in its last reception phase).

Figure 12 highlights why we get a polynomial time algorithm: when we reach the orange part of the execution, the nodes v_{N-1} , v_N and v_{N+1} are still in the initial state of the protocol. Moreover, in the orange part (which is the one that witnesses the covering of q_f), only five nodes take actions. Once one has computed in which set of states the nodes v_{N-2} and v_{N+2} can be at the beginning of the orange part, it only remains to compute the set of reachable configurations from a finite set of configurations. Let H be the set of possible states in which v_{N-2} and v_{N+2} can be at the beginning of the last part of the execution, and for $q_1, q_2 \in H$, let $C_{q_1, q_2} = (\Gamma_5, L_{q_1, q_2})$ where Γ_5 is the line topology with five vertices $\{v_1, v_2, v_3, v_4, v_5\}$ and $L_{q_1, q_2}(v_1) = q_1$, $L_{q_1, q_2}(v_5) = q_2$ and for all other vertex v , $L_{q_1, q_2}(v) = q_{in}$.

Our algorithm is then: (1) Compute H ; (2) For all $q_1, q_2 \in H$, explore reachable configurations from C_{q_1, q_2} ; (3) Answer yes if we reach a configuration covering q_f , answer no

otherwise. It remains to explain how to compute H . This computation relies on Item 2 of Lemma 6.4: locally, each node v_i at the left of v_{N-1} (resp. at the right of v_{N+1}) stops issuing transitions once its right neighbor v_{i+1} (resp. its left neighbor v_{i-1}) starts broadcasting.

Hence we compute iteratively set of coverable pairs of states $S \subseteq Q \times Q$ by relying on a family $(S_i)_{i \in \mathbb{N}}$ of subsets of $Q \times Q$ formally defined as follows:

$$\begin{aligned} S_0 &= \{(q_{in}, q_{in})\} \\ S_{i+1} &= S_i \cup \{(q_1, q_2) \mid \text{there exist } (p_1, p_2) \in S_i, j \in \{1, 2\} \text{ s.t. } (p_j, \tau, q_j) \in \Delta \text{ and } p_{3-j} = q_{3-j}\} \\ &\cup \{(q_1, q_2) \mid \text{there exists } (p_1, p_2) \in S_i, \text{ s.t. } (p_2, !!m, q_2) \in \Delta, (p_1, ?m, q_1) \in \Delta, m \in \Sigma\} \\ &\cup \{(q_1, q_2) \mid \text{there exists } p_2 \in Q \text{ s.t. } (q_1, p_2) \in S_i, \text{ and } (p_2, !!m, q_2) \in \Delta \text{ and } m \notin R(q_1)\} \\ &\cup \{(q_{in}, q) \mid \text{there exists } (q, q') \in S_i \text{ for some } q' \in Q\}. \end{aligned}$$

We then define $S = \bigcup_{n \in \mathbb{N}} S_n$, and $H = \{q \in Q \mid \text{there exists } q' \text{ and } (q, q') \in S\}$. Observe that $(S_i)_{i \in \mathbb{N}}$ is an increasing sequence bounded by $|Q|^2$. The computation reaches then a fixpoint and S can be computed in polynomial time. We define $H = \{q \mid \exists q' \in Q, (q, q') \in S\}$. Note that $H \subseteq Q_0 \cup Q_1^r$, as expected by Item 2 of Lemma 6.4. We also state that our construction is complete and correct, leading to the following theorem.

► **Theorem 6.5.** *COVER[Lines] is in P for k-phase-bounded protocols with $k \in \{1, 2\}$.*

Proof. We explain why the algorithm takes a polynomial time: step 1 (computing H) is done in polynomial time as explained above. For step 2, there are at most $|H| \times |H| \leq |Q|^2$ pairs, and for each pair, we explore a graph of at most $|Q|^5$ nodes in which each vertex represents a configuration $C = (\Gamma_5, L)$. Accessibility in a graph can be done non-deterministically in logarithmic space, and so in polynomial time. Observe that all the lemmas of this section hold true when considering 1-phase-bounded protocols, hence the theorem. ◀

References

- 1 B. Aminof, S. Jacobs, A. Khalimov, and S. Rubin. Parametrized model checking of token-passing systems. In *VMCAI'14*, volume 8318 of *LNCS*, pages 262–281. Springer-Verlag, 2014.
- 2 D. Angluin, J. Aspnes, Z. Diamadi, M. J. Fischer, and R. Peralta. Computation in networks of passively mobile finite-state sensors. In *PODC'04*, pages 290–299. ACM, 2004.
- 3 M. F. Atig, A. Bouajjani, and S. Qadeer. Context-bounded analysis for concurrent programs with dynamic creation of threads. *Log. Methods Comput. Sci.*, 7(4), 2011.
- 4 Benedikt Bollig, Mathieu Lehaut, and Nathalie Sznajder. Round-bounded control of parameterized systems. In *ATVA'18*, volume 11138 of *Lecture Notes in Computer Science*, pages 370–386. Springer, 2018.
- 5 E. M. Clarke, M. Talupur, T. Touili, and H. Veith. Verification by network decomposition. In *CONCUR'04*, volume 3170 of *LNCS*, pages 276–291. Springer-Verlag, 2004.
- 6 G. Delzanno, A. Sangnier, and G. Zavattaro. Parameterized verification of ad hoc networks. In *CONCUR'10*, volume 6269 of *LNCS*, pages 313–327. Springer, 2010.
- 7 G. Delzanno, A. Sangnier, and G. Zavattaro. On the power of cliques in the parameterized verification of ad hoc networks. In *FOSSACS'11*, volume 6604 of *LNCS*, pages 441–455. Springer, 2011.
- 8 A. Durand-Gasselin, J. Esparza, P. Ganty, and R. Majumdar. Model checking parameterized asynchronous shared-memory systems. *Formal Methods Syst. Des.*, 50(2-3):140–167, 2017.
- 9 J. Esparza, A. Finkel, and R. Mayr. On the verification of broadcast protocols. In *LICS'99*, pages 352–359. IEEE Computer Society, 1999.



© L. Guillou and A. Sangnier and N. Sznajder;
licensed under Creative Commons License CC-BY 4.0



Leibniz International Proceedings in Informatics
Schloss Dagstuhl – Leibniz-Zentrum für Informatik, Dagstuhl Publishing, Germany

- 10 J. Esparza, P. Ganty, J. Leroux, and R. Majumdar. Verification of population protocols. *Acta Informatica*, 54(2):191–215, 2017.
- 11 J. Esparza, P. Ganty, and R. Majumdar. Parameterized verification of asynchronous shared-memory systems. *J. ACM*, 63(1):10:1–10:48, 2016.
- 12 J. Esparza, S. Jaax, M. A. Raskin, and C. Weil-Kennedy. The complexity of verifying population protocols. *Distributed Comput.*, 34(2):133–177, 2021.
- 13 S. M. German and A. P. Sistla. Reasoning about systems with many processes. *Journal of the ACM*, 39(3):675–735, 1992.
- 14 L. Guillou, A. Sangnier, and N. Sznajder. Safety analysis of parameterised networks with non-blocking rendez-vous. In *CONCUR'23*, volume 279 of *LIPICs*, pages 7:1–7:17. Schloss Dagstuhl - Leibniz-Zentrum für Informatik, 2023.
- 15 O. H. Ibarra. Reversal-bounded multicounter machines and their decision problems. *J. ACM*, 25(1):116–133, 1978.
- 16 S. La Torre, P. Madhusudan, and G. Parlato. Model-checking parameterized concurrent programs using linear interfaces. In *CAV'10*, volume 6174 of *LNCS*, pages 629–644. Springer, 2010.
- 17 R.J. Lipton. *The reachability problem requires exponential space*. Research report (Yale University. Department of Computer Science). Department of Computer Science, Yale University, 1976.
- 18 M. L. Minsky. *Computation: Finite and Infinite Machines*. Prentice-Hall, Inc., 1967.
- 19 S. Qadeer and J. Rehof. Context-bounded model checking of concurrent software. In *TACAS'05*, volume 3440 of *LNCS*, pages 93–107. Springer, 2005.
- 20 C. Rackoff. The covering and boundedness problems for vector addition systems. *Theoretical Computer Science*, 6:223–231, 1978.
- 21 G. Ramalingam. Context-sensitive synchronization-sensitive analysis is undecidable. *ACM Trans. Program. Lang. Syst.*, 22(2):416–430, 2000.
- 22 Walter J. Savitch. Relationships between nondeterministic and deterministic tape complexities. *J. Comput. Syst. Sci.*, 4(2):177–192, 1970. doi:10.1016/S0022-0000(70)80006-X.
- 23 S. Schmitz and P. Schnoebelen. The power of well-structured systems. In *CONCUR'13*, volume 8052 of *LNCS*, pages 5–24. Springer, 2013.

A Cover and Cover[Trees] are equivalent

Let $P = (Q, \Sigma, q_{in}, \Delta)$ be a broadcast protocol, and $q_f \in Q$. Let $\rho = C_0 \rightarrow \dots \rightarrow C_n$ with $C_i = (\Gamma, L_i) \in \mathcal{C}_P$ for all $0 \leq i \leq n$, and a vertex $v_f \in V(\Gamma)$ such that $L_n(v_f) = q_f$. We will build an execution covering q_f with a tree topology Γ' , rooted in v_f , the node that reaches q_f . Γ' is actually an *unfolding* of the topology Γ .

We first define inductively the set of nodes $V' \subseteq \mathbb{N}^*$, along with a labelling function λ which associates to each node $v' \in V'$ a node $v \in V(\Gamma)$.

1. $\epsilon \in V'$ and $\lambda(\epsilon) = v_f$;
2. Let $N_\Gamma(v_f) = \{v_1, \dots, v_k\}$. For all $1 \leq i \leq k$, $i \in V'$ and $\lambda(i) = v_i$;
3. Let $w \cdot x \in V'$, with $w \in \mathbb{N}^*$ such that $|w| < n - 1$, and $x \in \mathbb{N}$. Let $N_\Gamma(\lambda(w \cdot x)) \setminus \{\lambda(w)\} = \{v_1, \dots, v_k\}$. Then, for all $1 \leq i \leq k$, $w \cdot x \cdot i \in V'$ and $\lambda'(w \cdot x \cdot i) = v_i$.

Finally, define $E' = \{\langle w, w \cdot x \rangle \mid w \in V', w \cdot x \in V'\}$. Note that $\epsilon \in V'$ and $V' \subseteq \mathbb{N}^*$ and is prefix closed. Furthermore, by construction, for all $w \in V'$, $|w| \leq n$, and for all $w \in V'$, in fact $w \in \{1, \dots, d\}^*$ where d is the maximal degree of Γ . Hence, V' is a finite set and $\Gamma' = (V', E')$ is a tree topology.

The way we built Γ' ensures that each node $v \in V'$ (except the leaves) enjoys the same set of neighbors than $\lambda(v) \in V$. This is formalised in the following lemma.

► **Lemma A.1.** *For all $u \in V'$, for all $u' \in N_{\Gamma'}(u)$, $\lambda(u') \in N_\Gamma(\lambda(u))$. Then, we let $f_u : N_{\Gamma'}(u) \rightarrow N_\Gamma(\lambda(u))$ defined by $f_u(u') = \lambda(u')$. If $|u| < n$, f_u is a bijection.*

Proof. We prove the lemma inductively on the structure of the nodes of V' .

- Let $u = \epsilon$, then $\lambda(u) = v_f$ and let $N_\Gamma(v_f) = \{v_1, \dots, v_k\}$. Then by definition, for all $1 \leq i \leq k$, $i \in V'$ and $\lambda(i) = v_i$. By definition of E' , $\{1, \dots, k\} \subseteq N_{\Gamma'}(\epsilon)$. Now let $u \in N_{\Gamma'}(\epsilon)$, again by definition of E' , $|u| = 1$ and $u \in \{1, \dots, k\}$ because all other nodes added in V' are of length greater or equal than 2. So $N_{\Gamma'}(\epsilon) = \{1, \dots, k\}$, and the function f_ϵ such that $f_\epsilon(i) = \lambda(i) = v_i$ is obviously a bijection.
- Let $w \cdot x \in V'$ such that $|w \cdot x| < n$ and $w \in \mathbb{N}^*$. By induction hypothesis, $f_w : N_{\Gamma'}(w) \rightarrow N_\Gamma(\lambda(w))$ is a bijection. Hence, since by definition of E' , $w \cdot x \in N_{\Gamma'}(w)$, $f_w(w \cdot x) = \lambda(w \cdot x) \in N_\Gamma(\lambda(w))$ and $(\lambda(w), \lambda(w \cdot x)) \in E$. Let then $N_\Gamma(\lambda(w \cdot x)) = \{v_1, \dots, v_\ell, \lambda(w)\}$. By definition of V' and E' , $N_{\Gamma'}(w \cdot x) = \{w, w \cdot x \cdot 1, \dots, w \cdot x \cdot \ell\}$ and $\lambda(w \cdot x \cdot i) = v_i$ for all $1 \leq i \leq \ell$. Hence, $f_{w \cdot x}$ is a bijection.

Moreover, if $w \cdot x \in V'$ with $|w \cdot x| = n$, then $w \cdot x$ is a leaf and $N_{\Gamma'}(w \cdot x) = \{w \cdot x\}$. By construction, $\lambda(w \cdot x) = v \in N_\Gamma(\lambda(w))$, which implies that $\lambda(w) \in N_\Gamma(\lambda(w \cdot x))$. ◀

From the execution $\rho = C_0 \rightarrow \dots \rightarrow C_n$ we will build a similar execution on Γ' . The idea is that for each step of the execution ρ , for each node $v \in V$, all the nodes in Γ' that are labelled by v will behave in the same way. This is possible thanks to Lemma A.1. Observe though that the leaves might not be able to behave as expected because they might not have the same set of neighbors than the node they are labelled by, so they might not be able to receive some broadcast message. However, we can ensure some weaker version of correctness, defined as follows. Let $0 \leq h \leq n$ and $C = (\Gamma, L)$ be a configuration. We say that a configuration $C' = (\Gamma', L')$ is *h-correct* for C if for all $u \in V(\Gamma')$, if $|u| \leq h$ then $L'(u) = L(\lambda(u))$.

The following lemma gives the main ingredient that allows to mimic the execution ρ on Γ' .

► **Lemma A.2.** Let $C_1 = (\Gamma, L_1)$, $C_2 = (\Gamma, L_2) \in \mathcal{C}_P$ such that $C_1 \rightarrow C_2$ and let $C'_1 = (\Gamma', L'_1) \in \mathcal{C}_P$ and $0 < h \leq n$ such that C'_1 is h -correct for C_1 . There exists $C'_2 \in \mathcal{C}_P$ such that $C'_1 \rightarrow^* C'_2$, and C'_2 is $(h-1)$ -correct for C_2 .

Proof. Denote $C_1 \xrightarrow{v,t} C_2$ with $t = (q, \alpha, q')$ and $\alpha \in \Sigma \cup \{\tau\}$. Let $\{u_1, \dots, u_K\}$ be the set of vertices in V' such that for all $1 \leq k \leq K$, $|u_k| \leq h$ and $\lambda(u_k) = v$. We will build inductively an execution $C'_{1,0} \xrightarrow{u_1,t} C'_{1,1} \xrightarrow{u_2,t} \dots \xrightarrow{u_K,t} C'_{1,K}$ of configurations over Γ' such that for all $0 \leq k \leq K$, $C'_{1,k} = (\Gamma', L'_{1,k})$ and for all node $u \in V'$ such that $|u| \leq h$,

- if $u \in \bigcup_{1 \leq j \leq k} (\{u_j\} \cup \mathbf{N}_{\Gamma'}(u_j))$, then $L'_{1,k}(u) = L_2(\lambda(u))$,
- otherwise, $L'_{1,k}(u) = L'_1(u)$.

We let $C'_{1,0} = C'_1$, since $\bigcup_{1 \leq j \leq k} (\{u_j\} \cup \mathbf{N}_{\Gamma'}(u_j)) = \emptyset$, C'_1 trivially meets the requirements.

Let $0 \leq k < K$ and assume now that we have built $C'_{1,0}, \dots, C'_{1,k}$ as required. First, observe that

$$(u_{k+1} \cup \mathbf{N}_{\Gamma'}(u_{k+1})) \cap \left(\bigcup_{1 \leq j \leq k} (\{u_j\} \cup \mathbf{N}_{\Gamma'}(u_j)) \right) = \emptyset. \quad (1)$$

Indeed assume otherwise and let u an element of this intersection. If $u = u_{k+1}$, then $u \notin \bigcup_{1 \leq j \leq k} \{u_j\}$ by definition. Then it must be in $\bigcup_{1 \leq j \leq k} \mathbf{N}_{\Gamma'}(u_j)$ and let j such that $u_{k+1} \in \mathbf{N}_{\Gamma'}(u_j)$. By Lemma A.1, $f_{u_j}(u_{k+1}) = \lambda(u_{k+1}) = v \in \mathbf{N}_{\Gamma}(\lambda(u_j)) = \mathbf{N}_{\Gamma}(v)$. Hence it implies that $(v, v) \in E$ which is impossible. If $u \in \mathbf{N}_{\Gamma'}(u_{k+1})$ then by a similar argument, $u \notin \bigcup_{1 \leq j \leq k} \{u_j\}$. Then let $1 \leq j \leq k$ such that $u \in \mathbf{N}_{\Gamma'}(u_j)$. Then $u_j \in \mathbf{N}_{\Gamma'}(u)$ and $u_{k+1} \in \mathbf{N}_{\Gamma'}(u)$. If $|u| < n$ (u is not a leaf), then $f_u(u_j) = \lambda(u_j) = v$ and $f_u(u_{k+1}) = \lambda(u_{k+1}) = v$ which contradicts the fact that f_u is bijective from Lemma A.1. If $|u| = n$, then it is a leaf and it has only one neighbor: its father in the tree. So it is not possible that $\{u_j, u_{k+1}\} \in \mathbf{N}_{\Gamma'}(u)$.

To define $C'_{1,k+1}$ we need to differentiate between the possible values of α (recall that $t = (q, \alpha, q')$).

- if $\alpha = \tau$, let $L'_{1,k+1}(u_{k+1}) = q'$ and $L'_{1,k+1}(u) = L'_{1,k}(u)$ for all $u \neq u_{k+1}$. First, by Equation (1) and induction hypothesis, $u_{k+1} \notin \bigcup_{1 \leq j \leq k} (\{u_j\} \cup \mathbf{N}_{\Gamma'}(u_j))$, then $L'_{1,k}(u_{k+1}) = L'_1(u_{k+1})$. Moreover, since C'_1 is h -correct for C_1 , $L'_1(u_{k+1}) = L_1(v) = q$. Then $C'_{1,k} \xrightarrow{u_{k+1},t} C'_{1,k+1}$. Let $u \in V'$ such that $|u| \leq h$ and $u \in \bigcup_{1 \leq j \leq k+1} (\{u_j\} \cup \mathbf{N}_{\Gamma'}(u_j))$. If $u \in \bigcup_{1 \leq j \leq k} (\{u_j\} \cup \mathbf{N}_{\Gamma'}(u_j))$, by induction hypothesis, $L'_{1,k}(u) = L_2(\lambda(u))$. Moreover, by Equation (1), $u \neq u_{k+1}$. Then, $L'_{1,k+1}(u) = L'_{1,k}(u) = L_2(\lambda(u))$. By construction, $L'_{1,k+1}(u_{k+1}) = q' = L_2(\lambda(u_{k+1}))$. Now, if $u \in \mathbf{N}_{\Gamma'}(u_{k+1})$, or $u \notin \bigcup_{1 \leq j \leq k+1} (\{u_j\} \cup \mathbf{N}_{\Gamma'}(u_j))$. Then, $L'_{1,k+1}(u) = L'_{1,k}(u)$. By induction hypothesis, $L'_{1,k}(u) = L'_1(u) = L_1(\lambda(u))$ because C'_1 is h -correct for C_1 . Moreover, $L_1(\lambda(u)) = L_2(\lambda(u))$. Hence, $C'_{1,k+1}$ meets the requirements.
- If $\alpha \neq \tau$ for some $m \in \Sigma$, we define $L'_{1,k+1}$ as follows.
 - $L'_{1,k+1}(u_{k+1}) = q'$ (the node u_{k+1} performs the broadcast).
 - for all $u \in \mathbf{N}_{\Gamma'}(u_{k+1})$ such that $|u| \leq h$, $L'_{1,k+1}(u) = L_2(\lambda(u))$.
 - for all $u \in \mathbf{N}_{\Gamma'}(u_{k+1})$ such that $|u| > h$, if there exists $p \in Q$ and $(L'_{1,k}(u), ?m, p) \in \Delta$, $L'_{1,k+1}(u) = p$, otherwise, $L'_{1,k+1}(u) = L'_{1,k}(u)$ (its neighbors receive the broadcast).
 - For all other $u \in V'$, $L'_{1,k+1}(u) = L_1(u)$.

We first show that $C'_{1,k} \xrightarrow{u_{k+1},t} C'_{1,k+1}$. By Equation (1), $u_{k+1} \notin \bigcup_{1 \leq j \leq k} (\{u_j\} \cup \mathbf{N}_{\Gamma'}(u_j))$. Hence, the induction hypothesis ensures that $L'_{1,k}(u_{k+1}) = L_1(\lambda(u_{k+1})) = L_1(v)$. Let $u \in \mathbf{N}_{\Gamma'}(u_{k+1})$ such that $|u| \leq h$. By Equation (1), $u \notin \bigcup_{1 \leq j \leq k} (\{u_j\} \cup \mathbf{N}_{\Gamma'}(u_j))$. Then, by induction hypothesis, $L'_{1,k}(u) = L'_1(u) = L_1(\lambda(u))$ since C'_1 is h -correct for C_1 . Moreover,

since $u \in \mathbf{N}_{\Gamma'}(u_{k+1})$, Lemma A.1 implies that $\lambda(u) \in \mathbf{N}_{\Gamma}(v)$. Since $C_1 \xrightarrow{v,t} C_2$, we know that either $(L_1(\lambda(u)), ?m, L_2(\lambda(u))) \in \Delta$, hence $(L'_{1,k}(u), ?m, L'_{1,k+1}(u)) \in \Delta$, or $L'_{1,k+1}(u) = L_2(\lambda(u)) = L_1(\lambda(u)) = L'_{1,k}(u)$. In both cases, we can conclude that $C'_{1,k} \xrightarrow{u_{k+1},t} C'_{1,k+1}$.

Let now $u \in V'$ such that $|u| \leq h$ and $u \in \bigcup_{1 \leq j \leq k+1} (\{u_j\} \cup \mathbf{N}_{\Gamma'}(u_j))$. If $u \in \bigcup_{1 \leq j \leq k} (\{u_j\} \cup \mathbf{N}_{\Gamma'}(u_j))$, again by Equation (1), $u \notin \{u_{k+1}\} \cup \mathbf{N}_{\Gamma'}(u_{k+1})$, and $L'_{1,k+1}(u) = L'_{1,k}(u) = L_2(\lambda(u))$ by induction hypothesis. If $u = u_{k+1}$, $L'_{1,k+1}(u) = q' = L_2(v) = L_2(\lambda(u_{k+1}))$. If $u \in \mathbf{N}_{\Gamma'}(u_{k+1})$, by definition we have that $L'_{1,k+1}(u) = L_2(\lambda(u))$. If now $|u| \leq h$ and $u \notin \bigcup_{1 \leq j \leq k+1} (\{u_j\} \cup \mathbf{N}_{\Gamma'}(u_j))$, $L'_{1,k+1}(u) = L'_{1,k}(u) = L'_1(u)$ by induction hypothesis.

We let $C'_2 = C'_{1,K}$ and we prove that C'_2 is $(h-1)$ -correct for C_2 . Let $u \in V'$ such that $|u| \leq h-1 < n$. As C'_1 is h -correct for C_1 , $L'_1(u) = L_1(\lambda(u))$.

If u is such that $\lambda(u) \in \mathbf{N}_{\Gamma}(v)$, then by Lemma A.1, there exists $u' \in \mathbf{N}_{\Gamma'}(u)$ such that $\lambda(u') = v$. Furthermore, since Γ' is a tree topology, and $|u| \leq h-1$, either $|u'| \leq h-2$ or $|u'| \leq h-1+1 = h$. In both cases, $|u'| \leq h$. As a consequence, $u' \in \{u_1, \dots, u_K\}$, and so, $L'_2(u) = L'_{1,K}(u) = L_2(\lambda(u))$. If u is such that $\lambda(u) = v$, then $u \in \{u_1, \dots, u_K\}$, and again, $L'_2(u) = L'_{1,K}(u) = L_2(\lambda(u))$. In other cases, $\lambda(u) \notin \mathbf{N}_{\Gamma}(v) \cup \{v\}$, and $L_2(\lambda(u)) = L_1(\lambda(u))$. By definition of $\{u_1, \dots, u_K\}$ and by Lemma A.1, $u \notin \bigcup_{1 \leq j \leq k} (\{u_j\} \cup \mathbf{N}_{\Gamma'}(u_j))$. As a consequence, $L'_2(u) = L'_{1,K}(u) = L'_1(u) = L_1(\lambda(u)) = L_2(\lambda(u))$.

Hence, C'_2 is $(h-1)$ -correct for C_2 . \blacktriangleleft

We build now an execution covering q_f with Γ' : let $C'_0 = (\Gamma', L'_0)$ defined by $L'_0(v) = q_{in}$ for all $v \in \mathbf{V}(\Gamma')$. Obviously, C'_0 is n -correct. By Lemma A.2, there exists a sequence of configurations $(C'_i)_{1 \leq i \leq n}$ such that for all $1 \leq i \leq n$, $C'_{i-1} \rightarrow^* C'_i$ and C'_i is $(n-i)$ -correct for C_i . Hence, $C'_0 \rightarrow^* C'_n$ and C'_n is 0-correct for C_n and $L'_n(\epsilon) = L_n(\lambda(\epsilon)) = L_n(v_f) = q_f$.

This allows to prove the following result.

► **Theorem A.3.** *COVER and COVER[Trees] are equivalent.*

B Phase-bounded protocols as an under-approximation

Phase-bounded protocols can be seen as a semantic restriction of general protocols in which each process can only switch a bounded number of times between phases where it receives messages and phases where it can send messages. When, usually, restricting the behavior of processes immediately yields an underapproximation of the reachable states, we highlight here the fact that preventing messages from being received can in fact lead to new reachable states. This motivates our definition of phase-bounded protocols, in which a process always ends in a reception phase.

Indeed, consider the protocol pictured on Figure 13a. The state q_3 is not coverable: to cover q_3 , a node v_1 needs to receive message a when it is on state q_2 from one of its neighbor v_2 . By construction, v_1 broadcasts message m before reaching q_2 . Vertex v_2 can only broadcast message a when it is on state q_5 . To reach q_5 , vertex v_2 visited exactly states q_{in}, q_4 and q_5 . From each of those states, there is an outgoing reception transition labelled with m going to p . Hence, at any moment of the execution, the broadcast of message m by vertex v_1 would have brought v_2 in p , preventing the broadcast of a . However, a naive 2-phase bounded unfolding of this protocol, in which we limit the number of phases of sending and reception to 2, is illustrated in Figure 13b. In this protocol, $(q_3, r, 2)$ (hence q_3) is coverable:



© L. Guillou and A. Sangnier and N. Sznajder;
licensed under Creative Commons License CC-BY 4.0



Leibniz International Proceedings in Informatics

Schloss Dagstuhl – Leibniz-Zentrum für Informatik, Dagstuhl Publishing, Germany

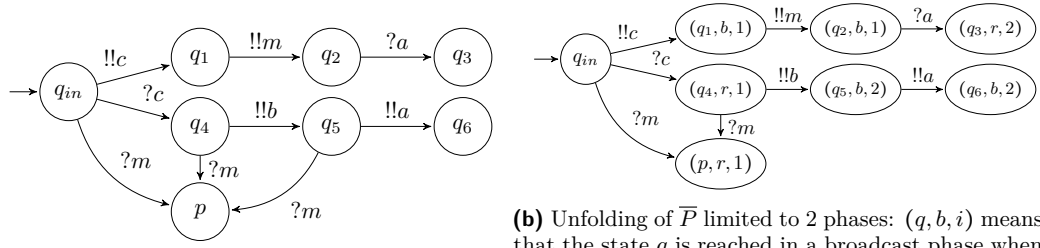

(a) An example of a broadcast protocol \bar{P}

(b) Unfolding of \bar{P} limited to 2 phases: (q, b, i) means that the state q is reached in a broadcast phase when (q, r, i) means that it is reached in a reception phase. The number of the phase is given by i .

■ **Figure 13** A protocol and its bounded unfolding showing that it may not be an underapproximation.

consider $\Gamma = (\{v_1, v_2\}, \{\{v_1, v_2\}\})$ and the following execution:

$$\begin{aligned} &(\Gamma, \{v_1 \mapsto q_{in}, v_2 \mapsto q_{in}\}) \rightarrow (\Gamma, \{v_1 \mapsto (q_1, b, 1), v_2 \mapsto (q_4, r, 1)\}) \rightarrow (\Gamma, \{v_1 \mapsto (q_1, b, 1), \\ &v_2 \mapsto (q_5, b, 2)\}) \rightarrow (\Gamma, \{v_1 \mapsto (q_2, b, 1), v_2 \mapsto (q_5, b, 2)\}) \rightarrow (\Gamma, \{v_1 \mapsto (q_3, r, 2), v_2 \mapsto (q_6, b, 2)\}). \end{aligned}$$

In fact, in state $(q_5, b, 2)$ a process is not allowed to switch anymore, hence the transition allowing to receive message m has been removed. Doing so, we have made state q_3 coverable. This shows that this type of bounded semantics does not give an underapproximation of the coverable states, in spite of what was expected.

Actually, the reception of a message is something that is not under the control of a process. If another process broadcasts a message, a faithful behavior of the system is that all the processes that can receive it indeed do so, no matter in which phase they are in their own execution. Hence, in a restriction that attempts to limit the number of switches between sending and receiving phases, one should not prevent a reception to happen. This motivates our definition of a phase-bounded protocol.

Let $P = (Q, \Sigma, q_{in}, \Delta)$ be a broadcast protocol, and $k \in \mathbb{N}$.

We define the k -unfolding of P denoted by P_k as the following protocol: $P_k = (Q_k, \Sigma, q_{in}, \Delta_k)$ with $Q_k = \{q^0 \mid q \in Q\} \cup \{q^{b,j}, q^{r,j} \mid q \in Q, 1 \leq j \leq k\}$. To ease the notations we let $q^{r,0} = q^0$, $q^{b,0} = q^0 =$ for all $q^0 \in Q_0$.

$$\begin{aligned} \Delta_k = & \{(q^0, \tau, p^0) \mid (q, \tau, p) \in \Delta\} \\ & \cup \{(q^{r,j}, \alpha, p^{r,j}) \mid 1 \leq j \leq k \text{ and } (q, \alpha, p) \in \Delta \text{ and } \alpha \in \{\tau\} \cup ?\Sigma\} \\ & \cup \{(q^{b,j}, \alpha, p^{b,j}) \mid 1 \leq j \leq k \text{ and } (q, \alpha, p) \in \Delta \text{ and } \alpha \in \{\tau\} \cup !!\Sigma\} \\ & \cup \{(q^{r,j}, !!m, p^{b,j+1}) \mid 0 \leq j < k \text{ and } (q, !!m, p) \in \Delta\} \\ & \cup \{(q^{b,j}, ?m, p^{r,j+1}) \mid 0 \leq j < k \text{ and } (q, ?m, p) \in \Delta\} \\ & \cup \{(q^{b,k}, ?m, p^{r,k}) \mid (q, ?m, p) \in \Delta\}. \end{aligned}$$

The last case of the definition of Δ_k implements the fact that we never prevent a reception from occurring, even in the last phase.

The following lemma establishes that this definition of unfolding can be used as an underapproximation for COVER.

► **Lemma B.1.** q_f can be covered in P if and only if there exist $k \in \mathbb{N}$, $y \in \{r, b\}$ and $0 \leq j \leq k$ such that (q_f, y, j) can be covered in P_k .

Proof. Left-to-right direction: Assume that q_f can be covered in P , and let $C_0 \rightarrow C_1 \rightarrow \dots \rightarrow C_n$ be an execution of P such that $C_i = (\Gamma, L_i)$ for all $0 \leq i \leq n$ and there exists $v_f \in \mathbb{V}(\Gamma)$

such that $L_n(v_f) = q_f$. For all $v \in V$, we define κ_v a function associating to each $0 \leq i \leq n$ the number and the type of phase in which vertex v is. More formally, $\kappa_v(0) = 0$ and for $0 \leq i < n$,

$$\kappa_v(i+1) = \begin{cases} (b, 1) & \text{if } \kappa_v(i) = 0 \text{ and } C_i \xrightarrow{v,t} C_{i+1} \text{ for some } t = (q, !!m, q') \in \Delta, \\ & q, q' \in Q, m \in \Sigma \\ (r, 1) & \text{if } \kappa_v(i) = 0 \text{ and } C_i \xrightarrow{v',t} C_{i+1} \text{ with } v \in N(v') \text{ and} \\ & t = (q, !!m, q') \in \Delta, q, q' \in Q, m \in \Sigma \text{ and } (L_i(v), ?m, L_{i+1}(v)) \in \Delta \\ (b, j) & \text{if } \kappa_v(i) = (r, j-1) \text{ and } C_i \xrightarrow{v,t} C_{i+1} \text{ for some } t = (q, !!m, q') \in \Delta, \\ & q, q' \in Q, m \in \Sigma \\ (r, j) & \text{if } \kappa_v(i) = (b, j-1) \text{ and } C_i \xrightarrow{v',t} C_{i+1} \text{ with } v \in N(v') \text{ and} \\ & t = (q, !!m, q') \in \Delta, q, q' \in Q, m \in \Sigma \text{ and } (L_i(v), ?m, L_{i+1}(v)) \in \Delta \\ \kappa_v(i) & \text{otherwise.} \end{cases}$$

We define $k = \max_{v \in V(\Gamma)} \{x_v \mid \kappa_v(n) = (x_v, y), y \in \{r, b\}\}$. Since, for all $0 \leq i < n$, for all $v \in V(\Gamma)$, $\kappa_v(i) \leq \kappa_v(i+1)$, it holds that $k \geq \{x_v \mid \kappa_v(i) = (x_v, y), y \in \{r, b\}, 0 \leq i \leq n\}$. We now consider $P_k = (Q_k, \Sigma, q_{in}^0, \Delta_k)$ the k -unfolding of P . For each $0 \leq i \leq n$, for all $v \in V(\Gamma)$, if $L_i(v) = q$ we let $L'_i(v) = q^{\kappa_v(i)}$. We now show $C'_0 \rightarrow C'_1 \rightarrow \dots \rightarrow C'_n$ is an execution of P_k where for all $0 \leq i \leq n$, $C'_i = (\Gamma, L'_i)$. Consider $C'_0 = (\Gamma, L'_0)$ with $L'_0(v) = q_{in}^0$ for all $v \in V(\Gamma)$. As $\kappa_v(0) = 0$ for all $v \in V(\Gamma)$, the induction property holds and C'_0 is initial. Assume we proved that $C'_0 \rightarrow^* C'_i$. We have to prove that $C'_i \rightarrow C'_{i+1}$. Denote $v_!$ the vertex such that $C_i \xrightarrow{v_!,t} C_{i+1}$.

If $t = (q_1, \tau, q_2)$ for some $q_1, q_2 \in Q$, for all $v \in V(\Gamma)$, $\kappa_v(i+1) = \kappa_v(i)$ and if $v \neq v_!$, $L_{i+1}(v) = L_i(v)$ hence, $L'_{i+1}(v) = L'_i(v)$. By definition of P_k , $(q_1^{\kappa_{v_!}(i)}, \tau, q_2^{\kappa_{v_!}(i+1)}) \in \Delta_k$. Hence, if $\alpha = \tau$, $C'_i \rightarrow C'_{i+1}$.

Now let $t = (q_1, !!m, q_2)$ for some $m \in \Sigma$ and $q_1, q_2 \in Q$. We start by observing that for all $v \in V(\Gamma) \setminus (\{v_!\} \cup N(v_!))$, $\kappa_v(i+1) = \kappa_v(i)$ and $L_{i+1}(v) = L_i(v)$ hence, $L'_{i+1}(v) = L'_i(v)$.

Observe that, either (a) $\kappa_{v_!}(i+1) = (b, j)$ and $\kappa_{v_!}(i) = (r, j-1)$ (or $\kappa_v(i) = 0$) for some $j \leq k$, or (b) $\kappa_{v_!}(i+1) = \kappa_{v_!}(i)$. In case (a), $L'_i(v_!) = q_1^{(r, j-1)}$ or $L'_i(v_!) = q_1^0$, and $L'_{i+1}(v_!) = L_{i+1}(v_!)^{\kappa_{v_!}(i+1)} = L_{i+1}(v_!)^{(b, j)} = q_2^{(b, j)}$. By definition, $(q_1^{(r, j-1)}, !!m, q_2^{(b, j)}) \in \Delta_k$ (or $(q_1^0, !!m, q_2^{(b, j)}) \in \Delta_k$).

In case (b), $\kappa_v(i) = \kappa_v(i+1) = (b, j)$ for some $1 \leq j \leq k$. Then, $L'_i(v_!) = q_1^{(b, j)}$ and $L'_{i+1}(v_!) = L_{i+1}(v_!)^{\kappa_{v_!}(i+1)} = L_{i+1}(v_!)^{(b, j)} = q_2^{(b, j)}$. By definition, $(q_1^{(b, j)}, !!m, q_2^{(b, j)}) \in \Delta_k$.

Let now $v \in N(v_!)$. If there is no $q' \in Q$ such that $(L_i(v), ?m, L_{i+1}(v)) \in \Delta$, then $L_i(v) = L_{i+1}(v)$ and $\kappa_v(i+1) = \kappa_v(i)$. Hence $L'_{i+1}(v) = L_{i+1}(v)^{\kappa_v(i+1)} = L_i(v)^{\kappa_v(i)} = L'_i(v)$. Furthermore, by construction of P_k , there is no transition $(L'_i(v), ?m, p^\kappa) \in \Delta_k$ for some $p^\kappa \in Q_k$ as otherwise, there would be a transition $(L_i(v), ?m, p) \in \Delta$, which contradicts the fact that $L_i(v) = L_{i+1}(v)$.

Let now $v \in N(v_!)$ such that $(L_i(v), ?m, L_{i+1}(v)) \in \Delta$. By definition of κ_v , again, either (a) $\kappa_v(i+1) = (r, j)$ and $\kappa_v(i) = (b, j-1)$ (or $\kappa_v(i) = 0$) for some $1 \leq j$, or (b) $\kappa_v(i+1) = \kappa_v(i)$. In that case, $\kappa_v(i) = (r, j)$ for some $j \geq 1$. In both cases, by construction of k , it holds that $j \leq k$. Hence, by definition of Δ_k , in case (a), $L'_i(v) = L_i(v)^{(b, j-1)}$ and $L'_{i+1}(v) = L_{i+1}(v)^{(r, j)}$ and $(L'_i(v), ?m, L'_{i+1}(v)) \in \Delta_k$, and in case (b), $L'_i(v) = L_i(v)^{(r, j)}$ and $L_{i+1}(v) = L_{i+1}(v)^{(r, j)}$. Hence, $(L'_i(v), ?m, L'_{i+1}(v)) \in \Delta_k$.

We conclude that $C'_i \rightarrow C'_{i+1}$.

Hence, $L'_n(v_f) = q_f^{\kappa_{v_f}(n)}$ and so there exists $0 \leq j \leq k$ and $y \in \{r, b\}$ such that $q_f^{y, j}$ is coverable in P_k .

Right-to-left direction: Conversely, assume that there exist $k \in \mathbb{N}$, $0 \leq j \leq k$ and $y \in \{r, b\}$ such that $q_f^{y,j}$ is coverable in P_k . Let $C_0 \rightarrow C_1 \rightarrow \dots \rightarrow C_n$ an execution such that $C_n = (\Gamma, L_n)$ and there exists $v_f \in V(\Gamma)$ with $L_n(v_f) = q_f^{y,j}$. We show that there exists an execution $C'_0 \rightarrow C'_1 \rightarrow \dots \rightarrow C'_n$ such that for all $1 \leq i \leq n$, for $C'_i = (\Gamma, L'_i)$ and any vertex $v \in V(\Gamma)$, $L'_i(v) = q$ if and only if there exists $\kappa_{v,i} \in \{0\} \cup (\{r, b\} \times [0, n])$ such that $L_i(v) = q^{\kappa_{v,i}}$.

Let $C'_0 = (\Gamma, L'_0)$ with $L_0(v) = q_{in}$ for all $v \in V(\Gamma)$. As $L'_0(v) = q_{in}^0$ for all $v \in V(\Gamma)$, the induction hypothesis holds. Assume we proved that $C'_0 \rightarrow^* C'_i$ where for all $v \in V(\Gamma)$, $L'_i(v) = q$ if and only if there exists $\kappa_{v,i} \in \{0\} \cup (\{r, b\} \times [0, n])$ such that $L_i(v) = q^{\kappa_{v,i}}$.

Let $C'_{i+1} = (\Gamma, L'_{i+1})$ be the configuration such that for all $v \in V(\Gamma)$, $L'_{i+1}(v) = q$ if and only if there exists $\kappa_{v,i+1} \in \{0\} \cup (\{r, b\} \times [0, n])$ such that $L_{i+1}(v) = q^{\kappa_{v,i+1}}$. We prove now that $C'_i \rightarrow C'_{i+1}$.

Denote $C_i \xrightarrow{v_i, t} C'_{i+1}$ and $t = (q_1^{\kappa_{v_1, i}}, \alpha, q_2^{\kappa_{v_1, i+1}}) \in \Delta_k$. From the definition of Δ_k , it holds that $(q_1, \alpha, q_2) \in \Delta$. Hence, if $\alpha = \tau$, $C'_i \rightarrow C'_{i+1}$, as for all other nodes, $L'_{i+1}(v) = q$ if and only if there exists $\kappa_{v,i+1} \in \{0\} \cup (\{r, b\} \times [0, n])$ such that $L_{i+1}(v) = q^{\kappa_{v,i+1}}$. Furthermore, $L_{i+1}(v) = L_i(v) = q^{\kappa_{v,i+1}}$ hence $L'_i(v) = q = L'_{i+1}(v)$.

Assume now that $\alpha = !!m$ for some $m \in \Sigma$ and let $v \in N(v_1)$. Either (a) $(L_i(v), ?m, L_{i+1}(v)) \in \Delta_k$, or (b) there is no $p \in Q_k$ such that $(L_i(v), ?m, p) \in \Delta_k$. In case (a), by construction of Δ_k , there exists $(p_1, ?m, p_2) \in \Delta$ such that $L_i(v) = p_1^{\kappa_1}$ and $L_{i+1}(v) = p_2^{\kappa_2}$ for some $\kappa_1, \kappa_2 \in \{0\} \cup (\{r, b\} \times [1, n])$ Hence, $(L'_i(v), ?m, L'_{i+1}(v)) \in \Delta$.

In case (b), we show that there is no $p \in Q$ such that $(L'_i(v), ?m, p) \in \Delta$. Assume by contradiction that this is the case, and denote $L_i(v) = p_1^\kappa$ and $(p_1, ?m, p_2) \in \Delta$. If $\kappa = 0$, then by definition of Δ_k , $(p_1^\kappa, ?m, p_2^{r,1}) \in \Delta_k$ and we reach a contradiction. If $\kappa = (r, j)$ for some $1 \leq j \leq k$, by definition of Δ_k , $(p_1^{(r,j)}, ?m, p_2^{(r,j)}) \in \Delta_k$ and again, we reach a contradiction. If $\kappa = (b, j)$, by definition of Δ_k : $(p_1^{(b,j)}, ?m, p_2^{(r,j+1)}) \in \Delta_k$ and we reach a contradiction. Finally, if $\kappa = (b, k)$ then, by definition of Δ_k : $(p_1^{(b,k)}, ?m, p_2^{(r,k)}) \in \Delta_k$ and we reached a contradiction.

Hence, there is no transition $(p_1, ?m, p_2) \in \Delta$ for some $p_2 \in Q$.

We conclude that $C'_i \rightarrow C'_{i+1}$. Hence, there is an execution $C'_0 \rightarrow^* C'_n$ of P with $L_n(v_f) = q_f$ and q_f is coverable in P . \blacktriangleleft

C Undecidability proof of Cover (Section 4)

We reduce the coverability problem of a Minsky machine to the COVER problem in broadcast networks with 6-phase-bounded protocols.

Minsky Machines.

A Minsky Machine M is a tuple $M = (\text{Loc}, \text{Trans}, \ell_0, \ell_f, x_1, x_2)$ such that Loc is a finite state of locations, $\ell_{in} \in \text{Loc}$, $\ell_f \in \text{Loc}$, x_1, x_2 are two counters and Trans is a finite set of transitions such that $\text{Trans} \subseteq \text{Loc} \times \{\text{inc}(x_i), \text{dec}(x_i), \text{test}(x_i) \mid i = 1, 2\} \times \text{Loc}$. We denote a configuration of M by a tuple (ℓ, x_1, x_2) where $\ell \in \text{Loc}$ and $x_1, x_2 \in \mathbb{N}$ are values of the two counters (respectively x_1 and x_2). Let (ℓ, x_1, x_2) and (ℓ', x'_1, x'_2) be two configurations, and $t \in \text{Trans}$. We note $(\ell, x_1, x_2) \xrightarrow{t} (\ell', x_1, x_2)$ with $t = (\ell, \text{op}, \ell')$ and one of the following conditions holds:

- $\text{op} = \text{inc}(x_i)$ for some $i \in \{1, 2\}$ and $x'_i = x_i + 1$ and $x'_{3-i} = x_{3-i}$;
- $\text{op} = \text{dec}(x_i)$ for some $i \in \{1, 2\}$ and $x'_i = x_i - 1$ and $x'_{3-i} = x_{3-i}$;
- $\text{op} = \text{test}(x_i)$ for some $i \in \{1, 2\}$ and $x'_i = x_i = 0$ and $x'_{3-i} = x_{3-i}$.



© L. Guillou and A. Sangnier and N. Sznajder;
licensed under Creative Commons License CC-BY 4.0



Leibniz International Proceedings in Informatics

Schloss Dagstuhl – Leibniz-Zentrum für Informatik, Dagstuhl Publishing, Germany

The halting problem asks if there is a sequence of transitions t_1, \dots, t_n such that $(\ell_{in}, 0, 0) \xrightarrow{t_1} (\ell_1, x_1^1, x_2^1) \xrightarrow{t_2} \dots \xrightarrow{t_n} (\ell_f, x_1^n, x_2^n)$ for $x_1^i, x_2^i \in \mathbb{N}$ for all $1 \leq i \leq n$ and $x_1^n = x_2^n = 0$. It is known to be undecidable. We denote X for the set of counters $\{x_1, x_2\}$.

C.1 Definition of P .

Let $M = (\text{Loc}, \text{Trans}, \ell_{in}, \ell_f, x_1, x_2)$ be a Minsky Machine. The protocol P of the reduction is described in Figure 14 and is defined on a finite alphabet Σ that we define now. We start by defining $\text{OP} = \{\text{test}_x, \text{todo}_{x+1}, \text{todo}_{x-1}, \text{todo}_{x+1}, \text{todo}_{x-1} \mid x \in X\}$. Next, for $0 \leq i \leq 2$, we define $\text{OP}^i = \{\text{op}^i \mid \text{op} \in \text{OP}\}$ and $\text{OK}^i = \{\text{done}_{\text{op}}^i \mid \text{op} \in \text{OP}\}$. We can now define the alphabet $\Sigma = \{\text{done}, 0, 1, 2\} \cup \bigcup_{0 \leq i \leq 2} \text{OP}^i \cup \text{OK}^i$. We also define for $0 \leq i \leq 2$ two operations: $i \ominus 1 = (i - 1) \bmod 3$ and $i \oplus 1 = (i + 1) \bmod 3$.

A transition from a sub protocol (an orange box) to a state means that from any states of the sub protocol, there is an outgoing transition with the same label and to the same state. Hence, any state q of P_M has outgoing transitions $(q, ?1, \odot)$, $(q, ?2, \odot)$ and $(q, ?0, \odot)$.

The main idea is to build a protocol that will ensure, during an initialization phase, a specific organization among processes depicted in Figure 15. In particular, after the initialization phase, processes will be organized as line v_0, v_1, \dots, v_n with the first process v_0 in a state ℓ_{in} corresponding to the initial location of the machine, the last process v_n in a state q^{tail} , and for $1 \leq i < n$, process v_i is on state z^{b_i} where $b_i = i \bmod 3$. This way, a process v_i (for some $0 \leq i < n$) can *distinguish* between its two neighbors (intuitively between its right and left). For instance, if $n < 5$, process v_4 is on a state z^1 and has its left neighbor v_3 on z^0 and its right neighbor v_5 on a state z^2 .

P_M , P_{tail} and P_i for $0 \leq i \leq 2$ will be defined on the same alphabet of messages Σ .

- We describe $P_M = (Q^M, \Delta^M)$ in Figure 16, this is where the machine is simulated: the process v_0 evolves in the sets Loc, we will see that if it takes a transition of the machine which should not be taken (a false test to 0, a decrement not possible, or an increment not feasible because of lack of processes), then other processes will fail in their execution, and q_f will not be covered.
- We describe $P_1 = (Q^1, \Delta^1)$ in Figure 18. The processes evolving on P_1 will simulate counters' values, each of them representing one unit of one of the counter: when the process is on x_1^1 [resp. x_2^1] it represents a unit of counter x_1 [resp. x_2].
- P_2 and P_3 are obtained from P_1 by replacing each $j \in \{0, 1, 2\}$ appearing in the protocol (states and transitions) by $j \oplus 1$ for P_2 and $j \ominus 1$ for P_3 . As in P_1 , processes evolving on P_2 or P_3 will simulate counters' values: for $x \in X$, a process on x^2 or x^0 represents one unit of x .
- We describe $P_{\text{tail}} = (Q^t, \Delta^t)$ in Figure 17. The process v_n will check that all the operations have been correctly executed. When it will receive message "done" (first sent by the process P_M), it will reach state q_f .

State \odot is a deadlock state (there is no outgoing transitions from \odot). In order for P to be phase-bounded, we actually duplicate \odot state as much as needed so there is no contradictions (one state per reception phase). For instance, if there are two receptions transitions $(q, ?m, \odot)$, $(q', ?m', \odot)$ with q and q' not in the same phase, we duplicate \odot into two states \odot, \odot' such that $(q, ?m, \odot)$, and $(q', ?m', \odot')$. For ease of notation, when referring to any of those deadlock states, we use \odot .

As a result, we get the following lemma.

► **Lemma C.1.** *P is 6-phase-bounded.*



© L. Guillou and A. Sangnier and N. Sznajder;
licensed under Creative Commons License CC-BY 4.0

Leibniz International Proceedings in Informatics

Schloss Dagstuhl – Leibniz-Zentrum für Informatik, Dagstuhl Publishing, Germany

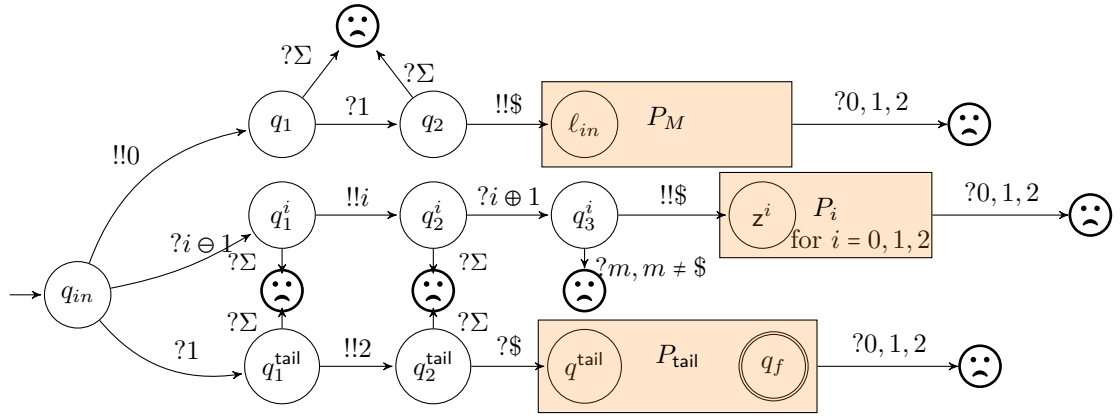

■ **Figure 14** Description of P , the protocol of the reduction.

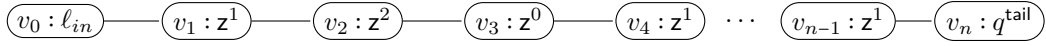

■ **Figure 15** Particular shape of configurations from which we can simulate the Minsky machine.

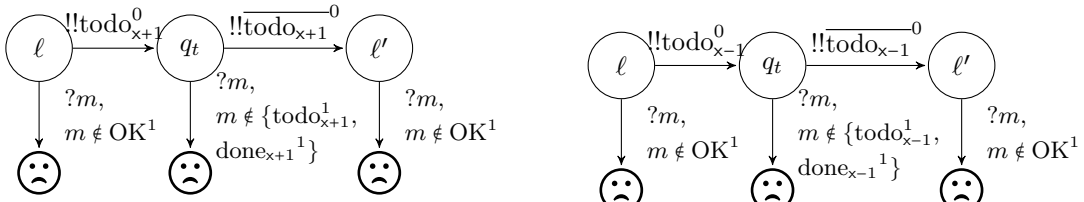

(a) Translation of a decrement transition $t = (\ell, \text{inc}(x), \ell')$.

(b) Translation of a decrement transition $t = (\ell, \text{dec}(x), \ell')$.

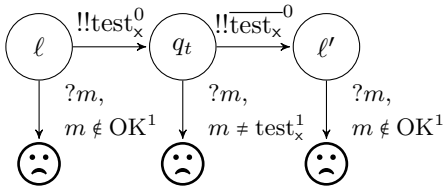

(c) Translation of a test transition $t = (\ell, \text{test}(x), \ell')$.

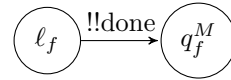

(d) End of the simulation.

■ **Figure 16** Description of P_M .

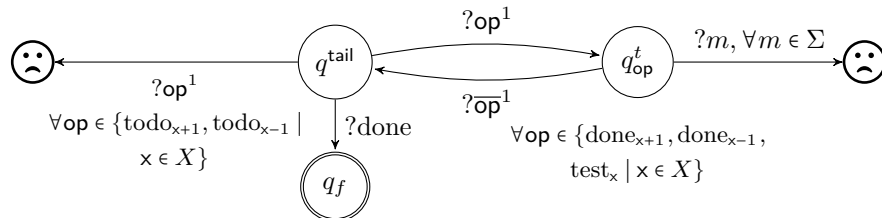

■ **Figure 17** Description of P_{tail} .

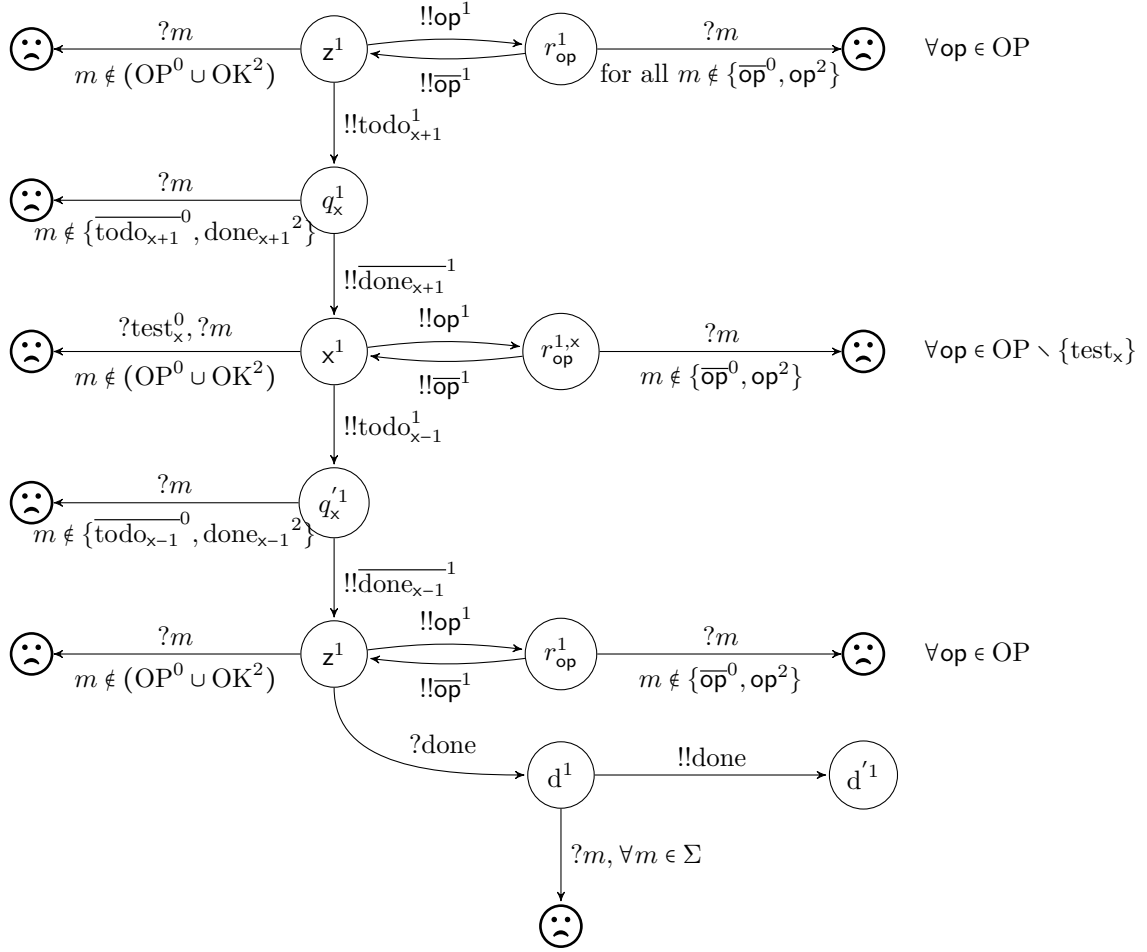

■ **Figure 18** Description of P_1 . We draw two states z^1 for readability's sake. P_2 is obtained by replacing each $j \in \{0, 1, 2\}$ by $j \oplus 1$ and P_0 by replacing each $j \in \{0, 1, 2\}$ by $j \ominus 1$.

Proof. We give the partition of states satisfying the 6-phase-bounded protocols condition.

- $Q_0 = \{q_{in}\};$
- $Q_1^b = \{q_1\}$ and $Q_1^r = \{q_1^i \mid i \in \{0, 1, 2\}\} \cup \{q_1^{\text{tail}}\} \cup \{\odot\};$
- $Q_2^b = \{q_2^i \mid i \in \{0, 1, 2\}\} \cup \{q_2^{\text{tail}}\}$ and $Q_2^r = \{q_2\} \cup \{\odot\};$
- $Q_3^b = \{\ell, q_t, q_f^M \mid \ell \in \text{Loc}, t \in \text{Trans}\}$ and $Q_3^r = \{q_3^i \mid i \in \{0, 1, 2\}\} \cup Q^t \cup \{\odot\};$
- $Q_4^b = \{q \in Q^i \setminus \odot, d^i, d^i i \in \{0, 1, 2\}\}$ and $Q_4^r = \{\odot\};$
- $Q_5^b = \emptyset$ and $Q_5^r = \{d^i \mid i \in \{0, 1, 2\}\} \cup \{\odot\};$
- $Q_6^b = \{d^i \mid i \in \{0, 1, 2\}\}$ and $Q_6^r = \{\odot\}.$

◀

Note that P is also k -phase-bounded for any $k > 6$ by taking $Q_7^r = \{\odot\}$, $Q_7^b = \emptyset$ and $Q_j^y = \emptyset$ for any $j \geq 8$ and $y \in \{r, b\}$.

In the rest of this section, we denote $b_i = i \bmod 3$ for all $i \in \mathbb{N}$.

C.2 Completeness of the Reduction.

► **Lemma C.2.** *If there is a transition sequence t_1, \dots, t_n such that $(\ell_{in}, 0, 0) \xrightarrow{t_1} (\ell_1, x_1^1, x_2^1) \xrightarrow{t_2} \dots \xrightarrow{t_n} (\ell_f, 0, 0)$, then there exist $C \in \mathcal{I}, C' = (\Gamma', L') \in \mathcal{C}$, such that $C \rightarrow^* C'$ and there exists $v \in V(\Gamma')$ such that $L'(v) = q_f$.*

Proof. We denote by m' the maximal value reached by counters during the machine execution, i.e. $m' = \max_{1 \leq i \leq n} (x_1^i + x_2^i)$. We define m as $m' + 1$. We suppose wlog that $m \bmod 3 = 1$, if it is not the case, we redefine m as the first integer greater than m equal to 1 modulo 3.

Define $\Gamma = (V, E)$ such that: $V = \{v_0, v_1, \dots, v_m, v_{m+1}\}$ and $E = \{(v_i, v_{i+1}) \mid 0 \leq i < m + 1\}$, and take $C_0 = (\Gamma, L_0)$ where for all $v \in V$, $L_0(v) = q_{in}$.

We define the following sequence of configurations: $C_0 \xrightarrow{v_0, t_0} C_1 \xrightarrow{v_1, t_1} \dots \xrightarrow{v_m, t_m} C_{m+1} \xrightarrow{v_0, t'_0} C_{m+2} \xrightarrow{v_1, t'_1} \dots \xrightarrow{v_m, t'_m} C_{2m+3}$ where:

$$t_i = \begin{cases} (q_{in}, !!0, q_1) & \text{for } i = 0 \\ (q_1^{b_i}, !!b_i, q_2^{b_i}) & \text{for } 1 \leq i \leq m \\ (q_1^{\text{tail}}, !!2, q^{\text{tail}}) & \text{for } i = m + 1. \end{cases}$$

and

$$t'_i = \begin{cases} (q_2, !!\$, \ell_{in}) & \text{for } i = 0 \\ (q_3^{b_i}, !!\$, z^{b_i}) & \text{for } 1 \leq i \leq m. \end{cases}$$

Denote $C_{m+2} = (\Gamma, L_{m+2})$ and $C_{2m+3} = (\Gamma, L_{2m+3})$, it holds that: $L_{m+2}(v_0) = q_2$, and $L_{m+2}(v_i) = q_3^{b_i}$ for all $1 \leq i \leq m$ and $L_{m+2}(v_{m+1}) = q_2^{\text{tail}}$. And: $L_{2m+3}(v_0) = \ell_{in}$, $L_{2m+3}(v_{m+1}) = q^{\text{tail}}$ and for all $1 \leq i \leq m$, $L_{2m+3}(v_i) = z^{b_i}$.

We will now build $C'_0 \rightarrow^+ C'_1 \rightarrow^+ \dots \rightarrow^+ C'_n$ such that for all $0 \leq i \leq n$, $C'_i = (\Gamma, L'_i)$, and: $L'_i(v_0) = \ell_i$, $L'_i(v_{m+1}) = q^{\text{tail}}$, and $x_1^i = |\{v \mid L'_i(v) = x_1^j, 0 \leq j \leq 2\}|$, $x_2^i = |\{v \mid L'_i(v) = x_2^j, 0 \leq j \leq 2\}|$, and for all $1 \leq j \leq m$, $L'_i(v_j) \in \{z^{b_j}, x_1^{b_j}, x_2^{b_j}\}$.

For $i = 0$, we take $C'_0 = C_{2m+3}$. By construction, it respects the conditions. Assume we built C'_i for some $0 \leq i < n$, and consider $(\ell_i, x_1^i, x_2^i) \xrightarrow{t_{i+1}} (\ell_{i+1}, x_1^{i+1}, x_2^{i+1})$. For readability's sake, we note $t = (\ell, \text{op}, \ell')$ and we rename $x_1^i, x_2^i, x_1^{i+1}, x_2^{i+1}$ by x_1, x_2, x'_1, x'_2 , finally we rename C'_i by C .

By induction hypothesis, $C = (\Gamma, L)$ is such that $L(v_0) = \ell$, $L(v_{m+1}) = q^{\text{tail}}$ and $x_1 = |\{v \mid L(v) = x_1^j, 0 \leq j \leq 2\}|$, $x_2 = |\{v \mid L(v) = x_2^j, 0 \leq j \leq 2\}|$, and for all $1 \leq j \leq m$, $L(v_j) \in \{z^k, x_1^k, x_2^k \mid k = j \bmod 3\}$. We distinguish the following cases:



- $\text{op} = \text{inc}(x)$ with $x \in X$, then by definition of m , $x_1 + x_2 < m - 1$. Hence, $|\{v \mid L(v) = x_1^j, 0 \leq j \leq 2\}| + |\{v \mid L(v) = x_2^j, 0 \leq j \leq 2\}| < m - 1$, and so there exists $v_f \in \{v_1, \dots, v_{m-1}\}$ such that $L(v_f) \notin \{x_2^j, x_1^j \mid 0 \leq j \leq 2\}$ with $1 \leq f \leq m$. Let us denote f the first such index. By hypothesis, $L(v_f) \in \{z^k, x_1^k, x_2^k\}$ for $k = f \bmod 3$, hence $L(v_f) = z^k$.

We denote y the counter such that $\{x, y\} = \{x_1, x_2\}$. We also denote $p_i := L(v_i)$, and p'_i the state such that:

$$p'_i = \begin{cases} r_{\text{inc}_x}^{b_i} & \text{if } p_i = z^{b_i}, i \neq f \\ r_{\text{inc}_x}^{b_i, x} & \text{if } p_i = x^{b_i}, i \neq f \\ r_{\text{inc}_x}^{b_i, y} & \text{if } p_i = y^{b_i}, i \neq f \\ q_x^{b_i} & \text{if } i = f \end{cases}$$

Consider the following sequence:

$$\begin{aligned} C^0 &\xrightarrow{v_0, (\ell, \overline{\text{todo}_{x+1}^0}, q_t)} C^1 \xrightarrow{v_1, (p_1, \overline{\text{todo}_{x+1}^{b_1}}, p'_1)} C^2 \xrightarrow{v_0, (q_t, \overline{\text{todo}_{x+1}^0}, \ell')} C^3 \xrightarrow{v_2, (p_2, \overline{\text{todo}_{x+1}^{b_2}}, p'_2)} \\ C^4 &\xrightarrow{v_1, (p'_1, \overline{\text{todo}_{x+1}^{b_1}}, p_1)} C^5 \xrightarrow{v_3, (p_3, \overline{\text{todo}_{x+1}^{b_3}}, p'_3)} C^6 \xrightarrow{v_2, (p'_2, \overline{\text{todo}_{x+1}^{b_2}}, p_2)} \\ C^7 &\xrightarrow{v_4, (p_4, \overline{\text{todo}_{x+1}^{b_4}}, p'_4)} \dots \xrightarrow{v_{f-1}, (p_{f-1}, \overline{\text{todo}_{x+1}^{b_{f-1}}}, p'_{f-1})} C^{2(f-1)} \xrightarrow{v_{f-2}, (p'_{f-2}, \overline{\text{todo}_{x+1}^{b_{f-2}}}, p_{f-2})} \\ C^{2f-1} &\xrightarrow{v_f, (p_f, \overline{\text{todo}_{x+1}^{b_f}}, p'_f)} C^{2f} \xrightarrow{v_{f-1}, (p'_{f-1}, \overline{\text{todo}_{x+1}^{b_{f-1}}}, p_{f-1})} \\ C^{2f+1} &\xrightarrow{v_{f+1}, (p_{f+1}, \overline{\text{done}_{x+1}^{b_{f+1}}}, p'_{f+1})} C^{2f+2} \xrightarrow{v_f, (p'_f, \overline{\text{done}_{x+1}^{b_f}}, x^{b_f})} \\ C^{2f+3} &\xrightarrow{v_{f+2}, (p_{f+2}, \overline{\text{done}_{x+1}^{b_{f+2}}}, p'_{f+2})} \dots \xrightarrow{v_m, (p_m, \overline{\text{done}_{x+1}^{b_m}}, p'_m)} \\ C^{2m} &\xrightarrow{v_{m-1}, (p'_{m-1}, \overline{\text{done}_{x+1}^{b_{m-1}}}, p_{m-1})} C^{2m+1} \xrightarrow{v_m, (p'_m, \overline{\text{done}_{x+1}^{b_m}}, p_{b_m})} C^{2m+2} \end{aligned}$$

Note that if $f = 1$, v_1 broadcasts $\text{inc}_x^{b_1}$ and $\overline{\text{done}_{x+1}^{b_1}}$, and every vertices except v_0 broadcast overlined messages as well. Furthermore, as $f \leq m - 1$, v_m always broadcasts $\overline{\text{todo}_{x+1}^{b_m}} \cdot \overline{\text{done}_{x+1}^{b_m}}$, hence $L^{2m}(v_{m+1}) = q_{\text{todo}_{x+1}}^t$ and $L^{2m+2}(v_{m+1}) = q^{\text{tail}}$. At the end of the sequence, $C^{2m+2} = (\Gamma, L^{2m+2})$ is such that $L^{2m+2}(v_0) = \ell'$, $L^{2m+2}(v_{m+1}) = q^{\text{tail}}$, and, $L^{2m+2}(v_f) = x^{b_f}$ and for all $1 \leq i \leq m$, $i \neq f$, $L^{2m+2}(v_i) = L(v_i)$.

- $\text{op} = \text{dec}(x)$, the sequence is analogous, this time we justify the existence of one process on a state x^j for some $0 \leq j \leq 2$ by induction hypothesis.
- $\text{op} = \text{test}(x)$, the only difference is that the propagated message does not change, all processes can propagate the message as no processes is on a state x^i for some $0 \leq i \leq 2$ (this is true by induction hypothesis).

Hence, we built a sequence of configurations $C'_0 \rightarrow^+ C'_1 \rightarrow^+ \dots \rightarrow^+ C'_n$ such that $C'_n = (\Gamma, L_n)$ with $L_n(v_0) = \ell_f$, $L_n(v_{m+1}) = q^{\text{tail}}$ and for all $0 \leq i \leq m$, $L_n(v_i) = z^{b_i}$. Finally, we build the sequence leading to the final configuration, from C'_n : $C'_n \xrightarrow{v_0, (\ell_f, \overline{\text{done}}, q_f^M)} C'_{n+1} \xrightarrow{v_1, (d^{b_1}, \overline{\text{done}}, d'^{b_1})} C'_{n+2} \xrightarrow{v_2, (d^{b_2}, \overline{\text{done}}, d'^{b_2})} \dots \xrightarrow{v_m, (d^{b_m}, \overline{\text{done}}, d'^{b_m})} C'_{n+m+1}$. Denote $C'_{n+m+1} = (\Gamma, L_{n+m+1})$, it holds that $L_{n+m+1}(v_{m+1}) = q_f$. \blacktriangleleft

C.3 Correctness of the Reduction.

This subsection is devoted to prove the following lemma.



© L. Guillou and A. Sangnier and N. Sznajder;
licensed under Creative Commons License CC-BY 4.0



Leibniz International Proceedings in Informatics

Schloss Dagstuhl – Leibniz-Zentrum für Informatik, Dagstuhl Publishing, Germany

► **Lemma C.3.** *If there exist $C \in \mathcal{I}$, $C' = (\Gamma', L') \in \mathcal{C}$ such that $C \rightarrow^* C'$ and there exists $v \in V(\Gamma')$ such that $L'(v) = q_f$, then there exists a transition sequence t_1, \dots, t_n such that $(\ell_{in}, 0, 0) \xrightarrow{t_1} (\ell_1, x_1^1, x_2^1) \xrightarrow{t_2} \dots \xrightarrow{t_n} (\ell_f, 0, 0)$.*

We say that a process $v \in V(\Gamma)$ is active if it broadcasts (at least) one message during the execution. We denote $C_0 \rightarrow C_1 \rightarrow \dots \rightarrow C_n$ where for each $0 \leq i \leq n$, $C_i = (\Gamma, L_i)$, $C_0 = C$ and $C_n = C'$. Furthermore, we denote v_f the process covering q_f . Lastly, for sake of readability, for $C, C' \in \mathcal{C}$, $m \in \Sigma$ and $v \in V(\Gamma)$, we denote $C \xrightarrow{v, a} C'$ when there exists a transition $(q, !!a, q') \in \Delta$ for some $q, q' \in Q$ such that $C \xrightarrow{v, (q, !!a, q')} C'$.

C.3.1 First step: Structure.

In a first step we prove that from the execution between C and C' , one can extract a set of vertices $V = \{v_0, v_1, \dots, v_m, v_{m+1}\}$ for some $m \in \mathbb{N}$ forming a *line* (i.e. for all $0 \leq i \leq m$, $\langle v_i, v_{i+1} \rangle \in E(\Gamma)$). And such that v_{m+1} covers q_f and neighbors of vertices in V which are not in V are not active (i.e. they do not broadcast anything). This subsection is devoted to prove the following lemma.

► **Lemma C.4.** *There exists $V = \{v_0, v_1, \dots, v_m, v_{m+1}\} \subseteq V(\Gamma)$, such that for all $0 \leq i \leq m$, $\langle v_i, v_{i+1} \rangle \in E(\Gamma)$ and $\exists j_0, j_1, \dots, j_m$ such that $L_{j_0}(v_0) = \ell_{in}$, $L_{j_m}(v_{m+1}) = q^{\text{tail}}$ and for all $1 \leq i \leq m$, $L_{j_i}(v_i) = z^{b_i}$ and for all other vertex $v \in V(\Gamma) \setminus V$ which is a neighbor of a vertex $v' \in V$, v is not active. Furthermore, $m \bmod 3 = 1$.*

By construction of the protocol, v_f receives message "done" from a process v_1 before reaching q_f . This process again either sends "done" from state ℓ_f or receives it before broadcasting it from a new process v_2 (note that $v_2 \neq v_f$ as "done" can be sent only once and v_f broadcasts it after the broadcast of v_1). In the second case, we can reiterate the reasoning. We do so until finding a process (let us denote it v_{m+1}) sending "done" from ℓ_f and we note v_1, \dots, v_m the intermediate processes. The process v_{m+1} exists as there is a finite number of processes. Furthermore, $\langle v_f, v_1 \rangle \in E(\Gamma)$ and for all $0 \leq i < m$, $\langle v_i, v_{i+1} \rangle \in E(\Gamma)$. We rename v_i by v_{m+1-i} for all $1 \leq i \leq m+1$, and v_f by v_{m+1} . Denote $V = \{v_0, \dots, v_{m+1}\}$. Note that there exists $j_0 < j_{m+1}$ such that $L_{j_0}(v_0) = \ell_{in}$ as v_0 broadcasts "done" from ℓ_f , and $L_{j_{m+1}}(v_{m+1}) = q^{\text{tail}}$ as v_{m+1} reaches state q_f from q^{tail} after v_0 reached ℓ_f . Furthermore, observe that for all $v \in V \setminus \{v_0, v_{m+1}\}$, there exists $i \in \{0, 1, 2\}$ such that there exists $j_1 < j$ with $L_j(v) = z^i$.

We get the two following lemmas.

► **Lemma C.5.** v_0 has only one active neighbor before broadcasting "done".

► **Lemma C.6.** v_{m+1} has only one active neighbor before receiving "done".

Indeed, otherwise, v_0 (or v_m) has two neighbors sending two messages $i_1, i_2 \in \{0, 1, 2\}$, by construction of P , one of the message will bring v_0 in \odot . With a similar argument, we get the following lemma.

► **Lemma C.7.** *Let $v_k \in V$ for some $1 \leq k \leq m$, v_k has only two active neighbors before broadcasting "done".*

We can now prove the following lemma.

► **Lemma C.8.** *There exist $j_0 < j_1 < \dots < j_m$, such that for all $0 \leq k \leq m+1$, $C_{j_k} \xrightarrow{v_k, b_k} C_{j_{k+1}}$. Furthermore $m+1 = 2 \bmod 3$.*



Proof. We prove the lemma by induction on $0 \leq k \leq m+1$. For $k=0$, it follows directly from the construction of P and the fact that there exists j such that $L_j(v_0) = \ell_f$ (v_0 is the first process to broadcast "done"). Denote j_0 such that $C_{j_0} \xrightarrow{v_0,0} C_{j_0+1}$.

Assume the property to hold for some $1 \leq k \leq m+1$ and denote $j_0 < j_1 < \dots < j_k$ such that for all $0 \leq k' \leq k$, $C_{j_{k'}} \xrightarrow{v_{k'}, b_{k'}} C_{j_{k'+1}}$.

Case $k+1 < m+1$. As $k+1 < m+1$, by construction of V , there exists $i \in \{0, 1, 2\}$ such that there exists j with $L_j(v_{k+1}) = z^i$. By Lemma C.7, v_{k+1} has exactly two active neighbors, which are by construction of V , v_k and v_{k+2} . Denote $i_{k+1} \in \{0, 1, 2\}$ the integer such that v_{k+1} receives "done" from $z^{i_{k+1}}$. By induction hypothesis, $C_{j_k} \xrightarrow{v_k, b_k} C_{j_k+1}$. We distinguish two cases: (a) $k=0$ and (b) $k>0$.

Subcase (a) $k=0$. Assume v_{k+1} broadcasts i_{k+1} from an index $j < j_0$. Observe that $L_j(v_0) = q_{in}$ and so $L_{j+1}(v_0) = q_1^{i_{k+1}}$ which contradicts the fact that v_0 broadcasts "done" from ℓ_f , hence, $j_0 < j$, and so $L_{j_0}(v_{k+1}) = q_{in}$, and $L_{j_0+1}(v_1) = q_1^1$. Hence $i_{k+1} = 1$ and $k+1 = 1$.

Subcase $k>0$. Consider v_{k-1} , by induction hypothesis $j_{k-1} < j_k$ with $C_{j_{k-1}} \xrightarrow{v_{k-1}, b_{k-1}} C_{j_{k-1}+1}$ and $C_k \xrightarrow{v_k, b_k} C_{k+1}$. Hence, as by Lemma C.7, v_k has only two active neighbors, only v_{k+1} can broadcast $(b_k + 1) \bmod 3$ once v_k broadcast b_k . Hence, $i_{k+1} = (b_k + 1) \bmod 3 = b_{k+1}$. Hence there exists $j_{k+1} > j_k$ such that $C_{j_{k+1}} \xrightarrow{v_{k+1}, b_{k+1}} C_{j_{k+1}+1}$.

Case $k+1 = m+1$. By construction of V , there exists j'_{m+1} such that $L_{j'_{m+1}}(v_{m+1}) = q^{\text{tail}}$. By Lemma C.6, v_{m+1} has exactly one active neighbor and this neighbor broadcasts "1". As $m \geq 1$, consider v_m . By induction hypothesis, and construction of P , there exists a unique j_m such that $C_{j_m} \xrightarrow{v_m, b_m} C_{j_m+1}$. Hence, $b_m = m \bmod 3 = 1$, finally there exists $j_{m+1} > j_m$ such that $C_{j_{m+1}} \xrightarrow{v_{m+1}, 2} C_{j_{m+1}+1}$. ◀

We are now ready to prove Lemma C.4.

Proof of Lemma C.4. Let $V = \{v_0, \dots, v_{m+1}\}$ such that, there exist j_0, j_1, \dots, j_{m+1} with $L_{j_0}(v_0) = \ell_f$, $L_{j_m}(v_{m+1}) = q^{\text{tail}}$ and for all $1 \leq k \leq m$, there exists $i \in \{0, 1, 2\}$ with $L_{j_k}(v_k) = z^i$.

From Lemma C.8 there exists $j'_0 < \dots < j'_{m+1}$ with $C_{j'_k} \xrightarrow{b_k} C_{j'_{k+1}}$ for all $0 \leq k \leq m+1$, and $(m+1) \bmod 3 = 2$. Furthermore, $L_{j'_1}(v_0) = q_1$ and $L_{j'_1+1}(v_0) = q_2$. In the same way, for all $1 \leq k \leq m$, $L_{j'_{k+1}}(v_k) = q_2^{b_k}$ and $L_{j'_{k+1}+1}(v_k) = q_3^{b_k}$. Lastly, $L_{j'_{m+1}+1}(v_{m+1}) = q_2^{\text{tail}}$. Hence, by construction of P , there exist $j''_0 \dots j''_m, j''_{m+1}$ such that $L_{j''_i}(v_i) = z^{b_i}$ for all $1 \leq i \leq m$, and $L_{j''_0}(v_0) = \ell_{in}$ and $L_{j''_{m+1}}(v_{m+1}) = q^{\text{tail}}$. ◻

C.3.2 Second step: the simulation.

We are now ready to extract the execution of the machine from the execution between C and C' . Fix $V = \{v_0, \dots, v_{m+1}\}$ the set of vertices from Lemma C.4. We forget about nodes not in V , as they are useless for v_f to cover q_f : either they are neighbors of some node in V and so they are inactive, either they are not connected to v_f through an inactive neighbor, or they are not connected to v_f .

Let $C, C' \in \mathcal{C}$ and $v \in \mathbb{V}(\Gamma)$, we denote $C \xrightarrow{|v|^*} C'$ whenever $C = C'$ or there exist $(u_1, t_1), \dots, (u_N, t_N)$, with $N \in \mathbb{N}$ and for all $1 \leq i \leq N$, $u_i \in \mathbb{V}(\Gamma) \setminus \{v\}$, $t_i \in \Delta$, and $C_1 \xrightarrow{u_1, t_1} \xrightarrow{u_2, t_2} \dots \xrightarrow{u_N, t_N} C'$.

Let $\text{op} \in \text{OP}$, we denote the set $\text{OK}(\text{op})$ as follows:

- $\text{OK}(\text{todo}_{x+1}) = \{\overline{\text{todo}_{x+1}}, \overline{\text{done}_{x+1}}\}$ for some $x \in X$;
- $\text{OK}(\text{todo}_{x-1}) = \{\overline{\text{todo}_{x-1}}, \overline{\text{done}_{x-1}}\}$ for some $x \in X$;
- $\text{OK}(\text{done}_{x+1}) = \{\overline{\text{done}_{x+1}}\}$ for some $x \in X$;
- $\text{OK}(\text{done}_{x-1}) = \{\overline{\text{done}_{x-1}}\}$ for some $x \in X$;
- $\text{OK}(\text{test}_x) = \{\overline{\text{test}_x}\}$ for some $x \in X$.

We denote $\text{Act} = \{x+1, x-1, x=0 \mid x \in X\}$.

We start by some observations.

► **Lemma C.9.** *For all $0 < i < m+1$, the word broadcast by v_i belongs to the language $E_i = b_i \cdot \$ \cdot (\sum_{\text{op} \in OP, \text{ok} \in \text{OK}(\text{op})} \text{op}^{b_i} \cdot \text{ok}^{b_i})^* \cdot \text{done}$. Furthermore, the word broadcast by v_0 belongs to the language $E_0 = 0 \cdot \$ \cdot (\sum_{\text{op} \in \{\text{todo}_{x+1}, \text{todo}_{x-1}, \text{test}_x \mid x \in X\}} (\text{op}^0 \cdot \overline{\text{op}}^0))^* \cdot \text{done}$.*

Proof. Follows from the construction of V and P . ◀

We denote n_i the index from which v_i broadcasts "done" for all $0 \leq i \leq m$. It holds that $n_0 < \dots < n_m$ by construction of V .

► **Lemma C.10.** *For all $0 \leq i < m$, $0 < j_1 < j_2 \leq n_i$, $\text{op} \in OP$, $\text{ok} \in \text{OK}(\text{op})$, such that $C_{j_1} \xrightarrow{v_i, \text{op}^{b_i}} C_{j_1+1} \xrightarrow{|v_i|^*} C_{j_2} \xrightarrow{v_i, \text{ok}^{b_i}} C_{j_2+1}$ there exists a unique $j_1 < j_3 < j_2$ such that $C_{j_3} \xrightarrow{v_{i+1}, w} C_{j_3+1}$ for some $w \in \Sigma$. Furthermore, if $\text{ok} = \overline{\text{op}}_2$, then $w = \text{op}_2^{b_{i+1}}$.*

Proof. We denote $b := b_{i+1}$ for readability's sake, and denote $\text{ok} = \overline{\text{op}}_2$. Recall that $n_i < n_{i+1}$ and $b = b_i \oplus 1$. Hence:

- if $\text{op}_2 = \text{todo}_{x+1}$ for some $x \in X$, then $L_{j_2}(v_{i+1}) \in \{r_{\text{op}_2}^b, r_{\text{op}_2}^{b, x_1}, r_{\text{op}_2}^{b, x_2}, q_x^b\}$;
- if $\text{op}_2 = \text{todo}_{x-1}$ for some $x \in X$, then $L_{j_2}(v_{i+1}) \in \{r_{\text{op}_2}^b, r_{\text{op}_2}^{b, x_1}, r_{\text{op}_2}^{b, x_2}, q_x^b\}$;
- otherwise, $L_{j_2}(v_{i+1}) \in \{r_{\text{op}_2}^b, r_{\text{op}_2}^{b, x_1}, r_{\text{op}_2}^{b, x_2}\}$.

Indeed, otherwise, $L_{j_2+1}(v_{i+1}) = \ominus$ as $(L_{j_2}(v_{i+1}), ?\overline{\text{op}}_2^{b_i}, \ominus) \in \Delta_b$. Furthermore:

- if $\text{op} = \text{test}_x$ for some $x \in X$, then $L_{j_1}(v_{i+1}) \in \{z^b, y^b \mid y \in X \setminus \{x\}\}$;
- otherwise, $L_{j_1}(v_{i+1}) \in \{z^b, y^b \mid y \in X\}$.

Indeed, otherwise, $L_{j_2+1}(v_{i+1}) = \ominus$ as $(L_{j_1}(v_{i+1}), ?\text{op}^{b_i}, \ominus) \in \Delta_b$. Note that any path between $L_{j_1+1}(v_{i+1})$ and $L_{j_2}(v_{i+1})$ requires at least one broadcast from v_{i+1} , and in particular a broadcast of op_2^b . Hence, there exists $j_1 < j_3 < j_2$ such that $C_{j_3} \xrightarrow{v_{i+1}, \text{op}_2^b} C_{j_3+1}$, consider the smallest such index. We now show that this is the unique index between j_1 and j_2 from which v_{i+1} broadcasts something.

If there exists $j_1 < j_4 < j_3$ such that $C_{j_4} \xrightarrow{v_{i+1}, w} C_{j_4+1}$ for some $w \in \Sigma$, and take j_4 the largest such index. By construction of j_4 and j_3 , $L_{j_4+1}(v_{i+1}) \in \{z^b, y^b \mid y \in X\}$, and so $w \in \text{OK}^b$. Hence, it holds that $L_{j_4}(v_i) \notin \{r_{\text{op}_2}^{b_i}, r_{\text{op}_2}^{b_i, x_1}, r_{\text{op}_2}^{b_i, x_2}, q_x^{b_i}, q_x^{b_i}\}$, as otherwise, $(L_{j_4}(v_i), ?w, \ominus)$. This contradicts the fact that $C_{j_1+1} \xrightarrow{|v_i|^*} C_{j_4}$ and $C_{j_1} \xrightarrow{v_i, \text{op}^{b_i}} C_{j_1+1}$. With a similar argument, there is no $j_3 < j_5 \leq j_2$ such that $C_{j_5} \xrightarrow{v_{i+1}, w} C_{j_5+1}$ for some $w \in \Sigma$. ◀

► **Lemma C.11.** *For all $0 \leq i < m$, $0 < j_1 < j_2 \leq n_i$, $\text{op} \in OP$, $w \in \Sigma$, such that $C_{j_1} \xrightarrow{v_i, \overline{\text{op}}^{b_i}} C_{j_1+1} \xrightarrow{|v_i|^*} C_{j_2} \xrightarrow{v_i, w} C_{j_2+1}$, there exists a unique $j_1 < j_3 < j_2$ such that $C_{j_3} \xrightarrow{v_{i+1}, w'} C_{j_3+1}$ for some $w' \in \Sigma$. Furthermore, $w' = \text{ok}'^b$ with $\text{ok}' \in \text{OK}(\text{op})$.*



Proof. We denote $b := b_{i+1}$ for readability's sake. Note that from Lemma C.9, $w \in \text{OP}^{b_i} \cup \{\text{done}\}$. Recall that $n_i < n_{i+1}$ and $b = b_i \oplus 1$. Hence, $L_{j_2}(v_{i+1}) \in \{z^b, x_1^b, x_2^b\}$, as otherwise $L_{j_2+1}(v_{i+1}) = \odot$, hence $(L_{j_2}(v_{i+1}), ?w, \odot) \in \Delta_b$. Furthermore,

- if $\text{op} = \text{todo}_{x+1}$ for some $x \in X$, then $L_{j_1}(v_{i+1}) \in \{r_{\text{op}}^b, r_{\text{op}}^{b, x_1}, r_{\text{op}}^{b, x_2}, q_x^b\}$;
- if $\text{op} = \text{todo}_{x-1}$ for some $x \in X$, then $L_{j_1}(v_{i+1}) \in \{r_{\text{op}}^b, r_{\text{op}}^{b, x_1}, r_{\text{op}}^{b, x_2}, q_x^b\}$;
- otherwise, $L_{j_1}(v_{i+1}) \in \{r_{\text{op}}^b, r_{\text{op}}^{b, x_1}, r_{\text{op}}^{b, x_2}\}$.

Note that any path between $L_{j_1}(v_{i+1})$ and $L_{j_2}(v_{i+1})$ requires at least one broadcast from v_{i+1} of a message w' , and if w' is the last broadcast from v_{i+1} before reaching $L_{j_2}(v_{i+1})$, it holds that:

- if $\text{op} = \text{todo}_{x+1}$, then $w' \in \{\overline{\text{todo}_{x+1}}^b, \text{todo}_{x+1}^b\}$;
- if $\text{op} = \text{todo}_{x-1}$, then $w' \in \{\overline{\text{todo}_{x-1}}^b, \text{todo}_{x-1}^b\}$;
- otherwise, $w' = \overline{\text{op}}^b$.

Hence $w' = \text{ok}^b$ with $\text{ok}' \in \text{OK}(\text{op})$. We now show that j_3 is the unique index between j_1 and j_2 from which v_{i+1} broadcasts something. Remember that it has been chosen as the greatest such index.

If there exists $j_1 < j_4 < j_3$ such that $C_{j_4} \xrightarrow{v_{i+1}, w''} C_{j_4+1}$ for some $w'' \in \Sigma$, and take j_4 the largest such index. By construction of j_3 and j_4 , $L_{j_4+1}(v_{i+1}) \in \{r_{\text{op}}^b, r_{\text{op}}^{b, x}, q_x^b, q_x^{b'} \mid x \in X\}$, and so $w'' \in \text{OP}^b$. Hence, it holds that $L_{j_4}(v_i) \notin \{r_{\text{op}}^{b_i}, r_{\text{op}}^{b_i, x} \mid \text{op} \in \text{OP}, x \in X\}$, as otherwise, $(L_{j_4}(v_i), ?w, \odot)$. This contradicts the fact that $C_{j_1+1} \xrightarrow{|v_i} C_{j_4}$ and $C_{j_1} \xrightarrow{v_i, \overline{\text{op}}^{b_i}} C_{j_1+1}$. ◀

► **Lemma C.12.** *Let $0 < j_1^0 < j_2^0 < n_0$ and $\text{op} \in \{\text{todo}_{x+1}, \text{todo}_{x-1}, \text{test}_x \mid x \in X\}$ such that $C_{j_1^0} \xrightarrow{v_0, w_0} C_{j_1^0+1} \xrightarrow{|v_0} C_{j_2^0} \xrightarrow{v_0, w_0'} C_{j_2^0+1}$ and $w_0 = \text{op}^0$ and $w_0' = \overline{\text{op}}^0$. Then there exists a unique sequence of indices $j_1^1, j_2^1, \dots, j_1^m, j_2^m$ such that for all $1 \leq i \leq m$:*

- $j_1^{i-1} < j_1^i < j_2^{i-1} < j_2^i < n_i$, and
- $C_{j_1^i} \xrightarrow{v_i, w_i} C_{j_1^i+1} \xrightarrow{*} C_{j_2^i} \xrightarrow{v_i, w_i'} C_{j_2^i+1}$ for some $w_i, w_i' \in \Sigma$, and
- if $w_{i-1} = \overline{\text{op}}_i^{b_{i-1}}$ for some $\text{op}_i \in \text{OP}$, then $w_i = \text{op}_i^{b_i}$ and $w_i' = \text{ok}_i^{b_i}$ with $\text{ok}_i \in \text{OK}(\text{op}_i)$.

Proof. Let $0 < j_1^0 < j_2^0 < n_0$ and $\text{op} \in \{\text{todo}_{x+1}, \text{todo}_{x-1}, \text{test}_x \mid x \in X\}$ such that $C_{j_1^0} \xrightarrow{v_0, \text{op}^0} C_{j_1^0+1} \xrightarrow{|v_0} C_{j_2^0} \xrightarrow{v_0, \overline{\text{op}}^0} C_{j_2^0+1}$.

We build the sequence of indexes $j_1^1, j_2^1, \dots, j_1^m, j_2^m$ and the sequence of operations $\text{op}_1, \dots, \text{op}_m$ such that $w_i = \text{op}_i^{b_i}$ and $w_i' = \text{ok}_i^{b_i}$ with $\text{ok}_i \in \text{OK}(\text{op}_i)$ inductively. Using Lemma C.10, there exists a unique $j_1^0 < j_1^1 < j_2^0$ such that $C_{j_1^1} \xrightarrow{v_1, w_1} C_{j_1^1+1}$ for some $w_1 \in \Sigma$, and it holds that $w_1 = \text{op}^1$. As $j_2^0 < n_0$, there exists $j_2^0 < n \leq n_0$ such that $C_n \xrightarrow{v_0, u} C_{n+1}$ for some $u \in \Sigma$. Using Lemma C.11, there exists a unique $j_2^0 < j_2^1 < n$ such that $C_{j_2^1} \xrightarrow{v_1, w_1'} C_{j_2^1+1}$ for some $w_1' \in \Sigma$ with $w_1' = \text{ok}_1^1$ and $\text{ok}_1 \in \text{OK}(\text{op})$.

Define $\text{op}_1 = \text{op}$. We found a unique pair of indexes j_1^1, j_2^1 such that $j_1^0 < j_1^1 < j_2^0 < j_2^1 \leq n_0 < n_1$ and $C_{j_1^1} \xrightarrow{v_1, w_1} C_{j_1^1+1} \xrightarrow{*} C_{j_2^1} \xrightarrow{v_1, w_1'} C_{j_2^1+1}$ for some $w_1, w_1' \in \Sigma$. Furthermore, $w_0 = \overline{\text{op}}^0$ and $w_1 = \text{op}_1^1$ and $w_1' = \text{ok}_1^1$ with $\text{ok}_1 \in \text{OK}(\text{op}_1)$.

Assume we have built $j_1^1, j_2^1, \dots, j_1^k, j_2^k$ for some $k < m$. And denote $C_{j_1^k} \xrightarrow{v_k, \text{op}_k^{b_k}} C_{j_1^k+1}$ and $C_{j_2^k} \xrightarrow{v_k, \text{ok}_k^{b_k}} C_{j_2^k+1}$ with $\text{ok}_k = \overline{\text{op}}_k^k$. Using Lemma C.10, there exists a unique $j_1^k < j_1^{k+1} < j_2^k$ such that $C_{j_1^{k+1}} \xrightarrow{v_{k+1}, w_{k+1}} C_{j_1^{k+1}+1}$ for some $w_{k+1} \in \Sigma$. Furthermore $w_{k+1} = \text{op}_k^{b_{k+1}}$.

As $j_2^k < n_k$, there exists $j_2^k < n \leq n_k$ such that $C_n \xrightarrow{v_k, u} C_{n+1}$ for some $u \in \Sigma$. Using Lemma C.11, there exists a unique $j_2^k < j_2^{k+1} < n \leq n_k < n_{k+1}$ such that $C_{j_2^k} \xrightarrow{v_{k+1}, w'_{k+1}} C_{j_2^{k+1}}$ for some $w'_{k+1} \in \Sigma$. Furthermore, $w'_{k+1} = \text{ok}'^b$ and $\text{ok}' \in \text{OK}(\text{op}'_k)$. ◀

Let $0 < j_1^0 < j_2^0 < n_0$ and $\text{op} \in \{\text{todo}_{x+1}, \text{todo}_{x-1}, \text{test}_x \mid x \in X\}$ such that $C_{j_1^0} \xrightarrow{v_0, \text{op}^0} C_{j_1^0+1} \xrightarrow{v_0} C_{j_2^0} \xrightarrow{v_0, \overline{\text{op}}^0} C_{j_2^0+1}$. We denote $\text{Seq}(j_1^0, j_2^0)$ the unique sequence of indexes $j_1^1, j_2^1, \dots, j_1^m, j_2^m$ defined in the previous lemma.

► **Lemma C.13.** *If $\text{op} = \text{test}_x$ for some $x \in X$, then for all $1 \leq i \leq m$, $L_{j_1^i}(v_i) = L_{j_2^i+1}(v_i) \in \{z^{b_i}, y^{b_i} \mid y \neq x\}$.*

Proof. From Lemma C.12, as $\text{OK}(\text{test}_x) = \{\overline{\text{test}_x}\}$, it holds that for all $1 \leq i \leq m$, $C_{j_1^i} \xrightarrow{v_i, \text{test}_x^{b_i}} C_{j_1^i+1}$, and $C_{j_2^i} \xrightarrow{v_i, \overline{\text{test}_x}^{b_i}} C_{j_2^i+1}$. As $C_{j_1^i+1} \xrightarrow{|v_i|^*} C_{j_2^i}$, by construction of the protocol, we have that $L_{j_1^i}(v_i) = L_{j_2^i+1}(v_i) \in \{z^{b_i}, y^{b_i} \mid y \neq x\}$. ◀

► **Lemma C.14.** *If $\text{op} = \text{todo}_{x+1}$ for some $x \in X$, then, there exists a unique $1 \leq p \leq m$ such that $L_{j_1^p}(v_p) = z^{b_p}$, $L_{j_2^p+1}(v_p) = x^{b_p}$, and for all $1 \leq i \leq m$, $i \neq p$, it holds that $L_{j_1^i}(v_i) = L_{j_2^i+1}(v_i) \in \{z^{b_i}, x_1^{b_i}, x_2^{b_i}\}$.*

Proof. Denote $\text{op}_0, \dots, \text{op}_m \in \text{OP}$, $\text{ok}_0, \dots, \text{ok}_m \in \text{OK}$ as defined in Lemma C.12.

We start by observing the following: Let $0 \leq i < m$ such that $\text{op}_i = \text{done}_{x+1}$, then $\text{op}_{i+1} = \text{done}_{x+1}$ and $\text{ok}_{i+1} = \overline{\text{done}_{x+1}}$. Indeed, it holds that $\text{ok}_i = \text{done}_{x+1}$ by definition of $\text{OK}(\text{done}_{x+1})$, hence . by Lemma C.12, $\text{op}_{i+1} = \text{done}_{x+1}$, and so $\text{ok}_{i+1} = \overline{\text{done}_{x+1}}$ by definition of $\text{OK}(\text{done}_{x+1})$.

As a consequence, $L_{j_1^{i+1}}(v_{i+1}) = L_{j_2^{i+1}+1}(v_{i+1}) \in \{z^{b_{i+1}}, x_1^{b_{i+1}}, x_2^{b_{i+1}}\}$.

Now let $0 < i \leq m$, such that $\text{op}_i = \text{todo}_{x+1}$, then $\text{op}_{i-1} = \text{todo}_{x+1}$ and $\text{ok}_{i-1} = \overline{\text{todo}_{x+1}}$. Indeed, by Lemma C.12, as $\text{op}_i = \text{todo}_{x+1}$, it must be that $\text{ok}_{i-1} = \overline{\text{todo}_{x+1}}$. And from C.9, $\text{ok}_{i-1} \in \text{OK}(\text{op}_{i-1})$. Note that the only $\text{op} \in \text{OP}$ such that $\overline{\text{todo}_{x+1}} \in \text{OP}(\text{op})$ is todo_{x+1} , hence $\text{op}_{i-1} = \text{todo}_{x+1}$.

As a consequence, $L_{j_1^{i-1}}(v_{i-1}) = L_{j_2^{i-1}+1}(v_{i-1}) \in \{z^{b_{i-1}}, x_1^{b_{i-1}}, x_2^{b_{i-1}}\}$.

Recall that $\text{op}_0 = \text{todo}_{x+1}$ and observe that $\text{op}_m = \text{done}_{x+1}$, as otherwise, necessarily $L_{j_1^m+1}(v_{m+1}) = \odot$. As a consequence, there exists a unique $0 < p < m$ such that $\text{op}_p = \text{todo}_{x+1}$ and $\text{op}_{p+1} = \text{done}_{x+1}$ and it holds that for all $i < p$, $\text{op}_i = \text{todo}_{x+1}$ and for all $i > p$, $\text{op}_i = \text{done}_{x+1}$.

Observe that, from Lemma C.12, as $\text{op}_{p+1} = \text{done}_{x+1}$, $\text{ok}_p = \overline{\text{done}_{x+1}}$, and so by construction of P , it holds that $L_{j_1^p}(v_p) = z^{b_p}$, $L_{j_2^p+1}(v_p) = x^{b_p}$. ◀

► **Lemma C.15.** *If $\text{op} = \text{todo}_{x-1}$ for some $x \in X$, then, there exists a unique $1 \leq p \leq m$ such that $L_{j_1^p}(v_p) = x^{b_p}$, $L_{j_2^p+1}(v_p) = z^{b_p}$, and for all $1 \leq i \leq m$, $i \neq p$, it holds that $L_{j_1^i}(v_i) = L_{j_2^i+1}(v_i) \in \{z^{b_i}, x_1^{b_i}, x_2^{b_i}\}$.*

Proof. Same proof as Lemma C.14. ◀

We now associate to j_1^0, j_2^0 two configurations $\text{prec}(j_1^0, j_2^0) = (\ell, x_1, x_2)$, $\text{succ}(j_1^0, j_2^0) = (\ell', x'_1, x'_2)$ of the machine as follows:

- $\ell = L_{j_1^0}(v_0)$, $x_1 = |\{i \mid L_{j_1^i}(v_i) = x_1^{b_i}, 1 \leq i \leq m\}|$, $x_2 = |\{i \mid L_{j_1^i}(v_i) = x_2^{b_i}, 1 \leq i \leq m\}|$;
- $\ell' = L_{j_2^0+1}(v_0)$, $x'_1 = |\{i \mid L_{j_2^i+1}(v_i) = x_1^{b_i}, 1 \leq i \leq m\}|$, $x'_2 = |\{i \mid L_{j_2^i+1}(v_i) = x_2^{b_i}, 1 \leq i \leq m\}|$.

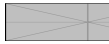

► **Lemma C.16.** $\text{prec}(j_1^0, j_2^0) \rightarrow \text{succ}(j_1^0, j_2^0)$

Proof. Denote $\text{op}_0, \dots, \text{op}_m \in \text{OP}$, $\text{ok}_0, \dots, \text{ok}_m \in \text{OK}$ as defined in Lemma C.12.

Observe that by construction, $L_{j_1^0}(v_0) = \ell$, $L_{j_2^0}(v_0) = \ell'$ for some $\ell, \ell' \in \text{Loc}$.

- If $\text{op}_0 = \text{todo}_{x+1}$, then by construction, there exists $t = (\ell, \text{inc}(x), \ell') \in \text{Trans}$. Furthermore, by Lemma C.14, there exists a unique $1 \leq p < m$ such that $L_{j_1^p}(v_p) \neq L_{j_2^p+1}(v_p)$ and $L_{j_2^p+1}(v_p) = x^{b_p}$ and $L_{j_1^p}(v_p) = z^{b_p}$. Denote $i \in \{1, 2\}$ such that $x = x_i$ and $\text{prec}(j_1^0, j_2^0) = (\ell, x_1, x_2)$. Hence, $\text{succ}(j_1^0, j_2^0) = (\ell', x'_1, x'_2)$ with $x'_i = x_i + 1$, and $x'_{3-i} = x_{3-i}$.
- If $\text{op}_0 = \text{test}_x$, then by construction, there exists $t = (\ell, \text{test}(x), \ell') \in \text{Trans}$. Denote $i \in \{1, 2\}$ such that $x = x_i$. By Lemma C.13, for all $1 \leq k \leq m$, $L_{j_1^k}(v_k) = L_{j_2^k+1}(v_k) \in \{z^{b_k}, x_{3-i}^{b_k}\}$. Hence, if $\text{prec}(j_1^0, j_2^0) = (\ell, x_1, x_2)$, then $x_i = 0$. Denote $\text{succ}(j_1^0, j_2^0) = (\ell', x'_1, x'_2)$, it holds that $x'_1 = x_1$, $x_2 = x'_2$ and $x'_i = x_i = 0$.
- If $\text{op}_0 = \text{todo}_{x-1}$, then by construction, there exists $t = (\ell, \text{dec}(x), \ell') \in \text{Trans}$. Furthermore, by Lemma C.15, there exists a unique $1 \leq p < m$ such that $L_{j_1^p}(v_p) \neq L_{j_2^p+1}(v_p)$ and furthermore, $L_{j_2^p+1}(v_p) = z^{b_p}$ and $L_{j_1^p}(v_p) = x^{b_p}$. Denote $i \in \{1, 2\}$ such that $x = x_i$ and $\text{prec}(j_1^0, j_2^0) = (\ell, x_1, x_2)$. Hence, $\text{succ}(j_1^0, j_2^0) = (\ell', x'_1, x'_2)$ with $x'_i = x_i - 1$, and $x'_{3-i} = x_{3-i}$.

◀

We now denote $j < j_{1,0} < j_{2,0} < \dots < j_{1,k} < j_{2,k} < n_0$ for some $k \in \mathbb{N}$ the indices such that: $C_0 \xrightarrow{|v_0|^*} C_j \xrightarrow{v_0,0} C_{j+1} \xrightarrow{|v_0|^*} C_{j_{1,0}} \xrightarrow{v_0, \text{op}^{00}} C_{j_{1,0}+1} \xrightarrow{|v_0|^*} C_{j_{2,0}} \xrightarrow{v_0, \text{op}^{00}} C_{j_{2,0}+1} \xrightarrow{|v_0|^*} C_{j_{1,1}} \dots C_{j_{2,k}} \xrightarrow{v_0, \text{op}^{k0}} C_{j_{2,k}+1} \xrightarrow{|v_0|^*} C_{n_0}$ with $\text{op}^0, \dots, \text{op}^k \in \{\text{todo}_{x+1}, \text{todo}_{x-1}, \text{test}_x \mid x \in \{x_1, x_2\}\}$.

► **Lemma C.17.** $\text{prec}(j_{1,0}, j_{2,0}) = (\ell_{in}, 0, 0)$.

Proof. Denote $\text{Seq}(j_{1,0}, j_{2,0}) = j_1^1, j_2^1, \dots, j_1^m, j_2^m$.

First note that by construction, $L_{j_1^0}(v_0) = \ell_{in}$.

In fact: for all $1 \leq i \leq m$, it holds that $C_0 \xrightarrow{|v_i|^*} C_{x_i} \xrightarrow{v_i, b_i} C_{x_i+1} \xrightarrow{|v_i|^*} C_{y_i} \xrightarrow{v_i, \$} C_{y_i+1} \xrightarrow{|v_i|^*} C_{j_1^i}$ for some indices x_i, y_i . Assume this is not the case and take the smallest index p such that this is not the case: there exists at least two indices from which it broadcasts b_p and $\$$ as $L_{j_1^p}(v_p) \in \{z^p, x_1^p, x_2^p\}$. Assume now, there are more than two indices from which v_p broadcasts, i.e. there exist $x_p < y_p < z_p$ such that $C_0 \xrightarrow{|v_p|^*} C_{x_p} \xrightarrow{v_p, b_p} C_{x_p+1} \xrightarrow{|v_p|^*} C_{y_p} \xrightarrow{v_p, \$} C_{y_p+1} \xrightarrow{|v_p|^*} C_{z_p} \xrightarrow{v_p, w} C_{z_p+1} \rightarrow^* C_{j_1^p}$. By construction of the protocol, $w \in \text{OP}^{b_p}$. If $p = 1$, then $L_{z_p}(v_0) = \ell_{in}$, and so $L_{z_p+1}(v_0) = \ominus$ which contradicts the existence of $j_{1,0}$. Assume $p > 1$, then $L_{z_p}(v_{p-1}) = z^{b_{p-1}}$ and so $L_{z_p+1}(v_{p-1}) = \ominus$ which contradicts the fact that v^{p-1} broadcasts "done".

Hence, for all $1 \leq i \leq m$, it holds that $C_0 \xrightarrow{|v_i|^*} C_{x_i} \xrightarrow{v_i, b_i} C_{x_i+1} \xrightarrow{|v_i|^*} C_{y_i} \xrightarrow{v_i, \$} C_{y_i+1} \xrightarrow{|v_i|^*} C_{j_1^i}$ for some indices x_i, y_i . As a consequence, $L_{j_1^i}(v_i) = z^{b_i}$, and so $\text{prec}(j_{1,0}, j_{2,0}) = (\ell_{in}, 0, 0)$. ◀

► **Lemma C.18.** For all $0 \leq i < k$, $\text{succ}(j_{1,i}, j_{2,i}) = \text{prec}(j_{1,i+1}, j_{2,i+1})$.

Proof. Let $0 \leq i < k$ such that $\text{succ}(j_{1,i}, j_{2,i}) \neq \text{prec}(j_{1,i+1}, j_{2,i+1})$. Denote $\text{succ}(j_{1,i}, j_{2,i}) = (\ell, x_1, x_2)$ and $\text{prec}(j_{1,i+1}, j_{2,i+1}) = (\ell', x'_1, x'_2)$. Denote $\text{Seq}(j_{1,i}, j_{2,i}) = j_1^1, j_2^1, \dots, j_1^m, j_2^m$ and $\text{Seq}(j_{1,i+1}, j_{2,i+1}) = i_1^1, i_2^1, \dots, i_1^m, i_2^m$. By construction, $C_{j_{2,i+1}} \xrightarrow{|v_0|^*} C_{j_{1,i+1}}$ hence, $\ell = \ell'$. Hence, there exists $1 \leq p \leq m$ such that $L_{j_2^p+1}(v_p) \neq L_{i_1^p}(v_p)$. Consider the first such index p . By C.12, $L_{j_2^p+1}(v_p) \in \{z^{b_p}, x_1^{b_p}, x_2^{b_p}\}$. Again, by C.12, $L_{i_1^p}(v_p) \neq \ominus$ and so there exists $j_2^p + 1 \leq j < i_1^p$ such that $C_j \xrightarrow{v_p, w} C_{j+1}$. Take j the first such index, by construction of P , $w \in \text{OP}^{b_p}$.



© L. Guillou and A. Sangnier and N. Sznajder;
licensed under Creative Commons License CC-BY 4.0



Leibniz International Proceedings in Informatics
Schloss Dagstuhl – Leibniz-Zentrum für Informatik, Dagstuhl Publishing, Germany

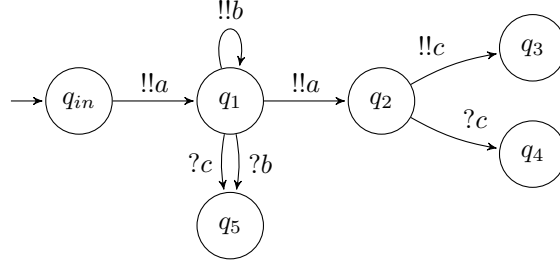

■ **Figure 19** Example of a 1-phase-bounded broadcast protocol denoted P



■ **Figure 20** Example of two star-configurations of P denoted C_1 to the left and C_2 to the right.

If $p = 1$, then $L_{j+1}(v_0) = \ominus$, as $w \in \text{OP}^{b_p}$ and $L_{j+1}(v_0) = L_{j_1,i}(v_0) = \ell$. If $p > 1$, then $L_j(v_{p-1}) = L_{j_2^{p-1}+1}(v_{p-1}) \in \{z^{b_{p-1}}, x_1^{b_{p-1}}, x_2^{b_{p-1}}\}$. Hence, $L_{j+1}(v_{p-1}) = \ominus$ which contradicts the existence of i_1^{p-1} . ◀

We are now ready to prove Lemma C.3:

Proof of Lemma C.3. We found a sequence of indices $j < j_{1,0} < j_{2,0} < \dots < j_{1,k} < j_{2,k} < n_0$ such that:

- $\text{prec}(j_{1,0}, j_{2,0}) = (\ell_{in}, 0, 0)$ (Lemma C.17)
- for all $0 \leq j \leq k$, $\text{prec}(j_{1,j}, j_{2,j}) \rightarrow \text{succ}(j_{1,j}, j_{2,j})$ (Lemma C.16)
- for all $0 \leq i < k$, $\text{succ}(j_{1,i}, j_{2,i}) = \text{prec}(j_{1,i+1}, j_{2,i+1})$ (Lemma C.18)
- $\text{succ}(j_{1,k}, j_{2,k}) = (\ell_f, x_1, x_2)$ for some $x_1, x_2 \in \mathbb{N}$, as $L_{j_{2,k}}(v_0) = L_{n_0}(v_0) = \ell_f$.

Putting everything together, we get a sequence $(\ell_{in}, 0, 0) \rightarrow \text{succ}(j_{1,0}, j_{2,0}) \rightarrow \text{succ}(j_{1,1}, j_{2,1}) \rightarrow \dots \rightarrow \text{succ}(j_{1,k}, j_{2,k}) = (\ell_f, x_1, x_2)$. ◻

D Proofs of Section 5

We start by an example.

► **Example D.1.** Consider the protocol P depicted in Figure 19. P is 1-phase-bounded. We depict two star-configurations C_1 and C_2 in Figure 20. Both are b-configurations as the root node v_0 is in q_1 in both configurations and $q_1 \in Q_1^b$. The broadcast-print of C_1 is equal to the one of C_2 and $\mathbf{bprint}(C_1) = \mathbf{bprint}(C_2) = (q_1, \{q_{in}, q_1, q_2\})$.

D.1 Proof of Lemma 5.1

Proof of Lemma 5.1. Assume there exists $\Gamma = (V, E)$ in **Graphs**, $C = (\Gamma, L) \in \mathcal{I}$ and $D = (\Gamma, L') \in \mathcal{C}_P$ and $v \in V(\Gamma)$ such that $C \rightarrow^* D$ and $L'(v) = q_f$. Thanks to Theorem 2.4,

we can assume that $\Gamma \in \text{Trees}$ and without loss of generality that $v = \epsilon$ (i.e. it the root of the tree). We consider the execution:

$$C_0 \xrightarrow{v_1, \delta_1} C_1 \xrightarrow{v_2, \delta_2} C_2 \xrightarrow{v_3, \delta_3} \dots \xrightarrow{v_n, \delta_n} C_n$$

such that $C_0 = C$ and $C_n = D$ and $C_i = (\Gamma, L_i)$ for all $i \in [0, n]$. Note in particular that $L_n(\epsilon) = q_f$. Without loss of generality we can assume that $|v_n| \leq 1$ otherwise it means that the last step of this execution does not affect the root node and hence we could have stop it at C_{n-1} . We denote by m the number of steps in this executions labelled by the root node or the node at height 1 whose label in the previous step belongs to $Q_0 \cup Q_1^b$, i.e. $m = |\{i \in [1, n] \mid v_i = \epsilon \text{ or } (|v_i| = 1 \text{ and } L_{i-1}(v_i) \in Q_0 \cup Q_1^b)\}|$. Intuitively m is the number of steps in the execution, which can affect the root node or which an internal move of a node at height 1 which stays in the $Q_0 \cup Q_1^b$ component. Note that since we are dealing with 1-phase-bounded protocol if for some $i \in [1, n]$ and some nodes $v \in V$, we have $L_i(v) \notin Q_0 \cup Q_1^b$ then $L_j(v) \notin Q_0 \cup Q_1^b$ for all $j \in [i, n]$. We consider then the configuration $\Gamma' \in \text{Stars}$ which is a restriction of the tree Γ to nodes of height at most one, i.e. $\Gamma' = (V', E')$ with $V' = \{v \in V \mid |v| \leq 1\}$ and $E' = \{(v, v') \in E \mid v, v' \in V'\}$.

We will show how to build an execution of length m from $C' = (\Gamma', L'_0) \in \mathcal{I}$ to a configuration $D' = (\Gamma', L'''_m)$ with $L'''_m(\epsilon) = q_f$. For this matter we consider an injective function $f : [1, m] \mapsto [1, n]$ which select m indices of the step of the previously introduced execution keeping only the one labelled by nodes in V' . Formally f is the unique injective function respecting the following conditions:

- for all $i \in [1, m], v_{f(i)} = \epsilon$ or $(|v_{f(i)}| = 1 \text{ and } L_{f(i)-1}(v_{f(i)}) \in Q_0 \cup Q_1^b)$;
- for all $i, j \in [1, m]$, if $i < j$ then $f(i) < f(j)$.

Since $v_n \in V'$, we have $f(m) = n$. We shall now show that there exists an execution of the form:

$$C'_0 \xrightarrow{v_{f(1)}, \delta_{f(1)}} C'_1 \xrightarrow{v_{f(2)}, \delta_{f(2)}} C'_2 \xrightarrow{v_{f(3)}, \delta_{f(3)}} \dots \xrightarrow{v_{f(m)}, \delta_{f(m)}} C'_m$$

where $C'_0 = (\Gamma', L'_0)$ and for all $i \in [1, m]$ we have $C'_i = (\Gamma', L'_i)$ with L'_i satisfying the following condition: $L'_i(\epsilon) = L_{f(i)}(\epsilon)$ and for all $v \in V' \setminus \{\epsilon\}$, if $L_{f(i)}(v) \in Q^0 \cup Q_1^b$ then $L'_i(v) = L_{f(i)}(v)$. We shall now see how to build this execution by induction. First note that if we extend f to 0 by setting $f(0) = 0$ for $i = 0$, we have that $L'_0(\epsilon) = L_{f(0)}(\epsilon) = q_{in}$ and for all $v \in V' \setminus \{\epsilon\}$, $L'_0(v) = L_{f(0)}(v) = q_{in}$ and $q_{in} \in Q^0$. Now assume that we have build $C'_0 \xrightarrow{v_{f(1)}, \delta_{f(1)}} C'_1 \xrightarrow{v_{f(2)}, \delta_{f(2)}} C'_2 \xrightarrow{v_{f(3)}, \delta_{f(3)}} \dots \xrightarrow{v_{f(i)}, \delta_{f(i)}} C'_i$ with $C'_i = (\Gamma', L'_i)$ with L'_i satisfying the following condition: $L'_i(\epsilon) = L_{f(i)}(\epsilon)$ and for all $v \in V' \setminus \{\epsilon\}$, if $L_{f(i)}(v) \in Q^0 \cup Q_1^b$ then $L'_i(v) = L_{f(i)}(v)$. Consider the node $v_{f(i+1)}$, we have two cases:

1. $v_{f(i+1)} = \epsilon$. Since between $C_{f(i)}$ and $C_{f(i+1)-1}$ the root node did not perform an internal action, nor any broadcast and none of the node at height 1 performed a broadcast, we deduce that $L_{f(i+1)-1}(v_{f(i+1)}) = L_{f(i)}(v_{f(i+1)}) = L'_i(v_{f(i+1)})$, hence from C'_i the transition $\delta_{f(i+1)}$ can be taken from the root node. And we have $C'_i \xrightarrow{v_{f(i+1)}, \delta_{f(i+1)}} C'_{i+1}$ with $C'_{i+1} = (\Gamma', L'_{i+1})$. Note that we have necessarily $L'_{i+1}(\epsilon) = L_{f(i+1)}(\epsilon)$. And for all $v \in V' \setminus \{\epsilon\}$, if $L_{f(i+1)}(v) \in Q^0 \cup Q_1^b$, it means that the action of the root node did not affect v then $L_{f(i+1)}(v) = L_{f(i+1)-1}(v)$ and by the same reasoning as we did for the root node, since $L_{f(i+1)-1}(v) \in Q^0 \cup Q_1^b$, we have $L_{f(i+1)-1}(v) = L_{f(i)}(v) = L'_i(v)$. But in the transition from C'_i to C'_{i+1} the same action still not affect v , this allows us to deduce that $L'_{i+1}(v) = L'_i(v)$. Hence $L'_{i+1}(v) = L_{f(i+1)}(v)$.



2. $v_{f(i+1)} \neq \epsilon$. In that case $|v_{f(i+1)}| = 1$ and $L_{f(i+1)-1}(v_{f(i+1)}) \in Q_0 \cup Q_1^b$. Here again we can deduce that $L_{f(i+1)-1}(v_{f(i+1)}) = L_{f(i)}(v_{f(i+1)}) = L'_i(v_{f(i+1)})$, hence from C'_i the transition $\delta_{f(i+1)}$ can be taken from the node $v_{f(i+1)}$. Hence we have $C'_i \xrightarrow{v_{f(i+1)}, \delta_{f(i+1)}} C'_{i+1}$ with $C'_{i+1} = (\Gamma', L'_{i+1})$. Consider $v \in V' \setminus \{\epsilon\}$, if $v = v_{f(i+1)}$, it is clear that $L'_{i+1}(v) = L_{f(i+1)}$. If $v \neq v_{f(i+1)}$ and $L_{f(i+1)}(v) \in Q^0 \cup Q_1^b$, we can deduce that $L'_{i+1}(v) = L'_i(v)$ because the action of node at height 1 does not affect the other node at height 1, and $L_{f(i+1)}(v) = L_{f(i+1)-1}(v)$ for the same reason, and $L_{f(i+1)-1}(v) = L_{f(i)}(v)$ by definition of f and $L_{f(i)}(v) = L'_i(v)$. Hence $L'_{i+1}(v) = L_{f(i+1)}(v)$. If $v = \epsilon$, we can show that $L'_i(v) = L_{f(i)}(v) = L_{f(i+1)-1}(v)$ and this allows us to deduce that $L'_{i+1}(v) = L_{f(i+1)}(v)$.

We have hence proven that we can build the execution $C'_0 \xrightarrow{v_{f(1)}, \delta_{f(1)}} C'_1 \xrightarrow{v_{f(2)}, \delta_{f(2)}} C'_2 \xrightarrow{v_{f(3)}, \delta_{f(3)}} \dots \xrightarrow{v_{f(m)}, \delta_{f(m)}} C'_m$ where $C'_m = (\Gamma', L'_m)$ such that $L'_m(\epsilon) = L_{f(m)}(\epsilon) = L_n(\epsilon) = q_f$. \square

D.2 Proof of Lemma 5.2

Proof of Lemma 5.2. Let $(q, \Lambda) \in Q^b \times 2^{Q^b}$. We consider F subset of $Q^b \times 2^{Q^b}$, built according to the following rules:

- Initially, $F = \emptyset$;
- for all transitions $(q, \tau, q') \in \Delta$, add (q', Λ) to F ;
- for all transitions $(q, !!m, q') \in \Delta$, add (q', Λ') to F where $\Lambda' = \Lambda \setminus \{q'' \in \Lambda \mid \exists q''' \in Q. (q'', ?m, q''') \in \Delta\}$;
- for all transitions $(q', \tau, q'') \in \Delta$, with $q' \in \Lambda$ add $(q, \Lambda \cup \{q''\})$ and $(q, (\Lambda \setminus \{q'\}) \cup \{q''\})$ to F (the latter case being here to deal with the case where in the configuration with broadcast-print (q, Λ) there is a single node labelled with q');
- for all transitions $(q', !!m, q'') \in \Delta$ such that $q' \in \Lambda$ and there does not exist $q''' \in Q$ with $(q, ?m, q''') \in \Delta$, add $(q, \Lambda \cup \{q''\})$ and $(q, (\Lambda \setminus \{q'\}) \cup \{q''\})$ to F .

It is clear that F can be built in polynomial time and a case analysis allows to show $F = \{(q', \Lambda') \mid (q, \Lambda) \Rightarrow (q', \Lambda')\}$. \square

D.3 Proof of Lemma 5.3

Proof of Lemma 5.3.

- (i) Let $C_1 = ((V_1, E_1), L_1)$, $C'_1 = ((V_1, E_1), L_1)$ and $C_2 = ((V_2, E_2), L_2)$ be star-configurations such that $C_1 \xrightarrow{v, \delta} C'_1$ and $C_1 \leq C_2$. First note that if $v \neq \epsilon$ and $L_1(v) \notin Q^b$, then $C'_1 \leq C_2$ and $C_2 \rightarrow^* C_2$. If $v = \epsilon$, then $L_2(v) = L_1(v)$ by definition of \leq , hence we have $C_2 \xrightarrow{v, \delta} C'_2$ and one can show that $C'_1 \leq C'_2$ (the root node have obviously the same label and if some nodes at height one are affected because of a broadcast from C_1 to C'_1 , their label will go out of Q^b in C'_1 and the nodes with the same label will be affected similarly going to C'_2). If $v \neq \epsilon$ and $L_1(v) \notin Q^b$, then there exists a node $v' \in V_2 \setminus \{\epsilon\}$ such that $L_2(v') = L_1(v)$ and we have $C_2 \xrightarrow{v', \delta} C'_2$ with $C'_1 \leq C'_2$ (here if δ is a broadcast it should affect the root node from C_1 and C_2 similarly and does not affect the other nodes).



- (ii) Assume $C_1 = ((V_1, E_1), L_1)$, $C'_1 = ((V_1, E_1), L_1)$ and $C_2 = ((V_2, E_2), L_2)$ are b-configurations such that $C_1 \xrightarrow{v, \delta} C'_1$ and $\mathbf{bprint}(C_1) = \mathbf{bprint}(C_2)$ and $C_1 \leq C_2$. From the previous point, we easily deduce that there exists a b-configuration C'_2 such that $C'_1 \leq C'_2$ and $C_2 \rightarrow^* C'_2$. However it might be the case that $\mathbf{bprint}(C'_1) \neq \mathbf{bprint}(C'_2)$. In that case, we have necessarily $\mathbf{bprint}(C'_1) = (q, \Lambda_1)$ and $\mathbf{bprint}(C'_2) = (q, \Lambda_2)$ with $\Lambda_1 \subset \Lambda_2$. This happens if $v \neq \epsilon$ is the only node labelled by $L_1(v) \in Q^b$ in C_1 and in C_2 there are strictly more than 1 node labelled by $L_1(v)$. Assume $\{v' \in V_2 \mid L_2(v') = L_1(v)\} = \{v_1, \dots, v_k\}$ then the execution $C_2 \xrightarrow{v_1, \delta} C_{2,1} \xrightarrow{v_2, \delta} C_{2,2} \xrightarrow{v_3, \delta} C_{2,3} \dots \xrightarrow{v_k, \delta} C_{2,k}$ is a valid execution. Note that along this execution the state of the root node does not change, because C'_1 is a b-configuration hence $C_1 \xrightarrow{v, \delta} C'_1$ with $v \neq \epsilon$ does not affect the root node (otherwise it would perform a reception and its state would not be in Q^b anymore). Furthermore we have $C'_1 \leq C'_{2,k}$ and $C_2 \rightarrow^* C'_{2,k}$ and $\mathbf{bprint}(C'_1) = \mathbf{bprint}(C'_{2,k})$.
- (iii) Let $C = ((V, E), L)$, be a b-configuration such that $C_{in} \rightarrow^* C$ for some initial configuration C_{in} and such that $\mathbf{bprint}(C) = (q, \Lambda)$. Let $N \in \mathbb{N}$. We assume that $\Lambda = \{q_1, \dots, q_k\}$. There exist k nodes u_1, \dots, u_k in $V \setminus \{\epsilon\}$ such that $L(u_i) = q_i$ for all $i \in [1, k]$. Assume furthermore that we have an execution of the form:

$$C_0 \xrightarrow{v_1, \delta_1} C_1 \xrightarrow{v_2, \delta_2} C_2 \xrightarrow{v_3, \delta_3} \dots \xrightarrow{v_n, \delta_n} C_n$$

with $C_0 = C_{in}$ and $C_n = C$. Here again since C is a b-configuration and $q_i \in Q^b$ for all $i \in [1, k]$, none of the transitions δ_i performed by a node v_i different than ϵ changes the state of ϵ and none of the transitions performed by ϵ changes the states of nodes u_1, \dots, u_k . We build an initial star configuration $C'_{in} = ((V', E'), L'_{in})$ where $V' = V \cup \{w_{1,1}, w_{1,2}, \dots, w_{1,N}, w_{2,1}, w_{2,2}, \dots, w_{2,N}, \dots, w_{k,1}, w_{k,2}, \dots, w_{k,N}\}$ with $w_{i,j}$ is a node of depth one such that $w_{i,j} = \max(v \in V \setminus \{\epsilon\}) + (i-1) * N + j$ and E' is defined such that (V', E') is a star with root ϵ . Now we build an execution from C'_{in} to $C' = ((V', E'), L')$ following the same steps as the execution from C_{in} to C and replacing each step $\xrightarrow{v_\ell, \delta_\ell}$ with $v_\ell = u_i$ for some $i \in [1, k]$, by the sequence $\xrightarrow{v_\ell, \delta_\ell} \xrightarrow{w_{i,1}, \delta_\ell} \dots \xrightarrow{w_{i,N}, \delta_\ell}$. It is easy to see that at the end $\mathbf{bprint}(C) = \mathbf{bprint}(C') = (q, \Lambda)$ and $|\{v \in V' \setminus \{\epsilon\} \mid L'(v) = q'\}| \geq N$ for all $q' \in \Lambda$.

□

D.4 Proof of Lemma 5.4

Proof of Lemma 5.4. Let $(q, \Lambda) \in Q^b \times 2^{Q^b}$. First assume that there exist two b-configurations $C_{in} \in \mathcal{I}$ and C such that $C_{in} \rightarrow^* C$ and $\mathbf{bprint}(C) = (q, \Lambda)$. Hence there exists an execution of the form $C_0 \rightarrow C_1 \rightarrow \dots \rightarrow C_n$ with $C_0 = C_{in}$ and $C_n = C$. Let $(q_i, \Lambda_i) = \mathbf{bprint}(C_i)$ for all $i \in [0, n]$. By definition of \Rightarrow , we have $(q_0, \Lambda_0) \Rightarrow (q_1, \Lambda_1) \Rightarrow \dots \Rightarrow (q_n, \Lambda_n)$, hence $(q_0, \Lambda_0) \Rightarrow^* (q_n, \Lambda_n)$. Since C_0 is an initial configuration and $(q_0, \Lambda_0) = \mathbf{bprint}(C_0)$, we have $q_0 = q_{in}$ and $\Lambda_0 \in \{\emptyset, \{q_{in}\}\}$ and by definition we have $(q_n, \Lambda_n) = \mathbf{bprint}(C_n) = \mathbf{bprint}(C) = (q, \Lambda)$.

Now assume that $(q_{in}, \Lambda_{in}) \Rightarrow^* (q, \Lambda)$ with $\Lambda_{in} \in \{\emptyset, \{q_{in}\}\}$. Hence we have $(q_0, \Lambda_0) \Rightarrow (q_1, \Lambda_1) \Rightarrow \dots \Rightarrow (q_n, \Lambda_n)$ with $(q_0, \Lambda_0) = (q_{in}, \Lambda_{in})$ and $(q_n, \Lambda_n) = (q, \Lambda)$. We reason by induction on n to show that for all $i \in [0, n]$, there exist two b-configurations $C_{in} \in \mathcal{I}$ and C_i such that $C_{in} \rightarrow^* C_i$ and $\mathbf{bprint}(C_i) = (q_i, \Lambda_i)$. If $n = 0$, then it is clear that there exists an initial b configuration $C_{in} \in \mathcal{I}$ such that $\mathbf{bprint}(C_{in}) = (q_0, \Lambda_0)$ and $C_{in} \rightarrow^* C_{in}$.



Suppose the property holds for $i \in [0, n - 1]$ and let us prove it still holds for $i + 1$. By induction hypothesis, there exist two b -configurations $C_{in} \in \mathcal{I}$ and C_i such that $C_{in} \rightarrow^* C_i$ and $\mathbf{bprint}(C_i) = (q_i, \Lambda_i)$.

Since $(q_i, \Lambda_i) \Rightarrow (q_{i+1}, \Lambda_{i+1})$, there exists two b -configurations $C'_i = ((V'_i, E'_i), L'_i)$ and C_{i+1} such that $C'_i \rightarrow C_{i+1}$ and $\mathbf{bprint}(C'_i) = (q_i, \Lambda_i)$ and $\mathbf{bprint}(C_{i+1}) = (q_{i+1}, \Lambda_{i+1})$. We let $N = \max_{q' \in Q^b} (|\{v \in V'_i \mid L'_i(v) = q'\}|)$. Since $C_{in} \rightarrow^* C_i$ and $\mathbf{bprint}(C_i) = (q_i, \Lambda_i)$, using Lemma 5.3.(iii), there exists an initial configuration C'_{in} and a b -configuration $C''_i = ((V''_i, E''_i), L''_i)$ such that $C'_{in} \rightarrow^* C''_i$ and $\mathbf{bprint}(C''_i) = (q_i, \Lambda_i)$ and $|\{v \in V''_i \mid L''_i(v) = q'\}| \geq N$ for all $q' \in \Lambda_i$. By definition we have $C'_i \leq C''_i$. By Lemma 5.3.(ii), there exists a b -configuration C'_{i+1} such that $C_{i+1} \leq C'_{i+1}$ and $\mathbf{bprint}(C_{i+1}) = \mathbf{bprint}(C'_{i+1}) = (q_{i+1}, \Lambda_{i+1})$ and $C''_i \rightarrow^* C'_{i+1}$. We deduce that we have $C'_{in} \rightarrow^* C'_{i+1}$ and $\mathbf{bprint}(C'_{i+1}) = (q_{i+1}, \Lambda_{i+1})$. \square

D.5 Unary VASS and the control state reachability problem

We present here the syntax and semantics of (unary) Vector Addition System with States (VASS). In our context a VASS V is a tuple (S, X, T) where: S is a finite set of control states, X is a finite set of variables taking their value in the natural and T is a finite set of transitions of the form (s, a, s') with $s, s' \in S$ and $a \in \{x ++, x -- \mid x \in X\} \cup \{\mathbf{skip}\}$. A configuration of such a VASS is a pair (s, ν) with $s \in S$ and $\nu : X \mapsto \mathbb{N}$. We define the transition relation \triangleright between VASS configurations as follows: $(s, \nu) \triangleright (s', \nu')$ iff there exists a transition (s, a, s') in T one of the following condition holds:

- $a = \mathbf{skip}$ and $\nu = \nu'$, or,
- $a = x ++$ and $\nu'(x) = \nu(x) + 1$ and $\nu'(x') = \nu(x')$ for all $x' \in X \setminus \{x\}$, or,
- $a = x --$ and $\nu'(x) = \nu(x) - 1$ and $\nu'(x') = \nu(x')$ for all $x' \in X \setminus \{x\}$.

Remark that if $\nu(x) = 0$ then it is not possible to take the transition $(s, x --, s')$ from (s, ν) . We denote by \triangleright^* the reflexive and transitive closure of \triangleright . The control state reachability problem for VASS can be defined as follows:

| VASSCONTROLREACH | |
|------------------|--|
| Input: | A VASS $V = (S, X, T)$, an initial configuration (s_{in}, ν_{in}) and a state $s_f \in S$; |
| Question: | Does there exist $\nu' : X \mapsto \mathbb{N}$ such that $(s_{in}, \nu_{in}) \triangleright^* (s_f, \nu')$? |

From [17, 20], we know that VASSCONTROLREACH is EXPSpace-complete.

D.6 Proof of Lemma 5.5

Proof of Lemma 5.5. Let $(q, \Lambda) \in Q^b \times 2^{Q^b}$. From the 1-phase-bounded protocol $P = (Q, \Sigma, q_{in}, \Delta)$, we build a VASS $V = (S, X, T)$ as follows:

- $S = Q \cup (Q \times \delta) \cup \{s_{in}\}$;
- $X = Q^b$;
- T is the smallest set verifying the following conditions:
 - $(s_{in}, q' ++, s_{in}) \in T$ for all $q' \in \Lambda$ (initialisation phase adding processes in Λ);
 - $(s_{in}, \mathbf{skip}, q) \in T$;
 - for all $(q_1, \tau, q_2) \in \Delta$, we have $(q_1, \mathbf{skip}, q_2) \in T$ (central node does an internal action);
 - for all $\delta = (q_1, \tau, q_2) \in \Delta$ with $q_1 \in Q^b$ and all $q' \in Q$, we have $(q', q_1 --, (q', \delta)), ((q', \delta), q_2 ++, q') \in T$ (node at height one does an internal action);



- for all $\delta = (q_1, !!m, q_2) \in \Delta$ and $(q', ?m, q'') \in \Delta$, we have $(q', q_1 --, (q'', \delta)), ((q'', \delta), q_2 + +, q'') \in T$ (node at height one broadcasts a message received by the root);
- for all $\delta = (q_1, !!m, q_2) \in \Delta$ and all $q' \in Q$ such that there does not exist q'' in Q verifying $(q', ?m, q'') \in \Delta$, we have $(q', q_1 --, (q', \delta)), ((q', \delta), q_2 + +, q') \in T$ (node at height one broadcasts a message not received by the root).

Intuitively, the control state of the VASS tracks the state of the root whereas the counters count how many processes are in states Q^b . One can verify that there exist a b-configuration C and a star-configuration $C_f = (\Gamma_f, L_f)$ such that $\mathbf{bprint}(C) = (q, \Lambda)$ and $L_f(\epsilon) = q_f$ and $C \rightarrow_r^* C_f$ iff there exists $\nu' : X \mapsto \mathbb{N}$ such that $(s_{in}, \nu_{in}) \triangleright^* (q_f, \nu')$ where $\nu_{in}(q) = 1$ for all $q \in \Lambda$ and $\nu_{in}(q) = 0$ for all $q \in Q^b \setminus \Lambda$. We have hence shown that given $(q, \Lambda) \in Q^b \times 2^{Q^b}$, proving whether there exist a b-configuration $C = (\Gamma_f, L)$ and a star-configuration $C_f = (\Gamma_f, L_f)$ such that $\mathbf{bprint}(C) = (q, \Lambda)$ and $L_f(\epsilon) = q_f$ and $C \rightarrow_r^* C_f$ reduces to the control state reachability problem for VASS, VASSCONTROLREACH , which is EXPSpace -complete. □

D.7 Proof of Theorem 5.6

Thanks to Theorems 2.4 and 5.1, we have to prove that given 1-phase-bounded-protocol $P = (Q, \Sigma, q_{in}, \Delta)$ and $q_f \in Q$, deciding whether there exists $\Gamma \in \text{Stars}$, $C = (\Gamma, L) \in \mathcal{I}$ and $D = (\Gamma, L') \in \mathcal{C}_P$ such that $C \rightarrow^* D$ and $L'(\epsilon) = q_f$ is an EXPSpace -complete problem.

We begin with the upper bound providing an NEXPSpace algorithm. Let $P = (Q, \Sigma, q_{in}, \Delta)$ be a 1-phase-bounded protocol and $q_f \in Q$. We first guess a broadcast-print $(q, \Lambda) \in Q^b \times 2^{Q^b}$ and show we have $(q_{in}, \Lambda_{in}) \Rightarrow^* (q, \Lambda)$ with $\Lambda_{in} \in \{\emptyset, \{q_{in}\}\}$. This boils down to a reachability query in the graph $(Q^b \times 2^{Q^b}, \Rightarrow)$ which can be achieved in NPSpace thanks to Lemma 5.2 and because the number of vertices in this graph is smaller than $|Q| * 2^{|Q|}$. Thanks to Savitch's theorem, we can do this reachability query in PSPACE . Then we look for a b-configuration $C' = (\Gamma_f, L)$ and a star-configuration $C_f = (\Gamma_f, L_f)$ such that $\mathbf{bprint}(C') = (q, \Lambda)$ and $L_f(\epsilon) = q_f$ and $C' \rightarrow_r^* C_f$. Thanks to Lemma 5.5, this can be done in EXPSpace . The overall procedure gives rise to an NEXPSpace algorithm and using again Savitch's theorem, we obtain an EXPSpace -algorithm.

Let us show that this algorithm is complete. Assume there exist $\Gamma \in \text{Stars}$, $C = (\Gamma, L) \in \mathcal{I}$ and $D = (\Gamma, L') \in \mathcal{C}_P$ such that $C \rightarrow^* D$ and $L'(\epsilon) = q_f$. Since the protocol is 1-phase-bounded, there exists a b-configuration C' such that $C \rightarrow^* C' \rightarrow_r^* D$. If $q_f \notin Q^b$, take for $C' = (\Gamma, L')$ the last configuration in the execution $C \rightarrow^* D$ such that $L'(\epsilon) \in Q^b$ and otherwise take $C' = D$. Thanks to Lemma 5.4, if $\mathbf{bprint}(C') = (q, \Lambda)$, we have $(q_{in}, \Lambda_{in}) \Rightarrow^* (q, \Lambda)$ with $\Lambda_{in} \in \{\emptyset, \{q_{in}\}\}$. As $L'(\epsilon) = q_f$ and $C' \rightarrow_r^* D$, we can conclude that our algorithm is complete.

We shall now show it is sound. Assume there exists $(q, \Lambda) \in Q^b \times 2^{Q^b}$ such that $(q_{in}, \Lambda_{in}) \Rightarrow^* (q, \Lambda)$ with $\Lambda_{in} \in \{\emptyset, \{q_{in}\}\}$ and such that there exist a b-configuration $C' = (\Gamma_f, L)$ and a star-configuration $C_f = (\Gamma_f, L_f)$ verifying $\mathbf{bprint}(C') = (q, \Lambda)$ and $L_f(\epsilon) = q_f$ and $C' \rightarrow_r^* C_f$. Thanks to Lemma 5.4, there exist two b-configurations $C_{in} \in \mathcal{I}$ and $C = ((V, E), L)$ in \mathcal{C} such that $C_{in} \rightarrow^* C$ and $\mathbf{bprint}(C) = (q, \Lambda)$. We denote by $N = \max_{q' \in Q^b} (|\{v \in V \mid L(v) = q'\}|)$. Using Lemma 5.3.(iii), there exists an initial configuration C'_{in} and a b-configuration $C'' = (\Gamma'', L'')$ such that $C'_{in} \rightarrow^* C''$ and $\mathbf{bprint}(C) = \mathbf{bprint}(C'') = (q, \Lambda)$ and $|\{v \in V(\Gamma'') \setminus \{\epsilon\} \mid L''(v) = q'\}| \geq N$ for all $q' \in \Lambda$. But we have then that $C' \leq C''$. Thanks to Lemma 5.3.(i) applied to each transition of the execution $C' \rightarrow_r^* C_f$, we deduce that there exists $C'_f = (\Gamma'_f, L'_f)$ such that $C_f \leq C'_f$

and $C'' \rightarrow^* C'_f$, Since $C_f \leq C'_f$ and $L_f(\epsilon) = q_f$ we deduce that $L'_f(\epsilon) = q_f$. Since we have $C''_{in} \rightarrow^* C'' \rightarrow^* C'_f$, our algorithm is sound.

It remains to prove the lower bound. For this matter, we provide a reduction from VASSCONTROLREACH, the control state reachability problem for VASS. The intuition being that the root node keeps track of the states in S and the other nodes represent the value of the counters, the value of X at a certain time being the number of processes in state x_1 . Then the nodes encoding the counters will only perform broadcast saying whether they increment or decrement a counter and if at some point the root node receives an action on a counter, it is not suppose to do according to its control state, it will go in an error state err from which it will not be able to reach the final state anymore. Let $V = (S, X, T)$ be a VASS, (s_{in}, ν_{in}) an initial configuration and $s_f \in S$. Without loss of generality we assume that $\nu_{in}(x) = 0$ for all $x \in X$. We build the following broadcast protocol $P = (Q, \Sigma, q_{in}, \Delta)$ with:

- $Q = \{q_{in}, err\} \cup S \cup \{x_0, x_1 \mid x \in X\}$;
- $\Sigma = \{x ++, x -- \mid x \in X\}$;
- Δ is the smallest set satisfying the following conditions:
 - (q_{in}, τ, s_{in}) belong to Δ ;
 - for all $m \in \Sigma$, $(q_{in}, ?m, err)$ belong to Δ ;
 - for all $x \in X$, (q_{in}, τ, x_0) belong to Δ ;
 - $(x_0, !!x ++, x_1)$ and $(x_1, !!x --, x_0)$ are in Δ for all $x \in X$;
 - for all $(s, x ++, s') \in T$, we have $(s, ?x ++, s') \in \Delta$;
 - for all $(s, x --, s') \in T$, we have $(s, ?x --, s') \in \Delta$;
 - for all $(s, \text{skip}, s') \in T$, we have $(s, \tau, s') \in \Delta$;
 - for all $s \in S$ and all $x \in X$, if there does not exist $s' \in S$ such that $(s, x ++, s') \in T$ then $(s, ?x ++, err) \in \Delta$;
 - for all $s \in S$ and all $x \in X$, if there does not exist $s' \in S$ such that $(s, x --, s') \in T$ then $(s, ?x --, err) \in \Delta$.

Note that P is 1-phase bounded (the transitions leaving a state in $\{x_0, x_1 \mid x \in X\}$ only perform broadcasts and the the transitions leaving a state in $\{s \mid s \in S\}$ only perform receptions or internal actions). We can then show that there exists $\Gamma \in \text{Stars}$, $C = (\Gamma, L) \in \mathcal{I}$ and $D = (\Gamma, L') \in \mathcal{C}_P$ such that $C \rightarrow^* D$ and $L'(\epsilon) = s_f$ iff there exists $\nu' : X \mapsto \mathbb{N}$ such that $(s_{in}, \nu_{in}) \triangleright^* (s_f, \nu')$.

E Proofs of Section 6

E.1 Proofs of Section 6.1

We recall the definition of simple paths. A *simple path between u and u'* in a topology $\Gamma = (V, E)$ is a sequence of distinct vertices v_0, \dots, v_k such that $u = v_0$, $u' = v_k$, and for all $0 \leq i < k$, $(v_i, v_{i+1}) \in E$. Its length is denoted $d(v_0, \dots, v_k)$ and is equal to k . In a tree topology Γ' , for two vertices u, u' , there exists a unique simple path between u and u' , hence we denote $d(u, u')$ to denote the length of the unique path between u and u' . Furthermore, for all vertex u , $d(\epsilon, u) = |u|$.

E.1.1 Proof of Lemma 6.2.

Given (P, q_f) a positive instance of COVER[Trees], we let $f(P, q_f)$ the minimal number of processes needed to cover q_f with a tree topology and we fix $\Gamma = (V, E)$ a tree topology such



that $|V| = f(P, q_f)$ and that covers q_f . Let $v \in V(\Gamma)$ and $(C_i = (\Gamma, L_i))_{0 \leq i \leq n}$ configurations such that $C_0 \in \mathcal{I}$, $C_0 \rightarrow C_1 \rightarrow \dots \rightarrow C_n$ and $L_n(v) = q_f$. We assume wlog that v is the root of the tree, i.e. $v = \epsilon$.

For all $u \in V(\Gamma)$, we define $b(u)$ as the first index $0 \leq i < n$ from which u takes a broadcast transition, and ∞ if it never broadcasts anything.

We define $\Gamma[u]$ as the tree topology obtained from Γ by removing u and all $u' \in V(\Gamma)$ which admits u as a prefix. More formally, $\Gamma[u] = (V', E')$ with $V' = V \setminus \{w \in V \mid w = u \cdot w', w' \in \mathbb{N}^*\}$ and $E' = E \cap (V' \times V')$.

We establish the following lemma before proving Lemma 6.2.

► **Lemma E.1.** *For all $u \in V(\Gamma) \setminus \{\epsilon\}$, $b(u) \neq \infty$. Moreover, for all $u_1, u_2 \in V(\Gamma) \setminus \{\epsilon\}$ such that $u_2 = u_1 \cdot x$ for some $x \in \mathbb{N}$, it holds that $b(u_1) > b(u_2)$.*

Proof. We first prove the first part of the lemma. Assume there exists $u \in V(\Gamma)$ such that $u \neq v$ and u does not broadcast anything during the execution. Take $\Gamma' = \Gamma[u] = (V', E')$. From $C'_0 = (\Gamma', L'_0) \in \mathcal{I}$, we make the processes in $V(\Gamma')$ perform the same sequence of transitions as in the original execution. The remaining parent of u can perform the same sequence of transitions as it never receives anything from u .

Now we prove the second part of the lemma. Assume for the sake of contradiction that there exist $u_1, u_2 \in V(\Gamma) \setminus \{\epsilon\}$ such that $u_2 = u_1 \cdot x$ for some $x \in \mathbb{N}$, and $b(u_1) < b(u_2)$. From the first part of the lemma, $b(u_1) \leq b(u_2) < n$. We show now that q_f is covered with $\Gamma' = \Gamma[u_2]$. For that, we will define by induction configurations $C'_0 = (\Gamma', L'_0), \dots, C'_n = (\Gamma', L'_n)$ such that $C'_0 \in \mathcal{I}$, $C'_1, \dots, C'_n \in \mathcal{C}$ and $C'_0 \rightarrow^* C'_1 \rightarrow^* \dots \rightarrow^* C'_n$. We will prove that, for all $0 \leq k \leq n$,

$$P(k) : \text{for all } v' \in V(\Gamma') \setminus \{u_1\}, L'_k(v') = L_k(v'), \text{ and if } L_k(u_1) \notin Q_2^r, L'_k(u_1) = L_k(u_1).$$

For $k = 0$, C'_0 is uniquely defined, and obviously, for all $v' \in V(\Gamma')$, $L'_0(v') = L_0(v')$. Let $0 \leq k < n$, and assume we have built $C'_0, \dots, C'_k \in \mathcal{C}$ and that $P(k)$ holds. Let $u \in V(\Gamma)$, $t \in \Delta$ such that $C_k \xrightarrow{u,t} C_{k+1}$.

■ If $t = (q, \tau, q')$, we define L'_{k+1} as follows.

$$L'_{k+1}(u') = \begin{cases} q' & \text{if } u' = u \text{ and } L'_k(u) = L_k(u) \\ L'_k(u') & \text{otherwise.} \end{cases}$$

First case: $L'_k(u) = L_k(u)$. Then $L'_k(u) = q$, and it follows immediately that $C'_k \xrightarrow{u,t} C'_{k+1}$. Also, let $v' \in V(\Gamma') \setminus \{u_1\}$. By induction hypothesis, $L'_k(v') = L_k(v')$ hence if $v' \neq u$, $L'_{k+1}(v') = L'_k(v') = L_k(v') = L_{k+1}(v')$ by definition of $C_k \xrightarrow{u,t} C_{k+1}$. Also, $L'_{k+1}(u) = L_{k+1}(u)$ by definition of $C_k \xrightarrow{u,t} C_{k+1}$. If $L_{k+1}(u_1) \notin Q_2^r$ and $u \neq u_1$, then $L_k(u_1) = L_{k+1}(u_1) \notin Q_2^r$, and $L'_{k+1}(u_1) = L'_k(u_1) = L_k(u_1) = L_{k+1}(u_1)$. If $u = u_1$, then by construction $L'_{k+1}(u_1) = q' = L_{k+1}(u_1)$. Then $P(k+1)$ holds.

Second case: $L'_k(u) \neq L_k(u)$. Then $C'_{k+1} = C'_k$ and $C'_k \rightarrow^* C'_{k+1}$. Moreover, since $P(k)$ holds, it implies that $u = u_1$ and $L_k(u_1) \in Q_2^r$. Then $L_{k+1}(u_1) \in Q_2^r$ and $P(k+1)$ holds by induction hypothesis.

■ If $t = (q, !!m, q')$, we differentiate three cases.

1. if $u \in V(\Gamma')$, and $u \neq u_1$, we let $C'_{k+1} = (\Gamma', L'_{k+1})$ defined as follows:



© L. Guillou and A. Sangnier and N. Sznajder;
licensed under Creative Commons License CC-BY 4.0



Leibniz International Proceedings in Informatics
Schloss Dagstuhl – Leibniz-Zentrum für Informatik, Dagstuhl Publishing, Germany

$$L'_{k+1}(u') = L_{k+1}(u') \text{ for all } u' \in \mathcal{V}(\Gamma') \setminus \{u_1\}$$

$$L'_{k+1}(u_1) = \begin{cases} L'_k(u_1) & \text{if } u_1 \notin \mathcal{N}_{\Gamma'}(u) \\ L_{k+1}(u_1) & \text{if } u_1 \in \mathcal{N}_{\Gamma'}(u) \text{ and } L'_k(u_1) = L_k(u_1) \\ p & \text{if } u_1 \in \mathcal{N}_{\Gamma'}(u), L'_k(u_1) \neq L_k(u_1) \text{ and there exists } (L'_k(u_1), ?m, p) \in \Delta \\ L'_k(u_1) & \text{otherwise.} \end{cases}$$

First, we show that $C'_k \xrightarrow{u,t} C'_{k+1}$. By induction hypothesis, $L_k(u') = L'_k(u')$ for all $u' \in \mathcal{V}(\Gamma') \setminus \{u_1\}$. Then $L'_k(u) = L_k(u) = q$ and $L'_{k+1}(u) = q'$. For all $u' \neq u_1$, $L'_{k+1}(u') = L_{k+1}(u')$ and $L_k(u') = L'_k(u')$. If $u_1 \notin \mathcal{N}_{\Gamma'}(u)$, then $L'_{k+1}(u_1) = L'_k(u_1)$, and $C'_k \xrightarrow{u,t} C'_{k+1}$. Otherwise, if $L'_k(u_1) = L_k(u_1)$, then $L'_{k+1}(u_1) = L_{k+1}(u_1)$ and u_1 has behaved correctly, hence $C'_k \xrightarrow{u,t} C'_{k+1}$. If $u_1 \in \mathcal{N}_{\Gamma'}(u)$ and $L'_k(u_1) \neq L_k(u_1)$, then either there exists a transition $(L'_k(u_1), ?m, p) \in \Delta$ and $L'_{k+1}(u_1) = p$ or $L'_{k+1}(u_1) = L'_k(u_1)$.

In any case, $C'_k \xrightarrow{u,t} C'_{k+1}$.

Let $v' \in \mathcal{V}(\Gamma') \setminus \{u_1\}$. By definition, $L'_{k+1}(v') = L_{k+1}(v')$. If $L_{k+1}(u_1) \notin Q_2^r$ then as P is 2-phase bounded, $L_k(u_1) \notin Q_2^r$ and so by induction hypothesis $L'_k(u_1) = L_k(u_1)$. Then, by construction of $L'_{k+1}(u_1)$: either $u_1 \notin \mathcal{N}_{\Gamma'}(u)$ and so $L'_{k+1}(u_1) = L'_k(u_1) = L_k(u_1) = L_{k+1}(u_1)$, or $u_1 \in \mathcal{N}_{\Gamma'}(u)$ and $L'_{k+1}(u_1) = L_{k+1}(u_1)$.

2. If $u = u_1$, note that, as $(L_k(u_1), !!m, L_{k+1}(u_1)) \in \Delta$, by definition of 2-phase-bounded protocols, $L_k(u_1) \notin Q_2^r$. Hence, by induction hypothesis, $L'_k(u_1) = L_k(u_1) = q$. We then simply let $L'_{k+1}(u') = L_{k+1}(u')$ for all $u' \in \mathcal{V}(\Gamma')$. As $C_k \rightarrow C_{k+1}$, and by the induction hypothesis, $C'_k \rightarrow C'_{k+1}$. Moreover, by construction, for all $u' \in \mathcal{V}(\Gamma')$, $L'_k(u') = L'_{k+1}(u')$ hence $P(k+1)$ holds.
3. If $u \notin \mathcal{V}(\Gamma')$, we let $C'_{k+1} = C'_k$ and then $C'_k \rightarrow^* C'_{k+1}$. If $u \neq u_2$, then $\mathcal{N}_{\Gamma'}(u) \cap \mathcal{V}(\Gamma') = \emptyset$. Indeed, $u = u_2 \cdot w$ for $w \in \mathbb{N}^+$, hence $u[-1] = u_2 \cdot w' \notin \mathcal{V}(\Gamma')$ and for every $x \in \mathbb{N}$, $u \cdot x \notin \mathcal{V}(\Gamma')$. Hence, for $u' \in \mathcal{V}(\Gamma')$, $L_{k+1}(u') = L_k(u')$. Then, $P(k+1)$ holds.

If $u = u_2$, its only neighbor in $\mathcal{V}(\Gamma')$ is u_1 . Furthermore, as $b(u_1) < b(u_2) \leq k$, u_1 already broadcast some messages, and as P is 2-phase-bounded, $L_k(u_1) \in Q_1^b \cup Q_2^b \cup Q_2^r$. Either $L_{k+1}(u_1) = L_k(u_1)$, and since $L'_{k+1}(u_1) = L'_k(u_1)$, the induction property still holds, or $(L_k(u_1), ?m, L_{k+1}(u_1)) \in \Delta$. Then, as P is 2-phase-bounded, $L_{k+1}(u_1) \in Q_2^r$, and the induction property holds too.

Then $L'_n(\epsilon) = L_n(\epsilon)$ (since $u_1 \neq \epsilon$), and $L'_n(\epsilon) = q_f$. Hence we found a tree topology $\Gamma' = (V', E')$ with $|V'| < |V|$ with which q_f is coverable. This is not possible as $|V| = f(P, q_f)$, hence $b(u_1) > b(u_2)$. \blacktriangleleft

We are now ready to prove Lemma 6.2.

Proof of Lemma 6.2. Assume there exists $u \in \mathcal{V}(\Gamma)$ such that $|u| > |Q| + 1$. For all $1 \leq i \leq |u|$, we denote v_i the prefix of u of length i . By definition of a tree topology, for all $1 \leq i \leq |u|$, $v_i \in \mathcal{V}(\Gamma)$. Let $1 \leq i \leq n$, from Lemma E.1 we know that $0 \leq b(v_i) < n$. Hence, we can denote q_i the state from which v_i performs its first broadcast, i.e. $C_{b(v_i)} \xrightarrow{v_i, (q_i, !!m_i, q'_i)} C_{b(v_i)+1}$ for some $m_i \in \Sigma$ and $q'_i \in Q$.

As $|u| > |Q| + 1$, there exists $1 < i_1 < i_2 \leq |u|$ such that $q_{i_1} = q_{i_2}$. Note that we take two such nodes in $v_2, \dots, v_{|u|}$ instead of in $v_1, \dots, v_{|u|}$. We will see later that we need v_{i_1} to *not* have ϵ as neighbor in order to apply Lemma E.1 on v_{i_1} and its neighbor v_{i_1-1} .

From Lemma E.1, $b(v_{i_1}) > b(v_{i_2})$. Take $\Gamma' = (V', E')$ defined as the tree topology obtained from Γ by only keeping processes u such that (1) the unique path between path from u to v

does not contain v_{i_1} , i.e. v_{i_1} is not a prefix of u , or (2) the unique path between u and v contains v_{i_2} , i.e. v_{i_2} is a prefix of u . We also add an edge between v_{i_2} and the remaining parent of v_{i_1} . To stay consistent with the definition of our tree topology, we also rename nodes. More formally: $V' = V \setminus \{u \in V \mid v_{i_1} \text{ is a prefix of } u\} \cup \{v_{i_1} \cdot w \mid w \in \mathbb{N}^* \text{ and } v_{i_2} \cdot w \in V\}$, and $E' = \{(w, w \cdot x) \mid x \in \mathbb{N}, w \in V', w \cdot x \in V'\}$. Let $w \in V'$, we let

$$\begin{aligned} \text{tr} : V' &\rightarrow V \\ \text{tr} : w &\mapsto \begin{cases} w & \text{if } v_{i_1} \text{ is not a prefix of } w \text{ in } V' \\ v_{i_2} \cdot w' & \text{if } w = v_{i_1} \cdot w' \text{ in } V' \text{ for some } w' \in \mathbb{N}^*. \end{cases} \end{aligned}$$

Note that for all $u_1, u_2 \in \mathbb{V}(\Gamma')$, such that $(u_1, u_2) \neq (v_{i_1-1}, v_{i_1})$, it holds that: $(u_1, u_2) \in \mathbb{E}(\Gamma')$ if and only if $(\text{tr}(u_1), \text{tr}(u_2)) \in \mathbb{E}(\Gamma)$.

We prove the existence of an execution covering q_f with Γ' in three steps.

First step.

We start by building $C'_0 = (\Gamma', L'_0) \in \mathcal{I}$, $C'_1, \dots, C'_{b(v_{i_2})} \in \mathcal{C}$ such that for all $0 \leq i \leq b(v_{i_2})$, and $C'_i = (\Gamma', L'_i)$, for all $u \in \mathbb{V}(\Gamma')$, $L'_i(u) = L_i(\text{tr}(u))$. We now prove by induction that $C'_0 \rightarrow^* C'_1 \rightarrow^* \dots \rightarrow^* C'_{b(v_{i_2})}$. Let $k \geq 0$, and assume that we have proved that $C'_0 \rightarrow^* C'_k$.

Assume that $C_k \xrightarrow{u,t} C_{k+1}$.

- if $t = (q, \tau, q')$ and there exists $v \in \mathbb{V}(\Gamma')$ such that $\text{tr}(v) = u$, then by construction, $L'_k(v) = L_k(v) = q$ and $L'_{k+1}(v) = L_{k+1}(u) = q'$. For all other nodes $v' \in \mathbb{V}(\Gamma')$, $L'_{k+1}(v') = L_{k+1}(\text{tr}(v')) = L_k(\text{tr}(v')) = L'_k(v')$ as tr is injective. Hence, $C'_k \xrightarrow{v,t} C'_{k+1}$.
- if $t = (q, \tau, q')$ and there is no $v \in \mathbb{V}(\Gamma')$ such that $\text{tr}(v) = u$, then for all $v \in \mathbb{V}(\Gamma')$, $L'_{k+1}(v) = L_{k+1}(\text{tr}(v)) = L_k(\text{tr}(v)) = L'_k(v)$ and so $C'_{k+1} = C'_k$.
- if $t = (q, !!m, q')$ and there $v \in \mathbb{V}(\Gamma')$ such that $\text{tr}(v) = u$, then by construction, $L'_k(v) = L_k(v) = q$ and $L'_{k+1}(v) = L_{k+1}(u) = q'$. Furthermore, for all nodes v' such that $(v', v) \in \mathbb{E}(\Gamma')$, then either $(\text{tr}(v'), \text{tr}(v)) \in \mathbb{E}(\Gamma')$ or $\{v, v'\} = \{v_{i_1-1}, v_{i_1}\}$. In the first case, as $C_k \xrightarrow{\text{tr}(v), t} C_{k+1}$, either $(L'_k(v'), ?m, L'_{k+1}(v')) \in \Delta$ or $L'_k(v') = L'_{k+1}(v')$ and there is no $p \in Q$ such that $(L'_k(v'), ?m, p) \in \Delta$. In the latter case, recall that $k < b(v_{i_2})$ and, from Lemma E.1, $b(v_{i_2}) < \dots < b(v_{i_1}) < b(v_{i_1-1})$. Hence, $u \notin \{v_{i_2}, v_{i_1-1}\}$. Hence, $v \notin \{v_{i_1-1}, v_{i_1}\}$, and we reach a contradiction.

All other nodes u' not neighbors of v are such that $L'_{k+1}(u') = L_{k+1}(\text{tr}(u'))$ and $(\text{tr}(u'), \text{tr}(v)) \notin \mathbb{E}(\Gamma')$, as $v \notin v_{i_1}$. Hence, $L'_{k+1}(u') = L_{k+1}(\text{tr}(u')) = L_k(\text{tr}(u')) = L'_k(u')$.

Hence $C'_k \xrightarrow{v,t} C'_{k+1}$.

- if $t = (q, !!m, q')$ and there is no $v \in \mathbb{V}(\Gamma')$ such that $\text{tr}(v) = u$, hence $u = v_{i_1} \cdot x$ for some $x \in \mathbb{N}^*$ and v_{i_2} is not a prefix of u . We prove that for all $v \in \mathbb{V}(\Gamma')$, it holds that $L_{k+1}(\text{tr}(v)) = L_k(\text{tr}(v))$. Assume this is not the case, then $(\text{tr}(v), u) \in \mathbb{E}(\Gamma)$. If $\text{tr}(v)$ is a parent of u and so $\text{tr}(v) = v_{i_1-1}$ and $u = v_{i_1}$. With Lemma E.1 it implies that $k < b(v_{i_2}) < b(u)$, which is absurd as $C_k \xrightarrow{u,t} C_{k+1}$. If u is a parent of $\text{tr}(v)$, then $\text{tr}(v) = v_{i_2}$ and $u = v_{i_2-1}$. For the same reason, we get $k < b(v_{i_2}) < b(u)$, which is absurd as $C_k \xrightarrow{u,t} C_{k+1}$. Hence $(\text{tr}(v), u) \notin \mathbb{E}(\Gamma)$ and $L_{k+1}(\text{tr}(v)) = L_k(\text{tr}(v))$. Hence, $L'_{k+1}(v) = L_{k+1}(\text{tr}(v)) = L_k(\text{tr}(v)) = L'_k(v)$ for all $v \in \mathbb{V}(\Gamma')$ and so $C'_k = C'_{k+1}$.

Hence $C'_0 \rightarrow^* C'_{b(v_{i_2})}$ where for all $u \in \mathbb{V}(\Gamma')$, $L'_{b(v_{i_2})}(u) = L_{b(v_{i_2})}(\text{tr}(u))$.

Second step.

Next, we build $C'_{b(v_{i_2})+1}, C'_{b(v_{i_2})+2}, \dots, C'_{b(v_{i_1})} \in \mathcal{C}$ such that $C'_{b(v_{i_2})} \rightarrow^* \dots \rightarrow^* C'_{b(v_{i_1})}$. Moreover, we ensure that for all $b(v_{i_2}) \leq k \leq b(v_{i_1})$, if we let $C'_k = (\Gamma', L'_k)$,

$$\begin{aligned} \text{for all } u \in \mathcal{V}(\Gamma') \text{ such that } u = \text{tr}(u), L'_k(u) &= L_k(u) \\ \text{and } L'_k(v_{i_1}) &= q_{i_2}. \end{aligned}$$

Observe that, from the first step, $C'_{b(v_{i_2})}$ is such that for all $u \in \mathcal{V}(\Gamma')$, $L'_{b(v_{i_2})}(u) = L_{b(v_{i_2})}(\text{tr}(u))$, and then $L'_{b(v_{i_2})}(v_{i_1}) = L_{b(v_{i_2})}(\text{tr}(v_{i_1})) = L_{b(v_{i_2})}(v_{i_2}) = q_{i_2}$. So the induction hypothesis holds for $k = b(v_{i_2})$.

Now, let $b(u_{i_2}) \leq k < b(v_{i_1})$ and assume that we have built $C'_{b(u_{i_2})}, \dots, C'_k$. Let $v \in \mathcal{V}(\Gamma)$ and $t = (q, \alpha, q')$ such that $C_k \xrightarrow{v,t} C_{k+1}$. If there is no $u \in \mathcal{V}(\Gamma')$ such that $\text{tr}(u) = v$, or if the only $u \in \mathcal{V}(\Gamma')$ such that $\text{tr}(u) = v$ is such that $u \neq v$, then we let $C'_{k+1} = C'_k$.

- If $\alpha = \tau$, we know that for all $u' \in \mathcal{V}(\Gamma) \setminus \{v\}$, $L_{k+1}(u') = L_k(u')$, hence, by induction hypothesis, if $u' = \text{tr}(u')$, we have that $L'_{k+1}(u') = L_{k+1}(u')$, and $L'_{k+1}(v_{i_1}) = q_{i_2}$.
- If $\alpha = !!m$ for some $m \in \Sigma$, then the neighbors of v may have changed state. Since $k < b(v_{i_1})$, we know that $u \neq v_{i_1}$. Hence, $u = v_{i_1} \cdot w$ for some $w \in \mathbb{N}^+$ and then, for all $u' \in \mathcal{V}(\Gamma')$, if $u' = \text{tr}(u')$, then $u' \notin \mathcal{N}_\Gamma(v)$. Thus, for all $u' \in \mathcal{V}(\Gamma')$ such that $u' = \text{tr}(u')$, $L_{k+1}(u') = L_k(u')$ and then $L'_{k+1}(u') = L_{k+1}(u')$. Moreover, $L'_{k+1}(v_{i_1}) = L'_k(v_{i_1}) = q_{i_2}$.

Assume now that $v = \text{tr}(v)$. By definition, v_{i_1} is not a prefix of v in V' .

- If $\alpha = \tau$, we let $L'_{k+1}(v) = q'$ and, for all $u \in \mathcal{V}(\Gamma') \setminus \{v\}$, $L'_{k+1}(u) = L_{k+1}(u) = L_k(u)$. By induction hypothesis, $L'_k(v) = L_k(v)$, hence $(L'_k(v), \tau, L'_{k+1}(v)) \in \Delta$ and $C'_k \xrightarrow{v,t} C'_{k+1}$. Moreover, for all $u \in \mathcal{V}(\Gamma')$ such that $u = \text{tr}(u)$, $L'_{k+1}(u) = L_{k+1}(u)$. Also, $v \neq v_{i_1}$ hence $L'_{k+1}(v_{i_1}) = L'_k(v_{i_1}) = q_{i_2}$.
- If $\alpha = !!m$, let $L'_{k+1}(v) = q'$ and, for all $u \in \mathcal{N}_{\Gamma'}(v)$, if $\text{tr}(u) = u$, let $L'_{k+1}(u) = L_{k+1}(u)$. For all other $u \in \mathcal{V}(\Gamma')$, let $L'_{k+1}(u) = L'_k(u)$. First, we show that $C'_k \xrightarrow{v,t} C'_{k+1}$. By induction hypothesis, $L'_k(v) = L_k(v)$, hence $(L'_k(v), !!m, L'_{k+1}(v)) \in \Delta$. Let $u \in \mathcal{N}_{\Gamma'}(v)$ and assume that $\text{tr}(u) \neq u$. It means that $u = v_{i_1} \cdot w$ for some $w \in \mathbb{N}^*$. Since $v = \text{tr}(v)$, we also know that v_{i_1} is not a prefix of v . If $v = u \cdot x$ then $v = v_{i_1} \cdot w \cdot x$, which is impossible since u_{i_1} is not a prefix of v . If $u = v \cdot x$, then either v_{i_1} is also a prefix of v which is impossible, or $u = v_{i_1}$ and then $v_{i_1} = v \cdot x$. This means that $v = v_{i_1-1}$, the father of v_{i_1} . By Lemma E.1, it would mean that $b(v) = b(v_{i_1}) < b(v)$ but $k < b(v_{i_1})$ and v broadcasts a message from C_k . This leads to a contradiction. Hence, for all $u \in \mathcal{N}_{\Gamma'}(v)$, $\text{tr}(u) = u$, and then, for all $u \in \mathcal{N}_{\Gamma'}(v)$, $L'_{k+1}(u) = L_{k+1}(u)$. By induction hypothesis, $L_k(u) = L'_k(u)$, then either $L_k(u) = L_{k+1}(u)$ and there is no $(L'_k(u), ?m, p) \in \Delta$, or $(L'_k(u), ?m, L'_{k+1}(u))$. Hence $C'_k \xrightarrow{v,t} C'_{k+1}$. Moreover, by induction hypothesis, for all $u \in \mathcal{V}(\Gamma')$ such that $\text{tr}(u) = u$, $L'_k(u) = L_k(u)$. Then, if $u \in \mathcal{N}_{\Gamma'}(v)$, $L'_{k+1}(u) = L_{k+1}(u)$, and otherwise, $L'_{k+1}(u) = L'_k(u) = L_k(u)$. Let again u such that $u = \text{tr}(u)$ and $(u, v) \notin \mathcal{E}(\Gamma')$, then $(\text{tr}(u), \text{tr}(v)) \notin \mathcal{E}(\Gamma)$, hence $(u, v) \notin \mathcal{E}(\Gamma)$. Then $u \notin \mathcal{N}_\Gamma(v)$ and $L_{k+1}(u) = L_k(u)$. Hence, for all $u \in \mathcal{V}(\Gamma')$ such that $u = \text{tr}(u)$, $L'_{k+1}(u) = L_{k+1}(u)$. Since $v_{i_1} \neq \text{tr}(v_{i_1})$, and since $v \neq v_{i_1}$, $L'_{k+1}(v_{i_1}) = L'_k(v_{i_1}) = q_{i_2}$ by induction hypothesis.

In this part of the execution, we have forgotten the transitions issued by nodes $u = v_{i_1} \cdot w$ for $w \in \mathbb{N}^+$ in $\mathcal{V}(\Gamma)$. The configuration we reach is such that $L'_{b(v_{i_1})}(v_{i_1}) = q_{i_2}$ and correspond to the states reached in $C_{b(v_{i_1})}$ in the rest of the tree. This will allow us to reach q_f . The subtree rooted in v_{i_1} might visit different states than in the original execution, but this will



not influence the states visited by the root, thanks to the fact that the protocol is 2-phase bounded.

Third step.

Finally, we build $C'_{b(v_{i_1})}, C'_{b(v_{i_1})+1}, \dots, C'_n \in \mathcal{C}$ such that $C'_{b(v_{i_1})} \rightarrow^* C'_{b(v_{i_1})+1} \rightarrow^* \dots \rightarrow^* C'_n$. Moreover, we ensure that for all $b(v_{i_1}) \leq k \leq n$, if we let $C'_k = (\Gamma', L'_k)$,

$$\begin{aligned} \text{for all } u \in \mathcal{V}(\Gamma') \text{ such that } u = \text{tr}(u), L'_k(u) &= L_k(u) \\ \text{and } L'_k(v_{i_1}) &= L_k(v_{i_1}) \text{ or } L_k(v_{i_1}) \in Q_2^r. \end{aligned}$$

Processes $u \in \mathcal{V}(\Gamma')$ such that $u = \text{tr}(u)$, perform the same sequence of transitions than between $C_{b(v_{i_1})}$ and C_n and process v_{i_1} broadcasts the sequence of messages broadcast by the same node in Γ . Formally we build the sequence by induction on $b(v_{i_1}) \leq k \leq n$. $C'_{b(v_{i_1})}$ is already defined and satisfies the induction property. Assume we have built $C'_{b(v_{i_1})}, \dots, C'_k$ for some $b(v_{i_2}) \leq k < n$ such that: for all $u \in \mathcal{V}(\Gamma')$ with $u = \text{tr}(u)$, it holds that $L'_k(u) = L_k(u)$, and, furthermore either $L'_k(v_{i_1}) = L_k(v_{i_1})$ or $L_k(v_{i_1}) \in Q_2^r$.

Denote $C_k \xrightarrow{u,t} C_{k+1}$ with $t = (q, \alpha, q')$ and $\alpha \in \{\tau\} \cup \Sigma$.

- First, if $\alpha = \tau$ and $u = \text{tr}(u)$ or $u = v_{i_1}$, then define L'_{k+1} as follows: if $L'_k(u) = L_k(u)$, define $L'_{k+1}(u) = q'$ and $L'_{k+1}(u') = L'_k(u')$ for all other nodes, otherwise $L'_{k+1} = L'_k$.
 - If $L'_k(u) = L_k(u)$, $L_k(u) = q$ and so we immediately get that $C'_k \rightarrow C'_{k+1}$. Furthermore, for all $u' \in \mathcal{V}(\Gamma') \setminus \{u\}$, it holds that $L'_{k+1}(u') = L'_k(u')$. If $u' \neq v_{i_1}$ and $u' = \text{tr}(u')$, by induction hypothesis, $L'_{k+1}(u') = L'_k(u') = L_k(u') = L_{k+1}(u')$. Furthermore, either $u = v_{i_1}$ and $L'_{k+1}(v_{i_1}) = L_{k+1}(v_{i_1})$, or $u \neq v_{i_1}$ and as $L_{k+1}(v_{i_1}) = L_k(v_{i_1})$, it holds that $L'_{k+1}(v_{i_1}) = L_{k+1}(v_{i_1})$ or $L_{k+1}(v_{i_1}) = L_k(v_{i_1}) \in Q_2^r$.
 - If $L'_k(u) \neq L_k(u)$, by induction hypothesis $u = v_{i_1}$ and $L_k(v_{i_1}) \in Q_2^r$. As P is 2-phase-bounded, for all p such that $(L_k(v_{i_1}), \tau, p) \in \Delta$, it holds that $p \in Q_2^r$. Hence, $L_{k+1}(v_{i_1}) \in Q_2^r$ and the induction property holds.

Note that if $u \neq \text{tr}(u)$ and $u \neq v_{i_1}$, for all u' such that $u' = \text{tr}(u')$ or $u' = v_{i_1}$, it holds that $L_{k+1}(u') = L_k(u')$, hence by taking $C'_{k+1} = C'_k$, the induction property holds.

- In the following, we assume that $\alpha \neq m$ for some $m \in \Sigma$. We start by defining C'_{k+1} , then we prove that $C'_k \rightarrow^* C'_{k+1}$ and finally we prove that C'_{k+1} respects the induction property. We build C'_{k+1} depending on u .

1. if $\text{tr}(u) = u$ and $u \neq v_{i_1-1}$, then let $L'_{k+1}(u') = L_{k+1}(u')$ for all u' such that $\text{tr}(u') = u'$, and $L'_{k+1}(u') = L'_k(u')$ for all other nodes.
2. if $u = v_{i_1-1}$, then let $L'_{k+1}(u') = L_{k+1}(u')$ for all u' such that $\text{tr}(u') = u'$, and $L'_{k+1}(u') = L'_k(u')$ for all other nodes $u' \neq v_{i_1}$. It is left to define $L'_{k+1}(v_{i_1})$. If $L'_k(v_{i_1}) = L_k(v_{i_1})$, then define $L'_{k+1}(v_{i_1}) = L_{k+1}(v_{i_1})$, otherwise if there exists $(L'_k(v_{i_1}), ?m, p) \in \Delta$, define $L'_{k+1}(v_{i_1}) = p$, and else define $L'_{k+1}(v_{i_1}) = L'_k(v_{i_1})$.
3. if $u = v_{i_1}$, then let $L'_{k+1}(v_{i_1}) = L_{k+1}(v_{i_1}) = q'$, and let $L'_{k+1}(u') = L_{k+1}(u')$ for all u' such that $\text{tr}(u') = u'$. Furthermore, for all other nodes u' , if $(v_{i_1}, u') \in \mathbf{E}(\Gamma')$, then if there exists $(L'_k(u'), ?m, p) \in \Delta$, let $L'_{k+1}(u') = p$, otherwise $L'_{k+1}(u') = L'_k(u')$. If $(v_{i_1}, u') \notin \mathbf{E}(\Gamma')$, then $L'_{k+1}(u') = L'_k(u')$.
4. otherwise, $C'_{k+1} = C'_k$.



We prove now that in all cases 1, 2 and 3, it holds that $C'_k \rightarrow C'_{k+1}$.

In case 1, observe that as $u \neq v_{i_1-1}$ and $\text{tr}(u) = u$, then all neighbors $u' \in \mathbf{N}_{\Gamma'}(u)$ are such that $\text{tr}(u') = u'$. Indeed, if v_{i_1} is not a prefix of u , it is not a prefix of its parent (if any), and for $x \in \mathbb{N}$, v_{i_1} is a prefix of $u \cdot x$ if and only if $u \cdot x = v_{i_1}$, i.e. $u = v_{i_1-1}$. Hence, for all $(u', u) \in \mathbf{E}(\Gamma')$, it holds that $(\text{tr}(u'), \text{tr}(u')) = (u, u') \in \mathbf{E}(\Gamma)$, and by induction hypothesis $L'_k(u') = L_k(u')$. Therefore, as $C_k \rightarrow C_{k+1}$, $(L'_k(u'), ?m, L'_{k+1}(u')) \in \Delta$ or there is no transition labeled by $?m$ from $L'_k(u')$ and $L'_{k+1}(u') = L'_k(u')$. Furthermore, $(L'_k(u), !!m, L'_{k+1}(u)) \in \Delta$. Let $u' \in \mathbf{V}(\Gamma')$ which is not a neighbor of u , and such that $\text{tr}(u') = u'$. Then, $u' \notin \mathbf{N}_{\Gamma'}(u)$, and by induction hypothesis $L'_k(u') = L_k(u')$. As $C_k \rightarrow C_{k+1}$, $L_k(u') = L_{k+1}(u')$. And so by definition of L'_{k+1} , $L'_{k+1}(u') = L_{k+1}(u') = L'_k(u')$. Let $u' \in \mathbf{V}(\Gamma')$ which is not a neighbor of u and such that $\text{tr}(u') \neq u'$. Then, by definition of L'_{k+1} , $L'_{k+1}(u') = L'_k(u')$. Hence $C'_k \rightarrow C'_{k+1}$.

In case 2, the only difference is that v_{i_1} is now a neighbor of the broadcasting node $u = v_{i_1-1}$. If $L'_k(v_{i_1}) = L_k(v_{i_1})$, then we defined $L'_{k+1}(v_{i_1}) = L_{k+1}(v_{i_1})$. As $(v_{i_1-1}, v_{i_1}) \in \mathbf{E}(\Gamma)$ and $C_k \rightarrow C_{k+1}$, then $(L'_k(v_{i_1}), ?m, L'_{k+1}(v_{i_1})) \in \Delta$ or there is no transition labeled by $?m$ from $L'_k(v_{i_1})$ and $L'_{k+1}(v_{i_1}) = L'_k(v_{i_1})$. Hence, $C'_k \rightarrow C'_{k+1}$. Otherwise, $L'_k(v_{i_1}) \neq L_k(v_{i_1})$, and by definition of L'_{k+1} , either $(L'_k(v_{i_1}), ?m, L'_{k+1}(v_{i_1})) \in \Delta$, or $L'_{k+1}(v_{i_1}) = L'_k(v_{i_1})$ and there is no transitions $(L'_k(v_{i_1}), ?m, p) \in \Delta$ for some $p \in Q$. Hence, $C'_k \rightarrow C'_{k+1}$.

In case 3, note that by definition of a 2-phase-bounded protocol, $L_k(v_{i_1}) \notin Q_2^r$ as $(L_k(v_{i_1}), !!m, q') \in \Delta$. Hence, by induction hypothesis, $L'_k(v_{i_1}) = L_k(v_{i_1})$ and so v_{i_1} can perform the broadcast of m from C'_k . Furthermore, by induction hypothesis, its parent v_{i_1-1} is such that $L'_k(v_{i_1-1}) = L_k(v_{i_1-1})$ and, by definition, $L'_{k+1}(v_{i_1-1}) = L_{k+1}(v_{i_1-1})$. As $(v_{i_1-1}, v_{i_1}) \in \mathbf{E}(\Gamma)$, and $C_k \rightarrow C_{k+1}$, either $(L_k(v_{i_1-1}), ?m, L_{k+1}(v_{i_1-1})) \in \Delta$ or there is no transitions $(L_k(v_{i_1-1}), ?m, p) \in \Delta$ for some $p \in Q$. For other neighbors u' of v_{i_1} , $u' \neq \text{tr}(u')$ and by construction of L'_{k+1} , $(L'_k(u'), ?m, L'_{k+1}(u')) \in \Delta$, or there is no reception transitions labeled by $?m$ from $L'_k(u')$ and $L'_{k+1}(u') = L'_k(u')$. Other nodes u' which are not neighbors of v_{i_1} are either such that $u' = \text{tr}(u')$, and it holds that $L'_{k+1}(u') = L_{k+1}(u') = L_k(u') = L'_k(u')$, as $(u', v_{i_1}) \notin \mathbf{E}(\Gamma)$. Or $u' \neq \text{tr}(u')$ and by construction, $L'_{k+1}(u') = L'_k(u')$. Hence it holds that $C'_k \rightarrow C'_{k+1}$.

We prove now that in all cases 1, 2, 3 and 4, C'_{k+1} satisfies the induction property, i.e. for all $u \in \mathbf{V}(\Gamma')$ such that $\text{tr}(u) = u$, it holds that $L'_{k+1}(u) = L_{k+1}(u)$, and $L'_{k+1}(v_{i_1}) = L_{k+1}(v_{i_1})$ or $L_{k+1}(v_{i_1}) \in Q_2^r$. In case 1, the first part is trivial by construction. As $(u, v_{i_1}) \notin \mathbf{E}(\Gamma)$, $L_{k+1}(v_{i_1}) = L_k(v_{i_1})$, hence either $L'_{k+1}(v_{i_1}) = L'_k(v_{i_1}) = L_k(v_{i_1}) = L_{k+1}(v_{i_1})$ by induction hypothesis, or $L_{k+1}(v_{i_1}) = L_k(v_{i_1}) \in Q_2^r$.

In case 2, either $L'_{k+1}(v_{i_1}) = L_{k+1}(v_{i_1})$ or $L'_k(v_{i_1}) \neq L_k(v_{i_1})$. In the latter case, by induction hypothesis, $L_k(v_{i_1}) \in Q_2^r$, and so, as P is 2-phase-bounded, $L_{k+1}(v_{i_1}) \in Q_2^r$. Case 3 is direct from the definition of L'_{k+1} .

In case 4, for all $u' \in \mathbf{V}(\Gamma')$ such that $u' = \text{tr}(u')$, $L_{k+1}(u') = L_k(u')$ as $(u', u) \notin \mathbf{E}(\Gamma)$. Hence, $L'_{k+1}(u') = L'_k(u') = L_k(u') = L_{k+1}(u')$. However, if $u = v_{i_1+1}$, v_{i_1} might change its state between C_k and C_{k+1} upon reception of m . If it does so, $(L_k(v_{i_1}), ?m, L_{k+1}(v_{i_1})) \in \Delta$. As $k > b(v_{i_1})$ and P is 2-phase-bounded, v_{i_1} already went through its broadcasting phase, and $L_{k+1}(v_{i_1}) \in Q_2^r$, and so the induction property holds.

Conclusion.

Hence we found an execution covering q_f with a tree topology $\Gamma' = (V', E')$ and $|V'| < |V|$. It contradicts the fact that $|V| = f(P, q_f)$.



© L. Guillou and A. Sangnier and N. Sznajder;
licensed under Creative Commons License CC-BY 4.0



Leibniz International Proceedings in Informatics
Schloss Dagstuhl – Leibniz-Zentrum für Informatik, Dagstuhl Publishing, Germany

□

E.1.2 Proof of Theorem 6.3

Proof of Theorem 6.3. We prove the decidability by reducing both COVER and COVER[Trees] to COVER[K – BP]. Let P a protocol and q_f a state of P . Assume that there is a topology Γ with which q_f is coverable. Then, by Theorem 2.4, there exist a tree topology Γ' with which q_f is coverable. Assume that $|V| = f(P, q_f)$. Then, each simple path in Γ' has a length bounded by $2(|Q| + 1)$. Indeed, let $u_1, u_2 \in V(\Gamma')$, as Γ' is a tree topology, the unique simple path between u_1 and u_2 either contains ϵ and $d(u_1, u_2) = |u_1| + |u_2|$, or there exists $u \in \mathbb{N}^+$ such that $u_1 = u \cdot u'_1$ and $u_2 = u \cdot u'_2$, and u'_1 and u'_2 have no common prefix. In the latter case, the length of the simple path between u_1 and u_2 is $|u'_1| + |u'_2| < |u_1| + |u_2|$. In both cases, $d(u_1, u_2) \leq |u_1| + |u_2|$, and hence from Lemma 6.2, $d(u_1, u_2) \leq 2(|Q| + 1)$. Then q_f is coverable in a $2(|Q| + 1)$ -bounded path topology.

Conversely, assume that there exists a $2(|Q| + 1)$ -bounded path topology Γ with which q_f is coverable. Then, immediately, there is a topology with which q_f is coverable. By Theorem 2.4, there also exists a tree topology with which q_f is coverable. Theorem 6.1 allows to conclude to decidability of both COVER and COVER[Trees]. □

E.2 Proofs of Section 6.2

E.2.1 Proof of Lemma 6.4

Let $q_f \in Q$ be a coverable state. We fix Γ with $V(\Gamma) = \{v_1, \dots, v_\ell\}$ the line topology such that there exist $\rho = C_0 \rightarrow \dots \rightarrow C_n$ with $C_n = (\Gamma, L_n)$ and $L_n(v_N) = q_f$ for some $v_N \in V(\Gamma)$. We suppose wlog that $N \geq 3$ and $N \leq \ell - 2$, otherwise, we can just add artificial nodes not issuing any transition in the execution.

We start by proving the following lemma.

► **Lemma E.2.** *There exists $\rho' = C'_0 \rightarrow^* C'_n$ such that $C'_n = (\Gamma, L'_n)$ with $L'_n(v_N) = q_f$, and*

- for all $1 \leq i \leq N - 2$, $t_{last}(v_i, \rho') \leq b_{first}(v_{i+1}, \rho')$;
- for all $N + 2 \leq i \leq \ell$, $t_{last}(v_i, \rho') \leq b_{first}(v_{i-1}, \rho')$.

E.2.1.1 Proof of Lemma E.2.

To prove Lemma E.2, we give two symmetric lemmas.

► **Lemma E.3.** *Let $\rho = C_0 \rightarrow^* C$ with $C = (\Gamma, L)$ and $1 \leq K < \ell$. There exists $\rho' = C_0 \rightarrow^* C'$ such that $C' = (\Gamma, L')$, and*

- for all $v \in \{v_{K+1}, \dots, v_\ell\}$, $L'(v) = L(v)$;
- for all $1 \leq i \leq K - 1$, $t_{last}(v_i, \rho') \leq b_{first}(v_{i+1}, \rho')$;
- for all $K \leq i \leq \ell$, $t_{last}(v_i, \rho') \leq b_{first}(v_{i+1}, \rho')$ if and only if $t_{last}(v_i, \rho) \leq b_{first}(v_{i+1}, \rho)$.

Proof. We show that we can build ρ_K by induction on K : for $K = 1$, there is nothing to do and $\rho_1 = \rho$. Let $1 < K < \ell$, and assume we have built $\rho_{K-1} = C_0 \xrightarrow{v^0, t^0} C_1 \xrightarrow{v^1, t^1} \dots \xrightarrow{v^{n-1}, t^{n-1}} C_n$ such that $C_n = (\Gamma, L_n)$ and:

- for all $v \in \{v_K, \dots, v_\ell\}$, $L_n(v) = L(v)$;



© L. Guillou and A. Sangnier and N. Sznajder;
licensed under Creative Commons License CC-BY 4.0



Leibniz International Proceedings in Informatics
Schloss Dagstuhl – Leibniz-Zentrum für Informatik, Dagstuhl Publishing, Germany

- for all $1 \leq i \leq K-2$, $t_{\text{last}}(v_i, \rho_{K-1}) \leq b_{\text{first}}(v_{i+1}, \rho_{K-1})$;
- for all $K \leq i \leq \ell$, $t_{\text{last}}(v_i, \rho_{K-1}) \leq b_{\text{first}}(v_{i+1}, \rho_{K-1})$ if and only if $t_{\text{last}}(v_i, \rho) \leq b_{\text{first}}(v_{i+1}, \rho)$.

If $t_{\text{last}}(v_{K-1}, \rho_{K-1}) \leq b_{\text{first}}(v_K, \rho_{K-1})$, there is nothing to do.

Assume $t_{\text{last}}(v_{K-1}, \rho_{K-1}) > b_{\text{first}}(v_K, \rho_{K-1})$, then $t_{\text{last}}(v_{K-1}, \rho_{K-1}) \geq 0$ and v_{K-1} issues at least one transition in ρ_{K-1} after $b_{\text{first}}(v_K, \rho_{K-1})$. Let

$$j_1 = \begin{cases} \min\{j > b_{\text{first}}(v_K, \rho_{K-1}) \mid C_j \xrightarrow{v_{K-1}, t} C_{j+1} \text{ for some } t \in \Delta\} & \text{if } b_{\text{first}}(v_{K-1}, \rho_{K-1}) \leq b_{\text{first}}(v_K, \rho_{K-1}) \\ \min\{j \geq 0 \mid C_j \xrightarrow{v_i, t} C_{j+1} \text{ for some } t \in \Delta \text{ and for some } 1 \leq i \leq K-1\} & \text{otherwise.} \end{cases}$$

We now build the following sequence of configurations C'_{j_1}, \dots, C'_n :

- $C'_{j_1} = C'_{j_1+1} = C_{j_1}$;
- for $j_1 + 1 \leq j < n$, $C'_{j+1} = (\Gamma, L'_{j+1})$ and
 - $L'_{j+1}(v) = L_{j+1}(v)$ for all $v \in \{v_{K+1}, \dots, v_\ell\}$,
 - $L'_{j+1}(v) = L'_j(v)$ for all $v \in \{v_1, \dots, v_{K-2}\}$,
 - $L'_{j+1}(v_{K-1})$ is defined as follows: if $v^j = v_K$ and t^j is a broadcast transition of some message $m \in \Sigma$, and $(L'_j(v_{K-1}), ?m, p) \in \Delta$ for some $p \in Q$, then $L'_{j+1}(v_{K-1}) = p$, otherwise $L'_{j+1}(v_{K-1}) = L'_j(v_{K-1})$;
 - $L'_{j+1}(v_K)$ is defined as follows:
 - * if $v^j = v_{K+1}$ and $L'_j(v_K) \neq L_j(v_K)$ and t^j is a broadcast transition of some message $m \in \Sigma$, and $(L'_j(v_K), ?m, p) \in \Delta$ for some $p \in Q$, then $L'_{j+1}(v_K) = p$;
 - * if $v^j = v_{K+1}$ and $L'_j(v_K) = L_j(v_K)$, then $L'_{j+1}(v_K) = L_{j+1}(v_K)$;
 - * if $v^j = v_K$ and $L'_j(v_K) = L_j(v_K)$, then $L'_{j+1}(v_K) = L_{j+1}(v_K)$;
 - * otherwise, $L'_{j+1}(v_K) = L'_j(v_K)$.

At j_1 , actions of process v_{K-1} (and hence actions of all processes in $\{v_1, \dots, v_{K-1}\}$) will have no influence any more on $\{v_{K+1}, \dots, v_\ell\}$, either because v_K has emitted its first broadcast, and thus will only receive messages from $\{v_1, \dots, v_{K-1}\}$ in its last reception phase (then will never feed it to v_{K+1}), or because anyway the first broadcast of v_{K-1} happens to late (after the first broadcast of v_K). In order to prove the induction step, we have just built a sequence of configurations that ignore subsequent actions of $\{v_1, \dots, v_{K-1}\}$, starting from j_1 , while still being an execution. The state of the protocol in which v_K is during this part of the execution is either faithful to what it was in ρ_{K-1} , or v_K is in its last reception phase.

Formally, we now prove that, for all $j_1 + 1 \leq j \leq n$,

1. $P_1(j)$: either $C'_{j-1} \xrightarrow{v^{j-1}, t^{j-1}} C'_j$ and $v^{j-1} \in \{v_K, \dots, v_\ell\}$ or $C'_j = C'_{j-1}$ and $v^{j-1} \in \{v_1, \dots, v_K\}$,
2. $P_2(j)$: $L'_j(v_K) = L_j(v_K)$ or $L'_j(v_K) \in Q_2^r$.

We prove $P_1(j)$ and $P_2(j)$ by induction on j . For $j = j_1 + 1$, $P_1(j)$ trivially holds as $C'_{j_1+1} = C'_{j_1}$ and $C_{j_1} \xrightarrow{v_i, t} C_{j_1+1}$ for $1 \leq i \leq K-1$, by construction. Let us prove now that $P_2(j_1 + 1)$ holds: recall first that $L'_{j_1+1}(v_K) = L'_{j_1}(v_K) = L_{j_1}(v_K)$. Since $C_{j_1} \xrightarrow{v_i, t} C_{j_1+1}$, for some $1 \leq i \leq K-1$, either $L_{j_1+1}(v_K) = L_{j_1}(v_K)$ and $P_2(j)$ holds, or $(L_{j_1}(v_K), ?m, L_{j_1+1}(v_K)) \in \Delta$ and $t = (p, !!m, q)$. In that case $C_{j_1} \xrightarrow{v_{K-1}, t} C_{j_1+1}$. Since either $j_1 > b_{\text{first}}(v_K, \rho_{K-1})$ if $b_{\text{first}}(v_{K-1}, \rho_{K-1}) \leq b_{\text{first}}(v_K, \rho_{K-1})$, or $b_{\text{first}}(v_{K-1}, \rho_{K-1}) > b_{\text{first}}(v_K, \rho_{K-1})$ and $C_{j_1} \xrightarrow{v_{K-1}, t} C_{j_1+1}$ with $t = (p, !!m, q)$, then in any case $j_1 > b_{\text{first}}(v_K, \rho_{K-1})$. Since P is 2-phase-bounded, $L_{j_1}(v_K) \in Q_1^b \cup Q_2^b \cup Q_2^r$ and so $L_{j_1+1}(v_K) \in Q_2^r$. Hence $P_2(j)$ holds.

Let now $j_1 + 1 \leq j < n$ such that $P_1(j)$ and $P_2(j)$ hold. We make the following observation.

► **Observation E.4.** Let $C_1 \xrightarrow{v,t} C'_1$ with $C_1 = (\Gamma, L_1)$ and $C'_1 = (\Gamma, L'_1)$. Consider $C_2 = (\Gamma, L_2)$, $C'_2 = (\Gamma, L'_2)$ two configurations such that, for all $u \in \{v\} \cup N(v)$, $L_2(u) = L_1(u)$ and $L'_2(u) = L'_1(u)$, and for all $u \notin \{v\} \cup N(v)$, $L'_2(u) = L_2(u)$. Then $C_2 \xrightarrow{v,t} C'_2$.

The induction step is proved by a case analysis over $v^j \in V(\Gamma)$. (Recall that $C_j \xrightarrow{v^j, t^j} C_{j+1}$.)

- Assume $v^j \in \{v_{K+2}, \dots, v_\ell\}$. Then $\{v^j\} \cup N(v^j) \subseteq \{v_{K+1}, \dots, v_\ell\}$, and by construction of C'_j and C'_{j+1} , for all $v \in \{v^j\} \cup N(v^j)$, $L'_j(v) = L_j(v)$ and $L'_{j+1}(v) = L_{j+1}(v)$. Then, nodes of $\{v^j\} \cup N(v^j)$ behave in the same way than in ρ_{K-1} . Let $v \notin \{v^j\} \cup N(v^j)$ and $v \in \{v_1, \dots, v_K\}$. In that case, either $v \in \{v_1, \dots, v_{K-2}\}$, and by construction, $L'_{j+1}(v) = L'_j(v)$, or $v \in \{v_{K-1}, v_K\}$, and since $v^j \notin \{v_{K-2}, v_{K-1}, v_K, v_{K+1}\}$, by construction, $L'_{j+1}(v) = L'_j(v)$. Let $v \notin \{v^j\} \cup N(v^j)$ such that $v \in \{v_{K+1}, \dots, v_\ell\}$. In that case, $L'_{j+1}(v) = L_{j+1}(v) = L_j(v) = L'_j(v)$. This allows us to conclude that $C'_j \xrightarrow{v^j, t^j} C'_{j+1}$ thanks to Observation E.4, and so $P_1(j+1)$ holds. By $P_2(j)$, either $L'_j(v_K) = L_j(v_K)$ and we have just proved that $L'_{j+1}(v_K) = L'_j(v_K)$, and that $L_j(v_K) = L_{j+1}(v_K)$. Then $L'_{j+1}(v_K) = L_{j+1}(v_K)$ and $P_2(j+1)$ holds. Or $L_j(v_K) \in Q_2^r$ and since $L_j(v_K) = L_{j+1}(v_K)$, $L_{j+1}(v_K) \in Q_2^r$. Hence, $P_2(j+1)$ holds.
- Assume that $v^j = v_{K+1}$, or that $v^j = v_K$ and $L'_j(v_K) = L_j(v_K)$. By construction, $L_{j+1}(v^j) = L'_{j+1}(v^j)$ and $L_j(v^j) = L'_j(v^j)$. Observe that v^j has at most two neighbors v, v' such that:
 - $v = v_{K+2}$ or $v = v_{K+1}$, and so by construction $L_{j+1}(v) = L'_{j+1}(v)$ and $L_j(v) = L'_j(v)$;
 - $v' = v_K$ or $v' = v_{K-1}$. If $v' = v_{K-1}$ or $v' = v_K$ and $L'_j(v_K) \neq L_j(v_K)$, then by construction either t^j is a broadcast transition of some message $m \in \Sigma$ and $(L'_j(v'), ?m, L'_{j+1}(v')) \in \Delta$. Or $L'_{j+1}(v') = L'_j(v')$. If $v' = v_K$ and $L'_j(v_K) = L_j(v_K)$, then $L'_{j+1}(v_K) = L_{j+1}(v_K)$ by definition.

Furthermore, for all $v \notin \{v^j\} \cup N(v^j)$, either $v \in \{v_{K+2}, \dots, v_\ell\}$ and $L'_{j+1}(v) = L_{j+1}(v) = L_j(v) = L'_j(v)$, or $v \in \{v_1, \dots, v_{K-2}\}$ and $L'_{j+1}(v) = L'_j(v)$, or $v = v_{K-1}$ (if $v^j = v_{K+1}$), and $L'_{j+1}(v) = L'_j(v)$. This allows us to conclude (with Observation E.4) that $C'_j \xrightarrow{v^j, t^j} C'_{j+1}$ and so $P_1(j+1)$ holds. For $P_2(j+1)$, if $v^j = v_K$ and $L'_j(v_K) = L_j(v_K)$, then by construction $L'_{j+1}(v_K) = L_{j+1}(v_K)$ and so $P_2(j+1)$ trivially holds. If $v^j = v_{K+1}$, then either $L'_j(v_K) = L_j(v_K)$ and so by construction, $L'_{j+1}(v_K) = L_{j+1}(v_K)$, or $L'_j(v_K) \neq L_j(v_K)$ and so by induction hypothesis $L_j(v_K) \in Q_2^r$, and since P is 2-phase-bounded, $L_{j+1}(v_K) \in Q_2^r$.

- Assume that $v^j = v_K$ and $L'_j(v_K) \neq L_j(v_K)$. Then, by $P_2(j)$, $L_j(v_K) \in Q_2^r$. Hence, t is an internal transition (it cannot be a broadcast), and so $L_{j+1}(v) = L_j(v) = L'_j(v) = L'_{j+1}(v)$ for all $v \in \{v_{K+1}, \dots, v_\ell\}$, and $L'_{j+1}(v) = L'_j(v)$ for all $v \in \{v_1, \dots, v_{K-2}\}$, and $L'_{j+1}(v_{K-1}) = L'_j(v_{K-1})$ and $L'_{j+1}(v_K) = L'_j(v_K)$. As a consequence, $C'_{j+1} = C'_j$ and $P_1(j+1)$ holds. Furthermore, by induction hypothesis, $L_j(v_K) \in Q_2^r$ and so, as P is 2-phase-bounded, it holds that $L_{j+1}(v_K) \in Q_2^r$ and we have proved $P_2(j+1)$.
- Finally, assume that $v^j \in \{v_1, \dots, v_{K-1}\}$. Then, for all $v \in \{v_{K+1}, \dots, v_\ell\}$, $L_{j+1}(v) = L_j(v)$, and $L'_{j+1}(v) = L_{j+1}(v)$ and $L'_j(v) = L_j(v)$ by construction. For all $v^j \in \{v_1, \dots, v_{K-1}, v_K\}$, $L'_{j+1}(v) = L'_j(v)$ and so $C'_{j+1} = C'_j$ and $P_1(j)$ holds. Furthermore, either $L_j(v_K) = L_{j+1}(v_K)$ or $(L_j(v_K), ?m, L_{j+1}(v_K)) \in \Delta$ and $v^j = v_{K-1}$ and $t^j = (L_j(v_{K-1}), !!m, L_{j+1}(v_{K-1}))$. In the first case, by $P_2(j)$, either $L_j(v_K) = L'_j(v_K)$ and then $L_{j+1}(v_K) = L_j(v_K) = L'_j(v_K) = L'_{j+1}(v_K)$, or $L_j(v_K) = L_{j+1}(v_K) \in Q_2^r$ and so $P_2(j+1)$ holds. In the second case, $j > b_{\text{first}}(v_K, \rho_{K-1})$. Indeed, either $b_{\text{first}}(v_{K-1}, \rho_{K-1}) \leq b_{\text{first}}(v_K, \rho_{K-1})$ and then $j > j_1 > b_{\text{first}}(v_K, \rho_{K-1})$, or $j \geq b_{\text{first}}(v_{K-1}, \rho_{K-1}) > b_{\text{first}}(v_K, \rho_{K-1})$. By definition of a



2-phase-bounded protocol, $L_j(v_K) \in Q_1^b \cup Q_2^b \cup Q_2^r$ hence, $L_{j+1}(v_K) \in Q_2^r$ and so $P_2(j+1)$ holds.

Hence, $P_1(j)$ and $P_2(j)$ holds for all $j_1 + 1 \leq j \leq n$.

We build a sequence of configurations $C'_0 \rightarrow^* C'_1 \rightarrow^* C'_n$ by letting $C'_i = C_i$ for all $0 \leq i \leq j_1$. Let us show now that C'_0, \dots, C'_n that we have defined form the expected execution ρ_K .

- Let $v \in \{v_{K+1}, \dots, v_\ell\}$. By construction $L'_n(v) = L_n(v)$. By induction hypothesis (on K), $L_n(v) = L(v)$.
- Since $P_1(j)$ holds for all $j_1 + 1 \leq j \leq n$, $t_{\text{last}}(v_{K-1}, \rho_K) < j_1$ and, by definition of j_1 , it implies that $t_{\text{last}}(v_{K-1}, \rho_K) \leq b_{\text{first}}(v_K, \rho_K)$. Let $1 \leq i < K-1$. By induction hypothesis, $t_{\text{last}}(v_i, \rho_{K-1}) \leq b_{\text{first}}(v_{i+1}, \rho_{K-1})$. If $b_{\text{first}}(v_{K-1}, \rho_{K-1}) \leq b_{\text{first}}(v_K, \rho_{K-1})$, then $t_{\text{last}}(v_{K-2}, \rho_{K-1}) \leq b_{\text{first}}(v_{K-1}, \rho_{K-1}) \leq b_{\text{first}}(v_K, \rho_{K-1}) < j_1$. Thus, $t_{\text{last}}(v_{K-2}, \rho_K) = t_{\text{last}}(v_{K-2}, \rho_{K-1}) \leq b_{\text{first}}(v_{K-1}, \rho_{K-1}) = b_{\text{first}}(v_{K-1}, \rho_K)$. Since, for all $1 \leq i < K-2$, $b_{\text{first}}(v_{i+1}, \rho_{K-1}) \leq t_{\text{last}}(v_{i+1}, \rho_{K-1}) < j_1$, and by induction hypothesis, $t_{\text{last}}(v_i, \rho_{K-1}) \leq b_{\text{first}}(v_{i+1}, \rho_{K-1})$, we deduce that $t_{\text{last}}(v_i, \rho_K) = t_{\text{last}}(v_i, \rho_{K-1}) \leq b_{\text{first}}(v_{i+1}, \rho_{K-1}) = b_{\text{first}}(v_{i+1}, \rho_K)$. If now $b_{\text{first}}(v_{K-1}, \rho_{K-1}) > b_{\text{first}}(v_K, \rho_{K-1})$, then by $P_1(j)$, $t_{\text{last}}(v, \rho_K) = -1$, for all $v \in \{v_1, \dots, v_{K-1}\}$. Obviously then, for all $1 \leq i \leq K-1$, $t_{\text{last}}(v_i, \rho_K) \leq b_{\text{first}}(v_{i+1}, \rho_K)$.
- Let $K+1 \leq i \leq \ell$. Then, by $P_1(j)$, $t_{\text{last}}(v_i, \rho_K) \leq b_{\text{first}}(v_{i+1}, \rho_K)$ if and only if $t_{\text{last}}(v_i, \rho_{K-1}) \leq b_{\text{first}}(v_{i+1}, \rho_{K-1})$ if and only if, by induction hypothesis, $t_{\text{last}}(v_i, \rho) \leq b_{\text{first}}(v_{i+1}, \rho)$.

◀

By symmetry, we get the following lemma.

► **Lemma E.5.** *Let $\rho = C_0 \rightarrow^* C$ with $C = (\Gamma, L)$ and $1 < K \leq \ell$. There exists $\rho' = C_0 \rightarrow^* C'$ such that $C' = (\Gamma, L')$, and*

- for all $v \in \{v_1, \dots, v_{K-1}\}$, $L'(v) = L(v)$;
- for all $K+1 \leq i \leq \ell$, $t_{\text{last}}(v_i, \rho') \leq b_{\text{first}}(v_{i-1}, \rho')$;
- for all $1 \leq i \leq K$, $t_{\text{last}}(v_i, \rho') \leq b_{\text{first}}(v_{i-1}, \rho')$ if and only if $t_{\text{last}}(v_i, \rho) \leq b_{\text{first}}(v_{i-1}, \rho)$.

We are now ready to prove Lemma E.2.

Proof of Lemma E.2. From $\rho = C_0 \rightarrow^* C$ with $C = (\Gamma, L)$ we apply Lemma E.3 for $K = N-1$ and we get an execution $\rho' = C'_0 \rightarrow^* C'$ such that $C' = (\Gamma, L')$ and

- for all $v \in \{v_N, \dots, v_\ell\}$, $L'(v) = L(v)$;
- for all $1 \leq i \leq N-2$, $t_{\text{last}}(v_i, \rho') \leq b_{\text{first}}(v_{i+1}, \rho')$;
- for all $N-1 \leq i \leq \ell$, $t_{\text{last}}(v_i, \rho') \leq b_{\text{first}}(v_{i+1}, \rho')$ if and only if $t_{\text{last}}(v_i, \rho) \leq b_{\text{first}}(v_{i+1}, \rho)$.

Next, from ρ' , we apply Lemma E.5 for $K = N+1$ and we get an execution $\rho'' = C''_0 \rightarrow^* C''$ such that $C'' = (\Gamma, L'')$ and

- for all $v \in \{v_1, \dots, v_N\}$, $L''(v) = L'(v)$;
- for all $N+2 \leq i \leq \ell$, $t_{\text{last}}(v_i, \rho'') \leq b_{\text{first}}(v_{i-1}, \rho'')$;
- for all $1 \leq i \leq N+1$, $t_{\text{last}}(v_i, \rho'') \leq b_{\text{first}}(v_{i-1}, \rho'')$ if and only if $t_{\text{last}}(v_i, \rho') \leq b_{\text{first}}(v_{i-1}, \rho')$.

Hence, ρ'' covers q_f as $L''(v_N) = L'(v_N) = L(v_N) = q_f$ and

- for all $N+2 \leq i \leq \ell$, $t_{\text{last}}(v_i, \rho'') \leq b_{\text{first}}(v_{i-1}, \rho'')$;
- for all $1 \leq i \leq N-2$, $t_{\text{last}}(v_i, \rho'') \leq b_{\text{first}}(v_{i+1}, \rho'')$.

□

E.2.1.2 Proof of Lemma 6.4

We are now ready to prove Lemma 6.4. We begin with three observations that hold regardless of whether P is 2-phase-bounded or not. In a line $\Gamma = (V, E)$ with $V = \{v_1, \dots, v_\ell\}$ and $E = \{\{v_i, v_{i+1}\} \mid 1 \leq i < \ell\}$, we define the distance between two nodes v_i, v_j as $d(v_i, v_j) = |j - i|$.

► **Observation E.6.** *Let $C, C' \in \mathcal{C}$, and $u, v \in V(\Gamma)$ such that $d(v, u) \geq 3$. If $C \xrightarrow{u, t} C_1 \xrightarrow{v, t'} C'$ for two transitions $t, t' \in \Delta$ and a configuration $C_1 \in \mathcal{C}$, then there exists $C_2 \in \mathcal{C}$ such that $C \xrightarrow{v, t'} C_2 \xrightarrow{u, t} C'$.*

► **Observation E.7.** *Let $C, C' \in \mathcal{C}$, and $u, v \in V(\Gamma)$ such that $d(u, v) \geq 2$. Then if $C \xrightarrow{u, t} C_1 \xrightarrow{v, t'} C'$ for two transitions $t, t' \in \Delta$ with one of the two transitions internal and a configuration $C_1 \in \mathcal{C}$, then there exists $C_2 \in \mathcal{C}$ such that $C \xrightarrow{v, t'} C_2 \xrightarrow{u, t} C'$.*

► **Observation E.8.** *Let $C, C' \in \mathcal{C}$, and $u, v \in V(\Gamma)$. Then if $C \xrightarrow{u, t} C_1 \xrightarrow{v, t'} C'$ for two internal transitions $t, t' \in \Delta$ and a configuration $C_1 \in \mathcal{C}$, then there exists $C_2 \in \mathcal{C}$ such that $C \xrightarrow{v, t'} C_2 \xrightarrow{u, t} C'$.*

For the rest of this proof we let $\rho = C_0 \xrightarrow{v^0, t^0} C_1 \xrightarrow{v^1, t^1} \dots \xrightarrow{v^{n-1}, t^{n-1}} C_n$ be the execution obtained from Lemma E.2. We define $j_1 := t_{\text{last}}(v_{N-3}, \rho) + 1$ and $j_2 = t_{\text{last}}(v_{N+3}, \rho) + 1$.

► **Lemma E.9.** *Let $0 \leq j < j_1$ be the maximal index such that $C_j \xrightarrow{v^j, t^j} C_{j+1}$, for some $v^j \in \{v_{N-1}, v_N, \dots, v_\ell\}$ then, $C_0 \rightarrow^* C_j \xrightarrow{v^{j+1}, t^{j+1}} C'_{j+1} \rightarrow^* C'_{j_1-2} \xrightarrow{v_{N-3}, t^{j_1}} C'_{j_1-1} \xrightarrow{v^j, t^j} C_{j_1}$.*

Proof. Let $0 \leq j < j_1$ be the maximal index such that $C_j \xrightarrow{v^j, t^j} C_{j+1}$ for some $v \in \{v_{N-1}, v_N, \dots, v_\ell\}$.

Recall that $j_1 = t_{\text{last}}(v_{N-3}, \rho) + 1$, and recall that $t_{\text{last}}(v_{N-3}, \rho) \leq b_{\text{first}}(v_{N-2}, \rho)$, hence either $b_{\text{first}}(v_{N-2}, \rho) = -1$ and so it never broadcast anything, either $j_1 \leq b_{\text{first}}(v_{N-2}, \rho)$. In both cases, v_{N-2} does not broadcast anything between C_0 and C_{j_1} .

As j is maximal, for all $j < k < j_1$, $v^k \in \{v_1, \dots, v_{N-2}\}$ and if $v^k = v_{N-2}$, t^k is internal. We prove by induction that for all $j \leq k < j_1$:

$P(k)$: there exists C'_{j+1}, \dots, C'_k such that $C_j \xrightarrow{v^{j+1}, t^{j+1}} C'_{j+1} \rightarrow \dots \xrightarrow{v^k, t^k} C'_k \xrightarrow{v^j, t^j} C_{k+1}$.

For $k = j$, the induction property trivially holds.

Let $j \leq k < j_1 - 1$ such that $C_j \xrightarrow{v^{j+1}, t^{j+1}} C'_{j+1} \dots \xrightarrow{v^k, t^k} C'_k \xrightarrow{v^j, t^j} C_{k+1}$. Let $C_{k+1} \xrightarrow{v^{k+1}, t^{k+1}} C_{k+2}$.

First case: $v^j = v_{N-1}$. Then, since $j \leq k + 1 \leq j_1 - 1 = t_{\text{last}}(v_{N-3}, \rho) \leq b_{\text{first}}(v_{N-2}, \rho) \leq t_{\text{last}}(v_{N-2}, \rho) \leq b_{\text{first}}(v_{N-1}, \rho)$, by Lemma E.2, t^j cannot be a broadcast and is thus an internal transition. If $v^{k+1} \in \{v_1, \dots, v_{N-3}\}$, then $d(v_{N-1}, v^{k+1}) \geq 2$ and we apply Observation E.7, to get that there exists C'_{k+1} such that $C'_k \xrightarrow{v^{k+1}, t^{k+1}} C'_{k+1} \xrightarrow{v^j, t^j} C_{k+2}$. If $v^{k+1} = v_{N-2}$, then t^{k+1} is internal and we can hence apply Observation E.8 to get that there exists C'_{k+1} such that $C'_k \xrightarrow{v^{k+1}, t^{k+1}} C'_{k+1} \xrightarrow{v^j, t^j} C_{k+2}$.

Second case: $v^j = v_N$. Then, if $v^{k+1} \in \{v_1, \dots, v_{N-3}\}$ and so $d(v_N, v^{k+1}) \geq 3$: We can apply Observation E.6 to get that there exists C'_{k+1} such that $C'_k \xrightarrow{v^{k+1}, t^{k+1}} C'_{k+1} \xrightarrow{v^j, t^j} C_{k+2}$. Otherwise, $v^{k+1} = v_{N-2}$ and t^{k+1} is internal and $d(v_N, v_{N-2}) = 2$ and so we can apply Observation E.7 to get that there exists C'_{k+1} such that $C'_k \xrightarrow{v^{k+1}, t^{k+1}} C'_{k+1} \xrightarrow{v^j, t^j} C_{k+2}$.

Third case: $v^j \in \{v_{N+1}, \dots, v_\ell\}$. Then $d(v^j, v^{k+1}) \geq 3$ and so we can apply Observation E.6 to get that there exists C'_{k+1} such that $C'_k \xrightarrow{v^{k+1}, t^{k+1}} C'_{k+1} \xrightarrow{v^j, t^j} C_{k+2}$. ◀

► **Lemma E.10.** *Let $j_1 \leq j < j_2$ the maximal index such that $C_j \xrightarrow{v^j, t^j} C_{j+1}$, for some $v^j \in \{v_{N-2}, v_{N-1}, v_N, v_{N+1}\}$, then, $C_{j_1} \rightarrow^* C_j \xrightarrow{v^{j+1}, t^{j+1}} C'_{j+1} \xrightarrow{v^{j+2}, t^{j+2}} \dots \rightarrow C'_{j_2-2} \xrightarrow{v_{N+3}, t^{j_2}} C'_{j_2-1} \xrightarrow{v^j, t^j} C_{j_2}$.*

Proof. Let $j_1 \leq j < j_2$ be the maximal index such that $C_j \xrightarrow{v^j, t^j} C_{j+1}$ for some $v \in \{v_{N-2}, v_{N-1}, v_N, v_{N+1}\}$.

Recall that $j_1 = t_{\text{last}}(v_{N-3}, \rho) + 1$, and that $t_{\text{last}}(v_{N-3}, \rho) \geq b_{\text{first}}(v_{N-3}, \rho) \geq t_{\text{last}}(v_{N-4}, \rho)$, and so by a simple inductive reasoning: $j_1 > t_{\text{last}}(v, \rho)$ for all $v \in \{v_1, \dots, v_{N-3}\}$. Hence, for all $j_1 \leq k < j_2$, $v^k \notin \{v_1, \dots, v_{N-3}\}$.

Hence, as j is maximal, for all $j < k < j_1$, $v^k \in \{v_{N+2}, \dots, v_\ell\}$. We prove by induction that for all $j \leq k < j_2$, there exist C'_{j+1}, \dots, C'_k such that $C_j \xrightarrow{v^{j+1}, t^{j+1}} C'_{j+1} \rightarrow \dots \rightarrow C'_k \xrightarrow{v^j, t^j} C_{k+1}$. For $k = j$, the induction property trivially holds. Let $j \leq k < j_2 - 1$ such that there exist C'_{j+1}, \dots, C'_k with $C_j \xrightarrow{v^{j+1}, t^{j+1}} C'_{j+1} \rightarrow \dots \rightarrow C'_k \xrightarrow{v^j, t^j} C_{k+1}$. Denote $C_{k+1} \xrightarrow{v^{k+1}, t^{k+1}} C_{k+2}$.

First case: $v^j = v_{N+1}$. Then, $t_{\text{last}}(v_{N+2}, \rho) \leq b_{\text{first}}(v_{N+1}, \rho)$ by Lemma E.2, and $t_{\text{last}}(v_{N+3}, \rho) \leq b_{\text{first}}(v_{N+2}, \rho) \leq t_{\text{last}}(v_{N+2}, \rho)$. Since $k + 1 \leq j_2 - 1 = t_{\text{last}}(v_{N+3}, \rho)$, $k + 1 \leq t_{\text{last}}(v_{N+3}, \rho) \leq b_{\text{first}}(v_{N+1}, \rho)$, and so, t^j cannot be a broadcast, and is an internal transition. If $v^{k+1} \in \{v_{N+3}, \dots, v_\ell\}$ then $d(v_{N+1}, v^{k+1}) \geq 2$ and we can apply Observation E.7 to get that there exists C'_{k+1} such that $C'_k \xrightarrow{v^{k+1}, t^{k+1}} C'_{k+1} \xrightarrow{v^j, t^j} C_{k+2}$. Otherwise, $v^{k+1} = v_{N+2}$. Recall that $j_2 = t_{\text{last}}(v_{N+3}, \rho) + 1$ and that $k + 1 \leq t_{\text{last}}(v_{N+3}, \rho) \leq b_{\text{first}}(v_{N+2}, \rho)$, hence t^{k+1} is an internal transition. Hence we can apply Observation E.8 to get that there exists C'_{k+1} such that $C'_k \xrightarrow{v^{k+1}, t^{k+1}} C'_{k+1} \xrightarrow{v^j, t^j} C_{k+2}$.

Second case: $v^j = v_N$. Then, if $v^{k+1} \in \{v_{N+3}, \dots, v_\ell\}$ and so $d(v_N, v^{k+1}) \geq 3$, we can apply Observation E.6 to get that there exists C'_{k+1} such that $C'_k \xrightarrow{v^{k+1}, t^{k+1}} C'_{k+1} \xrightarrow{v^j, t^j} C_{k+2}$. Otherwise, $v^{k+1} = v_{N+2}$ and t^{k+1} is internal and $d(v_N, v_{N+2}) = 2$ and so we can apply Observation E.7 to get that there exists C'_{k+1} such that $C'_k \xrightarrow{v^{k+1}, t^{k+1}} C'_{k+1} \xrightarrow{v^j, t^j} C_{k+2}$.

Third case: $v^j \in \{v_{N-2}, v_{N-1}\}$. Then $d(v^j, v^{k+1}) \geq 3$ and so we can apply Observation E.6 to get that there exists C'_{k+1} such that $C'_k \xrightarrow{v^{k+1}, t^{k+1}} C'_{k+1} \xrightarrow{v^j, t^j} C_{k+2}$. ◀

We are now ready to prove Lemma 6.4.

Proof of Lemma 6.4. Let $j_1(\rho) := t_{\text{last}}(v_{N-3}, \rho) + 1$ and $j_2(\rho) = t_{\text{last}}(v_{N+3}, \rho) + 1$. We let i_1, \dots, i_k the indices $0 \leq i_1 < \dots < i_k < j_1(\rho)$ such that $C_{i_j} \xrightarrow{v, t_j} C_{i_j+1}$ for some $v \in \{v_{N-1}, \dots, v_\ell\}$ and $t_j \in \Delta$. We denote $\text{EarlyActions}[\rho]$ the number of such indices.

We build inductively $\rho_0, \rho_1, \dots, \rho_k$ such that for all j , $\rho_j = C_0 \rightarrow^* C^j = (\Gamma, L^j)$ with:

- $P_1(j)$: $L^j(v_N) = q_f$, and
- $P_2(j)$: $\text{EarlyActions}[\rho_j] = k - j$, and
- $P_3(j)$: the order of Lemma E.2 is preserved, i.e. for all $1 \leq i \leq N - 2$, $t_{\text{last}}(v_i, \rho_j) \leq b_{\text{first}}(v_{i+1}, \rho_j)$ and for all $N + 2 \leq i \leq \ell$, $t_{\text{last}}(v_i, \rho_j) \leq b_{\text{first}}(v_{i-1}, \rho_j)$.

For $j = 0$, define $\rho_0 = \rho$. It trivially satisfies the induction properties.

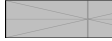

Let $0 \leq j < k$ and assume we have built ρ_j satisfying $P_1(j)$, $P_2(j)$ and $P_3(j)$ and denote it $\rho_j = C_0^j \xrightarrow{v^0, t^0} C_1^j \xrightarrow{v^1, t^1} \dots \xrightarrow{v^{n-1}, t^{n-1}} C_n^j = (\Gamma, L_n^j)$. Let i be the maximal index such that $i < j_1(\rho_j)$ and $C_i \xrightarrow{v^i, t^i} C_{i+1}$ for some $v^i \in \{v_{N-1}, \dots, v_\ell\}$ and $t \in \Delta$. From Lemma E.9, there exists $C'_{i+1}, \dots, C'_{j_1(\rho_j)-1}$ such that $C_0^j \xrightarrow{*} C_i^j \xrightarrow{v^{i+1}, t^{i+1}} C'_{i+1} \xrightarrow{v^{i+2}, t^{i+2}} \dots \rightarrow C'_{j_1(\rho_j)-1} \xrightarrow{v^i, t^i} C_{j_1(\rho_j)}^j$, hence we define $\rho_{j+1} = C_0^j \xrightarrow{*} C_i^j \xrightarrow{v^{i+1}, t^{i+1}} C'_{i+1} \xrightarrow{*} C'_{j_1(\rho_j)-1} \xrightarrow{v^i, t^i} C_{j_1(\rho_j)}^j \xrightarrow{*} C_n$. By construction $P_1(j+1)$ holds. Furthermore, $j_1(\rho_{j+1}) = t_{\text{last}}(v_{N-3}, \rho_{j+1}) + 1 = j_1(\rho_j) - 1$ and so $\text{EarlyActions}[\rho_{j+1}] = \text{EarlyActions}[\rho_j] - 1 = k - j - 1$ and so $P_2(j+1)$ holds.

We denote $v^i = v_r$. Recall that $v_r \in \{v_{N-1}, \dots, v_\ell\}$. Observe that for all $1 \leq k \leq \ell$, it holds that:

- if $k < \ell$ and $k \notin \{r-1, r\}$, then $t_{\text{last}}(v_k, \rho_{j+1}) \leq b_{\text{first}}(v_{k+1}, \rho_{j+1})$ if and only if $t_{\text{last}}(v_k, \rho_j) \leq b_{\text{first}}(v_{k+1}, \rho_j)$;
- if $k > 0$ and $k \notin \{r, r+1\}$, then $t_{\text{last}}(v_k, \rho_{j+1}) \leq b_{\text{first}}(v_{k-1}, \rho_{j+1})$ if and only if $t_{\text{last}}(v_k, \rho_j) \leq b_{\text{first}}(v_{k-1}, \rho_j)$.

Hence, by $P_3(j)$, for all $1 \leq k \leq N-2$, if $k \notin \{r-1, r\}$ $t_{\text{last}}(v_k, \rho_{j+1}) \leq b_{\text{first}}(v_{k+1}, \rho_{j+1})$ and for all $N+2 \leq k \leq \ell$, if $k \notin \{r, r+1\}$, $t_{\text{last}}(v_k, \rho_j) \leq b_{\text{first}}(v_{k-1}, \rho_j)$.

Let now $1 \leq k \leq N-2$, such that $k \in \{r-1, r\}$. As $N-1 \leq r \leq \ell$, $k = N-2$ and $r = N-1$. As $j_1(\rho_j) > i \geq 0$, from $P_3(j)$, we get that $j_1(\rho_j) - 1 = b_{\text{first}}(v_{N-3}, \rho_j) \leq t_{\text{last}}(v_{N-3}, \rho_j) < b_{\text{first}}(v_{r-1}, \rho_j) \leq t_{\text{last}}(v_{r-1}, \rho_j) < b_{\text{first}}(v_r, \rho_j)$. Hence $t_{\text{last}}(v_{r-1}, \rho_{j+1}) = t_{\text{last}}(v_{r-1}, \rho_j)$, and $b_{\text{first}}(v_r, \rho_{j+1}) = b_{\text{first}}(v_r, \rho_j)$.

Let now $N+2 \leq k \leq \ell$, such that $k \in \{r, r+1\}$, hence, $N+1 \leq r \leq \ell$. If $k = r$, then notice that either $t_{\text{last}}(v_r, \rho_j) > i$ or $t_{\text{last}}(v_r, \rho_j) = i$. In the first case, as for all $i < i_2 < j_1(\rho_j)$, $v^{i_2} \notin \{v_{N+1}, \dots, v_\ell\}$, it holds that $t_{\text{last}}(v_r, \rho_j) > j_1(\rho_{j+1})$, and so $t_{\text{last}}(v_r, \rho_{j+1}) = t_{\text{last}}(v_r, \rho_j)$, and, from $P_3(j)$, $j_1(\rho_j) \leq t_{\text{last}}(v_r, \rho_{j+1}) \leq b_{\text{first}}(v_{r-1}, \rho_j) = b_{\text{first}}(v_{r-1}, \rho_{j+1})$. If $t_{\text{last}}(v_r, \rho_j) = i$, then $t_{\text{last}}(v_r, \rho_{j+1}) = j_1(\rho_j) - 1$. As for all $i < i_2 < j_1(\rho_j)$, $v^{i_2} \notin \{v_{N+1}, \dots, v_\ell\}$, it holds that $t_{\text{last}}(v_r, \rho_j) \leq j_1(\rho_j) - 1 \leq b_{\text{first}}(v_{r-1}, \rho_j) = b_{\text{first}}(v_{r-1}, \rho_{j+1})$. Hence, $t_{\text{last}}(v_r, \rho_{j+1}) \leq b_{\text{first}}(v_{r-1}, \rho_{j+1})$.

If $k = r+1$, then, as for all $i < i_2 < j_1(\rho_j)$, $v^{i_2} \notin \{v_{N+1}, \dots, v_\ell\}$, it holds that $t_{\text{last}}(v_k, \rho_{j+1}) = t_{\text{last}}(v_k, \rho_j)$ and if t^i is internal, $b_{\text{first}}(v_r, \rho_{j+1}) = b_{\text{first}}(v_r, \rho_j)$. Otherwise, $b_{\text{first}}(v_r, \rho_j) \leq b_{\text{first}}(v_r, \rho_{j+1})$. From $P_3(j)$, it holds that $t_{\text{last}}(v_k, \rho_{j+1}) = t_{\text{last}}(v_k, \rho_j) \leq b_{\text{first}}(v_{k-1}, \rho_j) \leq b_{\text{first}}(v_{k-1}, \rho_{j+1})$. Hence $P_3(j+1)$ holds.

Hence, we build ρ_k such that $\rho_k = C_0^k \xrightarrow{*} C'_{j_1(\rho_k)} \xrightarrow{*} C_n^k$ and $P_1(k)$, $P_2(k)$ and $P_3(k)$ hold.

With the same reasoning between C_{j_1} and C_{j_2} , and applying this time Lemma E.10, we finally get an execution $\rho' = C_0' \xrightarrow{*} C'_{j_1(\rho')} \xrightarrow{*} C'_{j_2(\rho')} \xrightarrow{*} C_n'$ such that:

- for all $1 \leq i \leq N-2$, $t_{\text{last}}(v_i, \rho') \leq b_{\text{first}}(v_{i+1}, \rho')$;
- for all $N+2 \leq i \leq \ell$, $t_{\text{last}}(v_i, \rho') \leq b_{\text{first}}(v_{i-1}, \rho')$;
- nodes issuing transitions between C_0' and $C'_{j_1(\rho')}$ belong to $\{v_1, \dots, v_{N-3}, v_{N-2}\}$ and v_{N-2} only performs internal transitions (because $j_1(\rho') = t_{\text{last}}(v_{N-3}, \rho') + 1 \leq b_{\text{first}}(v_{N-2}, \rho')$);
- nodes issuing transitions between $C'_{j_1(\rho')}$ and $C'_{j_2(\rho')}$ belong to $\{v_{N+2}, v_{N+3}, \dots, v_\ell\}$ and v_{N+2} only performs internal transitions;

It is left to prove that in $C'_{j_2(\rho')} \xrightarrow{*} C_n'$, only nodes in $\{v_{N-2}, v_{N-1}, v_N, v_{N+1}, v_{N+2}\}$ issue transitions. Assume a node $v \notin \{v_{N-2}, v_{N-1}, v_N, v_{N+1}, v_{N+2}\}$ issues a transition between $C'_{j_2(\rho')}$ and C_n' , hence by definition, $t_{\text{last}}(v, \rho') \geq j_2(\rho')$. Either $v \in \{v_1, \dots, v_{N-3}\}$ and so $t_{\text{last}}(v, \rho') \leq t_{\text{last}}(v_{N-3}, \rho') < j_1(\rho') < j_2(\rho')$ and we reach a contradiction. Or $v \in \{v_{N+3}, \dots, v_\ell\}$

and so $t_{\text{last}}(v, \rho') \leq t_{\text{last}}(v_{N+3}, \rho') < j_2(\rho')$ and we reach a contradiction. \square

E.2.2 Completeness of the algorithm

This part is dedicated to prove the following lemma.

► **Lemma E.11.** *If q_f is coverable with a line topology, then there exist $q_1, q_2 \in H$ such that $C_{q_1, q_2} \xrightarrow{*} C$ and $C = (\Gamma_5, L)$ with $L(v_3) = q_f$.*

If q_f is coverable, then let $\rho = C_0 \xrightarrow{*} C_{j_1} \xrightarrow{*} C_{j_2} \xrightarrow{*} C_n$ be the execution obtained from Lemma 6.4 with $j_1 = b_{\text{first}}(v_{N-3}, \rho) + 1$ and $j_2 = b_{\text{first}}(v_{N+3}, \rho) + 1$. We denote $C_i = (\Gamma, L_i)$ for all $0 \leq i \leq n$.

We start by proving that $L_{j_1}(v_{N-2}) \in H$ and $L_{j_2}(v_{N+2}) \in H$. We need three preliminaries lemmas.

► **Lemma E.12.** *For all $0 \leq j \leq b_{\text{first}}(v_1, \rho)$, $(L_j(v_1), q_{in}) \in S$.*

Proof. We prove the lemma by induction on j . For $j = 0$, $L_0(v_1) = q_{in}$ and by construction $(q_{in}, q_{in}) \in S$. Let $0 \leq j < b_{\text{first}}(v_1, \rho)$ such that $(L_j(v_1), q_{in}) \in S$. Denote $C_j \xrightarrow{v^j, t^j} C_{j+1}$. Observe that either $L_j(v_1) = L_{j+1}(v_1)$ (and there is nothing to do), or $v^j \in \{v_1, v_2\}$. As $j < b_{\text{first}}(v_1, \rho)$, from Item 1 of Lemma 6.4, it holds that $j < b_{\text{first}}(v_1, \rho) \leq b_{\text{first}}(v_2, \rho)$. Hence t^j is internal and if $v^j = v_2$, $L_j(v_1) = L_{j+1}(v_1)$. Otherwise, $v^j = v_1$ and $(L_j(v_1), q_{in}) \in S$. Hence, $(L_{j+1}(v_1), q_{in}) \in S$ by definition of S . \blacktriangleleft

We adopt the convention that $L_{-1}(v) = q_{in}$ for all v . We prove the following lemma by induction on k .

► **Lemma E.13.** *For all $1 < k \leq N - 2$, if $L_{b_{\text{first}}(v_{k-1}, \rho)}(v_{k-1}) \in H$, then $L_j(v_k) \in H$ for all $b_{\text{first}}(v_{k-1}, \rho) \leq j \leq b_{\text{first}}(v_k, \rho)$.*

Proof. Let $1 < k \leq N - 2$ such that $L_{b_{\text{first}}(v_{k-1}, \rho)}(v_{k-1}) \in H$, we prove the lemma by induction. For ease of readability, denote $j^{k-1} = b_{\text{first}}(v_{k-1}, \rho)$ and $j^k = b_{\text{first}}(v_k, \rho)$. By definition of H , there exists $q \in Q$ such that $(L_{j^{k-1}}(v_{k-1}), q) \in S$.

First let us show that for all $0 \leq j \leq j^{k-1}$, $(L_j(v_k), L_{j^{k-1}}(v_{k-1})) \in S$: for $j = 0$, as $(L_{j^{k-1}}(v_{k-1}), q) \in S$, by definition of S , $(q_{in}, L_{j^{k-1}}(v_{k-1})) \in S$. Let now $0 \leq j < j^{k-1}$ and denote $C_j \xrightarrow{v^j, t^j} C_{j+1}$. Recall that in ρ , as $j < j^{k-1} \leq j_1$, it holds that $v^j \in \{v_1, \dots, v_{N-2}\}$ (Item 1 of Lemma 6.4). Furthermore, as $j < j^{k-1}$, then $j < b_{\text{first}}(v, \rho)$ for all $v \in \{v_{k-1}, \dots, v_{N-2}\}$ (Item 2 of Lemma 6.4). Hence, either t^j is an internal transition, or $v^j \in \{v_1, \dots, v_{k-2}\}$. In the latter case, $L_{j+1}(v_k) = L_j(v_k)$. Otherwise, either $v^j \neq v_k$ and so $L_{j+1}(v_k) = L_j(v_k)$ and there is nothing to do, or $v^j = v_k$ and so $(L_j(v_k), \tau, L_{j+1}(v_k)) \in \Delta$ and so, as $(L_j(v_k), L_{j^{k-1}}(v_{k-1})) \in S$, $(L_{j+1}(v_k), L_{j^{k-1}}(v_{k-1})) \in S$ by definition of S .

Hence $(L_{j^{k-1}}(v_k), L_{j^{k-1}}(v_{k-1})) \in S$. We now prove that for all $j^{k-1} \leq j \leq j^k$, $(L_j(v_k), L_j(v_{k+1})) \in S$. As we just proved it for $j = j^{k-1}$, let $j^{k-1} \leq j < j^k$, and denote $C_j \xrightarrow{v^j, t^j} C_{j+1}$. Note that from Lemma 6.4, we get that (a) $v^j \in \{v_1, \dots, v_{N-2}\}$ as $j < b_{\text{first}}(v_k, \rho) \leq j_1$; (b) as $j \geq j^{k-1}$, it holds that $j \geq t_{\text{last}}(v, \rho)$ for all $v \in \{v_1, \dots, v_{k-2}\}$, hence $v^j \notin \{v_1, \dots, v_{k-2}\}$; and (c) if $v^j \in \{v_k, \dots, v_{N-2}\}$, then t^j is an internal transition as $j < b_{\text{first}}(v_k, \rho) \leq b_{\text{first}}(v, \rho)$ for all $v \in \{v_k, \dots, v_{N-2}\}$.

Overall, we get that either $v^j = v_{k-1}$, or $v^j \in \{v_k, \dots, v_{N-2}\}$ and t^j is internal. In the first case, all cases (t^j is an internal transition, t^j is a broadcast transition and the message is

received by v_k , or t^j is a broadcast transition and the message is not received by v_k) are covered by our definition of S . In the latter case, either $v^j \neq v_k$ and v_k and v_{k-1} remain on the same states, or $v^j = v_k$ and this case is covered by our definition of S (t^j is internal). \blacktriangleleft

Hence, as $L_{b_{\text{first}}(v_1, \rho)}(v_1) \in H$ from Lemma E.12, by applying inductively Lemma E.13, we get that $L_j(v_{N-2}) \in H$ for all $b_{\text{first}}(v_{N-3}, \rho) \leq j \leq b_{\text{first}}(v_{N-2}, \rho)$. As $j_1 = b_{\text{first}}(v_{N-3}, \rho) + 1$, then $L_{j_1}(v_{N-2}) \in H$.

With a similar reasoning on v_{N+2} and between C_{j_1} and C_{j_2} , we get the following lemma.

► **Lemma E.14.** $L_{j_1}(v_{N-2}) \in H$ and $L_{j_2}(v_{N+2}) \in H$.

Denote $q_1 = L_{j_1}(v_{N-2})$ and $q_2 = L_{j_2}(v_{N+2})$. Denote $C_{j_2} \xrightarrow{v^{j_2}, t^{j_2}} C_{j_2+1} \xrightarrow{v^{j_2+1}, t^{j_2+1}} \dots \xrightarrow{v^{n-1}, t^{n-1}} C_n$. Recall that from Item 1 of Lemma 6.4, $v^{j_2}, \dots, v^{n-1} \in \{v_{N-2}, v_{N-1}, v_N, v_{N+1}, v_{N+2}\}$. Denote $C_{q_1, q_2} = (\Gamma_5, L_{q_1, q_2})$, and observe that $L_{q_1, q_2}(v_i) = L_{j_2}(v_{N-3+i})$ for all $1 \leq i \leq 5$. Hence, $C_{q_1, q_2} = C'_0 \xrightarrow{v_2^0, t_2^0} C'_1 \xrightarrow{v_2^1, t_2^1} \dots \xrightarrow{v_2^{n-j_2-1}, t_2^{n-j_2-1}} C'_{n-j_2}$ where for all $0 \leq j < n - j_2$: $C'_j = (\Gamma_5, L'_j)$ and $L'_j(v_i) = L_{j_2+j}(v_{N-3+i})$ for all $1 \leq i \leq 5$. And for all $0 \leq j < n - j_2$: $t_2^j = t^{j_2+j}$ and if $v^{j_2+j} = v_{N-3+i}$ for some $1 \leq i \leq 5$, then $v_2^j = v_i$. Hence, $C_{q_1, q_2} \rightarrow^* C'_{n-j_2}$ with $L'_{n-j_2}(v_3) = L_n(v_N) = q_f$. This concludes the proof of Lemma E.11.

E.2.3 Correctness of the algorithm

This part is devoted to prove the following lemma.

► **Lemma E.15.** *If there exist $q_1, q_2 \in H$, $v \in V(\Gamma_5)$, such that $C_{q_1, q_2} \rightarrow^* C$ and $C = (\Gamma_5, L)$ with $L(v) = q_f$, then there exist $\Gamma \in \text{Lines}$, $C_0 \in \mathcal{I}$, $C' = (\Gamma, L') \in \mathcal{C}$ such that $C_0 \rightarrow^* C'$ and $L'(v) = q_f$.*

We start by proving the following lemma.

► **Lemma E.16.** *For all $q \in H$, there exists $k \in \mathbb{N}$ such that q is coverable with a line topology $\Gamma = (\{v_1, \dots, v_k\}, \{\{v_i, v_{i+1}\} \mid 1 \leq i < k\})$ and vertex v_1 .*

Proof. We will in fact prove that for all $(q_1, q_2) \in S$, there exists $\Gamma_{q_1, q_2} \in \text{Lines}$ such that $V(\Gamma_{q_1, q_2}) = \{v_1, \dots, v_k\}$, $E(\Gamma_{q_1, q_2}) = \{\{v_i, v_{i+1}\} \mid 1 \leq i < k\}$ for some $k \in \mathbb{N}$ with $k \geq 2$ and there exists $C_0 \in \mathcal{I}$, $C = (\Gamma_{q_1, q_2}, L)$ with $C_0 \rightarrow^* C$ and $L(v_1) = q_1$ and $L(v_2) = q_2$.

Denote S_0, \dots, S_K the subsets defined by the algorithm to build S . We have that $S = S_N$. We prove the property to be true for all $(q_1, q_2) \in S_i$ by induction on $0 \leq i \leq N$. For $i = 0$, $S_0 = \{(q_{in}, q_{in})\}$, this is trivial: define $\Gamma_{q_{in}, q_{in}} = (\{v_1, v_2\}, \{\{v_1, v_2\}\})$ and take the initial configuration $C = (\Gamma_{q_{in}, q_{in}}, L_0)$ with $L_0(v_1) = L_0(v_2) = q_{in}$. Let $0 \leq i < K$, and assume we proved the property to be true for all $(q_1, q_2) \in S_i$. Let $(q_1, q_2) \in S_{i+1} \in S_i$.

- if there exists $(q_1, p_2) \in S_i$ such that $(p_2, \tau, q_2) \in \Delta$, let $\Gamma_{q_1, p_2} \in \text{Lines}$, and C_0 and $C = (\Gamma_{q_1, p_2}, L)$ obtained from the induction hypothesis such that $C_0 \rightarrow^* C$ and $L(v_1) = q_1$ and $L(v_2) = p_2$. Then, $C \xrightarrow{v_2, (p_2, \tau, q_2)} C'$ and $C' = (\Gamma_{q_1, p_2}, L')$ with $L'(v_1) = q_1$ and $L'(v_2) = q_2$;
- if there exists $(p_1, q_2) \in S_i$ such that $(p_1, \tau, q_1) \in \Delta$, the reasoning is the same as in the previous case;
- if there exists $(p_1, p_2) \in S_i$ and $m \in \Sigma$ such that $(p_1, ?m, q_1) \in \Delta$ and $(p_2, !!m, q_2) \in \Delta$, we use a similar reasoning as in the previous cases;

- if there exists $(q_1, p_2) \in S_i$ and $m \in \Sigma$ such that $(p_2, !!m, q_2) \in \Delta$ and $m \notin R(q_1)$, we use a similar reasoning as in the previous cases;
- if there exists q_3 such that $(q_2, q_3) \in S_i$ and $q_1 = q_{in}$, then let Γ_{q_2, q_3} , C_0 and $C = (\Gamma_{q_2, q_3}, L)$ obtained from the induction hypothesis such that $C_0 \rightarrow^* C$ and $L(v_1) = q_2$ and $L(v_2) = q_3$. Define $\Gamma_{q_1, q_2} = (\{v'_1\} \cup \mathbf{V}(\Gamma_{q_2, q_3}), \{\{v'_1, v_1\}\} \cup \mathbf{E}(\Gamma_{q_2, q_3}))$. Denote $C_0 \xrightarrow{v^0, t^0} \dots \xrightarrow{v^{n-1}, t^{n-1}} C_n = C$. Recall that as $L_n(v_1) \in H$, $L_n(v_1) \in Q_0 \cup Q_1^r$, hence for all $0 \leq i \leq n-1$, if $v^i = v_1$ then t^i is internal. Hence, there exists $C'_0 \dots C'_n$ such that $C'_0 \xrightarrow{v^0, t^0} \dots \xrightarrow{v^{n-1}, t^{n-1}} C'_n$ and: for all $0 \leq i < n-1$, with $C'_i = (\Gamma_{q_1, q_2}, L'_i)$ and $C_i = (\Gamma_{q_2, q_3}, L_i)$, and for all $v \in \mathbf{V}(\Gamma_{q_2, q_3})$, $L'_i(v) = L_i(v)$ and $L'_i(v'_1) = q_{in}$. Hence $L'_n(v'_1) = q_{in}$ and $L'_n(v_1) = q_2$. ◀

We are now ready to prove Lemma E.15.

Proof of Lemma E.15. Let $q_1, q_2 \in H$, from Lemma E.16, let $\Gamma_{q_1} = (\{v_1, \dots, v_k\}, \{\{v_i, v_{i+1}\} \mid 1 \leq i < k\})$, and $\Gamma_{q_2} = (\{v'_1, \dots, v'_n\}, \{\{v'_i, v'_{i+1}\} \mid 1 \leq i < n\})$ the two line topologies such that q_1 is coverable with v_1 and q_2 with v'_1 . Denote $C_0 \rightarrow^* C$ with $C = (\Gamma_{q_1}, L)$ and $L(v_1) = q_1$ and $C'_0 \rightarrow^* C'$ with $C' = (\Gamma_{q_2}, L')$ and $L'(v'_1) = q_2$. As $q_1, q_2 \in H$ and $H \subseteq Q_0 \cup Q_1^r$, v_1 does not broadcast anything between C_0 and C and v'_1 does not broadcast anything between C'_0 and C' .

Define $\Gamma = (V, E)$ such that $V = \mathbf{V}(\Gamma_{q_1}) \cup \mathbf{V}(\Gamma_{q_2}) \cup \{u_2, u_3, u_4\}$ and $E = \mathbf{E}(\Gamma_{q_1}) \cup \mathbf{E}(\Gamma_{q_2}) \cup \{\langle v_1, u_2 \rangle, \langle u_2, u_3 \rangle, \langle u_3, u_4 \rangle, \langle u_4, v'_1 \rangle\}$. Note that v_1 and v'_1 are not neighbors, and that each node in $\mathbf{V}(\Gamma_{q_1})$ [resp. in $\mathbf{V}(\Gamma_{q_2})$] has the same neighborhood as before, except for v_1 , and v'_1 which have an additional new neighbor, respectively u_2 and u_4 . Denote $C''_0 = (\Gamma, L''_0)$ with $L''_0(v) = q_{in}$ for all $v \in \mathbf{V}(\Gamma)$.

Denote $C_0 \xrightarrow{v^1, t^1} C_1 \xrightarrow{v^2, t^2} \dots \xrightarrow{v^{n_1}, t^{n_1}} C_{n_1} = C$ and $C'_0 \xrightarrow{v'^1, t'^1} C'_1 \xrightarrow{v'^2, t'^2} \dots \xrightarrow{v'^{n_2}, t'^{n_2}} C'_{n_2} = C'$. Then $C''_0 \xrightarrow{v^1, t^1} C''_1 \xrightarrow{v^2, t^2} \dots \xrightarrow{v^{n_1}, t^{n_1}} C''_{n_1} \xrightarrow{v'^1, t'^1} C''_{n_1+1} \xrightarrow{v'^2, t'^2} \dots \xrightarrow{v'^{n_2}, t'^{n_2}} C''_{n_1+n_2}$ with $C''_{n_1+n_2} = (\Gamma, L''_{n_1+n_2})$ and $L''_{n_1+n_2}(v) = L_{n_1}(v)$ for all $v \in \mathbf{V}(\Gamma_{q_1})$ and $L''_{n_1+n_2}(v) = L'_{n_2}(v)$ for all $v \in \mathbf{V}(\Gamma_{q_2})$ and $L''_{n_1+n_2}(v) = q_{in}$ for all $v \in \{u_2, u_3, u_4\}$. Hence $L''_{n_1+n_2}(v_1) = q_1$ and $L''_{n_1+n_2}(v'_1) = q_2$.

Finally, rename $\Gamma_5 = (\{u_1, u_2, u_3, u_4, u_5\}, \{\{u_i, u_{i+1}\} \mid 1 \leq i < 5\})$, and v_1 by u_1 and v'_1 by u_5 . Denote $C^5_{q_1, q_2} \xrightarrow{u^1, \delta^1} C^5_1 \xrightarrow{u^2, \delta^2} \dots \xrightarrow{u^{n_3}, \delta^{n_3}} C^5_{n_3}$. Denote $C^5_{q_1, q_2} = (\Gamma_5, L_{q_1, q_2})$ and $C^5_{n_3} = (\Gamma_5, L^5_{n_3})$. Note that for all $u \in \mathbf{V}(\Gamma_5)$, $L_{q_1, q_2}(u) = L''_{n_1+n_2}(u)$. Hence, $C^5_{n_1+n_2} \xrightarrow{u^1, \delta^1} C^5_{n_1+n_2+1} \xrightarrow{u^2, \delta^2} \dots \xrightarrow{u^{n_3}, \delta^{n_3}} C^5_{n_1+n_2+n_3}$ with $C^5_{n_1+n_2+n_3} = (\Gamma, L''_{n_1+n_2+n_3})$ and $L''_{n_1+n_2+n_3}(v) = L_{n_1}(v)$ for all $v \in \{u_1, u_2, u_3, u_4, u_5\}$. Hence $L''_{n_1+n_2+n_3}(u_3) = q_f$. □

